



OWNER'S MANUAL

LG Wi-Fi Sound Bar

Please read this manual carefully before operating your set and retain it for future reference.

MODEL

SL8YG (SL8YG, SPL8-W)

Safety Information



CAUTION: TO REDUCE THE RISK OF ELECTRIC SHOCK DO NOT REMOVE COVER (OR BACK) NO USER-SERVICEABLE PARTS INSIDE REFER SERVICING TO QUALIFIED SERVICE PERSONNEL



This lightning flash with arrowhead symbol within an equilateral triangle is intended to alert the user to the presence of uninsulated dangerous voltage within the product's enclosure that may be of sufficient magnitude to constitute a risk of electric shock to persons.



The exclamation point within an equilateral triangle is intended to alert the user to the presence of important operating and maintenance (servicing) instructions in the literature accompanying the product.

WARNING: TO PREVENT FIRE OR ELECTRIC SHOCK HAZARD, DO NOT EXPOSE THIS PRODUCT TO RAIN OR MOISTURE.

WARNING: Do not install this equipment in a confined space such as a book case or similar unit.

CAUTION: Do not use high voltage products around this product. (ex. Electrical swatter) This product may malfunction due to electrical shock.

CAUTION: The apparatus should not be exposed to water (dripping or splashing) and no objects filled with liquids, such as vases, should be placed on the apparatus.

CAUTION: Do not block any ventilation openings. Install in accordance with the manufacturer's instructions.

Slots and openings in the cabinet are provided for ventilation and to ensure reliable operation of the product and to protect it from over heating. The openings should never be blocked by placing the product on a bed, sofa, rug or other similar surface. This product shall not be placed in a built-in installation such as a bookcase or rack unless proper ventilation is provided or the manufacturer's instruction has been adhered to.

CAUTION: No naked flame sources, such as lighted candles, should be placed on the apparatus.

NOTICE: For safety marking information including product identification and supply ratings, please refer to the main label on the bottom or the other surface of the product.

CAUTION concerning the Power Cord

The Power Plug is the disconnecting device. In case of an emergency, the Power Plug must remain readily accessible.

Check the specification page of this owner's manual to be certain of the current requirements.

Do not overload wall outlets. Overloaded wall outlets, loose or damaged wall outlets, extension cords, frayed power cords, or damaged or cracked wire insulation are dangerous. Any of these conditions could result in electric shock or fire. Periodically examine the cord of your device, and if its appearance indicates damage or deterioration, unplug it, discontinue use of the device, and have the cord replaced with an exact replacement part by an authorized service center. Protect the power cord from physical or mechanical abuse, such as being twisted, kinked, pinched, closed in a door, or walked upon. Pay particular attention to plugs, wall outlets, and the point where the cord exits the device.

CAUTION: Only use the AC adapter supplied with this device. Do not use a power supply from another device or another manufacturer. Using any other power cable or power supply may cause damage to the device and void your warranty.

Symbols

| | |
|---|-------------------------------------|
| ~ | Refers to alternating current (AC). |
| ≡ | Refers to direct current (DC). |
| ⊞ | Refers to class II equipment. |
| ⏻ | Refers to stand-by. |
| I | Refers to "ON" (power). |
| ⚡ | Refers to dangerous voltage. |

Table of Contents

1 Getting Started

- 2 Safety Information
- 6 Introduction
- 7 Front panel
- 9 Rear panel
- 10 Remote control
- 13 Installing the sound bar
- 14 Mounting the main unit on a wall

2 Connecting

- 16 Network connection
- 16 – Installing “Google Home” App
- 17 – Launch the app to connect Wi-Fi
- 18 Organizing cables
- 18 Connecting the AC Adapter
- 18 Wireless subwoofer and rear speaker (Sold Separately) connection
- 18 – Wireless subwoofer connection
- 20 – Rear speakers connection (Sold Separately)
- 21 – Surround sound
- 24 – How to Affix the Ferrite Core
- 25 Connecting to your TV
- 25 – Using an OPTICAL cable
- 25 – LG Sound Sync
- 27 – Using an HDMI cable
- 27 – ARC (Audio Return Channel) function
- 27 – What is SIMPLINK?
- 28 – Additional information for HDMI
- 29 Optional equipment connection
- 29 – DOLBY ATMOS®
- 29 – DTS:X®
- 30 – HDMI IN connection
- 30 – OPTICAL IN connection
- 31 – USB connection

3 Operating

- 34 USB operation
- 35 How to use the Google Assistant
 - 35 – Talk to the Google Assistant
- 37 – Reference site for Google Assistant Help
- 38 Control your TV and Sound Bar with Voice command
 - 38 – Available voice commands
- 40 “LG Wi-Fi Speaker”
 - 40 – Installing “LG Wi-Fi Speaker” App
- 41 Using a Bluetooth Wireless Technology
 - 41 – About Bluetooth
 - 41 – Bluetooth profiles
 - 41 – Listening to Music of a Bluetooth Device
- 44 Other operations
 - 44 – Using your TV remote control
 - 44 – AUTO POWER On/Off
 - 45 – Auto function change
- 46 Standby mode
 - 46 – Standby mode
 - 46 – Networked standby mode
- 46 Reset the Speaker

4 Troubleshooting

- 47 Troubleshooting
 - 47 – General
 - 49 – Network
 - 49 – Application
 - 50 – NOTES to use wireless
 - 50 – NOTES to release Demo mode

5 Appendix

- 51 File requirement
- 51 Trademarks and licenses
- 52 Specifications
- 54 Handling the Speaker
- 54 Important Information Relating to Network Services
- 55 TERMS OF USE

1

2

3

4

5

Introduction

Symbol used in this manual



Note

Indicates special notes and operating features.



Caution

Indicates cautions for preventing possible damages from abuse.

Front panel

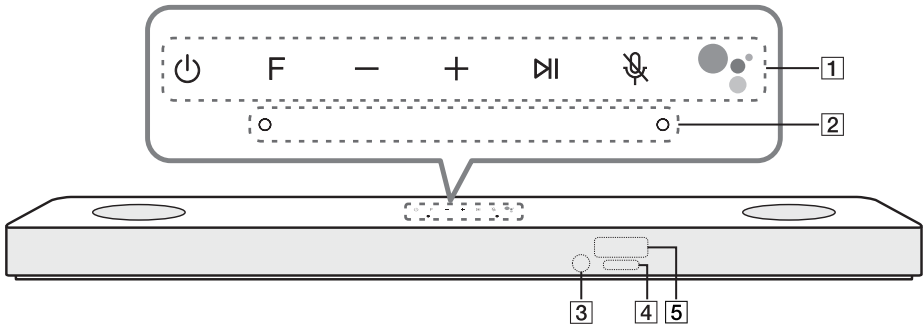

⏻ (Standby)

- Switches the unit ON or OFF.

F (Function)

- Select the function and input source by pressing **F** repeatedly.

| Input source / Function | Display |
|---|--------------|
| Wi-Fi | WI-FI |
| Bluetooth | BT |
| Optical ARC LG Sound Sync (Wired) | OPT/HDMI ARC |
| HDMI IN | HDMI |
| USB | USB |

1

- 1 You can use **Bluetooth** function after making Wi-Fi network connection by using Google Home app.

+ / - (Volume)

- Adjusts volume level.

⏮

- Starts playback. / Pauses playback.

🔇 (Mic mute)

- Disables the detect voice recognition by pressing 🔇. All the Google Assistant LED turns amber and "The mic is muted." is heard.
To cancel it, press 🔇 again. Google Assistant LED turns off and "The mic is back on." is heard.

🗣️

- Enables Google Assistant to receive your voice commands.
To cancel it, press 🗣️ again. (Page 35)

2

Microphone

3 Remote sensor

Google Assistant LED

- Changes LED status according to Google Assistant performance.

4

| LED | Status | Description |
|---------|---|--|
| ○ ○ ○ ○ | All four LEDs are on. | Ready to listen to your voice command. |
| ◌◌◌◌ | All four LEDs blink. | Responds to your voice command. |
| ● ○ ○ ○ | Microphone is off and the solid amber LED will be on. | Voice recognition is disable |

Display Window

5

- Display window will be darkened automatically if there is no key input for 15 seconds. When you press any button, the display window will brighten.

Precautions in using the touch buttons



- Use the touch buttons with clean and dry hands.
 - In a humid environment, wipe out any moisture on the touch buttons before using.
- Do not press the touch buttons hard to make it work.
 - If you apply too much strength, it can damage the sensor of the touch buttons.
- Touch the button that you want to work in order to operate the function correctly.
- Be careful not to have any conductive material such as metallic object on the touch buttons. It can cause malfunctions.



- This unit will turn itself off to save electric consumption when the main unit is not connected to an external device and is not used for 15 minutes.

Rear panel

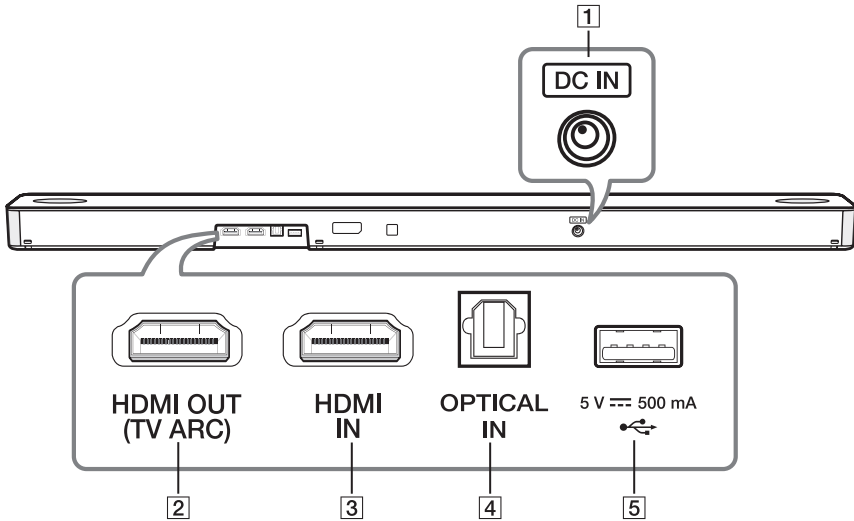

-
- | | |
|--|--|
| 1 | DC IN - Connect to the AC adapter. |
| <hr style="border-top: 1px dotted #000;"/> | |
| 2 | HDMI OUT (TV ARC) - Connect the HDMI OUT (TV ARC) jack on the back of the unit to ARC jack on the TV. |
| <hr style="border-top: 1px dotted #000;"/> | |
| 3 | HDMI IN - Connect HDMI IN jack on the back of the unit to HDMI OUT jack on the external device. You can enjoy the sound and picture from HDMI connection on an external device. |
| <hr style="border-top: 1px dotted #000;"/> | |
| 4 | OPTICAL IN - Connect the OPTICAL IN jack on the back of the unit to OPTICAL OUT jack on the TV. |
| <hr style="border-top: 1px dotted #000;"/> | |
| 5 | USB Port - Connect USB memory device to the USB port on the back of the unit. |
-

Remote control

Getting Started

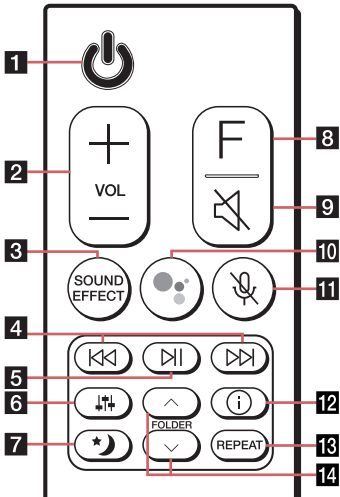

Replacement of Battery

Remove the battery cover on the rear of the remote control, and insert the battery with + and - matched correctly.

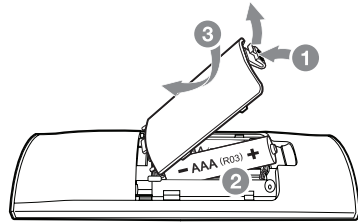

⏻ (Standby)

- Switches the unit ON or OFF.

1

- **Networked standby:** It allows the unit to switch to standby mode.
To turn on Networked standby function, Press ⏻.
To turn off Networked standby function, press ⏻ for about 3 seconds.

2

VOL (Volume) +/-

- Adjusts speaker volume.

SOUND EFFECT

- Selects a sound effect mode by using **SOUND EFFECT**.

| On Display | Description |
|------------------------------|---|
| ASC (Adaptive Sound Control) | Analyzes the property of the input sound and provides the sound optimized for the content in real time. |
| BASS BLAST or BASS BLAST+ | Reinforces the bass and powerful sound. |
| STANDARD | You can enjoy premium sound with MERIDIAN technology. |
| MOVIE | You can enjoy more immersive and cinematic surround sound. |
| MUSIC | You can enjoy more good sound for music source. |

3

- ① When this unit detects DOLBY ATMOS or DTS:X stream, you cannot change sound effect to any other. In this case, even though you press **SOUND EFFECT**, this unit does not respond. And you can see only "NOT SUPPORTED" on the display window.

- **TV remote:** It allows you to control the volume of this unit by your TV remote control even by other company's product. (Page 44)
To turn on or off the TV Remote function, press and hold **SOUND EFFECT** for about 3 seconds and press it again.

- ① Supported TV brands

| | | | | | | | |
|----|-----------|---------|---------|-------|------|---------|-------|
| LG | Panasonic | Philips | Samsung | Sharp | Sony | Toshiba | Vizio |
|----|-----------|---------|---------|-------|------|---------|-------|

⏮ / ⏭ (Skip)**4**

- Press **⏮** or **⏭** to go to next or previous file.

⏮ | ⏭ (Play/Pause)**5**

- Starts playback. / Pauses playback.

🔊 (Sound tuning)

- Adjusts sound level of each speaker.
Select the speaker you want to adjust by using **🔊** and adjust the sound level by using **VOL + / -**.

- ① Adjusting rear speakers level is applied only when the rear speakers are connected.















| Speaker | Display | Range |
|-------------------------|---------|---------|
| Sub Woofer | WF | -15 ~ 6 |
| Center | C | -6 ~ 6 |
| Overhead Volume Control | OVC | -6 ~ 6 |
| Rear | R | -6 ~ 6 |
| Treble | TRE | -5 ~ 5 |
| Bass | BAS | -5 ~ 5 |

6

- **Surround sound:** It allows you to enjoy surround sound with rear speakers. (Page 21)
To turn on or off the surround sound, press and hold **🔊** for about 3 seconds and press it again.

🌙 (Night time)**7**

- It is useful when you want to watch movies at low volume late at night. It makes to reduce the sound intensity and improve fineness and softness.
Press **🌙** to activate Night time mode. To cancel it, press **🌙** again.

- 8** **F** (Function)
- Select the function and input source by pressing **F** repeatedly.
- 9**  (Mute)
- Press  to mute your unit. To cancel it, press  again.
- 10**  
- Enables Google Assistant to receive your voice commands **while watching TV (not necessary when listening to music through Wi-Fi or Bluetooth, you can just say "Ok Google")**.
To cancel it, press  again. (Page 35)
- 11**  (Mic mute)
- Disables the detect voice recognition by pressing . All the Google Assistant LED turns amber and "The mic is muted." is heard.
To cancel it, press  again. Google Assistant LED turns off and "The mic is back on." is heard.
- 12**  (Information)
- You can display various information of the input source by pressing .
- Wi-Fi: Connected Application name
- BT (**Bluetooth**): Connected **Bluetooth** device name
- OPT (Optical)/ARC/HDMI (HDMI IN): Audio format
- USB: File information contained on a USB.
• **Auto Power ON/OFF**: It allows the unit to turn on and off automatically by input signals: Optical (Page 44)
To turn on or off AUTO POWER function, press and hold  for about 3 seconds and press it again.
- 13** **REPEAT**
- Press **REPEAT** to select desired repeat or random mode.
- 14** **FOLDER**  / 
- Searches a folder on USB device.

Installing the sound bar

You can hear the sound by connecting the unit to the other device: TV, Blu-ray disc player, DVD player, etc.

Place the unit in front of the TV and connect it to the device you want. (Pages 25 - 31)

You can place the wireless subwoofer anywhere in your room. But it is better to place the subwoofer near the main unit. Turn it slightly toward the center of the room to reduce the wall reflections.

For the best surround sound, place the speakers as shown below.

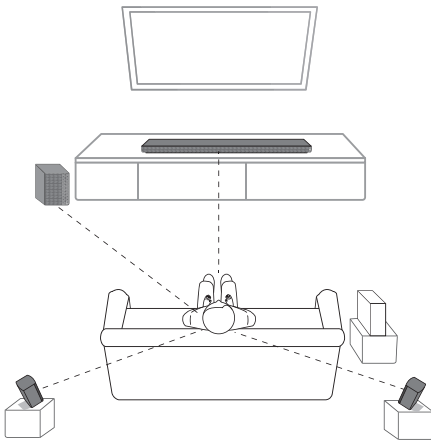

! Note

- If the sound bar covers the remote sensor of the TV, please separate distance between the sound bar and TV by 10 ~ 15 cm or more.
- The illustration above may differ from actual units.
- You can enjoy surround sound by using Wireless Rear Speaker kit. Wireless Rear Speakers Kit sold separately (SPK8-S).

! Caution

- For best performance of wireless connection such as **Bluetooth** or wireless subwoofer, do not install the unit on Metallic furniture because wireless connection communicates through a module positioned on the bottom of the unit.
- Be careful not to make scratches on the surface of the Unit /Subwoofer when installing or moving them.

Installing the additional foot

You can extend the height of the unit by using additional foot (height: 14 mm).

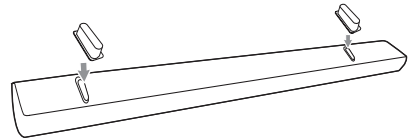

1. Turn the unit upside down.
2. Peel off a sticker attached to the additional foot. Then place it on the existing foot of the unit.
3. Press the additional foot with adequate force to get it firmly fixed.

Mounting the main unit on a wall

You can mount the main unit on a wall.



Caution

Because it is difficult to make a connection after installing this unit, you should connect the cables before installation.

Preparation materials

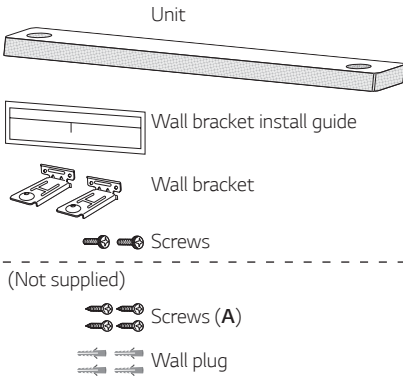

1. Match the TV's BOTTOM EDGE of Wall bracket install guide with the bottom of TV and attach to the position.

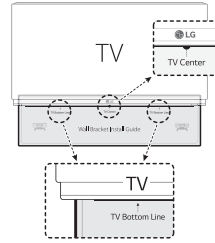

2. When you mount it on a wall (concrete), use the wall plugs. You should drill some holes. A guide sheet (Wall bracket install guide) is supplied to drill. Use the sheet to check the point to drill.

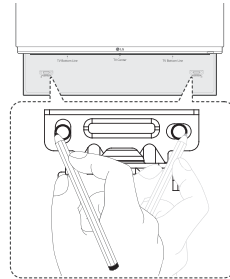

3. Remove the Wall bracket install guide.
4. Fix the brackets with screws (A) as shown in the illustration below.

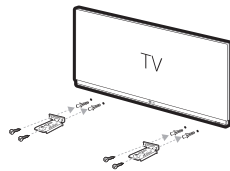

Note

Screws (A) and Wall Plugs are not supplied for mounting the unit. We recommend the Hilti (HUD-1 6 x 30) for the mounting.

- Put the unit on the brackets to match screw holes on the bottom of the unit.

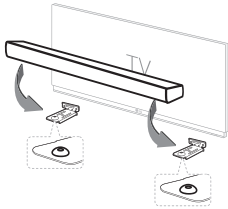

- Fix the unit with the screws firmly.

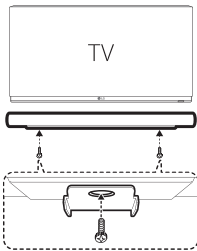

! Note

To detach the unit, perform it in reverse order.

! Caution

- Do not install this unit upside down. It can damage the parts of this unit or be the cause of personal injury.
- Do not hang onto the installed unit and avoid any impact to the unit.
- Secure the unit firmly to the wall so that it does not fall off. If the unit falls off, it may result in an injury or damage to the product.
- When the unit is installed on a wall, please make sure that a child does not pull any of connecting cables, as it may cause it to fall.

Network connection

You can enjoy various functions of this sound bar by connecting to network and your smart device with “Google Home” app.

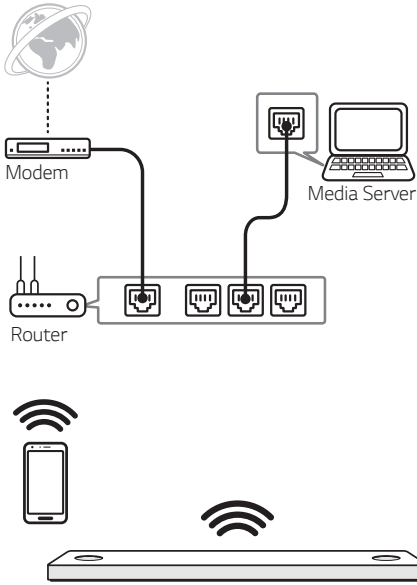

The “Google Home” app is required to connect the sound bar wirelessly to the network.

! Note

In a network environment (Router, Internet and Internet Service Provider) that supports both IPv4 and IPv6, the network automatically connects to IPv4 or IPv6 when connecting to the network.

You can check the each network status by selecting the settings of My Speakers ([Settings]>[IP Info.]) on the “LG Wi-Fi Speaker” app.

Installing “Google Home” App

The “Google Home” app allows you to use various functions of this speaker through your smart device.

Requirements before setup

- A wireless router must be connected to the internet. A smart device such as Android or iOS devices must be connected to the wireless router via Wi-Fi connection.
- It needs Google account to use this app. During connect Wi-Fi, this app may request to create Google account.

Through “Google Play” or “App Store”

1. Tap the “Google Play Store” icon or “App Store” icon on your smart device.
2. Type in “Google Home” in the search bar and tap “Search” on “Google Play” or “App Store”
3. Select “Google Home” in the search result list to download.

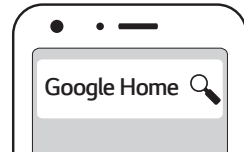

! Note

- Depending on the device version, “Google Home” app may not work.
- For more information, visit the web site. <https://www.google.com/cast/setup/>

Launch the app to connect Wi-Fi

Make sure your smart device Wi-Fi feature is turned on. Once a connecting operation is performed, it does not need to be performed again.

! Note

In case of iOS devices, it should be turned on **Bluetooth** setting on your smart device.

1. Tap the "Google Home" icon to launch the app.



2. Follow the screen on app to set speaker. Follow these instructions in order.

! Note

- Use the same Wi-Fi connection to set the speaker and your smart device.
- If the **Bluetooth** setting turned on your smart device, it will be easy to connect Wi-Fi.
- During installation, you should create a speaker name. It is needed when pairing the **Bluetooth** device. You can check and edit the speaker name. Follow the "Edit speaker name". (Page 43)
- For more information on the setup, visit the web site. <https://support.google.com/assistant/answer/7538816>

3. When the speaker is properly connected to Wi-Fi, "CONNECTED" will appear on the display window with sound.

! Note

- Depending on wireless router status, it might not work well Wi-Fi connection.
- It is recommended that you use Wi-Fi Group Play with less than 5 speakers.
- "Google Home" app is provided by Google. It might be revised by a change of Google Policy.
- For more information (Set up, Usage, Help etc.), research "Google Assistant Help" or visit the web site. <http://support.google.com/assistant>
- The speaker is not available for use on some functions from the "Google Assistant Help" site. (ex. Call etc.) (Page 37)

Organizing cables

You can organize the cable with cable ties.

1. Hold the cables together with cable ties as shown below.
2. Tighten cable ties.

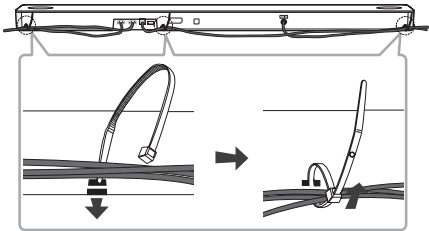

! Note

After all connections are completed, you can arrange cables as needed.

Connecting the AC Adapter

Connect the sound bar to the power supply with the supplied AC adapter.

1. Connect the supplied AC power cord to the AC adapter.
2. Connect the AC adapter cable to DC IN adapter input.
3. Plug the AC power cord into an AC outlet.

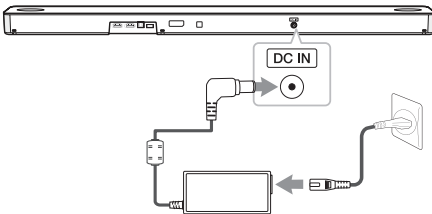

! Caution

Only use the AC adapter supplied with this device. Do not use a power supply from another device or manufacturer. Using any other power cable or power supply may cause damage to the device and void your warranty.

Wireless subwoofer and rear speaker (Sold Separately) connection

Wireless subwoofer connection

LED indicator of wireless subwoofer

| LED Color | Status |
|------------------|--|
| Green (Blink) | The connection is trying. |
| Green | The connection is completed. |
| Red | The wireless subwoofer is in standby mode or the connection is failed. |
| Off (No display) | The power cord of wireless subwoofer is disconnected. |

Setting up the wireless subwoofer for the first time

1. Connect the power cord of the sound bar and the wireless subwoofer to the outlet.
2. Turn on the sound bar. The sound bar and the wireless subwoofer will be automatically connected.
 - Pairing is completed. The green LED on the rear of the wireless subwoofer turns on.

Manually pairing wireless subwoofer

When your connection is not completed, you can check red LED on the wireless subwoofer and the wireless subwoofer does not make sound. To solve the problem, follow the steps below.

1. Press **Pairing** on the rear of the wireless subwoofer.

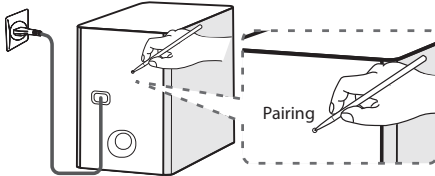

- The green LED on the rear of the wireless subwoofer blinks quickly. (If the green LED does not blink, press and hold the **Pairing**.)
2. Turn on the sound bar.
 - Pairing is completed. The green LED on the rear of the wireless subwoofer turns on.

! Note

- It takes a few seconds (and may take longer) for the main unit and the subwoofer to communicate with each other and make sounds.
- The closer the main unit and the subwoofer, the better sound quality. It is recommended to install the main unit and the subwoofer as close as possible and avoid the cases below.
 - There is an obstacle between the main unit and the subwoofer.
 - There is a device using same frequency with this wireless connection such as a medical equipment, a microwave or a wireless LAN device.
 - Keep the sound bar and the subwoofer away from the device (ex. wireless router, microwave oven, etc.) over 1 m to prevent wireless interference.

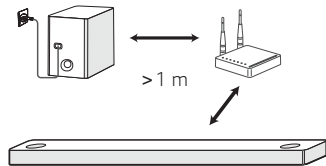

Rear speakers connection (Sold Separately)

Connecting the rear speakers

1. Connect the black stripe wire to the terminal marked - (minus) and the other end to the terminal marked + (plus).

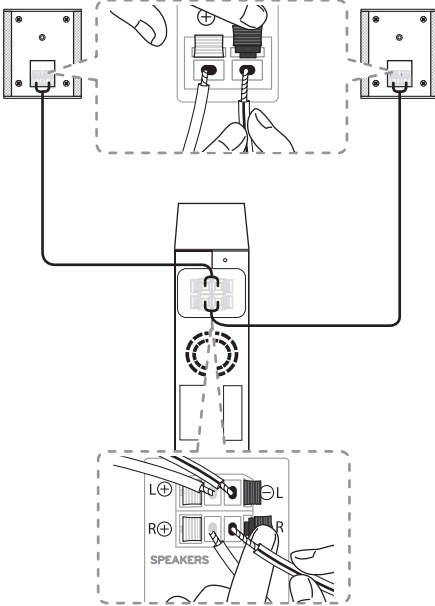

2. Connect the wireless receiver and the rear speakers (right, left) with the speaker cables.

| Color | Position |
|-------|------------|
| Grey | Rear right |
| Blue | Rear left |

! Note

You need to purchase the wireless rear speakers kit (SPK8-S) to enjoy surround sound.

! Caution

- Use the speaker supplied with this unit only. Using any other speaker may cause malfunction.
- Be sure to match the speaker cable to the appropriate terminal on the components: + to + and - to -. If the cables are reversed, the sound will be distorted and will lack bass.

LED indicator of wireless receiver

| LED Color | Status |
|------------------------|---|
| Yellow - green (Blink) | The connection is trying. |
| Yellow - green | The connection is completed. |
| Red | The wireless receiver is in standby mode or the connection is failed. |
| Off (No display) | The power cord of wireless receiver is disconnected. |

Setting up the wireless receiver for the first time

1. Connect the power cord to the wireless receiver to the outlet.
2. Turn on the main unit: The sound bar and wireless receiver will be automatically connected.
 - Yellow - green LED on the wireless receiver turns on.

Manually pairing wireless receiver

When your connection is not completed, you can see the red LED on the wireless receiver and rear speakers do not make sound. To solve the problem, follow the below steps.

1. Press **PAIRING** on the rear of the wireless receiver.

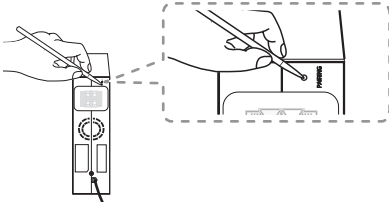

- The yellow - green LED on the wireless receiver blinks quickly.
2. Turn on the main unit
 - Pairing is completed. The yellow - green LED on the wireless receiver turns on.

Surround sound

You can enjoy magnificent surround sound for all the input sound source with rear speakers.





















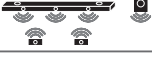





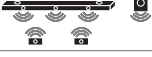

If you turn on the surround function, the whole speaker outputs sound.

When you turn off the surround function, the speakers output sound as an original input sound channel.



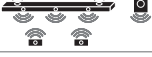



























To turn on surround function, press and hold **↓↑** on the remote control for about 3 seconds and press it once again while "OFF - SURROUND" is scrolled.

To turn off surround function, press and hold **↓↑** on the remote control for about 3 seconds and press it once again while "ON - SURROUND" is scrolled.

Surround function ON

| Sound Effect | Input | Output | |
|---------------------------------|----------------|---|---|
| | | No rear speakers | Rear speakers connected |
| ASC | 2.0 Ch |  |  |
| | 5.1 Ch |  |  |
| | 7.1 Ch or more |  |  |
| BASS BLAST or BASS BLAST+ | 2.0 Ch |  |  |
| | 5.1 Ch |  |  |
| | 7.1 Ch or more |  |  |
| STANDARD | 2.0 Ch |  |  |
| | 5.1 Ch |  |  |
| | 7.1 Ch or more |  |  |
| MOVIE | 2.0 Ch |  |  |
| | 5.1 Ch |  |  |
| | 7.1 Ch or more |  |  |
| MUSIC | 2.0 Ch |  |  |
| | 5.1 Ch |  |  |
| | 7.1 Ch or more |  |  |

Surround function OFF

| Sound Effect | Input | Output | |
|---------------------------------|----------------|---|---|
| | | No rear speakers | Rear speakers connected |
| ASC | 2.0 Ch |  |  |
| | 5.1 Ch |  |  |
| | 7.1 Ch or more |  |  |
| BASS BLAST or BASS BLAST+ | 2.0 Ch |  |  |
| | 5.1 Ch |  |  |
| | 7.1 Ch or more |  |  |
| STANDARD | 2.0 Ch |  |  |
| | 5.1 Ch |  |  |
| | 7.1 Ch or more |  |  |
| MOVIE | 2.0 Ch |  |  |
| | 5.1 Ch |  |  |
| | 7.1 Ch or more |  |  |
| MUSIC | 2.0 Ch |  |  |
| | 5.1 Ch |  |  |
| | 7.1 Ch or more |  |  |

How to Affix the Ferrite Core

Ferrite core may not be provided depending on each nation's regulations.

Affix the Ferrite Core for speaker cables

You must affix a ferrite core in order to reduce or eliminate electrical interference.

1. Pull the stopper [a] of the ferrite core to open.
2. Wind the speaker cables around the ferrite core twice.
3. Close the ferrite core until it clicks.

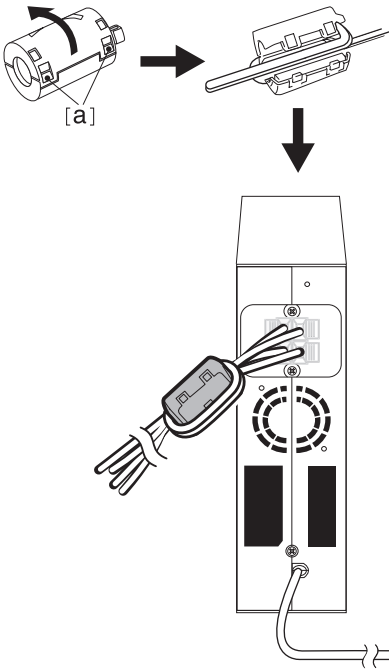

! Note

- If there is a strong electromagnetic wave product nearby, interference may occur. Put the main unit and wireless receiver away from there.
- The wireless receiver will automatically switch to standby mode in a few minutes after the sound bar is turned off. When the wireless receiver is in standby mode, the LED will turn on in red.
- When you turn on the sound bar, the wireless receiver will turn on and the LED will change to yellow - green and then the rear speakers makes sound within a few seconds.
- It takes a few seconds (and may take longer) for the main unit and Wireless Receiver to communicate with each other.
- Use the rear speaker at least 30 cm away from either TV screen or PC monitor.
- When the wireless receiver is being connected or disconnected with the main unit, output sound is maybe interrupted.
- Set the distance between the sound bar and the wireless receiver as close as possible and keep them away from the device (ex. wireless router, microwave oven, etc.) over 1 m to prevent wireless interference.

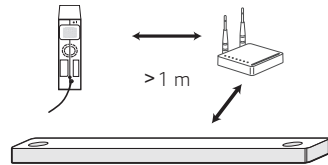

Connecting to your TV

Please connect with this unit and TV using the optical digital cable or HDMI cable considering the state of the TV.

Using an OPTICAL cable

1. Connect the OPTICAL IN jack on the back of the unit to OPTICAL OUT jack on the TV using an OPTICAL cable.

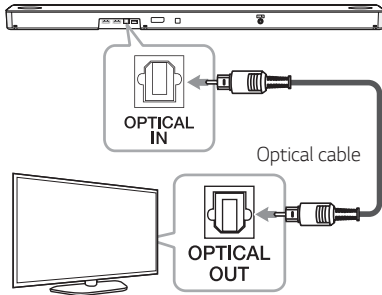

2. Select the input source to OPT/HDMI ARC by pressing **F** repeatedly.

You can see "OPT" on the display window if connecting normally between this unit and your TV.

! Note

- Before connecting the optical cable, be sure to remove the protection plug cover if your cable has the cover.
- You can enjoy the TV audio through the speakers of this unit. In the case of some TV models, you must select the external speaker option from the TV menu. (For details, reference your TV user manual)
- Set up the sound output of TV to listen to the sound through this unit:
TV setting menu → [Sound] → [TV Sound output] → [External speaker (Optical)]
- Details of TV setting menu vary depending on the manufacturers or models of your TV.
- If this unit is connected by OPTICAL and ARC at the same time, the ARC signal is a high priority.

LG Sound Sync

Sound Sync

You can control some functions of this unit by your TV's remote control with LG Sound Sync. It is compatible with the LG TV that supports LG Sound Sync. Make sure of the LG Sound Sync logo is on your TV.

Controllable function by LG TV's remote control:
Volume up/down, mute

Refer to the TV's instruction manual for the details of LG Sound Sync.

Make one of the following connections, depending on the capabilities of your equipment.

! Note

- You can also use the remote control of this unit while using LG Sound Sync. If you use TV's remote control again, the unit synchronizes with the TV.
According to TV Specifications, the volume and mute of this unit synchronize with TV.
- When the connection fails, make sure of the condition of the TV and power.
- Make sure of the condition of this unit and the connection in the cases below when using LG Sound Sync.
 - The unit is turned off.
 - Changing to another function.
 - Disconnecting the optical cable.
- The amount of time to turn off this unit is different depending on your TV when you set AUTO POWER function to ON.

LG Sound Sync with wired connection

1. Connect your LG TV to the unit by using an optical cable.

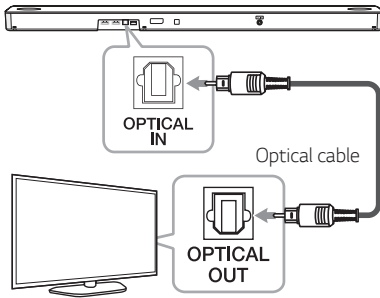

2. Set up the sound output of TV to listen to the sound through this unit:
TV setting menu → [Sound] → [TV Sound output] → [LG Sound Sync (Optical)]
3. Turn on the unit by pressing .
4. Select the input source to OPT/HDMI ARC by pressing **F** repeatedly.
You can see "LGOPT" on the display window if connecting normally between this unit and your TV.

Note

Details of TV setting menu vary depending on the models of your TV.

Using an HDMI cable

If you connect this unit to a TV that supports HDMI CEC and ARC (Audio Return Channel), you can enjoy the TV audio through the speakers of this unit without connecting the optical cable.

1. Connect the HDMI OUT (TV ARC) jack on the back of the unit to ARC jack on the TV using an HDMI cable.

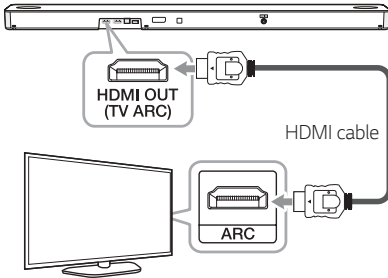

2. Select the input source to OPT/HDMI ARC by pressing **F** repeatedly.

You can see "ARC" on the display window if connecting normally between this unit and your TV.

! Note

- You can enjoy the TV audio through the speakers of this unit. In the case of some TV models, you must select the external speaker option from the TV menu. (For details, reference your TV user manual.)
- Set up the sound output of TV to listen to the sound through this unit:
TV setting menu → [Sound] → [TV Sound output] → [External speaker (HDMI ARC)]
- Details of TV setting menu vary depending on the manufacturers or models of your TV.
- Depending on your LG TV model, you may need to turn on the SIMPLINK function on your LG TV.
- When you return to ARC function from another function, you need to select the input source to OPT/HDMI ARC. Then this unit changes to ARC function automatically.

ARC (Audio Return Channel) function

The ARC function enables an HDMI capable TV to send the audio stream to HDMI OUT of the unit.

To use this function:

- Your TV must support the HDMI-CEC and ARC function and the HDMI-CEC and ARC must be set to On.
- The setting method of HDMI-CEC and ARC may differ depending on the TV. For details about ARC function, refer to your TV manual.
- You must use the HDMI cable (Type A, High Speed HDMI™ cable with Ethernet).
- You must connect the HDMI OUT on the unit with HDMI IN of the TV that supports ARC function using an HDMI cable.
- You can connect only one Sound bar to TV compatible with ARC.

What is SIMPLINK?



Some functions of this unit are controlled by the TV's remote control when this unit and LG TV's with SIMPLINK are connected through HDMI connection.

Controllable functions by LG TV's remote control:
Power on/off, volume up/down, etc.

Refer to the TV owner's manual for the details of SIMPLINK function.

LG TV's with SIMPLINK function has the logo as shown above.

! Note

- Depending on the state of the unit, some SIMPLINK operation may differ from your purpose or not work.
- Depending on a TV or a player which is connected with this unit, SIMPLINK operation may differ from your purpose.

Additional information for HDMI

- When you connect an HDMI or DVI compatible device make sure of the following:
 - Try switching off the HDMI/DVI device and this player. Next, switch on the HDMI/DVI device and leave it for around 30 seconds, then switch on this player.
 - The connected device's video input is set correctly for this unit.
 - The connected device is compatible with 720 x 576p (or 480p), 1280 x 720p, 1920 x 1080i, 1920 x 1080p, 4096 x 2160p or 3080 x 2160p video input.
- Not all HDCP-compatible HDMI or DVI devices will work with this player.
 - The picture will not be displayed properly with non-HDCP device.

Note

- If a connected HDMI device does not accept the audio output of the player, the HDMI device's audio sound may be distorted or may not output.
- Changing the resolution when the connection has already been established may result in malfunctions. To solve the problem, turn off the player and then turn it on again.
- When the HDMI connection with HDCP is not verified, TV screen is changed to black screen. In this case, check the HDMI connection, or disconnect the HDMI cable.
- If there are noises or lines on the screen, please check the HDMI cable (length is generally limited to 4.5 m).
- You cannot change the video resolution in the HDMI mode. Change the video resolution of the connected component.
- If the video output signal is abnormal when your personal computer is connected to HDMI IN jack, change the resolution of your personal computer to 576p (or 480p), 720p, 1080i or 1080p.

HDMI cable Checklist

Some HDMI cables have poor signal transmission, which can cause problems with sound and video transmission.

Even after HDMI cable connections, if no sound, sound interrupted, noise occurring from the sound bar and/or no video, no smooth video on your TV, the HDMI cable may be the problem.

Use the cable marked with the premium HDMI certification logo. Also make sure that the your using cable is a certified Type A, Ethernet high-speed HDMI™ cable.

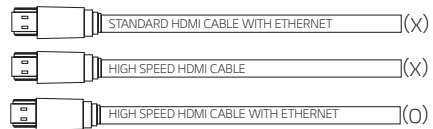

Connection through HDMI Cable*

Your television must support the newest HDMI features (HDMI CEC¹⁾ / ARC (Audio Return Channel)) to fully enjoy the Live broadcasting channel with audio system through an HDMI cable. Unless your TV supports these HDMI features, the audio system should be connected through an OPTICAL cable.

1) HDMI CEC (High-Definition Multimedia Interface Consumer Electronics Control)

Consumer Electronics Control (CEC) is an HDMI feature designed to allow the user to command and control the CEC-enabled devices, that are connected through HDMI by using only one of their remote controls.

* Trade names for CEC are SimpLink (LG), Anynet+ (Samsung), BRAVIA Sync (Sony), EasyLink (Philips), etc.

Optional equipment connection

DOLBY ATMOS®

What is DOLBY ATMOS®?

Dolby Atmos gives you amazing experience you've never before by overhead sound, and all the richness, clarity, and power of Dolby sound.

DTS:X®

What is DTS:X®?

In the real world, sound is all around us, moving freely in any direction. DTS:X® is immersed in this natural, multi-dimensional sound experience as we go about our daily lives.

For using DOLBY ATMOS® and DTS:X®

- DOLBY ATMOS® is available only in HDMI and ARC mode.
 - To use DOLBY ATMOS® in ARC mode, your TV has to support DOLBY ATMOS®.
- DTS:X® is available only in HDMI mode
- It is needed to set up an audio output on external devices (Blu-ray disc player, TV etc.) to "No encoding" such as "Bitstream", "Auto" or "Bypass"
 - If you can select audio output sampling rate, set it to 192 kHz.

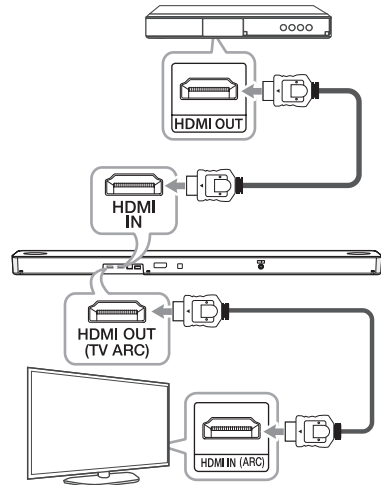

1. Connect HDMI IN jack on the back of the unit to HDMI OUT jack on the external device such as Blu-ray disc player, DVD player, etc.
2. Connect HDMI OUT (TV ARC) jack on the back of the unit to HDMI IN (ARC) jack on the TV.
3. Select the input source to HDMI or OPT/HDMI ARC by pressing **F** repeatedly.
 - If you select HDMI, you can hear the sound from the external device. Select it when playing the external device.
 - If you select OPT/HDMI ARC, you can hear the sound from your TV. Select it when watching the TV.

You can see "DOLBY ATMOS" or "DTS:X" on the display window if connecting normally between this sound bar and your TV and the contents is played.

! Note

- DOLBY ATMOS®/DTS:X® supports 3.1.2 channel (5.1.2 channel when it connected with Rear kit)
- If the sound bar does not have sound or the video on TV is not smooth, the HDMI cable may be the problem. Refer to the HDMI cable checklist. (Page 28)

HDMI IN connection

You can enjoy the sound from the external device which is connected to HDMI IN jack on this unit.

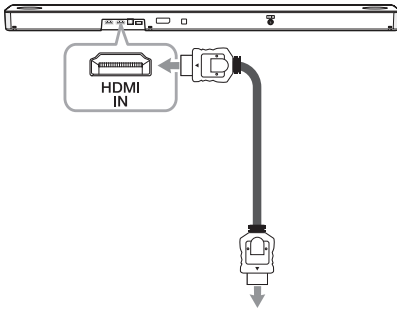

To the Blu-ray disc player,
DVD player, etc.

1. Connect HDMI IN jack on the back of the unit to HDMI OUT jack on the audio device such as Blu-ray disc player, DVD player, etc.
2. Select the input source to HDMI by pressing **F** repeatedly.

OPTICAL IN connection

Connect an optical output jack of external devices to the OPTICAL IN jack.

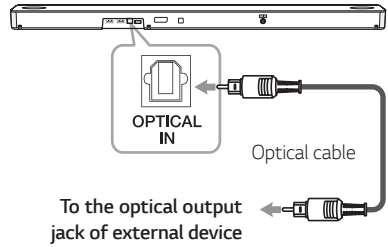

1. Connect the OPTICAL IN jack on the back of the unit to optical out jack of your external device.
2. Select the input source to OPT/HDMI ARC by pressing **F** repeatedly.

You can see "OPT" on the display window if connecting normally between this unit and your device.

! Note

Before connecting the optical cable, be sure to remove the protection plug cover if your cable has the cover.

Optional equipment connection

You can enjoy both sound and picture from the external device you connect.

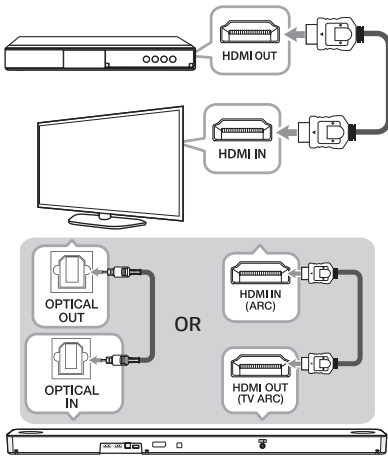

1. Connect HDMI IN jack of your TV to HDMI OUT jack on the external device such as Blu-ray disc player, DVD player, etc.
2. Connect the OPTICAL IN jack on the back of the unit to OPTICAL OUT jack on the TV using an OPTICAL cable.

Or connect the HDMI OUT (TV ARC) jack on the back of the unit to HDMI IN (ARC) jack on the TV using an HDMI cable.

3. Select the input source to OPT/HDMI ARC by pressing **F** repeatedly.

! Note

If the sound bar does not have sound or the video on TV is not smooth, the HDMI cable may be the problem. Refer to the HDMI cable checklist. (Page 28)

USB connection

Connect USB memory device to the USB port on the back of the unit.

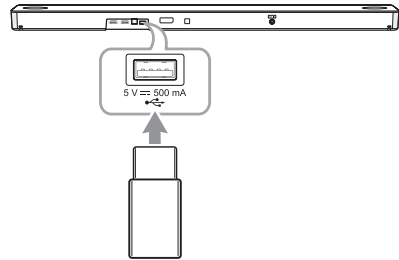

For more information of playing files on a USB, refer to the page 34.

Removing the USB Device from the unit

1. Choose a different function/mode.
2. Remove the USB device from the unit.

Compatible USB devices

- MP3 Player: Flash type MP3 player.
- USB Flash Drive: Devices that support USB 2.0.
- The USB function of this unit does not support some USB devices.

USB device requirement

- Devices which require additional program installation connected to a computer, are not supported.
- Do not extract the USB device while in operation.
- For a large capacity USB, it may take longer than a few minutes to be searched.
- To prevent data loss, back up all data.
- The unit's USB Port cannot be connected to PC. The unit can not be used as a storage device.
- The exFAT/NTFS file systems are not supported on this unit. (FAT16/FAT32 systems are available.)
- Depending on some devices, it may not available to recognize the followings on this unit.
 - External HDD
 - Card readers
 - Locked devices
 - Hard type USB devices
 - USB hub
 - Using USB extension cable
 - iPhone/iPod/iPad
 - Android device

Playable file

Sampling Frequency

- MP3: within 32 to 48 kHz
- OGG: within 32 to 48 kHz
- AAC: within 8 to 48 kHz

Bitrate resolution

- MP3: within 8 to 320 kbps
- OGG: within 64 to 320 kbps
- AAC: within 8 to 320 kbps

- Maximum files: Up to 2,000
- Maximum directories: Up to 200
- A protected file by DRM (Digital rights management) cannot be played on the unit.
- Video files in the USB storage device can not be played.
- Depending on the performance of your USB device, playback may not work well.

! Note

- Folders and files on the USB are recognized as below.

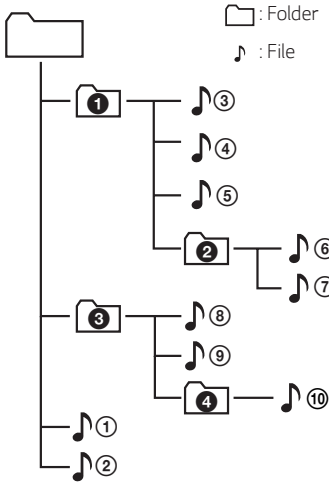

- If there is no file in a folder, the folder will not appear.
- File will be played from file ① to file ⑩ one by one.
- Files will be played in order recorded and it may be different depending on the record circumstances.
- This unit can display file or folder names that contain numbers or English characters only.
- *ROOT: The first screen you can see when a this unit recognize the USB is "ROOT".

USB operation

1. Connect the USB device to the USB port.
2. Select the USB function by pressing **F** repeatedly.

| To | Do this |
|------------------------------------|---|
| Playback | Press ▶ . |
| Pause | During playback, press ⏸ . |
| Skip to the next/ previous file | During playback, press ⏭ on the remote control to go to the next file. Playing less than 3 seconds, press ⏮ on the remote control to go to the previous file. Playing after 3 seconds, press ⏮ on the remote control to go to the beginning of the file. |
| Play repeatedly or randomly | Press REPEAT on the remote control repeatedly. Refer to the note for details about the display change. |
| Search a folder | Press FOLDER ^ / ∨ on the remote control. |

! Note

- The resume point may be cleared when you pull out the power cord or removing the USB device from the unit.
- Repeat/Random playback operates as follows.

| On Display | Description |
|------------|--|
| OFF | Plays songs on USB device in order. |
| ONE | Plays a same song repeatedly. |
| FOLDER | Plays songs in a folder repeatedly. |
| ALL | Plays all the songs on USB device repeatedly. |
| SHUFFLE | Plays all the songs once randomly, and stops the playback. |

How to use the Google Assistant

Talk to the Google Assistant

You can use a variety of voice commands to control this speaker with the Google Assistant. Try to say a voice command to the speaker. The speaker will activate the Google Assistant and perform your voice command.

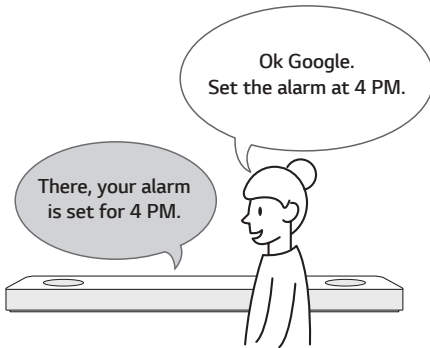

1. Turn on the speaker and connect Wi-Fi. (Page 17)
2. Say "Ok Google" or press . Then the speaker is activated and ready to receive your voice commands.

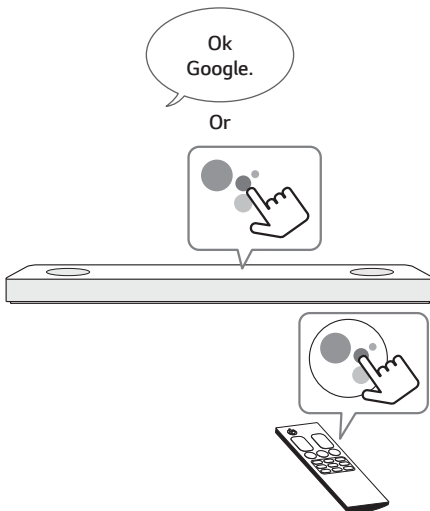

3. Just say the thing you want to do. Then the speaker recognizes and performs your voice command.
4. After a few seconds, the Google Assistant will respond to your command.

Note

- The Google Assistant only responds to voice commands when you are using Wi-Fi or BT (**Bluetooth**) as the input. If you are using HDMI, Optical, ARC, Optical Sound Sync, or USB input, then you must use the button to activate the Google Assistant.
- Each time you use voice recognition, say "Ok Google" or press .

Comfortable Function

With the Google Assistant built in, you can control compatible smart home devices such as TVs, lights, switches, plugs, thermostats and more by simply using your voice.

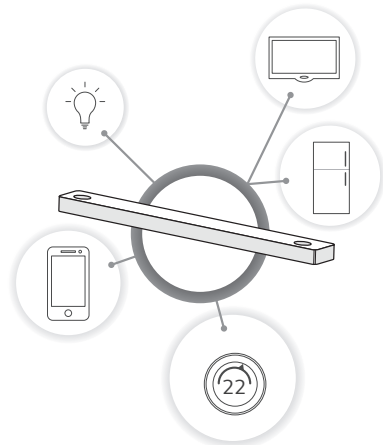

For more information, visit the below web site.

- **Set up, Usage and more:** <http://support.google.com/assistant/answer/7540703>
- **Compatible LG appliance models:** Visit <http://www.lg.com> and then search the information



Voice command

1. Time
"What time is it?"; "What time is it now?"; "What time is it in Spain?"
2. Weather
"What's the weather?"; "What's the weather this weekend?"; "What's the weather in Paris?"; "Will it rain tomorrow?"
3. Plan
"Tell me about my day."; "What's my next meeting?"; "Set a reminder to check schedule at 6pm."
4. Alarms
"Set an alarm"; "Set an alarm for 9am"; "Wake me up at 9am"; "What alarms are set?"
5. Music
"Play the music."; "Next song."; "Previous song."; "Pause the music"
6. Volume
"Volume level 3."; "Maximum volume."; "Mute."; "Turn it up"; "Turn it down"
7. Smart Home devices
"Set the heat to 22"
"Turn on lights in the kitchen"
"Watch on TV"

Note

- For more information on the voice commands, refer to the "Google Home" app screen or visit the web site. <http://support.google.com/assistant>
- **Voice command of Volume level change**
 - The volume range of this unit is 1-40. (Except LGOPT function. In LGOPT function, the volume range works 1-100.)
 - Google Assistant recognizes voice command of volume level change as a scale (1-10) or a percentage (1-100 %)
 - For example, if you say "Volume level five." the volume level of this unit changes to 20. If you say "Volume to 65 %," it changes to 26.
 - Volume level increases or decreases by 10 % (i.e. 4) when you say, "volume up" or "volume down".
 - When you say numbers of 10 and less, it is recommended to say "percent" to prevent too loud sound.

Note

- After connecting to Wi-Fi, this function is available to use. If Google Assistant LED (White) blinks, the speaker is not connected to Wi-Fi. Follow the "Installing "Google Home" App" and try again. (Page 16)
- If the Google Assistant LED is solid amber, the microphone is off. In that case, the Google Assistant is not available to receive your comment. Press .
- If the Google Assistant fails to understand your commands, it will say answers such as "Sorry, I can't help with that yet"; "My apologies. I don't understand".
- Avoid noisy places, because the speaker may not receive your commands or "Ok Google". Instead of "Ok Google", press .
- When the voice recognition time limit is exceeded on smart devices, this function automatically cancels.
- Speaking with correct pronunciation will increase the voice recognition rate.
- The Google Assistant may be slow to recognize or act depending on the Wi-Fi connection status or Google server status.
- If you have any trouble or question about Google Assistant, please suggest by saying "Ok Google, Feedback". It would be helpful for improving Google Services.

Reference site for Google Assistant Help

| | |
|--|---|
| Set up the Google Assistant on your speakers | https://support.google.com/assistant/answer/7538816 |
| Listen to music | https://support.google.com/assistant/answer/7539710 |
| Play music on your TV or speakers | https://support.google.com/assistant/answer/7539867 |
| Play TV shows & movies | https://support.google.com/assistant/answer/7539991 |
| Control smart home devices | https://support.google.com/assistant/answer/7540703 |
| Create a shopping list | https://support.google.com/assistant/answer/7540969 |
| Buy items on your shopping list | https://support.google.com/assistant/answer/7384588#speaker |
| Set up and manage My Day | https://support.google.com/assistant/answer/7393908#speaker |
| Listen to radio | https://support.google.com/assistant/answer/7540307 |
| See which Google Account is linked to your Assistant | https://support.google.com/assistant/answer/7539992 |
| Control volume of your speakers | https://support.google.com/assistant/answer/7538817 |
| Change your language | https://support.google.com/assistant/answer/7394513#speaker |

Control your TV and Sound Bar with Voice command

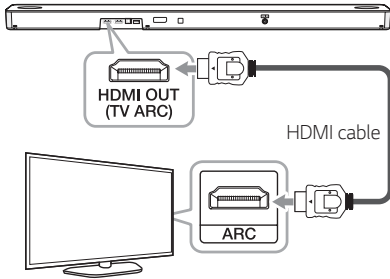

1. Connect your Sound Bar to Wi-Fi by using Google Home app.
2. Connect your Sound Bar and TV by using an HDMI cable.
3. Say a voice command. See the following tables.

! Note

- You have to say voice commands in English.
- Available TV: Web OS version 4.5 or later TV (LG TV models released after 2019 years)
- Available voice commands might be revised by a change of Google Policy.
- Speaks the voice commands with accurate and clear pronunciation.

Available voice commands

LG TV

| Commands | Action |
|--|---|
| Turn on LG TV Turn LG TV on Power on LG TV Power LG TV on | Turns on your LG TV. |
| Turn off LG TV Turn LG TV off Power off LG TV Power LG TV off | Turns off your LG TV. |
| Channel up on LG TV LG TV channel up Next channel on LG TV | Your LG TV changes the channel to up. |
| Channel down on LG TV LG TV channel down Previous channel on LG TV | Your LG TV changes the channel to down. |
| Volume up on LG TV LG TV volume up | Volume of your LG TV increases. |
| Volume down on LG TV LG TV volume down | Volume of your LG TV decreases. |
| Mute LG TV | Mutes your LG TV |
| LG TV unmute LG TV mute off | Unmutes your LG TV |

Sound Bar

| Commands | | Action |
|--|------------------------------|---|
| Turn off LG sound bar Power off LG sound bar | | Turns off your LG Sound Bar. |
| Switch function to Enable function Set function to | Wi-Fi network | Changes to the Wi-Fi function. |
| | BLUETOOTH | Changes to the BT (Bluetooth) function. |
| | OPTICAL | Changes to the Optical function. |
| | HDMI ARC | Changes to the HDMI ARC function. |
| | HDMI | Changes to the HDMI function. |
| | USB | Changes to the USB function. |
| Set sound effect | STANDARD | Changes the sound effect to STANDARD. |
| | ASC | Changes the sound effect to ASC. |
| | MOVIE | Changes the sound effect to MOVIE. |
| | MUSIC | Changes the sound effect to MUSIC. |
| | BASS BLAST (BASS BLAST PLUS) | Changes the sound effect to BASS BLAST (BASS BLAST PLUS). |
| Display the input source information | | Displays the input source information on display window. |
| Enable Auto volume Disable Auto volume | | Turns on Auto volume function. Turns off Auto volume function. |
| Enable Auto Power Disable Auto Power | | Turns on Auto power function. Turns off Auto power function. |
| Enable Night Time Disable Night Time | | Turns on Night time mode. Turns off Night time mode. |
| Enable DRC Disable DRC | | Turns on DRC. Turns off DRC. |
| Enable TV remote Disable TV remote | | Turns on TV remote function. Turns off TV remote function. |
| Enable Surround Disable Surround | | Turns on Surround sound. Turns off Surround sound. |
| Enable Neural X Disable Neural X | | Turns on Neural X. Turns off Neural X. |

“LG Wi-Fi Speaker”

The “LG Wi-Fi Speaker” app is provided by LG Electronics. This app allows you to use various functions of this speaker through your smart device:

Requirements before using

You should connect to Wi-Fi by using “Google Home” app prior using this app. (Page 17)

Enjoying music on your device and home network server

You can listen to the music on your smart device and home network server.

Using Chromecast built-in

You can enjoy music contents through this sound bar with Chromecast enabled apps.

Setting and controlling the sound bar

You can manage the sound bar settings and control the sound bar even without remote control.

Requirements

- A **wireless router** must be connected to the internet.
- A **smart device** such as a smartphone or tablet must be connected to the wireless router via Wi-Fi connection.

Note

For more informations of “LG Wi-Fi Speaker”, follow the instructions of the application.

Installing “LG Wi-Fi Speaker” App

Through Apple “App Store” or “Google Play Store”

1. Tap the Apple “App Store” icon or “Google Play Store” icon.
2. Type in “LG Wi-Fi Speaker” in the search bar and tap “Search”.
3. Select “LG Wi-Fi Speaker” in the search result list to download.

Note

- “LG Wi-Fi Speaker” app will be available in version of the software as follow;
Android OS: Ver 5.0 (or later)
iOS: Ver 10 (or later)
- Depending on the device, “LG Wi-Fi Speaker” app may not work.
- You can find the available application of this unit by using “LG Audio” app.
Android OS: Ver 5.0 (or later)

Using a Bluetooth Wireless Technology

About Bluetooth

Bluetooth is wireless communication technology for short range connection.

The sound may be interrupted when the connection interfered by the other electronic wave or you connect the **Bluetooth** in the other rooms.

Connecting individual devices under **Bluetooth** wireless technology does not incur any charges. A mobile phone with **Bluetooth** wireless technology can be operated via the Cascade if the connection was made via **Bluetooth** wireless technology.

- Available Devices: Smart phone, MP3, Notebook, etc.
- Version: 5.0
- Codec: SBC

Bluetooth profiles

In order to use **Bluetooth** wireless technology, devices must be able to interpret certain profiles. This speaker is compatible with following profile.

A2DP (Advanced Audio Distribution Profile)

Listening to Music of a Bluetooth Device

Before you start the pairing procedure, make sure that the **Bluetooth** feature on your smart device is turned on. Refer to your **Bluetooth** device's user guide. Once a pairing operation is performed, it does not need to be performed again.

1. Turn on the speaker and connect Wi-Fi. Follow "Network connection." (Page 16-17)
2. Select the **Bluetooth** function by pressing **F** repeatedly. "BT" and then "READY" appears in the display window.
3. Operate the **Bluetooth** device and perform the pairing operation. When searching for this speaker on your **Bluetooth** device, a list of the devices found may appear in the **Bluetooth** device display depending on the type of **Bluetooth** device. Your speaker appears as "Speaker name (App setup)".
4. Select the "Speaker name (App setup)":

! Note

- Speaker name was setup on "Google Home" app. For example, if the speaker name is set to "Living Room" in the "Google Home" app, you will see "Living Room" on your **Bluetooth** device.
- You may check and edit the speaker name on "Google Home" app (Page 43)
- Depending on the **Bluetooth** device type, some devices have a different pairing way. For details about **Bluetooth** pairing, refer to your **Bluetooth** device manual.

5. When this unit is successfully connected with your **Bluetooth** device, "PAIRED" → your device's name → "BT" appears on the display window.

! Note

- If it is unavailable to display device name on the unit, "-" will be displayed.
- To check the connected device's name, press **Ⓞ** on the remote control. The connected **Bluetooth** device's name is displayed.

6. Listen to music.

To play music in your **Bluetooth** device, refer to your **Bluetooth** device's user guide.

According to your **Bluetooth** device's volume level, the volume level of **Bluetooth** will be adjusted.

! Note

- When using **Bluetooth** technology, you have to make a connection between the unit and the **Bluetooth** device as close as possible and keep the distance.
However it may not work well in the case below:
 - There is an obstacle between the unit and the **Bluetooth** device.
 - There is a device using same frequency with **Bluetooth** technology such as a medical equipment, a microwave or a wireless LAN device.
- If last connected device is LG TV, this sound bar will connect to the TV automatically when you restart the sound bar.
- If the LG TV is turned off, this sound bar will enter "READY" (**Bluetooth** ready) mode. When the TV is turned back on, the Sound Bar will not reconnect automatically. To connect the Sound Bar and the TV:
 - Say "Ok Google, connect **Bluetooth**"
 - Turn the Sound Bar off and back on.
 Then follow the TV's on screen instructions.
- Available TV: LG TV models released after 2016 and some TVs may not work well.

! Note

- This unit supports **Bluetooth** auto pairing. However it does not operate in the case below:
 - When you restart this unit.
 - When you disconnect this unit by yourself.
 - When you disconnect this unit on the connected **Bluetooth** device.
- The sound may be interrupted when the connection is interfered with by the some other electronic wave.
- Pairing is limited to "One" **Bluetooth** device. Multi-Pairing is not supported.
- Depending on the type of the device, you may not be able to use the **Bluetooth** function.
- You can enjoy using **Bluetooth** when using Phone, MP3, Notebook, etc..
- The more distance between the unit and the **Bluetooth** device, the lower the sound quality becomes.
- **Bluetooth** connection will be disconnected when the unit is turned off or the **Bluetooth** device gets to far from the unit.
- If the **Bluetooth** connection is disconnected, connect the **Bluetooth** device again.
- When a **Bluetooth** device is not connected, "READY" appears on the display window.
- If you change to another function after connecting **Bluetooth** device, **Bluetooth** connection will be disconnected. When you return to **Bluetooth** function, **Bluetooth** connection will be connected automatically.
- When one **Bluetooth** device has connected to this unit, another device cannot find and connect to this unit. If you want to connect another device, disconnect the current device and try again.

Using Voice command to connect Bluetooth

If the speaker has paired to a **Bluetooth** device before, you can use "Google Assistant" to connect **Bluetooth**. Say "Connect", "Connect to **Bluetooth**" or "Ok **Bluetooth**".

To disconnect it, say "Cancel", "Unpair devices" or "Clear all devices".

Controls connected Bluetooth device

You can control the connected **Bluetooth** device from the unit; play, pause, skip, volume.

Note

- Only Android OS and iOS is available to use this function.
- This function may not be supported depending on the **Bluetooth** device or some of TV operated differently.
- You can control connected **Bluetooth** devices by voice recognition. Follow the "How to use Google Assistant" (Page 35).

Edit speaker name

You can check and edit the speaker name on the "Google Home" app.

Other operations

Using your TV remote control

You can control some functions of this unit by your TV remote control even by other company's product. Controllable functions are volume up/down and mute.

Press and hold **SOUND EFFECT** on the remote control for about 3 seconds. "ON - TV REMOTE" appears and you can control this unit by your TV remote control.

To check the status of this function, press and hold **SOUND EFFECT** on the remote control.

To turn off this function, press and hold **SOUND EFFECT** on the remote control and press it once again while "ON - TV REMOTE" is scrolled.

! Note

- Make sure that the sound output of your TV is set to [External speaker].
- This function does not operate on LG TV's magic remote control.
- This function may not work well when some TV control functions such as HDMI CEC, SIMPLINK and LG Sound Sync set to ON.
- Some remote control may not be supported.

AUTO POWER On/Off

This sound bar automatically turns on and off by an input source: Optical

To turn on this function, press and hold **Ⓢ** on the remote control for about 3 seconds and press it once again while "OFF - AUTO POWER" is scrolled.

To check the status of this function, press and hold **Ⓢ** on the remote control.

To turn off this function, press and hold **Ⓢ** on the remote control for about 3 seconds and press it once again while "ON - AUTO POWER" is scrolled.

Turning on

When you turn on your TV or an external device connected to this unit, this unit recognizes the input signal and selects the suitable function. You can hear the sound from your device.

Turning off

When the TV is off, this sound bar switches to the Networked standby mode.

! Note

- After the unit is turned on by AUTO POWER function, it will be automatically turned off if there is no signal for a certain period of time from the TV connected by LG Sound Sync (Optical).
- After the unit is turned on by AUTO POWER function, it will be automatically turned off if there is no signal for a certain period of time from the external device.
- If you turned off the unit directly, it cannot be turned on automatically by AUTO POWER function. However the unit can be turned on by AUTO POWER function when optical signal comes in after 5 seconds of no signal.
- Depending on the connected device, this function may not operate.
- When you turn on this unit for the first time, status of Auto Power function is turned on.
- You can set the AUTO POWER function only when this unit is turned on.

Auto function change

This sound bar recognizes input signals such as Optical, HDMI ARC, **Bluetooth**, and “LG Wi-Fi Speaker” app and then changes suitable function automatically.

When you turn on your TV or an external device

When you turn on your TV or an external device connected by the one among Optical, LG Sound Sync (Optical), or HDMI ARC, this sound bar will change to a suitable function so you can listen to the sound through it.

When you try to connect a Bluetooth device

When you try to connect your **Bluetooth** device to this unit, **Bluetooth** function is selected. Play your music on the **Bluetooth** device.

When you play music by “LG Wi-Fi Speaker” app

When you play music by “LG Wi-Fi Speaker” app on your smart device, this sound bar changes the function to WI-FI and you can listen to the music through it.

Note

This unit does not change the function to optical if SIMPLINK of the connected TV, Blu-ray disc player, set-top box or etc. device set to on or connected CEC supported device is turned on. If you want to use the auto function change, turn off SIMPLINK function on your LG TV. It takes for about 30 seconds to turn off SIMPLINK.

How to disconnect the wireless network connection or the wireless device

Turn off the unit by pressing the power button for more than 3 seconds.

Standby mode

The speaker switches to the standby mode if there is no music playback or no button operation.

Standby mode

If you press and hold  for about 3 seconds, the speaker switches to the standby mode. Then "GOOD-BYE" appears on the display window. And all wireless network ports are deactivated.

Networked standby mode

Option 1.

When music is not played and buttons are not pressed for 15 minutes, the speaker switches to the Networked standby mode. Then "GOOD-BYE" appears on the display window.

Option 2.

If you press , the speaker switches to the Networked standby mode. Then "GOOD-BYE" appears on the display window.

Reset the Speaker



If the speaker doesn't respond, reset the speaker.

Press and hold the  until you hear the beep sound once. You can see "RESET" on the display window. Then all the stored wireless network information is deleted.

Troubleshooting

General

| Symptoms | Cause & Solution |
|--|---|
| The unit does not work properly. | <ul style="list-style-type: none"> • Turn off the power of this unit and the connected external device (TV, Woofer, DVD-player, Amplifier, etc.) and turn them on again. • Disconnect the power cord of this unit and the connected external device (TV, Woofer, DVD-player, Amplifier, etc.) and then try connecting again. • Previous setting may not be saved when device power is shut off. |
| The power does not turn on. | <p>Is the power cord plugged into the outlet?</p> <ul style="list-style-type: none"> • Connect the power plug to the outlet. |
| Sound is not produced. | <p>Is the volume set to minimum?</p> <ul style="list-style-type: none"> • Adjust the volume. • When you are using connection with an external device (set top box, Bluetooth device etc.), adjust volume level of the device. <p>Is the mute function activated?</p> <ul style="list-style-type: none"> • Press  or adjust the volume level to cancel the mute function. <p>Is the function selected properly?</p> <ul style="list-style-type: none"> • Check the input source and select the correct input source. |
| No woofer sound | <p>Is the subwoofer plugged in?</p> <ul style="list-style-type: none"> • Plug the power cord of subwoofer into the wall outlet securely. <p>Is pairing between the unit and the subwoofer disconnected?</p> <ul style="list-style-type: none"> • Connect the unit and the subwoofer. (Page 18) |
| The remote control does not work properly. | <p>Is the remote control too far from the unit?</p> <ul style="list-style-type: none"> • Operate the remote control within about 7 m. <p>Is there an obstacle in the path of the remote control and the unit?</p> <ul style="list-style-type: none"> • Remove the obstacle. <p>Are the batteries in the remote control exhausted?</p> <ul style="list-style-type: none"> • Replace the batteries with new one. |
| The AUTO POWER function does not work. | <ul style="list-style-type: none"> • Check connection of the external device such as TV, DVD/Blu-Ray player. • Check the state of SIMPLINK on your LG TV and turn off SIMPLINK. • Depending on the connected device, this function may not operate. |
| LG Sound Sync does not work. | <ul style="list-style-type: none"> • Check whether your LG TV supports LG Sound Sync (Wired). • Check connection of LG Sound Sync (Wired). • Check sound setting of your TV and this unit. |

| Symptoms | Cause & Solution |
|---|--|
| When you feel the output sound of the unit is low. | <p>Check the details below and adjust the unit according to them.</p> <ul style="list-style-type: none"> • Switch the state of DRC function to [OFF] by using "LG Wi-Fi Speaker". • With the sound bar connected with TV, change the AUDIO DIGITAL OUT setting on TV Setup Menu from [PCM] to [AUTO] or [BITSTREAM]. • With the sound bar connected with Player, change the AUDIO DIGITAL OUT setting on Player Setup Menu from [PCM] to [PRIMARY PASS-THROUGH] or [BITSTREAM]. • Change Audio DRC setting on connected device setup menu to [OFF] state. • Make sure that Night Time mode is not On. Turn off Night Time mode. |
| USB is not recognized | <ul style="list-style-type: none"> • Format the USB device and connect it again. When formatting the USB device, select file system as FAT16 or FAT32. |
| Bluetooth pairing does not work well. | <ul style="list-style-type: none"> • Be sure your Bluetooth device is on. • Switch Bluetooth off and on again on your Bluetooth device, then try pairing again. • Remove the obstacle in the path of the Bluetooth device and the unit. • Depending on the type of the Bluetooth device or surrounding environment, your device may not be paired with the unit. |
| The unit does not connect with Bluetooth device. | <ul style="list-style-type: none"> • Make sure the speaker connects to Wi-Fi by using "Google Home" app. |
| Voice recognition does not work well. | <ul style="list-style-type: none"> • The speaker may not be recognized because of the surrounding noise. • Instead of "Ok Google", press . • Check and make sure the microphone is muted. Press  button. |

Network

| Symptoms | Cause & Solution |
|--|---|
| Cannot connect the speaker to your home network. | <ul style="list-style-type: none"> • The wireless communication may be interrupted from household devices that are using radio frequencies. Move the speaker away from them. • Check your router. Try turning it off and back on. • Check that the Wi-Fi feature is turned on in your smart device. • Check that the speaker and your smart device are connected to same Wi-Fi. |
| Wi-Fi connection does not work well. | <p>If you restart the router?</p> <ul style="list-style-type: none"> • You need to turn the speaker's power off and on again. <p>If you install new router.</p> <ul style="list-style-type: none"> • You need to perform a factory set and setup the network connection for speaker. |

Application

| Symptoms | Cause & Solution |
|--|---|
| The application doesn't work properly. | <p>Does an error occur when accessing the app?</p> <ul style="list-style-type: none"> • Make sure that your smart device is compatible with the app. • Make sure that the application is the latest version. • Make sure that the connected unit turns on. |

NOTES to use wireless

| Symptoms | Cause & Solution |
|---|--|
| This device may have wireless interference. | <ul style="list-style-type: none"> • Wireless may not operate normally in weak signal area. • Please install the device close enough to wireless subwoofer. • Do not install the device on metal furniture for optimum performance. |
| Bluetooth device may malfunction or make noise in the following cases. | <ul style="list-style-type: none"> • When any part of your body contact the transceiver of the Bluetooth device or sound bar. • When there is an obstacle or wall or the device is installed in a secluded spot. • When there is a device (a wireless LAN, a medical equipment or a microwave) using same frequency, make the distance between the products as far away as possible each other. • When connecting the device to the Bluetooth device, make the distance between the products as close as possible each other. • When the device gets too far from the Bluetooth device, the connection is disconnected and also malfunction may occur. |

NOTES to release Demo mode

| Symptoms | Cause & Solution |
|--|--|
| Can not change input source with F such as BT (Bluetooth), HDMI etc. and only [DEMO] indication is showing in the front display. | Unplug the power cord and plug it in again. If that doesn't work, press and hold F (About 5 seconds) on the main unit until the display indicates current selected function. |
| Remote Control does not work. (No response) | |

File requirement

Available File extensions: "mp3", "aac", "ogg"

Sampling Frequency:

MP3: within 32 to 48 kHz

OGG: within 32 to 48 kHz

AAC: within 8 to 48 kHz

Bitrate resolution:

MP3: within 8 to 320 kbps

OGG: within 64 to 320 kbps

AAC: within 8 to 320 kbps

- The file requirements are not always compatible. There may have some restrictions by file features and media server's ability.
- Some wav files are not supported on this speaker.
- Depending on the types of file or ways of recording, it may not play back.
- Some DRM-loaded files are not supported on this speaker.
- The types of supported files may differ depending on the operating system and/or the manufacturer of the smart device and PC.

Trademarks and licenses

All other trademarks are trademarks of their respective owners.



DOLBY ATMOS®

Manufactured under license from Dolby Laboratories. Dolby, Dolby Atmos, and the double-D symbol are Trademarks of dolby Laboratories.



For DTS patents, see <http://patents.dts.com>. Manufactured under license from DTS Licensing Limited. DTS, the Symbol, & DTS and the Symbol together; DTS:X, and the DTS:X logo are registered trademarks or trademarks of DTS, Inc. in the United States and/or other countries. © DTS, Inc. All Rights Reserved.



The **Bluetooth®** word mark and logos are registered trademarks owned by the **Bluetooth SIG, Inc.** and any use of such marks by LG Electronics is under license. Other trademarks and trade names are those of their respective owners.



HDMI™
HIGH-DEFINITION MULTIMEDIA INTERFACE

The terms HDMI and HDMI High-Definition Multimedia Interface, and the HDMI logo are trademarks or registered trademarks of HDMI Licensing LLC in the United States and other countries.

Specifications

| General | |
|--|---|
| Power consumption | Refer to the main label on the unit. Networked standby: 5.5 W (If all network ports are activated.) |
| AC adapter | Model: DA-50F25 Manufacturer: Asian Power Devices Inc. Input: 100 - 240 V ~ 50 - 60 Hz Output: 25 V \equiv 2 A |
| Dimensions (W x H x D) | Approx. 1060.0 mm x 57.0 mm x 119.0 mm (with foot) |
| Operating temperature | 5 °C to 35 °C |
| Operating humidity | 5 % to 90 % |
| Bus Power Supply (USB) | 5 V \equiv 500 mA |
| Available Digital Input Audio Sampling Frequency | 32 kHz, 44.1 kHz, 48 kHz, 88.2 kHz, 96 kHz, 192 kHz |
| Available Digital Input Audio format | Dolby Atmos, Dolby Audio, DTS:X, DTS-HD, PCM |

| Input/Output | |
|--------------|--|
| OPTICAL IN | 3 V (p-p), Optical jack x 1 |
| HDMI IN | 19 Pin (Type A, HDMI™ connector) x 1 |
| HDMI OUT | 19 Pin (Type A, HDMI™ connector) x 1 1080p, 1080i, 720p, 576p, 480p 2160p@24/25/30 Hz 4:4:4 2160p@60/50 Hz 4:2:0 4K Sources dependent on HDCP 2.2 are supported at 4K resolutions. |

| Amplifier (RMS Output) | |
|------------------------|--|
| Total | 440 W RMS |
| Front | 50 W RMS x 2 (4 Ω at 1 kHz, THD 10 %) |
| Center | 40 W RMS (4 Ω at 1 kHz, THD 10 %) |
| Top | 40 W RMS x 2 (4 Ω at 1 kHz, THD 10 %) |
| Subwoofer | 220 W RMS (3 Ω at 80 Hz, THD 10 %) |

| Wireless subwoofer | |
|------------------------|---|
| Power requirements | Refer to the main label on the subwoofer. |
| Power consumption | Refer to the main label on the subwoofer. |
| Type | 1 Way 1 Speaker |
| Impedance | 3 Ω |
| Rated Input Power | 220 W RMS |
| Max. Input Power | 440 W RMS |
| Dimensions (W x H x D) | Approx. 221.0 mm x 390.0 mm x 312.8 mm |

| System | |
|---------------------------------|------------------------------|
| Wireless LAN (Internal antenna) | 802.11a/b/g/n Wi-Fi networks |

SPK8-S (SPK8-S, S78S1-S), Sold Separately

| Wireless receiver | |
|------------------------|---|
| Power requirements | Refer to the main label on the wireless receiver. |
| Power consumption | Refer to the main label on the wireless receiver. |
| Rear | 70 W RMS x 2 (3 Ω at 1 kHz, THD 10 %) |
| Dimensions (W x H x D) | Approx. 60.0 mm x 220.0 mm x 175.0 mm |

| Rear speakers (Each) | |
|------------------------|--|
| Type | 1 Way 1 Speaker |
| Impedance | 3 Ω |
| Rated Input Power | 70 W RMS |
| Max. Input Power | 140 W RMS |
| Dimensions (W x H x D) | Approx. 100.0 mm x 140.0 mm x 100.0 mm |

- Designs and specifications are subject to change without prior notice.

Handling the Speaker

When shipping the speaker

Please save the original shipping carton and packing materials. If you need to ship the speaker, for maximum protection, re-pack the speaker as it was originally packed at the factory.

Keeping the exterior surfaces clean

- Do not use volatile liquids such as insecticide spray near the speaker.
- Wiping with strong pressure may damage the surface.
- Do not leave rubber or plastic products in contact with the speaker for a long period of time.

Cleaning the speaker

To clean the player, use a soft, dry cloth. If the surfaces are extremely dirty, use a soft cloth lightly moistened with a mild detergent solution. Do not use strong solvents such as alcohol, benzine, or thinner, as these might damage the surface of the speaker.

Important Information Relating to Network Services

All information, data, documents, communications, downloads, files, text, images, photographs, graphics, videos, webcasts, publications, tools, resources, software, code, programs, applets, widgets, applications, products and other content (“Content”) and all services and offerings (“Services”) provided or made available by or through any third party (each a “Service Provider”) is the sole responsibility of the Service Provider from whom it originated.

The availability of and access to Content and Services furnished by the Service Provider through the LGE Device are subject to change at any time, without prior notice, including, but not limited to the suspension, removal or cessation of all or any part of the Content or Services.

Should you have any inquiry or problem related to the Content or Services, you may refer to the Service Provider’s website for the most up-to-date information. LGE is neither responsible nor liable for customer service related to the Content and Services. Any question or request for service relating to the Content or Services should be made directly to the respective Content and Service Providers.

Please note that LGE is not responsible for any Content or Services provided by the Service Provider or any changes to, removal of, or cessation of such Content or Services and does not warrant or guaranty the availability of or access to such Content or Services.

TERMS OF USE

These Terms of Use apply to those individuals and groups who use LG's Wi-Fi speaker, any software(s) associated with LG Wi-Fi speaker, this application and any services associated this application (collectively "LG Software"). They set out LGE's responsibilities to you as well as identifying the "dos" and "don'ts" that you should be aware of when you use the LG Software. LG Software is proprietary software owned by LG Electronics Inc, a corporation registered in Korea with its registered office at Yeouido-dong 20, Yeoungdeungpo-gu, Seoul, Korea. LGE, and its licensors ("LGE", "us" or "we").

By accessing or using LG Software, you confirm that you accept these Terms of Use and that you agree to comply with them. If you do not agree to these Terms of Use, you may not access or use the LG Software. To the extent that any conflict arises between these Terms of Use and any other document referred to in these Terms of Use, these Terms of Use will take precedence, unless clearly stated otherwise in the relevant document.

We grant you a non-exclusive license to use the pre-installed copy of LG Software solely to the extent necessary for you to use your LG Wi-Fi speaker personally and for no other purpose.

You acknowledge that all ownership rights in LG Software anywhere in the world belong exclusively to us and that no ownership rights in LG Software are transferred to you. You are only entitled to the limited use of LG Software as is granted in these license terms.

You may not copy, modify, decompile or reverse engineer our software in any way unless you are allowed to do so by law. We reserve the right to suspend, withdraw or discontinue all or part of the Services without notice if we consider that you are in breach of these Terms of Use.

You acknowledge that LG Software has not been developed to meet your individual requirements. We make no promises or guarantees that LG Software is free from bugs or errors or that it will always be available. We use commercially reasonable efforts to provide LG Software on a continuous, high quality basis but cannot guarantee that they will always be available, uninterrupted or error free. It is possible that we may have to interrupt or discontinue the LG Software or suspend or restrict your use of all or any part of the Services where we consider it reasonably necessary for technical, operational, security, legal or regulatory reasons.

We do not accept any responsibility if for any reason the Services or any part of them are unavailable at any time or for any period.

Although you may use LG Software to download and access content or applications made available by third parties on your LG Software, we make no promises or guarantees that you will always be able to access such content or applications. So far as we are legally able to do so, we exclude any warranties, conditions or other terms which may be implied into these license terms by law.

So far as we are legally able to do so, we exclude any liability for any loss or damage incurred by you or any other person in connection with your use of LG Software. We are only responsible for loss or damage suffered that is a foreseeable result of our breach of these license terms or our negligence up to the amount specified below, but we are not responsible for any loss or damage that is not foreseeable. Loss or damage is foreseeable if it is an obvious consequence of our breach or if it was contemplated by you and us when you starting using LG Software.

For any loss or damage that is not excluded under these license terms, whether in contract, tort (including negligence) or otherwise, the total liability of us and our group of companies to you is limited to the amount that you paid for your LG Software service. To the extent permissible under the applicable laws, some jurisdictions do not allow the limitation or exclusion of liability for incidental or consequential damages, or have legislation that restricts the limitation or exclusion of liability, so the above limitation may not apply to you.

Nothing in these license terms shall limit or exclude our liability for death or personal injury relating from our negligence, fraud or fraudulent misrepresentation or any other liability that cannot be excluded or limited by law.

LG Software provides access to "apps" and link to other services owned and operated by third parties, such as content providers. Any third party apps, services and content that you access via the Services are made available to you by these third party providers and are outside the scope of these Terms of Use.

Your dealings with any third party providers are solely between you and the relevant provider and may be subject to the provider's own terms and conditions and privacy policy. We encourage you to read these documents, although we are not responsible for their content. We do not accept any responsibility for apps, services or content provided by third party providers.

We may impose limits on the use of or access to certain third party content, application or services, in any case without notice or liability. We expressly disclaims any responsibility or liability for any change, interruption, disabling, removal of or suspension of any content, application or service made available through this LG Software. We are neither responsible nor liable for customer service related to the content, application and services. Any question or request for service relating to third party's content, application or services should be made directly to the respective content and service providers or application developers, as appropriate.

These terms do not affect your statutory rights as a consumer.

Suitability of the Services for children and parental control tools

Modify this accordingly to suit if appropriate: The Services are not directed at children under the age of 13 and are not structured specifically to attract children under 13. Further, certain content that you may access through your use of the Services may contain material that you consider indecent, objectionable or which may not be suitable for children.

If you permit a child to use your LG Smart TV to access the Services, you are solely responsible for deciding whether or not the relevant Services are appropriate for access by that child.

[Your Smart TV offers a parental control tool (by way of a 4 digit PIN). If you have enabled the 4-digit PIN, your LG Smart TV will not be able to display restricted content unless you type in the PIN. You are responsible for setting up and maintaining the parental control tool and any other controls that are available, and we will not be responsible for any harm, loss or damage you suffer or any other user of your LG Smart TV suffers as a result of your failure to do so. Depending on the models of your LG Smart TV, these features may not be available.

Viruses and Security

Modify this accordingly to suit if appropriate: We use commercially reasonable efforts to ensure that the Services are secure and virus free, but those efforts cannot and do not guarantee that the Services will be free from bugs, viruses, or other vulnerabilities.

Further, we do not accept responsibility for any loss or damage caused by a virus, distributed denial-of-service attack, or other technologically harmful material that may infect your LG Smart TV, data or other material belonging to you, during your use of the Services.

Modify as you think appropriate: Complaints

If you have any queries, concerns or complaints about the Services, please contact [include reference to non-personal LG email address].

Modify as you think appropriate: Miscellaneous

Unless expressly stated otherwise, these Terms of Use and the documents referred to in them contain the entire agreement between us and you relating to your use of the Services and supersede any previous agreements, arrangements, undertakings or proposals, written or oral, between us and you relating to your use of the Services.

We may assign, sub-contract or otherwise transfer any or all of our rights and obligations under these Terms of Use to any company, firm or person. We can only do this if it does not materially affect your rights under these Terms of Use. You may not assign, sub-contract or otherwise transfer your rights or obligations under these Terms to anyone else (except where you dispose of your LG Smart TV to a third party) unless you first agree this with us in writing.

If we decide not to exercise or enforce any right that we have against you at a particular time, then this does not prevent us from later deciding to exercise or enforce that right.

If any part of these Terms of Use is found to be illegal, invalid or otherwise unenforceable by a court or regulator, then, where required, that part shall be deleted and the remaining parts of the Terms of Use will continue to be enforceable.

These Terms of Use do not create or infer any rights that are enforceable by any person who is not party to them.

These Terms of Use are governed by the laws of the country where your LG Smart TV is sold and both you and LGE agree to submit to the exclusive jurisdiction of the courts of the country where your LG Smart TV is sold in connection with the same

This Agreement shall be governed by the laws of the Republic of Korea, excluding their conflicts of laws provisions.

If you have any questions or comments about these Terms of Use please contact www.lg.com.

These Terms of Use may be updated by LGE from time to time. If we make a material change to our Terms of Use, we will update you via your LG Software or other means.

OPEN SOURCE SOFTWARE NOTICE INFORMATION

To obtain the source code under GPL, LGPL, MPL, and other open source licenses, that is contained in this product, please visit <http://opensource.lge.com>.

In addition to the source code, all referred license terms, warranty disclaimers and copyright notices are available for download.

LG Electronics will also provide open source code to you on CD-ROM for a charge covering the cost of performing such distribution (such as the cost of media, shipping, and handling) upon email request to opensource@lge.com.

This offer is valid for a period of three years after our last shipment of this product. This offer is valid to anyone in receipt of this information.

For more information about Google's open source, visit device settings of Google Home app.

Disclaimers

Google, Google Home, Google Play, Chromecast built-in and other related marks and logos are trademarks of Google LLC.

Google Assistant requires an internet/data connection. Data rates may apply.

The Google Assistant is not available in certain languages and countries.

Subscriptions may be required, and additional terms, conditions and/or charges may apply.

Controlling certain devices and features in your home requires a compatible smart device.

