

EN Motion detector

- theLuxa S150 WH 1010500
- theLuxa S150 BK 1010501
- theLuxa S180 WH 1010505
- theLuxa S180 BK 1010506



1. Essential safety instructions

WARNING
 Danger of death through electric shock or fire!
 Installation should only be carried out by a professional electrician!

- The device conforms with EN 60669-2-1 when correctly installed
- IP 55 in accordance with EN 60529

Designated use

- Motion detector for automatic lighting control dependent on presence and brightness
- Suitable for installation on external walls
- Suitable for entrances, garages, gardens, corridors, parks, etc.
- Only intended for installation outside of arm's reach

Disposal

Dispose of the motion detector in an environmentally sound manner (electronic waste)

2. Description

Motion detector with sensor head

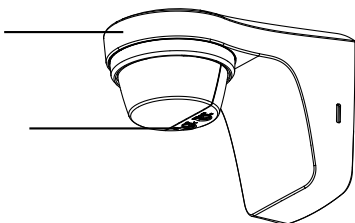

2 potentiometers for setting time (min) and brightness (lux)

3. Connection

WARNING

Danger of death through electric shock!

- Disconnect power source!
- Cover or shield any adjacent live components.
- Ensure device cannot be switched on again!
- Check power supply is disconnected!

➤ Earth and bypass!

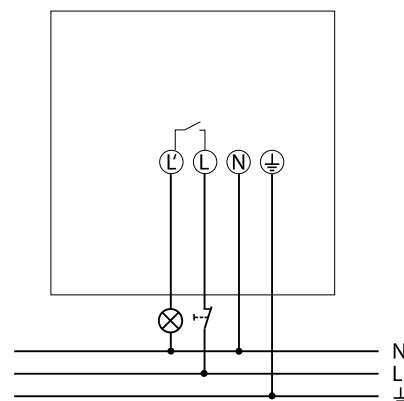
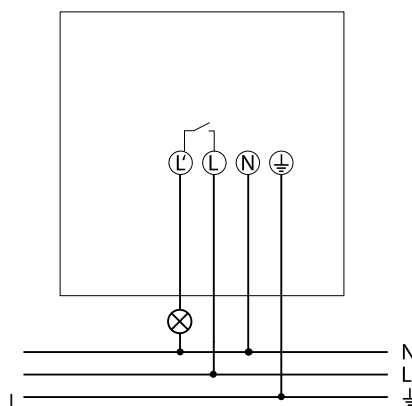

The device can be manually activated with a circuit breaker. After releasing the button (return of power) the device switches on (for at least 40 secs or for the time set on the device).

4. Installation

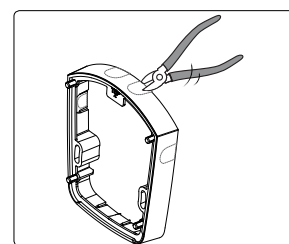
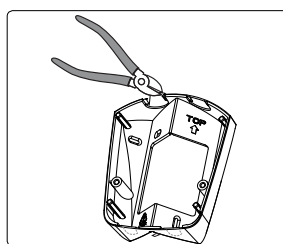

➤ If applicable, use optional corner bracket (9070902, 9070903) or spacer frame (9070906, 9070907) for flexible installation as well as cable insertion from side or top/bottom.

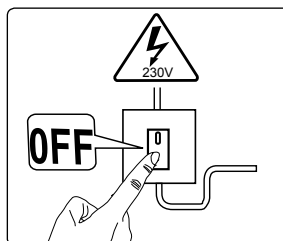

➤ Disconnect power source.

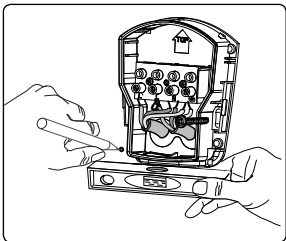

- Make marks for the holes on the wall (with enclosed drill template/base).
- Drill holes.

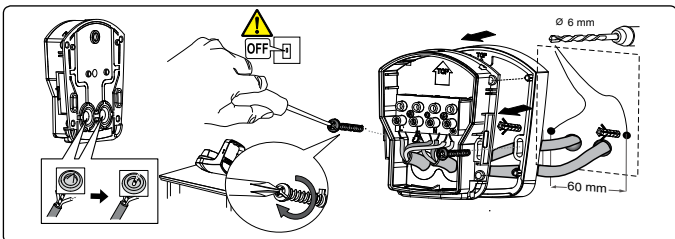

- Feed cable through the seal of the base.
- Fasten base (and spacer frame) to the wall.

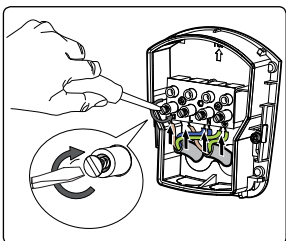

L	Phase	brown
N	Neutral conductor	blue
⊕	Earthing conductor	

L	Switched phase	brown
N	Neutral conductor	blue
⊕	Earthing conductor	green/yellow

- Connect the individual wires to the appropriate terminal.
- Tighten screws.

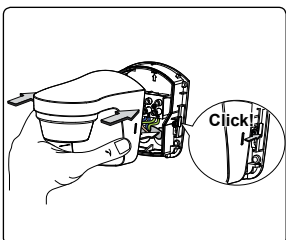

- Plug motion detector into base and click in.

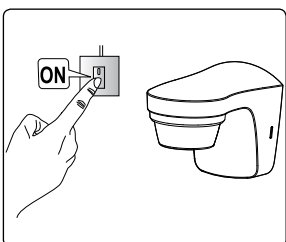

- Connect motion detector to power supply.

Dismantling

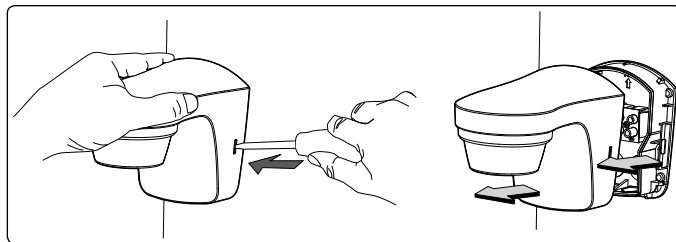

- Using the screwdriver, carefully loosen the snap-in hook at the side and pull the device forward.

Installation instructions

As the detector reacts to variations in temperature, avoid the following situations:

- Do not direct motion detectors at objects with highly reflective surfaces such as mirrors etc.
- Do not install motion detectors near heat sources such as heating outlets, air conditioning systems, lamps etc.
- Do not direct the motion detector at objects that turn in the wind such as curtains, large plants etc.
- Take account of motion direction during test run.

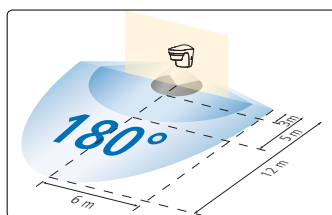
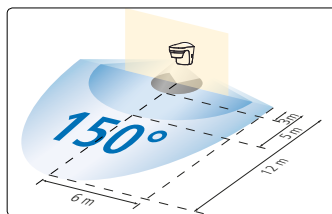
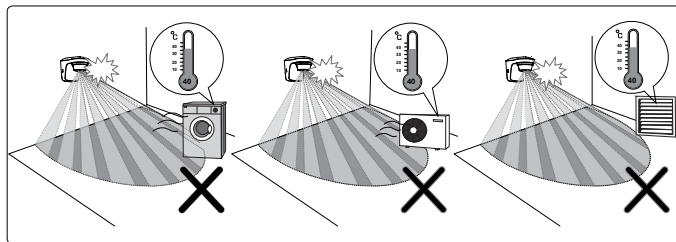

- Recommended installation height: 2 – 4 m
- Crosswise detection area: 12 m (crosswise to the detector)
- Frontal detection area: 5 m (in front of the detector)
- Detection angle: 150°/180°

5. Direction test and alignment

The walk test is used to test the detection range and to restrict it if necessary.

- Set the potentiometer time (min) to test.

The motion detector now only reacts to movement (independent of brightness).

- Crosswise to the detection area. After the motion detector has detected a movement, it switches on for 2 s.
- Note direction of motion during the test.

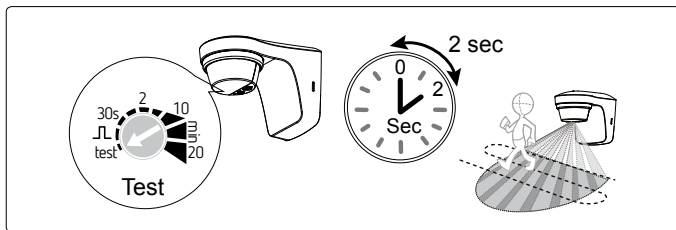

Align motion detector with sensor head

The sensor head can be turned by 30° downwards and by 90° to left and right.

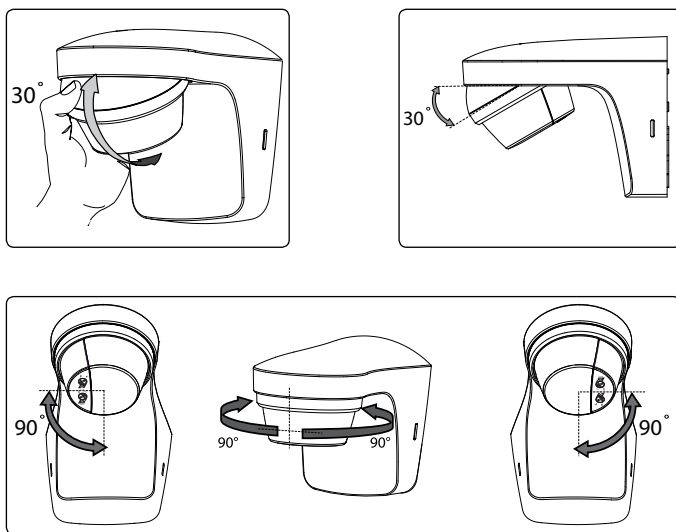

6. Setting

The motion detector has two potentiometers underneath for setting the time (min) and brightness (lux).

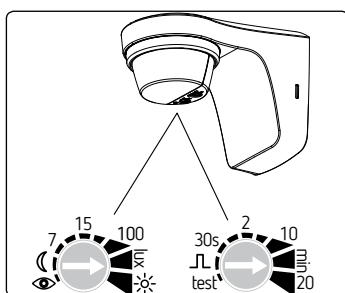

Set brightness (lux)

You can set different brightness values (lux) with the potentiometer.
If you want to change the preset brightness (15 lux default)

- Set potentiometer to desired brightness (5 – 1000 lux).

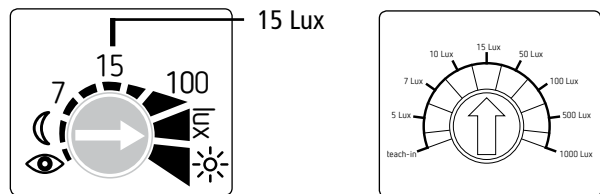

or want a specific brightness value to be learned using the teach-in function

- At the desired brightness set the potentiometer to . The value will be learned after 15 s.
- Leave potentiometer at position .

Set time (min)

If the motion detector detects no further movement, it switches off after the set time.

- If you want to change the preset time (2 min default)
- Set potentiometer to desired time (0.5 s – 20 min).

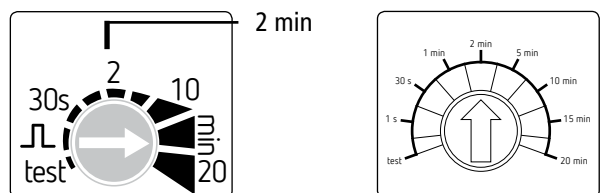

If you want to use the pulse function (e.g. for a staircase light time switch)

- Set potentiometer to position . The motion detector is switched on for < 1 s, then off for 9 s. If it detects a movement again, it switches on again for 1 s.

7. Caractéristiques techniques

- Operating voltage: 230 V AC, +10 % – 15 %
- Frequency: 50 Hz
- Standby: < 1 W
- Detection angle: 150°/180°
- Detection area: crosswise: max. 12 m, frontal: max. 5 m
- Installation height: 2 – 4 m
- Creep under protection: yes
- Brightness setting range: 5 – 1000/∞ lux
- Switching period range: 5 s – 20 min
- Permissible ambient temperature: –25 °C to +45 °C
- Protection class: II
- Protection rating: IP 55 in accordance with EN 60529
- Switching capacity: 10 A (cos φ = 1)
6 A (cos φ = 0.6)
3 AX (cos φ = 0.3)
- Min. switching capacity: 10 mA
- Switching contact: μ-Contact 230 V AC
- LED lamps <2 W 25 W
- LED lamps >2 W <8 W 90 W

- LED lamps >8 W 100 W
- Incandescent and halogen lamp load: 2300 W
- Low-voltage halogen lamps: 2300 VA
- Fluorescent lamps (low-loss series devices):
 - uncorrected: 400 VA
 - Series corrected: 400 VA
 - Parallel-corrected: 400 VA (42 µF)
- Fluorescent lamps (electronic series devices): 600 W
- Compact fluorescent tubes
(electronic series devices): 150 W

Service address

Theben AG
Hohenbergstr. 32
72401 Haigerloch
GERMANY
Phone +49 7474 692-0
Fax +49 7474 692-150

Hotline

Phone +49 7474 692-369
Fax +49 7474 692-207
hotline@theben.de

Addresses, telephone numbers etc.

www.theben.de