

FOR CAR USE ONLY/NUR FÜR AUTOMOBIL GEBRAUCH/POUR APPLICATION AUTOMOBILE UNIQUEMENT/PARA USO EN AUTOMÓVILES/SOLO PER L'UTILIZZO IN AUTOMOBILE/ENDAST FÖR BILBRUK/ALLEEN VOOR GEBRUIK IN DE AUTO/ТОЛЬКО ДЛЯ ИСПОЛЬЗОВАНИЯ В АВТОМОБИЛЯХ/DO UŻYCIA TYLKO W SAMOCHODZIE/GIA ΧΡΗΣΗ ΜΟΝΟ ΣΕ ΑΥΤΟΚΙΝΗΤΟ



Mobile Media Station

IVA-D511RB/IVA-D511R



iPhone 3GS
16GB 32GB



iPhone 3G
8GB 16GB



iPhone
4GB 8GB 16GB



iPod touch
2nd generation
8GB 16GB 32GB 64GB



iPod touch
1st generation
8GB 16GB 32GB



- OWNER'S MANUAL
Please read before using this equipment.
- BEDIENUNGSANLEITUNG
Lesen Sie diese Bedienungsanleitung bitte vor Gebrauch des Gerätes.
- MODE D'EMPLOI
Veuillez lire avant d'utiliser cet appareil.
- MANUAL DE OPERACIÓN
Léalo antes de utilizar este equipo.
- ISTRUZIONI PER L'USO
Si prega di leggere prima di utilizzare il attrezzatura.

- ANVÄNDARHANDLEDNING
Innan du använder utrustningen bör du läsa igenom denna användarhandledning.
- GEBRUIKERSHANDLEIDING
Lees deze aanwijzingen aandachtig alvorens dit toestel te gebruiken.
- РУКОВОДСТВО ПО ЭКСПЛУАТАЦИИ
Прочтите настоящее руководство перед началом использования оборудования.
- INSTRUKCJA OBSŁUGI
Prosimy zapoznać się z tą instrukcją przed przystąpieniem do użytkowania urządzenia.
- ΕΓΧΕΙΡΙΔΙΟ ΧΡΗΣΤΗ
Παρακαλούμε διαβάστε το πριν χρησιμοποιήσετε τη συσκευή.

ALPINE ELECTRONICS MARKETING, INC.
1-1-8 Nishi Gotanda,
Shinagawa-ku,
Tokyo 141-0031, Japan
Phone 03-5496-8231

ALPINE ELECTRONICS OF AMERICA, INC.
19145 Gramercy Place, Torrance,
California 90501, U.S.A.
Phone 1-800-ALPINE-1 (1-800-257-4631)

ALPINE ELECTRONICS OF CANADA, INC.
777 Superstest Road, Toronto,
Ontario M3J 2M9, Canada
Phone 1-800-ALPINE-1 (1-800-257-4631)

ALPINE ELECTRONICS OF AUSTRALIA PTY. LTD.
161-165 Princes Highway, Hallam
Victoria 3803, Australia
Phone 03-8787-1200

ALPINE ELECTRONICS GmbH
Wilhelm-Wagenfeld-Str. 1-3, 80807 München, Germany
Phone 089-32 42 640

ALPINE ELECTRONICS OF U.K. LTD.
Alpine House
Fletchamstead Highway, Coventry CV4 9TW, U.K.
Phone 0870-33 33 763

ALPINE ELECTRONICS FRANCE S.A.R.L.
(RCS PONTOISE B 338 101 280)
98, Rue de la Belle Etoile, Z.I. Paris Nord II,
B.P. 50016, 95945 Roissy Charles de Gaulle
Cedex, France
Phone 01-48638989

ALPINE ITALIA S.p.A.
Viale C. Colombo 8, 20090 Trezzano
Sul Naviglio (MI), Italy
Phone 02-484781

ALPINE ELECTRONICS DE ESPAÑA, S.A.
Portal de Gamarra 36, Pabellón, 32
01013 Vitoria (Alava)-APDO 133, Spain
Phone 945-283588

ALPINE ELECTRONICS (BENELUX) GmbH
Leuvensesteenweg 510-B6,
1930 Zaventem, Belgium
Phone 02-725-13 15

EN

DE

FR

ES

IT

SE

NL

RU

PL

GR

Contents

Operating Instructions

WARNING

WARNING	5
CAUTION	5
PRECAUTIONS	6
Discs Playable on This Unit	7

Getting Started

Accessory List	11
Location of Controls	11
Detaching and Attaching the Front Panel	12
Initial System Start-Up	12
Turning Power On or Off	12
Opening/Closing the Monitor	12
Moving the Monitor to be Flat	13
Adjusting the Volume	13
Lowering Volume Quickly	13
How to view the Display	13
TOUCH PANEL operation	13
Recalling the Source	13
Displaying the Numeric Keypad Input Screen	14

Radio

Listening to the Radio	15
Presetting Stations Manually	15
Presetting Stations Automatically	15
Tuning to Preset Stations	15

RDS Operation

Turning AF (Alternative Frequencies) On or Off	16
Receiving Traffic Information	16
PTY (Programme Type) Tuning	16
Receiving Traffic Information While Playing CD or Radio	17
Priority News	17
Using iTunes Tagging	17
Displaying Radio Text	17

CD/MP3/WMA/AAC

Playback	18
Repeat Play	18
M.I.X. (Random Play)	19
Selecting Folders (concerning MP3/WMA/AAC)	19
About MP3/WMA/AAC	19

DVD/Video CD

Playing a Disc	21
To display the DVD mode screen	21
If a menu screen appears	22
Displaying the Top Menu Screen	23
Displaying the Menu Screen	23
Displaying the Menu Operation Mode Screen	23
Searching by Programme	23
Searching by Playlist	23
Stopping Playback (Pre Stop)	24
Stopping Playback	24
Fast-forwarding/Fast-reversing	24
Finding the Beginnings of Chapters/Tracks/Files	24
Playing Still Frames (Pausing)	24
Forward/reverse frame-by-frame Playback	24
Slow Motion Playback	25
Selecting Programme (SKIP)	25
Selecting Playlist (SKIP)	25
Selecting Folders	25
Repeat Playback	25
Searching by Title/Group/Program/playlist/ Folder Number	26
Searching Directly by Chapter, Track or File Number	26
Switching the Angle	27
Scroll to Move the Page Forward or Backward	27
Switching the Audio Tracks	27
Switching the Subtitles (Subsubtitle Language)	27
Switching from the disc menu	27
About DivX®	28

Other Useful Features

Adjusting the Audio	28
Storing Settings in the Memory	31
Calling up the Preset Memory	31
Search Function	31
Rear Selection Function	32
Switching Display Modes	32
Switching the Visual Source Only (Simultaneous Function)	33
Cancelling the Simultaneous Function	33
Blackout Mode On and Off	33

Setup

DVD Setup

DVD Setup Operation	33
Changing the language setting	34
Setting of the Menu Language	34
Setting of the Audio Language	34
Setting of the Subtitle Language	34
Changing the Country Code Setting	34
Setting the Rating Level (Parental Lock)	35
Changing the Digital Output Setting	35
Setting the Downmix Mode	37
Setting the TV Screen	37
Setting of the Bonus Code	37
Setting the DVD-Audio Playback Mode	37
Playing MP3/WMA/AAC Data (File Play Mode)	38
Setting the compressed File Playback Data	38
Displaying DivX® Disc Information	38
Setting the Video CD Play Mode	38

Source Setup

Source Setup Operation	38
Radio Setup	38

Display Setup

Display Setup Operation	39
Adjusting the Monitor Angle	39
Setting Automatic Opening/Closing of the Monitor	40
Setting the Brightness of the Backlighting	40
Adjusting the Minimum Level of Backlight	40
Turn the Function Guide ON/OFF (Function Guide Fade)	40
Switching the Font Background Colour	40
Adjusting the Touch Panel	40

Visual EQ™

Visual EQ Setting Operation	41
Adjusting Image Brilliance (Live Contrast)	41
Selecting the Visual EQ Mode (Factory's setting)	41
Adjusting Brightness	41
Adjusting Colour of Picture	41
Adjusting Tint of Picture	42
Adjusting Image Contrast	42
Adjusting Picture Quality	42
Storing Visual EQ	42

General Setup

General Setup Operation	42
Displaying the Time	42
Setting the Clock Display	42
Setting the Time	43
Setting Summer Time	43
Demonstration Function	43
Sound (Beep) Guide Function	43
Setting the Scroll	43
Changing the Russian Font	43
Adjusting the Dimmer of Button Lighting at Night	43

System Setup

System Setup Operation	44
Setting the External Device Interrupt Mode	44
Setting the Interrupt Icon Display	44
Switching the function of the remote sensor	44
Setting the Rear Camera Input	44
Setting the Navigation Mode	45
Setting the Navigation Interruption	45
Setting the AUX Mode	45
Setting the Picture/Sound Output	46
Setting the BLUETOOTH Connection (BLUETOOTH IN)	46
Setting the Digital Output	46
Setting the AUX+ Mode	46
Setting the AUX+ Level	46
Changing the Lighting Colour of Buttons	46

IMPRINT Operation (Optional)

Changing MultEQ mode	47
Adjusting Sound Setting in Manual Mode	47
Setting the MX Level (Media Xpander)	47
Adjusting the Crossover Settings (X-Over)	48
Adjusting the Time Correction (Time Correction)	49
Setting the Time Correction Unit (T.Corr Parameter)	49
Graphic Equalizer Adjustments (G-EQ)	49
Adjusting the Parametric Equalizer Curve (P-EQ)	49
Equalizer Presets (F-EQ)	50
Setting the Response Slope for the High Range Speaker (TW Setup)	50
Storing Settings in the Memory	50
Calling up the Preset Memory	50
About Time Correction	51
About the Crossover	52

External Audio Processor Operation (Optional)

Adjustment Procedure for Dolby Surround	53
Setting the External Audio Processor	53
Set MX Mode of the External Audio Processor	54
Setting Bass Sound Control	54
Using the Pro Logic II Mode	54
X-OVER Adjustment	55
Performing Time Correction Manually (Time Correction)	55
Phase Switching	56
Graphic Equalizer Adjustments	56
Parametric Equalizer Adjustments	56
Setting the Speakers	56
Setting of Dolby Digital	57
Speaker Setup	57
Adjusting the DVD Level	58
Linear PCM Setting	58
Storing Settings in the Memory	58
Calling up the Preset Memory	58

BLUETOOTH Operation (Optional)

Setup Before Using	58
About BLUETOOTH	58
Before Using Hands-Free Function	58
How to connect to a BLUETOOTH compatible device (Pairing)	59
BLUETOOTH Setup	59
BLUETOOTH Setup Operation	59
Hands-Free Phone Control	60
About the Hands-Free Phone	60
Answering a Call	61
Hanging up the Telephone	61
Adjusting the volume when receiving a Call	61
Redial Function	61
Call Switching Operation	61
Call History	61
Redialing a Number in Dialed Calls History	62
Dialing a Number in Received Calls History	62
Dialing a Number in Missed Calls History	62
Dialing a Number In the Phone Book (Phone Book)	62
Dialing a Number Using Direct Dial Input	62
Voice Dial Operation	62
BLUETOOTH Audio Function	63
BLUETOOTH Audio Operation	63

Rearview Camera Operation (Optional)

Switching the Rear Camera Screen (Optional)	63
Displaying the rear view video while the car is in reverse	63
Displaying the rear view video manually	63

Navigation System (Optional)

Switching the Navigation Screen (Optional)	64
Portable Navigation System Operation (Optional)	64
With using the docking station type	64

Auxiliary Device (Optional)

Operating Auxiliary Devices (Optional) 64

TUE-T200DVB Operation (Optional)

Operating the TUE-T200DVB (Optional) 65

Changer (Optional)

Controlling CD Changer (Optional) 66

Multi-Changer Selection (Optional) 66

USB Memory/Portable audio player (Optional)

BANK Function 67

Playback 67

Repeat Play 68

Random Play Shuffle (M.I.X.) 68

Searching for a desired Song 68

 Searching by artist name 68

Alphabet Skip Function 69

Selecting Playlist/Artist/Album/

 Genre/Composer 69

Select the desired Folder (Folder up/down) 69

Creating the playlist from the Artist/Album
information of the current song 69

iPod/iPhone (Optional)

Connecting an iPod/iPhone 70

Playback 70

Searching for a desired Song 70

 Searching by artist name 71

Direct Search Function 71

Alphabet Skip Function 71

Selecting Playlist/Artist/Album/Genre/

 Composer/Episode/Category 72

Random Play Shuffle (M.I.X.) 72

Repeat Play 72

About Sub Display

Information

About DVDs 74

Terminology 75

List of Language Codes 76

List of Country Codes 77

In Case of Difficulty 79

Specifications 83

Installation and Connections

Warning 84

Caution 84

Precautions 84

Installation 85

Connections 87

System Example 90

Operating Instructions

WARNING



WARNING

This symbol means important instructions. Failure to heed them can result in serious injury or death.

INSTALL THE PRODUCT CORRECTLY SO THAT THE DRIVER CANNOT WATCH TV/VIDEO UNLESS THE VEHICLE IS STOPPED AND THE EMERGENCY BRAKE IS APPLIED.

It is dangerous for the driver to watch TV/Video while driving a vehicle. Installing this product incorrectly enables the driver to watch TV/Video while driving. This may cause a distraction, preventing the driver from looking ahead, thus causing an accident. The driver or other people could be severely injured.

DO NOT WATCH VIDEO WHILE DRIVING.

Watching the video may distract the driver from looking ahead of the vehicle and cause an accident.

DO NOT OPERATE ANY FUNCTION THAT TAKES YOUR ATTENTION AWAY FROM SAFELY DRIVING YOUR VEHICLE.

Any function that requires your prolonged attention should only be performed after coming to a complete stop. Always stop the vehicle in a safe location before performing these functions. Failure to do so may result in an accident.

KEEP THE VOLUME AT A LEVEL WHERE YOU CAN STILL HEAR OUTSIDE NOISES WHILE DRIVING.

Excessive volume levels that obscure sounds such as emergency vehicle sirens or road warning signals (train crossings, etc.) can be dangerous and may result in an accident. LISTENING AT LOUD VOLUME LEVELS IN A CAR MAY ALSO CAUSE HEARING DAMAGE.

MINIMIZE DISPLAY VIEWING WHILE DRIVING.

Viewing the display may distract the driver from looking ahead of the vehicle and cause an accident.

DO NOT DISASSEMBLE OR ALTER.

Doing so may result in an accident, fire or electric shock.

USE ONLY IN CARS WITH A 12 VOLT NEGATIVE GROUND.

(Check with your dealer if you are not sure.) Failure to do so may result in fire, etc.

KEEP SMALL OBJECTS SUCH AS BOLTS OR SCREWS OUT OF THE REACH OF CHILDREN.

Swallowing them may result in serious injury. If swallowed, consult a physician immediately.

USE THE CORRECT AMPERE RATING WHEN REPLACING FUSES.

Failure to do so may result in fire or electric shock.

DO NOT BLOCK VENTS OR RADIATOR PANELS.

Doing so may cause heat to build up inside and may result in fire.

USE THIS PRODUCT FOR MOBILE 12V APPLICATIONS.

Use for other than its designed application may result in fire, electric shock or other injury.

DO NOT PLACE HANDS, FINGERS OR FOREIGN OBJECTS IN INSERTION SLOTS OR GAPS.

Doing so may result in personal injury or damage to the product.



CAUTION

This symbol means important instructions. Failure to heed them can result in injury or material property damage.

HALT USE IMMEDIATELY IF A PROBLEM APPEARS.

Failure to do so may cause personal injury or damage to the product. Return it to your authorized Alpine dealer or the nearest Alpine Service Centre for repairing.

KEEP FINGERS AWAY WHILE THE MOTORIZED FRONT PANEL OR MOVING MONITOR IS IN MOTION.

Failure to do so may result in personal injury or damage to the product.

PRECAUTIONS

Product Cleaning

Use a soft dry cloth for periodic cleaning of the product. For more severe stains, please dampen the cloth with water only. Anything else has the chance of dissolving the paint or damaging the plastic.

Temperature

Be sure the temperature inside the vehicle is between +45°C (+113°F) and 0°C (+32°F) before turning your unit on.

Moisture Condensation

You may notice the disc playback sound wavering due to condensation. If this happens, remove the disc from the player and wait about an hour for the moisture to evaporate.

Damaged Disc

Do not attempt to play cracked, warped, or damaged discs. Playing a bad disc could severely damage the playback mechanism.

Maintenance

If you have problems, do not attempt to repair the unit yourself. Return it to your Alpine dealer or the nearest Alpine Service Station for servicing.

Never Attempt the Following

Do not grip or pull out the disc while it is being pulled back into the player by the automatic reloading mechanism.

Do not attempt to insert a disc into the unit when the unit power is off.



Inserting Discs

Your player accepts only one disc at a time for playback. Do not attempt to load more than one disc.

Make sure the label side is facing up when you insert the disc. "Disc Error" will be displayed on your player if you insert a disc incorrectly. If "Disc Error" continues to be displayed even though the disc has been inserted correctly, push the RESET switch with a pointed object such as a ballpoint pen.

Playing a disc while driving on a very bumpy road may result in skips, but this will not scratch the disc or damage the player.

Irregular Shaped Discs

Be sure to use round shaped discs only for this unit and never use any special shaped discs.

Use of special shaped discs may cause damage to the mechanism.



New Discs

To prevent the CD from jamming, "Disc Error" is displayed if discs with irregular surfaces are inserted or if discs are inserted incorrectly. When a new disc is ejected immediately after initial loading, use your finger to feel around the inside of the centre hole and outside edge of the disc. If you feel any small bumps or irregularities, this could inhibit proper loading of the disc. To remove the bumps, rub the inside edge of the hole and outside edge of the disc with a ballpoint pen or other such instrument, then insert the disc again.

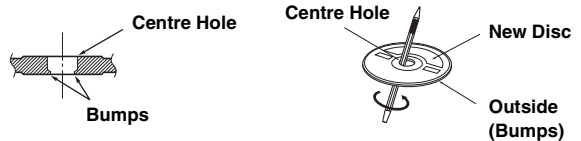

Installation Location

Make sure the IVA-D511RB/IVA-D511R will not be installed in a location subjected to:

- Direct sun and heat
- High humidity and water
- Excessive dust
- Excessive vibrations

Correct Handling

Do not drop the disc while handling. Hold the disc so you will not leave fingerprints on the surface. Do not affix tape, paper, or gummed labels to the disc. Do not write on the disc.

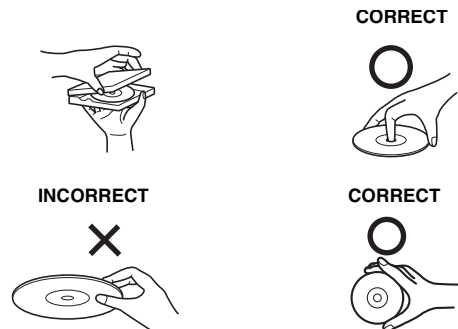

Disc Cleaning

Fingerprints, dust, or soil on the surface of the disc could cause the DVD player to skip. For routine cleaning, wipe the playing surface with a clean, soft cloth from the centre of the disc to the outer edge. If the surface is heavily soiled, dampen a clean, soft cloth in a solution of mild neutral detergent before cleaning the disc.



Disc Accessories

There are various accessories available on the market for protecting the disc surface and improving sound quality. However, most of them will influence the thickness and/or diameter of the disc. Using such accessories can cause the disc to be out of standard specifications and may create operational problems. We recommend not using these accessories on discs played in Alpine DVD players.

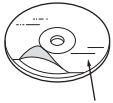

Transparent Sheet

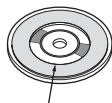

Disc Stabilizer

Handling the Detachable Front Panel

- Do not expose to rain or water.
 - Do not drop or subject to shock.
-
- After turning the system off, a slight ghost of the image will remain temporarily. This is an effect peculiar to LCD technology and is normal.
 - In cold temperature conditions, the screen may lose contrast temporarily. After a short warm-up period, it will return to normal.

Alpine products equipped with the Ai-NET bus, connected to the IVA-D511RB/IVA-D511R, can be operated from the IVA-D511RB/IVA-D511R. Depending on the products connected, the functions and displays will vary. For details, consult your Alpine dealer.

Operation of some of the functions of this unit is very complex. Because of this, it was deemed necessary to place these functions into a special screen. This will restrict operation of these functions to times when the vehicle is parked. This ensures the focus of the driver's attention will be on the road and not on the IVA-D511RB/IVA-D511R. This has been done for the safety of the driver and passengers.

Audio Processor Adjustments cannot be made if the car is moving. The car must be parked and the parking brake must be engaged for the procedure described in the Owner's Manual to be valid. The warning "Can't operate while driving", will be displayed if any attempts are made to perform these operations while driving.

- The IVA-D511RB/IVA-D511R draws minimal current even when its power switch is turned off. If the switched power (ignition) lead of the IVA-D511RB/IVA-D511R is connected directly to the positive (+) post of the vehicle's battery, the battery may be discharged. An SPST (Single-Pole, Single-Throw) switch (sold separately) can be added to simplify this procedure. Then, you can simply place it in the OFF position when you leave the vehicle. Turn the SPST switch back ON before using the IVA-D511RB/IVA-D511R. For connecting the SPST switch, refer to the "Connection Diagram of SPST Switch (Sold Separately)" (page 86). If the power (ignition) lead is unswitched, it must be disconnected from the battery post should the vehicle be left unused for an extended period of time.

Discs Playable on This Unit

Playable discs

The discs listed below can be played on this unit.

	Mark (logo)	Recorded content	Disc size
DVD Video		Audio + Video	12 cm*
			8 cm
DVD Audio		Audio + Video	12 cm*
			8 cm
Video CD		Audio + Video	12 cm
			8 cm
Music CD		Audio	12 cm
			8 cm (CD single)
DivX®		Audio + Video	12cm
			8 cm

* Two-layer DVD disc compatible

The formatted discs listed below can be played on this unit.

	CD-R/ CD-RW	DVD-R/ DVD-RW	DVD+R/ DVD+RW
CD Format	○		
MP3 Format ("mp3")	○	○	○
WMA Format ("wma")	○	○	○
AAC Format ("aac", "m4a")	○	○	○
DVD Video Format		○	○
DVD-VR Format		○	
DivX Format ("avi", "divx")	○	○	○
Video CD Format	○		

Discs that are not finalised cannot be played back

Discs that cannot be played

DVD-ROMs, DVD-RAMs, CD-ROMs (excluding MP3/WMA/AAC files), photo CDs, etc.

DualDisc

This unit is not compatible with DualDisc.

Using a DualDisc may cause unit malfunction, and may cause disc damage when the disc is inserted/ejected.

DVD region number (playable region number)

This DVD player will play back any disc whose region number is 2 (or All). DVDs with a region number other than those listed below, cannot be played on this DVD player.



Video CDs

This DVD head unit is compatible with playback control (PBC) compatible Video CDs (version 2.0).

“PBC” is a function by which you can use menu screens recorded on the disc to find the scene you want to watch and view various types of information in dialogue style.

Using compact discs (CD/CD-R/CD-RW)

If you use unspecified compact discs, correct performance cannot be guaranteed.

You can play CD-Rs (CD-Recordable)/CD-RWs (CD-ReWritable) which have been recorded only on audio devices. You can also play CD-Rs/CD-RWs containing MP3/WMA/AAC formatted audio files.

- Some of the following discs may not play on this unit:
Flawed discs, discs with fingerprints, discs exposed to extreme temperatures or sunlight (e.g., left in the car or this unit), discs recorded under unstable conditions, discs on which a recording failed or a re-recording was attempted, copy-protected CDs which do not conform to the audio CD industry standard.
- Use discs with MP3/WMA/AAC files written in a format compliant with this unit. For details, see pages 19 and 20.

To customers using CD-R/CD-RW

- If a CD-R/CD-RW cannot be played back, make sure the last recording session was closed (finalized).
- Finalize the CD-R/CD-RW if necessary, and attempt playback again.

Tips for making your own CDs

The IVA-D511RB/IVA-D511R plays DVD Video, DVD Audio, Video CD, Audio CD, DivX[®] and has a built in MP3/WMA/AAC decoder.

The following information is designed to help you create your own music CDs (either Audio CD or MP3/WMA/AAC encoded CD-R/RW files).

What is the difference between an Audio and MP3/WMA/AAC CD?

An Audio CD is the same format as the commercial CDs you buy in the store (also known as CD-DA). MP3 (MPEG-1 Audio Layer 3)/WMA (Windows Media Audio)/AAC (Advanced Audio Coding) is a data file that uses a compression scheme to reduce the size of the music file.*

Hybrid Audio CD and Data (MP3/WMA/AAC) CD-R/RW discs:

The IVA-D511RB/IVA-D511R can read either sector on the disc. Choose CD-DA to play the CD audio section or MP3/WMA/AAC to play the MP3/WMA/AAC section.*

Multi-session CD-R/RW:

Once a recording has been stopped, this is considered one session. If the disc is not closed (finalized), additional data may be added. Once this additional data has been recorded, this becomes a “multi-session” CD. The IVA-D511RB/IVA-D511R can only read multi-session DATA Formatted discs (MP3/WMA/AAC files - Not Audio CD files).

Properly formatted MP3/WMA/AAC Discs:

Use ISO9660 formatting to insure proper playback. You may use standard ISO naming Level 1 (8.3 DOS standard), Level 2 (32 characters) or Joliet (Windows or Macintosh long filenames) file naming conventions*.

*Please consult the Owner’s manual for additional information.

On handling compact discs (CD/CD-R/CD-RW)

- Do not touch the surface.
- Do not expose the disc to direct sunlight.
- Do not affix stickers or labels.
- Clean the disc when it is dusty.
- Make sure that the disc is smooth and flat.
- Do not use commercially available disc accessories.

Do not leave the disc in the car or the unit for a long time. Never expose the disc to direct sunlight.

Heat and humidity may damage the disc and you may not be able to play it again.

Using DVD-Rs/DVD-RWs/DVD+Rs/DVD+RWs

- This unit is compatible with discs recorded in the standard DVD-Video and DVD-VR (DVD-R/DVD-RW only) formats.
- Note that discs not finalized (processed to enable to play on playback-only DVD players) cannot be played on this DVD player.
- Some discs may not play back, depending on the recording device and disc format.
- Discs or files utilizing copy protection, may not be playable. Some recording systems may not properly format copied files to enable proper playback.
- In the following cases, the disc may not play on this unit: discs recorded by certain DVD recorders, certain irregular discs, flawed discs, dirty discs, when the pickup lens of this DVD player is dirty, or when moisture condensation has occurred inside the unit.
- Be sure to follow all cautions included with your DVD-Rs/DVD-RWs/DVD+Rs/DVD+RWs discs.
- Do not put stickers, seals, or tape on the label side of DVD-Rs/DVD-RWs/DVD+Rs/DVD+RWs.
- Compared to the regular discs, DVD-Rs/DVD-RWs/DVD+Rs/DVD+RWs are more affected by heat, moisture, and direct sunlight. If left in a car, etc., damage may occur and it might not play on this unit.
- The operable temperature range for disc playback is as follows:
DVD-R/DVD-RW: -25 ~ +70°C
DVD+R/DVD+RW: +5 ~ +55°C

Disc terminology

Title

If titles are programmed for the DVD, these are the largest units of division of the information recorded on the disc.

Chapter

Each Title may also be divided into smaller divisions, called chapters. These can be specific scenes or musical selections.

Protecting the USB connector

- Only an iPod/iPhone, USB memory or Portable audio player can be connected to the USB connector on this unit. Correct performance using other USB products cannot be guaranteed.
- If the USB connector is used, be sure to use only the supplied connector cable with the unit. A USB hub is not supported.
- Depending on the connected USB memory device, the unit may not function or some functions may not be performed.
- The audio file format that can be played back on the unit is MP3/WMA/AAC.
- Artist/song name, etc., can be displayed, however characters may not be correctly displayed.



CAUTION

Alpine accepts no responsibility for lost data, etc., even if data, etc., is lost while using this product.

On Handling USB Memory

- This unit can control a memory storage device that supports the USB Mass Storage Class (MSC) protocol. Playable audio file formats are MP3, WMA and AAC.
- USB memory function is not guaranteed. Use USB memory according to the terms of agreement. Read the USB memory Owner's Manual thoroughly.
- Avoid usage or storage in the following locations:
 - Anywhere in the car exposed to direct sunlight or high temperatures.
 - Anywhere the possibility of high humidity or corrosive substances are present.
- Fix the USB memory in a location where driver operation will not be hindered.
- USB memory may not function correctly at high or low temperature.
- Use only certified USB memory. Note that even certified USB memory, may not function correctly depending on its type or state.
- Depending on the settings of the USB memory type, memory state or encoding software, the unit may not play back or display properly.
- Files protected by DRM (Digital Rights Management), cannot be played back on this unit. These include AAC formatted files purchased from the iTunes Store and WMA or other files with some form of copyright protection.
- USB memory may take time to start playback. If there is a particular file other than audio in the USB memory, it may take considerable time before the file is played back or searched.
- The unit can play back "mp3", "wma" or "m4a" file extensions.
- Do not add the above extensions to a file other than audio data. This non-audio data will not be recognized. The resulting playback may contain noise that can damage speakers and/or amplifiers.
- It is recommended to back up important data on a personal computer.
- Do not remove the USB device while playback is in progress. Change SOURCE to something other than USB, then remove the USB device to prevent possible damage to its memory.

On Handling Portable audio player

- The unit can control a Portable audio player with the USB interface. Playable audio file formats are MP3 and WMA.
- Portable audio player function is not guaranteed. Use Portable audio player according to the terms of agreement. Read the Portable audio player Owner's Manual thoroughly.
- Avoid usage or storage in the following locations:
 - Anywhere in the car exposed to direct sunlight or high temperatures.
 - Anywhere the possibility of high humidity or corrosive substances are present.
- Fix the Portable audio player in a location where driver operation will not be hindered.
- Portable audio player may not function correctly at high or low temperature.
- Depending on the settings of the Portable audio player type, memory state or encoding software, the unit may not play back or display properly.
- If the Portable audio player has an MSC/MTP setting, set to MTP.
- A Portable audio player in which data is stored by USB Mass Storage may not be playable on the unit.
- Depending on the Portable audio player settings, USB Mass Storage may be supported. For setting, refer to the Owner's Manual of the player.
- The unit can play back MP3/WMA files synchronized by Windows Media Player (Ver. 10 or 11), and are then forwarded to the player. The "mp3" or "wma" extensions are playable.
- If data is not synchronized by Windows Media Player and is forwarded in another way, the unit may not be able to correctly play back the files.
- WMDRM10 is supported by the unit.
- A file that is copy-protected (copyright protection) cannot be played back.
- It is recommended to back up important data on a personal computer.
- Do not remove the USB device while playback is in progress. Change SOURCE to something other than USB, then remove the USB device to prevent possible damage to its memory.
- *This product incorporates copyright protection technology that is protected by U.S. patents and other intellectual property rights. Use of this copyright protection technology must be authorized by Macrovision, and is intended for home and other limited viewing uses only unless otherwise authorized by Macrovision. Reverse engineering or disassembly is prohibited.*
- *Manufactured under license from Dolby Laboratories. Dolby and the double-D symbol are trademarks of Dolby Laboratories.*
- *Manufactured under license under U.S. Patent #'s: 5,451,942; 5,956,674; 5,974,380; 5,978,762; 6,487,535 & other U.S. and worldwide patents issued & pending. DTS and the Symbol are registered trademarks, & DTS 2.0+ Digital Out and the DTS logos are trademarks of DTS, Inc. Product includes software. © DTS, Inc. All Rights Reserved.*
- *Windows Media and the Windows logo are trademarks, or registered trademarks of Microsoft Corporation in the United States and/or other countries.*
- *iPod and iTunes are trademarks of Apple Inc., registered in the U.S. and other countries.*
- *iPhone is a trademark of Apple Inc., registered in the U.S. and other countries.*
- *"Made for iPod" means that an electronic accessory has been designed to connect specifically to iPod and has been certified by the developer to meet Apple performance standards.*
- *"Works with iPhone" means that an electronic accessory has been designed to connect specifically to iPhone and has been certified by the developer to meet Apple performance standards.*
- *Apple is not responsible for the operation of this device or its compliance with safety and regulatory standards.*
- *The BLUETOOTH® word mark and logos are registered trademarks owned by the Bluetooth SIG, Inc. and any use of such marks by Alpine Electronics, Inc. is under license.*
- *"MPEG Layer-3 audio coding technology licensed from Fraunhofer IIS and Thomson"*
- *"Supply of this product only conveys a license for private, non-commercial use and does not convey a license nor imply any right to use this product in any commercial (i.e. revenue-generation) real time broadcasting (terrestrial, satellite, cable and/or any other media), broadcasting/streaming via internet, intranets and/or other networks or in other electronic content distribution systems, such as pay-audio or audio-on-demand applications. An independent license for such use is required. For details, please visit <http://www.mp3licensing.com>"*
- *Audyssey MultEQ XT is a registered trademark of Audyssey Laboratories Inc.*
- *DivX, DivX Certified, and associated logos are trademarks of DivX, Inc. and are used under license. DivX Certified to play DivX video.*

Getting Started

Accessory List

• Head unit	1
• Power Cable	1
• Pre OUT/AUX cable	1
• Mounting Sleeve	1
• Mounting Bracket	2
• Flush Head screw (M4 x 5)	8
• Hexagon washer-head screw (M4 x 6)	4
• Rubber Cap	1
• Hex Bolt	1
• Front Frame	1
• USB extension cable	1
• Carrying bag	1
• Owner's Manual	1 set

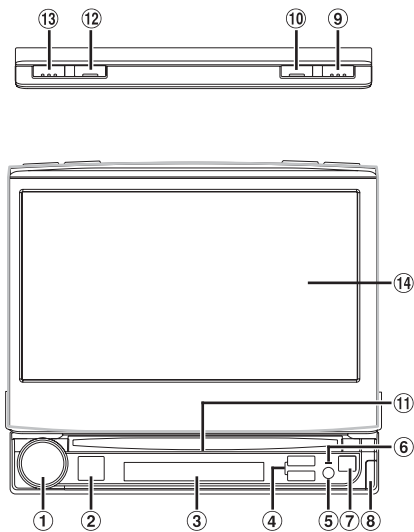

Connectable to Remote Control Interface Box

You can operate this unit from the vehicle's control unit when an Alpine Remote Control Interface Box (optional) is connected. For details, contact your Alpine dealer.

Location of Controls

- ① **Rotary encoder/MODE/MUTE**
Adjust the volume by turning to the left or right.
Press to display the Audio mode screen. The Balance/Fader, Subwoofer Level, Defeat mode can be adjusted in this mode.
Press and hold for at least 2 seconds to activate/deactivate the mute mode.
- ② **SOURCE/⏪ button**
Turns the power on. Press and hold for at least 3 seconds to turn the power off.
Monitor open: Recalls the SOURCE selection screen.
Monitor closed: Changes the source.
- ③ **Sub Display**
Refer to "About Sub Display" on page 73.
- ④ **Track tune button**
Press to select the desired Radio preset station/track/file/ chapter.
- ⑤ **Remote Sensor**
Point the optional remote control transmitter towards the remote sensor within a range of 2 meters.
- ⑥ **Power/Operation Indicator**
This indicator is lit when power is on.
Blinks when operation is done.
- ⑦ **⏏ button**
Ejects a disc.
- ⑧ **⏏ button**
Use this button to remove the front panel.
- ⑨ **OPEN/CLOSE button**
Press to open/close the monitor.
- ⑩ **FLAT button**
Press to set the open monitor to the flat position.
- ⑪ **DISC Slot Indicator**
Lights up when power is on.
- ⑫ **VISUAL button**
Monitor open: Press to recall the VISUAL selection screen.
Monitor closed: Press to toggle the text information, tag information, etc. on the Sub display.
- ⑬ **BAND/TA button**
Radio mode: Changes the band.
Press this button for at least 2 seconds to turn the T.INFO mode ON or OFF.
- ⑭ **Main Display**

- *The buttons on the face of this unit are shown in bold (e.g. **SOURCE/⏪**). The onscreen buttons that appear in the display are shown in bold enclosed by [] (e.g. **[BAND]**).*

Detaching and Attaching the Front Panel

Detaching

- 1 Turn off the unit power.
- 2 Press **△** (Release) at the lower right side until the front panel pops out.
- 3 Grasp the right side of the front panel and pull it out.

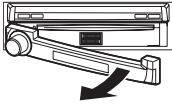

- The front panel may become hot in normal usage (especially the connector terminals on the back of the front panel). This is not a malfunction.
- To protect the front panel, place it in the supplied carrying bag.

Attaching

- 1 Insert the left side of the front panel into the main unit. Align the groove on the front panel with the projections on the main unit.
- 2 Push the right side of the front panel until it locks firmly into the main unit.

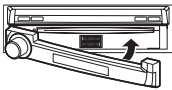

- Before attaching the front panel, make sure that there is no dirt or dust on the connector terminals and no foreign object between the front panel and the main unit.
- Attach the front panel carefully, holding the sides of the front panel to avoid pushing buttons by mistake.

Initial System Start-Up

Immediately after installing or applying power to the unit, it should be initialized. To do this, first, remove the detachable front panel. Behind the front panel, to the left of the connector, there is a small hole. Using a pencil or other pointed object, press the RESET switch mounted behind this hole to complete the initialization procedure.

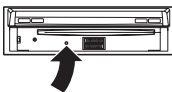

- Any of the buttons does not function while the monitor is closing by reset.

Turning Power On or Off

Some of this unit's functions cannot be performed while the vehicle is in motion. Be sure to stop your vehicle in a safe location and apply the parking brake, before attempting these operations.

- 1 Press **SOURCE/⏻** to turn on the unit.
 - The unit can be turned on by pressing any button on the unit except **OPEN/CLOSE**, **FLAT** and **△** (Eject).
- 2 Press and hold **SOURCE/⏻** for at least 3 seconds to turn off the unit.

Opening/Closing the Monitor

- 1 Press **OPEN/CLOSE**.

The monitor beeps 3 times and opens the monitor automatically.
- 2 Press **OPEN/CLOSE** again.

The monitor beeps 3 times and closes the monitor automatically.

 - Opening/closing the monitor should never be performed manually. It may cause a malfunction.
 - The monitor's angle is set to 90 degrees at the factory. Depending on the car, the monitor may hit the dashboard when opened. The monitor's angle can be adjusted and stored in memory so that the monitor will not hit the dashboard when opening. For adjusting the monitor, refer to "Adjusting the Monitor Angle" (page 39). Even when the vehicle's battery power is removed, the adjusted monitor angle remains stored in memory.
 - The IVA-D51 1RB/IVA-D51 1R is a precision device. With gentle handling, its unique capabilities can be enjoyed for a long time.
 - If the monitor touches anything while it is being opened (or closed), the monitor will stop opening (or closing) immediately. Should this occur, remove the obstacle and press **OPEN/CLOSE** again.
 - When the movable monitor is opened, do not place any object on the monitor and be careful not to bump or apply any pressure to the monitor while it is open. This can cause damage to the mechanism.
 - In low ambient temperature conditions, the display may be dark for a short period of time immediately after the power is turned on. Once the LCD has warmed up, the display returns to normal.
 - For your safety, some operation of the unit cannot be performed while the vehicle is in motion. In this case, first stop the vehicle and engage the parking brake, then perform the operation.

Moving the Monitor to be Flat

When you want to operate some function on the car (air conditioner, etc.) which is hidden by the raised monitor, use this function.

1 When the monitor is open, press FLAT.
The monitor moves to the flat position.

2 Press FLAT again.
The monitor returns to the previous angle.

- The monitor returns to the previous angle 10 seconds after being moved to the flat position.
- If an excessive force is added to the monitor when the monitor is flat, putting an object on the back of the monitor for example, it may cause a malfunction.

Adjusting the Volume

Adjust the volume by turning the **Rotary encoder**.

Volume: 0 - 35

Lowering Volume Quickly

Activating this function will instantly lower the volume level by 20 dB.

Press and hold Rotary encoder (MUTE) for at least 2 seconds.

The audio level decreases by about 20 dB.

Press and hold Rotary encoder (MUTE) for at least 2 seconds again brings the audio back to its previous level.

How to view the Display

TOUCH PANEL operation

- To protect the display, touch the onscreen button with the tip of your finger.
- If you touch a button and there is no reaction, remove your finger from the display once, and try again.
- If you touch two buttons at the same time, a malfunction may occur.

Onscreen buttons are expressed as follows in this Owner's Manual.

- Onscreen buttons are shown in bold, enclosed in [] (e.g. [BAND]).

Recalling the Source

Here is an example explanation for the Radio mode display on how to recall a source.

1 Press SOURCE/⏻.
The SOURCE selection screen is displayed.

Display example for SOURCE selection screen



- ① Changes the item of source selection list. (Depending on the source quantity, this button may not be displayed.)
 - ② Displays the source modes that can be selected.
 - ③ Changes to Navigation screen. (Available only when ON is set in "Setting the Navigation Mode" (page 45).)
 - ④ Changes to SETUP main screen.
 - ⑤ Changes to Navigation main screen. (When "ON" is set in "Setting the Navigation Mode" (page 45) or "NAV." is set in "Adjusting the AUX1 name Mode" (page 45).)
 - ⑥ Changes to the Telephone Menu screen. (When "BLUETOOTH IN" is set to Adapter (page 46)).)
 - ⑦ Displays the rear view video. (When an optional rearview camera is connected and Camera IN is set to other than OFF (page 44).)
 - ⑧ Turns off the Source Select screen, and returns to previous source screen.
 - ⑨ Changes to the Rear selection screen when "Setting the Picture/Sound Output" (page 46) is set to ON.
 - ⑩ Returns to the previous screen.
- The kind of source modes that are displayed varies depending on connection and setting

2 Touch [Radio].
The screen changes to the Radio mode main display.

Display example for FM Radio main screen

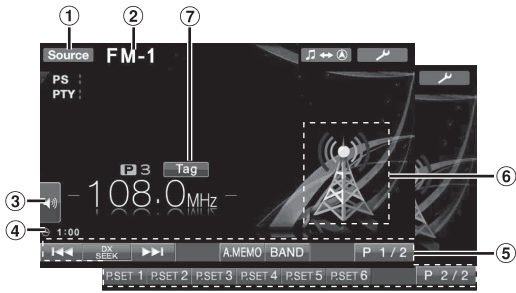

- ① Changes to the SOURCE selection screen (to step 1 screen).
- ② Displays the source name, such as radio band, etc., that is selected.
- ③ Changes to MultEQ^{*1}, MX level^{*2}, Audio Preset Memory recall^{*3} select screen directly.
- ④ Displays the time.
- ⑤ Function Guide:
The function guide display varies depending on each source.
The contents of the function guide change by touching [P1/2]^{*4}, [P1/3]^{*4} or [P1/4]^{*4} on the function guide, and many other operations can be performed.
- ⑥ Displays the image of current source.

^{*1} Adjustable only when an optional IMPRINT audio processor is connected, Curve1, Curve2 is stored.
^{*2} Adjustable only when Defeat is OFF, Media Xpander is ON. There is no MX mode for FM, MW and LW radio. If an optional IMPRINT audio processor is connected, you should set MultiEQ to OFF (page 47).
^{*3} Adjustable only when Defeat is OFF.
^{*4} Display may vary depending on the connected devices.

- When an optional DVD player or DVD changer is connected via Ai-NET, AUX appears as "EXT. DVD" or "DVD CHG." on the display.
- When both the optional DVD player and DVD changer are connected via Ai-NET, AUX appears as "EXT. DVD" and DVD changer as "DVD CHG." in the display.

3 Touch [Source] on the main source screen to change to another source screen, and select the desired source from the SOURCE selection screen.

- The screen can be changed to the VISUAL selection screen by pressing VISUAL.
- The screen can be changed to the SETUP selection screen by touching [].

Displaying the Numeric Keypad Input Screen

The numeric keypad input screen is displayed when the DVD or Video CD mode is selected for searching a title or chapter, and also for entering a country code or password for the DVD setup item.

- 1 Touch [10KEY] on the main source screen.
- 2 Touch the desired numeric key.

Display example for numeric keypad

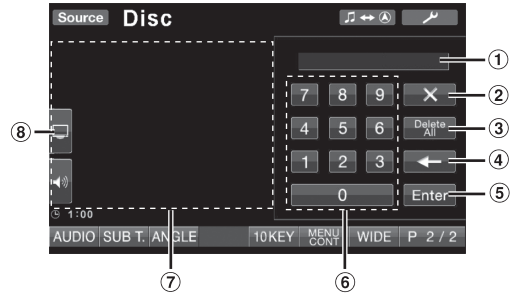

- ① Input screen area.
- ② Closes numeric keypad input screen.
- ③ All input numbers will be deleted.
- ④ Previous number will be deleted.
- ⑤ Input number is confirmed.
- ⑥ Numeric keypad.
- ⑦ The numeric keypad input screen closes if the area is touched while displayed.
- ⑧ Changes to Image Brilliance adjustment screen directly. (Adjustable only when the vehicle is in parking mode.)

3 Touch [Enter] to confirm your entry.

Radio

Display example for FM Radio main screen

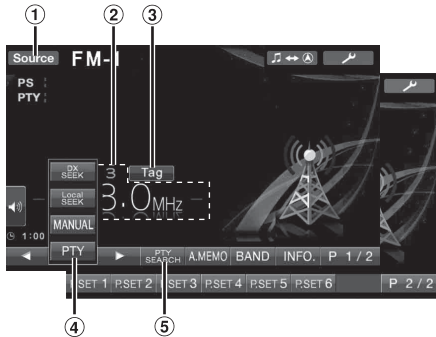

- ① [Source] button: Refer to page 13
- ② Displays the preset number/frequency
- ③ Touch to tag the song information, etc. For details, refer to "Using iTunes Tagging" on page 17.
- ④ [DX SEEK]*¹ button: Displays the tuning mode selection list.
- ⑤ [PTY SEARCH]*² button: Search for a station by PTY (Programme Type) Tuning, refer to "PTY (Programme Type) Tuning" (page 16).

*¹The button displays the current tuning mode.

*²The button displays only when the tuning mode of PTY is selected.

Listening to the Radio

- 1 Touch [Source] on the main source screen.
The SOURCE selection screen is displayed.
- 2 Touch [Radio].
The radio mode is activated and the display changes to the Radio Mode screen.
- 3 Touch [BAND] to select the desired radio band.
Each press changes the bands as follows:
FM-1 → FM-2 → FM-3 → MW → LW → FM-1
- 4 Touch [DX SEEK] to choose the tuning mode.
DX SEEK Local SEEK MANUAL PTY

- There are two modes you can select for auto tuning, DX and Local:
 - DX (Distance) mode;
Both strong and weak stations will be tuned in.
 - Local mode;
Only strong stations will be tuned in.
The initial setting is DX.
- 5 Touch [◀◀], [▶▶] or [◀], [▶] to change the radio frequency up or down respectively.
When touched and held in the manual mode, the frequency changes continuously.

Presetting Stations Manually

- 1 Tune in a desired radio station you wish to store in the preset memory by manual or automatic seek tuning.
- 2 Touch [P1/2] to change the function guide.
- 3 Touch and hold any one of the preset buttons [P.SET 1] through [P.SET 6] for at least 2 seconds.
The selected station is stored.
- 4 Repeat the procedure to store up to 5 other stations onto the same band.
To use this procedure for other bands, simply select the band desired and repeat the procedure.

A total of 30 stations can be stored in the preset memory (6 stations for each band; FM1, FM2, FM3, MW and LW).

- If a preset memory has already been set in the same preset number, it will be cleared and the new station will be memorized.

Presetting Stations Automatically

The tuner can automatically seek and store 6 strong stations in the selected band in order of signal strength.

After selecting the desired band, touch and hold [A.MEMO] for at least 2 seconds.

The tuner automatically seeks and stores 6 strong stations into [P.SET 1] to [P.SET 6] in order of signal strength.
When the automatic storing has been completed, the tuner goes to the station stored in [P.SET 1].

- If no stations are stored, the tuner will return to the original station you were listening to before the automatic storing procedure began.

Tuning to Preset Stations

You can tune in the preset stations in memory on each band using the preset number.

- 1 After selecting the desired band, touch [P1/2] to change the function guide.
- 2 Touch any one of the preset buttons [P.SET 1] through [P.SET 6] that has a station stored to it.
The preset station is received.

RDS Operation

Turning AF (Alternative Frequencies) On or Off

The RDS (Radio Data System) is a radio information system using the 57 kHz subcarrier of regular FM broadcast. The RDS allows you to receive a variety of information such as traffic information, station names, and to automatically re-tune to a stronger transmitter that is broadcasting the same programme.

1 Touch [] on the main source screen.

The SETUP selection screen is displayed.

2 Touch the title bar of Source Setup.

The source setup screen appears.

3 Touch the title bar of RDS Setup.

The display changes to the RDS mode screen.

4 Touch [AF] to select the AF (Alternative Frequency) ON or OFF mode.

- RDS SETUP mode will not be displayed when the band of radio is set to MW or LW.
- When the AF ON mode is selected, the unit automatically tunes to a strong signal station in the AF list.
- Use the AF OFF mode when automatic re-tuning is not required.

5 Touch [] to return to the previous screen.

- Touching [Exit] will turn off the Setup screen, and return to previous main screen.

Tips

- If the unit receives the PTY31 (Emergency Broadcast) signal, the unit will show "Alarm" in the display only when PTY31 is set to on. For operation, refer to "Setting PTY31 (Emergency Broadcast) Reception" (page 39).
- The RDS digital data includes the following:

PI	Programme Identification
PS	Programme Service Name
AF	List of Alternative Frequencies
TP	Traffic Programme
TA	Traffic Announcement
PTY	Programme Type
EON	Enhanced Other Networks
- Refer to page 39 about "PI Seek Setting", "Receiving RDS Regional (Local) Stations", "Switching the Display Language of PTY (Programme Type)" and "Setting PTY31 (Emergency Broadcast) Reception".

Receiving Traffic Information

Press and hold **BAND/TA** for at least 2 seconds to turn on the Traffic Information mode.

When the traffic information station is tuned in, the TA indicator lights up.

Traffic information is heard only when it is being broadcast. If traffic information is not being broadcast, the unit is set in the standby mode.

When a traffic information broadcast begins, the unit automatically receives it and the display shows "T. Info".

When traffic information broadcast is over, the unit will automatically set in the standby mode.

- If the traffic information broadcast signal falls below a certain level, the unit remains in the receiving mode for 1 minute. If the signal remains below a certain level for over 70 seconds, "TA" blinks in the display.
- If you do not want to listen to the traffic information being received, lightly press **BAND/TA** to skip that traffic information message. The T. INFO mode will remain in the ON position to receive the next traffic information message.
- If the volume level is changed while receiving traffic information, the changed volume level will be memorized. When traffic information is received next time, the volume level will be automatically adjusted to the level memorized.

PTY (Programme Type) Tuning

RDS SETUP mode

1 Touch [PTY] on the screen.

FM Radio mode

1 Touch [DX SEEK]* to choose the PTY tuning mode.

The PTY mode is activated.

The Programme Type of the station being currently received will be displayed.

2 Touch [◀] or [▶] after activating the PTY mode to choose the desired programme type while "PTY" (programme type) is displayed.

Each press scrolls the programme type by one.

RDS SETUP mode

3 Touch [PTY] after selecting the programme type to start searching for a station of the selected programme type.

FM Radio mode

3 Touch [PTY SEARCH] after selecting the programme type to start searching for a station of the selected programme type.

If no station is found, "No PTY" will be displayed.

* The button displays the current tuning mode.

Receiving Traffic Information While Playing CD or Radio

The example explained here is how to receive the traffic information broadcast during CD playback.

1 In the CD mode, press and hold **BAND/TA** for at least 2 seconds to turn on the Traffic information mode.

The unit automatically starts to search the receivable traffic broadcasts.

When the traffic information broadcast is searched out, the CD mode is switched to the Radio mode and the unit receives the traffic information broadcast.

- When the traffic information broadcast starts, the unit automatically mutes the CD.
- When the traffic information broadcast finishes, the unit automatically returns to the original source you were playing before the traffic information broadcast began.
- *The receiver is equipped with the EON (Enhanced Other Networks) function so if the station being received does not broadcast the traffic information, the receiver automatically tunes in the related station that broadcasts the traffic information.*

2 When the traffic information broadcast has finished, the unit returns to the CD mode.

Priority News

This function allows you to preset to give priority to the News programme. You will never miss the News programme as the unit automatically gives priority to the News programme whenever it begins broadcasting, and interrupts the programme you are currently listening. This feature is functional when your unit is set to a mode other than the LW and MW modes.

1 Touch **[NEWS]** to activate the PRIORITY NEWS mode.

The "NEWS" indicator appears in the display. Touch **[NEWS]** again to deactivate the Priority News mode and return to the programme you were previously listening.

2 Touch **[↶]** to return to the previous screen.

Using iTunes Tagging

iTunes Tagging lets you tag songs you hear on RDS stations with your new IVA-D511RB/IVA-D511R and then preview, buy, and download them later from your iTunes Tagged playlist the next time you sync your iPod.

- For details on the iPod/iPhone models usable with this unit, refer to "Connecting an iPod/iPhone" on page 70.
- iPod with video does not support the tagging function.

1 Tune in the desired RDS station.

If there is tag information, "Tag" indicator appears in the screen.

2 Touch **[Tag]** while desired song is broadcasting.

The "Tag" blinks at the same time the unit beeps for 2 times and "Tagging ..." is displayed.

3 When completed, "Tag stored" is displayed and the "Tag" indicator lights up at the same time the unit beeps for 2 times*.

* When completed, "Tag Count X" (X is the total amount of stored tag information) is displayed if no iPod/iPhone is connected.

- During tagging, the iPod/iPhone takes priority to save the tag information. If no iPod/iPhone is connected, the tag information is saved to this unit.
- When the memory of iPod/iPhone is full, "iPod Memory Full, Tag Count X" is displayed and the unit beeps 2 times. The tag information will be stored to the unit.
- During tagging, changing the source or RDS station or traffic information, etc., is received, the tagging will be cancelled and "Cannot Tag" will be displayed.
- This unit can store up to 50 pieces of tag information. When the memory of the unit is full, "Tuner Memory Full. Connect iPod" may be displayed and the unit beeps 2 times.
- When an iPod that doesn't support the tagging function is connected, "Non-Tagging iPod" may be displayed.
- When the iPod/iPhone is disconnected from the unit during tagging, its tag information will be stored in the unit.
- If there is stored tag information on the unit, when an iPod/iPhone supporting the tag function is connected, the stored tag information will be transferred to the iPod/iPhone automatically. When the storage volume of the connected iPod/iPhone is insufficient, "iPod Memory Full" will be displayed, and any tag information on the unit will not be transferred to the iPod/iPhone.
- If tag information already exists, "Already Tagged" will be displayed when you try to tag information again.
- Tagging may be cancelled by changing the frequency or station, and the message "Cannot Tag", etc., may not be displayed.

Displaying Radio Text

Text messages from a radio station can be displayed.

1 Tune in a radio station that transmits text messages.

2 Touch **[INFO.]** in the FM radio mode to activate the Radio Text mode.

The display shows "WAIT" for a few seconds.

3 To change the Radio Text display, touch **[INFO.]**.

- If there is no receivable text message or the unit cannot receive a text message properly, the display shows "NO TEXT".

CD/MP3/WMA/AAC

Display example for MP3/WMA/AAC main screen

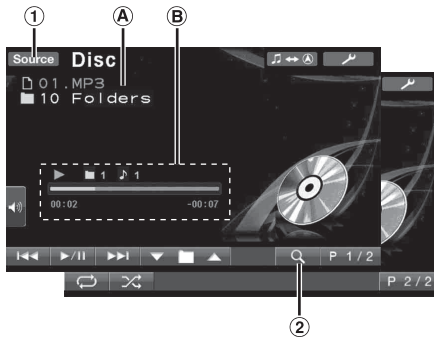

① [Source] button: Refer to page 13

② [Q] button: Refer to page 31

Ⓐ CD:

Displays the Track text^{*1}/Disc text^{*1}.

- If there is neither Track nor Disc name information, "NO TEXT" will be displayed.

MP3/WMA/AAC:

After displaying the file name in the upper line, the track name is displayed if there is ID3 tag information. After displaying the folder name in the lower line, the album name/artist name are displayed if there is ID3 tag information.

Ⓑ CD:

Displays play state/the disc number^{*2}/track number/progress bar/elapsed time/remain time.

MP3/WMA/AAC:

Displays play state/the disc number^{*3}/folder number/track number/progress bar/elapsed playback time/remain time.

^{*1} Displayed when a CD text disc is inserted.

^{*2} Displayed when a CD changer is connected.

^{*3} Displayed when an MP3 compatible CD changer is connected.

- When the CD/MP3 changer source is selected, progress bar, etc. will not be displayed.

Playback

1 Touch [Source] on the main source screen.

The SOURCE selection screen is displayed.

2 Touch [Disc].

The display shows the Disc screen.

When a CD/MP3/WMA/AAC is inserted into the DISC SLOT of the IVA-D511RB/IVA-D511R, with the label side facing up, the unit starts to play the CD/MP3/WMA/AAC.

3 Touch [◀◀] or [▶▶] to select the desired track (file).

Returning to the beginning of the current track (file) :

Touch [◀◀].

Fast reverse :

Touch and hold [◀◀◀].

Advancing to the beginning of the next track (file) :

Touch [▶▶].

Fast forward :

Touch and hold [▶▶▶].

To pause playback

Touch [▶/||].

Touching [▶/||] again will resume playback.

To eject the disc

Press ▲.

- If the disc does not eject, press and hold ▲ for at least 3 seconds.
- The IVA-D511RB/IVA-D511R models include a built-in MP3/WMA/AAC unit. You can play CD-ROMs, CD-Rs, and CD-RWs containing MP3/WMA/AAC files on this unit. Use the format compliant with this unit.

For further information about playing or storing MP3/WMA/AAC files, refer to pages 19 and 20 before using the unit.

- WMA format files that are protected by DRM (Digital Rights Management), AAC format files that have been purchased from iTunes Store and files that are copy-protected (copyright protection) cannot be played back on this unit.
- The unit can play discs containing both audio data and MP3/WMA/AAC data.
- The track display for CD audio data playback is the track numbers recorded on the disc.
- Three-inch (8cm) CD's can be used.
- "Playing MP3/WMA/AAC Data (File Play Mode)" is mentioned on page 38.
- If an MP3/WMA/AAC disc with many files and folders is played, it takes a little longer than normal to start playback.
- Touch [Q] to activate the search mode. For operations, refer to "Search Function" on page 31. However, the search mode function does not work in the CD changer mode.
- The playback time may not be correctly displayed when a VBR (Variable Bit Rate) recorded file is played back.
- If the disc is left in the unit after pressing ▲, the disc is automatically pulled back into the unit and paused. In this case, start playback by touching [▶/||] or eject again and remove the disc within 15 seconds.

Repeat Play

Touch [↺] to play back repeatedly the track currently being played.

The track (file) will be played repeatedly.

Touch [↺] again and select OFF to deactivate Repeat play.

CD: → ^{*1} → (off) →

(Repeat one) (Repeat disc)

MP3/WMA/AAC:

- 1 Touch [P1/2]^{*3} to change the function guide.
- 2 Touch [↺] and select the desired Repeat play.

→ ^{*2} → ^{*1} → (off) →

(Repeat one) (Repeat folder) (Repeat disc)

^{*1} If a CD Changer or an MP3 compatible CD changer is connected and the RPT DISC mode is selected, the unit repeatedly plays back all tracks (files) on the disc selected.

^{*2} Only files in a folder are repeatedly played back.

^{*3} Display may vary depending on the connected devices.

M.I.X. (Random Play)

Touch [⏮] during playback.

The tracks (files) on the disc will be played back in a random sequence.

To cancel M.I.X. play, touch [⏮].

CD: ⏮ → ⏮ ALL*¹ → (off) → ⏮

MP3/WMA/AAC:

- 1 Touch [P1/2]*⁴ to change the function guide.
- 2 Touch [⏮] and select the desired M.I.X. play.

⏮ ■*³ → ⏮*² → (off) → ⏮ ■*³

*¹ If a CD Changer equipped with the M.I.X. ALL function is connected, M.I.X. ALL will also be selectable.

In this mode, the tracks on all the CDs in the current magazine will be included in the random playback sequence.

*² If an MP3 compatible CD changer is connected, all files in a disc are played back in random sequence, and playback shifts to the next disc.

*³ Only files in a folder are played back in random sequence in the M.I.X. Folder mode.

*⁴ Display may vary depending on the connected devices.

- If the search mode (page 31) is activated, the M.I.X. Play mode will be cancelled.

Selecting Folders (concerning MP3/WMA/AAC)

Touch ■ [▼] or [▲] to select the folder.

About MP3/WMA/AAC

CAUTION

Except for private use, duplicating audio data (including MP3/WMA/AAC data) or distributing, transferring, or copying it, whether for free or for a fee, without permission of the copyright holder is strictly prohibited by the Copyright Act and by international treaty.

What is MP3?

MP3, whose official name is "MPEG-1, 2, 2.5 Audio Layer 3," is a compression standard prescribed by the ISO, the International Standardization Organization and MPEG which is a joint activity institution of the IEC.

MP3 files contain compressed audio data. MP3 encoding is capable of compressing audio data at extremely high ratios, reducing the size of music files to as much as one-tenth their original size. This is achieved while still maintaining near CD quality. The MP3 format realizes such high compression ratios by eliminating the sounds that are either inaudible to the human ear or masked by other sounds.

What is WMA?

WMA, or "Windows Media™ Audio," is compressed audio data. WMA is similar to MP3 audio data and can achieve CD quality sound with small file sizes.

What is AAC?

AAC is the abbreviation for "Advanced Audio Coding," and is a basic format of audio compression used by MPEG2 or MPEG4.

Method for creating MP3/WMA/AAC files

Audio data is compressed using software with MP3/WMA/AAC codecs. For details on creating MP3/WMA/AAC files, refer to the user's manual for that software.

MP3/WMA/AAC files that can be played back by this device have the following file extensions:

MP3: "mp3"

WMA: "wma" (ver. 7.1, 8, 9, 9.1 and 9.2 are supported)

AAC: "m4a"

WMA is not supported for the following files, Windows Media Audio Professional, Windows Media Audio 9 Voice or Windows Media Audio 9 Pro Lossless.

There are many different versions of the AAC format. Confirm that the software being used conforms to the acceptable formats listed above. It's possible that the format may be unplayable even though the extension is valid. Playback of AAC files encoded by iTunes is supported.

Supported playback sampling rates and bit rates

MP3

Sampling rates: 48 kHz, 44.1 kHz, 32 kHz, 24 kHz, 22.05 kHz, 16 kHz, 12 kHz, 11.025 kHz, 8 kHz

Bit rates: 32 - 320 kbps

WMA

Sampling rates: 48 kHz, 44.1 kHz, 32 kHz

Bit rates: 48 - 192 kbps

AAC

Sampling rates: 48 kHz, 44.1 kHz, 32 kHz, 24 kHz, 22.05 kHz, 16 kHz, 12 kHz, 11.025 kHz, 8 kHz

Bit rates: 16 - 320 kbps

This device may not play back correctly depending on sampling rates.

ID3 tags/WMA tags

This device supports ID3 tag v1 and v2, and WMA tag.

If tag data is in an MP3/WMA/AAC file, this device can display the title (track title), artist name, and album name ID3 tag/WMA tag data (maximum 128 characters).

This device can only display single-byte alphanumeric characters and the underscore. For non-supported characters, "No Support" is displayed.

The number of characters may be limited, or not correctly displayed, depending on the tag information.

Producing MP3/WMA/AAC discs

MP3/WMA/AAC files are prepared, then written to a CD-R or CD-RW (DVD-R/DVD-RW) using CD-R writing software. A disc can hold up to 4,096 files/256 folders (including Root Folders), and the maximum number of folders is 255. Playback may not be performed if a disc exceeds the limitations described above.

Media supported

The media that this device can play back are CD-ROMs, CD-Rs, CD-RWs, DVD-Rs and DVD-RWs.

Corresponding File Systems

This device supports discs formatted with ISO9660 Level 1 or Level 2.

Under the ISO9660 standard, there are some restrictions to remember.

The maximum nested folder depth is 8 (including the root directory). The number of characters for a folder/file name is limited.

Valid characters for folder/file names are letters A-Z (all caps), numbers 0-9, and '_' (underscore).

This device also can play back discs in Joliet, etc., and other standards that conform to ISO9660. However, sometimes the file names, folder names, etc., are not displayed correctly.

Formats supported

This device supports CD-ROM XA, Mixed Mode CD, Enhanced CD (CD-Extra) and Multi-Session.

This device cannot correctly play back discs recorded with Track At Once or packet writing.

Order of files

Files are played back in the order that the writing software writes them to the disc. Therefore, the playback order may not be what's expected. Verify the writing order in the software's documentation. The playback order of the folders and files is as follows. (The following numbers may differ from actually displayed numbers.)

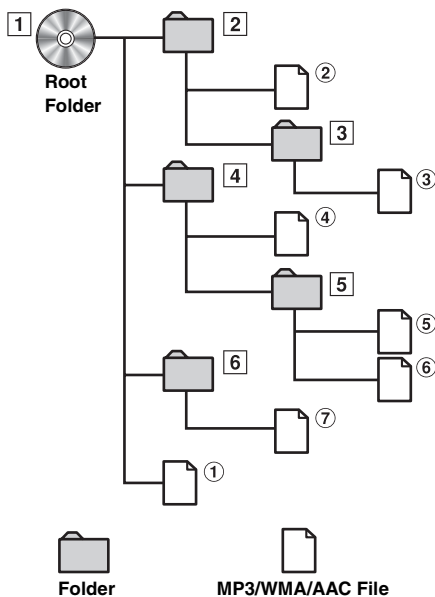

Terminology

Bit rate

This is the "sound" compression rate specified for encoding. The higher the bit rate, the higher the sound quality, but also the larger the files.

Sampling rate

This value shows how many times per second the data is sampled (recorded). For example, music CDs use a sampling rate of 44.1 kHz, so the sound is sampled (recorded) 44,100 times per second. The higher the sampling rate, the higher the sound quality, but also the larger the volume of data.

Encoding

Converting music CDs, WAVE (AIFF) files, and other sound files into the specified audio compression format.

Tag

Song information such as track titles, artist names, album names, etc., written into MP3/WMA/AAC files.

Root folder

The root folder (or root directory) is found at the top of the file system. The root folder contains all folders and files. It is created automatically for all burned discs.

DVD/Video CD

Display example for DVD Video main screen

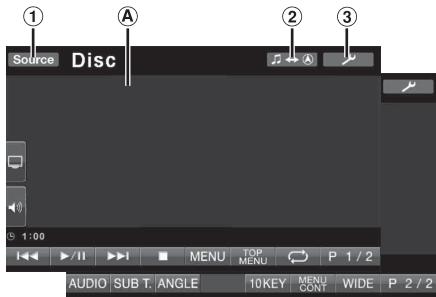

- ① [Source] button: Refer to page 13.
 - ② [Music/Navigation] button: Changes to Navigation screen.
 - ③ [Setup] button: Displays the SETUP selection screen.
 - Ⓐ Displays the disc (DVD VIDEO, DVD AUDIO, PROGRAM/PLAYLIST (DVD-VR), VIDEO CD) being played back.
Displays tag information for DivX®.
- If [Search] on the DivX® mode screen is touched, the search list screen is displayed. Refer to "Search Function" (page 31).
 - Some operations cannot be carried out depending on the disc or playback screen.
 - Displays of the function guide [PI/2], etc., may vary depending on the connected device(s).

Disc types that can be used for each heading are represented by the following marks.

- DVD-V** DVD Commercial Video discs (used for the distribution of movies, etc.) or a DVD-R/DVD-RW, DVD+R/DVD+RW recorded in a video mode can be used.
(including discs containing both DVD video and DVD audio data that are played back when "Video" is set in "Setting the DVD-Audio Playback Mode" (page 37)).
- DVD-A** DVD Commercial Audio discs can be used.
- DVD-VR** DVD-R/DVD-RW discs recorded in DVD-VR mode can be used.
- V CD** Video-CD discs can be used.
- DivX** CD-R/CD-RW/DVD-R/DVD-RW/DVD+R/DVD+RW discs that are recorded in the DivX® mode can be used.

Playing a Disc

DVD-V DVD-A DVD-VR V CD DivX

IVA-D511RB/IVA-D511R has a built-in DVD player. When an optional Alpine DVD/Video CD/CD player (or DVD changer) is connected to the IVA-D511RB/IVA-D511R, you can control it from the IVA-D511RB/IVA-D511R. (except some operations)

⚠ WARNING

It is dangerous for the driver to watch the TV/DVD/Video while driving the vehicle. The driver may be distracted from looking ahead and an accident could occur.

Install the IVA-D511RB/IVA-D511R correctly so that the driver cannot watch TV/DVD/Video unless the vehicle is stopped and the emergency brake is applied.

If the IVA-D511RB/IVA-D511R is not installed correctly, the driver will be able to watch the TV/DVD/Video while driving the vehicle and may be distracted from looking ahead causing an accident. The driver or other people could be severely injured.

To display the DVD mode screen

DVD-V DVD-A DVD-VR V CD DivX

- If you try to activate the auxiliary device while driving, the display will show the warning-Picture off for your safety.

⚠ Caution

- **Not all functions will operate for every DVD. See the individual DVD's instructions for details on the features supported.**
- **Fingerprints on a disc may adversely affect playback. If a problem occurs, remove the disc and check for fingerprints on the playback side. Clean the disc if necessary.**
- **If you switch the power or Ignition Key OFF or change sources during playback, playback will continue where you left off when you resume playback.**
- **If you try to perform an invalid operation (based on the type of disc being played), the following mark is displayed on the monitor screen: ⊘**

- **Play Position Memory Function**
Even if you turn power off or switch the Ignition Key to OFF during playback or change the source, playback will continue from the point where playback stopped when the power is turned ON again.

1 Touch [Source] on the main source screen.

The SOURCE selection screen is displayed.

2 Touch [Disc].

The display shows the DISC mode screen.
Insert a disc with the label side facing up. The unit starts to play the disc.

When an optional Alpine DVD player is connected:
Insert a disc into the DVD/Video CD/CD player, the player starts playing.

- The operation screen changes to the visual screen in the DVD or Video CD mode for 5 seconds after an operation has been performed. Touch the display panel to display the operation screen again.
- The display mode can be changed by touching [WIDE]. For operation, see "Switching Display Modes" on page 32.

To eject the disc

Press ▲.

- The reverse side of a double-sided DVD will not be played automatically.
Remove the disc, turn it over, and reinsert it.
- If the disc does not eject, press and hold ▲ for at least 3 seconds.
- Do not insert discs containing maps for the navigation system. Doing so could result in damage.
- Refer also to "DVD Setup" (pages 33 to 38).
- Be sure the remote input lead is connected to the remote output lead of this unit when a DVD changer or DVD player is connected. If not correctly connected, touch operation cannot be performed.
- To return to the previous screen during Video CD playback, touch [↶] after touching [PI/2] of the function guide. However, the function may vary depending on the disc.
- If the disc is left in the unit after pressing ▲, the disc is automatically pulled back into the unit and stopped. In this case, start playback by touching [▶/||] or eject again and remove the disc within 15 seconds.
- "Can't Downmix" is displayed when a Downmix (multi-channel signals are mixed into 2ch) prohibited section of a DVD-Audio disc is played. In this case, only the Lch/Rch recorded on the disc is output as sound. (The sound of Centre speaker, L-surround speaker, R-surround speaker, and Subwoofer is not output.)
- While "Index reading" is displayed by DivX®, the fast-forwarding/fast-reversing and repeat functions, etc. cannot be used.

If a menu screen appears

On DVDs and Video CDs with playback control (PBC), menu screens may appear automatically. If this happens, perform the operation described below to start playback.

- To play back a DVD-Audio disc, set "VCAP" in "Setting the DVD-Audio Playback Mode" (page 37).

Direct Menu Operations DVD-V DVD-A

1 Touch the DVD menu directly.

- Some operations cannot be performed depending on the disc.

Menu Operations DVD-V DVD-A

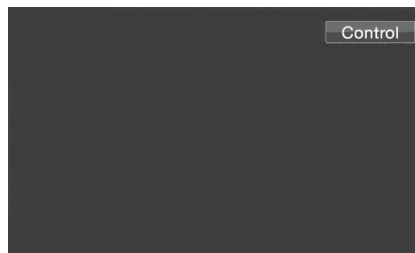

1 Touch [Control] to display the operation keys.



2 Touch [Key].
The menu operation mode will be displayed.

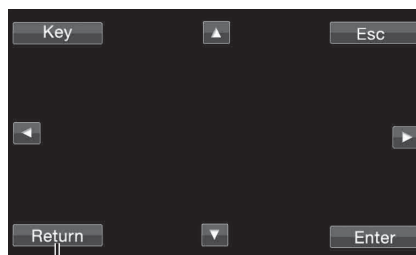

Touch [Return] to return to the previous display.
(Operation may not be possible, depending on the disc.)

- 3 Select a desired menu item by touching [▲], [▼], [◀] or [▶].
- 4 Touch [Enter] to confirm the selected item.

Numeric Keypad Input Operations DVD-V DVD-A

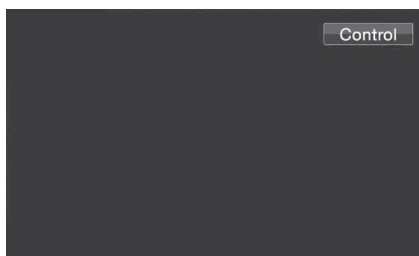

- 1 Touch **[Control]** to display the operation keys.



- 2 Touch **[Key]**.
The menu operation mode appears.
- 3 Touch **[Key]** again.
The numeric keypad input mode screen appears.

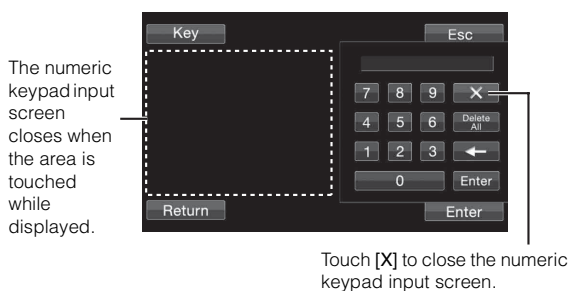

- 4 Touch a desired number.
- 5 Touch **[Enter]** on the numeric keypad mode screen to confirm your selection.

Numeric Keypad Input Operations VCD

When PBC is turned OFF, the menu screen is not displayed. Turn it ON to display the screen (See "Setting the Video CD Play Mode" on page 38).

- 1 Touch **[P1/2]** in the Video CD mode to change to the function guide.
- 2 Touch **[10KEY]**.
The numeric keypad is displayed.
- 3 Touch and input a desired number.
- 4 Touch **[Enter]** to confirm.

Displaying the Top Menu Screen

DVD-V DVD-A

When a DVD contains two or more titles, the top menu screen appears.

Touch [TOP MENU] on the DVD mode main screen.

The top menu screen appears.

- To perform necessary operations, see "If a menu screen appears" on page 22.
- To play back a DVD-Audio disc, set "VCAP" in "Setting the DVD-Audio Playback Mode" (page 37).

Displaying the Menu Screen DVD-V

With a DVD having two or more menus, a menu screen will appear for the programs available, in addition to the main programs.

Touch [MENU] on the DVD mode main screen.

The menu screen appears.

- To perform necessary operations, see "If a menu screen appears" on page 22.

Displaying the Menu Operation Mode Screen DVD-V DVD-A

- 1 Touch **[P1/2]*** on the DVD mode main screen.

The function guide changes.

* The display differs, depending on the disc (mode).

- 2 Touch **[MENU CONT]**.

The menu operation mode screen appears.

- For further operation, see "If a menu screen appears" on page 22.
- To play back a DVD-Audio disc, set "VCAP" in "Setting the DVD-Audio Playback Mode" (page 37).

Searching by Programme DVD-VR

- 1 Touch **[TOP MENU]** on the DVD mode main screen while playing a DVD-VR disc.

The programme search list screen is displayed.

- 2 Touch the title bar of the programme you want to play.

The selected programme is played back, and then returns to the DVD mode main screen.

Searching by Playlist DVD-VR

- 1 Touch **[MENU]** on the DVD mode main screen while playing DVD-VR disc.

The playlist search list screen is displayed.

- 2 Touch the title bar of the playlist you want to play.

The selected playlist is played back, and then returns to the DVD mode main screen.

- Only discs containing a Playlist can be operated.

Stopping Playback (Pre Stop)

DVD-V DVD-A DVD-VR V CD DivX

Press the stop button during playback to stop playback. That position is stored in the memory.

1 Touch [■] once during playback.

"Pre Stop" is displayed.

2 Touch [▶/||] in the Pre Stop mode.

Playback starts from the position at which it was stopped.

- For some discs, the position at which playback was stopped may not be accurate.
- To play back a DVD-Audio disc, set "VCAP" in "Setting the DVD-Audio Playback Mode" (page 37).

Stopping Playback

DVD-V DVD-A DVD-VR V CD DivX

Touch [■] twice or touch and hold [■] for at least 2 seconds during playback.

"Stop" is displayed, and playback stops.

- Playback starts from the beginning when [▶/||] is touched while playback is stopped.

Fast-forwarding/Fast-reversing

DVD-V DVD-A DVD-VR V CD DivX

DVD-Video, DVD-VR, Video-CD, DVD-Audio (VCAP mode)*, DivX®:

1 During playback, touch and hold [◀◀] (Fast-reverse) or [▶▶] (fast-forward).

When touched and held for more than 1 second, the disc is forwarded/reversed at double speed. When held for 5 more seconds or longer, the disc is forwarded/reversed at 8 times the normal speed. When held for 10 seconds or longer, the disc is forwarded/reversed at 21 times the normal speed.

DVD-Audio (VOFF mode)*:

1 During playback, touch and hold [◀◀] (Fast-reverse) or [▶▶] (fast-forward).

2 Stop touching [◀◀] or [▶▶] to return to normal playback.

* When "VCAP" or "VOFF" is set in "Setting the DVD-Audio Playback Mode" (page 37).

- No sound is played during fast-forwarding/fast-reversing.
- For DVDs and Video CDs with playback control (PBC), the menu screen may reappear during fast-forwarding/fast-reversing.
- Operation may not be possible, depending on the disc.

Finding the Beginnings of Chapters/Tracks/Files

DVD-V DVD-A DVD-VR V CD DivX

During playback, touch [◀◀] or [▶▶].

The chapter/track/file switches each time the button is touched, and playback of the selected chapter/track/file starts.

▶▶: Touch this to start playback from the beginning of the following chapter, track or file.

◀◀: Touch this to start playback from the beginning of the current chapter, track or file.

- Some DVDs do not have chapters.
- Be sure to turn PBC off before starting the search (see "Setting the Video CD Play Mode" on page 38).

Supplementary explanation

"Chapters" are divisions of movies or musical selections on DVDs.

"Tracks" are divisions of movies or musical selections on Video CD, DVD Audio and music CDs.

"Groups" associate a track (one song) with other tracks stored on a DVD-Audio. Group playback differs depending on the disc.

"Playlists" specify a range of images and their playback order.

- Only discs containing a Playlist can be used.

Playing Still Frames (Pausing)

DVD-V DVD-A DVD-VR V CD DivX

1 During playback, touch [▶/||].

2 Touch [▶/||] to resume playback.

- No sound is played during the still frame mode.
- The image or sound may stop temporarily when playback starts from the pause mode. This is not a malfunction.

Forward/reverse frame-by-frame Playback

DVD-V DVD-VR V CD

1 In the pause mode, touch [◀◀] or [▶▶].

The picture advances or reverses by one frame each time the button is touched.

2 Touch [▶/||] to return to normal mode.

- No sound is output during forward/reverse frame-by-frame playback.
- Reverse frame-by-frame cannot be carried out on the DVD-VR and Video CD.

Slow Motion Playback

DVD-V DVD-VR V CD

1 When [**◀◀**] or [**▶▶**] is touched and held while in the pause mode, the 1/8th speed slow motion playback mode is set.

When held in for 5 more seconds, the slow motion speed switches to 1/2 the normal speed.

2 Stop touching [**◀◀**] or [**▶▶**] to pause, and touch [**▶** / **||**] to play back.

- No sound is played during slow motion playback.
- Reverse slow motion playback is not available on the DVD-VR and Video CD.
- 1/2, 1/8 are approximate speeds. The actual speed differs from disc to disc.

Selecting Programme (SKIP) DVD-VR

1 Touch [**P1/3**] twice while playing a programme of a DVD-VR disc.

The PROGRAM function guide is displayed.

2 Touch [**P**] * [**▼**] or [**▲**] to select a programme.

- * To switch the function guide display **⇒** [**▼**] or [**▲**] to [**P**] [**▼**] or [**▲**], play back the programme. For details, refer to “Searching by Programme” (page 23).

Selecting Playlist (SKIP) DVD-VR

1 Touch [**P1/3**] twice while playing a playlist of a DVD-VR disc.

The PLAYLIST function guide is displayed.

2 Touch **⇒** * [**▼**] or [**▲**] to select a playlist.

- * To switch the function guide display [**P**] [**▼**] or [**▲**] to **⇒** [**▼**] or [**▲**], play back the playlist. For details, refer to “Searching by Playlist” (page 23).

Selecting Folders DivX

Touch **■** [**▼**] or [**▲**] to select the folder.

Repeat Playback

DVD-V DVD-A DVD-VR V CD DivX

Use this function to play the disc's titles, chapters or tracks etc., repeatedly.

DVD Video

1 Touch [**↺**].

The repeat mode switches every time the button is touched.

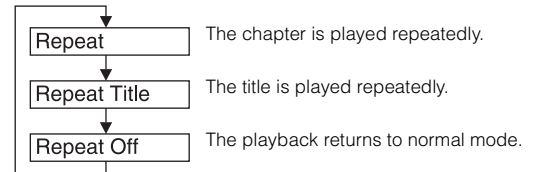

- Display may vary depending on the connected devices.
- The REPEAT mode is always turned off when [**↺**] is touched and held for at least 2 seconds.

Video CD

1 During playback, touch [**↺**].

The repeat mode switches every time the button is touched.

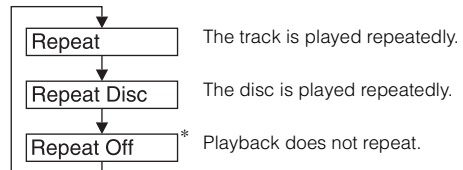

* Displayed only in the changer mode.

- Display may vary depending on the connected devices.
- The track/disc repeat modes cannot be used on Video CDs with playback control (PBC). These modes can be carried out after turning PBC off. See “Setting the Video CD Play Mode” on page 38.
- For some discs it is not possible to switch the repeat mode.

DVD Audio

1 Touch [**↺**].

The repeat mode switches every time the button is touched.

VCAP mode*1:

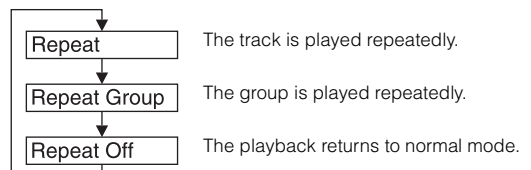

VOFF mode*1:

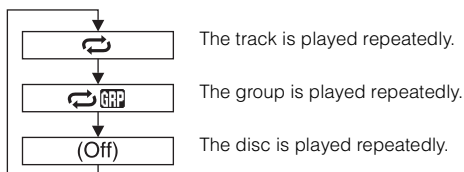

*1 When "VCAP" or "VOFF" is set in "Setting the DVD-Audio Playback Mode" (page 37).

DVD-VR

1 Touch [REPEAT].

The repeat mode switches every time the button is touched.

The Program mode*2:

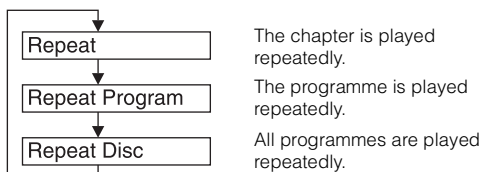

The Playlist mode*2:

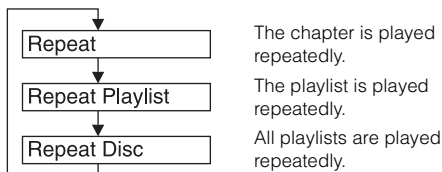

*2 To switch the Program mode display to the Playlist mode display on the DVD mode main screen, play back via program or playlist search. Refer to "Searching by Programme" or "Searching by Playlist" (page 23).

- Only discs containing a Playlist can be displayed.

DivX®

1 Touch [REPEAT] after touching [P1/2].

The repeat mode switches every time the button is touched.

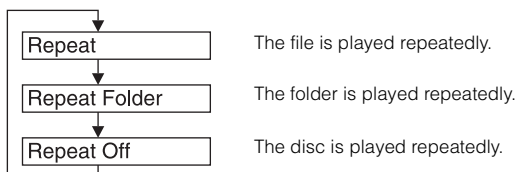

- The REPEAT mode is always turned off when [REPEAT] is touched and held for at least 2 seconds.

Searching by Title/Group/Program/playlist/Folder Number

DVD-V DVD-A DVD-VR DivX

Use this function to easily find positions on the DVD using the DVD's titles, Groups, Programs or playlists.

1 Touch [P1/2]* while playback is stopped.

The function guide appears.

* The display differs, depending on the disc (mode).

2 Touch [10KEY].

The numeric keypad input mode screen appears.

3 Enter a desired title, Group, Program or playlist by touching its title, Group, Program or playlist number.

See page 23 for operation of the numeric keypad.

4 Confirm your selection by touching [Enter].

Playback will start from the title number selected.

- To switch the Program mode display to the Playlist mode display on the DVD mode main screen, play back via program or playlist search. Refer to "Searching by Programme" or "Searching by Playlist" (page 23).
- This function cannot be used on discs on which no title numbers are recorded.
- Playback starts from the beginning of the chapter/track number in the state of Pre Stop.
- Some disc may not accept any operation.

Searching Directly by Chapter, Track or File Number

DVD-V DVD-A DVD-VR V CD DivX

Use this function to easily move to the beginnings of the chapters, tracks or files on the disc.

1 Touch [P1/2]* in any mode other than stop mode.

The function guide will appear.

* The display differs, depending on the disc (mode).

2 Touch [10KEY].

The numeric keypad input mode screen will appear.

3 Touch and enter the chapter or track number you want to play.

See page 23 for operation of the numeric keypad.

4 Touch [Enter] to confirm your selection.

Playback will start from the selected chapter or track.

- This function is not available for a disc on which chapters or tracks are not stored.
- Be sure to turn PBC off before starting the search (See "Setting the Video CD Play Mode" on page 38).

Switching the Angle

On DVDs in which scenes have been filmed from multiple angles, the angle can be switched during playback.

- 1 During playback, touch [P1/2]*.**
The function guide changes.

* *The display differs, depending on the disc (mode).*

- 2 Touch [ANGLE].**
The angle switches between the angles recorded on the disc every time the button is touched.

- *Some time may be required for the angle to change.*
- *Depending on the disc, the angle may switch in one of two ways.*
 - *Seamless: The angle switches smoothly.*
 - *Non-seamless: When the angle is switched, a still picture is displayed first, after which the angle switches.*
- *To play back a DVD-Audio disc, set "VCAP" in "Setting the DVD-Audio Playback Mode" (page 37).*

Scroll to Move the Page Forward or Backward

"Page" is a still image stored on a DVD-Audio disc.

- 1 Touch [P1/3] twice while playing a DVD-Audio disc in VCAP mode*.**

* *Playing back a DVD-Audio disc when "VCAP" is set in "Setting the DVD-Audio Playback Mode" (page 37).*

- 2 Touch PAGE [▼] or [▲].**
The display switches.
Touch and hold to display the home page.

- *For DVD-Audio discs without Pages, depending on the DVD-Audio disc, the "Page" function may not be operable if images are in slide show form.*

Switching the Audio Tracks

DVDs with multiplex audio or audio languages allow switching the sound during playback.

- 1 During playback, touch [P1/2]*¹.**

*¹ *The display differs, depending on the disc (mode).*

- 2 Touch [AUDIO].**
The sound switches between the alternate audio tracks recorded on the disc every time the button is touched.

- *The alternate track selected becomes the default setting every time the power is turned on or the disc is replaced. If the disc does not include that track, the disc's default language is selected instead.*
- *Not all discs will allow changing the alternate audio tracks during playback. In these cases, select audio tracks from the DVDs menu.*
- *There may be a delay before the selected alternate track begins to play.*

Video CDs or DVD-VR with multiplex audio

- 1 During playback, touch [P1/2]*².**
The function guide changes.

*² *Touch [P1/3] while playing a DVD-VR disc.*

- 2 Touch [AUDIO]*³.**
The left and right channels will be output as shown, each time the button is touched.

*³ *Touch [AUDIO] for at least 2 seconds to switch while playing a DVD-VR disc.*

Audio LR → Audio LL → Audio RR → Audio LR

Switching the Subtitles (Subtitle Language)

With DVDs on which multiple subtitle languages are recorded, the subtitle language can be switched during playback; moreover, subtitles can be hidden.

- 1 During playback, touch [P1/2]*.**
The function guide changes.

* *The display differs, depending on the disc (mode).*

- 2 Touch [SUBT].**
Touching this button repeatedly selects sequentially the subtitle languages recorded on the disc, and then turns the subtitles OFF.

- *To play back a DVD-Audio disc, set "VCAP" in "Setting the DVD-Audio Playback Mode" (page 37).*
- *There may be a delay before the selected subtitle appears.*
- *Not all discs will allow changing the subtitles during playback. In these cases, select subtitles from the DVDs menu.*
- *The subtitle language selected becomes the default setting every time the power is turned on or the disc is replaced. If the disc does not include that language, the disc's default language is selected instead. However, the subtitle language may differ depending on the disc.*
- *For some discs, the subtitles will be displayed even when this is set to OFF. However, the subtitle language may differ depending on the disc.*
- *Switches the subtitles ON/OFF while playing a DVD-VR disc.*

Switching from the disc menu

For some discs, the audio language, angle and subtitles can be switched from the disc menu.

- 1 Touch [MENU] or [TOP MENU] to display the menu.**

- 2 Select an item to confirm it.**
See "If a menu screen appears" on page 22.

- *To play back a DVD-Audio disc, set "VCAP" in "Setting the DVD-Audio Playback Mode" (page 37).*

About DivX®

DivX® is a codec (software) program to compress moving images while maintaining image quality using a highly advanced compression ratio and operating speed.

- Official DivX® Certified product
- Plays all versions of DivX® video (including DivX® 5) with standard playback of DivX® media files
- DivX, DivX Certified, and associated logos are trademarks of DivX, Inc. and are used under license

The unit can play back CD-R/CD-RW/DVD-R/DVD-RW/DVD+R/DVD+RW discs that are recorded in the DivX® mode with extension "avi" or "divx".

The optimum size for DivX® disc playback is as follows:

Screen Size: 32 to 720 pixel (horizontal) × 32 to 576 pixel (vertical)

With an aspect ratio other than 16:9, black bars may be displayed on the left and right sides, or at the top and bottom of the screen.

Image bit rate: "average 4 Mbps, Peak 8 Mbps"
Home Theater Profile supported

The following audio recording systems are supported.

MPEG1 Layer II	64 to 384 kbps
MPEG1 Layer III	32 to 320 kbps
MPEG2 Layer III	8 to 160 kbps
MPEG2.5 Layer III	8 to 160 kbps
Dolby Digital	64 to 448 kbps (Max. 5.1ch)

Other Useful Features

Adjusting the Audio

1 Touch [⌂].

The SETUP selection screen is displayed.

2 Touch the title bar of Audio Setup.

The display changes to the AUDIO setup screen.

Display Example for Audio Adjustment Screen

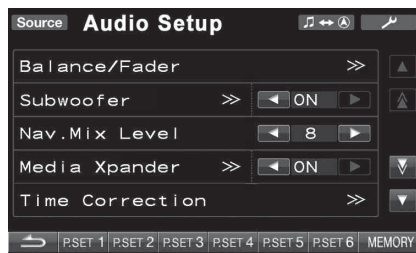

- When the optional IMPRINT audio processor (PXA-H100) or an external audio processor is connected, the "A.Processor" list is displayed. For details on operation, refer to "IMPRINT Operation (Optional)" (page 47) or "External Audio Processor Operation (Optional)" (page 53).
- Touching [↶] will return to the previous display.
- Scroll the list one line at a time by touching [▲] or [▼].
- Scroll the list one page at a time by touching [▲] or [▼].

UnitThis item is controllable with the IVA-D511RB/ IVA-D511R only.

IMPRINTThis item is available when the optional IMPRINT audio processor (PXA-H100) is connected.

A.PROCThis item is available when an External Audio Processor is connected.

Adjusting Balance/Fader **Unit** **IMPRINT**

Touch the title bar of Balance/Fader.

The display changes to the Balance/Fader adjusting screen.

Display Example for Balance/Fader Screen

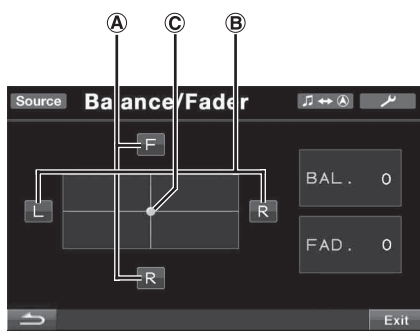

A Adjusting the Fader

Touch [F] or [R] to adjust the volume of the front and rear speakers.

Setting range: F15 to R15

- If an IMPRINT audio processor (PXA-H100) is connected to this unit and you have set the 2.2ch (3WAY)/4.2ch (FRONT/REAR/SUBW.) switch of the IMPRINT audio processor (PXA-H100) to 2.2ch (3WAY), you cannot adjust the Fader mode. For details, refer to the Owner's Manual of PXA-H100.

B Adjusting the Balance

Touch [L] or [R] to adjust the sound volume of the left and right speakers.

Setting range: L15 to R15

C Adjusting the Balance/Fader Directly

Touch and move [O] to a desired setting.

Or touch a desired setting range, and [O] will move to that location.

Touch [L] or [R] of Balance and [F] or [R] of Fader for fine-tuning.

Adjusting Bass/Treble IMPRINT

You can change the bass or treble frequency emphasis to create your own tonal preference.

Touch the title bar of Bass/Treble to adjust screen.

- Adjustment cannot be performed when Defeat is set to ON.
- If OFF is set in "Changing MultiEQ mode" (page 47) when the IMPRINT audio processor is connected, the list is not displayed.

Setting the Bass level

You can emphasize or weaken the bass frequency.

Touch [◀] or [▶] of Bass Level to select the desired bass level.

Setting range: -7 to +7

Setting the treble level

You can emphasize the treble frequency.

Touch [◀] or [▶] of Treble Level to select the desired treble level.

Setting range: -7 to +7

Subwoofer On and Off Unit IMPRINT

Touch [◀] or [▶] of Subwoofer to set to ON or OFF.

- OFF: Subwoofer output is off.
- ON: Subwoofer output is on.

Adjusting the Subwoofer Level

When ON is set in "Subwoofer On and Off", the item is displayed.

When an External Audio Processor is connected, the list is not displayed.

- 1 Touch the title bar of Subwoofer.
The display change to the Subwoofer Adjusting screen.
- 2 Touch [◀] or [▶] of Level to adjust the subwoofer output.

Setting range: 0 to 15

Switching the Subwoofer phase

When ON is set in "Subwoofer On and Off" while the car is parked, the item is displayed.

The subwoofer output phase is toggled SUBWOOFER NORMAL (0°) or SUBWOOFER REVERSE (180°).

- 1 Touch the title bar of Subwoofer.
The display change to the Subwoofer Adjusting screen.
- 2 Touch [◀] or [▶] of Phase to select to 0° or 180°.

- When the IMPRINT audio processor is connected, set "Changing MultiEQ mode" (page 47) to OFF while the car is parked.

Setting the Subwoofer System

When ON is set in "Subwoofer On and Off" while the car is parked, the item is displayed.

- 1 Touch the title bar of Subwoofer.
The display change to the Subwoofer Adjusting screen.
- 2 Touch [◀] or [▶] of System to select to System 1 or System 2.

System 1: Subwoofer level changes according to the main volume setting.

System 2: Subwoofer level change is different from the main volume setting. For example, even at low volume settings, the subwoofer is still audible.

Setting the Subwoofer Channel

When ON is set in "Subwoofer On and Off" while the car is parked, the item is displayed.

- 1 Touch the title bar of Subwoofer.
The display change to the Subwoofer Adjusting screen.
- 2 Touch [◀] or [▶] of Channel to select to Stereo or Mono (monaural).

Stereo: Subwoofer stereo (L/R) output

Mono: Subwoofer monaural output

- When the IMPRINT audio processor is connected, set "Changing MultiEQ mode" (page 47) to OFF while the car is parked.

Adjusting the Subwoofer Level A.PROC

When an external audio processor is connected, the list is displayed.

Touch [◀] or [▶] of Subw. Level to adjust the subwoofer output.

Setting range: 0 to 15

Adjusting Nav. Mix Level Unit IMPRINT A.PROC

Touch [◀] or [▶] of Nav. Mix Level to adjust the volume of navigation interruption.

Setting range: 0 to 15

- This adjustment becomes available when Nav. Mix is turned ON in "Setting the Navigation Interruption" (page 45).
- The setting navigation interruption is not displayed if an external audio processor not compatible with Nav. Mix is connected.
- While an External audio processor is connected, this function may inoperable when Defeat is set to ON.

Setting the Media Xpander mode Unit

When the Media Xpander is on, you can adjust the Media Xpander level. While the car is parked, the item is displayed.

1 Select ON or OFF of MX by touching [◀] or [▶] of Media Xpander.

OFF: Turns off the MX effect of every music source.
ON: Turns on the specified MX mode.

2 Touch the title bar of Media Xpander after setting to ON.

The Media Xpander setup screen appears.

3 Touch [◀] or [▶] of the current MX mode.

- Music source (such as USB and CDs, etc.) level can be set.

MX CD (No Effect, Level 1 to 3)

CD mode processes a large quantity of data. This data is used to reproduce the sound cleanly by making use of the data quantity.

MX CMPM (No Effect, Level 1 to 3)

This corrects information that was omitted at the time of compression. This reproduces a well-balanced sound close to the original.

MX DVD (No Effect, Level 1 to 3)

The dialog portion of the video is reproduced more clearly.

MX AUX (No Effect, Level 1 to 3)

Choose the MX mode that corresponds to the media connected.

- When No Effect is selected, MX effect of each MX mode will be OFF.
- Each music source, such as CD, MP3 can have its own MX setting.
- There is no MX mode for FM, MW and LW radio.
- MX CMPM is applied for MP3/WMA/AAC, iPod/iPhone and BT Audio.
- The MX setting can be performed only when a source is currently selected.
- This setting is unavailable when an external audio processor is connected.
- The function is inoperable when Defeat is set to ON.
- You can adjust this setting in main source screen by touching [🔊] directly.

Adjusting the Time Correction Unit

While the car is parked, this item is displayed.

Before performing the following procedures, refer to "About Time Correction" (page 51).

1 Touch the title bar of Time correction.

The Time correction screen appears.

2 Adjust the distance (0.0 to 336.6 cm) of a desired speaker by touching the respective [◀] or [▶] button.

L = (distance to farthest speaker) – (distance to other speakers)

Refer to "Time Correction Value List" on page 51.

3 Repeat step 2 to set another speaker.

By setting these values to make its sound reach the listening position at the same time as the sound of other speakers.

- The total adjustment distance for all speakers should be less than 680 cm (268.1 inch).
- This setting is unavailable when an external audio processor is connected.

Setting the Time Correction Unit (T.Corr Parameter) Unit

While the car is parked, this item is displayed.

You can change the unit, (cm or inch) of time correction.

Touch [◀] or [▶] of T.Corr Parameter to select cm or Inch.

Setting item: T.Corr Parameter

cm ↔ Inch

cm: The unit of time correction is cm.

Inch: The unit of time correction is Inch.

- This setting is unavailable when an external audio processor is connected.

Setting EQ mode Unit

While the car is parked, this item can be adjusted.

This setting gives you a choice of 5-band parametric, or 7-band graphic equalizer.

Touch [◀] or [▶] of EQ Select to select P-EQ or G-EQ.

P-EQ: 5-band Parametric EQ.

G-EQ: 7-band Graphic EQ.

- This setting item is ineffective when Defeat is ON or an external audio processor is connected.

Adjusting the Parametric Equalizer Curve (P-EQ)

When P-EQ is set in "Setting EQ mode" while the car is parked, this item can be adjusted.

You can modify the Equalizer settings to create a response curve more appealing to your personal taste.

1 Touch the title bar of EQ Select after selecting P-EQ in "Setting EQ mode".

The P-EQ list screen appears.

2 Adjust the P-EQ to your preference.

Adjusting the Band

Touch [◀] or [▶] of Band to select the band to be adjusted.

Band 1 / Band 2 / Band 3 / Band 4 / Band 5

Adjusting the Frequency

Touch [◀] or [▶] of Freq. to adjust the frequency of the selected band.

Adjustable frequency bands: 63 Hz to 17.5 kHz (in 1/3 octave steps)

Band-1: 63 Hz~200 Hz (63 Hz)

Band-2: 160 Hz~1 kHz (160 Hz)

Band-3: 630 Hz~4 kHz (630 Hz)

Band-4: 1.6 kHz~10 kHz (1.6 kHz)

Band-5: 10 kHz~17.5 kHz (10 kHz)

Adjusting the Level

Touch [◀] or [▶] of Level to adjust the level of selected band.

Adjustable level: -6 to +6 dB

Setting the Bandwidth

Touch [◀] or [▶] of Q to select the bandwidth.

Adjustable bandwidth: 1, 2, 3, 4

3 To adjust another band, repeat step 2 and adjust all bands.

- The frequency value range of the current band should be higher than the previous band's setting value and lower than the next band's setting value.
- While adjusting the Parametric EQ, you should consider the frequency response of the connected speakers.
- When the Parametric EQ is adjusted, the adjustment for Graphic EQ becomes ineffective.

Adjusting the Graphic Equalizer Curve (G-EQ)

When G-EQ is set in "Setting EQ mode" while the car is parked, this item can be adjusted.

You can modify the equalizer settings to create a response curve more appealing to your personal taste.

1 Touch the title bar of EQ Select after selecting G-EQ in "Setting EQ mode".

The G-EQ list screen appears.

2 Adjust the G-EQ to your preference.

Band-1 (80 Hz) / Band-2 (250 Hz) / Band-3 (500 Hz) /
Band-4 (1,000 Hz) / Band-5 (4,000 Hz) / Band-6 (8,000 Hz) /
Band-7 (16,000 Hz)

Adjusting the Level

Touch [◀] or [▶] to adjust the level of selected band.

Adjustable level: -6 to +6 dB

3 To adjust another band, repeat step 2, and then adjust all bands.

- When Graphic EQ is adjusted, the adjustment for Parametric EQ becomes ineffective.

Adjusting Highpass Filter Unit

When Defeat is set to OFF, touch the title bar of H.P.F. to adjust screen.

Touch [◀] or [▶] of Front H.P.F. to adjust the front speaker.

Setting range: OFF, 60 Hz, 80 Hz, 100 Hz

Touch [◀] or [▶] of Rear H.P.F. to adjust the rear speaker.

Setting range: OFF, 60 Hz, 80 Hz, 100 Hz

- Select OFF when no adjustment is required.
- The H.P.F. item is not displayed when an IMPRINT audio processor or External Audio Processor is connected.

Turning Defeat ON or OFF Unit IMPRINT A.PROC

Touch [◀] or [▶] of Defeat to set to ON or OFF.

Storing Settings in the Memory

Adjustment or setting contents of Time Correction and P/G-EQ can be stored.

Contents that can be stored vary depends on the audio processor used.

1 Check whether the Defeat mode is OFF.

2 Touch [MEMORY] on the right side of bottom screen.

3 Within 5 seconds, touch any one of the preset buttons [P.SET 1] through [P.SET 6] on the bottom screen.

The setting contents are stored.

- The stored contents will not be deleted even when the battery power cord is detached.

Calling up the Preset Memory

1 Check whether the Defeat mode is OFF.

2 Touch any one of the preset buttons [P.SET 1] through [P.SET 6] on the bottom display to select the preset memory.

- You can adjust this setting in main source screen by touching [◀] directly.
- It takes a few moments to call up the preset memory.

Search Function

1 Touch [Q] on the function guide while in the CD or MP3/WMA/AAC or DivX® mode.

The search list screen is displayed.

Select a desired track or folder

Touch [▶] for direct playback.

When a hierarchical list is prepared, >>> will be displayed.

Touch the title bar to display the respective hierarchy list screens.

Display Example for Search Screen



- ① Select directly by touching [▶], and its track (or folder/file) is played back.
- ② >> is displayed if there is a hierarchical list.
- ③ Scroll the list one line at a time by touching [▲] or [▼].
- ④ Scroll the list one page at a time by touching [▲] or [▼].
- ⑤ Touch [↶] to return to the previous list screen.
- ⑥ Touching [Exit] will turn off the search screen, and return to previous main screen.

- The search function does not work on the DVD, Video CD or CD changer: If [TOP MENU] or [MENU] is touched in the DVD-VR mode, the unit changes to the search function. Refer to "Searching by Programme" and "Searching by Playlist" (page 23).
- A folder list is displayed only during MP3/WMA/AAC playback when the DVD player (DVA-5210) or changer compatible with MP3 is connected.

Internal CD player mode

1 The track list* screen appears.

* If the CD is text compatible only.

2 Touch [▶] of a desired track text*.
The selected track will be played back.

- "TRACK" is displayed in the track text list if there is no text on the disc.

Internal MP3/WMA/AAC/DivX® Player/external MP3-compatible DVD Player/Changer Mode

1 The folder list screen appears.
Select a desired folder and then touch the title bar.
(➤ appears only when a file is present in the selected folder.)
The file list screen is displayed.

- Touch [▶] to play back the folder directly.

2 Touch [▶] of a desired file name.
The selected file will be played back.

Rear Selection Function

The rear entertainment function independently routes different sources to the front and the rear inside a car. For example, while listening to the radio or other audio source in the front, DVD can be enjoyed in the rear with the optional rear monitor and headphones.

1 Touch [Source] on the main source screen.

The SOURCE selection screen is displayed.

2 Touch [Rear].

Rear Select display appears.

- This function cannot be used when "Setting the Picture/Sound Output" (page 46) is set to OFF in the System Setup.
- If [Main] on the Rear Select screen is touched, the screen changes to the main source screen.

3 Touch the desired source such as visual (auxiliary input, built-in DVD, etc.) to select.

- Touch [Off] to cancel the rear entertainment function.
- When the AUX1 IN is set to OFF and AUX2 IN is set to iPod Video, the AUX source is not displayed. Refer to "Setting the AUX Mode" (page 45).
- Some sources such as DVD CHG/EXT.DVD (connected via Ai-Net), DVB-T (TUE-T250DV is connected), USB-Video, etc., can be normally displayed on rear monitor only when they are the same as the main source.

Switching Display Modes

While your vehicle is parked, touch [WIDE] on the visual source screen.

Each touch changes the display modes as follows:

Mode 1 → Mode 2 → Mode 3 → Mode 1
(WIDE) (CINEMA) (NORMAL) (WIDE)



In Mode 1 (Wide), the monitor displays a normal picture wider to fit in a wide-screen monitor by evenly stretching out the picture horizontally.

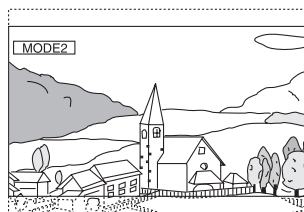

In Mode 2 (Cinema), the monitor displays a normal picture by stretching out the picture horizontally and vertically. This mode is good for displaying a cinema type picture at the 16 : 9 ratio.

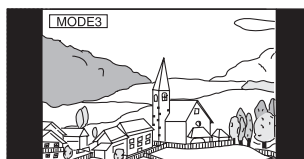

In Mode 3 (Normal), the monitor displays a normal picture at the centre of the screen with a vertical black band at each side.

- You can also switching the display Modes by pressing BAND/TA on visual source screen while your vehicle is parked.
- To play back a DVD-Audio disc, set "VCAP" in "Setting the DVD-Audio Playback Mode" (page 37).

Switching the Visual Source Only (Simultaneous Function)

You can watch the video portion of another source while listening to the current source.

- 1 Press **VISUAL** while the monitor is open.
The VISUAL selection screen appears.
- 2 Touch desired visual source.
The visual source is switched to the selected one.

Canceling the Simultaneous Function

- 1 Press **VISUAL** while the monitor is open.
- 2 Touch **[Normal]**.
The simultaneous function is cancelled.

- If a DVD player is connected, you can receive the DVD picture. DVD changer (DHA-S680P) is connected:
Press and hold **V.OUT** on the remote control supplied with the DVD player or DVD changer for more than 2 seconds. The picture of the DVD will be output.
The DVA-5210 or DHA-S690 is connected:
Press **V.OUT** on the remote control (included with the DVA-5210 or DHA-S690) to output DVD picture.
- The simultaneous function cannot be used when the Audio source is in the navigation mode.
- When the AUX1 IN is set to OFF and AUX2 IN is set to iPod Video, the AUX source is not displayed. Refer to "Setting the AUX Mode" (page 45).
- Some sources such as DVD CHG/EXT.DVD (connected via Ai-Net), DVB-T (TUE-T250DV is connected), USB-Video, etc., can be normally displayed in Visual mode only when they are the same as the main source.

Blackout Mode On and Off

When Blackout mode is turned on, the monitor display will turn off to reduce power consumption.

This additional power enhances the sound quality.

- 1 Press **VISUAL** while the monitor is open.
The VISUAL selection screen is displayed.
 - 2 Touch **[Off]**.
The backlit-display portion goes out.
 - 3 Touch **[Off]** again to cancel the display backlight.
- If any button on the unit is pressed or main screen is touched during Blackout mode, the function will be displayed for 5 seconds to show the operation before returning to Blackout mode.

Setup

DVD Setup

DVD Setup Operation

The Parking Brake must be engaged to access the DVD mode screen. Attempting to access this screen while driving will display the warning-Can't operate while driving.

The DVD Setup operation can be carried out after removing the disc from the unit.

The following steps 1 to 5 are common operations to each "Setting item" of DVD Setup. Refer to each section for details.

- 1 Touch **[Setup]** on the main screen.
The SETUP selection screen is displayed.
- 2 Touch the title bar of Source Setup.
The SOURCE SETUP screen appears.
- 3 Touch the title bar of DVD Setup.
The DVD setup screen appears.
- 4 Touch **[Left]** or **[Right]**, etc., of the desired item to change its setting.

Setting items:

Menu Language / Audio Language / SUBT. Language / Country Code / Parental / Digital Out Mode/ Downmix Mode / TV Screen / Bonus Code / DVD-A Setup / File Play Mode / DVD Play Mode / DivX Info. / PBC

Display example for DVD setup screen

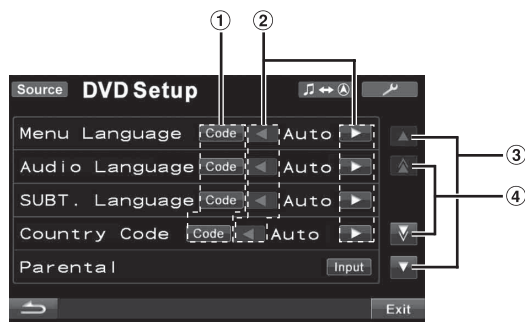

- ① Touch **[Code]** to display the numeric keypad input screen.
- ② Touch **[Left]** or **[Right]** to set a desired language/item.
- ③ Touch **[Up]** or **[Down]** to scroll a setting item list by one Line.
- ④ Touch **[Up]** or **[Down]** to scroll a setting item list by one page.

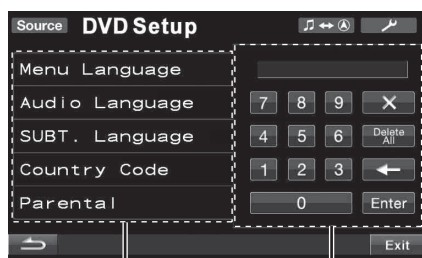

①

②

- ① The numeric keypad input screen closes when the area is touched while displayed.
- ② Numeric keypad input screen
The numeric keypad is used if you want to play back in a language other than that displayed, or to input your parental lock password, etc.

5 Touch [↩] to return to the previous screen.

- Touching [Exit] will turn off the DVD Setup screen, and return to previous main screen.
- Immediately after changing the settings of DVD mode (while the system is writing data automatically) do not turn the ignition key (engine key) to OFF. Otherwise, the settings may not be changed.

Changing the language setting

The audio language, subtitle language and menu language can be set according to your preferences.

Once set, this becomes the default language. This function is convenient when you always want to listen in English. (The language setting is not effective on some discs. If not, the default language is set from the factory.)

- When the settings are changed, the old settings are overwritten. Make a note of the current settings before making changes. The settings are cleared when the vehicle's battery is disconnected.
- To temporarily change the language of the current disc, either do so from the DVD menu or by using the operation described in the section "Switching the Audio Tracks" (page 27).
- If the disc does not include the selected language, the disc's default language is set.

Setting of the Menu Language

Set the language used for the menus (title menu, etc.).

Setting item: Menu Language

Setting contents: Auto / EN / JP / DE / ES / FR / IT / SE / RU / CN

- When "Auto" is selected, the primary menu language among the recorded ones is played.

Setting of the Audio Language

Set the audio language produced from the speakers.

Setting item: Audio Language

Setting contents: Auto / EN / JP / DE / ES / FR / IT / SE / RU / CN

- When "Auto" is selected, the primary audio language among the recorded ones is played.

Setting of the Subtitle Language

Set the language of the subtitles displayed on the screen.

Setting item: SUBT. Language

Setting contents: Auto / EN / JP / DE / ES / FR / IT / SE / RU / CN

- When "Auto" is selected, the primary subtitle language among the recorded ones is played.

To play in a language other than those displayed

- 1 Touch [Code].
The numeric keypad screen is displayed.
- 2 Touch the 4-digit numeral of the language number.
As for the language number, refer to "List of Language Codes" (page 76).
- 3 Touch [Enter] to memorize the number.

Changing the Country Code Setting

Set the country number of which you want to set the rating level (Parental lock).

Setting item: Country Code

Setting content: Auto / Other

- Auto:** The primary country code among the recorded ones is played.
- Other:** The setting content changes to "Other" if the desired country code is input.

- When the settings are changed, the old settings are overwritten. Make a note of the current settings before making changes. The settings are cleared when the vehicle's battery is disconnected.
 - 1 Touch [Code] of Country Code.
 - 2 Touch [Delete All] or [←].
Delete the displayed country number.
 - 3 Touch the 4-digit country code.
As for the country number, refer to "List of Country Codes" (pages 77, 78).
 - 4 Touch [Enter] to memorize the code.

Setting the Rating Level (Parental Lock)

This function can help restrict the viewing of movies to children of appropriate age levels only.

Setting item: Parental

Setting content: Input

- When the settings are changed, the old settings are overwritten. Make a note of the current settings before making changes. The memory is cleared when the vehicle's battery is disconnected.
- On unrated DVDs, playback will not be restricted even if the rating level is set.
- If you want to play back DVD software with the parental lock feature and its use is currently restricted, change the rating level and the country number in order to play back the DVD.
- Once set, this rating level remains in memory until changed. To enable playback of discs of higher rating levels or to cancel the parental lock, the setting must be changed.
- Not all DVDs provide a Parental Lock feature. If you are unsure about a DVD, play it first to confirm. Do not leave DVDs accessible to young children for whom you deem them inappropriate.
 - 1 Touch [Input].
The numeric keypad screen is displayed.
 - 2 Touch the numeric keypad to input a 4-digit password.
The initial number is 1111.
Input number are displayed as "*".
 - 3 Touch [Enter] to memorize the number.
The PARENTAL screen appears.

Set the rating level of PARENTAL

- 4 Touch [◀] or [▶] of Parental to turn on.
- 5 Touch [◀] or [▶] of Parental Level to select the rating level (1 to 8).
Select "OFF" to cancel the parental lock or if you do not want to set a rating level. The smaller the number, the higher the rating level.
- 6 Touch [↩] to return to the previous screen.

Changing the password

- 4 Touch [Input] of Password Change.
The numeric keypad screen is displayed.
- 5 Touch the input screen to enter a new 4-digit password.
 - Keep a note of the number somewhere safe in case you should forget it.
- 6 Touch [Enter] to memorize the number.
- 7 Touch [↩] to return to the previous screen.

Changing the rating level temporarily

Some discs may request that you change the rating level set in the default settings during playback. In this case, the message appears on the monitor screen "Parental level change OK? [Yes] / [No]."

If this screen appears, change the level as follows:

- **To change parental level and play, touch [Yes].**
When [Yes] is touched, the numeric keypad input screen is displayed. Input the 4-digit password in "Setting the Rating Level (Parental Lock)" you set, then touch [Enter].
- **To play without changing the parental level, touch [No].**
(When [No] is touched, playback will be at the parental level set in "Setting the Rating Level (Parental Lock).")

Changing the Digital Output Setting

Use the following procedure to set the digital audio signal output from the IVA-D511RB/IVA-D511R.

Setting item: Digital Out Mode

Setting contents: Auto / LPCM

- Auto:** The digital output is switched automatically according to the type of audio signals being played.
Be sure to select "Auto" when you want to connect a digital audio processor and play Dolby Digital audio. "Auto" is the factory setting.
- LPCM:** The audio signals recorded on the disc are converted to 48 kHz/16 bit (for DVDs) or 44.1 kHz (for Video CDs and CDs) linear PCM audio signals for output.

Audio output/Optical digital audio output

Disc Format	Audio recording format		Digital output setting (DVD SETUP)	Optical digital audio output	Analog audio output (Ai-NET, RCA output)
	Fs	Q			
LPCM (CD-DA, DVD-V, DVD-A, DVD-VR)	44.1/176.4kHz	16/20/24bit	AUTO or LPCM	44.1kHz, 16bit, LPCM 2ch (2ch Downmix)*	OK
	48/96/192kHz	16/20/24bit	AUTO or LPCM	48kHz, 16bit, LPCM 2ch (2ch Downmix)*	OK
PPCM (DVD-A)	44.1/88.2/ 176.4kHz	16/20/24bit	AUTO or LPCM	Not output	OK
	48/96/192kHz	16/20/24bit			
Dolby Digital (-EX) (DVD-V, DVD-A, DVD-VR)	48kHz	16/18/20bit	LPCM	48kHz, 16bit, Decoded 2ch (2ch Downmix)*	OK
			AUTO	Auto (Max 7.1ch)*	OK
DTS (-ES) (CD-DA, DVD-V, DVD-A)	44.1kHz	16/20/24bit	LPCM	44.1kHz, 16bit Decoded 2ch (2ch Downmix)*	OK
			AUTO	Auto (Max 6.1ch)*	OK
	48/96kHz	16/20/24bit	LPCM	48kHz, 16bit, Decoded 2ch (2ch Downmix)*	OK
			AUTO	Auto (Max 6.1ch)*	OK
MPEG1Layer II (VCD, DVD-V, DVD-A, DVD-VR)	44.1kHz	16bit	LPCM	44.1kHz, 16bit, Decoded 2ch*	OK
			AUTO	Auto*	OK
	48kHz	16bit	LPCM	48kHz, 16bit, Decoded 2ch (2ch Downmix)*	OK
			AUTO	Auto (Max 5.1ch)*	OK
MPEG2Layer II (DVD-V, DVD-A, DVD-VR)	44.1kHz	16bit	LPCM	44.1kHz, 16bit, Decoded 2ch*	OK
			AUTO	Auto*	OK
	48kHz	16bit	LPCM	48kHz, 16bit, Decoded 2ch (2ch Downmix)*	OK
			AUTO	Auto (Max 5.1ch)*	OK
MPEG1/2/ 2.5Layer III (MP3, WMA)	32kHz	16bit	AUTO or LPCM	32kHz, 16bit, Decoded 2ch	OK
	44.1kHz	16bit	AUTO or LPCM	44.1kHz, 16bit, Decoded 2ch	OK
	48kHz	16bit	AUTO or LPCM	48kHz, 16bit, Decoded 2ch	OK

* Not output when playing back a DVD-Audio.

Setting the Downmix Mode

This function applies to Dolby Digital, DTS stream sound.

Setting item: Downmix Mode

Setting contents: Surround / Stereo

Surround: Surround compatible Downmix
Stereo: Stereo Downmix

Setting the TV Screen

Use the procedure described below to modify the output screen according to the type of TV monitor (rear monitor) being used. This setting can also be applied for the IVA-D511RB/IVA-D511R. If the rear monitor is not connected, the screen setting is 16:9.

Setting item: TV Screen

Setting contents: 4:3 LB / 4:3 PS / 16:9

- For some discs, the picture may not be set to the selected screen size. (For details, refer to the explanation on the disc's jacket.)

4:3 LETTER BOX:

Select this when connected to a conventional 4:3 size (normal TV aspect ratio) monitor. There may be black stripes visible at the top and bottom of the screen (when playing a 16 : 9 size movie). The width of these stripes will depend upon the original aspect ratio of the theatrical release of the movie.



4:3 PAN-SCAN:

Select this when connected to a conventional 4:3 size monitor. The picture will fill the entire TV screen. However, due to the mismatch in aspect ratio, parts of the movie at the extreme left and right sides will not be visible (when playing a 16 : 9 size movie).



16:9 WIDE:

Select this when connected to a wide screen TV. This is the factory setting.



Setting of the Bonus Code DVD-A

Some DVD-Audio discs include bonus group.

The 4 digit code for the bonus group can be memorized.

Refer to the information on the jacket, etc., of the disc, for the code number.

Setting item: Bonus Code

Setting contents: Code

1 Touch [Code].

The 10 key input screen is displayed.

2 Input the 4 digit code number given on the jacket of the disc, etc.

3 Touch [Enter] to memorize the number.

- If the code number of the bonus group differs from the code number you set in this section, the 10 key input screen automatically appears in the display. If a new code number is input, this code number will be replaced.

Setting the DVD-Audio Playback Mode

DVD-A

To playback the DVD Audio Disc, you have a choice of 3 different settings. If the disc containing DVD Video and Audio, set VCAP (Video Capable Audio Player) or VOFF (Video OFF) to playback the DVD Audio.

Setting item: DVD-A Setup

Setting contents: Video / VCAP / VOFF

Video: Only DVD Video is played back if the disc contains DVD Video and Audio.
VCAP: DVD Audio is played back with Video.
VOFF: DVD Audio is played back without Video.

Playing MP3/WMA/AAC Data (File Play Mode)

When using discs containing both audio data and MP3/WMA/AAC data.

Setting item: File Play Mode

Setting content: CD / CMPM

CD: Plays only the audio data on discs containing both audio data and MP3/WMA/AAC data.

CMPM: Plays only the MP3/WMA/AAC files on discs containing both audio data and MP3/WMA/AAC data.

- If a disc is inserted, remove it from this unit before setting.
- When an MP3-compatible CD changer is used, this setting cannot be applied.

Setting the compressed File Playback Data

If a disc containing both a compressed video file and a compressed audio file is used, you have a choose to play back only a video or only audio.

Setting item: DVD Play Mode

Setting contents: Video / Audio

Video: only Video data is played back.

Audio: only Audio data is played back.

Displaying DivX® Disc Information

Setting item: DivX Info.

If the title bar of DivX Info. is touched, a DivX® file registered code is displayed.

Setting the Video CD Play Mode

When playing a Playback Control (PBC) enabled Video CD, you can choose to set PBC ON or OFF.

Setting item: PBC

Setting contents: OFF / ON

OFF: The PBC menu is not displayed.



ON: The PBC menu is displayed.

Source Setup

Source Setup Operation

The Parking Brake must be engaged to access the Source mode screen. Attempting to access this screen while driving will display the warning-Can't operate while driving.

The following steps 1 to 5 are common operations to each "Setting item" of Radio Setup. Refer to each section for details.

- 1 Touch [] on the main screen.**
The SETUP selection screen is displayed.
 - 2 Touch the title bar of Source Setup.**
The SOURCE SETUP screen appears.
 - 3 Touch the title bar of your desired Setup mode.**
DVD Setup^{*1}/Radio Setup/BLUETOOTH Setup^{*2}/RDS Setup^{*3}
- ^{*1} Refer to "DVD Setup" on page 33.
^{*2} Displayed when the optional BLUETOOTH INTERFACE (KCE-400BT) is connected and "BLUETOOTH IN" is set to Adapter (page 46).
^{*3} Refer to "RDS Operation" on page 16.
- 4 Touch [], [], or the title bar, etc. of the desired item to change its setting.**

Radio Setup:

RDS Clock DISP / FM Level / PI Seek / RDS Regional /
PTY Language / PTY31 / Tuner Condition

BLUETOOTH Setup:

Paired Devices / Device Search / Clear Device / Service Provider /
Visible Mode / Auto Answer / Speaker Select / MIC Input /
Firmware Version / Firmware Update

- For BLUETOOTH Setup details, refer to "BLUETOOTH Setup" (page 59).

- 5 Touch [] to return to the previous screen.**

Radio Setup

"Radio Setup" is selected on the source setup main menu in step 3.

RDS Time Display

When ON is selected, the clock is adjusted automatically based on the time data sent from the RDS broadcast.

Setting item: RDS Clock DISP

Setting content: OFF / ON

OFF: To adjust it manually.

ON: Adjust the clock automatically based on the time data. In this case, the clock cannot be adjusted manually. To adjust it manually, select OFF.

Adjusting Source Signal Levels

If the difference in volume level between the CD and FM radio is too great, adjust the FM signal level as follows.

Setting item: *FM Level*

Setting content: *Low / High*

PI Seek Setting

Setting item: *PI Seek*

Setting content: *OFF / Auto*

Receiving RDS Regional (Local) Stations

When OFF is selected, the unit automatically keeps receiving the related local RDS station.

Setting item: *RDS Regional*

Setting content: *OFF / ON*

Switching the Display Language of PTY (Programme Type)

You can select one of the patterns of the display languages.

Setting item: *PTY Language*

Setting content: *GB / NL / F / D / I / E*

Setting PTY31 (Emergency Broadcast) Reception

PTY31 (Emergency Broadcast) reception can be set to ON/OFF.

Setting item: *PTY31*

Setting content: *OFF / ON*

- The unit automatically gives priority to an Emergency Broadcast whenever it begins, and interrupts the programme you are currently listening to when PTY31 is set to ON.
- The unit will show "Alarm" in the display during PTY31 reception.

Setting the TUNER (FM) tone quality (Tuner Condition)

This unit can set your preferred tone quality for FM radio source.

Setting item: *Tuner Condition*

Setting contents: *Normal / HiFi / Stable*

Normal: Standard setting

HiFi: High-quality setting

Stable: Control noise



- Noise may be more noticeable when HiFi is set, depending on the reception status. In this case, the Normal setting is recommended.

Display Setup

Display Setup Operation

The Parking Brake must be engaged to access the Display mode screen. Attempting to access this screen while driving will display the warning-Can't operate while driving.

The following steps 1 to 4 are common operations to each "Setting item" of Display Setup. Refer to each section for details.

- 1 Touch [] on the main screen.**
The SETUP selection screen is displayed.
- 2 Touch the title bar of Display Setup.**
The Display Setup screen appears.
- 3 Touch [] or [] etc., of the desired item to change its setting.**

Setting items:

Tilt*¹ / Open/Close*¹ / Visual EQ*² / Dimmer / Screen Dimmer Level / Function Guide Fade / Base Color / Screen Alignment

*¹ These functions are adjustable while driving.

*² When the current source is iPod Audio or USB Audio, you can not adjust this setting.

- 4 Touch [] to return to the previous screen.**

- Touching [Exit] will turn off the Display Setup screen, and return to previous main screen.
- Immediately after changing the settings of Display Mode (While the system is writing data automatically) do not turn the ignition key (engine key) to OFF. Otherwise, the settings may not be changed.

Adjusting the Monitor Angle

Adjust the monitor's angle (between 40 and 105 degrees) for optimum visibility.

Setting item: *Tilt*

Setting range: *10 adjustable angles are available.*

- If the monitor touches an obstacle, remove the obstacle.
- The screen colour will vary when viewed at certain angles. Adjust the screen angle for the best viewing position.
- If the voltage of the vehicle's battery power is low, the screen may blink when the screen angle is changed. This is not a malfunction.

Setting Automatic Opening/Closing of the Monitor

Setting item: Open / Close

Setting content: Manual / Full / Close

- Manual:** The monitor is manually opened or closed by pressing OPEN/CLOSE.
- Full:** The monitor automatically opens or closes when the ignition key is turned to the "ACC" or "ON/OFF" position.
- Close:** The monitor automatically closes when the ignition key is turned OFF.

Setting the Brightness of the Backlighting

Backlighting is provided by a fluorescent light built into the liquid crystal panel. The illumination control adjusts the brightness of the backlighting based on the car ambient lighting for easier viewing.

Setting item: Dimmer

Setting content: Auto / ON / OFF

- Auto:** Adjust the brightness of the background illumination of the monitor automatically to the brightness of the car interior.
- ON:** Keep the background illumination of the monitor dark.
- OFF:** Deactivate Auto Dimmer mode to keep the background illumination of the monitor bright.
- When ON or Auto is set, the setting is also applied for the button lighting in "Adjusting the Dimmer of Button Lighting at Night" (page 43).
 - This setting is also effective for sub-display.

Adjusting the Minimum Level of Backlight

You can adjust the brightness of the backlight (LOW). This function could be used, for instance, to change the screen brightness while travelling at night.

Setting item: Screen Dimmer Level

Setting content: -15 to +15

You can adjust the level between MIN (-15) and MAX (+15). When it reaches the minimum or maximum point, the display shows "MIN" or "MAX" respectively.

Turn the Function Guide ON/OFF (Function Guide Fade)

By setting to ON, the function guide will be hidden if no operation is performed for 5 seconds in Radio source, USB source, etc. To display the function guide, touch the screen slightly.

Setting item: Function Guide Fade

Setting contents: OFF/ON

- In DVD play mode, the function guide will be hidden if there is no operation for 5 seconds even if you set OFF.

Switching the Font Background Colour

You can choose from 4 different colours for the font background.

Setting item: Base Color



Setting contents: Blue/Red/Green/Amber



Adjusting the Touch Panel

Adjustment becomes necessary when the display position on the LCD and the touch position on the touch panel do not match.

Setting item: Screen Alignment

Setting content:  / Reset

- 1 Touch the title bar of Screen Alignment. The adjustment screen appears.
- 2 Accurately touch the  mark provided in the lower left corner of the screen. The screen changes to the adjustment screen.
- 3 Accurately touch the  mark provided in the upper right corner of the screen. This completes adjustment, and returns to the Display Setup mode screen.

- If you have touched a location other than the  mark, touch [**Reset**] to restore the adjustment screen to the initial setting.
- If you touch [] on the adjustment screen, no adjustment is done and the Display Setup screen is restored.

Visual EQ Setting Operation

The following steps 1 to 4 are common operations to each "Setting item" of Visual EQ setting. Refer to each section for details

1 After steps 1 and 2 in "Display Setup Operation" (page 39) have been performed, touch the title bar of Visual EQ.

Visual EQ screen appears.

2 Select a desired setting item by touching [▲] or [▼].

Setting items:

Live Contrast* ↔ Visual EQ* ↔ Bright ↔ Color* ↔ Tint* ↔ Contrast ↔ Sharp* ↔ User Memory*

* The setting is available in the visual source mode. (except navigation screen)

3 Change the setting on the selected item by touching its [◀] or [▶].

4 Touch [↶] to return to the previous screen.

- Touching [Exit] will turn off the Display Setup screen, and return to previous main screen.
- Only one setting item can be displayed on each page, you can select the desired brightness, picture tint, etc. through the screen shown.

Adjusting Image Brilliance (Live Contrast)

The over brightness/darkness part of image will be adjusted to a proper brilliance automatically.

Setting item: Live Contrast

Setting contents: OFF / Low / High

- You can adjust this setting in visual source mode by touching [□] directly. (In this case, the "Live Contrast" is displayed as "Contrast".)

Selecting the Visual EQ Mode (Factory's setting)

You can select a mode suitable for the subject image.

Setting item: Visual EQ

Setting contents: OFF (FLAT) / Night M. / Soft / Sharp / Contrast / P-1 / P-2

OFF (FLAT):	Initial Setting
Night M.:	Suitable for movies in which dark scenes frequently appear.
Soft:	Suitable for CGs and animated films.
Sharp:	Suitable for old movies where images are not clearly shown.
Contrast:	Suitable for recent movies.
P-1:	Recalls the Visual EQ mode being stored on preset No.P-1 from "Storing Visual EQ" (page 42).
P-2:	Recalls the Visual EQ mode being saved on preset No.P-2 from "Storing Visual EQ" (page 42).

- To return to the initial setting, after selecting any one of the setting contents (Night M. to Contrast) and adjusting a desired brightness, picture tint, etc., set this function to OFF.
- If your desired brightness, picture tint, etc., are adjusted after selecting any one of the setting contents (Night M. to Contrast), "Custom" is displayed.

Adjusting Brightness

Setting item: Bright

Setting content: -15 ~ +15

You can adjust the brightness between MIN (-15) and MAX (+15). When it reaches the minimum or maximum point, the display shows "MIN" or "MAX" respectively.

- When any Visual EQ Preset is selected, the brightness is automatically adjusted according to the car's interior lighting as long as Auto is set in "Setting the Brightness of the Backlighting" (page 40).

Adjusting Colour of Picture

Setting item: Color

Setting content: -15 ~ +15

You can adjust the colour between MIN (-15) and MAX (+15). When it reaches the minimum or maximum point, the display shows "MIN" or "MAX" respectively.

- Colour adjustment can be made only in the iPod video, DVD, Video CD, AUX modes.
- Colour adjustment cannot be made if a Navigation system with the RGB feature is connected.

Adjusting Tint of Picture

Setting item: Tint

Setting content: G15 ~ R15

Adjust the colour from G15 to R15. "G MAX" or "R MAX" is displayed at the maximum of each colour.

- Tint adjustment can be made only in the iPod video, DVD, Video CD, AUX modes.
- When the picture from the external input is set to PAL, you cannot adjust the Tint.
- Tint adjustment cannot be made if a Navigation system with the RGB feature is connected.

Adjusting Image Contrast

Setting item: Contrast

Setting content: -15 to +15

Adjustment of contrast is done in the range of -15 to +15. "HIGH" and "LOW" appear as the maximum and minimum values specified.

Adjusting Picture Quality

Setting item: Sharp

Setting content: -5 to +5

Picture quality adjustment range is -5 to +5. "SOFT" and "HARD" appear as the minimum and maximum values specified.

- Picture quality adjustment can be made only in the iPod video, DVD, Video CD, AUX modes.
- Picture quality adjustment cannot be made if a Navigation system with the RGB feature is connected.

Storing Visual EQ

You can store the settings made for "Adjusting Image Brightness, Tint, Depth, Picture Quality and Contrast."

Setting item: User Memory

Setting content: P-1 / P-2

- 1 After completing "Adjusting Brightness, Tint, Colour, Sharpness, and Contrast" (pages 41-42), touch [◀] or [▶] of User Memory and then select preset number "P-1" or "P-2" to which the settings are to be stored.
 - 2 After selecting a preset No., touch [Memory]. The adjusted Visual EQ mode is stored by the above operations.
- You can recall the Visual EQ mode stored here from P-1 or P-2 of "Selecting the Visual EQ Mode (Factory's setting)" (page 41).

General Setup

General Setup Operation

The Parking Brake must be engaged to access the General mode screen. Attempting to access this screen while driving will display the warning-Can't operate while driving.

The following steps 1 to 4 are common operations to each "Setting item" of General Setup. Refer to each section for details.

- 1 Touch [SETUP] on the main screen.
The SETUP selection screen is displayed.
- 2 Touch the title bar of General Setup.
The General Setup screen appears.
- 3 Touch [◀], [▶] or the title bar of setting item, etc., of the desired item to change its setting.

Setting items:

Clock / Clock Mode / Clock Adjust / Summer Time / Demonstration / Beep / Auto Scroll / Language Sel. / Dimmer Level

- 4 Touch [↶] to return to the previous screen.
 - Touching [Exit] will turn off the General Setup screen, and return to previous main screen.
 - Immediately after changing the settings of General Mode (While the system is writing data automatically) do not turn the ignition key (engine key) to OFF. Otherwise, the settings may not be changed.

Displaying the Time

The clock indication on the monitor display is turned on or off respectively.

Setting item: Clock

Setting content: OFF / ON

- When you set to ON, the clock will be displayed on sub display when the power is off.

Setting the Clock Display

You can select the clock display type, 12-hour or 24-hour, depending on your preference.

Setting item: Clock Mode

Setting contents: 24h / 12h

Setting the Time

Setting item: Clock Adjust

Further setting items: Hour / Minute / Time Adjust

Setting content: 0-23 / 0-59 / Reset

- Hour: Adjust the hour.
Minute: Adjust the minute.
Reset: If the clock shows less than 30 minutes past, the minute will be "0"; more than 30, the hour advances.

- The clock-adjusting mode is cancelled when the power is turned off, when [➡] or [Exit] is touched.
- Clock adjustment can be made when "RDS Time Display" (page 38) is set to OFF.

Setting Summer Time

Setting item: Summer Time

Setting content: OFF / ON

- ON: Place the Summer Time mode ON. The time advances by one hour.
OFF: Return to the ordinary time.

Demonstration Function

This unit is equipped with a demonstration function capable of showing basic operations of respective sources on the monitor display.

Setting item: Demonstration

Setting content: OFF / ON

- ON: Turns on the demonstration mode to show the basic operations.
OFF: Turns off the demonstration mode.
- The demonstration operation is automatically repeated until the function is turned off.

Sound (Beep) Guide Function

Setting item: Beep

Setting content: OFF / ON

- ON: Activate the Sound Guide mode.
OFF: Deactivate the Sound Guide mode. The sound guide beep will not be produced when a button is pressed/touched.
- A beep always sounds when opening or closing the monitor, regardless of this setting.

Setting the Scroll

Scroll display is available if CD text, folder name, file name or tag information is entered.

Setting item: Auto Scroll

Setting contents: OFF / ON

- OFF: Turns off the AUTO scroll mode. Scroll display is done once as a track is changed.
ON: Turns on the AUTO scroll mode. Scroll display is repeated as long as the mode is turned on.

- The display scrolls on the unit when the screen is filled up.
- Song, artist and album name, etc. scrolls when an iPod/iPhone is connected.

Changing the Russian Font

Three types of font can be selected.

Setting item: Language Sel.

Setting contents: Mode1 / Mode2 / Mode3

- Mode1: Normal Font Display (ISO8859-1).
Mode2: Russian Font Display (WINDOWS-1251)
You cannot use this font for display in RDS, Tuner mode.
Mode3: European Font Display (WINDOWS-1252)

Adjusting the Dimmer of Button Lighting at Night

You can adjust the brightness of the button lighting and Sub-display at night with the dimmer.

Setting item: Dimmer Level

Setting level: -2 to +2

System Setup

System Setup Operation

The Parking Brake must be engaged to access the System mode screen. Attempting to access this screen while driving will display the warning-Can't operate while driving.

The following steps 1 to 4 are common operations to each "Setting item" of System Setup. Refer to each section for details.

- 1 Touch [SETUP] on the main screen.**
The SETUP selection screen is displayed.
- 2 Touch the title bar of System Setup.**
The System Setup screen appears.
- 3 Touch [LEFT] or [RIGHT] of the desired item to change its setting.**

Setting items:

IN Int. Mute*¹ / IN Int. Icon / Remote Sensor*² / Camera IN / Nav. IN / Nav. Mix*³ / AUX1 IN*⁴ / AUX2 IN / AUX Out / BLUETOOTH IN / Optical Out / AUX+ IN / AUX+ Level*⁵ / Illumi Color

- *¹ When OFF is set in "Setting the BLUETOOTH Connection (BLUETOOTH IN)" (page 46), the item is displayed.
*² When ON is set in "Setting the Picture/Sound Output" (page 46), the item is displayed.
*³ When ON is set in "Setting the Navigation Mode" (page 45), the item is displayed.
*⁴ The AUX1 IN setting item will not be displayed when the "AUX" is select in "Setting the Rear Camera Input" on page 44.
*⁵ When AUX+ IN is ON, the item is displayed.

- 4 Touch [BACK] to return to the previous screen.**
 - Touching [Exit] will turn off the System Setup screen, and return to previous main screen.
 - Immediately after changing the settings of System Mode (While the system is writing data automatically) do not turn the ignition key (engine key) to OFF.
Otherwise, the settings may not be changed.

Setting the External Device Interrupt Mode

If an Alpine Ai-NET Interrupt Box (NVE-K200) is connected to the IVA-D511RB/IVA-D511R, an Auxiliary Source will be allowed to interrupt the current audio source. For example, you can listen to the voice guidance of your navigation system when it occurs even while you are playing a CD or DVD. The CD/DVD player will be automatically muted during voice guidance. For further details, please refer to the manual for NVE-K200.

Setting item: IN Int. Mute
Setting content: OFF / ON

- OFF: The volume level can be adjusted in Interrupt mode.
ON: Sound will not be output. The icon set in "Setting the Interrupt Icon Display" is displayed.

- The auxiliary device being connected must have an Interrupt wire with a negative trigger for this function to operate automatically. Otherwise, a separate switch needs to be added to switch it manually.
- If Adapter or Nav. is set in "Setting the BLUETOOTH Connection (BLUETOOTH IN)" (page 46), the IN Int. Mute setting item is not displayed.

Setting the Interrupt Icon Display

The unit can display the icon of an external device, such as a telephone, whenever a phone call comes in to tell you there is a phone call.

Setting item: IN Int. Icon
Setting content: INT / TEL

- INT: The INT icon appears on the display.
TEL: When the external device (telephone) sends the interrupt signal, the telephone icon appears on the display.

Switching the function of the remote sensor

For remote control operation, the remote sensor of the external device (monitor, etc.) can be switched, as you prefer.

Setting item: Remote Sensor
Setting contents: Front / Rear

- Front: The remote sensor of this unit is effective.
Rear: The remote sensor of the external monitor connected to AUX OUT of this unit becomes effective. The remote control operates the source connected to the AUX OUT terminals.

- The touch panel rear monitor sensor has priority over the remote control sensor. If the rear monitor (connected to the Alpine rear monitor output via the Monitor control lead) is touched, the command is executed regardless of the remote control sensor switch setting. Note, however, that the remote control sensor that has been set takes priority if it has been 5 seconds since last touching the panel.
- When an optional DVD changer or DVD player is connected, and the remote control sensor is set to Rear, some onscreen button operations ([STOP] Stop, etc.) cannot be performed.
In this case, set the remote control sensor to Front.

Setting the Rear Camera Input

With an optional rear camera connected, rear view video is output to the monitor. Depending on the connected rear camera, set this item to "Direct" or "AUX".

Setting item: Camera IN
Setting contents: OFF / Direct / AUX

- OFF: The Camera mode is not displayed in the mode switching screen.
Direct: Use when the optional rearview camera such as HCE-C107D, etc. is connected.
AUX: Used when connecting to an optional rearview camera with RCA output connector.

- By shifting to reverse (R), the rear pictures are output. This function is effective when the reverse wire is properly connected.

After setting this item to Direct or AUX, touch the title bar of Camera IN, the following further setting items can be adjusted.

Setting the Rear Camera Signal Input

The video input signal type can be chosen.

Further Setting item: Camera Signal

Setting contents: NTSC/PAL / Auto

NTSC/PAL: Choose the video input signal type manually.

Auto: The suitable video input signal type will be automatically chosen between NTSC and PAL.

- When set to Auto, unstable display may occur while playing back certain black and white video signal. In this case, select NTSC or PAL mode manually.

Rear camera guide line display setting

You can set whether the rear camera guide line is displayed or not.

Further Setting item: Guide Line

Setting contents: OFF/ON

Adjusting the Rear Camera Guide line

You can adjust the rear camera guide line position.

Further Setting item: Guide Line Adjustment

1 Touch the title bar of Guide Line Adjustment.

The guide line adjustment screen is displayed.

2 Touch the guide pylon you intend to adjust.

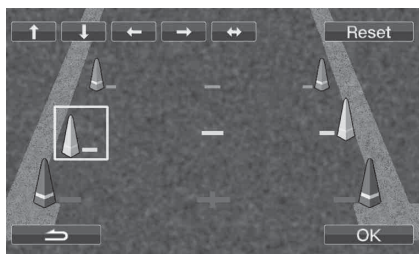

3 Touch [↑], [↓], [←] or [→] to adjust the position of the guide.

After moving the guide, when you touch [↔], the guides in the horizontal row are aligned in a row.

4 After the adjustment is completed, touch [OK].

You can touch [Reset] during adjustment to return to the default adjustment.

Setting the Navigation Mode

When you connect an optional navigation equipment, set it to ON.

Setting item: Nav. IN

Setting contents: OFF / ON

ON: Navigation source is displayed.

OFF: Navigation source is not displayed. The settings related to the navigation can not be changed from this unit.

Setting the Navigation Interruption

With an Alpine navigation system connected to the IVA-D511RB/ IVA-D511R, the voice guidance of the navigation system will be mixed with the radio or CD play.

Setting item: Nav. Mix

Setting content: OFF / ON

OFF: The navigation interruption mode is turned off.

ON: The navigation interruption mode is on.

See "Adjusting Nav. Mix Level" under "Adjusting the Audio" on page 29 to set the navigation interruption volume level.

- The volume level for voice prompts during navigation guidance is set by adjusting the its volume while the prompts are announced. When the announcement finishes, the normal audio volume and the previous audio screen are restored. The voice prompt volume is always at or below the current listening volume. If a navigation announcement cuts in while adjusting the audio level, it always resets to the current level regardless of the audio level setting.
- This setting is effective when Nav.IN of SYSTEM list screen is ON.

Setting the AUX Mode

Setting item: AUX1 IN

Setting contents: OFF / ON

OFF: AUX-1 source is not displayed.

ON: AUX-1 source is displayed.

- When OFF is selected, the settings related to AUX-1 cannot be changed from this unit.
- When AUX is set in "Setting the Rear Camera Input" (page 44), this item becomes unavailable.

After setting this item to ON, touch the title bar of AUX1 IN, the following further setting items can be adjusted.

Adjusting the AUX1 name Mode

Further Setting items: Primary / Secondary^{*1}

Setting contents: OFF^{*2} / AUX^{*3} / DVD / GAME / TV / DVB-T / EXT.DVD / NAV.^{*4} / DVD CHG / USB Video

^{*1} When a USB Video box or TUE-T200DVB (both are sold separately and cannot be connected at the same time) is connected, you can use it to connect one more External Input device. Setting the Secondary name can change the source name display of this device.

^{*2} The setting is only available for Secondary.

^{*3} The setting is only available for Primary.

^{*4} When the navigation of PMD-B200P is connected, if you want to enjoy music from PMD-B200P, please select this setting item.

- You can set Secondary name only when Primary name is set to DVB-T (or USB Video). And you cannot set the same name as in Primary name.
- OFF is not displayed when the optional DVD player or DVD changer is connected via Ai-Net. And the setting related AUX1 can not be adjusted.
- When OFF is selected, the settings related to AUX cannot be changed from this unit.
- The selected name is displayed on the Visual and Rear selection screen.
- Only when an Alpine TV tuner is connected, you can operate the displayed function guide from this unit.
- The selected source name is displayed instead of AUX source name. Select SOURCE to switch to the guide function of each mode.

Setting item: AUX2 IN**Setting contents: iPod Video / AUX**

iPod Video: Set when an iPhone or a video compatible iPod is connected to the iPod (V)/AUX Input Connector.

AUX: Set when an optional AV/RCA interface cable (4-pole mini AV plug to 3-RCA) is connected. A DVD player etc., with RCA audio/video output can be connected to this unit. In this case, the iPod video will not be displayed.

- When the current source is iPod video or AUX-2, this setting cannot be adjusted.

Touch the title bar of AUX1 IN or AUX2 IN, the following further setting items can be adjusted.

Adjusting the External Input Audio Level**Further Setting item: Level****Setting contents: Low / High**

Low: Decreases the external input audio level.

High: Increases the external input audio level.

- For AUX1, this setting item is adjustable only when AUX1 IN is set to ON.
- For AUX2, this setting item is adjustable only when AUX2 IN is set to AUX.

Switching the Visual Input Signal System**Further Setting item: Signal****Setting contents: NTSC/PAL / Auto**

- The video input type can be changed.
- When set to Auto, unstable display may occur while playing back certain black and white video signal. In this case, select NTSC or PAL mode manually.
- For AUX1, this setting item is adjustable only when AUX1 IN is set to ON.
- For AUX2, this setting item is adjustable only when AUX2 IN is set to AUX.

Setting the Picture/Sound Output

Outputs the picture/Sound of the source selected on the IVA-D511RB/ IVA-D511R connected to the rear monitor.

Setting item: AUX Out**Setting content: OFF / ON**

ON: The "Rear" item is displayed on the Source Selection screen.
Touch [Rear] to change to the REAR select screen, then touch the desired source. The selected source picture is output on the rear monitor.

OFF: The "Rear" item is not displayed on the SOURCE select screen.

Setting the BLUETOOTH Connection (BLUETOOTH IN)**Setting item: BLUETOOTH IN****Setting contents: OFF / Nav. / Adapter**

OFF: Select to ignore any external interrupts.

Nav.: Select when an optional Portable Navigation is connected.
The Telephone screen of the portable navigation is displayed.

Adapter: Select when an optional BLUETOOTH INTERFACE is connected.
When an external interruption occurs, the display changes to the Telephone screen.

- For details on BLUETOOTH operation, refer to the Owner's Manual of the BLUETOOTH INTERFACE.
- If mobile phone compatible with the Voice-Dial function is connected, the Voice-Dial function can be used.

Setting the Digital Output

To connect an audio processor using the optical digital output, set to "ON" by the following procedure.

Setting item: Optical Out**Setting contents: OFF / ON**

- Afterwards, set ACC to OFF once, then turn it ON again. The setting of Digital Output is decided.

Setting the AUX+ Mode

You can input the audio of an external device, (such as a Portable audio player) to the BLUETOOTH interface connector of this unit. A special Conversion cable (KCE-237B) is necessary to adapt the BLUETOOTH interface connector as an AUX IN.

A portable music device and a BLUETOOTH INTERFACE (KCE-400BT) cannot be connected to the BLUETOOTH interface connector at the same time.

Setting item: AUX+ IN**Setting contents: OFF / ON**

OFF: AUX+ source is not displayed.

ON: AUX+ source is displayed.

- When OFF is selected, the settings related to AUX+ cannot be changed from this unit.

Setting the AUX+ Level

After setting to ON in "Setting the AUX+ Mode", this setting can be carried out.

Setting item: AUX+ Level**Setting contents: Low / High**

Low: Decreases the external input audio level.

High: Increases the external input audio level.

Changing the Lighting Colour of Buttons**Setting item: Illumi Color****IVA-D511RB:****Setting content: Blue / Red**

Blue: Lighting colour is blue.

Red: Lighting colour is red.

IVA-D511R:**Setting contents: Green/Amber**

Green: Lighting colour is green.

Amber: Lighting colour is amber.

IMPRINT Operation (Optional)

Alpine introduces IMPRINT - the world's first technology that thoroughly eliminates in-car acoustic problems that normally degrade sound quality, which enables us to experience music the way the artist intended.

When the IMPRINT audio processor (PXA-H100) (sold separately) is connected to this unit, MultEQ and the following sound adjustment can be performed.

The Parking Brake must be engaged to access the IMPRINT mode screen. Otherwise, some functions are not adjustable.

Changing MultEQ mode

MultEQ, developed by Audyssey Labs, automatically corrects the audio for the listening environment. The system is optimized for selected positions in the vehicle. To accomplish this, MultEQ must take measurements of the vehicles response characteristics. For details on the set up procedure, consult your authorized Alpine dealer.

- 1 Touch [] .**
The SETUP selection screen is displayed.
- 2 Touch the title bar of IMPRINT Setup.**
The display changes to the IMPRINT Setup screen.
- 3 Touch [◀] or [▶] of MultEQ.**
Select the desired setting range.

Setting range : OFF (Manual Mode) / Curve1 (MultEQ-1) / Curve2 (MultEQ-2)

- The Curve mode can be selected only when Curve 1 and Curve 2 are stored.
- When MultEQ is set to Curve 1 or 2, Media Xpander, X-Over, Time Correction, Subwoofer Phase, Subwoofer Channel, TW Setup, P-EQ, G-EQ and F-EQ are set automatically. They are no longer user adjustable.
- When an external audio processor is connected, the MultEQ function cannot be used.
- If MultEQ is set to OFF, the "Adjusting Bass/Treble" (page 29) function is not available.

Adjusting Sound Setting in Manual Mode

You can change these sound settings to create your own preference when the MultEQ mode is set to OFF (Manual Mode).

Use steps 1 to 5 to select one of the Sound menu modes to modify. See the applicable section below for details about the selected item.

- 1 Check the Defeat mode is OFF (page 31), and then touch [] on the main screen.**
The SETUP selection screen is displayed.
- 2 Touch the title bar of Audio Setup.**
The Audio Setup screen appears.
- 3 Touch the title bar of A.Processor.**
The A.PROCESSOR list screen appears.
- 4 Touch [◀] or [▶] or the title bar of the desired item to change setting.**

Setting items : Media Xpander / X-Over / Time Correction / T.Corr Parameter / G-EQ / P-EQ / F-EQ / TW SETUP *

* This function can be operable only when PXA-H100 (sold separately) is connected and 2.2ch (3WAY) mode is set. For details, refer to the Owner's Manual of PXA-H100.

Setting the MX Level (Media Xpander)

MX (Media Xpander) makes vocals or instruments sound distinct regardless of the music source. The CD, DVD and iPod, will be able to reproduce the music clearly even in cars with a lot of road noise.

Setting item : Media Xpander

- 1 Touch [◀] or [▶] of Media Xpander to select ON or OFF.**
OFF: Turns off the MX effect of every music source.
ON: Turns on the specified MX mode.
- 2 Touch the title bar of Media Xpander after setting to ON.**
The Media Xpander setup screen appears.
- 3 Touch [◀] or [▶] of the desired MX mode.**

- Music source (such as CDs, iPod, etc.) level can be set.

MX CD (OFF, CD MX 1 to 3)

CD mode processes a large quantity of data. This data is used to reproduce the sound cleanly by making use of the data quantity.

MX CPM (OFF, CPM MX 1 to 3)

This corrects information that was omitted at the time of compression. This reproduces a well-balanced sound close to the original.

MX DVD (OFF, Movie MX 1 to 2)

The dialogue portion of the video is reproduced more clearly.

(DVD Music)

This disc contains a large quantity of data such as music clip. MX uses this data to reproduce the sound accurately.

MX AUX (OFF, CPMX, Movie MX, Music MX)

Choose the MX mode (CPMX, Music, or Movie) that corresponds to the media connected.

- When OFF is selected, MX effect of each MX mode will be OFF.
- Each music source, such as CD, and MP3 can have its own MX setting.
- MX mode does not function when MX is ON for FM, MW, LW radio.
- MX CPMX is applied for MP3/WMA/AAC and iPod/iPhone.
- The MX setting can be performed only when a source is currently selected.
- This function is inoperable when Defeat is set to ON.
- You can adjust this setting in main source screen by touching [🔊] directly.

Adjusting the Crossover Settings (X-Over)

Before performing the following procedures, refer to "About the Crossover" (page 52).

Setting item : X-Over

1 Touch [◀] or [▶] of X-Over to select L/R or L+R.

L/R: Different adjustment values can be set for the left and right channels.

L+R: Sets the same adjustment values for the left and right channels.

2 Touch the title bar of X-Over.

3 Touch the title bar of the band to be adjusted.

The screen changes to the X-Over screen to be adjusted.

4.2ch (FRONT/REAR/SUBW.) System

4.2ch (FRONT/REAR/SUBW.) System / (L+R)

Setting contents:

Low (SUB-W) / Mid (REAR) / High (FRONT)

4.2ch (FRONT/REAR/SUBW.) System / (L/R)

Setting contents:

Low (SUB-W)-L / Low (SUB-W)-R / Mid (REAR)-L / Mid (REAR)-R / High (FRONT)-L / High (FRONT)-R

4 Adjust the crossover to your preference.

Selecting the Cut-Off Frequency

Touch [◀] or [▶] of Freq., then select the cut-off frequency (crossover point).

The adjustable bandwidth differs depending on the speaker (channel).

4.2ch (FRONT/REAR/SUBW.) System

Setting contents:

Low (SUB-W)	20 Hz~200 Hz
Mid (REAR)	20 Hz~200 Hz
High (FRONT)	20 Hz~200 Hz

Adjusting the Slope

Touch [◀] or [▶] of Slope, then adjust the HPF or LPF slope.

Adjustable slope: FLAT, -6 dB/oct., -12 dB/oct., -18 dB/oct., -24 dB/oct.

Adjusting the Level

Touch [◀] or [▶] of Level, then adjust the HPF or LPF level.

Adjustable output level: -12 to 0 dB.

5 Repeat steps 3 to 4 to make adjustment to the other bands.

2.2ch (3WAY) System

2.2ch (3WAY) System / (L+R)

Setting contents:

Low / Mid-L / Mid-H / High

2.2ch (3WAY) System / (L/R)

Setting contents:

Low-L / Low-R / Mid-L-L / Mid-L-R / Mid-H-L / Mid-H-R / High-L / High-R

4 Adjust the crossover to your preference.

Selecting the Cut-Off Frequency

Touch [◀] or [▶] of Freq., then select the cut-off frequency (crossover point).

The adjustable bandwidth differs depending on the speaker (channel).

2.2ch (3WAY) System

Setting contents:

Low / Mid-L	20 Hz~200 Hz
Mid-H	20 Hz~20 kHz
High	(1 kHz~20 kHz)* ¹ / (20 Hz~20 kHz)* ²

*¹ When Factory's is selected, refer to "Setting the Response Slope for the High Range Speaker (TW Setup)" (page 50).

*² When User's is selected, refer to "Setting the Response Slope for the High Range Speaker (TW Setup)" (page 50).

Adjusting the Level

Touch [◀] or [▶] of Level, then adjust the HPF or LPF level.

Adjustable output level: -12 to 0 dB.

Adjusting the Slope

Touch [◀] or [▶] of Slope, then adjust the HPF or LPF slope.

Adjustable slope: FLAT*, -6 dB/oct., -12 dB/oct., -18 dB/oct., -24 dB/oct.

* FLAT can be set for the HIGH slope only when User's is selected in "Setting the Response Slope for the High Range Speaker (TW Setup)" (page 50). Depending on the response characteristics of the speaker, care should be taken when setting the response slope to FLAT, as speaker damage may result. With this unit, a message is displayed when the response slope for the high range speaker is set to FLAT.

5 Repeat steps 3 to 4 to make adjustment to the other bands.

- While adjusting the X-Over, you should consider the frequency response of the connected speakers.
- About the 2.2ch (3WAY)/4.2ch (FRONT/REAR/SUBW.) system You can switch the system mode with the 2.2ch (3WAY)/4.2ch (FRONT/REAR/SUBW.) switch on the PXA-H100. For details, refer to the Owner's Manual of PXA-H100.

Adjusting the Time Correction (Time Correction)

Before performing the following procedures, refer to "About Time Correction" (page 51).

- 1 Touch the title bar of Time Correction.**
The Time Correction adjustment screen appears.
- 2 Touch [◀] or [▶] of the desired speaker to adjust the distance.**
 $L = (\text{distance to farthest speaker}) - (\text{distance to other speakers})$
Refer to "Time Correction Value List" on page 51.
- 3 Repeat steps 1 and 2 to set another speaker.**
By setting these values to make its sound reach the listening position at the same time as the sound of other speakers.

Setting the Time Correction Unit (T.Corr Parameter)

You can change the unit, (cm or inch) of time correction.

Setting item: T.Corr Parameter
Setting contents: cm / Inch

- cm: Time correction value is in cm.
Inch: Time correction value is in inches.

Graphic Equalizer Adjustments (G-EQ)

You can modify the equalizer settings to create a response curve more appealing to your personal taste.

Setting item: G-EQ

- 1 Select L+R by touching [▶] of G-EQ.**
L+R: Sets the same adjustment values for the left and right channels.
When Parametric EQ is adjusted, this setting will be turned OFF.
- 2 Touch the title bar of G-EQ after selecting L+R.**
The G-EQ list screen appears.
- 3 Adjust the G-EQ to your preference.**

Selecting the Band

Touch [◀] or [▶] of Band to select the band to be adjusted.

Band-1 (63 Hz) / Band-2 (150 Hz) / Band-3 (400 Hz) /
Band-4 (1 kHz) / Band-5 (2.5 kHz) / Band-6 (6.3 kHz) /
Band-7 (17.5 kHz)

Adjusting the Level

Touch [◀] or [▶] of Level to adjust the level of selected band.

Adjustable output level: -6 to +6 dB

- 4 To adjust another band, repeat step 3, and then adjust all bands.**

- When Graphic EQ is adjusted, the adjustment for Parametric EQ becomes ineffective.

Adjusting the Parametric Equalizer Curve (P-EQ)

You can modify the Equalizer settings to create a response curve more appealing to your personal taste.

Setting item: P-EQ

- 1 Select L+R by touching [▶] of P-EQ.**
L+R: Sets the same adjustment values for the left and right channels.
When Graphic EQ is adjusted, this setting will be turned OFF.
- 2 Touch the title bar of P-EQ after selecting L+R.**
The P-EQ list screen appears.
- 3 Adjust the P-EQ to your preference.**

Selecting the Band

Touch [◀] or [▶] of Band to select the band to be adjusted.

Band 1 / Band 2 / Band 3 / Band 4 / Band 5

Adjusting the Frequency

Touch [◀] or [▶] of Freq. to adjust the frequency of the selected band.

Adjustable frequency bands: 20 Hz to 20 kHz (in 1/3 octave steps)

Band-1: 20 Hz~80 Hz (63 Hz)
Band-2: 50 Hz~200 Hz (150 Hz)
Band-3: 125 Hz~3.2 kHz (400 Hz)
Band-4: 315 Hz~8 kHz (1 kHz)
Band-5: 800 Hz~20 kHz (2.5 kHz)

Adjusting the Level

Touch [◀] or [▶] of Level to adjust the level of selected band.

Adjustable level: -6 to +6 dB

Setting the Bandwidth

Touch [◀] or [▶] of Q to select the bandwidth.

Adjustable bandwidth: 1, 1.5, 3

- 4 To adjust another band, repeat step 3 and adjust all bands.**

- When the Parametric EQ is adjusted, the adjustment for Graphic EQ becomes ineffective.
- The frequencies of adjacent bands cannot be adjusted within 4 steps.
- While adjusting the Parametric EQ, you should consider the frequency response of the connected speakers.

Equalizer Presets (F-EQ)

10 typical equalizer settings are preset at the factory for a variety of musical source material.

Setting contents: F-EQ

1 Touch the title bar of F-EQ.

The F-EQ list screen appears.

2 Touch [◀] or [▶] of the desired type to set to ON.

Flat / Pops / Rock / News / Jazz&Blues / Electrical Dance / Hip Hop&Rap / Easy Listening / Country / Classical / User1 / User2 / User3 / User4 / User5 / User6

- Only one type can be set to ON.
- By selecting User 1 to 6, you can recall the stored preset number in “Graphic Equalizer Adjustments (G-EQ)” (page 49) or “Adjusting the Parametric Equalizer Curve (P-EQ)” (page 49).

Setting the Response Slope for the High Range Speaker (TW Setup)

Depending on the response characteristics of the speaker, care should be taken when setting the response slope of the high range speaker to FLAT in 2.2ch (3WAY) mode (see “Adjusting the Crossover Settings (X-Over)” on page 48), as speaker damage may result.

Setting item: TW Setup

Touch [◀] or [▶] of TW Setup to select Factory's or User's.

Factory's: As protection from possible speaker damage, FLAT cannot be set for the response slope of the high range speaker in 2.2ch (3WAY) mode.

User's: The FLAT setting is possible in 2.2ch (3WAY) mode.

- Only if the 2.2ch (3WAY) switch is toggled between 4.2ch (FRONT/ REAR/SUBW.) and 2.2ch (3WAY) on the IMPRINT audio processor (PXA-H100), you can select the TW Setup mode.

Storing Settings in the Memory

Adjustment or setting contents of X-Over, Time Correction and P-EQ, etc. can be stored.

Contents that can be stored vary depends on the IMPRINT audio processor used.

1 Check whether the Defeat mode is OFF.

2 Touch [MEMORY] on the A.Processor list display.

3 Within 5 seconds, touch any one of the preset buttons [P.SET 1] through [P.SET 6] on the A.Processor list screen.

The setting contents are stored.

- The stored contents will not be deleted even when the battery power cord is detached.
- This operation cannot be performed when a typical equalizer setting (e.g. pops) is selected in “Equalizer Presets (F-EQ)” (page 50).

Calling up the Preset Memory

1 Check whether the Defeat mode is OFF.

2 Touch any one of the preset buttons [P.SET 1] through [P.SET 6] on the A.Processor list display to select the preset memory.

- You can adjust this setting in main source screen by touching [⏮] directly.
- It takes a few moment to recall the preset memory.

About Time Correction

The distance between the listener and the speakers in a car vary widely due to the complex speaker placement. This difference in the distances from the speakers to the listener creates a shift in the sounds image and frequency characteristics. This is caused by the time delay between the sound reaching the listener's right versus the left ear.

To correct this, this unit is able to delay the audio signal to the speakers closest to the listener. This effectively creates a perception of increased distance for those speakers. The listener can be placed at an equal distance between the left and right speakers for optimum staging. The adjustment will be made for each speaker in 3.4cm steps.

Example 1. Listening Position: Front Left Seat

Adjust the time correction level of the front left speaker to a high value and the rear right to a low value.

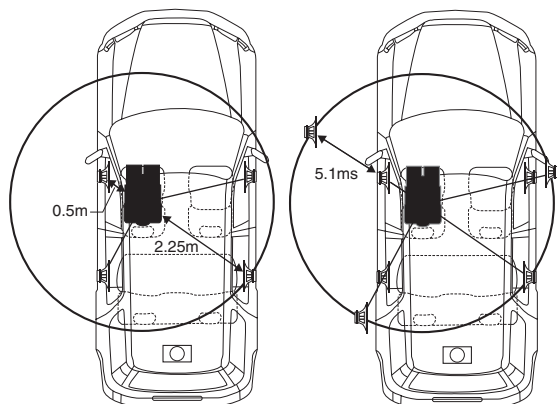

The sound is not balanced because the distance between the listening position and the various speakers is different. The difference in distance between the front left speaker and the rear right speaker is 1.75 m (68-7/8"). Here we calculate the time correction value for the front left speaker in the diagram on the above.

Conditions:

Farthest Speaker – listening position : 2.25 m (88-9/16")

Front left speaker – listening position : 0.5 m (19-11/16")

Calculation: $L = 2.25\text{ m} - 0.5\text{ m} = 1.75\text{ m}$ (68-7/8")

Time correction = $1.75 \div 343^{*1} \times 1000 = 5.1$ (ms)

**1 Speed of sound: 343 m/s (765 mph) at 20°C*

In other words, giving the front left speaker a time correction value of 5.1 ms makes it seem as if its distance from the listener is the same as the distance to the farthest speaker.

Time correction eliminates the differences in the time required for the sound to reach the listening position.

The time of the front left speaker is corrected by 5.1 ms so that its sound reaches the listening position at the same time as the sound of other speakers.

Example 2. Listening Position: All Seats

Adjust the time correction level of each speaker to almost the same level.

- 1** Sit in the listening position (driver's seat, etc.) and measure the distance (in meters) between your head and the various speakers.
- 2** Calculate the difference between the distance correction value to the farthest speaker and the other speakers.

$L = (\text{distance to farthest speaker}) - (\text{distance to other speakers})$

These values are the time correction values for the different speakers. Setting these values to make each sound reach the listening position at the same time as the sound of other speakers.

Time Correction Value List

Delay Number	Time Difference (ms)	Distance (cm)	Distance (inch)	Delay Number	Time Difference (ms)	Distance (cm)	Distance (inch)
1	0.0	0.0	0.0	51	5.0	170.0	67.0
2	0.1	3.4	1.3	52	5.1	173.4	68.3
3	0.2	6.8	2.7	53	5.2	176.8	69.7
4	0.3	10.2	4.0	54	5.3	180.2	71.0
5	0.4	13.6	5.4	55	5.4	183.6	72.4
6	0.5	17.0	6.7	56	5.5	187.0	73.7
7	0.6	20.4	8.0	57	5.6	190.4	75.0
8	0.7	23.8	9.4	58	5.7	193.8	76.4
9	0.8	27.2	10.7	59	5.8	197.2	77.7
10	0.9	30.6	12.1	60	5.9	200.6	79.1
11	1.0	34.0	13.4	61	6.0	204.0	80.4
12	1.1	37.4	14.7	62	6.1	207.4	81.7
13	1.2	40.8	16.1	63	6.2	210.8	83.1
14	1.3	44.2	17.4	64	6.3	214.2	84.4
15	1.4	47.6	18.8	65	6.4	217.6	85.8
16	1.5	51.0	20.1	66	6.5	221.0	87.1
17	1.6	54.4	21.4	67	6.6	224.4	88.4
18	1.7	57.8	22.8	68	6.7	227.8	89.8
19	1.8	61.2	24.1	69	6.8	231.2	91.1
20	1.9	64.6	25.5	70	6.9	234.6	92.5
21	2.0	68.0	26.8	71	7.0	238.0	93.8
22	2.1	71.4	28.1	72	7.1	241.4	95.1
23	2.2	74.8	29.5	73	7.2	244.8	96.5
24	2.3	78.2	30.8	74	7.3	248.2	97.8
25	2.4	81.6	32.2	75	7.4	251.6	99.2
26	2.5	85.0	33.5	76	7.5	255.0	100.5
27	2.6	88.4	34.8	77	7.6	258.4	101.8
28	2.7	91.8	36.2	78	7.7	261.8	103.2
29	2.8	95.2	37.5	79	7.8	265.2	104.5
30	2.9	98.6	38.9	80	7.9	268.6	105.9
31	3.0	102.0	40.2	81	8.0	272.0	107.2
32	3.1	105.4	41.5	82	8.1	275.4	108.5
33	3.2	108.8	42.9	83	8.2	278.8	109.9
34	3.3	112.2	44.2	84	8.3	282.2	111.2
35	3.4	115.6	45.6	85	8.4	285.6	112.6
36	3.5	119.0	46.9	86	8.5	289.0	113.9
37	3.6	122.4	48.2	87	8.6	292.4	115.2
38	3.7	125.8	49.6	88	8.7	295.8	116.6
39	3.8	129.2	50.9	89	8.8	299.2	117.9
40	3.9	132.6	52.3	90	8.9	302.6	119.3
41	4.0	136.0	53.6	91	9.0	306.0	120.6
42	4.1	139.4	54.9	92	9.1	309.4	121.9
43	4.2	142.8	56.3	93	9.2	312.8	123.3
44	4.3	146.2	57.6	94	9.3	316.2	124.6
45	4.4	149.6	59.0	95	9.4	319.6	126.0
46	4.5	153.0	60.3	96	9.5	323.0	127.3
47	4.6	156.4	61.6	97	9.6	326.4	128.6
48	4.7	159.8	63.0	98	9.7	329.8	130.0
49	4.8	163.2	64.3	99	9.8	333.2	131.3
50	4.9	166.6	65.7	100	9.9	336.6	132.7

About the Crossover

Crossover (X-Over):

This unit is equipped with an active crossover. The crossover limits the frequencies delivered to the outputs. Each channel is controlled independently. Thus, each speaker pair can be driven by the frequencies for which they have been optimally designed.

The crossover adjusts the HPF (high pass filter) or LPF (low pass filter) of each band, and also the slope (how fast the filter rolls off the highs or lows).

Adjustments should be made according to the reproduction characteristics of the speakers. Depending on the speakers, a passive network may not be necessary. If you are unsure about this point, please consult your authorized Alpine dealer.

4.2ch (FRONT/REAR/SUBW.) mode

	Cut-off frequency (1/3 octave steps)		Slope		Level
	HPF	LPF	HPF	LPF	
Low range speaker	----	20 Hz - 200 Hz	----	FLAT, 6, 12, 18, 24 dB/oct.	0 to -12 dB
Rear high range speaker	20 Hz - 200 Hz	----	FLAT, 6, 12, 18, 24 dB/oct.	----	0 to -12 dB
Front high range speaker	20 Hz - 200 Hz	----	FLAT, 6, 12, 18, 24 dB/oct.	----	0 to -12 dB

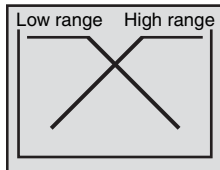

(Different from actual display)

2.2ch (3WAY) mode

	Cut-off frequency (1/3 octave steps)		Slope		Level
	HPF	LPF	HPF	LPF	
Low range speaker	----	20 Hz - 200 Hz	----	FLAT, 6, 12, 18, 24 dB/oct.	0 to -12 dB
Mid range speaker	20 Hz - 200 Hz	20 Hz - 20 kHz	FLAT, 6, 12, 18, 24 dB/oct.	FLAT, 6, 12, 18, 24 dB/oct.	0 to -12 dB
High range speaker	1 kHz - 20 kHz, (20 Hz ~ 20 kHz)*	----	FLAT* 6, 12, 18, 24 dB/oct.	----	0 to -12 dB

* Only when selecting User's in "Setting the Response Slope for the High Range Speaker (TW Setup)" (page 50).

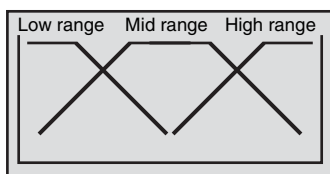

(Different from actual display)

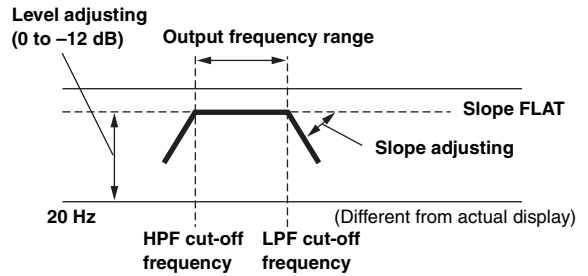

- **HPF (high pass filter):** Cuts the lower frequencies and allows the higher frequencies to pass.
 - **LPF (low pass filter):** Cuts the higher frequencies and allows the lower frequencies to pass.
 - **Slope:** The level change (in dB) for a frequency change of one octave.
 - The higher the slope value, the steeper the slope becomes.
 - Adjust the slope to FLAT to bypass the HP or LP filters.
 - Do not use a tweeter without the HPF on or set to a low frequency, as it may cause damage to the speaker due to the low frequency content.
 - You cannot adjust the crossover frequency higher than the HPF or lower than the LPF.
 - Adjustment should be made according to the recommended crossover frequency of the connected speakers. Determine the recommended crossover frequency of the speakers. Adjusting to a frequency range outside that recommended may cause damage to the speakers. For the recommended crossover frequencies of Alpine speakers, refer to the respective Owner's Manual.
- We are not responsible for damage or malfunction of speakers caused by using the crossover outside the recommended value.

External Audio Processor Operation (Optional)

A compatible, external audio processor is operable from this unit when connected. Some audio processors may require a wired controller. The explanations below use the PXA-H700/PXA-H701 as an example. Refer to the operating instructions of the audio processor for more details.

- The adjustments or settings performed on the connected audio processor cannot be operated properly from this unit.
- The setting "Setting the Speakers", "Setting Bass Sound Control", and "Graphic Equalizer Adjustments" are not available if the MRA-D550 is connected. Additionally, if the MRA-F350 is connected, the following setting "Setting the MX mode" is not available. Also, the setting content differs between the PXA-H700 and PXA-H701.
- This unit cannot be connected to the PXA-H510 and PXA-H900.

The Parking Brake must be engaged to access the Audio Processor mode screen. Attempting to access this screen while driving will display the warning-Can't operate while driving.

Adjustment Procedure for Dolby Surround

Make the adjustments described below in order to reproduce Dolby Digital and DTS sound with greater accuracy.

Adjustment procedure

- 1 Speaker Setup (page 57)**
(Turning the speakers to be used on and off and setting their response)
- 2 Adjusting the speaker levels (page 57)**
(Adjusting the signal output level to the various speakers)
- 3 Mixing bass sound to the rear channel (page 57)**
(Achieving smooth sound in the rear seat by mixing the front audio signals with the rear speaker signals)

- 4 Adjusting the acoustic image (page 57)**
(Adjusting the acoustic image to achieve a sound as if the centre speaker were directly in front of the listener)
- 5 Achieving powerful high volume sound (page 57)**
(Achieving energetic sound with even greater power, like the sound in a movie theater)
- 6 Adjusting the DVD Level (page 58)**
(Adjust the volume (signal level) in the Dolby Digital, Pro Logic II, DTS and PCM modes.)
- 7 Storing Settings in the Memory (page 58)**
(Storing all the settings and adjustments made on the IVA-D511RB/IVA-D511R (not only the above settings/adjusts) in the memory)

In case of combining the Automatic adjustments, etc.

We recommend to make the Automatic adjustments before the Dolby Surround adjustments.

Setting the External Audio Processor

Following Steps 1 to 5 describe the common procedures for operating the Audio Processor setting function. For details of the setting function items, refer to descriptions of respective items.

- 1 Check the Defeat mode is OFF (page 31), and then touch [] on the main screen.**
The SETUP selection screen is displayed.
- 2 Touch the title bar of Audio Setup.**
The Audio Setup screen appears.
- 3 Touch the title bar of A.Processor.**
The A.Processor list screen appears.
- 4 Touch [◀], [▶] or the title bar of the desired item to change its setting.**

Setting items :

Media Xpander / Bass Sound Cont. / Dolby PLII / Rear Fill / X-Over / Time Correction / Phase / G-EQ / P-EQ / Speaker Select / Multi Ch Setup / Speaker Setup / DVD Level / PCM Mode

- 5 Touch [↶] to return to the previous screen.**

Set MX Mode of the External Audio Processor

Before performing the operations below, set MX (Media Xpander) mode of the PXA-H700 to "AUTO" when the PXA-H700 is connected.

Setting item : Media Xpander

1 Select ON or OFF of MX by touching [◀] or [▶] of Media Xpander.

OFF: Turns off the MX effect of every music source.
ON: Turns on the specified MX mode.

2 Touch the title bar of Media Xpander after setting to ON.

The Media Xpander setup screen appears.

3 Touch [◀] or [▶] of the desired MX mode.

- Music source (such as CDs, iPod) level can be set.

MX CD (OFF, CD MX 1 to 3)

CD mode processes a large quantity of data. This data is used to reproduce the sound cleanly by making use of the data quantity.

MX CPM (OFF, CPM MX 1 to 3)

This corrects information that was omitted at the time of compression. This reproduces a well-balanced sound close to the original.

MX DVD (OFF, Movie MX 1 to 2)

The dialogue portion of the video is reproduced more clearly. (DVD Music)

This disc contains a large quantity of data such as music clip. MX uses this data to reproduce the sound accurately.

MX AUX (OFF, CPM MX, Movie MX, Music MX)

Choose the MX mode (CPM, Music, or Movie) that corresponds to the media connected.

- The contents of MX set here is reflected to PXA-H700 or PXA-H701.
- When OFF is selected, MX effect of each MX mode will be OFF.
- Each music source, such as CD, and MP3 can have its own MX setting.
- There is no MX mode for FM, MW and LW radio.
- MX CPM is applied for MP3/WMA/AAC and iPod/iPhone.
- The MX setting can be performed only when a source is currently selected.
- This function is inoperable when Defeat is set to ON.
- You can adjust this setting in main source screen by touching [🔊] directly.

Setting Bass Sound Control

Setting item: Bass Sound Cont.

Setting Bass Compressor

You can adjust the sound of low frequencies as desired.

Touch [◀] or [▶] of Bass Comp. to select the desired mode.

Bass sound is emphasized more as the mode is sequentially switched as Mode 1 → 2 → 3, offering you vivid low frequencies.

Select OFF when the setting is not necessary.

Setting Bass Focus

Using the previously specified delay number (time difference) allows you to set a time difference between the front-rear/left-right speakers. Namely, it enables a time correction based on your preference. With an initial delay of 0.05 ms for each of the 0 to 400 steps, audible time correction can be achieved.

Set the delay number in the front and rear, and on the right and left of the desired speaker by touching the respective [◀] or [▶] button.

- Any setting in Bass Focus is applied in time correction, too (page 55).

Using the Pro Logic II Mode

Pro Logic processing can be conducted on the music signals recorded on two channels to achieve Dolby Pro Logic II surround sound. For two-channel Dolby Digital and DTS signals, there is also a "Rear Fill" function for outputting the signals of the front channel to the rear channel.

Setting item: Dolby PLII/Rear Fill

Touch [◀] or [▶] of Dolby PLII/Rear to select the desired mode.

PL II Movie: Suits the stereo TV shows and all programmes encoded in Dolby Surround. It improves the sound field directivity to near that of discrete 5.1-channel sound.

PL II Music: Can be used for all stereo music recordings, and provides a wide, deep sound field.

OFF: Turns Dolby PL II function to OFF.

If PL II Music is selected, the centre width can be adjusted with following operations.

This function offers the optimum vocal position by adjusting the centre channel position between the centre speaker and the L/R speaker. (The adjustments established in "Adjusting the acoustic image (Bi-Phantom)" (page 57) are ineffective while this function is activated.)

Touch [◀] or [▶] of Center Width Cont. to adjust the level.

The level can be adjusted between 0 to +7. When the level increases, the centre channel position moves from the centre speaker position to both sides.

Touch [Off] of Center Width Cont. to turn off the centre width control.

- This adjustment is effective when the setting of the centre speaker is Small or Large in the Speaker Setup (page 57).
- "Rear Fill" function:
Depending on the input signals, the sound may only be output from the front speakers. In this case, the "Rear Fill" function can be used to output signals from the rear speakers as well.
- Avoid stopping, pausing, switching the disc, cueing, fast-forwarding or switching the audio channel of this unit while making this adjustment. The setting is cancelled if the Decode mode is switched.
- This adjustment is ineffective when the speaker is set Center to OFF in "Setting the Speakers" (page 56).
- This function only works with two-channel signals. This operation is ineffective when 5.1-channel DTS or Dolby Digital signals are input.
- If the setting of Rear Fill is made when Rear Mix is ON, sound is unchanged in the Rear Fill setting because Rear Mix is given priority during 2 channel decoder other than linear PCM.
- For linear PCM signals, the voice is output from the rear speaker regardless of the Rear Fill and Rear Mix setting.

X-OVER Adjustment

Setting item: X-Over

1 Touch [◀] or [▶] of X-Over to select L+R or L/R.

L+R: Sets the same adjustment values for the left and right channels.

L/R: Different adjustment values can be set for the left and right channels.

2 Touch the title bar of X-Over.

A speaker list on the X-Over screen is displayed.

3 Touch the title bar of the speaker to be adjusted.

The screen changes to the X-Over screen to be adjusted.

4 Adjust the crossover to your preference.

Selecting the Cut-Off Frequency

Touch [◀] or [▶] of Freq., then select the cut-off frequency (crossover point).

The adjustable bandwidth differs depending on the speaker (channel).

Adjusting the Level

Touch [◀] or [▶] of Level, then adjust the HPF or LPF level.

Adjusting the Slope

Touch [◀] or [▶] of Slope, then adjust the HPF or LPF slope.

- When the speaker is set to the "OFF" mode, the X-Over for that speaker cannot be set. Refer to "Setting the Speakers" (page 56).
- Check the playback frequencies of the connected speakers before adjusting.
- In order to protect the speakers, there is no OFF setting for the subwoofer low pass filter (the slope remains the same).
- The HPF cannot be set Slope to OFF if Tweeter (TW) is selected for Front1. Or, only the subwoofer is adjustable if Stereo is selected for the subwoofer.

Performing Time Correction Manually (Time Correction)

Because of the particular conditions inside the vehicle, there can be major differences in the distances between the various speakers and the listening position. It is possible to calculate the optimum correction values and eliminate the time error at the listening position yourself using this function.

Setting item: Time Correction

1 Sit in the listening position (the driver's seat, for example) and measure the distance (in meters) between your head and the various speakers.

2 Calculate the difference in distance between the farthest speaker and the other speakers.

$$L = (\text{distance of farthest speaker}) - (\text{distance of other speakers})$$

3 Divide the distances calculated for the different speakers by the speed of sound (343 m/s temperature 20°C).

This value is the time correction value for the various speakers.

Concrete examples

Calculating the time correction value for the front left speaker on the diagram below.

Conditions:

Distance between farthest speaker and listening position:

$$2.25 \text{ m (88-3/4")}$$

Distance between front left speaker and listening position:

$$0.5 \text{ m (20")}$$

Calculation:

$$L = 2.25 \text{ m (88-3/4")} - 0.5 \text{ m (20")} = 1.75 \text{ m (68-3/4")}$$

$$\text{Compensation time} = 1.75 \div 343 \times 1000 = 5.1 \text{ (ms)}$$

In other words, setting the time correction value for the front left speaker to 5.1 (ms) sets a virtual distance matching the distance to the farthest speaker.

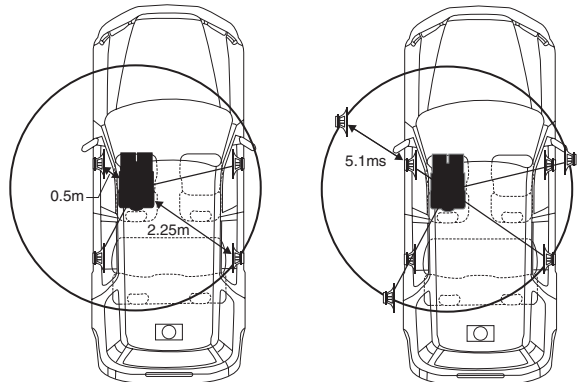

The sound is uneven because the distance between the listening position and the different speakers is different. The difference in the distance between the front left and rear right speakers is 1.75 meters (68-3/4").

Time correction eliminates the difference between the time required for the sound from the different speakers to reach the listening position. Setting the time correction of the front left speaker to 5.1 ms makes it possible to coordinate the distance from the listening position to the speaker.

4 Touch [◀] or [▶] of Time Correction.

Select L+R or L/R.

L+R: Sets the same adjustment values for the left and right channels.

L/R: Different adjustment values can be set for the left and right channels.

5 Touch the title bar of Time Correction.

The T.CORR adjustment screen appears.

6 Adjust the time correction value (0.00 ~ 20.00ms) of a desired speaker by touching the respective [◀] or [▶] button (1 step = 0.05ms).

- When the speaker is set to the "OFF" mode, the TCR for that speaker cannot be set. Refer to "Setting the Speakers" (page 56).
- The adjustment value for Front2 (Speakers) which is adjusted in time correction, is also applied to the front speakers in "Setting Bass Focus" (page 54).
- The adjustment (AUTO TCR) cannot be automatically set on this unit.

Phase Switching

Setting item: Phase

Switch the phase (0° or 180°) by touching [◀] or [▶] of the desired speaker.

Graphic Equalizer Adjustments

The graphic equalizer allows you to modify the sound using 31 bands each for the front (left and right), rear (left and right) and centre speakers. An additional 10 bands are available for the subwoofer. This allows you to customize the sound to suit your taste.

Setting item: G-EQ

1 Select L+R or L/R by touching [◀] or [▶] of G-EQ.

L+R: Sets the same adjustment values for the left and right channels.

L/R: Different adjustment values can be set for the left and right channels.

When parametric EQ is adjusted, this setting will be turned off.

2 Touch the title bar of G-EQ.

The G-EQ list screen appears.

3 Touch the title bar of the desired speaker (channel).

The G-EQ adjustment screen appears.

4 Adjust the G-EQ to your preference.

Adjusting the Level

Touch [◀] or [▶] of the desired frequency to adjust the level.

- When the speaker is set to the "OFF" mode, the graphic equalizer for that speaker cannot be set. Refer to "Setting the Speakers" (page 56).
- Check the playable frequency ranges of the connected speakers before making the equalizer adjustments. If the speaker's playable frequency range is 55 Hz to 30 kHz, for example, adjusting the 40 Hz or 20 Hz band has no effect. Additionally, you may overload and damage the speakers.
- When Graphic EQ is adjusted, the adjustment for Parametric EQ becomes ineffective.

Parametric Equalizer Adjustments

The frequency bands of the graphic equalizer are fixed. This makes it very difficult to correct for undesired peaks and dips at specific frequencies. The parametric equalizer's centre frequency can be tuned to these specific frequencies. Then, the bandwidth (Q) and level are fine-tuned, independently, to make the necessary corrections. The parametric equalizer function is an advanced tool for serious audiophiles.

Setting item: P-EQ

1 Select L+R or L/R by touching [◀] or [▶] of P-EQ.

L+R: Sets the same adjustment values for the left and right channels.

L/R: Different adjustment values can be set for the left and right channels.

When Graphic EQ is adjusted, this setting will be turned off.

2 Touch the title bar of P-EQ.

The P-EQ list screen appears.

3 Touch the title bar of the desired speaker (channel).

The P-EQ adjustment screen appears.

4 Adjust the P-EQ to your preference.

Selecting the Band

Touch [◀] or [▶] of Band to select the desired band.

Adjusting the Frequency

Touch [◀] or [▶] of Freq. to adjust the frequency of the selected band.

Adjusting the Level

Touch [◀] or [▶] of Level to adjust the level of the selected band.

Setting the Bandwidth

Touch [◀] or [▶] of Q to select the bandwidth.

- When the speaker is set to the "OFF" mode, the parametric equalizer for that speaker cannot be set. Refer to "Setting the Speakers" (page 56).
- It is not possible to adjust the frequencies of adjacent bands within 7 steps.
- Check the playable frequency ranges of the connected speakers before making the equalizer adjustments. If the speaker's playable frequency range is 55 Hz to 30 kHz, for example, adjusting the 40 Hz or 20 Hz band has no effect. Additionally, you may overload and damage the speakers.
- When the Parametric EQ is adjusted, the adjustment for Graphic EQ becomes ineffective.

Setting the Speakers

Setting item: Speaker Select

Set the connected speaker by touching the respective [◀] or [▶] button.

Front1:	OFF/Full (Full Range)/TW (Tweeter)
Front2:	OFF/ON
Rear:	OFF/ON
Center:	OFF/ON
Subw.:	OFF/Mono/Stereo

- Set the speaker which is not connected to OFF.
- Settings above can be carried out even when the speaker is set to OFF in "Speaker Setup" (page 57).
- To use the subwoofer in Mono with PXA-H700 or PXA-H701 connected, connect the subwoofer to the subwoofer output terminal of PXA-H700 or PXA-H701.

Setting of Dolby Digital

Setting item: Multi Ch Setup

Adjusting the acoustic image (Bi-Phantom)

In most installations, the centre speaker must be placed directly between the front passenger and driver. Using this function, the centre channel information is distributed to the left and right speakers. This creates an acoustic image simulating a centre speaker directly in front of each listener. Adjusting the centre width in PL II Music (see "Using the Pro Logic II Mode" on page 54), makes this function ineffective.

- *Avoid stopping, pausing, switching the disc, cueing, fast-forwarding or switching the audio channel of this unit while making this adjustment. The setting is cancelled if the Decode mode is switched.*

Touch [◀] or [▶] of Bi-Phantom to adjust the level. The level can be adjusted within the range of -5 to +5. The higher the level, the more the position of the centre speaker is shifted to the sides.

The Bi-Phantom function is turned off by touching [Off].

- *This adjustment is effective when the setting of the centre speaker to Small or Large in the speaker setup settings.*
- *This adjustment is ineffective when the speaker is set Center to OFF in "Setting the Speakers" (page 56).*

Mixing bass sound to the rear channel (Rear Mix)

This function mixes the front channel audio signals to the audio signals output from the rear speakers, improving the sound in the vehicle's rear seat.

- *Avoid stopping, pausing, switching the disc, cueing, fast-forwarding or switching the audio channel of this unit while making this adjustment. The setting is cancelled if the Decode mode is switched.*

Touch [◀] or [▶] of Rear Mix to adjust the level. The level can be adjusted in five steps: -6, -3, ±0, +3 and +6. The higher the level, the more bass is output from the rear speakers. (The effect differs according to the software (DVD, etc.))
The Rear Mix function is turned off by touching [Off].

- *This adjustment is ineffective when the rear speaker setup setting is set to "OFF".*
- *For linear PCM signals, the voice is output from the rear speaker regardless of the Rear Fill and Rear Mix setting.*

Achieving powerful high volume sound (Listening Mode)

With Dolby Digital, the dynamic range is compressed so that powerful sound can be achieved at regular volume levels. This compression can be cancelled to achieve an energetic sound with even greater power, like the sound in a movie theater. This function works only in the Dolby Digital mode.

Touch [◀] or [▶] of Listening Mode to select STD or MAX.

STD: For powerful sound at regular volume levels

MAX.: For powerful sound at high volumes

- *Keep the volume to a level at which sounds outside the vehicle can still be heard.*

Adjusting the speaker levels (Output Level)

The test tones help to make the volume adjustments of the different speakers. When levels are equal, a strong sense of presence can be heard from the different speakers at the listening position.

- *Avoid stopping, pausing, switching the disc, cueing, fast-forwarding or switching the audio channel of this unit while making this adjustment. The setting is cancelled if the decode mode is switched.*

1 Touch [On] of Output Level.

Test tone output is repeated for each of the different speaker channels. They will be repeated in the order shown below. If no operation is performed for 2 seconds, the channel switches to the next channel.

Left → Centre → Right → Right Surround →
Left Surround → Left

2 While the test tone is being produced from the speakers, touch [◀] or [▶] of Output Level balance the output from all the speakers.

- The adjustment range for the different speakers is -10 dB - +10 dB.
- Adjust based on the front speakers.

3 Touch [On] again to turn off.

- *If a speaker is set to off mode, that speaker's level adjustment cannot be made. Refer to "Speaker Setup" (page 57).*

Speaker Setup

The PXA-H700 or PXA-H701 can be set according to the playable frequency range of your speakers.

Check the playable frequency range of the speakers (not including the subwoofer) before performing this operation to verify whether the speakers can play low frequencies (of about 80 Hz or less).

- *Avoid stopping, pausing, switching the disc, cueing, fast-forwarding or switching the audio channel of this unit while making this adjustment. The setting is cancelled if Decode mode is switched.*

Setting item: Speaker Setup

Select the speaker characteristic by touching [◀], [▶] of the desired speaker setting.

OFF*¹: When no speaker is connected.

Small: When a speaker that cannot play low frequencies (80 Hz or less) is connected.

Large*²: When a speaker that can play low frequencies (80 Hz or less) is connected.

*¹ It is not possible to set the front speakers to "OFF".

*² If the front speakers are set to "Small", the rear and centre speakers cannot be set to "Large".

- *The subwoofer can be set only to ON/OFF.*
- *If the centre speaker is turned "OFF", the centre channel's audio signals are added to the audio signals output from the front speakers.*
- *If you set the speaker response to "OFF", also set the speaker setting to "OFF" (page 56).*
- *Perform the setup for all the speakers ("Front", "Centre", "Rear" and "Subwoofer"). If not, the sound may not be balanced.*
- *When centre is set to "OFF", the setting is ineffective even if centre is set with this function.*
- *Through changing the settings on each speaker, a change in the output of the other speakers may occur due to the setting requirements.*
- *When using the PRO Logic II, if the rear speaker is set to "Large", then there will be no output from the subwoofer.*

Adjusting the DVD Level

The volume (signal level) for Dolby Digital, Dolby PL II, DTS and PCM modes can be set.

- *Avoid stopping, pausing, switching the disc, cueing, fast-forwarding or switching the audio channel of this unit while making this adjustment. The setting is cancelled if the Decode mode is switched.*

Setting item: DVD Level

Adjust the level by touching [◀] or [▶] of the desired adjusting mode.

Linear PCM Setting

The output when playing discs recorded in linear PCM can be set to 2 or 3 channels.

Setting item: PCM Mode

Touch [◀] or [▶] of PCM Mode to select 2CH or 3CH.

2CH: 2ch output (L/R)

3CH: 3ch output (L/R/CENTRE)

- *This adjustment is ineffective when the speaker is set Center to OFF in "Setting the Speakers" (page 56).*

Storing Settings in the Memory

Adjustment or setting contents can be stored.

Contents that can be stored vary depends on the audio processor used.

1 Touch [MEMORY] on the A.Processor list display.

2 Within 5 seconds, touch any one of the preset buttons [P.SET 1] through [P.SET 6] on the A.Processor list screen.

The setting contents are stored.

- *The stored contents will not be deleted even when the battery power cord is detached.*

Calling up the Preset Memory

Touch any one of the preset buttons [P.SET 1] through [P.SET 6] on the A.Processor list display to select the preset memory.

- *You can adjust this setting in main source screen by touching [◀] directly.*
- *It takes a few moments to call up the preset memory.*

BLUETOOTH Operation (Optional)

When the optional BLUETOOTH INTERFACE (KCE-400BT) is connected to this unit, the following operation can be performed.

Setup Before Using

About BLUETOOTH

BLUETOOTH is a wireless technology allowing communication between a mobile device or personal computer over short distances. This enables a hands-free call or data transmission between BLUETOOTH compatible devices. BLUETOOTH transmission is available in the unlicensed 2.4 GHz spectrum if the distance between devices is within 10 meters. For details, refer to the BLUETOOTH Home page (<http://www.BLUETOOTH.com/>).

- *Depending on the BLUETOOTH version, a BLUETOOTH compatible device may not be able to communicate with this unit.*
- *Proper function of this unit with all BLUETOOTH compatible devices is not guaranteed. For handling of the BT compatible device, consult your ALPINE dealer or ALPINE website.*
- *Depending on the surroundings, BLUETOOTH wireless connection may be unstable.*
- *When you place a call, or perform setup operations, be sure to stop your car in a safe place.*
- *Depending on the connected BLUETOOTH compatible device(s), the function may differ. Also refer to the Owner's Manual of the connected device(s).*

Before Using Hands-Free Function

Before using the hands-free phone/audio function, the following settings need to be made.

1 Set "BLUETOOTH IN" to Adapter (page 46).

2 Turn the ignition key off (ACC OFF) and on again (ACC ON).

- *Before using a hands-free phone, it must be paired with this unit. Refer to "BLUETOOTH Setup" (pages 59-60).*

How to connect to a BLUETOOTH compatible device (Pairing)

For details on the control from a BLUETOOTH compatible device, refer to the Owner's Manual of the BLUETOOTH compatible device.

- 1 Set a BLUETOOTH connection from a BLUETOOTH compatible device.**
- 2 The PIN code ("0000") is displayed on the unit.**
- 3 Input the PIN code ("0000") in a BLUETOOTH compatible device.**
- 4 If this unit is successfully connected to a BLUETOOTH compatible device, "Connected/(Device name)" is displayed, and then the unit returns to normal mode.**

- Set "Setting the Search Mode" (page 60) to Visible Mode ON to enable this unit to recognize a mobile phone. For mobile phone passkey (passcode) input operation, refer to the mobile's Owner's Manual. Additionally, the mobile phone can be searched directly from this unit. Refer to "Registering the BLUETOOTH Device" (page 59).
- If a BLUETOOTH compatible device is successfully connected, the next time when the ignition key of the car is turned on, the unit will automatically connect to the previously connected device. However, the connection may fail. If the auto connection fails, try the connection manually.

BLUETOOTH Setup

BLUETOOTH Setup Operation

The following steps 1 to 5 are common to the various BLUETOOTH functions. For details, refer to each individual function.

- While calling, or in the BLUETOOTH Audio source, BLUETOOTH Setup operation cannot be performed.
- Set "BLUETOOTH IN" to Adapter (page 46), and then perform BLUETOOTH Setup operation.

- 1 Touch [] on the main source screen.**
The SETUP main screen is displayed.
- 2 Touch the title bar of Source Setup.**
The Source Setup screen appears.
- 3 Touch the title bar of BLUETOOTH Setup.**
The BLUETOOTH Setup screen appears.
- 4 Touch [◀], [▶] or the title bar of the desired item to change its setting.**

Setting items:

Paired Devices / Device Search / Clear Device / Service Provider / Visible Mode / Auto Answer / Speaker Select / MIC Input / Firmware Version / Firmware Update

- 5 Touch [↶] to return to the previous screen.**
Touch [Exit] to return to the main source screen that was displayed before the setup operation was started.

Setting the BLUETOOTH Device

Select one of 5 connected BLUETOOTH compatible devices that you previously registered.

Setting item: Paired Devices

Touch a BLUETOOTH compatible device to use (change connection) from the Paired Device list.

- If the connection is successfully changed, "Connected/(Device name)" is displayed for 2 seconds, and then the display returns to the Setup screen.
- If you input the wrong passcode or communications fail, "Failed" is displayed.
- If you want to connect another BLUETOOTH compatible device, after disconnecting the current BLUETOOTH compatible device, connect the BLUETOOTH compatible device you want to change to.
- The registration number 5 is deleted when you set ignition from ACC to OFF. If all the 5 positions have been registered, you cannot register the 6th device. To register another device, you need to delete one of the devices from position 1 to 5 first.

Registering the BLUETOOTH Device

The BLUETOOTH device is used when a connectable BLUETOOTH compatible device is searched and connected from this unit, or a new BLUETOOTH compatible device is registered.

Setting item: Device Search

- 1 When Device Search is selected, "Now Searching" is displayed, and searching starts.**
- 2 Touch the device name to be connected from the Device Search list.**
- 3 If the adapter is successfully connected to a BLUETOOTH compatible device, a paired device name and a registered number (No. 1 to 5) are displayed, and then the unit returns to normal mode.**

- If a mobile phone is registered for the first time: Input a passcode when the numeric keypad screen is displayed, then input the same passcode in the BLUETOOTH compatible device to make the pairing. After the pairing is completed, the unit will automatically connect to the BLUETOOTH compatible device.
- If you input the wrong passcode or communications fail, "Failed" is displayed.
- A passcode input on the unit is maximum 4-digit. If a passcode on the BLUETOOTH compatible device exceeds 4 digits, reset the passcode and make this setting again.

Deleting a BLUETOOTH Device from the list

You can delete the history of a previously connected BLUETOOTH compatible device.

Setting item: Clear Device

- 1 Touch the BLUETOOTH compatible device you want to delete from the Clear Device list.**
A message is displayed.
- 2 Touch [Yes] if you want to delete.**
 - Touching [No] will cancel the setting.
 - The registration number 5 is deleted once the ignition key goes from ACC to OFF.

Displaying the phone service provider name

Setting item : Service Provider

The service provider name of the connected BLUETOOTH compatible device will be displayed. If a BLUETOOTH compatible device is not connected, "ID UNSENT" will be displayed.

- *Depending on the character type some phone service provider name cannot be displayed.*

Setting the Search Mode

You can set whether KCE-400BT can be recognized or not from a BLUETOOTH compatible device. Normally set this to Visible Mode ON.

Setting item : Visible Mode

- ON: Enables recognition of KCE-400BT from the BLUETOOTH compatible device.
- OFF: Disables recognition of KCE-400BT from the BLUETOOTH compatible device.

- *Depending on the mobile phone, it may be necessary to input a passcode. For inputting the mobile phone's passcode, refer to the mobile phone's Owner's Manual.*

Setting the Received Calls automatically (Auto Answer)

When a call is received, you can set whether to receive it automatically or not.

Setting item : Auto Answer

- ON: When a call is received, it will be taken automatically after about 5 seconds.
- OFF: When a call is received, it will not be received automatically. If a message is displayed and [] is touched when a call is received, you can receive the call.

- *If the received call setting on the mobile phone is on, the call will be answered automatically even though this setting is set to OFF.*

Selecting the output speaker

You can select the connected speaker in car to output the sound signal of telephone.

Setting item : Speaker Select

- All: The sound be output from all of speakers in car.
- F-L: The sound only be output from the front left speaker.
- F-R: The sound only be output from the front right speaker.
- F-LR: The sound be output from the front left and front right speaker.

- *The setting cannot be adjusted during a phone call. Adjust the setting before placing a call.*
- *When an IMPRINT audio processor (PXA-H100) or External Audio processor (PXA-H701, etc.) is connected, the default setting All will be set and cannot be adjusted.*

Adjusting the volume for the microphone input

You can emphasize or weaken the microphone input volume level.

Setting item : MIC Input

Touch [] or [] to select the desired volume level (0 ~ 15).

- *The setting cannot be adjusted during a phone call. Adjust the setting before placing a call.*
- *The setting can be adjusted only when the BLUETOOTH compatible device is connected.*

Displaying the firmware version

Setting item : Firmware Version

The current firmware version of KCE-400BT will be displayed.

Updating the firmware

Setting item : Firmware Update

Future BLUETOOTH firmware update of KCE-400BT (for phone compatibility) at customer end will be available for this unit.

For information to update your BLUETOOTH firmware, please visit your local Alpine web site or choose your country from Alpine Europe top page (<http://www.alpine-europe.com>).

Hands-Free Phone Control

About the Hands-Free Phone

Hands-free calls are possible when using a HSP (Head Set Profile) and HFP (Hands-Free Profile) compatible mobile phone with this unit.

- *Avoid performing a hands-free call in heavy traffic or on narrow or winding streets.*
- *Close the windows while calling to reduce background noise.*
- *If both calling parties are using hands-free devices, or the call is made in a noisy location, difficulty hearing the other person's voice is normal.*
- *Depending on telephone line conditions or certain mobile devices used, voices may sound unnatural.*
- *When using a microphone, speak as directly as you can into the microphone to pick up the best sound quality.*
- *Certain mobile phone features are dependent on the capabilities and settings of your service provider's network. Additionally, certain features may not be activated by your service provider, and/or the provider's network settings may limit the feature's functionality. Always contact your service provider about feature availability and functionality.*
All features, functionality, and other product specifications, as well as the information contained in the Owner's Manual are based upon the latest available information and are believed to be accurate at the time of printing.
Alpine reserves the right to change or modify any information or specifications without notice or obligation.

Answering a Call

Incoming calls are announced by the received call ring tone and a displayed message (Caller name/PHONE No.).

Touch [📞].

The call starts.

- **Indicator 📶 (Signal Strength):**
While calling, the indicator will display the current signal strength of mobile phone. While in the mode other than Calling, the unit cannot read the signal strength of the mobile phone exactly. In this case, the indicator displays the signal strength of last call.
- When "Setting the Received Calls automatically (Auto Answer)" (page 60) is set to ON, you can receive a call automatically.
- While calling, the source sound on the unit is muted.
After calling, playback will resume.

Hanging up the Telephone

Touch [📞].

The call finishes.

Adjusting the volume when receiving a Call

While calling, you can adjust the volume. The adjusted volume level is stored.

Turn the Rotary encoder to adjust the volume.

- *You may need to increase volume from your regular audio listening source level. However, increasing the volume excessively may result in feedback. If feedback is noticed as feedback is directly related to the volume, turn down the volume as low as acceptable to eliminate it. Positioning the microphone in a direction away from the main car speakers (e.g. clipped on sun visor) may also reduce feedback at high volume.*

Redial Function

You can redial the person you have previously called.

After finishing a call, touch [📞] on the screen within 5 seconds.

The telephone is redialed.

Call Switching Operation

While making a call, this function allows you to initiate the transfer of the audio between the mobile phone and the speakers in the car.

While calling, touch [📞] to switch the call sound between the unit and mobile phone.

- Depending on the mobile phone, this operation may not be performed.

Call History

Call History is recorded for the last dialed/received/missed calls. There are various ways of making calls based on the "Call History". The following steps 1 to 3 are common to the various ways of making these calls. For details, refer to each individual category for making calls.

- 1 Check that "Adapter" is selected in "Setting the BLUETOOTH Connection (BLUETOOTH IN)" (page 46).**
- 2 Press SOURCE/📶.**
The SOURCE selection screen is displayed.
- 3 Touch [Phone].**
The Telephone Menu screen is displayed.
- 4 Touch the title bar of the desired item to place the call.**

Setting items:

- Dialed Calls / Received Calls / Missed Calls / Phone Book / Dial Input / Voice Dial
- *The adapter will update the information in the Call History automatically each time a mobile phone is connected or receiving/ dialing a call. At this time, if you select any outgoing mode, "Now Updating" will be displayed.*
- *It may take some time for the list to be displayed, and also directly after connection, the list may not be brought up to date.*
- 5 Touch [🔙] to return to the previous screen.**
Touch [Exit] to return to the main source screen that was displayed before the setup operation was started.
- *If you place a call directly from the paired mobile phone, the phone number is not displayed, you cannot redial from the unit in this case.*

Redialing a Number in Dialed Calls History

Previously dialed telephone numbers are stored in dialed calls history. You can redial a number by searching from dialed calls history.

Setting item: *Dialed Calls*

Touch [Call] of the person name or the telephone number you want to call from the Dialed Calls list.

The call is placed.

Dialing a Number in Received Calls History

Telephone numbers from received calls are stored in the received calls history. You can redial these numbers by searching here.

Setting item: *Received Calls*

Touch [Call] of the person name or the telephone number you want to call from the Received Calls list.

The call is placed.

Dialing a Number in Missed Calls History

Telephone numbers for received calls that are missed, are stored in the missed calls history. You can redial these numbers by searching here.

Setting item: *Missed Calls*

Touch [Call] of the person name or the telephone number you want to call from the Missed Calls list.

The call is placed.

Dialing a Number In the Phone Book (Phone Book)

Up to 1,000 telephone numbers are downloadable to the BLUETOOTH compatible unit from a mobile phone. Dial a call by selecting a person from the phone book list.

Setting item: *Phone Book*

Display example for Phone book screen

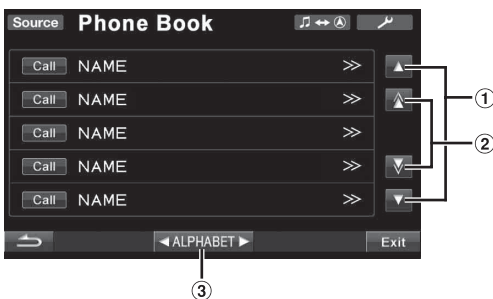

- 1 Scroll the list one line at a time by touching [▲] or [▼].
- 2 Scroll the list one page at a time by touching [▲] or [▼].
- 3 The names in Phone Book are listed alphabetically. The listing can be skipped to the next alphabetical character. e.g. touch ALPHABET [▶] to move to the names beginning with B from those beginning with A. (Only applicable to English alphabetic characters.)

Touch [Call] of the person name or the telephone number you want to call from the Phone Book list.

The call is placed.

- If one name has several numbers registered in the telephone book, choose and touch [Call] of the desired number after touching the name, the telephone will be called. Touch [Call] of the name directly, the default number of the name will be called. Depending on the connected mobile phone, this function may not be performed.
- If a name cannot be obtained via the phone book, only the telephone number (default number) is displayed. If both name and number cannot be obtained, "ID UNSENT" will be displayed.
- If the call history or phonebook of the mobile phone is added or deleted while it is connected to the unit, the list displayed on the unit may not be brought up to date. If it is not updated, you cannot correctly place a call.

Dialing a Number Using Direct Dial Input

You can place a call by inputting the telephone number directly by the numeric keypad screen on the unit.

Setting item: *Dial Input*

Display example for the Dial Input screen

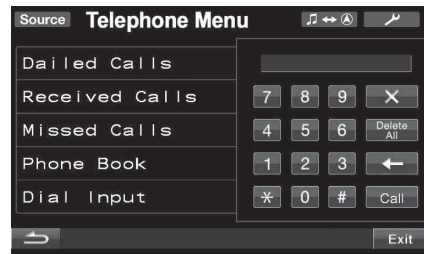

The numeric keypad screen is displayed. Touch (input) the telephone number, and then touch [Call].

The call is placed.

- About the numeric keypad
[X]: closes the numeric keypad input screen.
[Delete All]: deletes all input numbers.
[←]: deletes a previous number.
- The speed dial is recalled and the telephone is called by directly inputting the number which is registered with the speed dial on the mobile phone on the numeric keypad screen of this unit (SPEED DIAL).

Voice Dial Operation

You can call the telephone by performing voice operation.

Setting item: *Voice Dial*

- 1 Touch [▼] to display the item of Voice Dial.
 - 2 Touch the title bar of Voice Dial.
A message is displayed.
 - 3 Touch [Yes] to activate the voice dial mode.
The voice dial mode is activated, and "Speak" is displayed.
- Touch [No] will return to the Telephone Menu screen.
- 4 Say the telephone number*, name* you want to call into the microphone.

* The number and name depend on the voice dial information stored in the mobile phone.

- If the voice dial fails, the unit will return to normal mode in 30 seconds.
- You can perform this operation only when a voice dial compatible mobile phone is connected. If the mobile phone is not compatible with the voice dial, "Failed" is displayed for 2 seconds.
- The Voice Dial function performance depends on the recognition range of the mobile phone and mounting location of the microphone. Note when the microphone is mounted.
- This operation cannot be performed when the current source is BLUETOOTH Audio.
- Voice dial operation depends on the function of the mobile phone. For details, refer to the Owner's Manual of the mobile phone.

BLUETOOTH Audio Function

BLUETOOTH Audio Operation

Audio information of a BLUETOOTH compatible mobile phone, a portable player, etc., is controllable/playable wirelessly* from this unit.

* To play back audio, a mobile phone or a portable player conforming to A2DP (Advanced Audio Distribution Profile) or AVRCP (Audio/Video Remote Control Profile) is required.
Not all functions work with all devices.

- During a call, sound on the BLUETOOTH audio source is muted.

Recalling the BLUETOOTH audio source

- 1 Press SOURCE/⏻ on the unit.**
The SOURCE selection screen is displayed.
- 2 Touch the [BT Audio] icon.**
The BT Audio source is activated and the display changes to the BT Audio main screen.

Selecting the desired Song

Touch [◀◀].
Returns the beginning of the song being played back.

Touch [▶▶].
Forwards the next song.

Pausing

Touch [▶/||].
A playback stops. Touching again will resume a playback.

Rearview Camera Operation (Optional)

When an optional rearview camera with RCA output connector or Direct output connector such as HCE-C107D, etc. is connected, rear view video can be output to the monitor.

- Depending on the connected Rearview Camera, be sure to set "Camera IN" to "Direct" or "AUX" before using the Rearview Camera, refer to "Setting the Rear Camera Input" on page 44.

Switching the Rear Camera Screen (Optional)

The rear view video will be displayed for the two situations as below.

Displaying the rear view video while the car is in reverse

- 1 Shift the gear lever to the reverse (R) position.**
The rear view image is displayed while the car remains in reverse.
- 2 If you shift the gear lever to a position other than reverse (R), the monitor returns to the previous screen.**
 - Be sure to also check behind the car visually. Use the camera image to assist in showing conditions behind the car.
 - This function is effective when the reverse wire is properly connected.

Displaying the rear view video manually

- 1 Press SOURCE/⏻ on the unit.**
The SOURCE selection screen is displayed.
- 2 Touch [Camera].**
The Camera mode is activated and the rear view video is displayed.
- 3 Touch [Guide On] or [Guide Off] to set whether the rear camera guide line is displayed.**
- 4 Touch [↶] to access to Visual selection screen, and then touch [Normal] to return to previous main screen.**

Navigation System (Optional)

Switching the Navigation Screen (Optional)

If an optional Alpine Navigation System is connected to the IVA-D511RB/IVA-D511R, the Navigation screen can be displayed on this unit.

- 1 Touch [Source] on the main screen.**
The source screen appears on the display.
- 2 Touch [Nav.].**
The Navigation screen is displayed.
The operation is possible with the supplied navigation remote control.
For navigation operation, refer to the Owner's Manual of the navigator.
 - You can press **VISUAL** to activate the Visual Sel. screen when the monitor is open, and then touch [Nav.]. The navigation mode is activated from the Visual Sel. mode without interrupting normal audio.
 - You can also directly access to Navigation screen by pressing [F] ↔ [⊕] on main source screen. For details, refer to "Recalling the Source" on page 13.
 - If the Navigation mode menu is not displayed on the main menu screen, select **ON** in "Setting the Navigation Mode" (page 45).
 - When the Navigation System is on and in guidance mode, the voice prompts and navigation map interrupts the current audio source.

Portable Navigation System Operation (Optional)

An optional Alpine Portable Navigation System is controllable from the unit. For details, refer to the Owner's Manual of the Portable Navigation System.

With using the docking station type

For details on the connectable portable Navigation, consult your Alpine dealer.

- 1 Select NAV. in "Setting the AUX Mode" (page 45).**
- 2 Mount the Portable Navigation device to the optional docking station.**
The connection to the Portable Navigation is recognized by performing steps 1 and 2.
- 3 Touch [Source] on the main screen.**
The Source Selection screen is displayed.
- 4 Touch [Nav.].**
For details, refer to the Owner's Manual of the Portable Navigation System.

Auxiliary Device (Optional)

Operating Auxiliary Devices (Optional)

To operate your devices connected to the AUX terminals on the rear panel of IVA-D511RB/IVA-D511R (AUX1 mode) or to the iPod video connector by using an AV/RCA interface cable (sold separately) (AUX2 mode) or to the BLUETOOTH interface connector by using a special Conversion cable (KCE-237B) (sold separately) (AUX+ mode), follow the procedure described below.

WARNING

It is dangerous for the driver to watch the TV/Video while driving the vehicle. The driver may be distracted from looking ahead and an accident could occur.

Install the IVA-D511RB/IVA-D511R correctly so that the driver cannot watch TV/Video unless the vehicle is stopped and the emergency brake is applied.

If the IVA-D511RB/IVA-D511R is not installed correctly, the driver will be able to watch the TV/Video while driving the vehicle and may be distracted from looking ahead and cause an accident. The driver or other people could be severely injured.

- If you try to activate the auxiliary device while driving, the display will show the warning-Picture off for your safety.

- 1 Touch [Source] on the main source screen.**
The source screen appears on the display.

- 2 Touch [Aux-1]*, [Aux-2] or [Aux+].**
The external input screen is displayed.

- 3 Touch [NTSC/PAL] to change the video input.**

- * The name which is given as the source name in "Setting the AUX Mode" on page 45 is displayed.
- If the AUX mode is not displayed on the main menu, set **AUX1 IN** to **ON** or **AUX2 IN** to **AUX** by following "Setting the AUX Mode" (page 45).
- The setting of switching **NTSC/PAL**, which you have set in this section, can be used in same way in "Setting the AUX Mode" on page 45.
- The display mode changes by touching [**WIDE**].
For operation, refer to "Switching Display Modes" on page 32.

TUE-T200DVB

Operation (Optional)

Operating the TUE-T200DVB (Optional)

Operable when optional TUE-T200DVB is connected.
When DVB-T is selected in "Setting the AUX Mode" (page 45), the source is displayed in SOURCE selection screen.

1 While your vehicle is parked, touch [Source] on the main screen.

The source screen appears on the display.

2 Touch [DVB-T].

The DVB-T screen is displayed.

3 Perform the desired operation.

Channel Number UP/Down or Favorite Channel Number Up/Down

Touch [CH.]* to select changing the Channel or the Favorite Channel.
Touch CH. [◀] or [▶] to move the Channel number Up/Down.
Touch FAV [◀] or [▶] to move the Favorite Channel number Up/Down.

* The button displays the current changing mode ([CH.] or [FAV]).

Calling up Main Menu Screen

Touch [MENU] to call up the main menu screen.

Calling up Menu Operation Mode

Touch [MENU CONT] to call up the menu operation mode.

Switching the Source

Touch [A/V].
The source switches with each touch.

Calling up Electronic Program Guide (EPG)

Touch [EPG] to call up the Electronic Program Guide.

Scanning Mode

1 Touch [P1/3].

The function guide appears.

2 Touch [SCAN] to start the auto scan procedure.

- For detail, refer to the Owner's Manual of the TUE-T200DVB sold separately.

Video Menu Operation of TUE-T200DVB

1 Touch [P1/3] twice.

The direct touch mode screen is displayed.

- When the optional TUE-T200DVB is connected, you can control it by the touch key (except the [Control] key) on the display screen of the unit.

2 Touch [Control].

Return to DVB-T main screen.

- If no operation is performed for 5 seconds, the screen will automatically switch to the full screen mode.

Changer (Optional)

Controlling CD Changer (Optional)

An optional 6-disc or 12-disc CD Changer may be connected to the IVA-D511RB/IVA-D511R if it is Ai-NET compatible. With a CD Changer connected to the Ai-NET input of the IVA-D511RB/IVA-D511R, the CD Changer will be controllable from the IVA-D511RB/IVA-D511R.

If you connect a changer compatible with MP3, you can play CD-ROMs, CD-Rs, and CD-RWs containing MP3 files on the IVA-D511RB/IVA-D511R.

Using the KCA-410C (Versatile Link Terminal) multiple changers can be controlled by the IVA-D511RB/IVA-D511R.

See the Multi-Changer Selection section for selecting the CD Changers (explained on page 66).

1 Touch [Source] on the main screen.

2 Touch [CD CHG].

The display changes to the CD changer mode screen.

When a 6 Disc CD Changer is connected;

1 Touch [P1/2]*.

The Function Guide display appears.

* When an MP3 compatible CD changer or DVD changer is connected, touch repeatedly until the disc number is displayed.

2 Touch any one of the select buttons [DISC 1] through [DISC 6].

DISC 1 through DISC 6 select the discs from the first disc to 6th disc.

When an MP3 compatible CD changer is connected;

1 Touch [P1/3] twice to change the Function Guide display.

2 Touch any one of the select buttons [DISC 1] through [DISC 6].

DISC 1 through DISC 6 select the discs from the first disc to 6th disc.

When a 12-Disc CD Changer is connected;

You can select the disc numbers 1 to 6 in the same manner as for 6-disc Changer.

Touch [P1/3] twice to select disc numbers 7 to 12.

The function guide display changes so that DISC 7 through DISC 12 represent disc numbers 7 to 12.

- After selecting the desired disc, you can operate in the same way as for the CD player. For details, see the CD/MP3/WMA/AAC section.
- When an MP3 compatible CD changer is connected, the unit can play discs containing both audio data and MP3 data.
- The DVD changer (optional) is controllable from the IVA-D511RB/IVA-D511R as well as the CD changer.
- For operation of the connected DVD changer (DHA-S690), refer to the section "CD/MP3/WMA/AAC" or "DVD/Video CD" described in this manual, or the Owner's Manual of the DHA-S690.
- When the optional DVD changer (DHA-S690) is connected to this unit, touching [NTSC/PAL] after touching [P1/4] three times will change the video input.

Multi-Changer Selection (Optional)

When using KCA-410C (Versatile Link Terminal), you can connect two changers.

1 In changer mode, touch [CHG SEL] or press BAND/TA on the unit to select the next changer (connected CD changers only) .

2 To operate the selected changer, see "CD/MP3/WMA/AAC" section.

USB Memory/ Portable audio player (Optional)

A USB memory or Portable audio player can be connected to this unit through the USB Connector of this unit.

If a USB memory device or Portable audio player is connected to the unit, MP3/WMA/AAC files of USB memory and MP3/WMA files of Portable audio player can be played back.

BANK Function

What is a Bank?

A bank is a unit of up to 1,000 songs, which is stored in memory/portable audio player. "Banking" refers to the grouping of songs available in USB Memory/portable audio player, in banks of 1,000 songs each. However, when a USB Memory is connected, 1BANK can store up to 1,000 songs under the following conditions. Otherwise, the number of songs that can be stored may be less than 1,000.

Conditions (general estimate values)

Playlists: 20 (32 characters; 64 bytes)

Genres: 10 (32 characters; 64 bytes)

Composers: 30 (32 characters; 64 bytes)

Artists: 30 (32 characters; 64 bytes)

Albums: 100 (32 characters; 64 bytes)

Titles: 1,000 (32 characters; 64 bytes)

Folders: 100 (32 characters; 64 bytes)

Files: 1,000 (32 characters; 64 bytes)

File Paths: 1,000 (128 characters; 256 bytes)

About Banking

While a bank is being built up, "Banking" is displayed. Banking occurs whenever a USB Memory device/Portable audio player is connected or after power to the head unit turns on.

It can take anywhere from a few seconds to up to several minutes for banking to complete. This depends on the number of files and folders in USB Memory/Portable audio player.

Available operations while Banking

- With a song playing, Regular fast-forwarding and next song selection is available. However, when a portable audio player is connected, the above operation is unavailable and no sound will be output during Banking.
- While Banking, the song playback order may differ from the song order in the USB Memory device/Portable audio player.
- Searching is not recommended during the Banking process as the database is under construction at this time, and malfunction may result in some cases.

This unit has the BANK function that automatically divides every 1,000 songs stored in USB memory/Portable audio player into individual banks to make searching and playing back a song easier. A maximum of 1,000 songs for one bank can be stored according to the order stored in USB memory/Portable audio player. A maximum of 20 banks (20,000 songs) can be recognized. BANK1 (songs 1 to 1,000) is set as the default. If you want to search beyond 1,000 songs, perform the following operation to select a different bank.

BANK No.	Song number
BANK1	1~1,000
BANK2	1,001~2,000
⋮	⋮
BANK20	19,001~20,000

1 Touch [P1/2] to change the function guide.

2 Touch BANK [▼] or [▲] to select the desired BANK.

Each operation can be performed in the selected bank.

- *Even if the files are contained in the same folder, they may be saved as different BANK.*

Playback

1 Touch [Source] on the main source screen.

The Source Selection screen is displayed.

2 Touch [USB Audio], the USB mode is activated and the display changes to the USB screen.

3 Touch [◀◀] or [▶▶] to select the desired track (file).

Returning to the beginning of the current track (file):

Touch [◀◀].

Fast backward:

Touch and hold [◀◀].

Advancing to the beginning of the next track (file):

Touch [▶▶].

Fast forward:

Touch and hold [▶▶].

- *Depending on the connected portable audio player, fast-forwarding/fast-reversing may not be available.*

4 To pause playback, touch [▶/||].

Touching [▶/||] again will resume playback.

- *WMA format files that are protected by DRM (Digital Rights Management), AAC format files that have been purchased from iTunes Store and files that are copy-protected (copyright protection) cannot be played back on this unit.*
- *The playback time may not be correctly displayed when a VBR (Variable Bit Rate) recorded file is played back.*
- *If there is tag information, artist name/album name/track name is displayed.*
- *ID3 tag/WMA tag*
If an MP3/WMA/AAC file contains ID3 tag/WMA tag information, the ID3 tag/WMA tag information is displayed (e.g., song name, artist name, and album name). All other tag data is ignored.
- *"NO SUPPORT" is scroll displayed when text information is not compatible with this unit.*
- *Before disconnecting USB memory, be sure to change to another source or set to pause.*

Repeat Play

Only Repeat One is available for this mode.

Repeat One: A single song is repeatedly played back.

1 Touch [P1/2].
The function guide is displayed.

2 Touch [↻].
The file will be played repeatedly.

↻ ↔ (off)
(Repeat One)

3 To cancel repeat play, touch [↻].

Random Play Shuffle (M.I.X.)

The Shuffle function of the USB memory or Portable audio player is displayed as  on the IVA-D511RB/IVA-D511R.



Shuffle ALL ALL:

All songs in the USB memory or Portable audio player are played back in random sequence. Any one song does not play back again until all songs have been played back.

Shuffle Songs

Song shuffle randomly plays back songs within a selected category (playlist, album, etc.). The songs within the category are played just once until all songs have been played.

1 Touch [] after touching [P1/2].
The songs will be played back in random sequence.

  →  ALL → (off)
(Shuffle Songs) (Shuffle ALL)

2 To cancel M.I.X. play, touch [].

- When a song is played back during Random (M.I.X.) play, the song can be played back again randomly even if not all songs on the USB Memory have been played back.

Searching for a desired Song

A USB memory or Portable audio player can contain hundreds of songs. By using file tag information and keeping these songs organized in playlists, this unit's search functions will ease song searches. Each music category has its own individual hierarchy. Use the Playlists*/Artists/Albums/Songs/Genres/Composers/Folders/Files search mode to narrow searches based on the table below.

Hierarchy 1	Hierarchy 2	Hierarchy 3	Hierarchy 4
Playlists* ¹	Songs	—	—
Artists*	Albums*	Songs	—
Albums*	Songs	—	—
Songs	—	—	—
Genres*	Artists*	Albums*	Songs
Composers*	Albums*	Songs	—
Folders	Files	—	—
Files	—	—	—

*¹ Playlist search is not available when a Portable audio player is connected.

For example: Searching by Artist name

The following example explains how an Artists search is performed. Another search mode can be used for the same operation, although the hierarchy differs.

Searching by artist name

1 Touch [Q].
The search mode is activated, and the search list screen appears.

- Touching [Q] for at least 2 seconds will return to last search mode.

2 Touch the title bar of Artists.
The ARTISTS search screen is displayed.

3 Select the desired artist.





To play back the artist directly

- Touch [] next to the artist's name.
All songs of the selected artist are played back.

To search for the album of an artist

- Touch the title bar of the selected artist.
The Albums search screen of the selected artist is displayed.
- Touch [] next to the desired album's name.
All songs of the selected album are played back.

To search for a song in the album of an artist

- Touch the title bar of the desired album in "To search for the album of an artist" in step 2.
The Songs search screen of the selected album is displayed.
 - Touch [] next to the desired song's name.
The selected song is played back.
- Touching [] of ALL will play back all songs in the list when you are in a hierarchy with an asterisk "*" (see table on the left column).
 - Touching the title bar of ALL will display the search list in the next hierarchy.
 - When search is made during M.I.X. play, the M.I.X. play mode will be cancelled.
 - In the search mode, you can scroll the list one page at a time by touching [] or [].
 - In the search mode, a search can be made quickly by Alphabet skip function to find the desired artist or song, etc. For details, refer to "Alphabet Skip Function" on page 69.
 - In search mode, you can jump to an assigned position by touching the direct search bar for quick search. For details, refer to "Direct Search Function" (page 71).

Alphabet Skip Function

The unit is provided with a alphabet skip function for effective searching. When you use this function in the search mode, you can quickly search an artist or a song, etc.

Alphabet skip function*: The alphabet skip function is skipped to the next alphabet such as from A to B, B to C by pressing ALPHABET [▶]. You can also skip in reverse order such as from B to A by pressing ALPHABET [◀].

Display example for Albums search screen

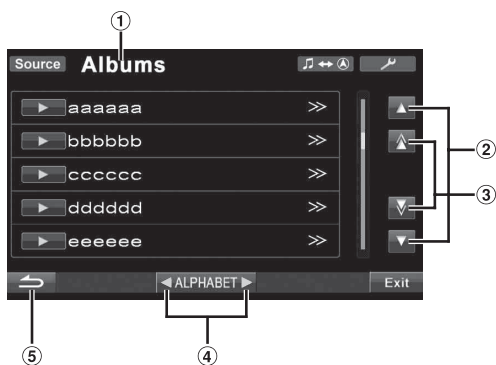

- ① Displays the current search mode.
- ② Scroll the list one line at a time by touching [▲] or [▼].
- ③ Skip the list one page at a time by touching [▲] or [▼]. Touching and holding [▲] or [▼], the display continuously changes.
- ④ Skip the list one alphabet at a time by touching ALPHABET [▶] or [◀].
- ⑤ Touch [↶] to return to the previous menu.

* Titles are listed alphabetically, and can be skipped every 200 titles with the same beginning alphabetical character. If there are fewer than 200 titles, titles beginning with the next alphabetical character e.g. touch ALPHABET [▶], switch to the section beginning with alphabet B from A.

- The alphabet select object is only the alphabet that is recorded by UTF-16 character code.
- This function is ineffective in Playlist search mode.

Selecting Playlist/Artist/Album/Genre/Composer

Playlist*/Artist/Album/Genre/Composer can be easily changed. For example, if you listen to a song from a selected album, the album can be changed.

Touch [▼] or [▲] to select the desired Playlist/Artist/Album/Genre/Composer.

- * This item is invalid when a portable audio player is connected.
- If search selection mode is not activated, a Song search is not possible.
- If an album is selected from an artist search, the album can be searched.
- During shuffle (M.I.X.) playback, this operation is not possible.

Select the desired Folder (Folder up/down)

If you listen to a file from a selected folder, the folder can be changed.

Touch [▼] or [▲] to select the folder.

Creating the playlist from the Artist/Album information of the current song

When a song is played back, a playlist about all the songs with the same Artist or Album stored in the USB memory or Portable audio player can be created.

1 Touch [P1/2] when a song is played back.
The function guide changes.

2 Touch [X-RPT ARTIST] or [X-RPT ALBUM] to create the playlist.

- According to the artist/album information of the current song, a playlist about all the songs with the same artist/album of the BANK are made into a playlist, which then starts to play back.

iPod/iPhone (Optional)

Connecting an iPod/iPhone

An iPod/iPhone can be connected to this unit, by using the USB connection cable. When this unit is connected by using the cable, the controls on the iPod are not functional.

- Other applications (Internet function, etc.) of the iPhone or iPod touch are not controllable from the unit; however, these functions can be controlled from the iPhone or iPod touch itself.
- If you connect an iPhone to this unit, it can be used as an iPod. If you use iPhone as a hands-free phone, you need the optional BLUETOOTH INTERFACE (KCE-400BT).
- To watch the video screen of the file from iPod/iPhone (iPhone, iPod touch, iPod classic, iPod with Video, iPod nano (3rd generation) and iPod nano (4th generation)), using the USB connection and the Parking Brake must be engaged, set "AUX2 IN" to "iPod Video" in "Setting the AUX Mode" (page 45).
- For automatic transmission vehicles, place the transmission lever in the Park position.

iPod/iPhone models usable with this unit

- Confirmed devices regarding Made for iPod. Correct function of earlier versions cannot be guaranteed.
 - iPod touch (2nd generation): Ver.3.0
 - iPod nano (4th generation): Ver.1.0.2
 - iPod classic (120 GB only): Ver.2.0.1
 - iPod touch (1st generation): Ver.3.0
 - iPod nano (3rd generation): Ver.1.1.3 PC
 - iPod classic (80 GB, 160 GB only): Ver.1.1.2 PC
 - iPod nano (2nd generation): Ver.1.1.3
 - iPod with video: Ver.1.3
 - iPod nano (1st generation): Ver.1.3.1
- Confirmed devices regarding Works with iPhone. Correct function of earlier versions cannot be guaranteed.
 - iPhone 3GS: Ver.3.1
 - iPhone 3G: Ver.3.0
 - iPhone: Ver.3.0
- For clarity in identifying your model of iPod, please see Apple's own document "Identifying iPod models" at <http://support.apple.com/kb/HT1353>.

Playback

- 1 Touch [Source] on the main screen.**
The Source Selection screen is displayed.
- 2 Touch [iPod].**
The display shows the iPod mode screen.
- 3 Touch [◀◀] or [▶▶] to select the desired song.**

Return to the beginning of the current song:

Touch [◀◀].

Fast backward the current song:

Touch and hold [◀◀].

Advance to the beginning of the next song:

Touch [▶▶].

Fast forward the current song:

Touch and hold [▶▶].

- 4 To pause playback, touch [▶/||].**
Touching [▶/||] again will resume playback.

- If a song is playing on the iPod/iPhone when it is connected to this unit, it will continue playing after the connection.
- If the artist, album or song name, created in iTunes, has too many characters, songs may not be played back when connected to this unit. Therefore, a maximum of 250 characters is recommended. The maximum number of characters for the head unit is 128 (128 byte).
- Some characters may not be correctly displayed.
- "NO SUPPORT" is displayed when text information is not compatible with the this unit.
- If an iPhone or a video-compatible iPod is connected, touching [WIDE] on the function guide will change the display mode. For operation, refer to "Switching Display Modes" (page 32).
- If you listen to an episode from a selected podcast or audiobook, the episode can be changed by pressing Episodes [▼] or [▲].
- An episode may have several chapters. The chapter can be changed by pressing [◀◀] or [▶▶].
- When an iPhone 3GS or an iPod (Ver.3.x) is connected to this unit, after changing the source or received traffic information, etc., to return to USB iPod mode, "No USB Device" may be displayed. In this case, reconnect the iPhone 3GS/iPod.

Searching for a desired Song

An iPod/iPhone can contain hundreds of songs. By keeping these songs organized in playlists, this unit can use these to ease song searches. Using the search mode's individual hierarchy, you can narrow down your search as shown in the table below.

<MUSIC Search Menu>

Hierarchy 1	Hierarchy 2	Hierarchy 3	Hierarchy 4
Playlists	Songs	—	—
Artists*	Albums*	Songs	—
Albums*	Songs	—	—
Songs	—	—	—
Podcasts	Episodes	—	—
Genres*	Artists*	Albums*	Songs
Composers*	Albums*	Songs	—
Audiobooks	—	—	—

- Video search mode depends on the iPod/iPhone. If the specification of the iPod/iPhone is changed, the search mode on this unit will also be changed.

For example: Searching by Artist name

The following example explains how an Artist search is performed. Another search mode can be used for the same operation, although the hierarchy differs.

Searching by artist name

1 Touch [Q].

The search mode is activated, and the search list screen appears.

- Touching and holding [Q] for at least 2 seconds will return to last search mode.

2 Touch the title bar of Music.

The Music search menu screen is displayed.

- If Video mode is selected, the Video playlists/Movies/Music Videos/TV Shows/Video Podcasts search mode may be used depending on the connected iPod/iPhone (Only for iPhone or iPod compatible Video).
- If you want to select Video search mode, set AUX2 to iPod Video in advance. Refer to "Setting the AUX Mode" on page 45.

3 Touch the title bar of Artists.

The Artist search screen is displayed.

4 Select the desired artist.

To play back the artist directly

- 1 Touch [▶] next to the artist's name.
All songs of the selected artist are played back.

To search for the album of an artist

- 1 Touch the title bar of the selected artist.
The Album search screen of the selected artist is displayed.
- 2 Touch [▶] next to the desired album's name.
All songs of the selected album are played back.

To search for a song in the album of an artist

- 1 Touch the title bar of the desired album in "To search for the album of an artist" in step 2.
The Song search screen of the selected album is displayed.
 - 2 Touch [▶] next to the desired song's name.
The selected song is played back.
- Touching [▶] of ALL will play back all songs in the list when you are in a hierarchy with an asterisk* (see table on the previous page).
 - Touching the title bar of ALL will display the search list in the next hierarchy.
 - In search mode, you can jump to an assigned position by touching the direct search bar for quick search. For details, refer to "Direct Search Function" (page 71).
 - If Alphabet Skip Function is activated in the search mode, a search can be made quickly by Alphabet skip function to find the desired artist or song, etc. For details, refer to "Alphabet Skip Function" on page 71.
 - When search is made during M.I.X. play, the M.I.X. play mode will be cancelled.
 - In search mode, touch [↶] to return to the previous menu.
 - In search mode, touch [Exit] to return to iPod main screen.

Direct Search Function

The unit's direct search function can be used to search for an album, song, etc., more efficiently. In Playlists/Artists/Albums/Songs/Genres/Composers/Podcasts/Audiobooks mode, you can quickly target any song.

Display example for Albums search screen



- ① Direct search bar
- ② Returns to the previous screen.
- ③ Touching [Exit] will turn off the search screen, and return to main screen.

In search mode, touch anywhere on the Direct search bar to step through items. The search list display also changes according to the selected song position.

Alphabet Skip Function

The unit is provided with an alphabet skip function for effective searching. When you use this function in the search mode, you can quickly search an artist or a song, etc.

Alphabet skip function*: The alphabet skip function is skipped to the next alphabet such as from A to B, B to C by pressing ALPHABET [▶]. You can also skip in reverse order such as from B to A by pressing ALPHABET [◀].

Display example for Albums search screen

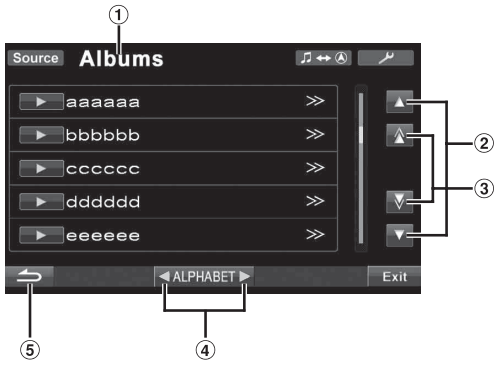

- ① Displays the current search mode.
- ② Scroll the list one line at a time by touching [▲] or [▼].
- ③ Skip the list one page at a time by touching [▲] or [▼]. Touching and holding [▲] or [▼], the display continuously changes.
- ④ Skip the list one alphabet* at a time by touching ALPHABET [▶] or [◀].
- ⑤ Touch [↶] to return to the previous menu.

* Titles are listed alphabetically, and can be skipped every 200 titles with the same beginning alphabetical character. If there are fewer than 200 titles, titles beginning with the next alphabetical character e.g. touch ALPHABET [▶], switch to the section beginning with alphabet B from A.

Selecting Playlist/Artist/Album/Genre/Composer/Episode/Category

Playlist/Artist/Album/Genre/Composer/Episode/Category* can be easily changed.

For example, if you listen to a song from a selected album, the album can be changed.

1 Touch [▼] or [▲] to select the desired Playlist/Artist/Album/Genre/Composer/Episode/Category*.

- * Category can be changed only when playback the video files of iPod/iPhone.
- If search selection mode is not activated, a Song search is not possible.
- During shuffle (M.I.X.) playback, this operation is not possible.
- If Playlist/Artist/Album/Genre/Composer/Episode are not searched, this operation is not possible.

Random Play Shuffle (M.I.X.)

The Shuffle function of the iPod is displayed as on the IVA-D511RB/IVA-D511R.

Shuffle ALL ALL:

Shuffle ALL plays all songs in the iPod randomly. Any one song does not play back again until all songs have been played back.

Shuffle Albums

Album shuffle playback plays back all songs in order, then randomly selects the next album. All songs of that album are played back in order, and so on. Any one album is played just once.

Shuffle Songs

Song shuffle randomly plays back certain selected songs. Any one song plays back just once until all songs have been played back.

1 Touch [ALL].

The songs will be played back in random sequence.

ALL ↔ (off)
(Shuffle ALL)

Touch [] after touching [P1/2].

→ → (off)
(Shuffle Albums) (Shuffle Songs)

2 To cancel M.I.X. play, touch [ALL] or [].

- For details of the search mode, refer to "Searching for a desired Song" (page 70).
- If a song is selected in the album search mode before selecting Shuffle (M.I.X.), the songs will not play back randomly even when Shuffle album is selected.

* This operation cannot be performed for the video files of iPod/iPhone.

Repeat Play

Only Repeat One is available for the iPod.

Repeat One: A single song is repeatedly played back.

1 Touch [P1/2].

The function guide is displayed.

2 Touch [].

The file will be played repeatedly.

↔ (off)
(Repeat One) (Repeat the list being played back)

3 To cancel repeat play, touch [].

- Depending on the connected iPod, track up/down may be not available during Repeat play.

About Sub Display

Display example for Radio mode

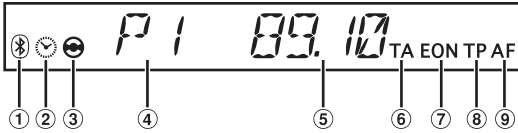

- ① Lights up when BLUETOOTH function is used.
- ② Lights up while the clock mode is selected.
- ③ Lights up when Rear Camera mode is activated.
- ④ Display preset No.
- ⑤ Display frequency.
- ⑥ Lights up when Traffic Information mode is ON.
- ⑦ Lights up while EON receiving.
- ⑧ Lights up when Traffic Information is tuned in.
- ⑨ Lights up when AF mode is ON.

Display example for CD mode

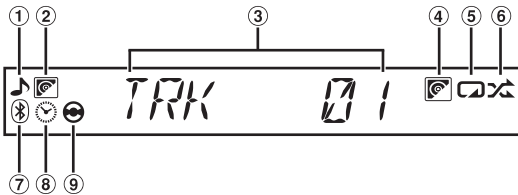

- ① Lights up when track information is displayed.
- ② Lights up when Disc text is displayed.
- ③ Display the track No.
- ④ Lights up when Repeat/M.I.X. Disc function is activated (when a CD changer is connected).
- ⑤ Lights up when Repeat function is activated.
- ⑥ Lights up when M.I.X. function is activated.
- ⑦ Lights up when BLUETOOTH function is used.
- ⑧ Lights up while the clock mode or elapsed time mode is selected.
- ⑨ Lights up when Rear Camera mode is activated.

Display example for MP3/WMA/AAC/DivX® mode

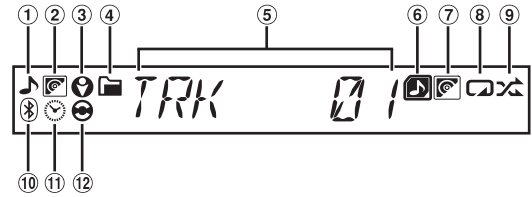

- ① Lights up when Song/File information is displayed.
- ② Lights up when Album name is displayed.
- ③ Lights up when Artist name is displayed.
- ④ Lights up when Folder information is displayed.
- ⑤ Display the Song/File No.
- ⑥ Lights up when Repeat/M.I.X. Folder function is activated.
- ⑦ Lights up when Repeat Disc function is activated (when an MP3 changer is connected).
- ⑧ Lights up when Repeat function is activated.
- ⑨ Lights up when M.I.X. function is activated.
- ⑩ Lights up when BLUETOOTH function is used.
- ⑪ Lights up while the clock mode or elapsed time mode is selected.
- ⑫ Lights up when Rear Camera mode is activated.

Display example for DVD mode

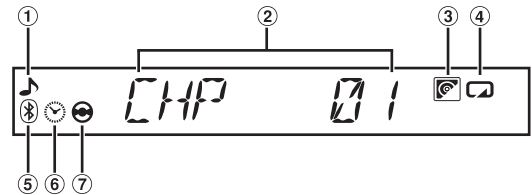

- ① Lights up when Chapter information is displayed.
- ② Display the Chapter No.
- ③ Lights up when Repeat programme function, etc. is activated.
- ④ Lights up when Repeat function is activated.
- ⑤ Lights up when BLUETOOTH function is used.
- ⑥ Lights up while the clock mode or elapsed time mode is selected.
- ⑦ Lights up when Rear Camera mode is activated.

Display example for VCD mode

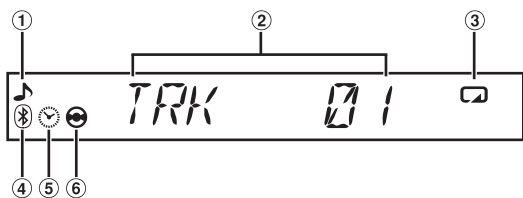

- ① Lights up when Track information is displayed.
- ② Display the Track No.
- ③ Lights up when Repeat track function is activated.
- ④ Lights up when BLUETOOTH function is used.
- ⑤ Lights up while the clock mode or elapsed time mode is selected.
- ⑥ Lights up when Rear Camera mode is activated.

Display example for iPod mode

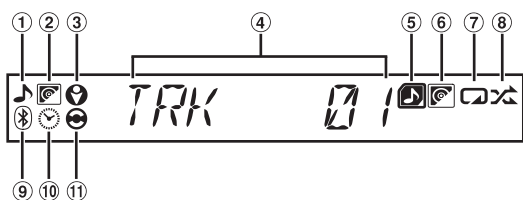

- ① Lights up when Song information is displayed.
- ② Lights up when Album name is displayed.
- ③ Lights up when Artist name is displayed.
- ④ Display the track No.
- ⑤ Lights up when M.I.X. Song function is activated.
- ⑥ Lights up when M.I.X. Album function is activated.
- ⑦ Lights up when Repeat function is activated.
- ⑧ Lights up when M.I.X. function is activated.
- ⑨ Lights up when BLUETOOTH function is used.
- ⑩ Lights up while the clock mode or elapsed time mode is selected.
- ⑪ Lights up when Rear Camera mode is activated.

- When the monitor is closed, you can switch the display by pressing **VISUAL**.
- The tag information, etc. may not be displayed correctly.
- Depending on the connected device, the display differs.

Information

About DVDs

Music CDs and DVDs have grooves (tracks) in which the digital data is recorded. The data is represented as microscopic pits recorded into the track – these pits are read by a laser beam to play the disc. On DVDs, the density of the tracks and pits is twice that of CDs, so DVDs can contain more data in less space.

CDs

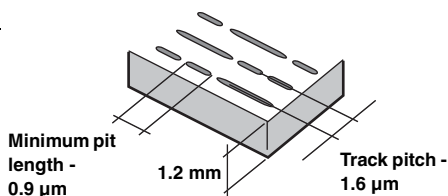

DVDs

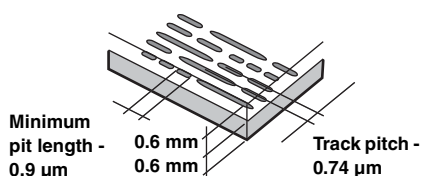

A 12 cm disc can contain one movie or about four hours of music.

In addition, DVDs provide sharp picture quality with vivid colours thanks to a horizontal resolution of over 500 lines (compared to less than 300 for VHS tape).

In addition, DVDs offer a variety of functions.

Multiple audio* (page 27)

Movies can be recorded in up to eight languages. The desired language can be selected from the unit.

Subtitles function* (page 27)

Movies can include subtitles in up to 32 languages. The desired subtitle language can be selected from the unit.

Multi angle function* (page 27)

When the DVD contains a movie shot from multiple angles, the desired angle can be selected from the unit.

Multi story function*

With this function, a single movie includes various story lines. You can select different story lines to view various versions of the same movie.

Operation differs from disc to disc. Story line selection screens including instructions appear during the movie. Just follow the instructions.

* The functions audio languages, subtitle languages, angles, etc., differ from disc to disc. For details, refer to the disc's instructions.

Terminology

Dolby Digital

Dolby Digital is a digital audio compression technology developed by Dolby Laboratories that allows large quantities of audio data to be efficiently recorded on discs. It is compatible with audio signals from mono (1 channel) all the way up to 5.1-channel surround sound. The signals for the different channels are completely independent, and since the sound is high quality digital there is no loss of sound quality.

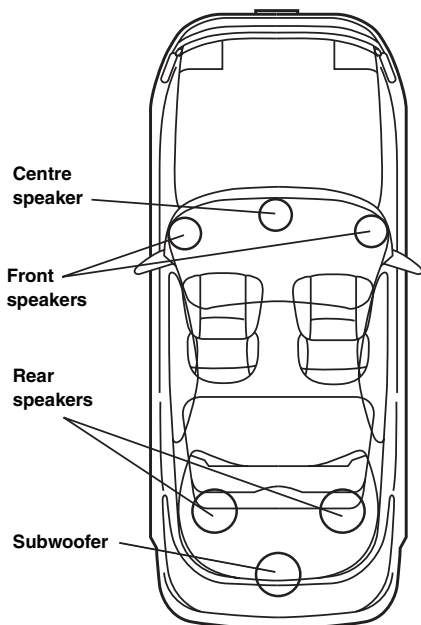

**Speaker layout for enjoying
Dolby Digital sound/DTS sound**

DTS

This is a home-use digital sound format of the DTS Sound System. This is a high quality sound system, developed by DTS, Inc. for use in movie theatres.

DTS has six independent sound tracks. The theatre presentation is fully realized in the home and other settings. DTS is the abbreviation for Digital Theatre System.

** To enjoy DTS surround sound you need the separately sold DTS digital audio processor (PXA-H700, etc.). The DVD video software must also have a DTS sound track.*

The IVA-D511RB/IVA-D511R has a built-in DTS 2-channel audio decoder. Analogue audio outputs are available.

Dolby Pro Logic II

Dolby Pro Logic II plays 2-channel sources in 5 channels over the entire frequency range.

This is done with an advance, high sound quality matrix surround decoder which draws out the spatial properties of the original recording without adding any sounds to or changing the sound of the source.

** The separately sold digital audio processor (PXA-H700, etc.) is required to enjoy Dolby Pro Logic II surround sound.*

Linear PCM audio (LPCM)

LPCM is a signal recording format used for music CDs. Whereas music CDs are recorded at 44.1 kHz/16 bits, DVDs are recorded at 48 kHz/16 bits to 96 kHz/24 bits, thereby achieving higher sound quality than music CDs.

Rating levels (parental lock)

This is a function of the DVD for restricting the viewing age as stipulated by laws in different countries. The way in which viewing is restricted differs from DVD to DVD. Sometimes the DVD cannot be played at all, other times certain scenes are skipped, and other times certain scenes are replaced with other scenes.

List of Language Codes

(For details, see page 34.)

Abbreviation	Code	Language	Abbreviation	Code	Language	Abbreviation	Code	Language
AA	6565	Afar	IE	7369	Interlingue	RN	8278	Kirundi
AB	6566	Abkhazian	IK	7375	Inupiak	RO	8279	Romanian
AF	6570	Afrikaans	IN	7378	Indonesian	RU	8285	Russian
AM	6577	Amharic	IS	7383	Icelandic	RW	8287	Kinyarwanda
AR	6582	Arabic	IT	7384	Italian	SA	8365	Sanskrit
AS	6583	Assamese	IW	7387	Hebrew	SD	8368	Sindhi
AY	6589	Aymara	JA	7465	Japanese	SG	8371	Sangho
AZ	6590	Azerbaijani	JL	7473	Yiddish	SH	8372	Serbo-Croatian
BA	6665	Bashkir	JW	7487	Javanese	SI	8373	Singhalese
BE	6669	Byelorussian	KA	7565	Georgian	SK	8375	Slovak
BG	6671	Bulgarian	KK	7575	Kazakh	SL	8376	Slovenian
BH	6672	Bihari	KL	7576	Greenlandic	SM	8377	Samoan
BI	6673	Bislama	KM	7577	Cambodian	SN	8378	Shona
BN	6678	Bengali, Bangla	KN	7578	Kannada	SO	8379	Somali
BO	6679	Tibetan	KO	7579	Korean	SQ	8381	Albanian
BR	6682	Breton	KS	7583	Kashmiri	SR	8382	Serbian
CA	6765	Catalan	KU	7585	Kurdish	SS	8383	Siswati
CO	6779	Corsican	KY	7589	Kirghiz	ST	8384	Sesotho
CS	6783	Czech	LA	7665	Latin	SU	8385	Sundanese
CY	6789	Welsh	LN	7678	Lingala	SV	8386	Swedish
DA	6865	Danish	LO	7679	Laothian	SW	8387	Swahili
DE	6869	German	LT	7684	Lithuanian	TA	8465	Tamil
DZ	6890	Bhutani	LV	7686	Latvian, Lettish	TE	8469	Telugu
EL	6976	Greek	MG	7771	Malagasy	TG	8471	Tajik
EN	6978	English	MI	7773	Maori	TH	8472	Thai
EO	6979	Esperanto	MK	7775	Macedonian	TI	8473	Tigrinya
ES	6983	Spanish	ML	7776	Malayalam	TK	8475	Turkmen
ET	6984	Estonian	MN	7778	Mongolian	TL	8476	Tagalog
EU	6985	Basque	MO	7779	Moldavian	TN	8478	Setswana
FA	7065	Persian	MR	7782	Marathi	TO	8479	Tonga
FI	7073	Finnish	MS	7783	Malay	TR	8482	Turkish
FJ	7074	Fiji	MT	7784	Maltese	TS	8483	Tsonga
FO	7079	Faroese	MY	7789	Burmese	TT	8484	Tatar
FR	7082	French	NA	7865	Nauru	TW	8487	Twi
FY	7089	Frisian	NE	7869	Nepali	UK	8575	Ukrainian
GA	7165	Irish	NL	7876	Dutch	UR	8582	Urdu
GD	7168	Scots Gaelic	NO	7879	Norwegian	UZ	8590	Uzbek
GL	7176	Galician	OC	7967	Occitan	VI	8673	Vietnamese
GN	7178	Guarani	OM	7977	(Afan) Oromo	VO	8679	Volapuk
GU	7185	Gujarati	OR	7982	Oriya	WO	8779	Wolof
HA	7265	Hausa	PA	8065	Punjabi	XH	8872	Xhosa
HI	7273	Hindi	PL	8076	Polish	YO	8979	Yoruba
HR	7282	Croatian	PS	8083	Pashto, Pushto	ZH	9072	Chinese
HU	7285	Hungarian	PT	8084	Portuguese	ZU	9085	Zulu
HY	7289	Armenian	QU	8185	Quechua			
IA	7365	Interlingua	RM	8277	Rhaeto-Romance			

List of Country Codes

(For details, see page 34.)

Abbreviation	Code	Country	Abbreviation	Code	Country	Abbreviation	Code	Country
AD	6568	Andorra	DM	6877	Dominica	KI	7573	Kiribati
AE	6569	United Arab Emirates	DO	6879	Dominican Republic	KM	7577	Comoros
AF	6570	Afghanistan	DZ	6890	Algeria	KN	7578	Saint Kitts and Nevis
AG	6571	Antigua and Barbuda	EC	6967	Ecuador	KP	7580	Korea, Democratic People's Republic of
AI	6573	Anguilla	EE	6969	Estonia			
AL	6576	Albania	EG	6971	Egypt	KR	7582	Korea, Republic of
AM	6577	Armenia	EH	6972	Western Sahara	KW	7587	Kuwait
AN	6578	Netherlands Antilles	ER	6982	Eritrea	KY	7589	Cayman Islands
AO	6579	Angola	ES	6983	Spain	KZ	7590	Kazakhstan
AQ	6581	Antarctica	ET	6984	Ethiopia	LA	7665	Lao People's Democratic Republic
AR	6582	Argentina	FI	7073	Finland			
AS	6583	American Samoa	FJ	7074	Fiji	LB	7666	Lebanon
AT	6584	Austria	FK	7075	Falkland Islands	LC	7667	Saint Lucia
AU	6585	Australia	FM	7077	Micronesia, Federated States of	LI	7673	Liechtenstein
AW	6587	Aruba	FO	7079	Faroe Islands	LK	7675	Sri Lanka
AZ	6590	Azerbaijan	FR	7082	France	LR	7682	Liberia
BA	6665	Bosnia and Herzegovina	GA	7165	Gabon	LS	7683	Lesotho
BB	6666	Barbados	GB	7166	United Kingdom	LT	7684	Lithuania
BD	6668	Bangladesh	GD	7168	Grenada	LU	7685	Luxembourg
BE	6669	Belgium	GE	7169	Georgia	LV	7686	Latvia
BF	6670	Burkina Faso	GF	7170	French Guiana	LY	7689	Libyan Arab Jamahiriya
BG	6671	Bulgaria	GH	7172	Ghana	MA	7765	Morocco
BH	6672	Bahrain	GI	7173	Gibraltar	MC	7767	Monaco
BI	6673	Burundi	GL	7176	Greenland	MD	7768	Moldova, Republic of
BJ	6674	Benin	GM	7177	Gambia	MG	7771	Madagascar
BM	6677	Bermuda	GN	7178	Guinea	MH	7772	Marshall Islands
BN	6678	Brunei Darussalam	GP	7180	Guadeloupe	MK	7775	Macedonia, The former Yugoslav Republic of
BO	6679	Bolivia	GQ	7181	Equatorial Guinea			
BR	6682	Brazil	GR	7182	Greece	ML	7776	Mali
BS	6683	Bahamas	GS	7183	South Georgia and the South Sandwich Islands	MM	7777	Myanmar
BT	6684	Bhutan				MN	7778	Mongolia
BV	6686	Bouvet Island	GT	7184	Guatemala	MO	7779	Macau
BW	6687	Botswana	GU	7185	Guam	MP	7780	Northern Mariana Islands
BY	6689	Belarus	GW	7187	Guinea-Bissau	MQ	7781	Martinique
BZ	6690	Belize	GY	7189	Guyana	MR	7782	Mauritania
CA	6765	Canada	HK	7275	Hong Kong	MS	7783	Montserrat
CC	6767	Cocos (Keeling) Islands	HM	7277	Heard Island and McDonald Islands	MT	7784	Malta
CD	6768	Congo, the Democratic Republic of the				MU	7785	Mauritius
CF	6770	Central African Republic	HN	7278	Honduras	MV	7786	Maldives
CG	6771	Congo	HR	7282	Croatia	MW	7787	Malawi
CH	6772	Switzerland	HT	7284	Haiti	MX	7788	Mexico
CI	6773	Cote d'Ivoire	HU	7285	Hungary	MY	7789	Malaysia
CK	6775	Cook Islands	ID	7368	Indonesia	MZ	7790	Mozambique
CL	6776	Chile	IE	7369	Ireland	NA	7865	Namibia
CM	6777	Cameroon	IL	7376	Israel	NC	7867	New Caledonia
CN	6778	China	IN	7378	India	NE	7869	Niger
CO	6779	Colombia	IO	7379	British Indian Ocean Territory	NF	7870	Norfolk Island
CR	6782	Costa Rica	IQ	7381	Iraq	NG	7871	Nigeria
CU	6785	Cuba	IR	7382	Iran, Islamic Republic of	NI	7873	Nicaragua
CV	6786	Cape Verde	IS	7383	Iceland	NL	7876	Netherlands
CX	6788	Christmas Island	IT	7384	Italy	NO	7879	Norway
CY	6789	Cyprus	JM	7477	Jamaica	NP	7880	Nepal
CZ	6790	Czech Republic	JO	7479	Jordan	NR	7882	Nauru
DE	6869	Germany	JP	7480	Japan	NU	7885	Niue
DE	6869	Germany	KE	7569	Kenya	NZ	7890	New Zealand
DJ	6874	Djibouti	KG	7571	Kyrgyzstan	OM	7977	Oman
DK	6875	Denmark	KH	7572	Cambodia	PA	8065	Panama

Abbreviation	Code	Country	Abbreviation	Code	Country	Abbreviation	Code	Country
PE	8069	Peru	SJ	8374	Svalbard and Jan Mayen	TW	8487	Taiwan, Province of China
PF	8070	French Polynesia	SK	8375	Slovakia	TZ	8490	Tanzania, United Republic of
PG	8071	Papua New Guinea	SL	8376	Sierra Leone	UA	8565	Ukraine
PH	8072	Philippines	SM	8377	San Marino	UG	8571	Uganda
PK	8075	Pakistan	SN	8378	Senegal	UM	8577	United States Minor Outlying Islands
PL	8076	Poland	SO	8379	Somalia	US	8583	United States
PM	8077	Saint Pierre and Miquelon	SR	8382	Suriname	UY	8589	Uruguay
PN	8078	Pitcairn	ST	8384	Sao Tome and Principe	UZ	8590	Uzbekistan
PR	8082	Puerto Rico	SV	8386	El Salvador	VA	8665	Holy See (Vatican City State)
PT	8084	Portugal	SY	8389	Syrian Arab Republic	VC	8667	Saint Vincent and the Grenadines
PW	8087	Palau	SZ	8390	Swaziland	VE	8669	Venezuela
PY	8089	Paraguay	TC	8467	Turks and Caicos Islands	VG	8671	Virgin Island, British
QA	8165	Qatar	TD	8468	Chad	VI	8673	Virgin Islands, U.S.
RE	8269	Reunion	TF	8470	French Southern Territories	VN	8678	Viet Nam
RO	8279	Romania	TG	8471	Togo	VU	8685	Vanuatu
RU	8285	Russian Federation	TH	8472	Thailand	WF	8770	Wallis and Futuna
RW	8287	Rwanda	TJ	8474	Tajikistan	WS	8783	Samoa
SA	8365	Saudi Arabia	TK	8475	Tokelau	YE	8969	Yemen
SB	8366	Solomon Islands	TM	8477	Turkmenistan	YT	8984	Mayotte
SC	8367	Seychelles	TN	8478	Tunisia	YU	8985	Yugoslavia
SD	8368	Sudan	TO	8479	Tonga	ZA	9065	South Africa
SE	8369	Sweden	TP	8480	East Timor	ZM	9077	Zambia
SG	8371	Singapore	TR	8482	Turkey	ZW	9087	Zimbabwe
SH	8372	Saint Helena	TT	8484	Trinidad and Tobago			
SI	8373	Slovenia	TV	8486	Tuvalu			

In Case of Difficulty

If you encounter a problem, please turn the power off, then on again. If the unit is still not functioning normally, please review the items in the following checklist. This guide will help you isolate the problem if the unit is at fault. Otherwise, make sure the rest of your system is properly connected, or then consult your authorized Alpine dealer.

Basic

No function or display.

- Vehicle's ignition is off.
 - If connected according to the instructions, the unit will not operate with the vehicle's ignition off.
- Improper power lead connections.
 - Check power lead connections.
- Blown fuse.
 - Check the fuse on the battery lead of the unit; replace with the proper value if necessary.
- Internal micro-computer malfunctioned due to interference noise, etc.
 - Press the RESET switch with a ballpoint pen or other pointed article.
- Blackout mode is activated.
 - Cancel Blackout mode.

No sound or unnatural sound.

- Incorrect setting of volume/balance/fader controls.
 - Readjust the controls.
- Connections are not properly or securely made.
 - Check the connections and firmly connect.

Screen not displayed.

- Brightness control is set at the minimum position.
 - Adjust the Brightness control.
- Temperature in the vehicle is too low.
 - Increase the vehicle's interior temperature to operation temperature range.
- Connections to the DVD, CD player, navigation system are not securely made.
 - Check the connections and firmly connect.

Movement of displayed picture is abnormal.

- Temperature in the vehicle is too high.
 - Allow the vehicle's interior temperature to cool.

Unclear or noisy display.

- Fluorescent plate is worn out.
 - Replace the fluorescent plate.

Navigation system inoperative.

- Connections to the navigation system are incorrect.
 - Check the connections with the navigation system and connect the cables correctly and firmly.

Unclear picture display.

- Fluorescent tube is exhausted.
 - Replace the fluorescent tube*.

* The fluorescent tube replacement is not free of charge even within the warranty period, for the tube is an article of consumption.

Radio

Unable to receive stations.

- No antenna, or open connection in the antenna cable.
 - Make sure the antenna is properly connected; replace the antenna or cable if necessary.

Unable to tune stations in the seek mode.

- You are in a weak signal area.
 - Make sure the tuner is in DX mode.
- If the area you are in is a primary signal area, the antenna may not be grounded and connected properly.
 - Check your antenna connections; make sure the antenna is properly grounded at its mounting location.
- The antenna may not be the proper length.
 - Make sure the antenna is fully extended; if broken, replace the antenna with a new one.

Broadcast is noisy.

- The antenna is not the proper length.
 - Extend the antenna fully; replace it if it is broken.
- The antenna is poorly grounded.
 - Make sure the antenna is grounded properly at its mounting location.
- The station signal is weak and noisy.
 - If above solution does not work, tune in another station.

CD/MP3/WMA/AAC/DVD/Video CD

Disc playback sound is wavering.

- Moisture condensation in the disc Module.
 - Allow enough time for the condensation to evaporate (about 1 hour).

Disc insertion not possible.

- A disc is already in the DVD player.
 - Eject the disc and remove it.
- The disc is being improperly inserted.
 - Make sure the disc is being inserted following the instructions in the CD/MP3/WMA/AAC, DVD/Video CD Player Operation section.

Unable to fast forward or reverse the disc.

- The disc has been damaged.
 - Eject the disc and discard it; using a damaged disc in your unit can cause damage to the mechanism.

Disc playback sound skips due to vibration.

- Improper mounting of the unit.
 - Securely re-mount the unit.
- Disc is very dirty.
 - Clean the disc.
- Disc has scratches.
 - Change the disc.
- The pick-up lens is dirty.
 - Do not use a commercial available lens cleaner disc. Consult your nearest ALPINE dealer.

Disc playback sound skips without vibration.

- Dirty or scratched disc.
 - Clean the disc; damaged disc should be replaced.

CD-R/CD-RW playback not possible.

- Close session (finalization) has not been performed.
 - Perform finalization and attempt playback again.

Error displays

- Mechanical error
 - Press ▲. After the error indication disappears, insert the disc again. If the above-mentioned solution does not solve the problem, consult your nearest ALPINE dealer.

MP3/WMA/AAC is not played back.

- Writing error occurred. The CD format is not compatible.
 - Make sure the CD has been written in a supported format. Refer to "About MP3/WMA/AAC" (pages 19 and 20), then rewrite in the format supported by this device.

Unit does not operate.

- Monitor's power is not turned on.
 - Turn on the monitor's power.
- Condensation.
 - Wait a while (about 1 hour) for the condensation to dry.

No picture is produced.

- Monitor's mode is not switched to the mode you want to see.
 - Switch to the mode you want to see.
- Monitor's parking brake lead is not connected.
 - Connect the monitor's parking brake wire and set the parking brake.
(For details, refer to the monitor's instructions.)

Playback does not start.

- Disc is loaded upside-down.
 - Check the disc and load it with the labelled side facing upward.
- Disc is dirty.
 - Clean the disc.
- A disc not able to play back with this unit is loaded.
 - Check if the disc is able to be played back.
- Parental lock is set.
 - Cancel the parental lock or change the rating level.

Picture is unclear or noisy.

- Disc is being fast-forwarded or fast-reversed.
 - The picture may be slightly disturbed, but this is normal.
- Vehicle's battery power is weak.
 - Check the battery power and wiring.
(The unit may malfunction if the battery power is under 11 volts with a load applied.)
- Monitor's fluorescent tube is worn.
 - Replace the monitor's fluorescent tube.

Image stops sometimes.

- Disc is scratched.
 - Replaced with a non-scratched disc.

Playing back a DRM protected DivX® File

Some operations cannot be performed while displaying the following message.

"Authorization Error This player is not authorized to play this video:"

- If an unauthorized DRM protected DivX® file is played back, the following message is displayed for 2 seconds: "Authorization Error This player is not authorized to play this video". This means the file's registration code does not match the player's and cannot be played back. After the message has been displayed, the beginning of the next file will automatically begin playing.

"Rental expired"

- A DivX® rental is set for a fixed number of viewings. If viewing time has counted down to 0, "Rental expired" is displayed for 2 seconds. This indicates that the file can no longer be played. After the message has been displayed, the beginning of the next file will automatically begin playing.

"Rental Countdown OK?"

- While playing back a rental file, if B.SKIP or ENTER is selected in the file selection menu, "Rental Countdown OK?" is displayed. The rental file playback is interrupted (viewing time is reduced by 1). To confirm stopping playback, touch [Yes], or touch [No] to continue playing the file.

"View DivX® VOD Rental

This rental has (remaining times) views left.

Do you want to use one of your (remaining times) views now?"

- If audio/visual times still remain, the remaining number of playback times is displayed. To play back, touch [Yes]. If the next file is to be played back, touch [No].

Indication for CD/MP3/WMA/AAC

No Disc

- No disc is inserted.
 - Insert a disc.
- Although a disc is inserted, "No Disc" is displayed and the unit does not start to play or eject the disc.
 - Remove the disc by following these steps:
Press ▲ for at least 3 seconds.

Mech Error

Loading Error

Eject Error

- Mechanism error.
 - 1) Press ▲ and eject the disc.
If not ejecting, consult your Alpine dealer.
 - 2) When the error indication remains after ejecting, press ▲ again.
If the error indication still does not turn off after pressing ▲ for a few times, consult your Alpine dealer.

Disc Error

- Scratched disc, contaminated disc/poor recording/disc incompatible with this unit.
 - Press ▲.
 - Change the disc.

Protect

- A copy-protected WMA file was played back.
 - You can only play back non-copy-protected files.

Unsupported

- A sampling rate/bit rate not supported by the unit is used.
 - Use a sampling rate/bit rate that is supported by the unit.

Indication for DVD/Video CD

No Disc

- No disc is inserted.
 - Insert a disc.
- Although a disc is inserted, “No Disc” is displayed and the unit does not start to play or eject the disc.
 - Remove the disc by following these steps:
 - Press ▲ for at least 3 seconds.



- Button operation on the unit or remote control (optional) is not possible.
 - For some discs or playing modes, certain operations are not possible. This is not a malfunction.

Mech Error

Loading Error

Eject Error

- Mechanism error.
 - 1) Press ▲ and eject the disc.
 - If not ejecting, consult your Alpine dealer.
 - 2) When the error indication remains after ejecting, press ▲ again.
 - If the error indication still does not turn off after pressing ▲ for a few times, consult your Alpine dealer.

Disc Error

- Scratched disc, contaminated disc/poor recording/disc incompatible with this unit.
 - Press ▲.
 - Change the disc.

Regional Code Violation

- Disc does not match regional code number.
 - Load a disc that matches the regional code number.

Eject disc before using DVD-Setup.

- The DVD setup operation was attempted when a disc is inserted in the unit.
 - Eject the disc before the DVD setup operation.

Unsupported

(DivX® mode)

- A sampling rate/bit rate not supported by the unit is used.
 - Use a sampling rate/bit rate that is supported by the unit.

Indication for CD changer

HI-TEMP

- Protective circuit is activated due to high temperature.
 - The indicator will disappear when the temperature returns to within operation range.

Error 01

- Malfunction in the CD Changer.
 - Consult your Alpine dealer. Press the magazine eject button and pull out the magazine.
 - Check the indication. Insert the magazine again.
 - If the magazine cannot be pulled out, consult your Alpine dealer.
- Magazine ejection not possible.
 - Press the magazine eject button. If the magazine does not eject, consult your Alpine dealer.

Error 02

- A disc is left inside the CD Changer.
 - Press the Eject button to activate the eject function. When the CD Changer finishes the eject function, insert an empty CD magazine into the CD Changer to receive the disc left inside the CD Changer.

No Magazine

- No magazine is loaded into the CD Changer.
 - Insert a magazine.

No Disc

- No indicated disc.
 - Choose another disc.

Indication for USB Memory/Portable audio player

Error 01

- Database error or decoder error.
 - You can solve the problem by switching the source.

Error 02

- Communication error or boot error, etc.
 - You can solve the problem by reconnecting the USB memory/Portable audio player or changing source.

Error 03

- The Portable audio player is not verified.
 - You can solve the problem by reconnecting the Portable audio player.
-

Current Error

- Abnormal current is run to the USB connector device.
 - You can solve the problem by switching the source.
-

Device Error

- A USB device that is not supported by the unit is connected.
 - Connect a USB device that is supported by the unit.
-

No USB Device

- A USB Memory/Portable audio player is not connected.
 - Make sure the USB Memory device is correctly connected and the cable is not excessively bent.
-

No Song

- No song (file) is stored in the USB Memory/Portable audio player.
 - Connect the USB Memory device/Portable audio player after storing songs (files).
-

Unsupported

- A sampling rate/bit rate not supported by the unit is used.
 - Use a sampling rate/bit rate that is supported by the unit.
-

Protect

- A copy-protected WMA file was played back.
 - You can only play back non-copy-protected files.
-

Indication for iPod Mode

No USB Device

- The iPod/iPhone is not connected.
 - Make sure the iPod/iPhone is correctly connected (refer to “Connections”).
 - Make sure the cable is not bent excessively.
-

No Song

- There are no songs in the iPod/iPhone.
 - Download songs to the iPod/iPhone and connect to the IVA-D511RB/IVA-D511R.
-

Error 01

- Database error or decoder error.
 - You can solve the problem by switching the source.
-

Error 02

- Communication error or boot error, etc.
 - You can solve the problem by reconnecting the iPod/iPhone or changing source.
-

Error 03

- The iPod/iPhone is not verified.
 - You can solve the problem by reconnecting the iPod/iPhone.
-

Current Error

- Abnormal current is run to the USB connector device.
 - You can solve the problem by switching the source.
-

USB Device Error

- A USB device that is not supported by the unit is connected.
 - Connect a USB device that is supported by the unit.
-

Specifications

MONITOR SECTION

Screen Size	7.0"
LCD Type	Transparent type TN LCD
Operation System	TFT active matrix
Number of Picture Elements	384,000 pcs. (800 × 480)
Effective Number of Picture Elements	99.99% or more
Illumination System	LED

FM TUNER SECTION

Tuning Range	87.5 – 108.0 MHz
Mono Usable Sensitivity	8.1 dBf (0.7 μ V/75 ohms)
50 dB Quieting Sensitivity	12 dBf (1.1 μ V/75 ohms)
Alternate Channel Selectivity	80 dB
Signal-to-Noise Ratio	65 dB
Stereo Separation	35 dB
Capture Ratio	2.0 dB

MW TUNER SECTION

Tuning Range	531 – 1,602 kHz
Sensitivity (IEC Standard)	25.1 μ V/28 dBf

LW TUNER SECTION

Tuning Range	153 – 281 kHz
Sensitivity (IEC Standard)	31.6 μ V/30 dBf

USB SECTION

USB requirements	USB 1.1/2.0
Max. Power Consumption	500mA
USB Class	USB (Play From Device)/ USB (Mass Storage Class)
File System	FAT12/16/32
MP3 Decoding	MPEG-1/2 AUDIO Layer-3
WMA Decoding	Windows Media™ Audio
AAC Decoding	AAC-LC format “.m4a” file
Number of Channels	2-Channel (Stereo)
Frequency Response*	5-20,000 Hz (\pm 1 dB)
Total Harmonic Distortion	0.008% (at 1 kHz)
Dynamic Range	95 dB (at 1 kHz)
Signal-to-Noise Ratio	105 dB
Channel Separation	85 dB (at 1 kHz)

* Frequency response may differ depending on the encoder software/bit rate.

CD/DVD SECTION

Frequency Response	5 – 20,000 Hz
Wow & Flutter (% WRMS)	Below measurable limits
Total Harmonic Distortion	0.008% (at 1 kHz)
Dynamic Range	95 dB (at 1 kHz)
Channel Separation	85 dB (at 1 kHz)
Signal system	NTSC/PAL
Horizontal resolution	500 lines or greater
Video output level	1Vp-p (75 ohms)
Video S/N ratio	DVD: 60 dB
Audio S/N ratio	105 dB

PICKUP

Wave length	DVD: 666 nm CD: 785 nm
Laser power	CLASS II

GENERAL

Power Requirement	14.4 V DC (11–16 V allowable)
Operating temperature	+32°F to +113°F (0°C to +45°C)
Maximum Power Output	50 W × 4
Output Voltage	2,000 mV/10k ohms
Weight	2.7 kg (5 lbs. 15 oz)
Audio output level	
Preout (Front, Rear):	2V/10k ohms (max.)
Preout (Subwoofer):	2V/10k ohms (max.)
AUX OUT:	1.2V/10k ohms
Ai-NET:	850 mV

CHASSIS SIZE

Width	178 mm (7")
Height	50 mm (2")
Depth	165 mm (6-1/2")

- Due to continuous product improvement, specifications and design are subject to change without notice.
- The LCD panel is manufactured using an extremely high precision manufacturing technology. Its effective pixel ratio is over 99.99%. This means that there is a possibility that 0.01% of the pixels could be either always ON or OFF.

CAUTION

**CLASS 1
LASER PRODUCT**

(Bottom side of player)

CAUTION-Laser radiation when open, DO NOT STARE INTO BEAM

(Bottom side of player)

Installation and Connections

Before installing or connecting the unit, please read the following and pages 5 to 10 of this manual thoroughly for proper use.

Warning

MAKE THE CORRECT CONNECTIONS

Failure to make the proper connections may result in fire or product damage.

USE ONLY IN CARS WITH A 12 VOLT NEGATIVE GROUND.

(Check with your dealer if you are not sure.) Failure to do so may result in fire, etc.

BEFORE WIRING, DISCONNECT THE CABLE FROM THE NEGATIVE BATTERY TERMINAL.

Failure to do so may result in electric shock or injury due to electrical shorts.

DO NOT ALLOW CABLES TO BECOME ENTANGLED IN SURROUNDING OBJECTS.

Arrange wiring and cables in compliance with the manual to prevent obstructions when driving. Cables or wiring that obstruct or hang up on places such as the steering wheel, shift lever, brake pedals, etc. can be extremely hazardous.

DO NOT SPLICE INTO ELECTRICAL CABLES.

Never cut away cable insulation to supply power to other equipment. Doing so will exceed the current carrying capacity of the wire and result in fire or electric shock.

DO NOT DAMAGE PIPE OR WIRING WHEN DRILLING HOLES.

When drilling holes in the chassis for installation, take precautions so as not to contact, damage or obstruct pipes, fuel lines, tanks or electrical wiring. Failure to take such precautions may result in fire.

DO NOT USE BOLTS OR NUTS IN THE BRAKE OR STEERING SYSTEMS TO MAKE GROUND CONNECTIONS.

Bolts or nuts used for the brake or steering systems (or any other safety-related system), or tanks should NEVER be used for installations or ground connections. Using such parts could disable control of the vehicle and cause fire etc.

KEEP SMALL OBJECTS SUCH AS BOLTS OR SCREWS OUT OF THE REACH OF CHILDREN.

Swallowing them may result in serious injury. If swallowed, consult a physician immediately.

DO NOT INSTALL IN LOCATIONS WHICH MIGHT HINDER VEHICLE OPERATION, SUCH AS THE STEERING WHEEL OR SHIFT LEVER.

Doing so may obstruct forward vision or hamper movement etc. and results in serious accident.

IMPORTANT

Please record the serial number of your unit in the space provided below and keep it as a permanent record. The serial number plate is located on the bottom of the unit.

Caution

HAVE THE WIRING AND INSTALLATION DONE BY EXPERTS.

The wiring and installation of this unit requires special technical skill and experience. To ensure safety, always contact the dealer where you purchased this product to have the work done.

USE SPECIFIED ACCESSORY PARTS AND INSTALL THEM SECURELY.

Be sure to use only the specified accessory parts. Use of other than designated parts may damage this unit internally or may not securely install the unit in place. This may cause parts to become loose resulting in hazards or product failure.

ARRANGE THE WIRING SO IT IS NOT CRIMPED OR PINCHED BY A SHARP METAL EDGE.

Route the cables and wiring away from moving parts (like the seat rails) or sharp or pointed edges. This will prevent crimping and damage to the wiring. If wiring passes through a hole in metal, use a rubber grommet to prevent the wire's insulation from being cut by the metal edge of the hole.

DO NOT INSTALL IN LOCATIONS WITH HIGH MOISTURE OR DUST.

Avoid installing the unit in locations with high incidence of moisture or dust. Moisture or dust that penetrates into this unit may result in product failure.

Precautions

- Be sure to disconnect the cable from the (-) battery post before installing your IVA-D511RB/IVA-D511R. This will reduce any chance of damage to the unit in case of a short-circuit.
- Be sure to connect the colour coded leads according to the diagram. Incorrect connections may cause the unit to malfunction or damage to the vehicle's electrical system.
- When making connections to the vehicle's electrical system, be aware of the factory installed components (e.g. on-board computer). Do not tap into these leads to provide power for this unit. When connecting the IVA-D511RB/IVA-D511R to the fuse box, make sure the fuse for the intended circuit of the IVA-D511RB/IVA-D511R has the appropriate amperage. Failure to do so may result in damage to the unit and/or the vehicle. When in doubt, consult your ALPINE dealer.
- The IVA-D511RB/IVA-D511R uses female RCA-type jacks for connection to other units (e.g. amplifier) having RCA connectors. You may need an adaptor to connect other units. If so, please contact your authorized ALPINE dealer for assistance.
- Be sure to connect the speaker (-) leads to the speaker (-) terminal. Never connect left and right channel speaker cables to each other or to the vehicle body.
- The Display must be completely retracted in the casing when installing. If it is not, problems may occur.
- When installing in automobiles, make sure the Display can open/close without coming in contact with the shift lever.

SERIAL NUMBER: _____
INSTALLATION DATE: _____
INSTALLATION TECHNICIAN: _____
PLACE OF PURCHASE: _____

Installation

Caution

Do not block the unit's fan or heat sink, thus preventing air circulation. If blocked, heat will accumulate inside the unit and may cause a fire.

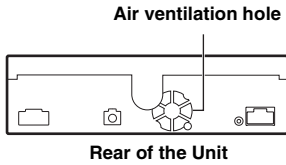

Installing the Monitor

Installation Location

Before deciding on the mounting location, check that opening and closing the display will not hamper shifting lever in that position.

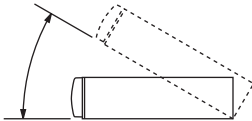

- Install at an angle of within 30 degrees from the horizontal.
- The monitor's angle is set to 90 degrees at the factory. Depending on the car, the monitor may hit the dashboard when opened. The monitor's angle can be adjusted and stored in memory so that the monitor will not hit the dashboard when opening. For adjusting the monitor, refer to "Adjusting the Monitor Angle" on page 39. Even when the vehicle's battery power is removed, the adjusted monitor angle remains stored in memory.

1

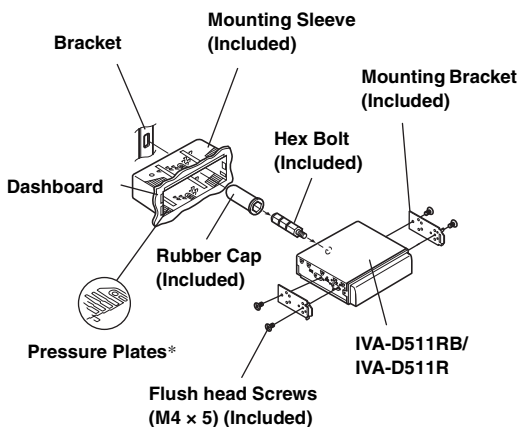

Slide the mounting sleeve into the dashboard. Install the supplied bracket on the monitor.

- Make sure to use the supplied Flush head screw (M4 x 5) to install the monitor. If you use another screw to install the monitor, it may cause a malfunction.

* If the installed mounting sleeve is loose in the dashboard, the pressure plates may be bent slightly to remedy the problem.

2

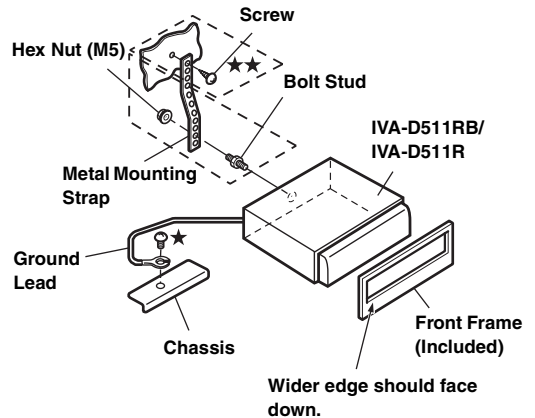

When your vehicle has the Bracket, mount the long hex bolt onto the rear panel of the IVA-D511RB/IVA-D511R and put the Rubber Cap on the hex bolt. If your vehicle does not have the Mounting Support, reinforce the monitor unit with the metal mounting strap (not supplied). Secure the ground lead of the unit to a clean metal spot using a screw (★) already attached to the vehicle's chassis.

- For the screw marked ★ ★, use an appropriate screw for the chosen mounting location.

Connect each input lead coming from an amplifier or equalizer to the corresponding output lead coming from the left rear of the IVA-D511RB/IVA-D511R. Connect all other leads of the IVA-D511RB/IVA-D511R according to details described in the Connections section.

3

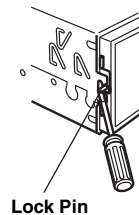

Slide the IVA-D511RB/IVA-D511R into the dashboard. When the unit is in place, make sure the locking pins are fully seated in the down position. This can be done by pressing firmly in on the unit while pushing the locking pin down with a small screwdriver. This ensures that the unit is properly locked and will not accidentally come out from the dashboard. Install the supplied Front Frame.

Removal

1. Use a small screwdriver (or similar tool) to push the locking pins to the "up" position (see Step 3). As each pin is unlocked, gently pull out on the unit to make sure it does not re-lock before unlocking the second pin.
2. Pull the unit out, keeping it unlocked as you do so.

< JAPANESE CAR >

To install using the vehicle's genuine bracket.

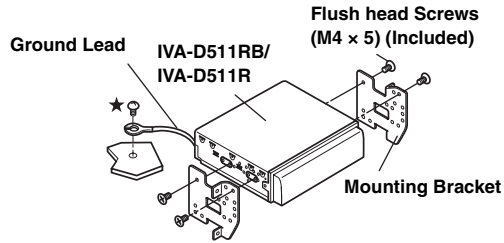

- Make sure to use the supplied flush head screw (M4 x 5) to install the monitor.
If you use another screw to install the monitor, it may cause a malfunction. However, only if you cannot install with the flush head screws (M4 x 5), use the supplied screw (M4 x 6).

Connection Diagram of SPST Switch (Sold Separately)

(If the ACC power supply is not available)

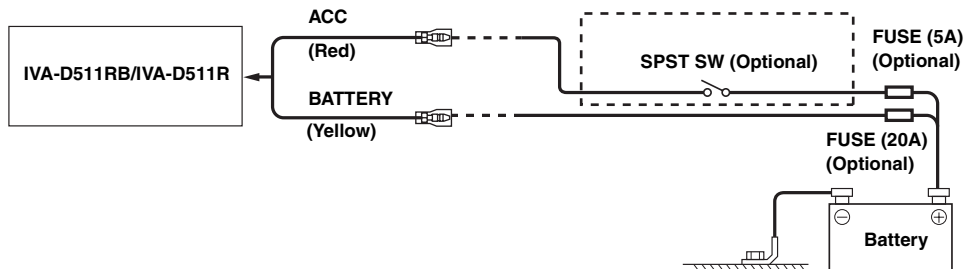

- If your vehicle has no ACC power supply, add an SPST (Single-Pole, Single-Throw) switch (sold separately) and fuse (sold separately).
- The diagram and the fuse amperage shown above are in the case when IVA-D511RB/IVA-D511R is used individually.
- If the switched power (ignition) lead of the IVA-D511RB/IVA-D511R is connected directly to the positive (+) post of the vehicle's battery, the IVA-D511RB/IVA-D511R draws some current (several hundred milliamperes) even when its switch is placed in the OFF position and the battery may be discharged.

To prevent external noise from entering the audio system.

- Locate the unit and route the leads at least 10 cm away from the car harness.
- Keep the battery power leads as far away from other leads as possible.
- Connect the ground lead securely to a bare metal spot (remove any paint, dirt or grease if necessary) of the car chassis.
- If you add an optional noise suppressor, connect it as far away from the unit as possible. Your Alpine dealer carries various noise suppressors, contact them for further information.
- Your Alpine dealer knows best about noise prevention measures so consult your dealer for further information.

Connections

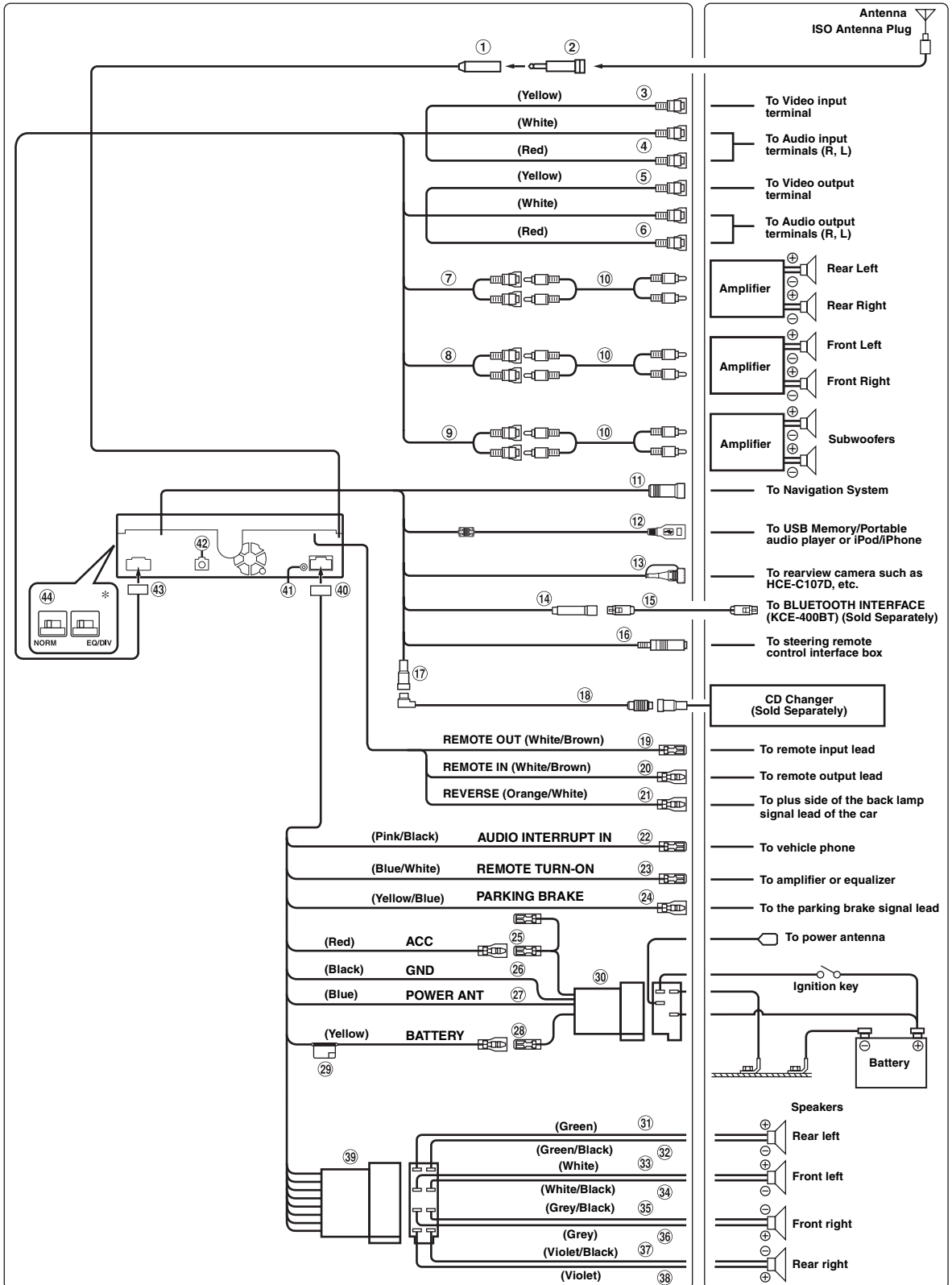

• Set the system switch to "NORM" when only a changer is connected (when the Ai-NET compatible equalizer is not used).
When the IMPRINT audio processor is connected, set to EQ/DIV position.

* The system switches are located on the right of the unit (if the front panel is viewed from the front).

- ① **Antenna Receptacle**
- ② **ISO/JASO Antenna Adapter (sold separately)**
ISO/JASO Antenna Adaptor may be required, depending on the vehicle.
- ③ **Video Output Connector (AUX OUTPUT) (Yellow)**
Output the video.
- ④ **Audio Output Connectors (AUX OUTPUT)**
RED is right and WHITE is left output the audio.
- ⑤ **Video Input/Camera Input RCA Connector (AUX/CAMERA IN) (Yellow)**
Input the AUX video or use when connecting a rearview camera with RCA Output connector.
 - Set "AUX" in "Setting the Rear Camera Input" (page 44) when connecting a rearview camera with RCA Output connector.
 - When you use this connector as normal AUX video input connector, set other than "AUX" in "Setting the Rear Camera Input" (page 44), and set "AUX1 IN" to ON in "Setting the AUX Mode".
- ⑥ **Audio Input Connector (AUX/CAMERA IN)**
RED is right and WHITE is left input the audio.
- ⑦ **Rear Output/Input RCA Connectors**
It can be used as Rear Output or Input RCA connectors. RED is right and WHITE is left.
- ⑧ **Front Output/Input RCA Connectors**
It can be used as Front Output or Input RCA connectors. RED is right and WHITE is left.
- ⑨ **Subwoofer Output RCA Connectors**
RED is right and WHITE is left.
- ⑩ **RCA Extension Cable (sold separately)**
- ⑪ **RGB Input Connector (Black)**
Connect this to the RGB output terminal of the Navigation System.
- ⑫ **USB Connector**
Connect this to an USB Memory/Portable audio player or to an iPod/iPhone. To use an iPod/iPhone, Interface cable for iPod connection is required.
 - Use the supplied USB cable. If a USB cable other than the supplied is used, correct performance cannot be guaranteed.
 - Route the USB cable away from other cables.
- ⑬ **Direct CAMERA Input Connector**
Use when the optional rearview camera (such as HCE-C107D, etc.) is connected.
 - Set "Direct" in "Setting the Rear Camera Input" (page 44) when connecting a rearview camera with Direct Output connector such as HCE-C107D.
- ⑭ **BLUETOOTH interface connector (Blue)**
Connect this to an optional BLUETOOTH INTERFACE (KCE-400BT). To use a hands-free mobile phone, an optional BLUETOOTH INTERFACE (KCE-400BT) connection is required. For details on connection, refer to the Owner's Manual of the BLUETOOTH INTERFACE (KCE-400BT). You can also connect this to an external device (such as a portable player) by using Conversion cable (KCE-237B) for building up the AUX IN (sold separately).
 - Refer to "Setting the AUX+ Mode" on page 46.
 - ON: When the external device is connected.
 - OFF: When set to OFF, AUX+ source cannot be selected.
- ⑮ **KCE-400BT Connection Cable (Included with KCE-400BT)**
- ⑯ **Steering Remote Control Interface Connector**
To steering remote control interface box.
For details about connections, consult your nearest Alpine dealer.
- ⑰ **Ai-NET Connector**
Connect this to the output or input connector of another device (CD Changer, Equalizer, etc.) equipped with Ai-NET.
 - *Cautions on connection with the DHA-S690:*
Set "Setting the Connected Head Unit (MODEL SETUP)" on the DHA-S690 to DVD CHG.
- ⑱ **Ai-NET Cable (Included with CD Changer)**
- ⑲ **Remote Control Output Lead (White/Brown)**
Connect this lead to the remote control input lead. This lead outputs the controlling signals from the remote control.
- ⑳ **Remote Control Input Lead (White/Brown)**
Connect the external Alpine product to the remote control output lead.
- ㉑ **Reverse Lead (Orange/White)**
Use only when a back-up camera is connected. Connect to the plus side of the car's reverse lamp. This lamp illuminates when the transmission is shifted into reverse (R).
With this lead properly wired, the video picture automatically switches to the back-up camera whenever the car is put into reverse (R).
- ㉒ **Audio Interrupt In Lead (Pink/Black)**
- ㉓ **Remote Turn-On Lead (Blue/White)**
Connect this lead to the remote turn-on lead of your amplifier or signal processor.
- ㉔ **Parking Brake Lead (Yellow/Blue)**
Connect this lead to the power supply side of the parking brake switch to transmit the parking brake status signals to the IVA-D511RB/IVA-D511R.
- ㉕ **Switched Power Lead (Ignition) (Red)**
Connect this lead to an open terminal on the vehicle's fuse box or another unused power source which provides (+) 12V only when the ignition is turned on or in the accessory position.
- ㉖ **Ground Lead (Black)**
Connect this lead to a good chassis ground on the vehicle. Make sure the connection is made to bare metal and is securely fastened using the sheet metal screw provided.
- ㉗ **Power Antenna Lead (Blue)**
Connect this lead to the +B terminal of your power antenna, if applicable.
 - This lead should be used only for controlling the vehicle's power antenna. Do not use this lead to turn on an amplifier or a signal processor, etc.
- ㉘ **Battery Lead (Yellow)**
Connect this lead to the positive (+) post of the vehicle's battery.

- ②⑨ **Fuse Holder (10A)**
- ③⑩ **ISO Power Supply Connector**
- ③① **Left Rear (+) Speaker Output Lead (Green)**
- ③② **Left Rear (-) Speaker Output Lead (Green/Black)**
- ③③ **Left Front (+) Speaker Output Lead (White)**
- ③④ **Left Front (-) Speaker Output Lead (White/Black)**
- ③⑤ **Right Front (-) Speaker Output Lead (Grey/Black)**
- ③⑥ **Right Front (+) Speaker Output Lead (Grey)**
- ③⑦ **Right Rear (-) Speaker Output Lead (Violet/Black)**
- ③⑧ **Right Rear (+) Speaker Output Lead (Violet)**
- ③⑨ **ISO Connector (Speaker Output)**
- ④⑩ **Power Supply Connector**
- ④① **iPod (V)/AUX Input Connector**

Input the iPhone/video compatible iPod audio/video signal or AUX video/audio signal.

 - Set “AUX2 IN” to “iPod Video” in “Setting the AUX Mode” (page 45) when an iPhone or a video compatible iPod is connected.
 - Set “AUX2 IN” to “AUX” in “Setting the AUX Mode” (page 45) when normal AUX video/audio is input.
- ④② **Digital Output Terminal (Optical)**

Use when combining fiber optic digital input compatible products. Be sure to use the Optical Digital Cable (KWE-610A) (sold separately) only.
- ④③ **AV Connector**
- ④④ **System Switch**

When connecting an equalizer or divider using Ai-NET feature, place the two switches in the EQ/DIV position. When no device is connected, leave the switch in the NORM position.

Change both switches to the left to set to the NORM position.

Change both switches to the right to set to the EQ/DIV position.

(If the front panel is viewed from the front.)

 - Do not make the two switches to different settings.
 - Be sure to turn the power off to the unit before changing the switch position.

System Example

Connect the Ai-NET compatible audio processor (Fiber optic digital compatible), Navigation system, DVD player and changer.

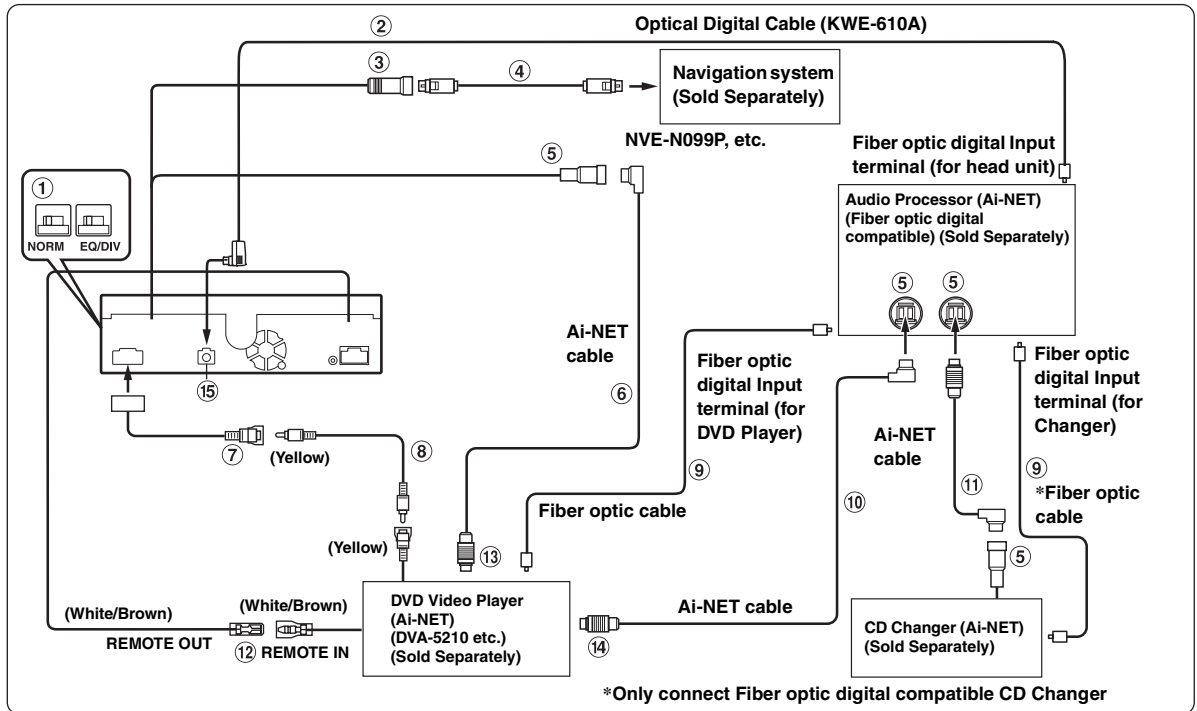

- When the fiber optic digital compatible product is connected, it is necessary to set the mode of this unit. Refer to "Setting the Digital Output" (page 46).

Please observe the following when using Fiber optic Cable.

- Do not coil the Fiber optic Cable smaller than a 30 mm radius.
- Do not place anything on top of the Fiber optic Cable.
- Be careful not to bend the Fiber optic Cable at a sharp angle.

① System Switch

When connecting an equalizer or divider using Ai-NET feature, place the two switches in the EQ/DIV position. When no device is connected, leave the switch in the NORM position.

Change both switches to the left to set to the NORM position.

Change both switches to the right to set to the EQ/DIV position.

(If the front panel is viewed from the front.)

- Do not make the two switches to different settings.
- Be sure to turn the power off to the unit before changing the switch position.

② Optical Digital Cable (KWE-610A) (Sold Separately)

③ RGB Input Connector (Black)

Connect this to the RGB output terminal of the Navigation System.

④ RGB Cable (Included with Navigation)

⑤ Ai-NET Connector

Connect this to the output or input connector of other product equipped with Ai-NET.

⑥ Ai-NET Cable (Included with DVD video player)

⑦ Video Input/Camera Input RCA Connector (AUX/CAMERA IN) (Yellow)

Input the AUX video or use when connecting a rearview camera with RCA Output connector.

- When you use this connector as normal AUX video input connector, set other than "AUX" in "Setting the Rear Camera Input" (page 44), and set "AUX1 IN" to ON in "Setting the AUX Mode".

⑧ RCA Extension Cable (Included with DVD video player)

⑨ Fiber optic Cable (Sold Separately)

⑩ Ai-NET Cable (Included with Audio Processor)

⑪ Ai-NET Cable (Included with CD Changer)

⑫ Remote Control Output Lead (White/Brown)

Connect this lead to the remote control input lead. This lead outputs the controlling signals from the remote control.

⑬ To Ai-NET Connector (Grey)

⑭ To Ai-NET Connector (Black)

⑮ Digital Output Terminal (Optical)

Connecting iPhone/Video compatible iPod and Back-up Camera

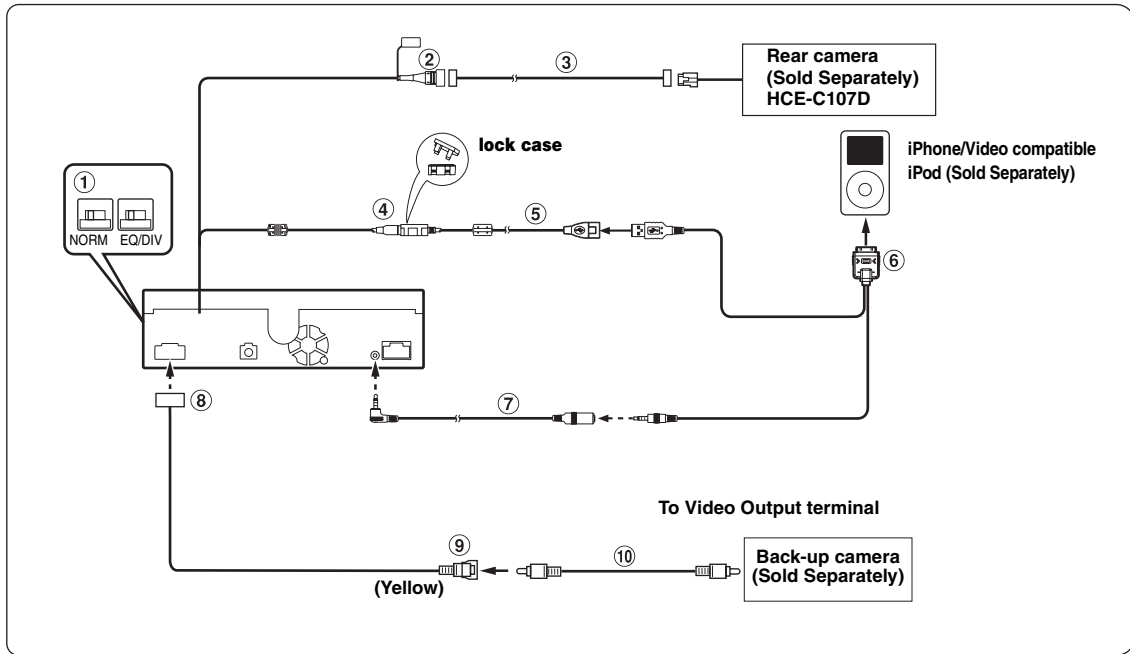

① System Switch

When connecting an equalizer or divider using Ai-NET feature, place the two switches in the EQ/DIV position. When no device is connected, leave the switch in the NORM position. Change both switches to the left to set to the NORM position. Change both switches to the right to set to the EQ/DIV position. (If the front panel is viewed from the front.)

- Do not make the two switches to different settings.
 - Be sure to turn the power off to the unit before changing the switch position.
- ② **Direct CAMERA Input Connector**
Use when the optional rearview camera (such as HCE-C107D, etc.) is connected.
- Set "Direct" in "Setting the Rear Camera Input" (page 44) when connecting a rearview camera with Direct Output connector such as HCE-C107D.

③ Camera extension cable (Included with HCE-C107D)

④ USB Connector

⑤ USB extension cable (Included)

⑥* USB 30P cable (Sold Separately)

⑦* AV extension cable (Sold Separately)

⑧ AV Connector

⑨ Video Input/Camera Input RCA Connector (AUX/CAMERA IN) (Yellow)

Input the AUX video or use when connecting a rearview camera with RCA Output connector.

- Set "AUX" in "Setting the Rear Camera Input" (page 44) when connecting a rearview camera with RCA Output connector.

⑩ RCA Extension Cable (Sold Separately)

* The optional accessory KCU-451iV contains ⑥ and ⑦, you cannot individually purchase ⑥ or ⑦.

When Connecting External Equipment

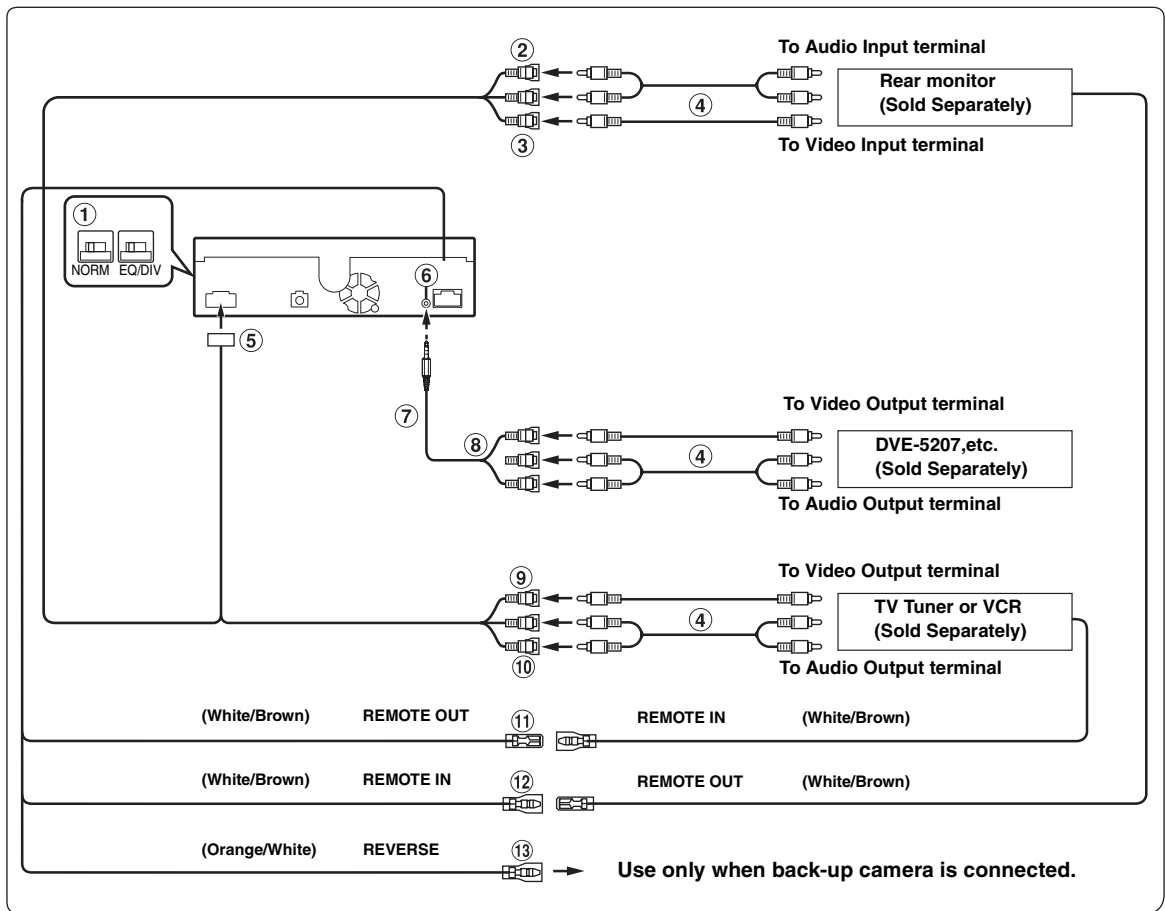

① System Switch

When connecting an equalizer or divider using Ai-NET feature, place the two switches in the EQ/DIV position. When no device is connected, leave the switch in the NORM position. Change both switches to the left to set to the NORM position. Change both switches to the right to set to the EQ/DIV position. (If the front panel is viewed from the front.)

- Do not make the two switches to different settings.
- Be sure to turn the power off to the unit before changing the switch position.

② Audio Output Connectors (AUX OUTPUT)

RED is right and WHITE is left output the audio.

③ Video Output Connector (AUX OUTPUT) (Yellow)

Output the video.

④ RCA Extension Cable (Sold separately)

⑤ AV Connector

⑥ iPod (V)/AUX Input Connector

Input the iPhone/video compatible iPod audio/video signal or AUX video/audio signal.

- Set "AUX2 IN" to "AUX" in "Setting the AUX Mode" (page 45) when normal AUX video/audio is input.
- When you use this connector as normal video/audio input connector (AUX 2 Input), an optional AV/RCA interface cable should be used. For details, refer to ⑦.

⑦ AV/RCA interface cable (4-pole mini AV plug to 3-RCA) (Sold Separately)

■ Usable 4-pole mini AV plug

Wiring convention of this system is as follows:

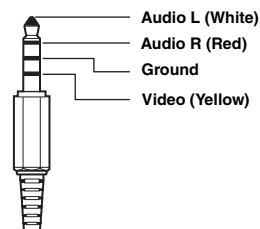

- Configuration commercially available 4-pole mini AV plugs is not unified.

⑧ **Video/Audio Input Connectors**

YELLOW is for input video, RED is right and WHITE is left input the audio.

⑨ **Video Input/Camera Input RCA Connector (AUX/CAMERA IN) (Yellow)**

Input the AUX video or use when connecting a rearview camera with RCA Output connector.

- *When you use this connector as normal AUX video input connector, set other than "AUX" in "Setting the Rear Camera Input" (page 44), and set "AUX1 IN" to ON in "Setting the AUX Mode".*

⑩ **Audio Input Connectors (AUX/CAMERA IN)**

RED is right and WHITE is left input the audio.

⑪ **Remote Control Output Lead (White/Brown)**

Connect this lead to the remote control input lead. This lead outputs the controlling signals from the remote control.

⑫ **Remote Control Input Lead (White/Brown)**

⑬ **Reverse Lead (Orange/White)**

Use only when a back-up camera is connected. Connect to the plus side of the car's reverse lamp. This lamp illuminates when the transmission is shifted into reverse (R). With this lead properly wired, the video picture automatically switches to the back-up camera whenever the car is put into reverse (R).