

30940/**/16

30941/**/16



Gebruiksaanwijzing

Notice d'emploi

Benutzerhandbuch

User manual

Manual de usuario

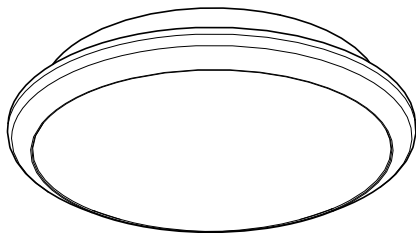

PHILIPS

Incl.

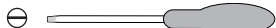
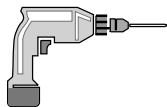
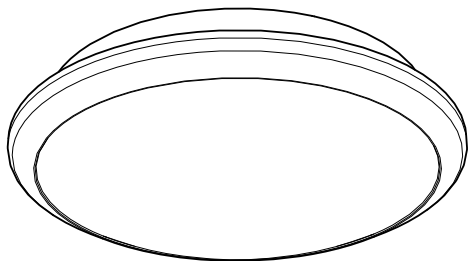

Type 1 P.4

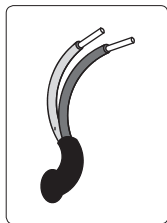
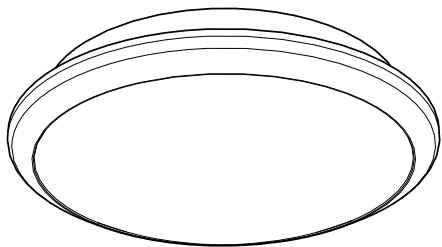

Type 2 P.8

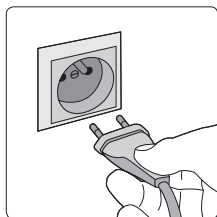
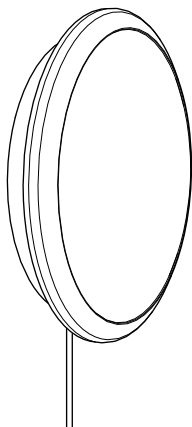

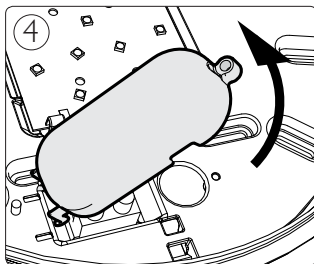
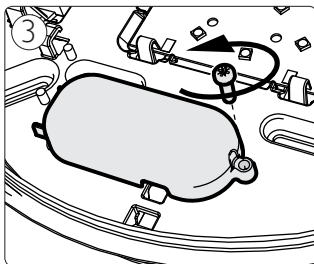
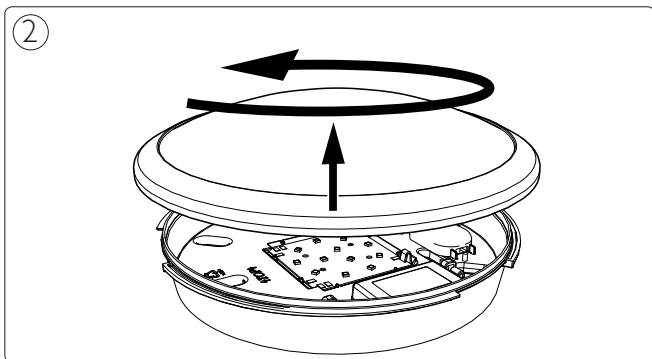
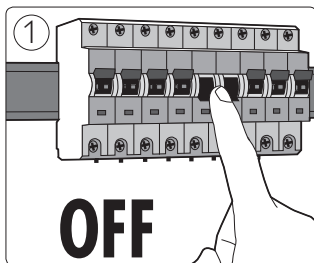
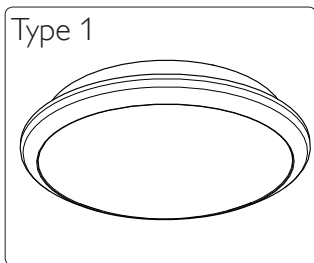

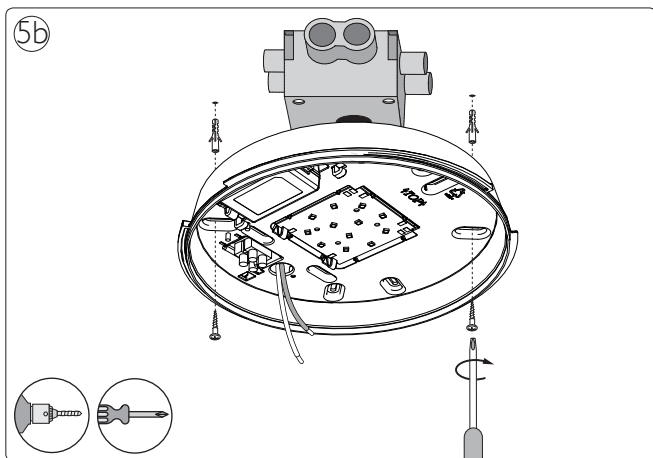
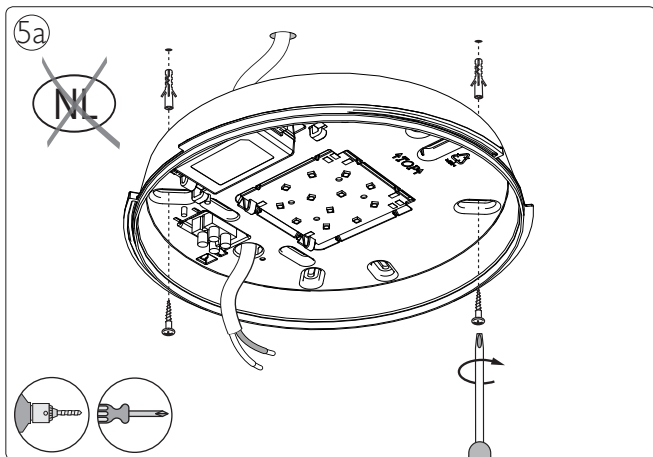

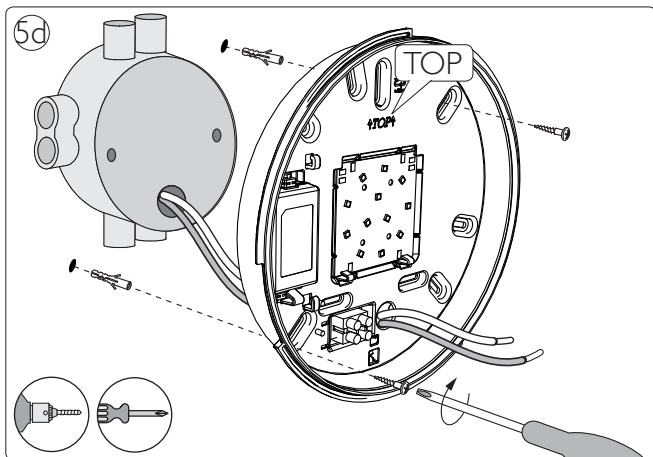
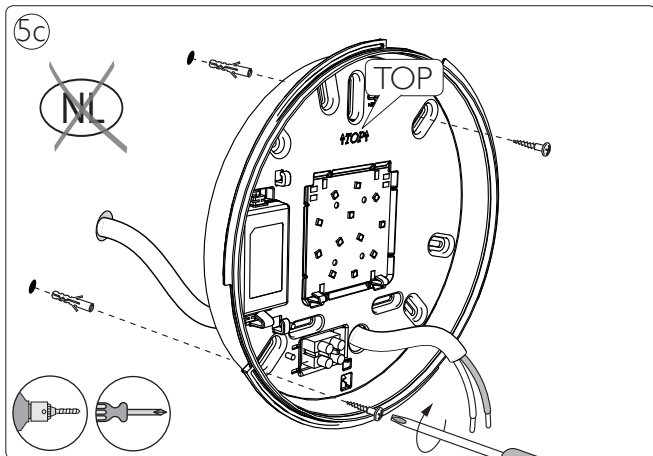

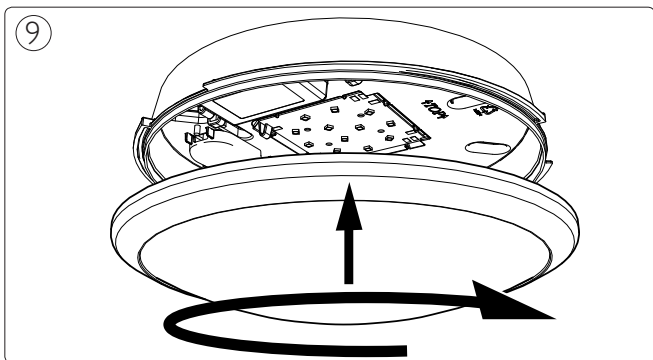
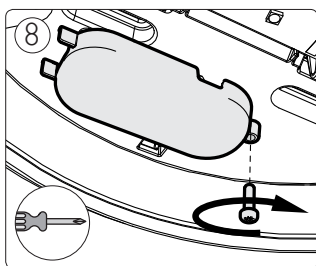
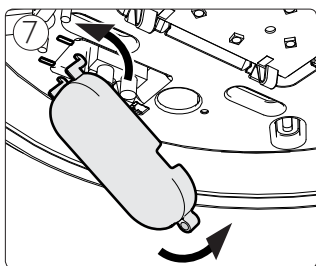
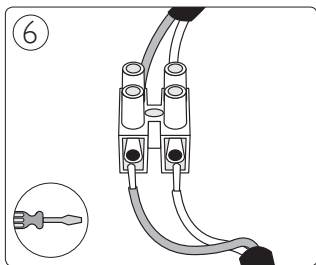

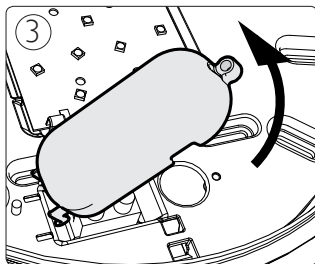
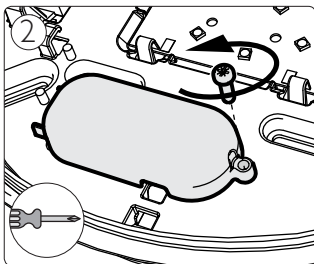
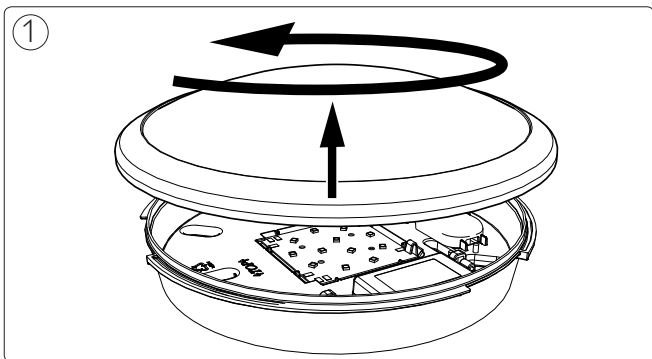
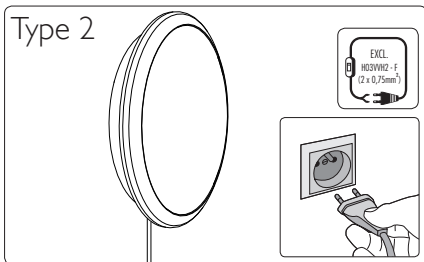

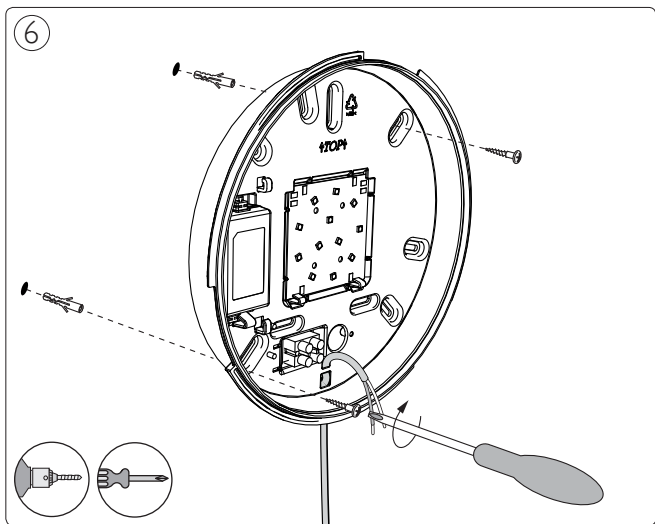
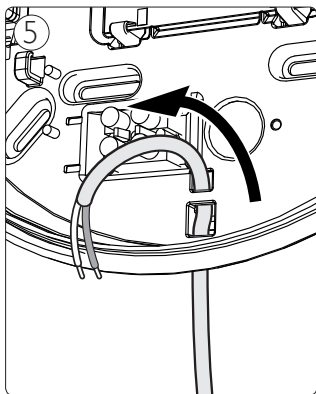
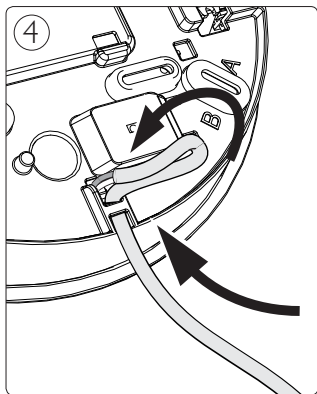

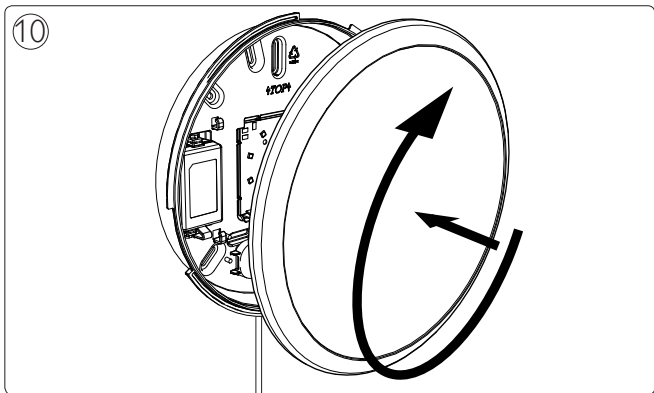
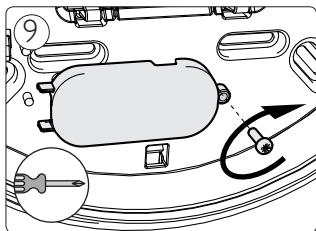
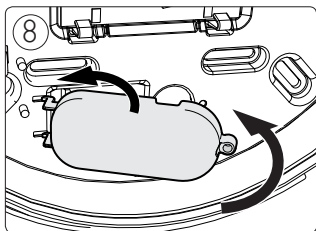
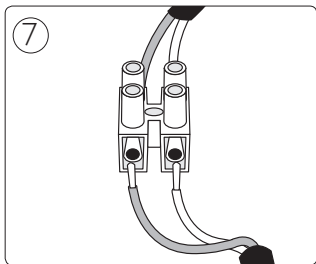

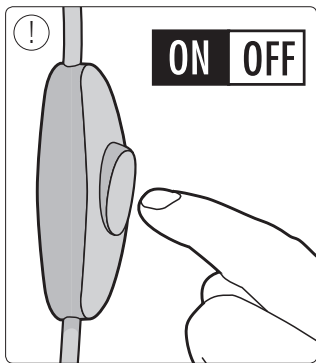
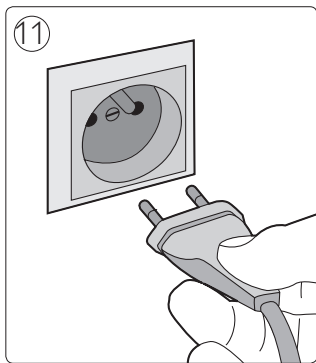



Philips Lighting Contact Centre
Int. Business Reply Service
I.B.R.S. / C.C.R.I. Numéro 10461
5600 VB Eindhoven
Pays-Bas / The Netherlands

www.philips.com/homelighting
 +800 7445 4775

4404.016.91491
Last update: 06/02/13