



**Wireless Streaming Pre-Amplifier**

**WXC-50**

**Owner's Manual (Advanced)**

---

Read "IMPORTANT SAFETY INSTRUCTIONS" described in the Owner's Manual (Basic) before using the unit.

musicCast

EN

# CONTENTS

## BEFORE USING THE UNIT 4

---

### Accessories..... 4

Preparing the remote control..... 4

Preparing the wireless antenna..... 4

### About this manual..... 4

### Features..... 5

Enjoying music easily..... 5

Sharing music with MusicCast compatible devices..... 5

### Part names and functions..... 6

Front panel..... 6

Rear panel..... 7

Remote control..... 9

Indicators on the front panel..... 10

## PREPARATIONS 11

---

### Placing the unit..... 11

Horizontal placement..... 11

Vertical placement..... 11

### Connecting an audio system..... 11

For an audio system with analog stereo audio input..... 12

For an audio system with digital optical / coaxial audio input..... 12

For other audio systems..... 13

### Connecting a power amplifier..... 13

### Connecting a subwoofer..... 14

### Connecting external devices..... 14

For an external device with digital optical audio output..... 14

For an external device with analog stereo audio output..... 14

### Connecting the power cable..... 15

### Setting the power to on/standby..... 15

### Connecting to a network..... 15

Connecting to a network wirelessly..... 15

Connecting to a wired network..... 17

### Setting the MusicCast..... 18

Installing MusicCast CONTROLLER to your mobile device..... 18

Adding the unit to the MusicCast network..... 18

## PLAYBACK 19

---

### Playing back music with MusicCast CONTROLLER..... 19

Music on a mobile device..... 19

Internet radio..... 19

Music stored on media servers (PCs/NAS)..... 20

Online streaming services..... 20

Music stored on a USB storage device..... 21

Registering the song/station being played back to a preset..... 21

### Playing back music from other devices..... 22

Listening to music from an external source..... 22

Playing back music with Bluetooth®..... 23

Playing back music with AirPlay..... 25

## OPERATING THE UNIT FROM A WEB BROWSER 27

---

### Web control using a PC..... 27

### Displaying the Web Control screen..... 27

Configuring with Windows..... 27

Configuring with Mac OS..... 27

### Operating on the Web Control screen..... 29

## CONFIGURING ADVANCED FEATURES 30

---

### Configuration from a web browser..... 30

SETTINGS1..... 30

SETTINGS2..... 31

<b>Configuration on Advanced Settings screen in mobile device app</b>	<b>34</b>
---	-----------

## **APPENDIX 37**

---

<b>Updating the unit's firmware via the network</b>	<b>37</b>
Updating with MusicCast CONTROLLER	37
Updating with a USB memory device	37
<b>Setting up the wireless connection manually</b>	<b>38</b>
<b>Restarting the unit</b>	<b>38</b>
<b>Restoring the default settings</b>	<b>38</b>
<b>Troubleshooting</b>	<b>40</b>
General	40
Network	41
Bluetooth®	42
<b>Error table of STATUS indicator</b>	<b>43</b>
<b>Glossary</b>	<b>44</b>
<b>Trademarks</b>	<b>44</b>
<b>Supported devices and file formats</b>	<b>45</b>
Supported devices	45
File formats	45
<b>Specifications</b>	<b>46</b>

# BEFORE USING THE UNIT

## Accessories

Confirm that all the following items are included in the package.

Remote control

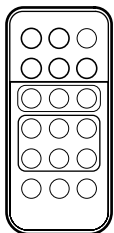

Wireless antenna

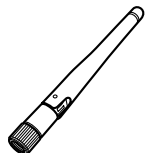

Stand x 2

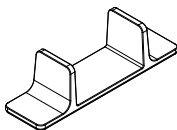

Non-skid pad (6 pads, including 2 spares)



Power cable

Owner's Manual (Basic)

## Preparing the remote control

Remove the insulation sheet of the remote control before using.

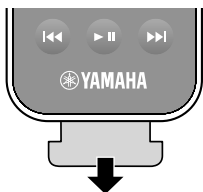

## Preparing the wireless antenna

Connect the wireless antenna and stand it upright.

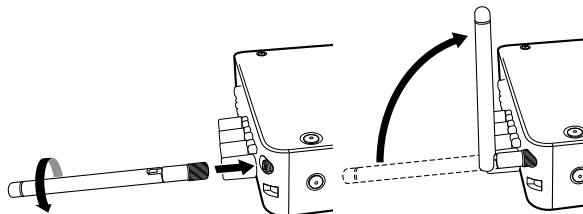

### Notice

- Do not apply excessive force on the wireless antenna. Doing so may damage the antenna.
- Check the direction that the bending joint of the antenna is able to move, and bend the antenna only in that direction.
- Do not remove the antenna.

## About this manual

- In this manual, iOS and Android mobile devices are collectively referred to as "mobile devices". The specific type of mobile device is noted in explanations as needed.
- This manual describes the iPhone, iPad and iPod Touch collectively as the "iPhone".
- Due to product improvements, specifications and appearance are subject to change without notice.
- Updates offering improved functionality of the dedicated "MusicCast CONTROLLER" app for mobile devices may become available without prior notice.

### Notice:

Indicates precautions for use to avoid the possibility of malfunction/damage to the unit.

### Note:

Indicates instructions and supplementary explanations for optimum use.

## Features

The unit is equipped with full of useful functions.

### Enjoying music easily

Using the free dedicated application "MusicCast CONTROLLER" on your mobile device such as a smartphone, you can easily select music to play back and configure the unit without the remote control. For details, search for "MusicCast CONTROLLER" on the App Store or Google Play™.

### MusicCast CONTROLLER capabilities

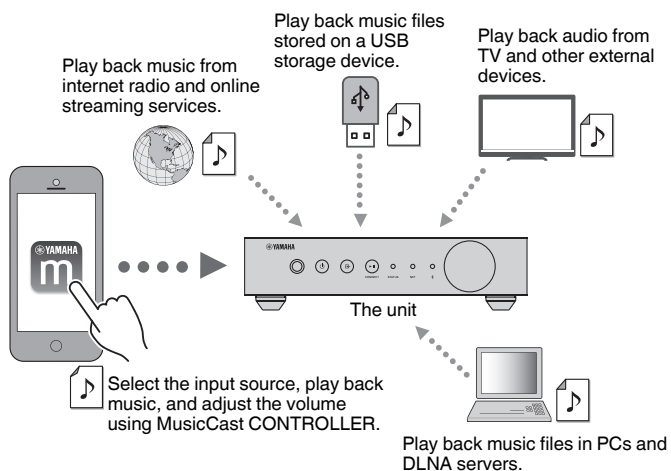

### Selecting and playing back various content

- Play back music from your mobile device
- Select an Internet radio station
- Select a streaming service
- Play back music files in PCs and DLNA servers

- Play back music files stored on a USB storage device

#### Note

In order to select music files in PCs and DLNA servers or music files stored on a USB storage device, the dedicated application "MusicCast CONTROLLER" for mobile devices is necessary.

### Operating and configuring the unit

- Select the input source, adjust the volume and mute the audio output
- Select from a wide variety of sound processing features

### Capabilities without MusicCast CONTROLLER

- Play back audio from external devices (TVs, CD players, etc.)
- Play back music files stored on a Bluetooth device, and enjoy music played back on the unit using Bluetooth speakers/headphones
- Play back iTunes or iPhone/iPad/iPod touch music via a network with AirPlay

### Sharing music with MusicCast compatible devices

By connecting the unit and MusicCast compatible devices in different rooms to a network, you can easily share and enjoy music with MusicCast compatible devices anywhere in your house.

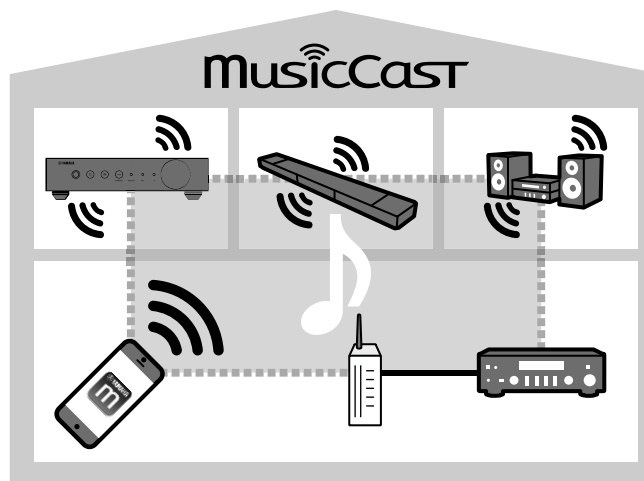

## Part names and functions

The part names and functions of the unit and the supplied remote control are as follows.

### Front panel

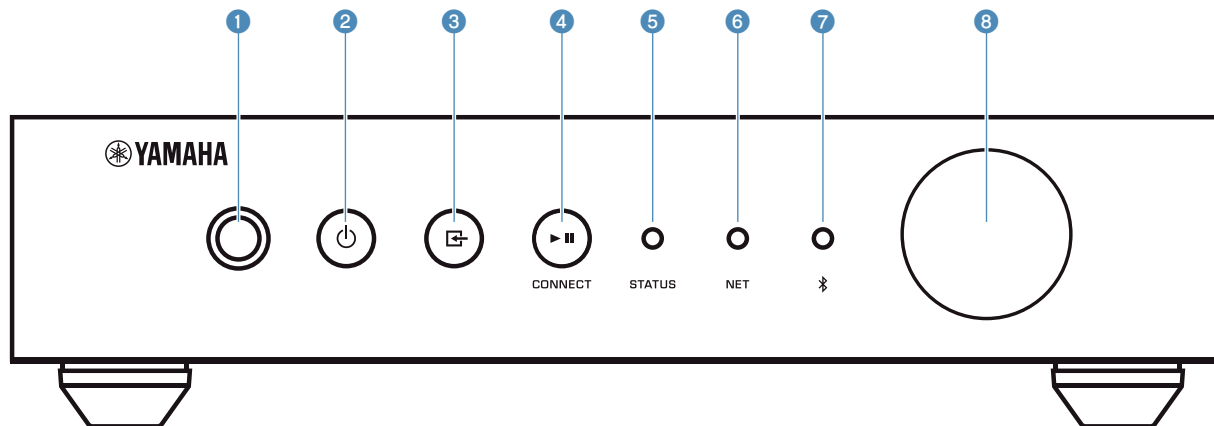

#### 1 Remote control sensor

Receives remote control signals.

#### 2 (power) key

Turns the unit's power to on/standby.

#### 3 (input) key

Selects an input source.

Holding down for 3 seconds allows the wireless network connection to be configured using the wireless LAN router's WPS button (p.16).

#### 4 (play/pause) (CONNECT) key

Resumes playback or stops playback temporarily.

Holding down for 5 seconds allows the network settings to be configured using the MusicCast CONTROLLER app (p.18).

#### 5 STATUS indicator

Indicates the selected input source and unit status depending on its color and whether it is lit or flashing.

##### Note

For details, refer to "Indicators on the front panel" (p.10)

#### 6 NET indicator

Lights up while the unit is connected to the wired or wireless (Wi-Fi) network.

#### 7 Bluetooth indicator

Lights up while the Bluetooth connection is established.

#### 8 Volume knob

Adjusts the volume.

# Rear panel

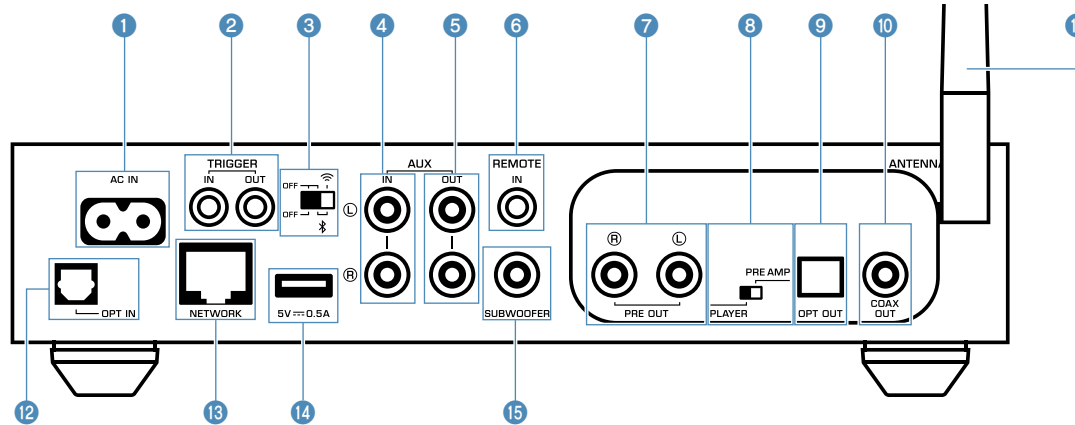

## 1 AC IN jack

For connecting the supplied power cable (p.15).

## 2 TRIGGER IN/OUT jacks

For connecting to an external device that supports the trigger function (p.13, p.14).

## 3 Wireless switch

Turns on/off wireless communications (wireless LAN connection and Bluetooth).

Position	Function
	Enables the wireless LAN and Bluetooth connection.
	Enables the Bluetooth connection only. Use a wired LAN connection if connecting to a network.
	Disables the wireless LAN and Bluetooth connection. Use a wired LAN connection if connecting to a network.

### Note

After changing this switch, be sure to disconnect the power cable from the AC wall outlet and plug it again.

## 4 AUX IN jacks

For connecting to audio components (such as audio players) equipped with analog output (p.14).

## 5 AUX OUT jacks

For connecting to audio components (such as pre-main amplifiers) equipped with analog input.

## 6 REMOTE IN jack

For connecting to an external component for remote control.

By connecting an infrared receiver to the REMOTE IN jack, you can operate the unit using the supplied remote control even if the unit is stored out of sight.

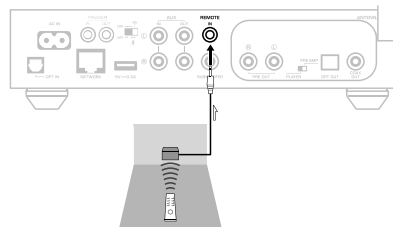

## 7 PRE OUT jacks

For connecting to audio components (such as mini-systems, Hi-Fi components, AV receivers or power amplifiers) equipped with analog input (p.12).

## 8 Mode switch

For switching the unit between player mode and preamp mode.

Mode	Function
PLAYER	The volume is controlled by audio devices connected to the PRE OUT / OPT OUT / COAX OUT jacks. The unit outputs audio at maximum volume. Additionally, some sound processing effects (Equalizer, Enhancer, Bass Extension, Direct, Monaural Downmix and Speaker Type) are disabled.
PRE AMP	The volume is controlled by the unit or by MusicCast CONTROLLER.

## 9 OPT OUT jack

For connecting to audio components equipped with optical digital input (p.12).

## 10 COAX OUT jack

For connecting to audio components equipped with coaxial digital input (p.12).

## 11 Wireless antenna

For a wireless (Wi-Fi) connection to a network and a Bluetooth connection (p.4).

**12 OPT IN jack**

For connecting to audio components equipped with optical digital output (p.14).

**13 NETWORK jack**

For a wired connection to a network (p.17).

**Note**

- When using a wireless LAN connection (Wi-Fi), a wired LAN connection is not necessary.
- When playing back high resolution contents (p.44) via the network, we recommend using the wired network connection for stable playback.

**14 USB jack**

For connecting a USB storage device (p.21).

**15 SUBWOOFER jack**

For connecting to a subwoofer with built-in amplifier (p.14).



## Remote control

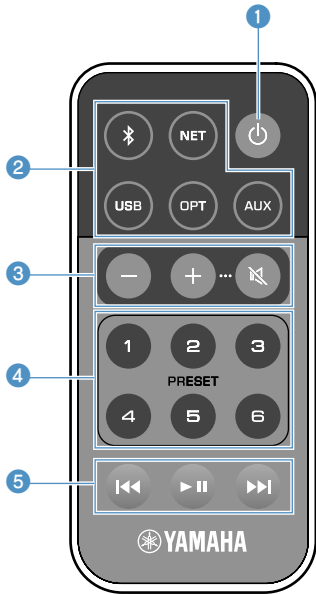

### 1 ⏻ (power) key

Turns the unit's power to on/standby.

### 2 Input source selection keys

Selects the input source for playback.

📶 (Bluetooth)	Bluetooth input
NET*	Network input
USB*	USB jack
OPT	OPT IN jack
AUX	AUX IN jack

\* In order to select content, the dedicated application "MusicCast CONTROLLER" for mobile devices is necessary.

### Note

The selected input source is indicated by the status indicator on the front panel (p.10).

### 3 Volume adjustment keys

Adjusts the volume.

+/- Adjusts the volume for playback.

🔇 (Mute) Mutes the speaker output.

### Note

To adjust the maximum volume, see "CONFIGURING ADVANCED FEATURES" (p.30).

### 4 PRESET keys

Presets PC/NAS albums or songs, Internet radio stations and streaming stations on the unit.

To register a song/station, press and hold any one of the PRESET keys (1 to 6) for 3 seconds. After a song/station is registered to a PRESET key, it can be played back by simply pressing that key (p.21).

### 5 USB/NET operation keys

Controls playback when selecting USB or NET as the input source.

⏮ Skips to the beginning of the song being played back (press and hold to skip to the previous song).

⏸ Plays/pauses.

⏭ Skips to the next song.

## Operating by the remote control

Point the remote control at the remote control sensor on the unit and remain within the operating range shown below.

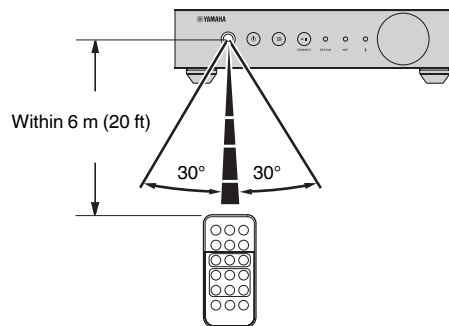

## Replacing the battery

1 While pushing the release tab in direction "A", slide out the battery holder in direction "B" as shown below.

2 Check the "+" of the battery and set it on the battery holder.

3 Insert the battery holder in the correct direction.

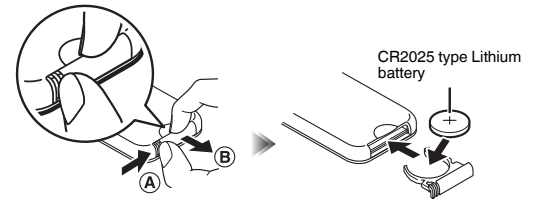

## Indicators on the front panel

The selected input source and unit status are indicated by three indicators on the front panel. Indications depending on their color and condition (lit or flashing) are shown below.

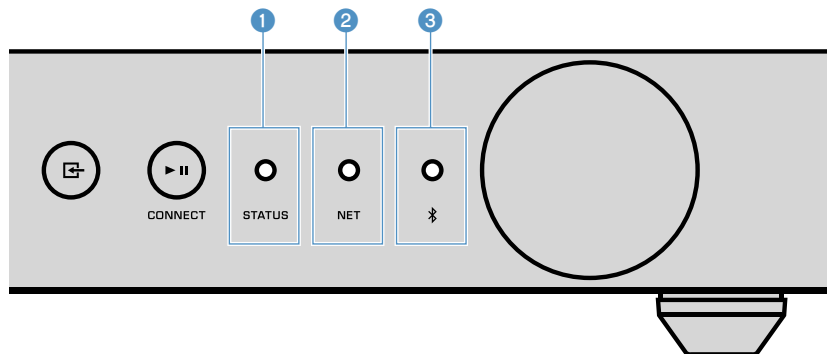

### 1 STATUS indicator

-	Unlit	Standby
● Red	Lit	Network standby or Bluetooth standby
	Flashing	Error occurred
● Blue	Lit	Bluetooth input
● Green	Lit	Network input
● Pink	Lit	AirPlay input
● Sky blue	Lit	USB input
● Purple	Lit	Optical digital input
○ White	Lit	AUX input

#### Note

- The indicator is lit with the same color as the input source selection key on the remote control.
- For details on error indications, see "Error table of STATUS indicator" (p.43).

### 2 NET indicator

-	Unlit	Standby
● Green	Lit	Network connected
	Flashing	Setting up a network connection

#### Note

For details on network connections, see "Connecting to a network" (p.15).

### 3 Ⓜ (Bluetooth) indicator

-	Unlit	Standby
● Blue	Lit	Bluetooth connected
	Flashing	Performing pairing

#### Note

For details on Bluetooth connections, see "Playing back music with Bluetooth<sup>®</sup>" (p.23).

# PREPARATIONS

## Placing the unit

Place the unit horizontally or vertically according to the place in your room.

### Note

Allow ventilation space of at least 10 cm (4 in.) on the top, side and back of the unit.

## Horizontal placement

When placing the unit horizontally, affix the non-skid pads on the feet.

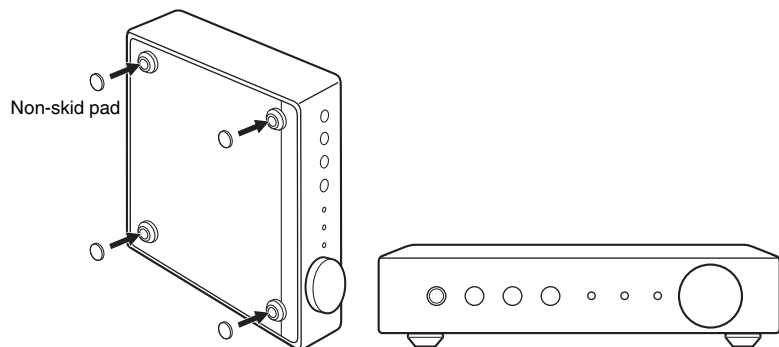

## Vertical placement

When placing the unit vertically, loosen the screws to remove the feet and attach the stands to the unit.

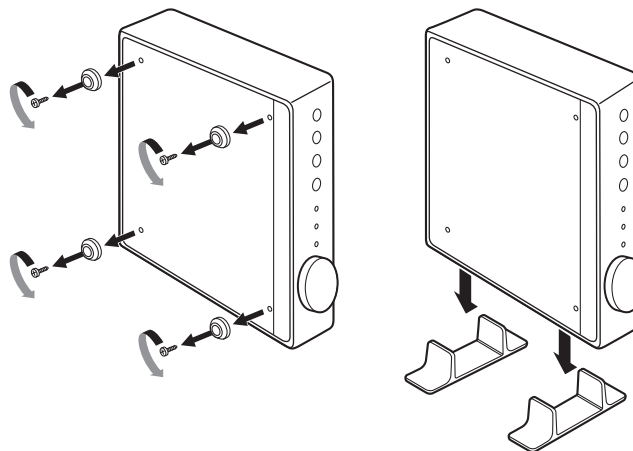

### Note

Be careful not to lose the removed feet and screws (there are 4 of each).

## Connecting an audio system

Connect an audio system with a volume control function (such as mini-systems, Hi-Fi components or AV amplifiers) to the unit.

### Note

- Flip the mode switch according to your audio system (p.7).
  - Volume control by the unit or "MusicCast CONTROLLER": PRE AMP
  - Volume control by audio system: PLAYER
- Turn the unit to standby before flipping the mode switch.

## For an audio system with analog stereo audio input

Connect an audio system to the unit with a commercially available analog stereo pin cable.

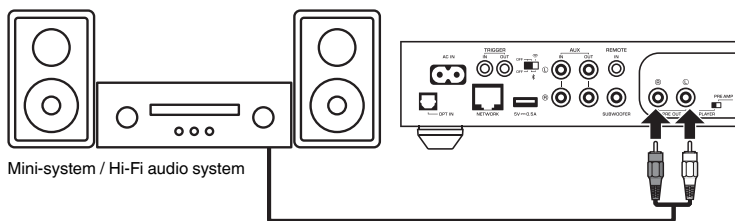

Mini-system / Hi-Fi audio system

## For an audio system with digital optical / coaxial audio input

Connect an audio system to the unit with a commercially available digital optical or digital coaxial cable.

### Note

The digital audio output from the unit cannot be recorded.

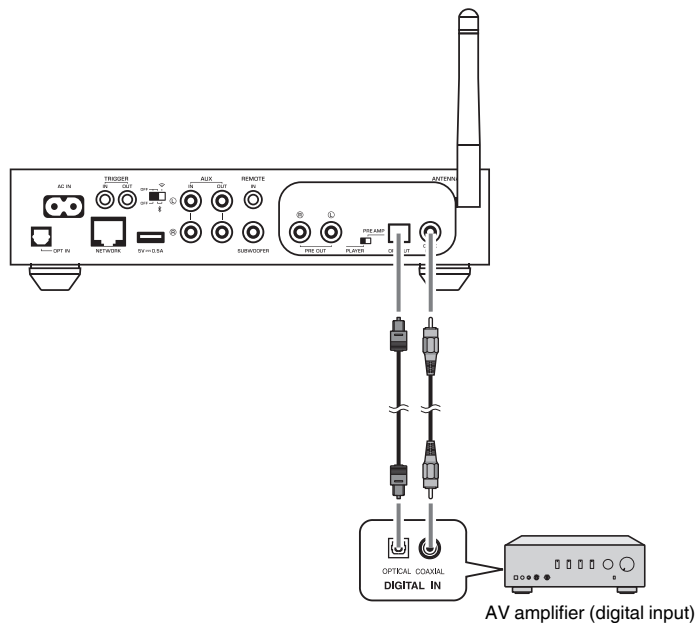

AV amplifier (digital input)

## For other audio systems

In the following connection setup which connects a Yamaha Hi-Fi amplifier (A-S series) to the unit, when the unit is turned to on or standby, the A-S series amplifier is also turned to on or standby automatically.

### Note

- Turn the unit to standby before flipping the mode switch.
- For more information about this trigger function, refer to the Owner's Manual of the A-S series amplifier.

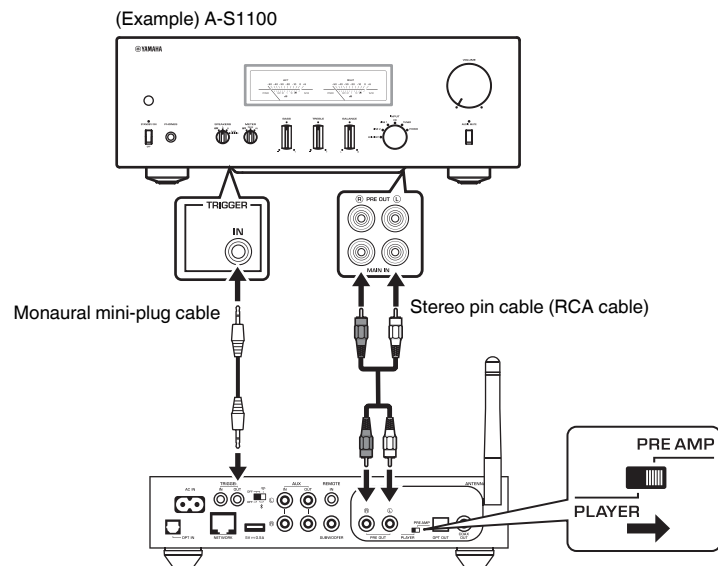

## Connecting a power amplifier

Connect audio devices without a volume control function such as power amplifiers to the unit. Set the mode switch to PRE AMP.

### Note

- To prevent loud sound or unexpected noise, before connecting a power amplifier, be sure to remove the unit's power cable from the AC wall outlet and turn off the power amplifier.
- Turn the unit to standby before flipping the mode switch.

Connect a power amplifier to the unit with a commercially available analog stereo pin cable.

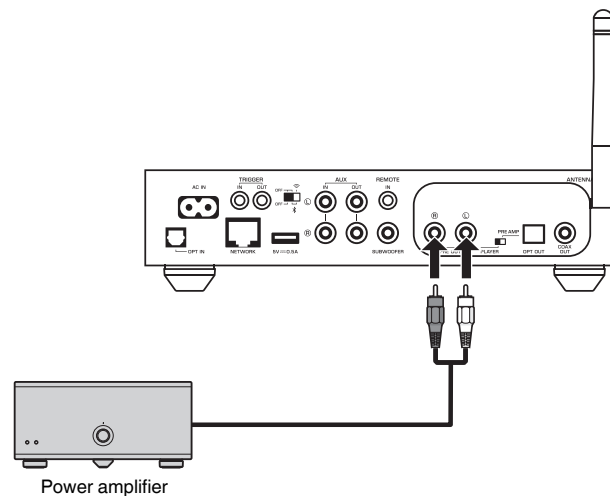

### Note

Control the volume using the volume knob on the front panel of the unit, the remote control or "MusicCast CONTROLLER".

## Connecting a subwoofer

Connect a subwoofer (with built-in amplifier) to the unit with a commercially available audio pin cable.

### Note

Before connecting a subwoofer, remove the unit's power cable from the AC wall outlet and turn off the subwoofer.

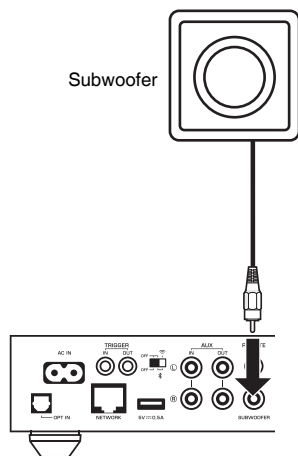

### Note

- You can adjust the volume or high frequency cut off control when the subwoofer is equipped with those functions.
- If a Yamaha subwoofer has system connection support, its power can be controlled in synchronization with the unit's power through the trigger function. If the subwoofer is connected to the unit with a commercially available mini-plug cable, switching the unit between on and standby will automatically turn the subwoofer on and off. For details, refer to the instruction manual for the subwoofer.

Yamaha subwoofer

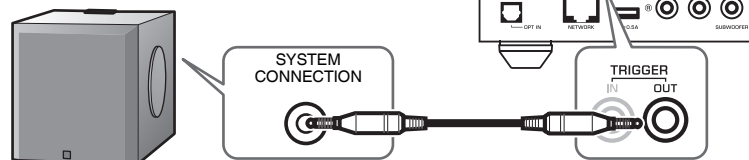

## Connecting external devices

Connect external devices such as a TV or CD player to the unit.

### For an external device with digital optical audio output

Use a commercially available digital optical cable.

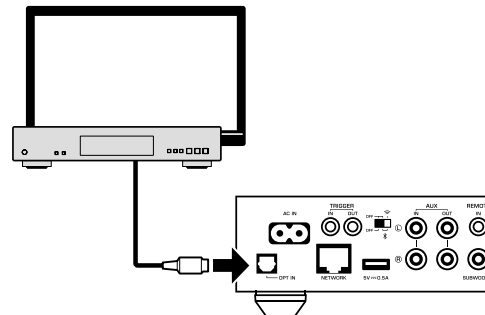

### For an external device with analog stereo audio output

Use a commercially available analog stereo pin cable.

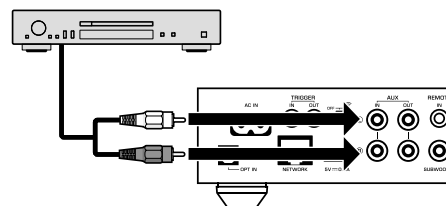

## Connecting the power cable

After all the connections are complete, plug the supplied power cable into the AC IN jack on the rear panel, and then plug the power cable to an AC wall outlet.

To an AC wall outlet

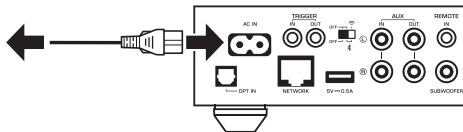

## Setting the power to on/standby

Use the  (power) key on the front panel or on the remote control to switch the unit's power between on and standby.

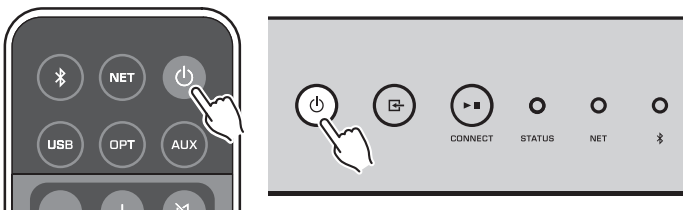

## Connecting to a network

Select whether to use a wired or wireless network connection, depending on your network environment.

### Connecting with a wireless router (access point)

Select a connection method listed below according to your network environment.

- Connecting with the MusicCast CONTROLLER
  - Follow the instructions in the MusicCast CONTROLLER screen (p.18)
- Connecting using the Wi-Fi setting of an iOS device (iPhone/iPad/iPod Touch)
  - Share the Wi-Fi settings of the iOS device (p.16)
- Connecting using the WPS push button on the wireless router (access point)
  - Set up using the WPS push button (p.16)
- Connecting with a wireless router (access point) without a WPS push button
  - Set up the wireless connection manually (p.38)

### Connecting with a wired router

- Connect using the automatic setup function of the router
  - Connect to a network by simply connecting to it with a cable (p.17)

#### Note

When playing back high resolution contents (p.44) via the network, we recommend using the wired network connection for stable playback.

## Connecting to a network wirelessly

Connect the unit to a wireless router (access point) using a wireless connection (Wi-Fi). You can also connect the unit to a wireless network with the MusicCast CONTROLLER (p.18).

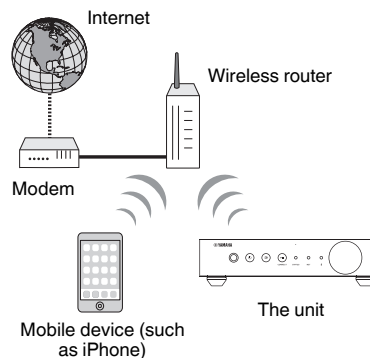

#### Note

For a wireless connection, turn on the wireless switch on the rear panel.

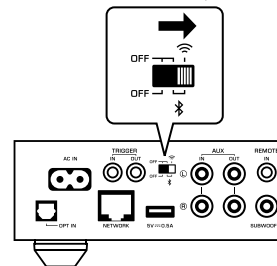

## ■ Sharing the Wi-Fi settings on an iOS device (WAC)

You can easily setup a wireless connection by applying the connection settings with WAC (Wireless Accessory Configuration) on iOS devices (iPhone/iPad/iPod touch).

Before proceeding, confirm that your iOS device is connected to a wireless router (access point).

### Note

- In order to share Wi-Fi settings, the iOS device must be installed with iOS 7 or later.
- The sharing process will reset the registered settings and specified account information on music streaming service accounts, registered presets, Bluetooth settings and bookmarks of Internet radio stations.
- The unit automatically starts WAC only at the first time of power on. When WAC does not start automatically, restore the unit to the factory default settings (p.38), and then follow the procedure below.

### 1 Turn on the unit.

The NET indicator on the front panel flashes during the sharing process.

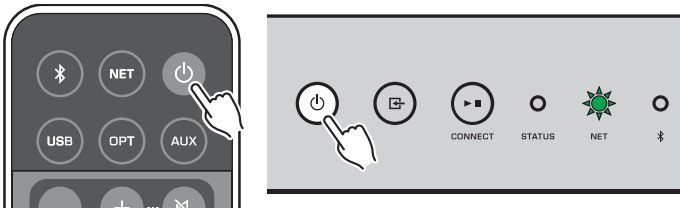

### 2 On the iOS device, select the unit as the AirPlay speaker in the Wi-Fi screen.

iOS 9 (example of English version)



The name of the unit

### 3 Select the network (access point) of which you want to share the settings with the unit.

When the sharing process finishes, the unit is automatically connected to the selected network (access point).

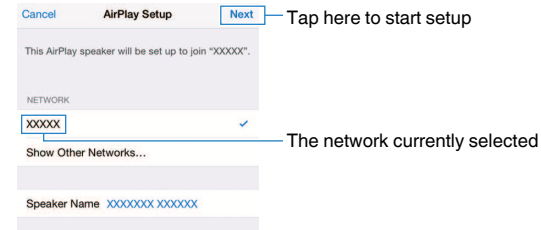

## ■ Using the WPS push button configuration (WPS)

You can easily set up a wireless connection with one push of the wireless router's WPS button.

### 1 Turn on the unit.

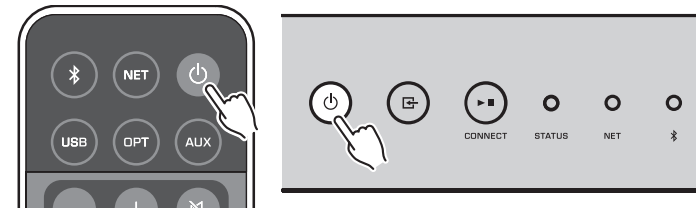

### 2 Hold down INPUT on the front panel for 3 seconds.

The NET indicator on the front panel flashes during the connection process.

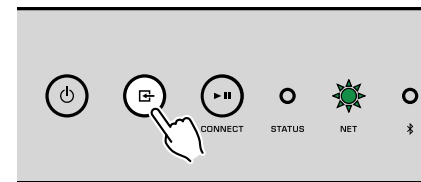



### 3 Press the WPS button on the wireless router (access point).

When the connection process finishes, the NET indicator changes to lit in green.

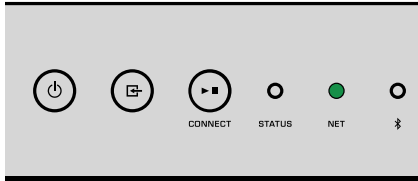

#### Note

The WPS button on the wireless router (access point) must be pressed within 2 minutes after completing Step 2. After 2 minutes have passed, the setup operation is canceled.

## Connecting to a wired network

Connect the unit to your router with a commercially-available STP network cable (CAT-5 or higher straight cable).

#### Note

When playing back high resolution contents (p.44) via the network, we recommend using the wired network connection for stable playback.

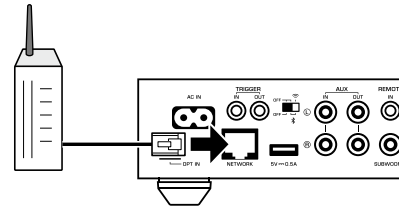

Turn on the unit. The network settings will be automatically configured.

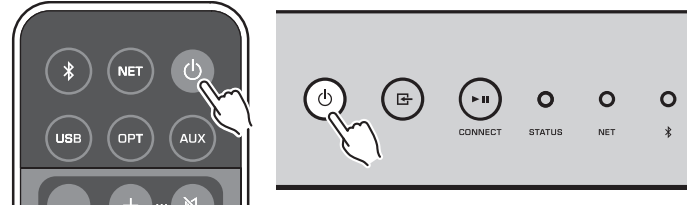

When the connection is established, the NET indicator on the front panel changes to lit in green.

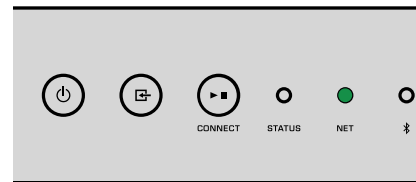

## Setting the MusicCast

MusicCast allows you to share music among all of your rooms with a variety of devices.

You can operate the unit easily as well as enjoy music from your smartphone, PC, NAS drive and music streaming service anywhere in your house with one easy-to-use application: “MusicCast CONTROLLER” for mobile devices. For more details and a lineup of MusicCast compatible products, visit the Yamaha website.

## Installing MusicCast CONTROLLER to your mobile device

Search for the free application “MusicCast CONTROLLER” on the App Store or Google Play™ and install it to your mobile device.

## Adding the unit to the MusicCast network

Follow the procedure below to add the unit to the MusicCast network.

You can also configure the unit’s wireless network settings at the same time.

### Note

- Connect the mobile device in which the “MusicCast CONTROLLER” application has been installed to the wireless router (access point) in advance.
- The SSID and security key for your network will be needed.

### 1 Tap the “MusicCast CONTROLLER” application icon on your mobile device and tap “Setup”.

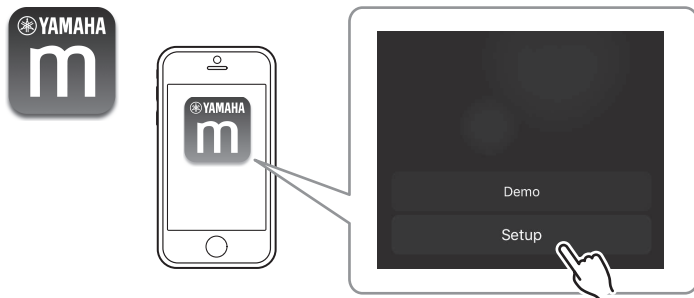

### Note

If you have already connected other MusicCast compatible devices to the network, tap “Settings” and then “Add New Device”.

### 2 Operate the “MusicCast CONTROLLER” application following the onscreen instructions to set up the network.

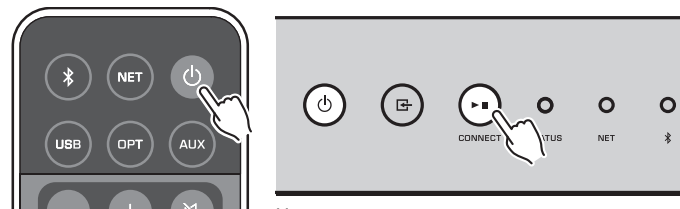

Hold down CONNECT for 5 seconds.

When the connection is established, the NET indicator on the front panel changes to lit in green.

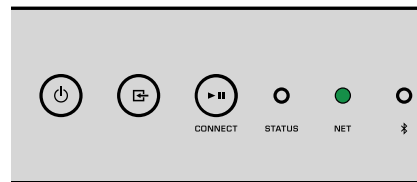

# PLAYBACK

## Playing back music with MusicCast CONTROLLER

You can play back music with the MusicCast CONTROLLER (p.18) on your mobile device. On the MusicCast CONTROLLER screen, select the room name that was specified for the unit, and then play back contents.

### Note

To play back contents from the Internet, the unit must be connected to the Internet.

## Music on a mobile device

With a mobile device that has MusicCast CONTROLLER installed, you can use the unit to play back music files stored on the mobile device.

### 1 Select

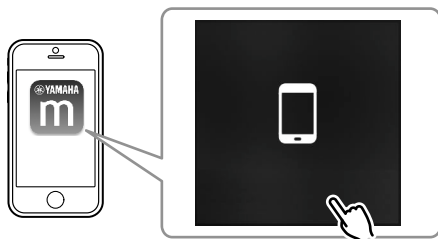

### 2 Select the music file to be played back.

## Internet radio

You can listen to Internet radio stations from all over the world.

### Note

- Some Internet radio stations may not be receivable or may be unavailable during certain times.
- The unit uses the vTuner Internet radio station database service.
- This service may be discontinued without notice.

## Selecting an Internet radio station

### 1 Select “Net Radio”.

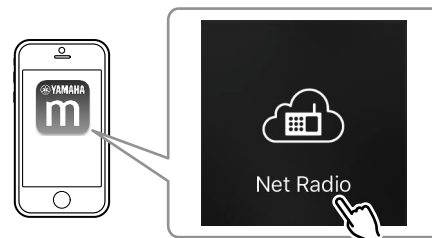

### 2 Select the radio station to be tuned into.

## Registering favorite Internet radio stations

You can register your favorite Internet radio stations to the “Bookmarks” folder on your mobile device.

### 1 Select any of the Internet radio stations on the MusicCast CONTROLLER screen.

### 2 Tap on the playback screen and select “Add Bookmark”.

### Note

You can quickly access registered Internet radio stations by selecting Net Radio, then Bookmarks, then My\_\_Favorites.

## Music stored on media servers (PCs/NAS)

The unit can play back music files stored on PCs and Network Attached Storage (NAS) devices that are connected to the network.

### Note

- To use this function, the unit and your PC/NAS must be connected to the same router (p.15).
- To play back music files, the server software installed on the PC/NAS must support the music file formats that you want to play back.
- The audio may be interrupted while using the wireless network connection. In this case, use the wired network connection.

## Setting the media sharing of music files

To play back music files stored on your PC or DLNA-compatible NAS, first you need to configure the media sharing setting on each music server.

The setting procedure may vary depending on the PC and DLNA server software. The procedures are setup examples for Windows Media Player 12 and Windows Media Player 11.

### Note

For a PC/NAS with other DLNA server software installed, refer to the instruction manual for the device or software and configure the media sharing settings.

### For Windows Media Player 12

- 1 Start Windows Media Player 12 on your PC.
- 2 Select “Stream”, then “Turn on media streaming”.
- 3 Click “Turn on media streaming”.
- 4 Select “Allowed” from the drop-down list next to the unit’s model name.
- 5 Click “OK” to exit.

### For Windows Media Player 11

- 1 Start Windows Media Player 11 on your PC.

- 2 Select “Library”, then “Media Sharing”.
- 3 Check the “Share my media to” box, select the unit’s icon, and click “Allow”.
- 4 Click “OK” to exit.

## Playing back music files

- 1 Select “Server”.

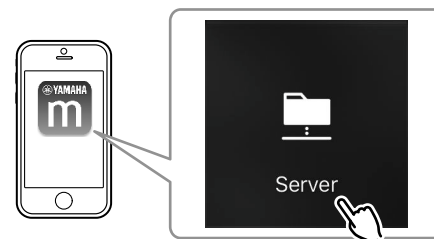

- 2 Select the music file to be played back.

## Online streaming services

You can listen to millions of songs through streaming services.

### Note

Supported music streaming services vary by the country or region of use.

## ■ Selecting a streaming service by its station name

- 1 Select a streaming service on the MusicCast CONTROLLER screen.

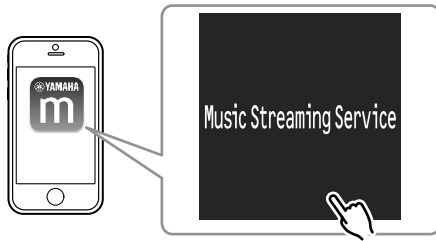

- 2 Select the station to be tuned into.

## Music stored on a USB storage device

The unit can play back music files saved on a USB storage device.

### Note

Connect a USB storage device directly to the USB jack of the unit. Do not use extension cables.

- 1 Connect the USB storage device to the USB jack.

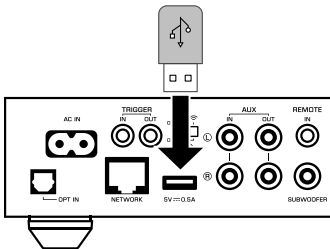

- 2 Select "USB".

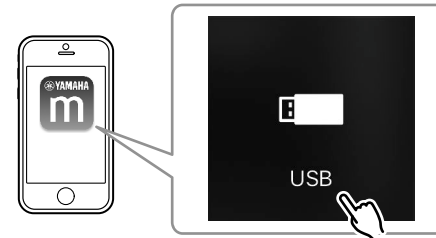

- 3 Select the music file to be played back.

### Note

Stop playback of the USB storage device before disconnecting it from the USB jack.

## Registering the song/station being played back to a preset

Up to 40 albums or songs stored on PC/NAS, Internet radio stations and streaming stations can be registered on the unit and easily recalled by using the MusicCast CONTROLLER.

The first 6 presets can be registered/recalled by using the supplied remote control.

### Note

The PRESET keys 1 to 6 on the remote control are the same as presets number 1 to 6 registered by the MusicCast CONTROLLER. If you register a song/station to a PRESET key on the remote control, the previously registered song/station is overwritten.

## ■ Registering a song/station by remote control

- 1 Play the song/station to be registered.

- 2** Hold down any of the PRESET keys 1 to 6 on the remote control for 3 seconds.

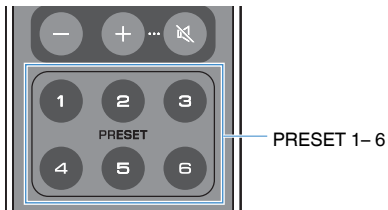

When the registration is finished, the STATUS indicator on the front panel flashes once in blue.

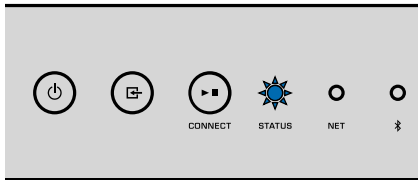

#### Note

- If the STATUS indicator flashes once in red, the selected song/station cannot be registered. Try with a different song/station.
- If a PRESET key where a song/station has already been registered is held down for 3 seconds, the previously registered song/station is overwritten.

## Recalling a registered song/station by remote control

- 1** On the remote control, press the PRESET key where the song/station is registered.



#### Note

- If a PRESET key with a registered song/station is pressed while the unit is in standby mode, the unit automatically turns on, and the registered song/station is played.
- Songs/stations from the following input sources can be registered to presets.
  - Server
  - Net Radio
  - Streaming service
  - USB

## Playing back music from other devices

Using the remote control, you can play back music from other devices.

## Listening to music from an external source

Music from an external device can be enjoyed by connecting the device to the OPT IN jack or AUX IN jack on the rear panel of the unit.

## ■ For an external device with digital optical audio output

- 1 Press OPT on the remote control.

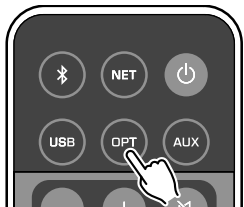

The STATUS indicator on the front panel lights up in purple.

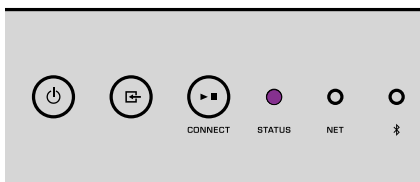

- 2 Play back music on the external device.

## ■ For an external device with analog stereo audio output

- 1 Press AUX on the remote control.

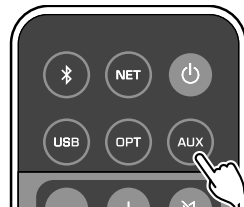

The STATUS indicator on the front panel lights up in white.

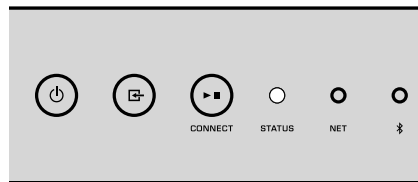

- 2 Play back music on the external device.

## Playing back music with Bluetooth®

The unit can play back music from Bluetooth-compatible devices such as smartphones and digital music players. Additionally, audio played back by the unit can be listened to using Bluetooth-compatible speakers or headphones.

Refer to the instruction manual supplied with the Bluetooth device.

### Notice

When you use the controls of Bluetooth devices (such as smartphones) to adjust volume, the volume may be unexpectedly loud. This could result in damage to the unit or speakers. If the volume suddenly increases during playback, stop playback on the Bluetooth device immediately.

### Note

- When making a Bluetooth connection, be sure to attach the wireless antenna to the unit (p.4).
- You cannot make Bluetooth connections to a Bluetooth device (such as smartphones) and Bluetooth speakers/headphones at the same time.

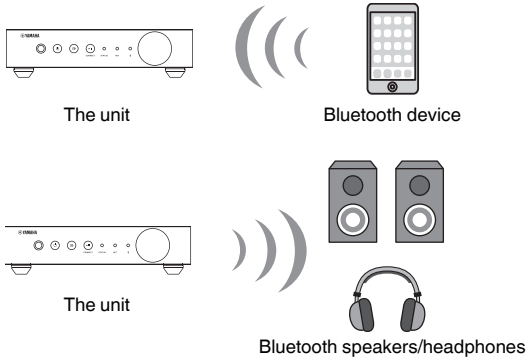

## ■ Playing back music from a Bluetooth® device

Follow the procedure below to establish a Bluetooth connection between a Bluetooth device (such as smartphones) and the unit, and play back music from the Bluetooth device.

### 1 Press (Bluetooth) on the remote control.

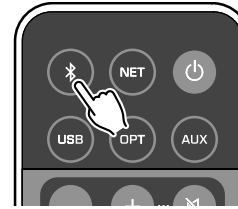

The Bluetooth indicator on the front panel of the unit flashes during the connection process.

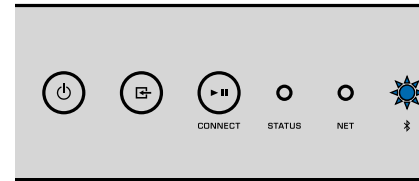

### Note

If the unit detects the Bluetooth device previously connected, the unit automatically connects to the last connected device. To establish another Bluetooth connection, first terminate the current Bluetooth connection.



## 2 Turn on the Bluetooth function on the Bluetooth device, and select “WXC-50 XXXXXX Bluetooth” in the Bluetooth device list on the device.

“XXXXXX” represents a unique sequence of numbers and letters for your unit.

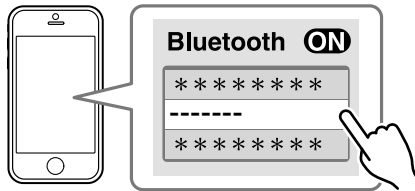

The Bluetooth indicator changes to lit in blue.

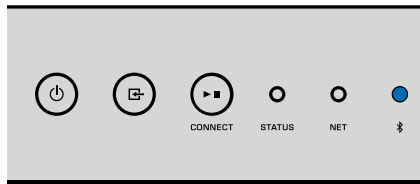

### Note

If the unit has been registered with the MusicCast CONTROLLER, the room name entered during registration appears on the Bluetooth device.

## 3 Play back music on the Bluetooth device.

### Note

- Depending on your Bluetooth device, it may be necessary to select the unit as the audio output.
- Adjust the Bluetooth device volume as needed.
- To terminate the Bluetooth connection, hold down  (Bluetooth) on the remote control for 3 seconds. When the connection is disconnected, the Bluetooth indicator flashes.

## Enjoying music with Bluetooth® speakers/headphones

By establishing a Bluetooth connection between Bluetooth speakers/headphones and the unit with the MusicCast CONTROLLER, you can enjoy music played back on the unit with Bluetooth speakers/headphones.

### 1 Select an input source other than Bluetooth in the MusicCast CONTROLLER screen and play back music on the unit.

### 2 Tap on the playback screen.

### 3 Select “Bluetooth Transmission” and enable the “Bluetooth transmission” function.

### 4 Set the Bluetooth speakers/headphones to the pairing mode, and then select the Bluetooth speakers/headphones to be connected with the unit.

When the connection process finishes, the Bluetooth indicator changes to lit in blue, and audio played back on the unit will be played back with the Bluetooth speakers/headphones.

### Note

- To terminate the Bluetooth connection, perform the disconnect operation on the Bluetooth speakers/headphones.
- AirPlay and DSD audio cannot be delivered.

## Playing back music with AirPlay

The AirPlay function allows you to play back iTunes or iPhone music on the unit via a network.

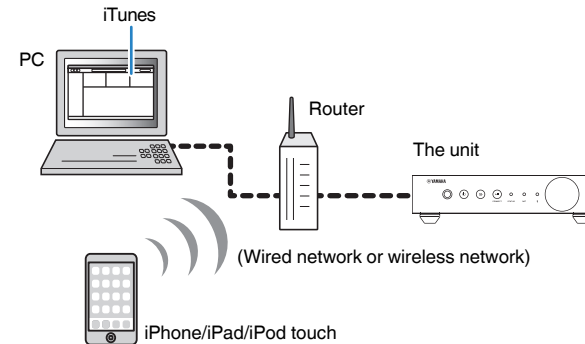

#### Notice

When you use iTunes/iPhone controls to adjust volume, the volume may be unexpectedly loud. This could result in damage to the unit or speakers. If the volume suddenly increases during playback, stop playback on the iTunes/iPhone immediately.

#### Note

- For details on supported iPhone devices, see “Supported devices and file formats” (p.45).
- You can limit access to the unit from other devices with the AirPlay by setting password in “AirPlay Password” (p.30) or “Password Setting” (p.34).

## 1 Turn on the unit, and start iTunes on the PC or display the playback screen on the iPhone.

When the iTunes/iPhone recognizes the unit, the AirPlay icon (  ) appears.\*

\* For iPhone, the AirPlay icon is displayed in Control Center. To access Control Center, swipe up from the bottom of the screen.

iTunes (example)

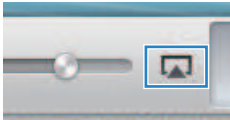

iOS 9 (example)

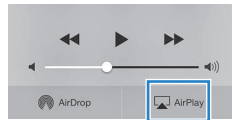

#### Note

If the icon does not appear, check whether the unit and PC/iPhone are connected to the router properly.

## 2 On the iTunes/iPhone, click (tap) the AirPlay icon and select the unit (network name of the unit) as the audio output device.

## 3 Select a song and start playback on the iTunes/iPhone.

The unit automatically selects “AirPlay” as the input source and starts playback.

The STATUS indicator changes to lit in pink.

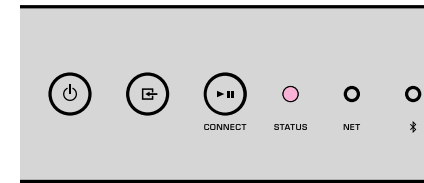

#### Note

- The unit automatically turns on when starting playback on iTunes/iPhone by setting “Network Standby” (p.30, p.34) to “On”.
- You can adjust the unit’s volume from the iTunes/iPhone during playback by setting “Volume Interlock” (p.30, p.34).

# OPERATING THE UNIT FROM A WEB BROWSER

## Web control using a PC

With the Web Control screen displayed in a web browser on a PC, you control the unit's music playback also display or modify the various unit settings such as the network connection settings as well as update the firmware.

Perform the following steps after connecting the unit to the network (p.15).

### Note

We recommend using one of the following web browsers. Operation on all web browsers cannot be guaranteed.

- Internet Explorer 11.x
- Safari 9.x

## Displaying the Web Control screen

Follow the procedure below to display the Web Control screen on a PC with Windows or Mac OS.

### Note

Enable Network Discovery in advance to display the Web Control screen on a PC with Windows via Network folder.

## Configuring with Windows

- 1 Open the “Network” folder.

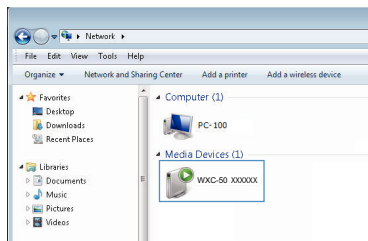

- 2 Double-click the room name (the unit) icon, which appears below “Other Devices” or “Media Devices”.

A special browser starts up and the Web Control screen for the unit appears.

## Configuring with Mac OS

- 1 Start up Safari, then open the “Preferences” window and click “Advanced”.

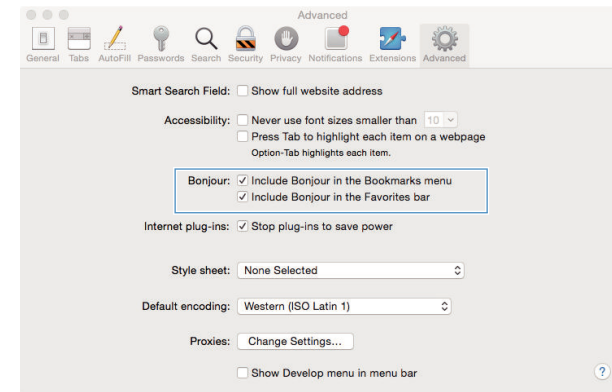

- 2 Select all check boxes for Bonjour.

### 3 Select the room name (the unit) from the Bookmarks menu list.

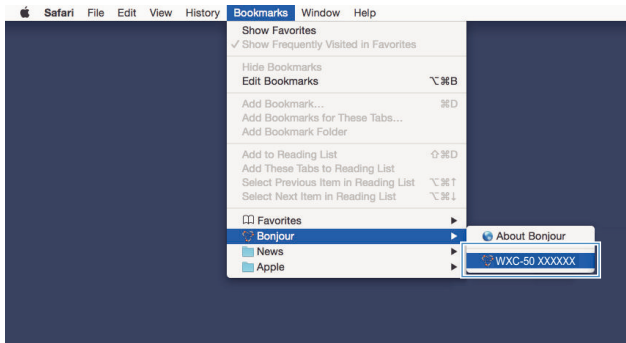

The Web Control screen for the unit appears.

# Operating on the Web Control screen

The Main screen of the Web Control screen appears first.

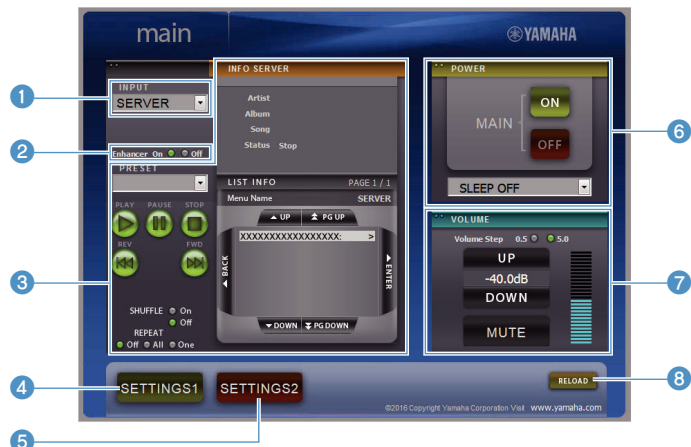

## SETTINGS1/SETTINGS2 screen



### 1 INPUT

Selects an input source.

### 2 Enhancer

Enables/disables the Compressed Music Enhancer (p.44) feature.

### 3 Input Info/Operation

Displays information about the selected input source and controls playback.

### 4 SETTINGS1

Moves to the settings1 screen (p.30).

### 5 SETTINGS2

Moves to the settings2 screen (p.31).

### 6 POWER

Turns the unit's power on/standby. You can also set a sleep timer.

### 7 VOLUME

Adjusts the volume or mutes the audio output. You can also select the increments used for volume adjustment.

### 8 RELOAD

Refreshes the information on the Web Control screen to show the most current data.

### 9 Menu

Selects a settings menu.

### 10 Settings item

For configuring advanced features.

### 11 BACK

Moves to the Main screen.

# CONFIGURING ADVANCED FEATURES

## Configuration from a web browser

Using a PC, the following items can be displayed and configured on the Web Control screen.

### SETTINGS1

SETTINGS (Menu)	Item	Setting values	Default	Explanation
<b>Rename</b>		-	-	Sets the network name of the unit and sets the zone name.
	<b>Current Network Connection</b>	-	-	Displays information about the current network connection of the unit.
	<b>Network Connection Select</b>	Wired / Wireless / Extend (1) / Extend (2) / Extend (3)	Wired	Sets the method of connecting to the network (p.38).
	<b>WPS PIN</b>	(check box)	unchecked	Allows a PIN code to be entered to a wireless router (access point) to establish a wireless connection (p.38).
<b>Network*</b>	<b>SSID</b>	-	-	Sets the SSID (network name) for the access point to which the unit is connected.
	<b>Security</b>	None / WEP / WPA2-PSK (AES) / Mixed Mode	None	Selects the encryption method for the network (p.38).
	<b>Security Key</b>	-	-	Sets the security key.
	<b>DHCP</b>	Off / On	On	Enables/disables the DHCP function.
	<b>IP Address</b>	-	-	Sets/displays the IP address for the unit.
	<b>Subnet Mask</b>	-	-	Sets/displays the subnet mask for the unit.
	<b>Default Gateway</b>	-	-	Sets/displays the IP address of the default gateway for the unit.
	<b>DNS Server (P)</b>	-	-	Sets/displays the IP address of the primary DNS server.
	<b>DNS Server (S)</b>	-	-	Sets/displays the IP address of the secondary DNS server.
	<b>AirPlay</b>	<b>AirPlay Mode</b>	Off / On	Off
<b>AirPlay Password</b>		-	-	Sets the password for AirPlay.
<b>Volume Interlock</b>		Off / Limited / Full	Limited	When AirPlay input is selected, this sets whether or not the volume of the unit and the volume of iTunes or the iPhone are synchronized.
<b>MAC filter</b>	<b>MAC Address 1-10</b>	-	0	Specifies the MAC addresses of the devices permitted access to the unit.

SETTINGS (Menu)	Item	Setting values	Default	Explanation
				Enables/disables the MAC address filter function. <b>Note</b> When enabling the MAC address filter, be sure to check the MAC addresses carefully before clicking "APPLY". Configuring the filter incorrectly may result in the unit becoming inaccessible. If this happens, the unit must be restored to the default settings (p.38).
MAC filter	Mode	Off / On	Off	
Network Standby		Off / On / Auto	Auto	Enables/disables the feature allowing the unit to be turned on by network devices (Network Standby).
Backup / Recovery		-	-	Saves the unit's current settings to a PC or loads them back from a PC. <b>Note</b> <ul style="list-style-type: none"> <li>The backup does not contain user information (such as user accounts and passwords) or unit-specific information (such as its IP address).</li> <li>Do not operate the unit during the recovery process (loading the settings back from a PC), as this may result in the incorrect recovery of the settings. When the recovery finishes, click "OK" to set the unit to standby mode.</li> </ul>
Firmware		-	-	Updates the unit's firmware from the web browser.
Licenses		-	-	Displays license information about the software used by the unit.



\* After configuring the network settings, it may be necessary to access the unit again or restart the browser.

## SETTINGS2

SETTINGS (Menu)	Item	Setting values	Default	Explanation
	PRE AMP/PLAYER Mode	-	-	Displays whether the unit is currently in PRE AMP mode or PLAYER mode.
	Enhancer	Off / On	On	Enables/disables the Compressed Music Enhancer feature (p.44).
	Bass Extension	Off / On	Off	Enables/disables extension of the low-frequency range of the frequency band of the speakers' playback. When this is "On", you can enjoy rich bass sounds as if you are using significantly larger speakers.
Sound	Monaural Downmix	Off / On	Off	Enables/disables a mode that plays back stereo signals as monaural audio.
	Direct	Off / On	Off	Enables/disables Direct playback. When this is enabled, audio is played back without being passed through the DSP.
	Ultra Low Jitter PLL	Level1-3	Level2	Sets the strength of the jitter removal applied to the audio input being played back, in order to adjust the audio quality. When the level is set high, the jitter removal is more effective, but the sound is likely to cut out. When the level is set low, the jitter removal is less effective, but the sound is less likely to cut out.

SETTINGS (Menu)	Item	Setting values	Default	Explanation	
Sound	Equalizer	Bypass / Auto / Manual	Auto	Adjusts the volumes for the low-frequency, middle-frequency, and high-frequency ranges of the audio. When this is "Auto", they stay synchronized with the main volume and perform hearing correction for the auditory response of the human ear.	
	Manual	High	-6.0 to 0.0 to +6.0 dB (0.5 dB steps)	0.0 dB	Adjusts the volume of the high-frequency range of the audio output.
		Mid	-6.0 to 0.0 to +6.0 dB (0.5 dB steps)	0.0 dB	Adjusts the volume of the medium-frequency range of the audio output.
		Low	-6.0 to 0.0 to +6.0 dB (0.5 dB steps)	0.0 dB	Adjusts the volume of the low-frequency range of the audio output.
	Speaker Type	Compact / Bookshelf / Floor standing / In-ceiling / In-wall	Bookshelf	Adjusts the effects of features such as Bass Extension and Adaptive EQ for optimal results depending on the speaker type. "Compact": optimizes for small speakers. "Bookshelf": optimizes for bookshelf speakers. "Floor standing": optimizes for large speakers that are placed on the floor. "In-ceiling": optimizes for speakers embedded in the ceiling. "In-wall": optimizes for speakers embedded in walls.	
Volume	L/R Balance	-12 to 0 to +12 (steps of 1)	0	Adjusts the balance of the volume between the left and right speakers.	
	Initial Volume	Mode	Off / On	Off	Enables/disables setting of the initial volume when the unit is turned on.
		Level	Mute, -80 dB to +0.0 dB (0.5 dB steps)	-40.0 dB	Sets the initial volume for when the unit is turned on.
	Max Volume	-20 dB to +0.0 dB (0.5 dB steps)	0.0 dB	Sets an upper limit for the volume levels to which the unit can be adjusted using the remote control, etc.	
	Subwoofer Volume	-6.0 to 0.0 to +6.0 dB (0.5 dB steps)	0.0 dB	Makes fine adjustments to the volume of the subwoofer.	
Input Setting	Input Trim	-6.0 to 0.0 to +6.0 dB (0.5 dB steps)	0.0 dB	Compensates for volume differences between input sources.	
	Auto Play	Off / On / Auto	different for every input source	Sets whether or not audio is automatically played back from servers, USB devices, etc. when the unit is turned on or the input source is switched. "Off": always starts up with playback stopped. "On": always begins playing back the content that was played the previous time. "Auto": begins playback if audio was currently being played back when the unit was turned to standby. <b>Note</b> The setting value is different for every input source or service.	
User Interface	LED Dimmer	0-3	3	Adjusts the brightness of the LED ("3" is the brightest).	





SETTINGS (Menu)	Item	Setting values	Default	Explanation	
User Interface	<b>Front Panel Operation</b>	Off / On	On	Enables/disables operation using the front panel (other than the power key).	
	<b>Sensor</b>	Off / On	On	Enables/disables operation using the remote control. When this is "Off", the unit can still be operated by other means.	
	<b>Remote</b>	<b>ID</b>	ID1 / ID2	ID1	Changes the ID of the remote control from which the unit receives signals. To change the ID of the remote control, set it as follows. Set to ID1: on the remote control, hold down  and PRESET 1 at the same time for 5 seconds. Set to ID2: on the remote control, hold down  and PRESET 2 at the same time for 5 seconds.
					<b>Access device Indication</b>
	Bluetooth	<b>Bluetooth</b>	Off / On	On	Enables/disables the Bluetooth function.
<b>Standby</b>		Off / On	On	Enables/disables the feature allowing the unit to be turned on by Bluetooth devices (Bluetooth Standby).	
<b>Audio Receive</b>		<b>Private Mode</b>	Off / On	Off	Sets whether or not the unit responds to searches other than from the paired Bluetooth device. When this is "On", the unit does not respond to searches.
		<b>Disconnect</b>	-	-	Terminates the Bluetooth connection between the Bluetooth device and the unit.
<b>Audio Send</b>	<b>Transmitter</b>	Off / On	Off	Enables/disables transmission of Bluetooth audio.	
Other Setup	<b>Auto Power Standby</b>	Off / 20min / 2h / 4h / 8h / 12h	Off	Sets the unit to be automatically set to standby mode when there are no operations for a specified amount of time. When this is set to 20min, the unit will only be set to standby mode automatically if there is no input signal during the 20 minutes without any operations.	
	<b>Memory Guard</b>	Off / On	Off	Protects the settings of the unit and prevents them from being modified.	
Network Info		-	-	Displays network information about the unit, such as its MAC address.	

## Configuration on Advanced Settings screen in mobile device app

Using your mobile device, the following items can be displayed and configured on the Advanced Settings screen in the MusicCast CONTROLLER.

To display the Advanced Settings screen, hold down the room name (the unit) on the MusicCast CONTROLLER screen and tap “Room Settings”, then tap “Advanced Settings” in the “Room Settings” menu.

SETTINGS (Menu)	Item	Settings	Default	Explanation	
	<b>PRE AMP/PLAYER Mode</b>	-	-	Displays whether the unit is currently in PRE AMP mode or PLAYER mode.	
	<b>Enhancer</b>	Off / On	On	Enables/disables the Compressed Music Enhancer feature (p.44).	
	<b>Bass Extension</b>	Off / On	Off	Enables/disables extension of the low-frequency range of the frequency band of the speakers' playback. When this is “On”, you can enjoy rich bass sounds as if you are using significantly larger speakers.	
	<b>Monaural Downmix</b>	Off / On	Off	Enables/disables a mode that plays back stereo signals as monaural audio.	
	<b>Direct</b>	Off / On	Off	Enables/disables Direct playback. When this is enabled, audio is played back without being passed through the DSP.	
<b>Sound</b>	<b>Ultra Low Jitter PLL</b>	Level1-3	Level2	Sets the strength of the jitter removal applied to the audio input being played back, in order to adjust the audio quality. When the level is set high, the jitter removal is more effective, but the sound is likely to cut out. When the level is set low, the jitter removal is less effective, but the sound is less likely to cut out.	
	<b>Equalizer</b>	Bypass / Auto / Manual	Auto	Adjusts the volumes for the low-frequency, middle-frequency, and high-frequency ranges of the audio. When this is “Auto”, they stay synchronized with the main volume and perform hearing correction for the auditory response of the human ear.	
	<b>Manual</b>	<b>High</b>	-6.0 to 0.0 to +6.0 dB (0.5 dB steps)	0.0 dB	Adjusts the volume of the high-frequency range of the audio output.
		<b>Mid</b>	-6.0 to 0.0 to +6.0 dB (0.5 dB steps)	0.0 dB	Adjusts the volume of the medium-frequency range of the audio output.
		<b>Low</b>	-6.0 to 0.0 to +6.0 dB (0.5 dB steps)	0.0 dB	Adjusts the volume of the low-frequency range of the audio output.
<b>Speaker Type</b>	Compact / Bookshelf / Floor standing / In-ceiling / In-wall	Bookshelf	Adjusts the effects of features such as Bass Extension and Adaptive EQ for optimal results depending on the speaker type. “Compact”: optimizes for small speakers. “Bookshelf”: optimizes for bookshelf speakers. “Floor standing”: optimizes for large speakers that are placed on the floor. “In-ceiling”: optimizes for speakers embedded in the ceiling. “In-wall”: optimizes for speakers embedded in walls.		

SETTINGS (Menu)	Item	Settings	Default	Explanation	
Volume	L/R Balance	-12 to 0 to +12 (steps of 1)	0	Adjusts the balance of the volume between the left and right speakers.	
	Initial Volume	Mode	Off / On	Off	Enables/disables setting of the initial volume when the unit is turned on.
		Level	Mute, -80 dB to +0.0 dB (0.5 dB steps)	-40.0 dB	Sets the initial volume for when the unit is turned on.
	Max Volume	-20 dB to +0.0 dB (0.5 dB steps)	0.0 dB	Sets an upper limit for the volume levels to which the unit can be adjusted using the remote control, etc.	
	Subwoofer Volume	-6.0 to 0.0 to +6.0 dB (0.5 dB steps)	0.0 dB	Makes fine adjustments to the volume of the subwoofer.	
	Input Trim	-6.0 to 0.0 to +6.0 dB (0.5 dB steps)	0.0 dB	Compensates for volume differences between input sources.	
Input Setting	Auto Play	Off / On / Auto	different for every input source	Sets whether or not audio is automatically played back from servers, USB devices, etc. when the unit is turned on or the input source is switched. "Off": always starts up with playback stopped. "On": always begins playing back the content that was played the previous time. "Auto": begins playback if audio was currently being played back when the unit was turned to standby.	
				<b>Note</b> The setting value is different for every input source or service.	
User Interface	Front Panel Operation	Off / On	On	Enables/disables operation using the front panel (other than the power key).	
	Remote	Sensor	Off / On	On	Enables/disables operation using the remote control. When this is "Off", the unit can still be operated by other means.
		ID	ID1 / ID2	ID1	Changes the ID of the remote control from which the unit receives signals. To change the ID of the remote control, set it as follows. Set to ID1: on the remote control, hold down  and PRESET 1 at the same time for 5 seconds. Set to ID2: on the remote control, hold down  and PRESET 2 at the same time for 5 seconds.
	LED Dimmer	0-3	3	Adjusts the brightness of the LED ("3" is the brightest).	
	Access device Indication	-	-	Lights the LED of the device currently being used for operation via a web browser.	
	Bluetooth	Bluetooth	Off / On	On	Enables/disables the Bluetooth function.
Standby		Off / On	On	Enables/disables the feature allowing the unit to be turned on by Bluetooth devices (Bluetooth Standby).	
Audio Receive		Private Mode	Off / On	Off	Sets whether or not the unit responds to searches other than from the paired Bluetooth device. When this is "On", the unit does not respond to searches.

SETTINGS (Menu)	Item	Settings	Default	Explanation	
<b>Bluetooth</b>	<b>Audio Receive</b>	<b>Disconnect</b>	-	-	Terminates the Bluetooth connection between the Bluetooth device and the unit.
	<b>Audio Send</b>	<b>Transmitter</b>	Off / On	Off	Enables/disables transmission of Bluetooth audio.
<b>Network*</b>	<b>Connection</b>	<b>Type</b>	Wired / Wireless	Wired	Sets the method of connecting to the network (p.38).
		<b>SSID</b>	-	-	Sets the SSID (network name) for the access point to which the unit is connected.
		<b>Security Type</b>	None / WEP / WPA2-PSK (AES) / Mixed Mode	None	Selects the encryption method for the network (p.38).
		<b>Security Key</b>	-	-	Sets the security key.
		<b>DHCP Client</b>	Off / On	On	Enables/disables the DHCP function.
		<b>IP Address</b>	-	-	Sets/displays the IP address for the unit.
		<b>Subnet Mask</b>	-	-	Sets/displays the subnet mask for the unit.
		<b>Default Gateway</b>	-	-	Sets/displays the IP address of the default gateway for the unit.
		<b>DNS Server (P)</b>	-	-	Sets/displays the IP address of the primary DNS server.
		<b>DNS Server (S)</b>	-	-	Sets/displays the IP address of the secondary DNS server.
	<b>Network Standby</b>	Off / On / Auto	Auto	Enables/disables the feature allowing the unit to be turned on by network devices (Network Standby).	
	<b>Network Name</b>	-	-	Sets the Network Name of the unit.	
<b>AirPlay</b>	<b>Volume Interlock</b>	Off / Limited / Full	Limited	When AirPlay input is selected, this sets whether or not the volume of the unit and the volume of iTunes or the iPhone are synchronized.	
	<b>Password Setting</b>	<b>Password</b>	Off / On	Off	Enables/disables the password functions for AirPlay.
		<b>Passphrase</b>	-	-	Sets the password for AirPlay.
<b>Other Setup</b>	<b>Auto Power Standby</b>	Off / 20min / 2h / 4h / 8h / 12h	Off	Sets the unit to be automatically set to standby mode when there are no operations for a specified amount of time. When this is set to 20min, the unit will only be set to standby mode automatically if there is no input signal during the 20 minutes without any operations.	
	<b>Memory Guard</b>	Off / On	Off	Protects the settings of the unit and prevents them from being modified.	

\* After configuring the network settings, it may be necessary to access the unit again or restart the browser.

# APPENDIX

## Updating the unit's firmware via the network

When the unit is connected to the Internet, you can update the firmware via the network.

Firmware can also be updated by downloading a firmware update file from the Yamaha website.

### Firmware update procedures

- Updating with MusicCast CONTROLLER (p.37)
- Updating with a USB memory device (p.37)

### STATUS indicator conditions

- When a new firmware update is available, the STATUS indicator flashes slowly in white after turning on the unit.
- If an error occurred during firmware updating, the STATUS indicator will repeatedly blink 2 - 7 times in red and 1 second off until the unit is turned to standby.

#### Note

- Do not operate the unit, turn it to standby or disconnect the power cable or network cable during a firmware update.
- A firmware update takes about 10 minutes or more (depending on your network connection speed).
- If the Internet connection speed is slow, or the unit is connected to the wireless network, a firmware update may not be possible depending on the condition of the wireless connection. In this case, try updating again after a while or update the firmware using a USB memory device (p.37).
- After a firmware update, check the version of firmware currently installed on the unit using the MusicCast CONTROLLER.
- For details on firmware updates, visit the Yamaha website.

## Updating with MusicCast CONTROLLER

When a new firmware update is available, a message prompting you to update appears in the MusicCast CONTROLLER screen.

Follow the procedure on the MusicCast CONTROLLER screen to update the firmware.

## Updating with a USB memory device

You can update the firmware using a USB memory device. Download the firmware update file from the Yamaha website to a USB memory device on a PC, and then connect the USB memory device to the USB jack on the unit.

- 1 Turn the unit to standby and disconnect the power cable from the AC wall outlet.
- 2 Connect the USB memory device to the USB jack on the rear panel.

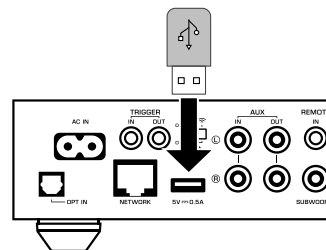

- 3 While holding down ►|| (CONNECT) on the front panel, plug the power cable to the AC wall outlet.

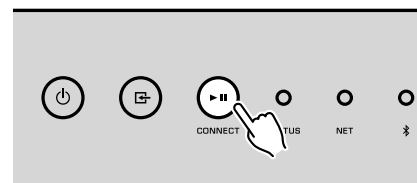

The firmware update starts. During firmware updating, the STATUS indicator lights up in blue, and the NET indicator and Bluetooth indicator flash alternately.

- When the update is finished, press **⏻** (power) on the front panel to turn the unit on again.

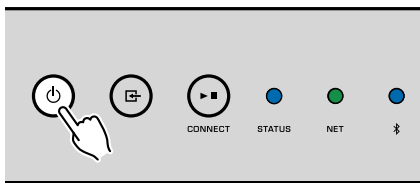

When updating is finished, the STATUS indicator (blue), NET indicator and **Ⓜ** (Bluetooth) indicator light up.

- Specify the network settings.

DHCP	Switches the DHCP function on/off. When set to "Off", some network settings, such as the IP address and subnet mask, can be specified manually.
IP Address	Displays the IP address for the unit.
Subnet Mask	Displays the subnet mask for the unit.
Default Gateway	Displays the IP address of the default gateway for the unit.
DNS Server (P)	Displays the IP address of the primary DNS server.
DNS Server (S)	Displays the IP address of the secondary DNS server.

- Click "APPLY".

## Setting up the wireless connection manually

You can set up the wireless connection manually with the Web Control screen on a PC (p.27).

Follow the procedure after connecting the unit to your router with a network cable.

### Note

You need to setup the SSID (network name), security method and security key for your network.

- On the Web Control screen, click "SETTINGS1".
- Select "Network".
- Select "Wireless" from the drop-down list at "Network Connection Select" in the "Network" menu.
- Specify the wireless router (access point) settings.

SSID	Enter the SSID.
Security	Select the security method.
Security Key	Enter the security key.

### Note

If you select "WPS PIN" as the connection method, the PIN code for the unit appears. Enter the PIN code into the wireless router (access point), and then proceed to Step 6.

## Restarting the unit

The unit can be restarted forcibly.

- Hold down **⏻** (power) on the front panel for 15 seconds.

The unit restarts when the key is released.

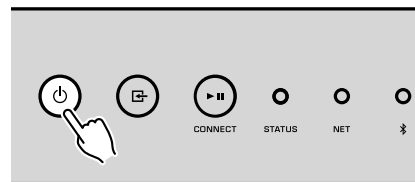

## Restoring the default settings

All unit settings can be restored to the defaults.

- Turn the unit to standby.

- 2** Hold down **⏻ (INPUT)** and **▶⏪ (CONNECT)** on the front panel for 5 seconds at the same time.

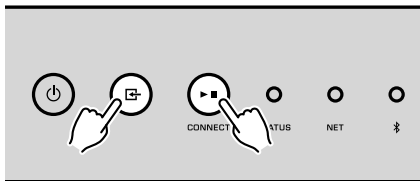

When restoring is finished, the unit is turned on and all settings are returned to their factory default configurations.

## Troubleshooting

Refer to the table below if the unit does not function properly.

If the problem you are experiencing is not listed below or if the instructions below do not help, turn off the unit, disconnect the power cable, and contact the nearest authorized Yamaha dealer or service center.

### General

Problem	Cause	Remedy
The power does not turn on.	The power cable is not properly connected.	Connect the power cable firmly.
	The protection circuitry has been activated.	As a safety precaution, capability to turn on the unit is disabled. Contact your nearest authorized Yamaha dealer or service center to request repair.
The power turns off immediately after the power has been turned on.	The inner power supply circuit is malfunctioning.	Contact your nearest authorized Yamaha dealer or service center to request repair.
The unit is not reacting.	The internal microcomputer is frozen, due to an external electric shock (such as lightning or excessive static electricity).	Hold down the ⏻ (power) key on the front panel for at least 15 seconds to restart the unit. If the problem persists, disconnect the power cable from the AC wall outlet and plug it again.
	The remote control IDs of the unit and the remote control are not identical.	Change the remote control ID of the unit or the remote control (p.31, p.34).
No sound.	Incorrect input or output cable connections.	Connect the cable properly.
	Another input source is selected.	Select an appropriate input source with the input selection keys.
	The volume is at the minimum or muted.	Turn up the volume.
	The output of the device that is connected to the unit's digital optical input is set to an audio format other than PCM.	The optical input of the unit supports only PCM signals. Change the audio output setting on the playback device (such as a TV) to PCM.
Noise or humming is heard coming from the unit or devices surrounding it.	The unit is too close to another digital or radio frequency device.	Move the unit further away from the device.



## Network

Problem	Cause	Remedy
Cannot configure connection settings on MusicCast CONTROLLER.	The mobile device is not connected to the wireless router at your home.	Connect the mobile device to the wireless router and start MusicCast CONTROLLER. Disable the cellular data transmission of your mobile device.
	It takes time for the application to detect the unit.	Wait a moment while making sure that your mobile device does not go into sleep mode.
	The wireless switch on the rear panel is turned off.	Connect the unit to a router (access point) with a network cable or set the wireless switch properly.
	The unit is set to standby mode.	Turn on the unit.
	Access to the network is restricted by the firewall settings of the wireless router (access point).	Check the firewall setting and the MAC address filter of the wireless router (access point).
	Microwave ovens or other wireless devices in your neighborhood might disturb the wireless communication.	Move the unit away from those devices.
MusicCast CONTROLLER does not detect the unit or the server (PC or DLNA-compatible NAS).	The media sharing setting is not correct.	Configure the sharing setting and select the unit as a device to which music contents are shared.
	Some security software installed on your DLNA server is blocking the access of the unit to your DLNA server.	Check the settings of security software installed on your DLNA server.
	The unit, DLNA server and mobile device are not in the same network.	Check the network connections and your router settings, and then connect the unit, DLNA server and mobile device to the same network.
	Multiple routers are connected between your network devices (double router).	Connect the network device you wish to use to the same router.
The network feature does not function.	The network parameters (IP address) have not been obtained properly.	Enable the DHCP server function on your router. And also the DHCP function on the unit must be set to "On" (default: On).
	Access to the network is restricted by the firewall settings of the wireless router (access point).	Check the firewall setting of the wireless router (access point) or the MAC address filter setting.
	The mobile device is connected to Secondary SSID when using a multiple SSID router.	In this case, access to the devices connected to the Primary SSID or wired network might be restricted by the router (only Internet access is available). Connect your mobile device to the Primary SSID.
Playback stops unexpectedly and files cannot be played continuously.	The folder contains some files that cannot be played via the unit.	Delete or remove files (including video or hidden files) that cannot be played via the unit from the folder.
Sound from high resolution contents is interrupted.	The wireless network connection is unstable or the wireless signal is weak.	Place the unit and the wireless router (access point) closer or use the wired network connection for stable playback.
The Internet radio cannot be played.	The service of selected Internet radio station may have been stopped.	Try the station later or select another station.
	The selected Internet radio station is currently broadcasting silence.	Some Internet radio stations broadcast silence at certain of times of the day. Try the station later or select another station.
	Access to the network is restricted by the firewall settings of your network devices (such as the router).	Check the firewall settings of your network devices. The Internet radio can be played only when it passes through the port designated by each radio station.
Firmware update via the network failed.	The network connection is unstable.	Try updating again after a while.
The unit cannot connect to the Internet via a wireless router (access point).	The wireless router (access point) is turned off.	Turn on the wireless router (access point).



Problem	Cause	Remedy
The unit cannot connect to the Internet via a wireless router (access point).	The unit and the wireless router (access point) are too far apart or there is an obstacle between them.	Place the unit and the wireless router (access point) closer to each other or move them to a location where there are no obstacles between them.

## Bluetooth®

Problem	Cause	Remedy
Cannot make the unit pair with a Bluetooth device.	The Bluetooth device does not support A2DP.	Use a Bluetooth device that supports A2DP.
	A Bluetooth device that you want to pair with the unit has a password other than "0000".	Use a Bluetooth device whose password is "0000".
	The unit and the Bluetooth device are too far apart.	Move the Bluetooth device closer to the unit.
	There is a device (such as a microwave or a wireless network device) that outputs signals in the 2.4 GHz frequency band nearby.	Move the unit away from those devices.
	The unit enters standby mode.	Turn on the unit and select Bluetooth as the input source, and then perform pairing with the device.
	The wireless switch on the rear panel is turned off.	Set the wireless switch properly to enable the Bluetooth connection (p.7).
	The wireless antenna is not attached.	Attach the wireless antenna.
	Another Bluetooth device is already connected to the unit.	Terminate the current Bluetooth connection and then establish a new connection.
Private Mode is set to "On". In this case, you can connect only a Bluetooth device that has been connected before.	Set Private Mode to "Off" and then connect the new Bluetooth device.	

## Error table of STATUS indicator

Refer to the table below when the STATUS indicator on the front panel flashes in error indications.

Color	Condition	Blink	Status of the unit
 Red	Flashing, and the power turns off immediately after the power has been turned on	2 - 8 times	As a safety precaution, the unit has turned itself off.
	Flashing, and the power does not turn on	4 - 8 times	As a safety precaution, capability to turn on the unit is disabled. Contact your nearest authorized Yamaha dealer or service center to request repair.
	Fast flashing	Once	No presets have been registered.
	Flashing (every 0.5 second) *	Repeat blinking 2 - 7 times and 1 second off until the unit is turned off	An error occurred during firmware updating. Check the connection of the USB memory device, or the unit to the network, and then update the firmware again.
	Slow flashing (every 1 second)	Twice	An error is occurring with the USB device.
		3 times	An error is occurring with the network.
		5 times	An error is occurring with WAC/WPS/CONNECT.
Repeated until the unit is turned off		Firmware update failed. Update the firmware using a USB memory device (p.37).	
 Orange	Flashing	Twice	The remote control IDs of the unit and the remote control are not identical, or reception of the remote control signal is disabled. To specify the remote control settings, see "CONFIGURING ADVANCED FEATURES" (p.31, p.34).
 White	Slow flashing after turning on the unit	10 times	A new firmware update is available. Update the firmware (p.37).

\* The NET indicator and  (Bluetooth) indicator flash at the same time.

## Glossary

This is a glossary of the technical terms used in this manual.

### Compressed Music Enhancer

The Compressed Music Enhancer feature compensates for missing harmonics in compression music formats (such as MP3). As a result, this technology provides improved performance for the overall sound system.

### High Resolution

High Resolution signifies high quality audio devices and content (such as 192 kHz/24 bit FLAC). The Consumer Electronics Association (CEA) defines High-Resolution Audio (Hi-Res Audio or HRA) as, "lossless audio that is capable of reproducing the full range of sound from recordings that have been mastered from better than CD quality music sources."

### SSID

SSID (Service Set Identifier) is a name that identifies a particular wireless LAN access point.

### Wi-Fi

Wi-Fi (Wireless Fidelity) is a technology that allows an electronic device to exchange data or connect to the Internet wirelessly using radio waves. Wi-Fi offers the advantage of eliminating the complexity of making connections with LAN cables by using wireless connection. Only products that complete Wi-Fi Alliance interoperability tests can carry the "Wi-Fi Certified" trademark.

### WPS

WPS (Wi-Fi Protected Setup) is a standard established by the Wi-Fi Alliance, which allows easy establishment of a wireless home network.

## Trademarks

The trademarks used in this manual are as follows.



Supports iOS 7 or later for setup using Wireless Accessory Configuration.

"Made for iPod," "Made for iPhone," and "Made for iPad" mean that an electronic accessory has been designed to connect specifically to iPod, iPhone, or iPad, respectively, and has been certified by the developer to meet Apple performance standards.

Apple is not responsible for the operation of this device or its compliance with safety and regulatory standards.

Please note that the use of this accessory with iPod, iPhone, or iPad may affect wireless performance.

iTunes, AirPlay, iPad, iPhone, iPod, and iPod touch are trademarks of Apple Inc., registered in the U.S. and other countries.

iPad Air and iPad mini are trademarks of Apple Inc.

App Store is a service mark of Apple Inc.



DLNA™ and DLNA CERTIFIED™ are trademarks or registered trademarks of Digital Living Network Alliance. All rights reserved. Unauthorized use is strictly prohibited.

### Windows™

Windows is a registered trademark of Microsoft Corporation in the United States and other countries.

Internet Explorer, Windows Media Audio and Windows Media Player are either registered trademarks or trademarks of Microsoft Corporation in the United States and/or other countries.

### Android™

### Google Play™

Android and Google Play are trademarks of Google Inc.



The Wi-Fi CERTIFIED™ Logo is a certification mark of Wi-Fi Alliance®.

The Wi-Fi Protected Setup™ Identifier Mark is a certification mark of Wi-Fi Alliance®.



The Bluetooth® word mark and logos are registered trademarks owned by Bluetooth SIG, Inc. and any use of such marks by Yamaha Corporation is under license.

### Bluetooth protocol stack (Blue SDK)

Copyright 1999-2014 OpenSynergy GmbH

All rights reserved. All unpublished rights reserved.



MusicCast is a trademark or registered trademark of Yamaha Corporation.

### Explanations regarding GPL

This product utilizes GPL/LGPL open-source software in some sections. You have the right to obtain, duplicate, modify, and redistribute this open-source code only. For information on GPL/LGPL open source software, how to obtain it, and the GPL/LGPL license, refer to the Yamaha Corporation website (<http://download.yamaha.com/sourcecodes/musiccast/>).

## Supported devices and file formats

The following devices and file formats can be used by the unit.

### Supported devices

#### DLNA

- PC installed with “Windows Media Player 11” or “Windows Media Player 12”
- DLNA (ver. 1.5) compatible NAS

#### Bluetooth devices

- Bluetooth devices that support A2DP
  - Yamaha does not assure the connections of all Bluetooth devices.

#### USB devices

- USB mass storage class devices (e.g., flash memory or portable audio players) using FAT16 or FAT32 format
  - Do not connect USB chargers, USB hubs, or other devices that are not USB mass storage class devices. Do not connect PCs, card readers, or external hard disk drives.
  - USB devices with encryption cannot be used.
  - Some features may not be compatible, depending on the model or manufacturer of the USB storage device.

#### AirPlay

AirPlay works with iPhone, iPad, and iPod touch with iOS 4.3.3 or later, Mac with OS X Mountain Lion or later and Mac and PC with iTunes 10.2.2 or later.

#### Made for.

iPhone 6 Plus, iPhone 6, iPhone 5s, iPhone 5c, iPhone 5, iPhone 4s

iPad Air 2, iPad mini 3, iPad Air, iPad mini 2, iPad mini, iPad (3rd and 4th generation), iPad 2

iPod touch (5th generation)

(as of May 2016)

### File formats

File	Sampling frequency (kHz)	Quantization bit number (bit)	Bitrate (kbps)	Number of channels	Support for gapless playback
<b>WAV(LPCM)</b>	Up to 192 kHz	16/24	-	2	✓
<b>FLAC</b>	Up to 192 kHz	16/24	-	2	✓
<b>AIFF</b>	Up to 192 kHz	16/24	-	2	✓
<b>ALAC</b>	Up to 96 kHz	16/24	-	2	✓
<b>MP3</b>	Up to 48 kHz	-	8 to 320	2	
<b>WMA</b>	Up to 48 kHz	-	8 to 320	2	
<b>MPEG-4 AAC</b>	Up to 48 kHz	-	8 to 320	2	
<b>DSD</b>	2.8 MHz/ 5.6 MHz	1	-	2	

# Specifications

The specifications of the unit are as follows.

## Input jacks

Analog Audio

- Stereo Audio (RCA) x 1

Digital Audio (Supported frequencies: 32 kHz to 192 kHz)

- Optical x 1

Other jacks

- USB x 1 (USB2.0)
- NETWORK (Wired) x 1 (100Base-TX/10Base-T)
- NETWORK (Wireless) x 1 (IEEE802.11b/g/n)

## Output jacks

Analog Audio

- Subwoofer Out x 1
- Stereo Audio (RCA) x 1

Digital Audio (Supported frequencies: 32 kHz to 192 kHz)

- Optical x 1
- Coaxial x 1

## Other jacks

Trigger Out x 1

Trigger In x 1

Remote In x 1

## USB

Capable of Mass Storage Class USB Memory

Current Supply Capacity: 0.5 A

## Bluetooth

Sink Function

- Source Device to Unit (ex. Smartphone/Tablet)
- Supported profile
  - A2DP, AVRCP
- Supported codec
  - SBC, AAC

Source Function

- Unit to Sink Device (ex. Bluetooth Headphone)
- Supported profile
  - A2DP, AVRCP
- Supported codec
  - SBC

Bluetooth version

- Ver. 2.1+EDR

Wireless output

- Bluetooth Class 2

Maximum communication distance

- 10 m (33 ft) without interference

## Network

Compatible with DLNA ver. 1.5

AirPlay supported

Internet Radio

Streaming Service

## Wi-Fi

Wireless Network Standard: IEEE 802.11 b/g/n

Radio Frequency Band: 2.4GHz

Capable of WPS (Wi-Fi Protected Setup) by PIN Method and Push-Button-Method

Available Security Method: WEP, WPA2-PSK (AES), Mixed Mode

## Audio Section

---

Total Harmonic Distortion (THD)	
• (20 Hz to 20 kHz, PRE OUT)	0.003% THD

---

Frequency Response (+0/-3 dB)	
• PRE OUT (OPT/NET/USB IN)	10 Hz to 80 kHz
• PRE OUT (AUX IN)	10 Hz to 40 kHz
• AUX OUT (OPT/NET/USB IN)	10 Hz to 50 kHz
• AUX OUT (AUX IN)	10 Hz to 40 kHz

---

Signal to Noise Ratio (IHF-A)	
• (OPT/NET/USB/Bluetooth IN)	112 dB
• (AUX IN)	98 dB

---

Channel Separation	
• (1 kHz/10 kHz)	95/85 dB

---

Rated Output Level / Output Impedance	
• PRE OUT (1 kHz)	2.0 V/470 Ω
• Subwoofer (30 Hz) (Except for China model)	4.0 V/470 Ω
• AUX OUT	2.0 V/1 kΩ

---

Maximum Output Level	
• PRE OUT (0.9% THD, PRE AMP / PLAYER mode, Gain offset +6 dB)	4.0V

---

Maximum Input Signal	
• AUX IN (1 kHz, 0.5% THD)	2.4 V

## General

---

Power Supply	
• [U.S.A. and Canada models]	AC 100 to 120 V, 50/60 Hz
• [Korea model]	AC 220 V, 60 Hz
• [Other models]	AC 100 to 240 V, 50/60 Hz

---

Power Consumption	
	12 W

---

### Standby Power Consumption

• Network Standby Off, Bluetooth Standby Off	0.1 W
• Network Standby On, Bluetooth Standby Off	
– Wired	1.6 W
– Wireless (Wi-Fi)	1.8 W
• Network Standby On, Bluetooth Standby On	
– Wired	1.8 W
– Wireless (Wi-Fi)	1.8 W

---

### Dimensions (W x H x D)

214 x 51.5 x 245.9 mm (8.43" x 2.03" x 9.68")

---

### Reference Dimensions (with wireless antenna upright)

\* Including legs and protrusions

214 x 123.6 x 245.9 mm (8.43" x 4.87" x 9.68")

---

### Weight

1.44 kg (3.17 lbs)

\* The contents of this manual apply to the latest specifications as of the publishing date. To obtain the latest manual, access the Yamaha website then download the manual file.

Yamaha Global Site  
<http://www.yamaha.com/>

Yamaha Downloads  
<http://download.yamaha.com/>

Manual Development Department  
© 2016 Yamaha Corporation

Published 05/2016 NV-B0

**WXC-500M/EN**