



AV Receiver

RX-S602

Owner's Manual

musicCast

-
- This unit is a product for enjoying video and music at home.
 - This manual explains preparations and operations for everyday users of the unit.
 - Read the supplied booklet "Quick Start Guide" before using the unit.

CONTENTS

BEFORE USING THE UNIT 7

How to use this manual..... 7

How to use this manual..... 7

Checking the accessories..... 7

Checking the accessories..... 7

Using the remote control..... 8

Insert the batteries in the remote control..... 8

Operating range of the remote control..... 8

FEATURES 9

What you can do with the unit..... 9

Part names and functions..... 11

Part names and functions of the front panel..... 11

Part names and functions of the front display..... 13

Part names and functions of the rear panel..... 14

Part names and functions of the remote control..... 15

PREPARATIONS 16

1 Connecting speakers..... 16

Names and functions of speakers..... 16

Speaker systems and speakers to be connected..... 17

Speaker requirements..... 17

Setting the speaker impedance..... 18

Cable requirements..... 18

How to connect speakers..... 18

How to place speakers (speaker systems)..... 20

Connecting front speakers that support bi-amp connections..... 23

2 Connecting a TV..... 24

HDMI connection with a TV..... 24

VIDEO (composite video) connection with a TV..... 24

3 Connecting playback devices..... 25

HDMI connection with a video device such as a BD/DVD player..... 25

Connection other than HDMI with a playback device..... 25

Connecting to the jack on the front panel..... 26

4 Connecting the radio antennas..... 27

Connecting the FM/AM antennas (Except for U.K., Europe and Australia models)..... 27

Connecting the DAB/FM antenna (U.K., Europe and Australia models)..... 28

5 Preparing for connecting to a network..... 29

Preparing for connecting to a network..... 29

Connecting a network cable (wired connection)..... 29

Preparing wireless antennas (wireless connection)..... 30

6 Plugging in the power cable..... 30

Plugging in the power cable..... 30

7 Selecting the on-screen menu language..... 31

Selecting the on-screen menu language..... 31

8 Configuring the necessary speaker settings..... 32

Assigning speaker configuration..... 32

Optimizing the speaker settings automatically (YPAO)..... 33

Error messages from YPAO..... 35

Warning messages from YPAO..... 36

9 Setting MusicCast..... 37

What is MusicCast..... 37

Using MusicCast CONTROLLER..... 37

Adding the unit to the MusicCast network..... 37

ENJOYING SOUND 38

Enjoying sound field effects..... 38

Select your favorite sound mode..... 38

Enjoying 3D sound fields (CINEMA DSP 3D)..... 38

Enjoying sound field effects optimized for the type of content..... 39

Enjoying sound field effects without surround speakers (Virtual CINEMA DSP)..... 39

Enjoying surround sound with 5 speakers placed in front (Virtual CINEMA FRONT)..... 39

Enjoying surround sound with headphones (SILENT CINEMA)..... 39

Enjoying unprocessed playback.....	40
Enjoying original sound (straight decode).....	40
Enjoying multichannel playback without sound field effects (surround decoder).....	40
Enjoying pure high fidelity sound (direct playback).....	41
Enjoying enhanced bass sound.....	41
Enhancing the bass (Extra Bass).....	41
Enjoying enhanced compressed music.....	42
Playing back digitally compressed formats with enriched sound (Compressed Music Enhancer).....	42
Enjoying music in multiple rooms.....	43
Playing back music in multiple rooms.....	43
Connecting Zone2 speakers.....	43
Controlling Zone2.....	44
Enjoying the same source in multiple rooms (party mode).....	44

PLAYBACK 45

Basic playback procedure.....	45
Basic procedure for playing back video and music.....	45
Switching information on the front display.....	46
Item names and functions of the playback screen.....	47
Item names and functions of the browse screen.....	48
Listening to FM/AM radio (Except for U.K., Europe and Australia models).....	49
Setting the frequency steps.....	49
Selecting a frequency for reception.....	50
Selecting a preset station.....	51
Registering radio stations automatically (Auto Preset).....	51
Registering a radio station manually.....	52
Clearing preset stations.....	53
Listening to DAB radio (U.K., Europe and Australia models).....	54
Preparing the DAB tuning.....	54
Selecting a DAB radio station for reception.....	55
Selecting a preset DAB radio station.....	55
Registering a DAB radio station as presets.....	56
Clearing preset DAB radio stations.....	57
Displaying the DAB information.....	57
Checking reception strength of each DAB channel label.....	58

Listening to FM radio (U.K., Europe and Australia models).....	59
Selecting a frequency for FM radio reception.....	59
Selecting a preset FM radio station.....	60
Registering FM radio stations automatically (Auto Preset).....	60
Registering an FM radio station manually.....	61
Clearing preset FM radio stations.....	62
Displaying the Radio Data System information.....	62
Playing back music stored on a Bluetooth® device.....	63
Playback Bluetooth® device music on the unit.....	63
Playing back music with AirPlay.....	64
Playback of iTunes/iPhone music contents with AirPlay.....	64
Playing back music stored on a USB storage device.....	65
Playback of USB storage device contents.....	65
Playing back music stored on media servers (PCs/NAS).....	66
Media sharing setup on media servers (PCs/NAS).....	66
Playing back music stored on media servers (PCs/NAS).....	66
Listening to Internet radio.....	68
Selecting an Internet radio station.....	68
Registering favorite Internet radio stations.....	68
Listening to music streaming services.....	69
Listening to a streaming service.....	69
Useful playback functions.....	70
SCENE function.....	70
Shortcut function.....	72

Configuring playback settings for different playback sources (Option menu).....	74
Basic operation of the Option menu.....	74
Option menu items.....	75
Switching the input source.....	76
Adjusting the tone of the audio output.....	76
Configuring DSP/Surround.....	76
Correcting volume differences during playback.....	79
Enabling Lipsync adjustment.....	79
Checking information about the video/audio signals.....	80
Combining audio of another input source with video of the current input source.....	80
Selecting a video source to be output with the selected audio source.....	81
Switching between stereo and monaural for FM radio reception.....	81
Setting presets for radio stations.....	82
Configuring the shuffle setting.....	83
Configuring the repeat setting.....	83
Enabling volume control via AirPlay.....	83
Adding an Internet radio station to the "Favorites" folder.....	84
Removing an Internet radio station from the "Favorites" folder.....	84
Performing an initial scan for DAB radio reception.....	84
Checking reception strength of each DAB channel label.....	85

CONFIGURATIONS 86

Configuring various functions (Setup menu).....	86
Basic operation of the Setup menu.....	86
Setup menu items.....	87

Configuring the speaker settings.....	90
Setting your speaker system.....	90
Setting the use of a subwoofer.....	90
Setting the size of the front speakers.....	91
Setting the use of a center speaker and its size.....	91
Setting the use of surround speakers and their size.....	92
Setting the crossover frequency of the low-frequency components.....	92
Setting the phase of the subwoofer.....	93
Setting the use of Extra Bass.....	93
Setting the use of Virtual CINEMA FRONT.....	93
Setting the distance between each speaker and the listening position.....	93
Adjusting the volume of each speaker.....	94
Setting the equalizer.....	94
Outputting test tones.....	95

Configuring the HDMI settings.....	96
Setting the use of HDMI Control.....	96
Setting the output of HDMI audio from the TV speaker.....	96
Setting the use of HDMI Standby Through.....	96
Setting the use of 4K upscaling of the HDMI video signal.....	96
Setting the version of HDCP used on the HDMI input jacks.....	97
Setting the audio jack used for TV audio input.....	97
Linking the standby modes of the unit and the TV.....	97
Setting the use of ARC.....	97
Setting the use of SCENE link playback.....	98

Configuring the sound settings.....	99
Setting the broadening effect of the front sound field.....	99
Adjusting the broadening effect of the center sound field.....	99
Adjusting the difference in level between the front and surround sound fields.....	99
Adjusting the center localization (broadening effect) of the front sound field.....	99
Setting the use of Monaural Mix.....	100
Setting the adjustment method of the Lipsync function.....	100
Adjusting the delay of the Lipsync function.....	100
Adjusting the volume of dialogue sound.....	100
Setting the scale of the volume display.....	101
Setting the dynamic range adjustment method.....	101
Setting the Main zone limit value of the volume.....	101
Setting the Main zone initial volume when the unit is turned on.....	101
Setting the Zone2 limit value of the volume.....	102
Setting the Zone2 initial volume when the Zone2 output is enabled.....	102

Configuring the power supply settings.....	103
Setting the amount of time for the auto-standby function.....	103
Setting the use of the eco mode.....	103
Configuring the function settings.....	104
Automatically changing the input source names displayed on the front display.....	104
Manually changing the input source names displayed on the front display.....	104
Setting input sources to be skipped when operating the INPUT knob.....	105
Adjusting the brightness of the front display.....	105
Preventing accidental changes to the settings.....	105
Setting the unit's functions for the RED/GREEN/YELLOW/BLUE keys of the remote control.....	106
Setting the use of switching to the party mode.....	106
Configuring the network settings.....	107
Checking the network information of the unit.....	107
Setting the network connection method (Wired/Wireless).....	107
Setting the network parameters automatically (DHCP).....	107
Setting the network parameters manually.....	108
Setting the MAC address filter.....	108
Setting the use of a Digital Media Controller.....	109
Setting the use of the Network Standby function.....	109
Setting the network name of the unit.....	110
Setting the power interlock from the unit to MusicCast compatible devices.....	110
Updating the firmware via the network.....	110
Configuring the Bluetooth® settings.....	111
Setting the use of Bluetooth®.....	111
Terminating the connection between a Bluetooth® device and the unit.....	111
Setting the use of the Bluetooth® Standby function.....	111
Configuring the language settings.....	112
Setting the on-screen menu language.....	112

Configuring the advanced settings (ADVANCED SETUP menu).....	113
Basic operation of the ADVANCED SETUP menu.....	113
ADVANCED SETUP menu items.....	113
Changing the speaker impedance setting (SP IMP.).....	114
Selecting the remote control ID (REMOTE ID).....	114
Changing the FM/AM tuning frequency setting (TU).....	114
Switching the video signal type (TV FORMAT).....	114
Selecting the HDMI 4K signal format (4K MODE).....	115
Backing up and restoring all the settings (BKUP/RSTR).....	115
Restoring the default settings (INIT).....	116
Updating the firmware (UPDATE).....	116
Checking the firmware version (VERSION).....	116

TROUBLESHOOTING 117

When any problem appears.....	117
If trouble occurs, first check the following:.....	117
Power, system, or remote control trouble.....	117
Audio trouble.....	119
Video trouble.....	122
FM/AM radio trouble (AM radio feature is not available for U.K., Europe and Australia models).....	123
DAB radio trouble (U.K., Europe and Australia models).....	123
USB trouble.....	124
Network trouble.....	125
Bluetooth® trouble.....	127
Error indications on the front display.....	128
Error indications on the front display.....	128

APPENDIX 130

Updating the unit's firmware via the network.....	130
Firmware updates.....	130
Updating the unit's firmware via the network.....	131

Connecting to a network wirelessly.....	132
Selecting a wireless network connection method.....	132
Setting up a wireless connection using the WPS button.....	133
Setting up a wireless connection using an iOS device.....	133
Setting up a wireless connection by selecting from the list of available access points.....	134
Setting up a wireless connection manually.....	135
Setting up a wireless connection by using the WPS PIN code.....	136
Input/output jacks and cables.....	137
Video/audio jacks.....	137
Video jacks.....	137
Audio jacks.....	137
Glossary.....	138
Glossary of audio information.....	138
Glossary of HDMI and video information.....	139
Glossary of network information.....	139
Glossary of Yamaha technologies.....	139
Supported devices and file formats.....	140
Supported Bluetooth® devices.....	140
Supported USB devices.....	140
Supported AirPlay devices.....	140
Supported file formats.....	141
Video signal flow.....	141
Video signal flow.....	141
Additional information on HDMI.....	142
HDMI Control and synchronized operations.....	142
Audio Return Channel (ARC).....	143
HDMI signal compatibility.....	144
Trademarks.....	145
Trademarks.....	145
Specifications.....	146
Specifications.....	146
Default settings.....	151
Default settings of the Option menu.....	151
Default settings of the Setup menu.....	151
Default settings of the ADVANCED SETUP menu.....	152

BEFORE USING THE UNIT

How to use this manual

How to use this manual

When reading this manual, mind the following items.

- The illustrations of the main unit used in this manual are of the U.S.A. model, unless otherwise specified.
- Some features are not available in certain regions.
- Due to product improvements, specifications and appearance are subject to change without notice.
- This manual mainly explains operations using the menu displayed on the TV screen. Operations with the TV screen menu are only available when your TV is connected to the unit via HDMI.
- This manual explains operations using the supplied remote control.
- This manual describes all the "iPod touch", "iPhone" and "iPad" as the "iPhone". "iPhone" refers to "iPod touch", "iPhone" and "iPad", unless otherwise specified.

Warning:

Indicates precautions for the possibility of death or serious injury.

Caution:

Indicates precautions for the possibility of minor or moderate injury.

Notice:

Indicates precautions for use to avoid the possibility of malfunction/damage to the unit.

Note:

Indicates instructions and supplementary explanations for optimum use.

Checking the accessories

Checking the accessories

Check that the following accessories are supplied with the product.

AM antenna (Except for U.K., Europe and Australia models)



FM antenna (Except for U.K., Europe and Australia models)

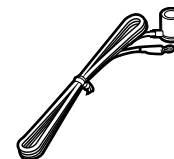

* One of the above is supplied depending on the region of purchase.

DAB/FM antenna (U.K., Europe and Australia models)



Remote control

Batteries (AAA, R03, UM-4) (x2)

YPAO microphone

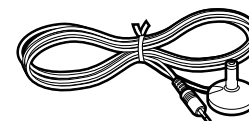

Quick Start Guide

Note

Access the Yamaha Downloads site to download the latest Owner's Manual and Quick Start Guide.
<http://download.yamaha.com/>

Using the remote control

Insert the batteries in the remote control

Insert the batteries the right way round.

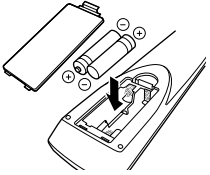

Operating range of the remote control

Point the remote control at the remote control sensor on the unit and remain within the operating range shown in the following figure.

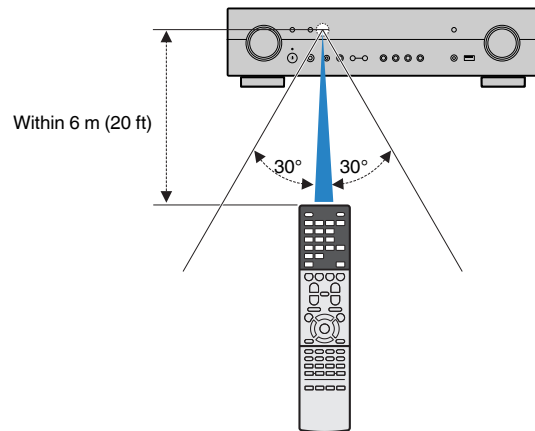

FEATURES

What you can do with the unit

Supporting 2- to 5.1-channel speaker system

According to the number of speakers that you are using, you can enjoy your favorite acoustic spaces in various styles.

- “Using 5.1-channel system” (p.20)
- “Using 3.1-channel system” (p.21)
- “Using Virtual CINEMA FRONT” (p.22)
- “Playing back music in multiple rooms” (p.43)

Automatically optimizing the speaker settings (YPAO)

YPAO function detects speaker connections, measures the distances from them to your listening position by using YPAO microphone measurement, and then automatically optimizes the speaker settings, such as volume balance and acoustic parameters, to suit your room (YPAO: Yamaha Parametric room Acoustic Optimizer).

- “Optimizing the speaker settings automatically (YPAO)” (p.33)

Enjoying sound field effects with much presence

The unit is equipped with a variety of sound programs and surround decoders that allow you to enjoy playback sources with your favorite sound mode (such as sound field effect or stereo playback).

- “Enjoying 3D sound fields (CINEMA DSP 3D)” (p.38)
- “Enjoying sound field effects optimized for the type of content” (p.39)
- “Enjoying sound field effects without surround speakers (Virtual CINEMA DSP)” (p.39)
- “Enjoying surround sound with headphones (SILENT CINEMA)” (p.39)
- “Enjoying original sound (straight decode)” (p.40)
- “Enjoying multichannel playback without sound field effects (surround decoder)” (p.40)
- “Enjoying pure high fidelity sound (direct playback)” (p.41)
- “Enhancing the bass (Extra Bass)” (p.41)
- “Playing back digitally compressed formats with enriched sound (Compressed Music Enhancer)” (p.42)

Wide variety of supported content via network

When the unit is connected to a network, you can enjoy the various kinds of content via network on the unit.

- “Playback of iTunes/iPhone music contents with AirPlay” (p.64)
- “Playing back music stored on media servers (PCs/NAS)” (p.66)
- “Selecting an Internet radio station” (p.68)
- “Listening to a streaming service” (p.69)

Playing back content of various devices

A number of HDMI jacks and various input/output jacks on the unit allow you to connect video devices (such as BD/DVD players), audio devices (such as CD players), Bluetooth devices (such as smartphones), game consoles, USB storage devices, and other devices. You can play back content of them.

- “Selecting a frequency for reception” (p.50)
- “Playback Bluetooth® device music on the unit” (p.63)
- “Playback of USB storage device contents” (p.65)

Useful functions

The unit is equipped with the various useful functions. The SCENE function allows you to select the input source and settings registered to the corresponding scene, such as sound program and Compressed Music Enhancer on/off, with just one touch. When the unit is connected to an HDMI Control-compatible TV with an HDMI cable, you can control the unit (such as power and volume) with TV remote control operations.

- “Selecting the input source and favorite settings with one touch (SCENE)” (p.70)
- “Registering a favorite content as shortcut” (p.72)
- “HDMI Control and synchronized operations” (p.142)
- “Audio Return Channel (ARC)” (p.143)

Useful applications

Application: “AV SETUP GUIDE”



AV SETUP GUIDE is an application that assists you with cable connections between AV Receiver and playback devices as well as AV Receiver setup. This app guides you through the various settings such as speaker connections, TV and playback device connections and selecting the speaker system.

For details, search for “AV SETUP GUIDE” on the App Store or Google Play.

Application: “AV CONTROLLER”



AV CONTROLLER is an application that assists you with various operations of AV Receiver without the remote control. This app allows you not only to control the unit's power and volume but also to select the input source and start/stop playback.

For details, search for “AV CONTROLLER” on the App Store or Google Play.

Application: “MusicCast CONTROLLER”



MusicCast CONTROLLER is an application that allows you to link a MusicCast compatible device to other MusicCast compatible devices in other rooms and play them back simultaneously. This app lets you use your smartphone or other mobile device instead of the remote control to easily select music to play back as well as configure the unit and MusicCast compatible devices.

For details, search for “MusicCast CONTROLLER” on the App Store or Google Play.

Part names and functions

Part names and functions of the front panel

The part names and functions of the front panel are as follows.

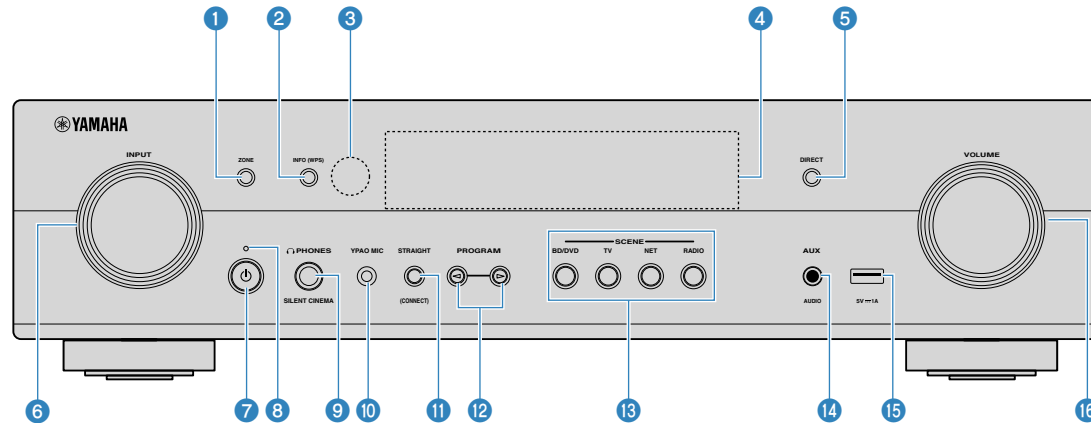

(U.S.A. model)

1 ZONE key

Enables/disables the audio output to Zone2 (p.44).

2 INFO (WPS) key

Selects the information displayed on the front display (p.46).

Enters the wireless LAN connection setup (WPS button configuration) by holding down for a few seconds (p.133).

3 Remote control sensor

Receives remote control signals (p.8).

4 Front display

Displays information (p.13).

5 DIRECT key

Enables/disables the direct playback mode (p.41).

6 INPUT knob

Select an input source.

7 (power) key

Turns on/off (standby) the unit.

8 Standby indicator

Lights up when the unit is in standby mode under any of the following conditions.

- HDMI Control is enabled (p.96)
- Standby Through is enabled (p.96)
- Network Standby is enabled (p.109)
- Bluetooth Standby is enabled (p.111)

9 PHONES jack

For connecting headphones.

10 YPAO MIC jack

For connecting the supplied YPAO microphone (p.33).

11 STRAIGHT (CONNECT) key

Enables/disables the straight decode mode (p.40).

Enters the MusicCast network addition and the wireless LAN setup by holding down for 5 seconds (p.37).

12 PROGRAM keys

Select a sound program or a surround decoder (p.38).

13 SCENE keys

Switch with one touch between multiple settings set using the SCENE function. Also, turns on the unit when it is in standby mode (p.70).

14 AUX jack

For connecting devices, such as portable audio players (p.26).

15 USB jack

For connecting a USB storage device (p.65).

16 VOLUME knob

Adjusts the volume.

Part names and functions of the front display

The part names and functions of the front display are as follows.

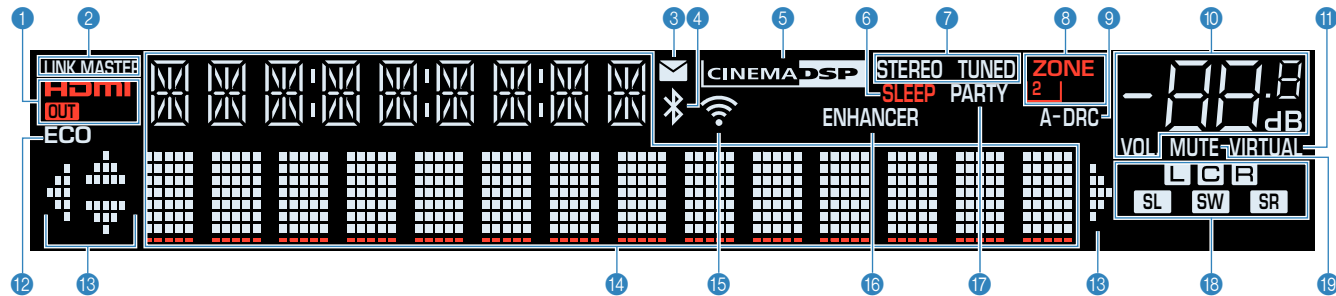

1 HDMI

Lights up when HDMI signals are being input or output.

OUT

Lights up when HDMI signals are being output.

2 LINK MASTER

Lights up when the unit is the master device of the MusicCast network.

3 Firmware update indicator

Lights up when a firmware update is available via the network.

4 Bluetooth indicator

Light up while the unit is connected to a Bluetooth device.

5 CINEMA DSP

Lights up when CINEMA DSP 3D (p.38) is working.

6 SLEEP

Lights up when the sleep timer is on.

7 STEREO

Lights up when the unit is receiving a stereo FM radio signal.

TUNED

Lights up when the unit is receiving an FM/AM radio station signal.

8 ZONE2

Lights up when audio output to Zone2 (p.44) is enabled.

9 A-DRC

Lights up when Adaptive DRC (p.78) is working.

10 Volume indicator

Indicates the current volume.

11 VIRTUAL

Lights up when the virtual processing (p.39) is working.

12 ECO

Lights up when the eco mode (p.103) is enabled.

13 Cursor indicators

Indicate the remote control cursor keys currently operational.

14 Information display

Displays the current status (such as input name and sound mode name). You can switch the information by pressing INFO (p.46).

15 Wireless LAN indicator

Light up while the unit is connected to a wireless network (p.132).

Note

This indicator may light up when the unit is added to the MusicCast network. For details, see "Adding the unit to the MusicCast network" (p.37).

16 ENHANCER

Lights up when Compressed Music Enhancer (p.42) is working.

17 PARTY

Lights up when the party mode (p.44) is enabled.

18 Speaker indicators

Indicate speaker terminals from which signals are output.

L Front speaker (L)

R Front speaker (R)

C Center speaker

SL Surround speaker (L)

SR Surround speaker (R)

SW Subwoofer

19 MUTE

Blinks when audio is temporarily muted.

Part names and functions of the rear panel

The part names and functions of the rear panel are as follows.

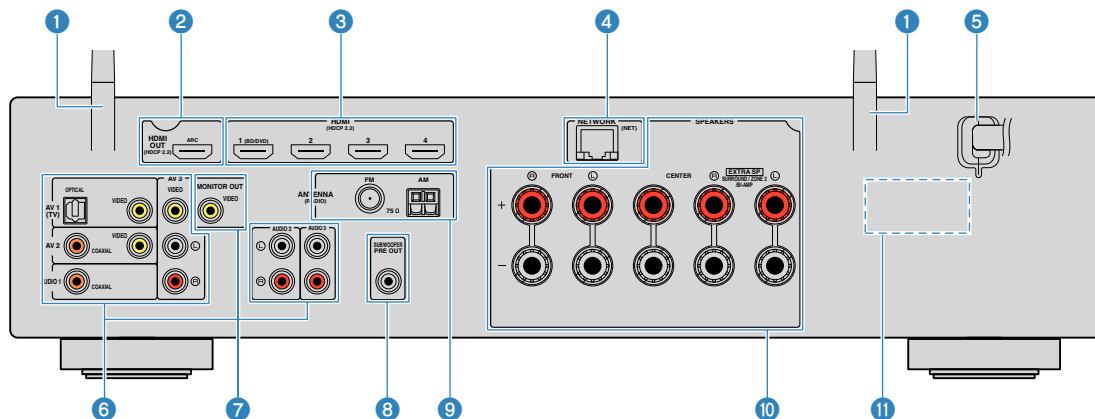

- The area around the video/audio output jacks is marked in white on the actual product to prevent improper connections.

1 Wireless antennas

For a wireless (Wi-Fi) connection to a network (p.132) and a Bluetooth connection (p.63).

2 HDMI OUT jack

For connecting to an HDMI-compatible TV and outputting video/audio signals (p.24). When using ARC, TV audio signal can also be input through the HDMI OUT jack.

3 HDMI 1-4 jacks

For connecting to HDMI-compatible playback devices and inputting video/audio signals (p.25).

4 NETWORK jack

For a wired connection to a network (p.29).

5 Power cable

For connecting to an AC wall outlet (p.30).

6 AV jacks AUDIO jacks

For connecting to video/audio playback devices and inputting video/audio signals (p.25).

7 MONITOR OUT jack

For connecting to a TV and outputting video signals (p.24).

8 SUBWOOFER PRE OUT jack

For connecting to a subwoofer (with built-in amplifier) (p.19).

9 ANTENNA jacks

For connecting to the radio antennas (p.27).

10 SPEAKERS terminals

For connecting to speakers (p.16).

11 VOLTAGE SELECTOR

(Taiwan, and Central and South America models only)
Selects the switch position according to your local voltage (p.30).

(U.S.A. model)

Part names and functions of the remote control

The part names and functions of the supplied remote control are as follows.

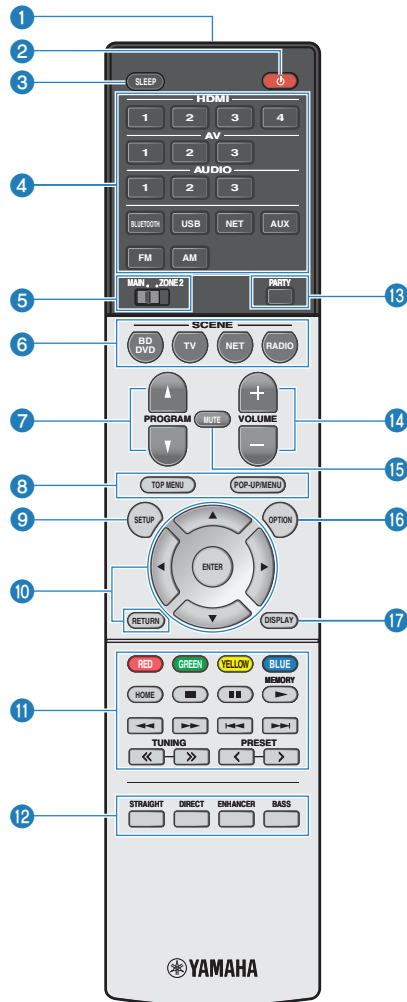

(U.S.A. model)

1 Remote control signal transmitter

Transmits infrared signals.

2 (receiver power) key

Turns on/off (standby) the unit.

3 SLEEP key

Pressing this key repeatedly will specify the time (120 min, 90 min, 60 min, 30 min, off), in which the unit switches to the standby mode.

4 Input selection keys

Selects an input source for playback directly by pressing each key.

Note

Presses NET repeatedly to select a desired network source.

5 MAIN/ZONE 2 switch

Changes the zone that is controlled by the remote control (p.44).

6 SCENE keys

Switch with one touch between multiple settings set using the SCENE function. Also, turn on the unit when it is in standby mode (p.70).

7 PROGRAM key

Select a sound program or a surround decoder (p.40).

8 10 11 15 16 External device operation keys

Let you perform playback operations when "USB" or "NET" is selected as the input source, or control playback of the HDMI Control-compatible playback device.

Note

- The playback devices must support HDMI Control. Some HDMI Control-compatible devices cannot be used.
- You can assign the unit's functions to the RED/GREEN/YELLOW/BLUE keys (p.106).

9 SETUP key

Displays the setup menu (p.86).

10 Menu operation keys

Operates the menu.

11 Playback operation keys

Controls playback of the external device.

12 Sound mode keys

Select a sound mode (p.38).

13 PARTY key

Turns on/off the party mode (p.44).

14 VOLUME keys

Adjust the volume.

15 MUTE key

Mutes the audio output.

16 OPTION key

Displays the option menu (p.74).

17 DISPLAY key

Turns on/off the browse screen, playback screen, etc.

PREPARATIONS

1 Connecting speakers

Names and functions of speakers

The names and functions of speakers connected to the unit are as follows.

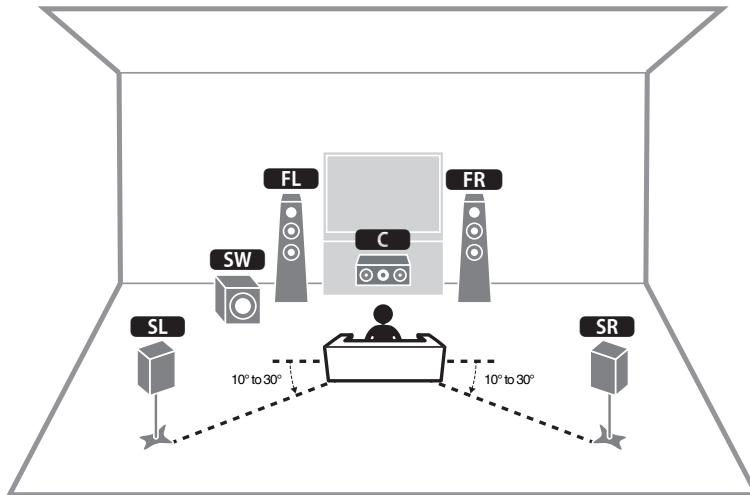

Note

Use this diagram as a reference for the ideal speaker layout for the unit. Your speaker layout does not need to match the diagram exactly, since the YPAO function can be used to automatically optimize the speaker settings (such as distances) to suit the actual speaker layout.

Speaker type	Abbr.	Function
Front (L/R)	FL / FR	Produce front channel sounds (stereo sounds).
Center	C	Produces center channel sounds (such as movie dialogue and vocals).
Surround (L/R)	SL / SR	Produce surround channel sounds.
Subwoofer	SW	Produces LFE (low-frequency effect) channel sounds and reinforces the bass parts of other channels.

Speaker systems and speakers to be connected

Select the speaker layout for the number of speakers that you are using and place the speakers and subwoofer in your room.

Speaker type	Speaker system (the number of channels)		
	5.1	3.1	2.1
Front (L/R) FL / FR	●	●	●
Center C	●	●	
Surround (L/R) SL / SR	●		
Subwoofer SW	●	●	●

Speaker requirements

Speakers and subwoofers to be connected to the unit must meet the following requirements:

- (U.S.A. model only)
Under its default settings, the unit is configured for 8-ohm speakers. When connecting 6-ohm speakers, set the unit's speaker impedance to "6 Ω MIN". For details, see the following:
 - "Setting the speaker impedance" (p.18)
- (Except for U.S.A. model)
Use speakers with an impedance of at least 6 Ω.
- Use a subwoofer with built-in amplifier.

Note

- Prepare the number of speakers according to your speaker system.
- Be sure to connect the front left and right speakers.

Setting the speaker impedance

(U.S.A. model only)

Under its default settings, the unit is configured for 8-ohm speakers. When connecting 6-ohm speakers, set the speaker impedance to "6 Ω MIN".

- 1 Before connecting speakers, connect the power cable to an AC wall outlet.
- 2 While holding down STRAIGHT on the front panel, press  (power).

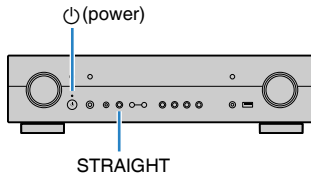

- 3 Check that "SP IMP." is displayed on the front display.



- 4 Press STRAIGHT to select "6 Ω MIN".
- 5 Press  (power) to set the unit to standby mode and remove the power cable from the AC wall outlet.

You are now ready to connect the speakers.

Cable requirements

Use the following types of commercially-available cables to connect speakers to the unit:

Speaker cables (the number of speakers required)



Audio pin cable (for connecting a subwoofer)



How to connect speakers

Connecting the speaker

Connect a speaker cable between the negative (-) terminal of the unit and the negative (-) terminal of the speaker, and between the positive (+) terminal of the unit and the positive (+) unit of the speaker.

Notice

When connecting the speaker cables, take notice of the following:

- Prepare speaker cables in a place away from the unit, to avoid accidentally dropping wire strands into the unit's interior which could result in a short circuit or malfunction of the unit.
- Improper connecting of the speaker cables may cause a short circuit and also damage the unit or the speakers.

– Twist the bare wires of the speaker cables firmly together.

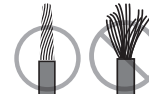

– Do not let the bare wires of the speaker cable touch one another.

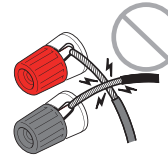

– Do not let the bare wires of the speaker cable come into contact with the unit's metal parts (rear panel and screws).

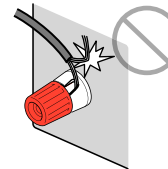

Note

- Remove the unit's power cable from an AC wall outlet before connecting the speakers.
- Be sure to connect the front left and right speakers.
- (U.S.A. model only)
Under its default settings, the unit is configured for 8-ohm speakers. When connecting 6-ohm speakers, set the unit's speaker impedance to "6 Ω MIN". For details, see the following:
 - "Setting the speaker impedance" (p.18)

1 Remove approximately 10 mm (3/8") of insulation from the ends of the speaker cable, and twist the bare wires of the cable firmly together.

2 Loosen the speaker terminal.

3 Insert the bare wires of the cable into the gap on the side (upper right or bottom left) of the terminal.

4 Tighten the terminal.

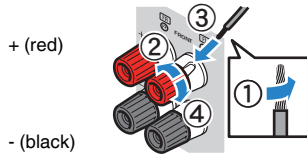

This completes the connection.

Note

- If "Check SP Wires" appears on the front display when the unit is turned on, turn off the unit, and then confirm that the speaker cables are not short circuited.
- (U.S.A., China, Taiwan, and Central and South America models only)
When using a banana plug, tighten the speaker terminal and insert a banana plug into the end of the terminal.

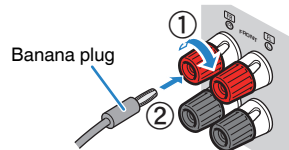

Connecting the subwoofer

Use an audio pin cable to connect the subwoofer.

Note

Unplug the power cables of the unit and subwoofer from the AC wall outlets before connecting the subwoofer.

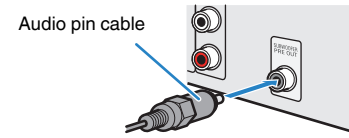

How to place speakers (speaker systems)

■ Using 5.1-channel system

This is a basic speaker layout recommended for enjoying surround sound.

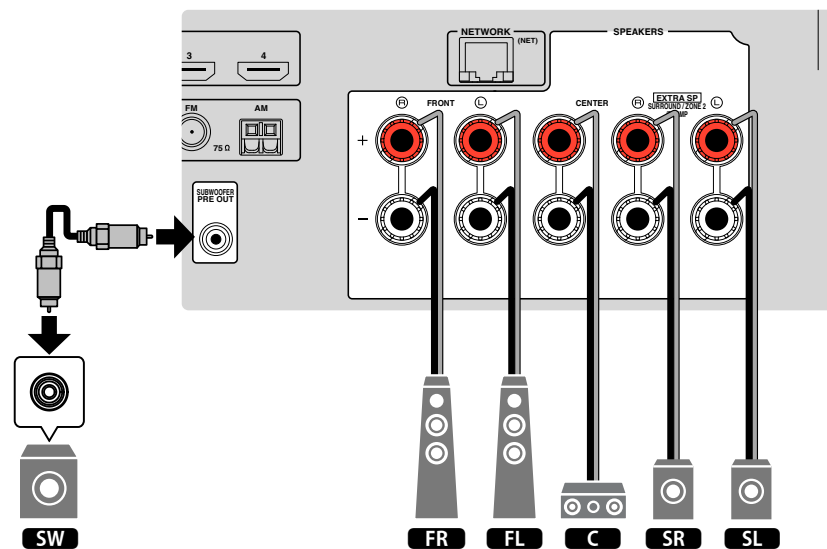
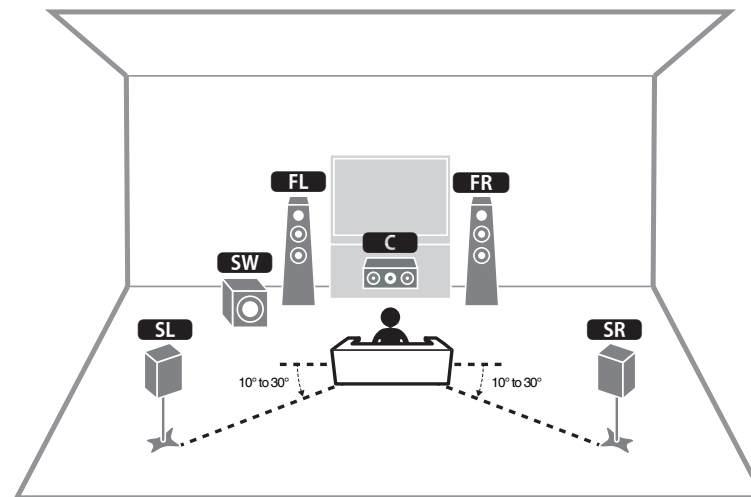

Using 3.1-channel system

This is a speaker layout recommended for enjoying stereo sound with a center speaker. Center channel sound such as movie dialogue and vocals can be clearly obtained.

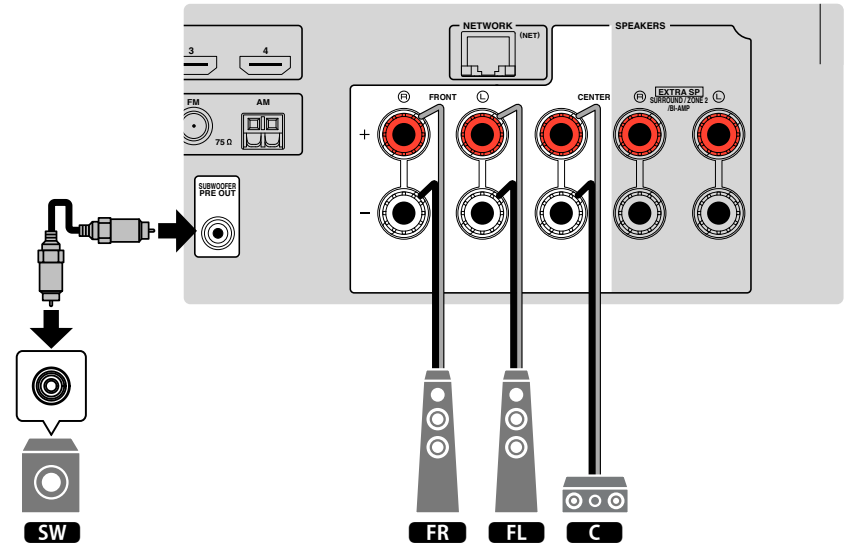
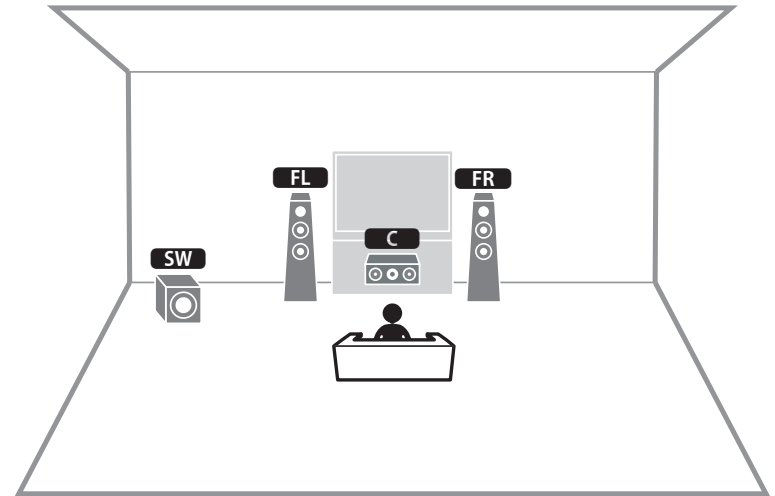

Using Virtual CINEMA FRONT

This speaker layout is recommended if you cannot place speakers in the back of the room.

Note

To use Virtual CINEMA FRONT, the speaker configuration settings must be changed. For details, see the following:

- “Assigning speaker configuration” (p.32)
- “Setting the use of Virtual CINEMA FRONT” (p.93)

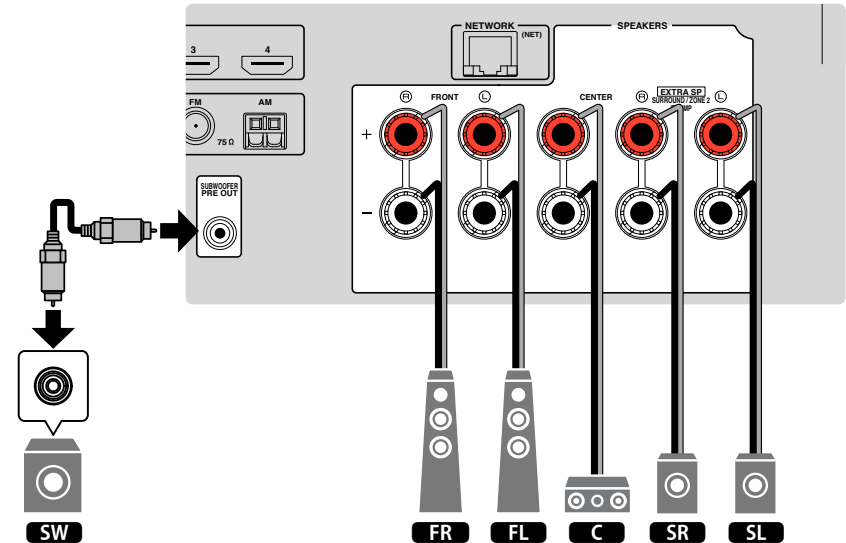
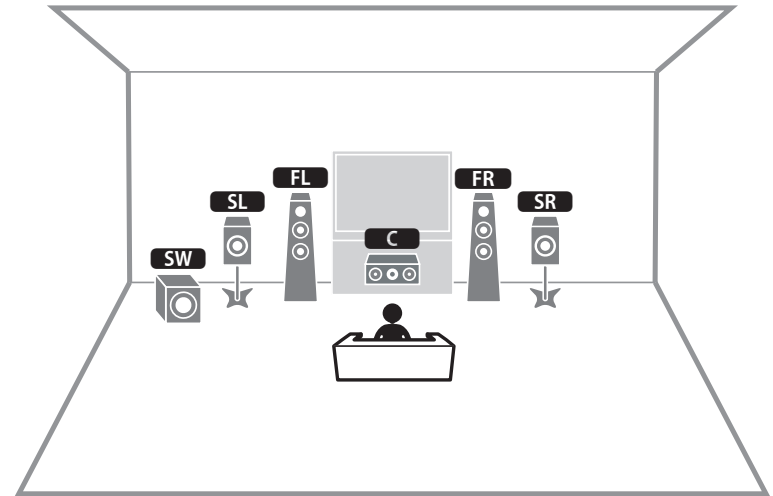

Connecting front speakers that support bi-amp connections

You can connect the front speakers that support bi-amp connections.

To enable the bi-amp function, configure the necessary speaker settings. For details, see the following:

- “Assigning speaker configuration” (p.32)
- “Setting your speaker system” (p.90)

Notice

- Before making bi-amp connections, remove any brackets or cables that connect a woofer with a tweeter. Refer to the instruction manual of the speakers for details. If you are not making bi-amp connections, make sure that the brackets or cables are connected before connecting the speaker cables.

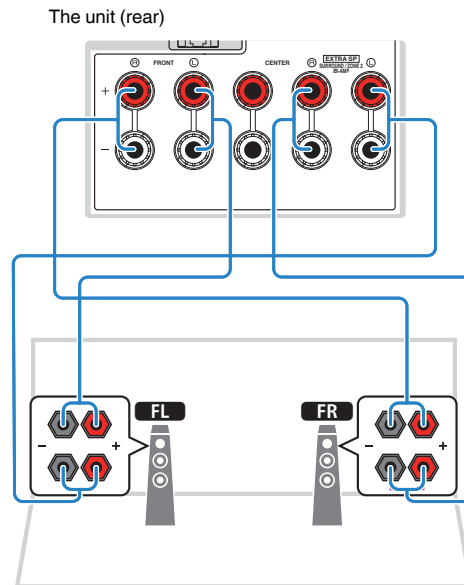

Note

- The following speakers cannot be connected simultaneously.
 - Surround speakers
 - Zone2 speakers
 - Bi-amp speakers
- The FRONT terminals and SURROUND/ZONE 2/BI-AMP terminals output the same signals.

2 Connecting a TV

HDMI connection with a TV

Connect a TV to the unit with an HDMI cable. If you connect a TV that supports ARC to the unit, you can output video/audio to the TV or input TV audio to the unit.

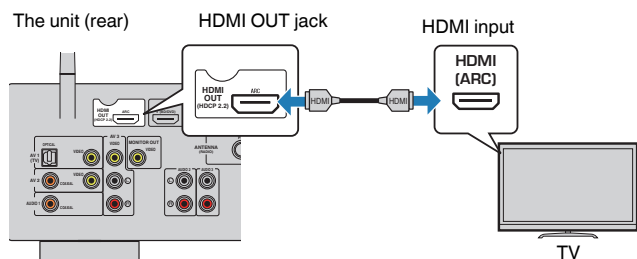

About Audio Return Channel (ARC)

- ARC allows audio signals to travel both ways with a single HDMI cable. To use ARC, connect to the TV using an HDMI cable that supports ARC.

Note

- If you connect a TV that supports HDMI Control to the unit with an HDMI cable, you can control the unit's power and volume with the TV's remote control.
- To use HDMI Control and ARC, you need to configure the HDMI settings on the unit. For details on the settings, see the following:
 - "HDMI Control and synchronized operations" (p.142)
 - "Audio Return Channel (ARC)" (p.143)
- If your TV does not support Audio Return Channel (ARC), a digital optical cable connection between the TV and the unit is needed.

VIDEO (composite video) connection with a TV

Connect a TV to the unit with a video pin cable and a digital optical cable.

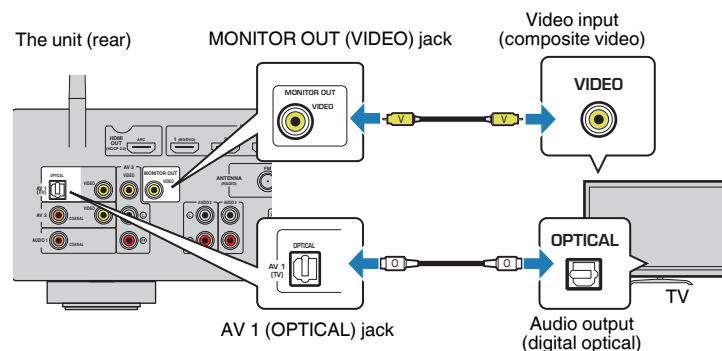

Note

- If you connect your TV to the unit with a cable other than HDMI, video input to the unit via HDMI cannot be output to the TV. For details, see the following:
 - "Video signal flow" (p.141)
- Operations with TV screen are available only when your TV is connected to the unit via HDMI.
- A digital optical cable connection allows audio from the TV to be played back on the unit. A digital optical cable connection is not needed in the following case:
 - If you will receive TV broadcasts only from the set-top box

3 Connecting playback devices

HDMI connection with a video device such as a BD/DVD player

Connect a video device to the unit with an HDMI cable.

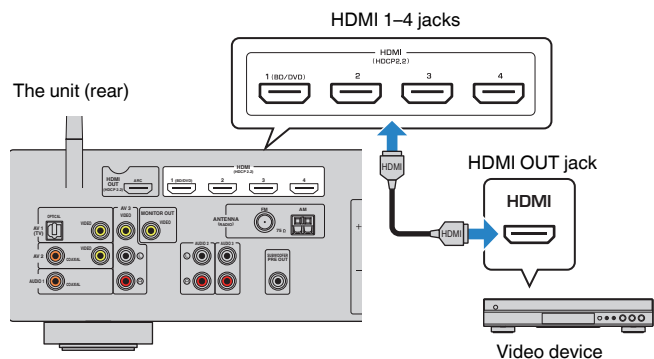

Note

To watch video input to the HDMI 1-4 jacks, you need to connect your TV to the HDMI OUT jack of the unit. For details, see the following:

- "HDMI connection with a TV" (p.24)

Connection other than HDMI with a playback device

VIDEO (composite video) connection with a video device

Connect a video device to the unit with a video pin cable and an audio cable (digital optical, digital coaxial or stereo pin cable). Choose a set of input jacks (on the unit) depending on the audio output jacks available on your video device.

Output jacks on video device		Input jacks on the unit
Video	Audio	
Composite video	Digital optical	AV 1 (VIDEO + OPTICAL)
	Digital coaxial	AV 2 (VIDEO + COAXIAL)
	Analog stereo	AV 3 (VIDEO + AUDIO)

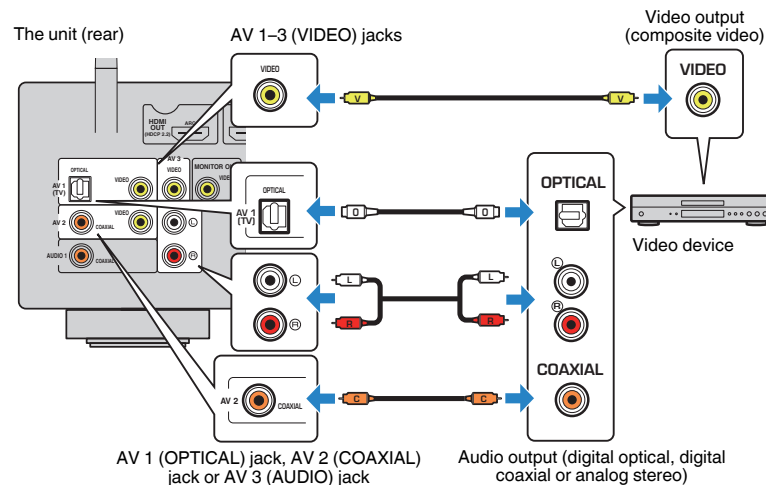

Note

If you connect a video device to the unit via composite video connection, you need to connect your TV to the MONITOR OUT (VIDEO) jack of the unit. For details, see the following:

- "VIDEO (composite video) connection with a TV" (p.24)

AUDIO connection with an audio device such as a CD player

Connect audio devices such as CD players and MD players to the unit. Depending on the audio output jacks available on your audio device, choose one of the following connections.

Note

To use a turntable, a commercially-available phono equalizer amplifier is required. Connect the output of the phono equalizer amplifier to the unit.

Audio output jacks on audio device	Audio input jacks on the unit
Digital optical	AV 1 (OPTICAL)
Digital coaxial	AUDIO 1 (COAXIAL) AV 2 (COAXIAL)
Analog stereo	AUDIO 2-3 (AUDIO) AV 3 (AUDIO)

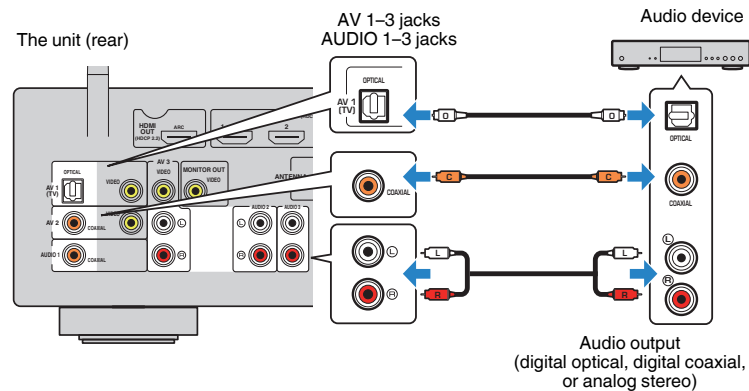

Note

"AV1" is set as TV audio input at the factory. If you have connected any external device to the AV 1 jack, use "TV Audio Input" in the "Setup" menu to change the TV audio input assignment. To use the SCENE function, you also need to change the input assignment for SCENE (TV). For details, see the following:

- "Setting the audio jack used for TV audio input" (p.97)
- "Registering a scene" (p.71)

Connecting to the jack on the front panel

Use the AUX jack on the front panel to temporarily connect devices such as portable audio players to the unit.



Caution

- Before making a connection, stop playback on the device and turn down the volume on the unit. The volume may be unexpectedly loud, and this could result in damage to hearing.

Note

You need to prepare the audio cable that matches the output jacks on your device.

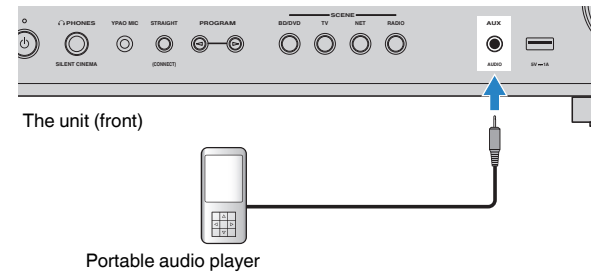

If you select "AUX" as the input source by pressing AUX, the audio played back on the device will be output from the unit.

4 Connecting the radio antennas

Connecting the FM/AM antennas (Except for U.K., Europe and Australia models)

Connect the supplied FM/AM antennas to the unit.

Fix the end of the FM antenna to a wall, and place the AM antenna on a flat surface.

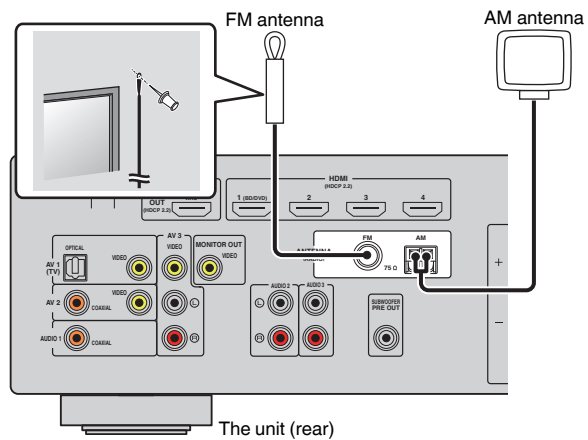

Assembling and connecting the AM antenna

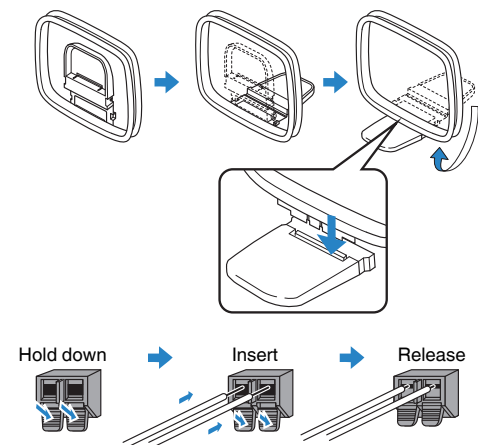

Note

- Unwind only the length of cable needed from the AM antenna unit.
- The wires of the AM antenna have no polarity.

Connecting the DAB/FM antenna (U.K., Europe and Australia models)

Connect the supplied DAB/FM antenna to the unit and fix the antenna ends to a wall.

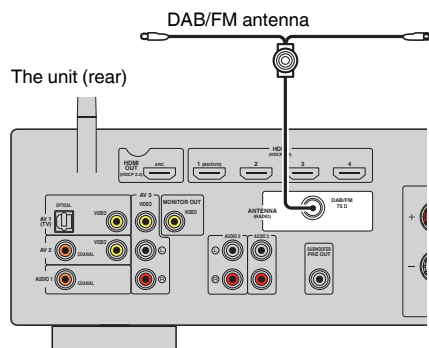

Note

- The antenna should be stretched out horizontally.
- If you cannot obtain good reception on the radio, adjust the height, direction or placement of the DAB/FM antenna.

5 Preparing for connecting to a network

Preparing for connecting to a network

The unit supports wired and wireless connections. Select a connection method according to your network environment.

If you are using a router that supports DHCP in the wired connection, you do not need to configure any network settings for the unit.

Note

You need to configure the network settings if your router does not support DHCP or if you want to configure the network parameters manually. For details, see the following:

- “Setting the network parameters manually” (p.108)

To connect the unit to a wireless network, select one of the following methods to configure the wireless network settings.

● Method using the MusicCast setting

When adding the unit to the MusicCast network, you can also configure the unit's wireless network settings at once. If you use MusicCast CONTROLLER, we recommend the wireless connection to MusicCast network. For details, see the following:

- “Adding the unit to the MusicCast network” (p.37)

● Other methods

For details, see the following:

- “Selecting a wireless network connection method” (p.132)

Connecting a network cable (wired connection)

Connect the unit to your router with a commercially-available STP network cable (CAT-5 or higher straight cable).

You can enjoy Internet radio or music files stored on media servers, such as PCs and Network Attached Storage (NAS), on the unit.

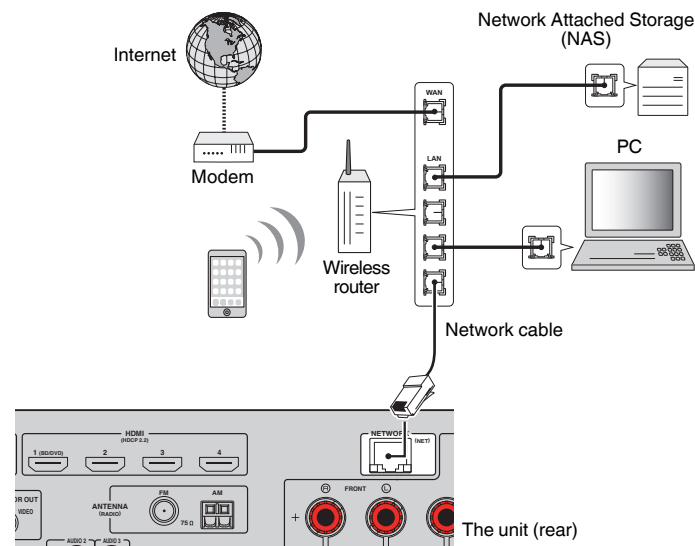

Note

- If you are using a router that supports DHCP, you do not need to configure any network settings for the unit, as the network parameters (such as the IP address) will be assigned automatically to it. You only need to configure the network settings if your router does not support DHCP or if you want to configure the network parameters manually. For details, see the following:
 - “Setting the network parameters manually” (p.108)
- You can check whether the network parameters (such as IP address) are properly assigned to the unit. For details, see the following:
 - “Checking the network information of the unit” (p.107)

Preparing wireless antennas (wireless connection)

Stand the wireless antennas upright for connecting to the wireless network or a Bluetooth device wirelessly.

For information on how to connect the unit to a wireless network, see the following:

- “Preparing for connecting to a network” (p.29)

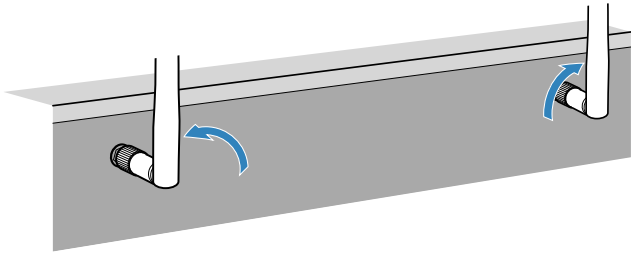

Notice

- Do not apply excessive force on the wireless antenna. Doing so may damage the antenna.

6 Plugging in the power cable

Plugging in the power cable



Warning

(Taiwan, and Central and South America models only)

Make sure you set VOLTAGE SELECTOR of the unit BEFORE plugging the power cable into an AC wall outlet. Improper setting of VOLTAGE SELECTOR may cause damage to the unit and create a potential fire hazard.

Before plugging in the power cable

Set the switch position of VOLTAGE SELECTOR according to your local voltage. Voltages are AC 110–120/220–240 V, 50/60 Hz.

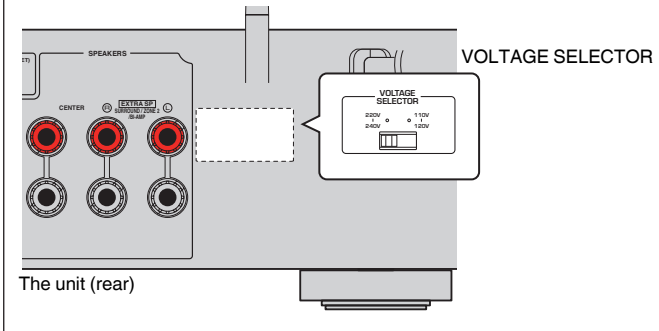

After all the connections are complete, plug in the power cable.

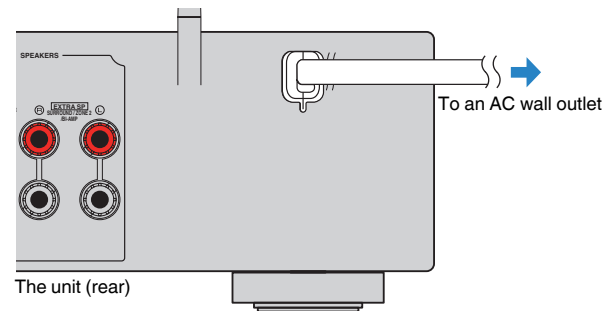

7 Selecting the on-screen menu language

Selecting the on-screen menu language

Select the desired on-screen menu language.

- 1 Press **⏻** (receiver power) to turn on the unit.
- 2 Turn on the TV and switch the TV input to display video from the unit (HDMI OUT jack).

Note

When you turn on the unit for the first time, a message regarding the network setup appears. You can switch the language on this message screen.

- 3 Press **SETUP**.
- 4 Use the cursor keys to select “Language” and press **ENTER**.

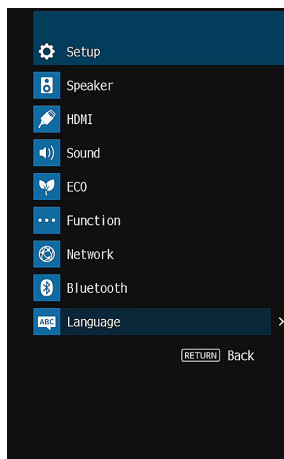

- 5 Use the cursor keys to select the desired language.

- 6 To exit from the menu, press **SETUP**.

This completes the necessary settings.

Note

The information on the front display is provided in English only.

8 Configuring the necessary speaker settings

Assigning speaker configuration

If you use any of the following speaker configurations, perform the following procedure to configure the corresponding speaker settings manually before performing YPAO.

- Using the bi-amp connection (playing back more high-quality sounds with bi-amp connections)
- Using the Zone2 speakers
- Using the surround speakers for front 5.1-channel system (Virtual CINEMA FRONT)

Note

For details on the speaker configurations, see the following:

- “Connecting front speakers that support bi-amp connections” (p.23)
- “Playing back music in multiple rooms” (p.43)
- “Using Virtual CINEMA FRONT” (p.22)

- 1 Press  (receiver power) to turn on the unit.**
- 2 Turn on the TV and switch the TV input to display video from the unit (HDMI OUT jack).**

Note
If you turn on the unit for the first time, the message regarding the network setup appears. For now, press RETURN and proceed to Step 3.
- 3 Press SETUP.**
- 4 Use the cursor keys to select “Speaker” and press ENTER.**
- 5 Use the cursor keys to select “Configuration” and press ENTER.**

6 Configure the corresponding speaker settings.

- Using bi-amp connections or Zone2 speakers, select your speaker system in “Power Amp Assign”. For details, see the following:
 - “Setting your speaker system” (p.90)
- Using the surround speakers for front 5.1-channel system (Virtual CINEMA FRONT), select “On” in “Virtual CINEMA FRONT”. For details, see the following:
 - “Setting the use of Virtual CINEMA FRONT” (p.93)

7 To exit from the menu, press SETUP.

This completes the speaker settings.

Optimizing the speaker settings automatically (YPAO)

The Yamaha Parametric room Acoustic Optimizer (YPAO) function detects speaker connections, measures the distances from them to your listening position(s), and then automatically optimizes the speaker settings, such as volume balance and acoustic parameters, to suit your room.

Note

- Use YPAO after connecting a TV and speakers to the unit.
- Configure the corresponding speaker settings manually before performing YPAO. For details on the settings, see the following:
 - “Assigning speaker configuration” (p.32)
- During the measuring process, test tones are output at high volume, and you cannot adjust the volume.
- During the measuring process, keep the room as quiet as possible and do not stand between the speakers and the YPAO microphone for accurate measurement.
- Do not connect headphones.

- 1** Press  (receiver power) to turn on the unit.
- 2** Turn on the TV and switch the TV input to display video from the unit (HDMI OUT jack).
- 3** Turn on the subwoofer and set the volume to half. If the crossover frequency is adjustable, set it to maximum.

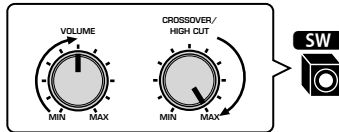

- 4** Place the YPAO microphone at your listening position and connect it to the YPAO MIC jack on the front panel.

Place the YPAO microphone at your listening position (same height as your ears). We recommend the use of a tripod as a microphone stand. You can use the tripod screws to stabilize the microphone.

The unit (front)

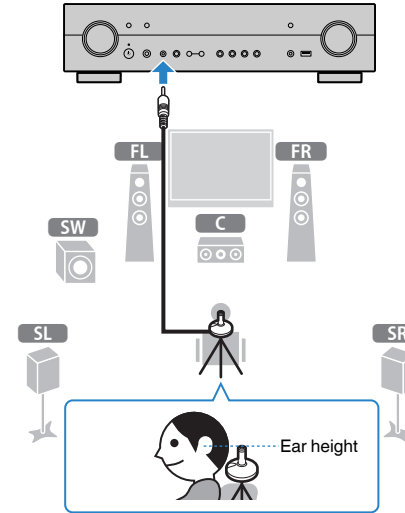

The following screen appears on the TV.

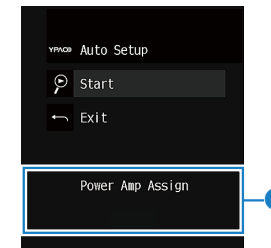

- 1** Setting of “Power Amp Assign” in the “Setup” menu

5 To start the measurement, use the cursor keys to select “Start” and press ENTER.

The measurement will start in 10 seconds. Press ENTER to start the measurement immediately.

The following screen appears on the TV when the measurement finishes.

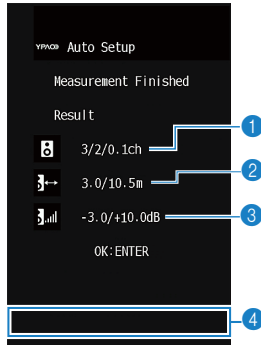

- 1 The number of speakers (front side/rear side/subwoofer)
- 2 Speaker distance (nearest/farthest)
- 3 Adjustment range of speaker output level
- 4 Warning message (if available)

Note

- To stop the measurement temporarily, press RETURN.
- If any error message (such as E-1) or warning message (such as W-1) appears, see the following:
 - “Error messages from YPAO” (p.35)
 - “Warning messages from YPAO” (p.36)
- A speaker with a problem is indicated by blinking of the speaker indicators in the front display.
- If multiple warnings are given (when operating with the front display), use the cursor keys to check the other warning messages.

6 Confirm the results displayed on the screen and press ENTER.

7 Use the cursor keys to select “SAVE” and press ENTER.

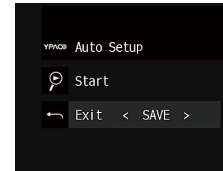

The adjusted speaker settings are applied.

Note

To finish the measurement without applying the result, select “CANCEL”.

8 Disconnect the YPAO microphone from the unit.

This completes optimization of the speaker settings.

Notice

- The YPAO microphone is sensitive to heat, so should not be placed anywhere it could be exposed to direct sunlight or high temperatures (such as on top of AV equipment).

Error messages from YPAO

If any error message is displayed during the measurement, resolve the problem and perform YPAO again.

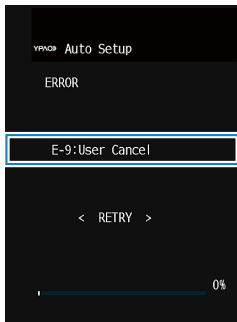

Error message

TV screen



Front display

Error message	Cause	Remedy
E-1:No Front SP (E-1:NO FRNT SP)	Front speakers are not detected.	Exit YPAO, turn off the unit, and then check the speaker connections.
E-2:No Sur. SP (E-2:NO SUR SP)	One of the surround speakers cannot be detected.	
E-5:Noisy (E-5:NOISY)	The noise is too loud.	Keep the room quiet and retry YPAO. If you select "PROCEED", YPAO takes the measurement again and ignores any noise detected.
E-7:No MIC (E-7:NO MIC)	The YPAO microphone has been removed.	Connect the YPAO microphone to the YPAO MIC jack firmly and retry YPAO.
E-8:No Signal (E-8:NO SIGNAL)	The YPAO microphone cannot detect test tones.	Connect the YPAO microphone to the YPAO MIC jack firmly and retry YPAO. If this error occurs repeatedly, contact the nearest authorized Yamaha dealer or service center.
E-9:User Cancel (E-9:CANCEL)	The measurement has been canceled.	Retry or exit YPAO as necessary.
E-10:Internal Err. (E-10:INTERNAL)	An internal error has occurred.	Exit YPAO, and turn off and on the unit. If this error occurs repeatedly, contact the nearest authorized Yamaha dealer or service center.

Note

- Text in parentheses denotes indicators on the front display.
- To exit the YPAO measurement for resolving the problem, use the cursor keys to select "EXIT" and press ENTER.
- For the error messages E-5 and E-9 only, you can proceed with the current YPAO measurement. Press ENTER, and then use the cursor keys to select "PROCEED" and press ENTER.
- To retry the YPAO measurement from beginning, press ENTER, and then use the cursor keys to select "RETRY" and press ENTER.

Warning messages from YPAO

If a warning message is displayed after the measurement, you can still apply the measurement results by following on-screen instructions.

However, we recommend you perform YPAO again in order to use the unit with the optimal speaker settings.

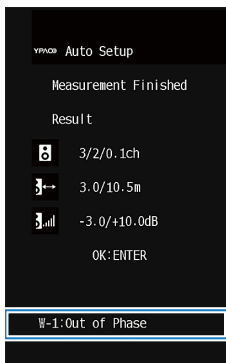

Warning message

TV screen

Problem speaker (blinks)



Front display

Warning message	Cause	Remedy
W-1: Out of Phase (W-1:PHASE)	A speaker cable may be connected with the reverse polarity (+/-).	<p>Check the cable connections (+/-) of the problem speaker.</p> <p>If the speaker is connected incorrectly: Turn off the unit, reconnect the speaker cable.</p> <p>If the speaker is connected correctly: Depending on the type of speakers or room environment, this message may appear even if the speakers are connected correctly. In this case, you can ignore the message.</p>
W-2: Over Distance (W-2:DISTANCE)	A speaker is placed more than 24 m (80 ft) from the listening position.	Exit YPAO, turn off the unit, and place the problem speaker within 24 m (80 ft) of the listening position.
W-3: Level Error (W-3:LEVEL)	There are significant volume differences between the speakers.	Check the usage environment and cable connections (+/-) of each speaker, and the volume of the subwoofer. If there is any problem, exit YPAO, turn off the unit, and then reconnect speaker cable or correct the speaker positions. We recommend using the same speakers or speakers with specifications that are as similar as possible.

Note

Text in parentheses denotes indicators on the front display.

9 Setting MusicCast

What is MusicCast

MusicCast is a brand new wireless musical solution from Yamaha, allowing you to share music among all of your rooms with a variety of devices. You can enjoy music from your smartphone, PC, NAS drive and music streaming service anywhere in your house with one easy-to-use application. For more details and a lineup of MusicCast compatible products, refer to the following site:

<http://www.yamaha.com/musiccast/>

- Seamlessly control all MusicCast compatible devices with the dedicated application “MusicCast CONTROLLER”.
- Link a MusicCast compatible device to another device in a different room and play them back simultaneously.
- Play back music from music streaming services. (The compatible music streaming services may differ depending on your region and product).
- Configure wireless network settings of MusicCast compatible devices.

Using MusicCast CONTROLLER

To use the network features on the MusicCast compatible device, you need the dedicated application “MusicCast CONTROLLER” for the operation. Search for the free application “MusicCast CONTROLLER” on the App Store or Google Play and install it to your device.

Adding the unit to the MusicCast network

Perform the following procedure to add the unit to the MusicCast network. You can also configure the unit’s wireless network settings at once.

Note

The SSID and security key for your network will be needed.

- 1 Tap the “MusicCast CONTROLLER” application icon on your mobile device and tap “Setup”.**

Note

If you have already connected other MusicCast compatible devices to the network, tap “Settings” and then “Add New Device”.

- 2 Operate the “MusicCast CONTROLLER” application following the on screen instructions, then hold down CONNECT on the front panel of the unit for 5 seconds.**

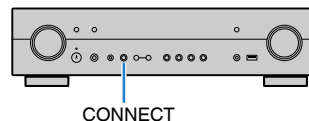

- 3 Operate the “MusicCast CONTROLLER” application following the onscreen instructions to set up the network.**

This completes adding the unit to the MusicCast network and the network settings.

Note

- AirPlay and DSD audio cannot be delivered.
- When the direct playback mode is enabled, input sources other than the network sources, Bluetooth and USB cannot be delivered.
- If you configure the unit’s wireless settings with this method, the wireless LAN indicator of the front display lights up when the unit is connecting to a network (even if a wired connection is used).
- You can interlock the power of MusicCast devices with the power of the unit (the MusicCast master). For details on the settings, see the following:
 - “Setting the power interlock from the unit to MusicCast compatible devices” (p.110)

ENJOYING SOUND

Enjoying sound field effects

Select your favorite sound mode

The unit is equipped with a variety of sound programs and surround decoders that allow you to enjoy playback sources with your favorite sound mode (such as sound field effect or stereo playback).

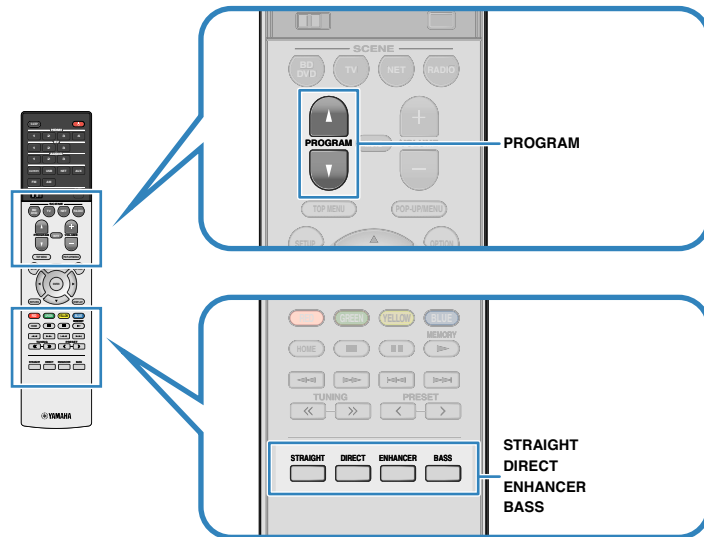

Note

- The sound mode can be applied separately to each input source.
- You can check which speakers are currently outputting sound by looking at the speaker indicators on the front display.
- You can assign the unit's functions of sound mode to the RED/GREEN/YELLOW/BLUE keys of the remote control. For details, see the following:
 - "Setting the unit's functions for the RED/GREEN/YELLOW/BLUE keys of the remote control" (p.106)

Enjoying 3D sound fields (CINEMA DSP 3D)

CINEMA DSP 3D

The unit is equipped with a variety of sound programs that utilize Yamaha's original DSP technology (CINEMA DSP 3D). It allows you to easily create sound fields like actual movie theaters or concert halls in your room and enjoy natural three-dimensional sound fields.

Sound program category

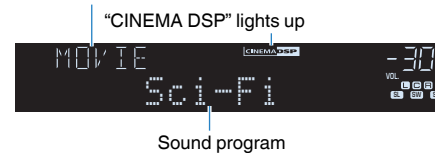

Note

- You can adjust the sound field effect level. For details, see the following:
 - "Adjusting the sound field effect level" (p.78)
- The sound mode can be applied separately to each input source.

Enjoying sound field effects optimized for the type of content

The unit is equipped with a variety of sound programs.

You can enjoy playback sources with your favorite sound mode, such as with a sound field effect added or with stereo playback.

- We recommend a sound program in the “MOVIE” category to enjoy video content.
- We recommend a sound program in the “MUSIC” category to enjoy music content.
- We recommend a sound program in the “STEREO” category to enjoy stereo playback.

For details on the sound programs, see the following:

- “Selecting sound programs” (p.76)

Note

You can select a sound program by pressing PROGRAM.

Enjoying sound field effects without surround speakers (Virtual CINEMA DSP)

If you select one of the sound programs (except 2ch Stereo and 5ch Stereo) when no surround speakers are connected, the unit automatically creates the surround sound field using the front speakers.

Note

When Virtual CINEMA DSP is working, “VIRTUAL” lights up on the front display.

Enjoying surround sound with 5 speakers placed in front (Virtual CINEMA FRONT)

You can enjoy the surround sound even when the surround speakers are placed in front.

When “Virtual CINEMA FRONT” in the “Setup” menu is set to “On”, the unit creates the virtual surround speakers in the rear side to allow you to enjoy multichannel surround sound with the 5 speakers placed in the front.

Note

- For details on the settings, see the following:
 - “Setting the use of Virtual CINEMA FRONT” (p.93)
- When Virtual CINEMA FRONT is working, “VIRTUAL” lights up on the front display.

Enjoying surround sound with headphones (SILENT CINEMA)

SILENT™ CINEMA

You can enjoy surround or sound field effects, like a multichannel speaker system, with stereo headphones by connecting the headphones to the PHONES jack and selecting a sound program or a surround decoder.

Enjoying unprocessed playback

Enjoying original sound (straight decode)

When STRAIGHT is pressed and the straight decode mode is enabled, the unit produces stereo sound from the front speakers for 2-channel sources such as CDs, and produces unprocessed multichannel sounds for multichannel sources.



Each time you press the key, the straight decode mode is enabled or disabled.

Enjoying multichannel playback without sound field effects (surround decoder)

Press PROGRAM to select "Sur.Decode". The previously selected surround decoder is selected. The surround decoder enables multichannel playback from 2-channel sources without sound field effects.

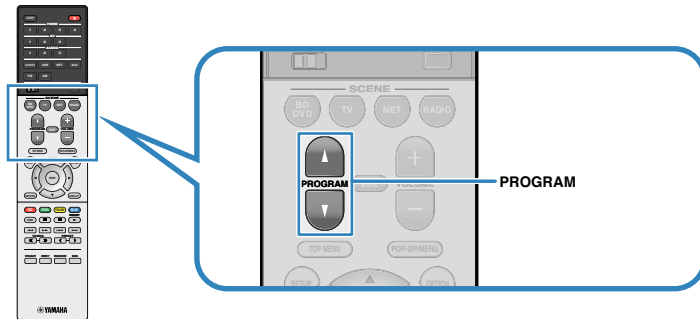

"SUR. DECODE" appears



Note

- You cannot change the previously selected surround decoder by pressing PROGRAM. To change it, use "Sur.Decode" in the "Option" menu. For details, see the following:
 - "Selecting the surround decoder used in the program" (p.78)
- For details on each decoder, see the following:
 - "Glossary of audio decoding format" (p.138)
- You can adjust the surround decoder parameters in "DSP Parameter" in the "Setup" menu. For details, see the following:
 - "Setting the broadening effect of the front sound field" (p.99)
 - "Adjusting the broadening effect of the center sound field" (p.99)
 - "Adjusting the difference in level between the front and surround sound fields" (p.99)
 - "Adjusting the center localization (broadening effect) of the front sound field" (p.99)

Enjoying pure high fidelity sound (direct playback)

When DIRECT is pressed and the direct playback mode is enabled, the unit plays back the selected source with the least circuitry. It allows you to enjoy Hi-Fi sound quality.



Each time you press the key, the direct playback mode is enabled or disabled.

Note

- When the direct playback mode is enabled, the following functions are not available.
 - Selecting sound programs
 - Using the multi-zone function
 - Adjusting the tone control
 - Operating the on-screen “Setup” and “Option” menus
 - Viewing information on the front display (when not in operation)
- When the direct playback mode is enabled, the front display may become dark.

Enjoying enhanced bass sound

Enhancing the bass (Extra Bass)

Press BASS to enable Extra Bass and enjoy enhanced bass sound, regardless of the size of the front speakers and the presence or absence of a subwoofer.

Each time you press the key, Extra Bass is enabled or disabled.

Note

You can also use “Extra Bass” in the “Setup” menu to enable/disable Extra Bass. For details, see the following:

- “Setting the use of Extra Bass” (p.93)

Enjoying enhanced compressed music

Playing back digitally compressed formats with enriched sound (Compressed Music Enhancer)

compressed music ENHANCER

Press ENHANCER to enable Compressed Music Enhancer and add depth and breadth to the sound, allowing you to enjoy a dynamic sound close to the original sound before it was compressed. This function can be used along with any other sound modes.

"ENHANCER" lights up



Each time you press the key, Compressed Music Enhancer is enabled or disabled.

Note

- Compressed Music Enhancer does not work on the following audio sources.
 - Signals whose sampling frequency is over 48 kHz
 - DSD audio
- You can also use "Enhancer" in the "Option" menu to enable/disable Compressed Music Enhancer. For details, see the following:
 - "Setting Compressed Music Enhancer" (p.79)

Enjoying music in multiple rooms

Playing back music in multiple rooms

The multi-zone function allows you to play back different input sources in the room where the unit is installed (Main zone) and in another room (Zone2).

For example, while you are watching TV in the living room (Main zone), another person can listen to radio in the study room (Zone2).

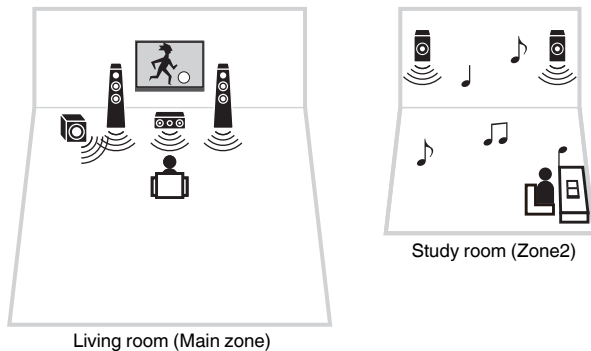

Note

- Zone2 can only output analog audio sources (AV 3, AUDIO 2-3, TUNER and AUX).
- The party mode allows you to play back the same audio output in Zone2 as in Main zone. For details on the party mode, see the following:
 - “Enjoying the same source in multiple rooms (party mode)” (p.44)

Connecting Zone2 speakers

Connect the device that will be used in Zone2 to the unit.

Notice

- Remove the unit's power cable from the AC wall outlet before connecting speakers.
- Ensure that the bare wires of the speaker cable do not touch one another or come into contact with the unit's metal parts. Doing so may damage the unit or the speakers. If the speaker cables short circuit, “Check SP Wires” will appear on the front display when the unit is turned on.

Connect the speakers placed in Zone2 to the unit with speaker cables.

To utilize the SURROUND/ZONE 2/BI-AMP terminals for Zone2 speakers, set “Power Amp Assign” in the “Setup” menu to “Zone 2” after connecting the power cable to an AC wall outlet. For details, see the following:

- “Setting your speaker system” (p.90)

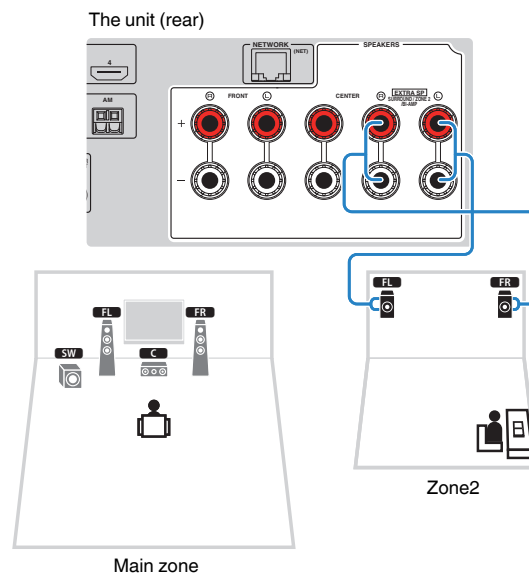

Note

The following speakers cannot be connected simultaneously.

- Surround speakers
- Zone2 speakers
- Bi-amp speakers

Controlling Zone2

Basic procedure for playing back music in Zone2 is as follows.

1 Set MAIN/ZONE 2 to “ZONE 2”.

2 Press (receiver power).

Each time you press the key, Zone2 output is enabled or disabled. When Zone2 output is enabled, “ZONE2” lights up in the front display.

3 Use the input selection keys to select an input source.

Note

- Zone2 can only output analog audio sources (AV 3, AUDIO 2-3, TUNER and AUX).
- An input source for Zone2 can only be selected using the input selection keys on the remote control.

4 Start playback on the external device or select a radio station.

Note

- The on-screen operations are not available for Zone2. Use the front display to control Zone2.
- Zone2 output is disabled when DIRECT is pressed to enable direct playback mode.
- Press SCENE to select the input source using the SCENE function. For details on the SCENE function, see the following:
 - “Selecting the input source and favorite settings with one touch (SCENE)” (p.70)
- To set the sleep timer (120 min, 90 min, 60 min, 30 min, off), press SLEEP repeatedly. The Zone2 output will be disabled after a specified period of time.
- To adjust the Zone2 volume, press VOLUME or MUTE.

Enjoying the same source in multiple rooms (party mode)

Press PARTY, and then the party mode allows you to play back in Zone2 the same music that is being played back in the main zone. During the party mode, stereo playback is automatically selected for all zones. Utilize this function when you want to use main zone music as background music for a house party.

Each time you press the key, the party mode is turned on or off. When the party mode is turned on, “PARTY” lights up in the front display.

Note

- If the party mode does not work on Zone2, set “Party Mode Set” in the “Setup” menu to “Enable”. For details, see the following:
 - “Setting the use of switching to the party mode” (p.106)
- The party mode is not available when the unit is in direct playback mode.

PLAYBACK

Basic playback procedure

Basic procedure for playing back video and music

Basic procedure for playing back video and music is as follows.

- 1 Turn on the external devices (such as a TV or BD/DVD player) connected to the unit.
- 2 Use the input selection keys to select an input source.

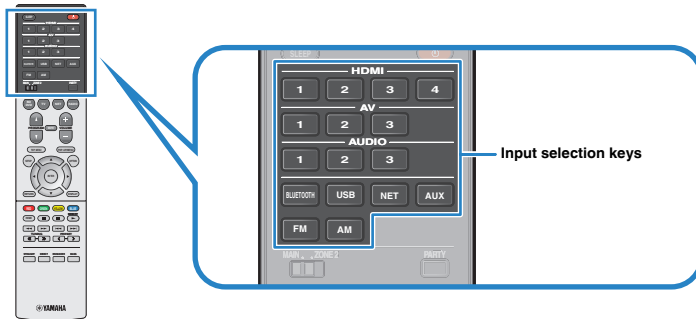

- 3 Start playback on the external device or select a radio station.
- 4 Press **VOLUME** to adjust the volume.

Note

- To mute the audio output, press MUTE. Press MUTE again to unmute.
- Refer to the instruction manual for the external device.

Switching information on the front display

Press INFO on the front panel to select between the various display items on the front display, as shown in the following table.



Item

About 3 seconds after a display item is selected, its corresponding information appears.



Information

Currently input source	Displayed item
HDMI	
AV	Input (input source name), DSP Program (sound mode name), Audio Decoder (decoder name*)
AUX	
AUDIO	
Bluetooth	Song (song title), Artist (artist name), Album (album name), DSP Program (sound mode name), Audio Decoder (decoder name*)
USB	
SERVER	Song (song title), Artist (artist name), Album (album name), DSP Program (sound mode name), Audio Decoder (decoder name*), IP Address, Ethernet MAC, Wi-Fi MAC
AirPlay	
NET RADIO	Song (song title), Album (album name), Station (station name), DSP Program (sound mode name), Audio Decoder (decoder name*), IP Address, Ethernet MAC, Wi-Fi MAC
MusicCast Link	DSP Program (sound mode name), Audio Decoder (decoder name*), IP Address, Ethernet MAC, Wi-Fi MAC
	Frequency (frequency), DSP Program (sound mode name), Audio Decoder (decoder name*)
	(U.K. and Europe models only)
TUNER (FM/AM)	Radio Data System data is also available when the unit is tuned into a Radio Data System broadcasting station. For details, see the following: <ul style="list-style-type: none"> • "Displaying the Radio Data System information" (p.62)
	(U.K., Europe and Australia models only)
TUNER (DAB)	For details, see the following: <ul style="list-style-type: none"> • "Displaying the DAB information" (p.57)

* The name of the audio decoder currently activated is displayed. If no audio decoder is activated, "Decoder Off" appears.

Note

Available items vary depending on the selected input source. The displayed item can also be applied separately to each input group which is shown in the table and divided by ruled lines.

Item names and functions of the playback screen

The item names and functions of the playback screen, available when your TV is connected to the unit via HDMI, are as follows.

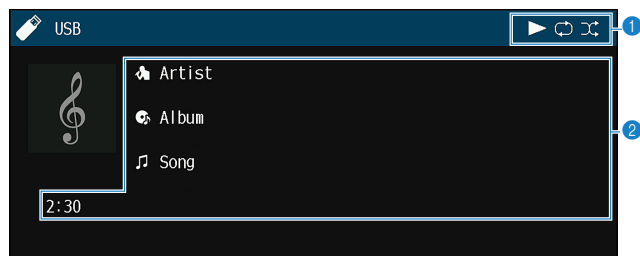

1 Status indicators

Display the current shuffle/repeat settings and playback status (such as play/pause).

2 Playback information

Displays the artist name, album name, song title, and elapsed time.

Use the following remote control keys to control playback.

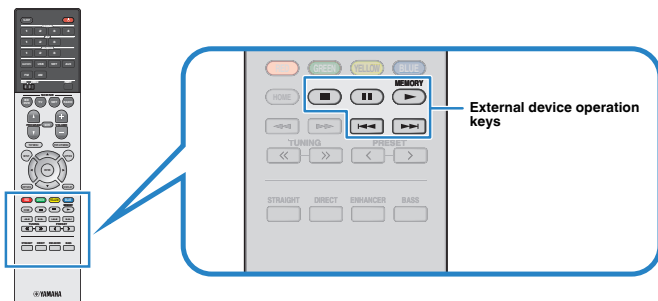

External device operation keys	Function
	Resumes playback from pause.
	Stops playback.
	Stops playback temporarily.
	Skips forward/backward.

Note

Displayed items vary depending on the content of playback.

Item names and functions of the browse screen

The item names and functions of the browse screen, available when your TV is connected to the unit via HDMI, are as follows. The browse screen appears when the next input source is selected.

- USB
- SERVER
- NET RADIO

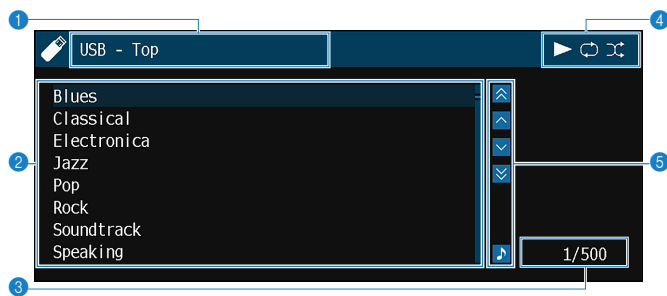

1 List name

2 Contents list

Displays the list of contents. Use the cursor keys to select an item and press ENTER to confirm the selection.

3 Item number/total

4 Status indicators

Display the current shuffle/repeat settings and playback status (such as play/pause).

5 Operation menu

Use the cursor keys to select an item. Press ENTER to confirm the selection.

Icon	Function
	Moves 10 pages backward.
	Moves to the previous page of the list.
	Moves to the next page of the list.
	Moves 10 pages forward.
	Moves to the playback screen.

Note

- Displayed items vary depending on the content of playback.
- A content selected by the cursor is displayed on the front display.

Listening to FM/AM radio (Except for U.K., Europe and Australia models)

Setting the frequency steps

(Asia, Taiwan, and Central and South America models only)

At the factory, the frequency step setting is set to 50 kHz for FM and 9 kHz for AM. Depending on your country or region, set the frequency steps to 100 kHz for FM and 10 kHz for AM.

- 1 Set the unit to standby mode.**
- 2 When holding down STRAIGHT on the front panel, press  (power).**

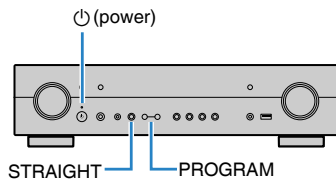

- 3 Press PROGRAM to select “TU”.**

TU FM50/AM9

- 4 Press STRAIGHT to select “FM100/AM10”.**

- 5 Press  (power) to set the unit to standby mode and turn it on again.**

This completes the settings.

Selecting a frequency for reception

You can tune into a radio station by specifying its frequency.

Note

The radio frequencies differ depending on the country or region where the unit is being used. The explanation of this section uses a display with frequencies used in U.K. and Europe models.

1 Press FM or AM to select “TUNER” as the input source.

“TUNER” is selected as the input source and the frequency currently selected is displayed on the front display.



2 Press TUNING to set a frequency.

Hold down the key for about a second to search stations automatically.

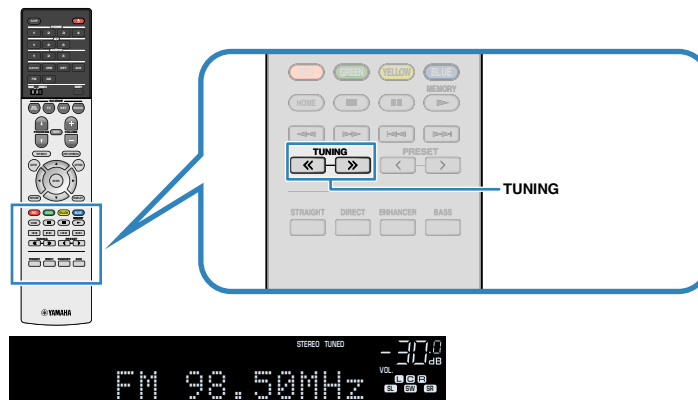

On the front display, “TUNED” lights up when the unit is receiving an FM/AM radio station signal.

“STEREO” lights up when the unit is receiving a stereo FM radio signal.

Note

You can watch videos input from external devices while listening to radio. For details, see the following:

- “Selecting a video source to be output with the selected audio source” (p.81)

Selecting a preset station

Tune into a registered radio station by selecting its preset number.

1 Press FM or AM to select “TUNER” as the input source.

“TUNER” is selected as the input source and the frequency currently selected is displayed on the front display.

2 Press PRESET to select the desired radio station.

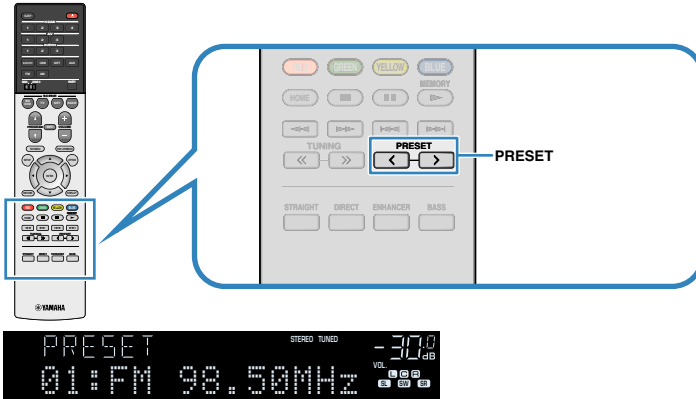

Note

“No Presets” appears on the front display when no radio stations are registered.

Registering radio stations automatically (Auto Preset)

Automatically register FM radio stations with strong signals.

Note

- You can register up to 40 radio stations as presets.
- To register AM radio stations, see the following:
 - “Registering a radio station manually” (p.52)

1 Press FM or AM to select “TUNER” as the input source.

“TUNER” is selected as the input source and the frequency currently selected is displayed on the front display.

2 Press OPTION.

3 Use the cursor keys to select “Preset” and press ENTER.



The preset number from which to start the registration is displayed on the front display.

Note

To specify the preset number from which to start the registration, press cursor keys or PRESET to select a preset number.

4 To start the Auto Preset process, press ENTER.

“SEARCH” appears during Auto Preset



Preset number from which to start the registration

The Auto Preset process starts and “SEARCH” appears during Auto Preset.

Note

To cancel the Auto Preset process, press RETURN.

When the Auto Preset process finishes, “FINISH” appears on the front display and the “Option” menu closes automatically.



Registering a radio station manually

Select a radio station manually and register it to a preset number.

Note

You can register up to 40 radio stations as presets.

1 Press FM or AM to select “TUNER” as the input source.

“TUNER” is selected as the input source and the frequency currently selected is displayed on the front display.

2 Press TUNING to set a frequency.

Hold down the key for about a second to search stations automatically.

3 Hold down MEMORY for a few seconds.

The first time that you do register a station, the selected radio station will be registered to the preset number “01”. Thereafter, each radio station you select will be registered to the next empty (unused) preset number after the most recently registered number.

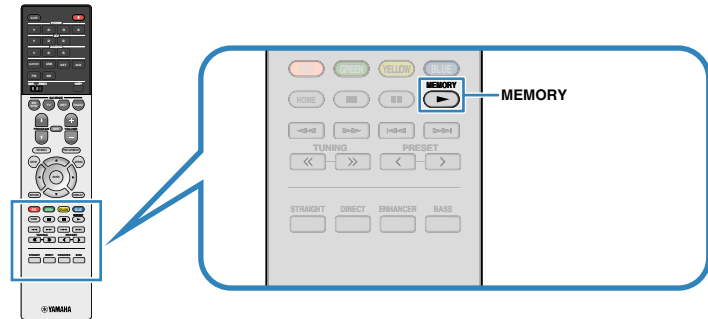

Preset number

Note

To select a preset number for registering, press MEMORY once after tuning into the desired radio station, press PRESET to select a preset number, and then press MEMORY again.



“Empty” (not in use) or the frequency currently registered

This completes the registers.

Clearing preset stations

Clear radio stations registered to the preset numbers.

1 Press FM or AM to select “TUNER” as the input source.

“TUNER” is selected as the input source and the frequency currently selected is displayed on the front display.

2 Press OPTION.

3 Use the cursor keys to select “Preset” and press ENTER.



4 Use the cursor keys to select “CLEAR”.

5 Use the cursor keys to select a preset station to be cleared and press ENTER.



Preset station to be cleared

If the preset station is cleared, “Cleared” appears and then the next in-use preset number is displayed.



6 Repeat step 5 until all desired preset stations are cleared.

7 Press OPTION.

This completes the clearing preset stations.

Listening to DAB radio (U.K., Europe and Australia models)

Preparing the DAB tuning

DAB (Digital Audio Broadcasting) uses digital signals for clearer sound and more stable reception compared to analog signals. The unit can also receive DAB+ (an upgraded version of DAB) that allows for more stations using MPEG-4 HE-AAC v2 audio codec, which has a more efficient transmission method.

Note

- The unit supports Band III (174 to 240 MHz) only.
- Be sure to check the DAB coverage in your area in that not all areas are currently being covered. For a list of nationwide DAB statuses and worldwide DAB frequencies, check WorldDMB online at <http://www.worlddab.org/>.
- For details on the antenna connection, see the following:
 - “Connecting the DAB/FM antenna (U.K., Europe and Australia models)” (p.28)

Before tuning into DAB radio stations, perform an initial scan.

1 Press DAB to select the DAB band.

The following message appears on the front display if you have not performed an initial scan yet.



2 Press ENTER to start an initial scan.



When the initial scan finishes, the unit automatically tunes into the first DAB radio station as stored in station order.



Note

- If no DAB radio stations are found by an initial scan, the message in Step 1 appears again. Press ENTER to start an initial scan again.
- You can check reception strength of each DAB channel label. For details, see the following:
 - “Checking reception strength of each DAB channel label” (p.58)
- To perform an initial scan again after some DAB radio stations are stored, select “Init Scan” in the “Option” menu. If you perform an initial scan again, the DAB radio stations currently registered to the preset numbers will be cleared. For details, see the following:
 - “Performing an initial scan for DAB radio reception” (p.84)

Selecting a DAB radio station for reception

You can select a DAB radio station from the stations stored by the initial scan.

1 Press DAB to select the DAB band.

"TUNER" is selected as the input source and then the DAB radio station currently selected is displayed on the front display.

2 Press TUNING to select a DAB radio station.

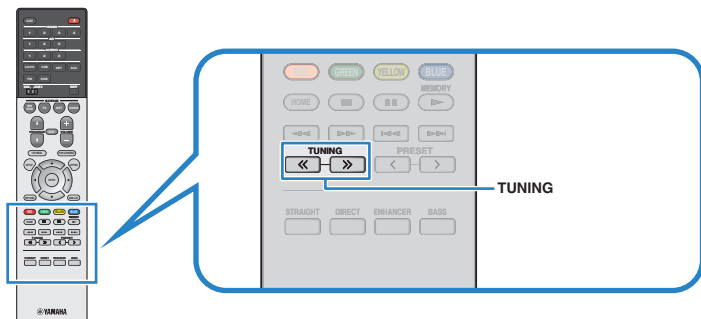

(U.K., Europe and Australia models)



Note

- "Off Air" appears when the selected DAB radio station is currently not available.
- When the unit is receiving a secondary station, "2" appears next to "DAB".

Secondary station



- You can watch videos input from external devices while listening to radio. For details, see the following:
 - "Selecting a video source to be output with the selected audio source" (p.81)

Selecting a preset DAB radio station

Tune into a registered DAB radio station by selecting its preset number.

1 Press DAB to select "TUNER" as the input source.

"TUNER" is selected as the input source and then the DAB radio station currently selected is displayed on the front display.

2 Press PRESET to select the desired DAB radio station.

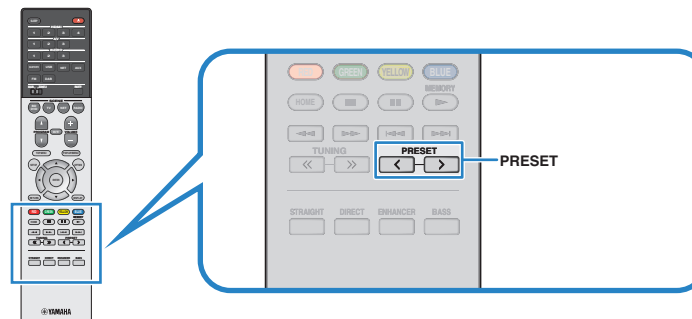

(U.K., Europe and Australia models)



Note

"No Presets" appears when no DAB radio stations are registered.

Registering a DAB radio station as presets

Select a DAB radio station and register it to a preset number.

Note

You can register up to 40 radio stations as presets.

1 Press DAB to select the DAB band.

“TUNER” is selected as the input source and then the DAB radio station currently selected is displayed on the front display.

2 Press TUNING to select a DAB radio station.

3 Hold down MEMORY for a few seconds.

The first time that you do register a station, the selected radio station will be registered to the preset number “01”. Thereafter, each radio station you select will be registered to the next empty (unused) preset number after the most recently registered number.

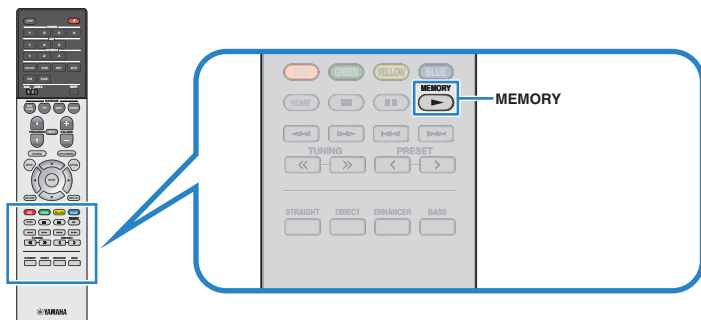

(U.K., Europe and Australia models)



Preset number

Note

To select a preset number for registering, press MEMORY once after tuning into the desired radio station, press PRESET to select a preset number, and then press MEMORY again.



“Empty” (not in use) or “Overwrite?” (in use)

This completes the registers.

Clearing preset DAB radio stations

Clear DAB radio stations registered to the preset numbers.

- 1 Press DAB to select “TUNER” as the input source.**
“TUNER” is selected as the input source and then the DAB radio station currently selected is displayed on the front display.

- 2 Press OPTION.**

- 3 Use the cursor keys to select “Preset” and press ENTER.**



- 4 Use the cursor keys to select a preset station to be cleared and press ENTER.**



Preset station to be cleared

If the preset station is cleared, “Cleared” appears and then the next in-use preset number is displayed.



- 5 Repeat step 4 until all desired preset stations are cleared.**

- 6 Press OPTION.**

This completes the clearing preset stations.

Displaying the DAB information

The unit can receive various types of DAB information when it is tuned into a DAB radio station.

- 1 Tune into the desired DAB radio station.**
- 2 Press INFO on the front panel to select between the various display items.**



Item name

About 3 seconds after a display item is selected, its corresponding information appears on the front display.



Information

Service Label	Station name
DLS (Dynamic Label Segment)	Information on the current station
Ensemble Label	Ensemble name
Program Type	Station genre
Date And Time	Current date and time
Audio Mode	Audio mode (monaural/stereo) and bit rate
CH Label/Freq.	Channel label and frequency
Signal Quality	Signal reception quality (0 [none] to 100 [best])
DSP Program	Sound mode name
Audio Decoder	Decoder name

Note

Some information may not be available depending on the selected DAB radio station.

Checking reception strength of each DAB channel label

■ Checking reception strength of each DAB channel label

You can check reception strength of each DAB channel label (0 [none] to 100 [best]).

1 Press DAB to select “TUNER” as the input source.

“TUNER” is selected as the input source and then the DAB radio station currently selected is displayed on the front display.

2 Press OPTION.

3 Use the cursor keys to select “Tune AID” and press ENTER.

4 Use the cursor keys to select the desired DAB channel label.



DAB channel label

Reception strength

5 Press OPTION.

This completes the checking.

■ DAB frequency information

The unit supports Band III (174 to 240 MHz) only.

Frequency	Channel label
174.928 MHz	5A
176.640 MHz	5B
178.352 MHz	5C
180.064 MHz	5D
181.936 MHz	6A
183.648 MHz	6B
185.360 MHz	6C
187.072 MHz	6D
188.928 MHz	7A
190.640 MHz	7B
192.352 MHz	7C
194.064 MHz	7D
195.936 MHz	8A
197.648 MHz	8B
199.360 MHz	8C
201.072 MHz	8D
202.928 MHz	9A
204.640 MHz	9B
206.352 MHz	9C
208.064 MHz	9D
209.936 MHz	10A
211.648 MHz	10B
213.360 MHz	10C
215.072 MHz	10D
216.928 MHz	11A
218.640 MHz	11B
220.352 MHz	11C
222.064 MHz	11D
223.936 MHz	12A
225.648 MHz	12B
227.360 MHz	12C
229.072 MHz	12D
230.784 MHz	13A

Frequency	Channel label
232.496 MHz	13B
234.208 MHz	13C
235.776 MHz	13D
237.488 MHz	13E
239.200 MHz	13F

Listening to FM radio (U.K., Europe and Australia models)

Selecting a frequency for FM radio reception

You can tune into an FM radio station by specifying its frequency.

Note

The radio frequencies differ depending on the country or region where the unit is being used. The explanation of this section uses a display with frequencies used in U.K. and Europe models.

1 Press FM to select the FM band.

“TUNER” is selected as the input source and the frequency currently selected is displayed on the front display.



2 Press TUNING to set a frequency.

Hold down the key for about a second to search stations automatically.

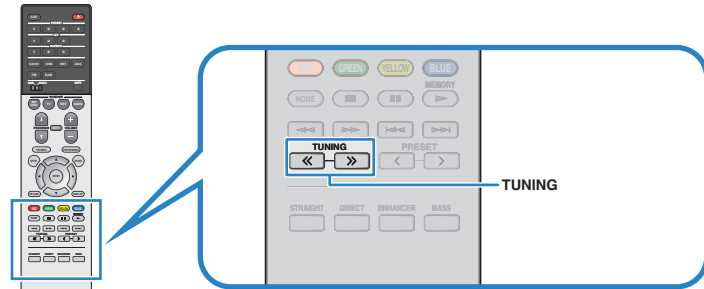

(U.K., Europe and Australia models)



On the front display, “TUNED” lights up when the unit is receiving an FM radio station signal.

“STEREO” lights up when the unit is receiving a stereo FM radio signal.

Note

You can watch videos input from external devices while listening to radio. For details, see the following:

- “Selecting a video source to be output with the selected audio source” (p.81)

Selecting a preset FM radio station

Tune into a registered FM radio station by selecting its preset number.

1 Press FM to select “TUNER” as the input source.

“TUNER” is selected as the input source and the frequency currently selected is displayed on the front display.

2 Press PRESET to select the desired FM radio station.

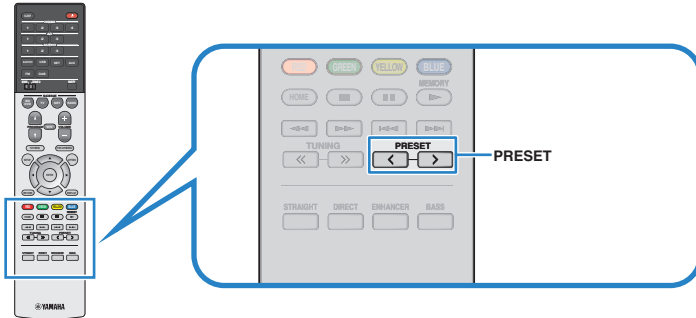

(U.K., Europe and Australia models)



Note

“No Presets” appears on the front display when no radio stations are registered.

Registering FM radio stations automatically (Auto Preset)

Automatically register FM radio stations with strong signals.

Note

- You can register up to 40 radio stations as presets.
- (U.K. and Europe models only)
• Only Radio Data System broadcasting stations are registered automatically by the Auto Preset function.

1 Press FM to select “TUNER” as the input source.

“TUNER” is selected as the input source and the frequency currently selected is displayed on the front display.

2 Press OPTION.

3 Use the cursor keys to select “Preset” and press ENTER.



The preset number from which to start the registration is displayed on the front display.

Note

To specify the preset number from which to start the registration, press cursor keys or PRESET to select a preset number.

4 To start the Auto Preset process, press ENTER.

“SEARCH” appears during Auto Preset



Preset number from which to start the registration

The Auto Preset process starts and “SEARCH” appears during Auto Preset.

Note

To cancel the Auto Preset process, press RETURN.

When the Auto Preset process finishes, “FINISH” appears on the front display and the “Option” menu closes automatically.



Registering an FM radio station manually

Select an FM radio station manually and register it to a preset number.

Note

You can register up to 40 radio stations as presets.

1 Press FM to select “TUNER” as the input source.

“TUNER” is selected as the input source and the frequency currently selected is displayed on the front display.

2 Press TUNING to set a frequency.

Hold down the key for about a second to search stations automatically.

3 Hold down MEMORY for a few seconds.

The first time that you do register an FM radio station, the selected radio station will be registered to the preset number “01”. Thereafter, each radio station you select will be registered to the next empty (unused) preset number after the most recently registered number.

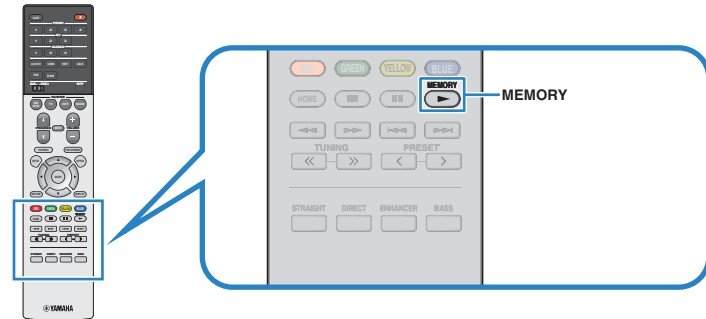

(U.K., Europe and Australia models)



Preset number

Note

To select a preset number for registering, press MEMORY once after tuning into the desired radio station, press PRESET to select a preset number, and then press MEMORY again.



“Empty” (not in use) or the frequency currently registered

This completes the registers.

Clearing preset FM radio stations

Clear FM radio stations registered to the preset numbers.

1 Press FM to select “TUNER” as the input source.

“TUNER” is selected as the input source and the frequency currently selected is displayed on the front display.

2 Press OPTION.

3 Use the cursor keys to select “Preset” and press ENTER.



4 Use the cursor keys to select “CLEAR”.

5 Use the cursor keys to select a preset station to be cleared and press ENTER.



Preset station to be cleared

If the preset station is cleared, “Cleared” appears and then the next in-use preset number is displayed.



6 Repeat step 5 until all desired preset stations are cleared.

7 Press OPTION.

This completes the clearing preset stations.

Displaying the Radio Data System information

(U.K. and Europe models only)

Radio Data System is a data transmission system used by FM stations in many countries. The unit can receive various types of Radio Data System data, such as “Program Service”, “Program Type”, “Radio Text” and “Clock Time”, when it is tuned into a Radio Data System broadcasting station.

1 Tune into the desired Radio Data System broadcasting station.

Note

We recommend using “Auto Preset” to tune into the Radio Data System broadcasting stations. For details, see the following:

- “Registering FM radio stations automatically (Auto Preset)” (p.60)

2 Press INFO on the front panel to select between the various display items.



Item name

About 3 seconds after a display item is selected, its corresponding information appears on the front display.



Information

Program Service	Program service name
Program Type	Current program type
Radio Text	Information on the current program
Clock Time	Current time
DSP Program	Sound mode name
Audio Decoder	Decoder name
Frequency	Frequency

Note

“Program Service”, “Program Type”, “Radio Text”, and “Clock Time” are not displayed if the radio station does not provide the Radio Data System service.

Playing back music stored on a Bluetooth® device

Playback Bluetooth® device music on the unit

You can play back music files stored on a Bluetooth device (such as smartphones) on the unit.

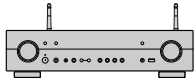

The unit



Bluetooth device
(such as smartphones)

Note

- Use the wireless antennas that are standing upright for connecting to a Bluetooth device wirelessly. For details, see the following:
 - “Preparing wireless antennas (wireless connection)” (p.30)
- To use the Bluetooth function, turn on the Bluetooth function of a Bluetooth device.
- To use the Bluetooth function, set “Bluetooth” in the “Setup” menu to “On”. For details, see the following:
 - “Setting the use of Bluetooth™” (p.111)
- For details on supported Bluetooth devices, see the following:
 - “Supported Bluetooth® devices” (p.140)

1 Press **BLUETOOTH** to select “Bluetooth” as the input source.

2 On the Bluetooth device, select the unit (network name of the unit).

A connection between the Bluetooth device and the unit will be made.

If the pass key is required, enter the number “0000”.

3 On the Bluetooth device, select a song and start playback.

The playback screen is displayed on the TV.

Note

- If the unit detects the Bluetooth device previously connected, the unit automatically connects to the Bluetooth device after Step 1. To establish another Bluetooth connection, first terminate the current Bluetooth connection.
- To terminate the Bluetooth connection, perform one of the following operations.
 - Perform the disconnect operation on the Bluetooth device.
 - Select an input source other than “Bluetooth” on the unit.
 - Select “Disconnect” in “Audio Receive” in the “Setup” menu.

Playing back music with AirPlay

Playback of iTunes/iPhone music contents with AirPlay

The AirPlay allows you to play back iTunes or iPhone/iPad/iPod touch music on the unit via network.

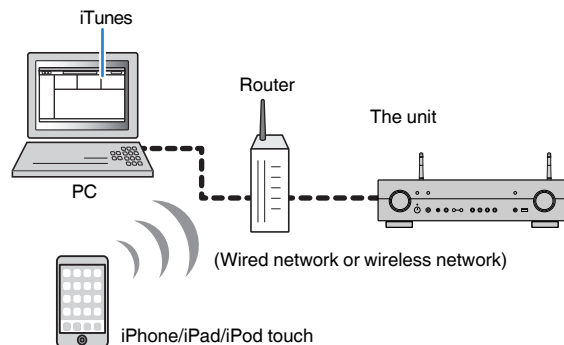

Note

For details on supported iPhone devices, see the following:

- "Supported AirPlay devices" (p.140)

1 Start iTunes on the PC or display the playback screen on the iPhone.

2 On the iTunes/iPhone, click (tap) the AirPlay icon and select the unit (network name of the unit) as the audio output device.

iOS 10 (example)

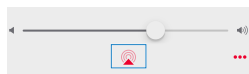

iTunes (example)



3 Select a song and start playback.

The unit automatically selects "AirPlay" as the input source and starts playback.

The playback screen is displayed on the TV.



Caution

- When you use iTunes/iPhone controls to adjust volume, the volume may be unexpectedly loud. This could result in damage to the unit or speakers. If the volume suddenly increases during playback, stop playback on the iTunes/iPhone immediately. We recommend volume controls from iTunes/iPhone within the limited range by setting "Volume Interlock" in the "Option" menu.

Note

- You can turn on the unit automatically when starting playback on iTunes or iPhone. For details on the settings, see the following:
 - "Setting the use of the Network Standby function" (p.109)
- You can edit the network name (the unit's name on the network) displayed on iTunes/iPhone. For details, see the following:
 - "Setting the network name of the unit" (p.110)
- You can adjust the unit's volume from the iTunes/iPhone during playback. To disable volume controls from iTunes/iPhone, see the following:
 - "Enabling volume control via AirPlay" (p.83)

Playing back music stored on a USB storage device

Playback of USB storage device contents

You can play back music files stored on a USB storage device on the unit.

Note

For details on playable USB devices and USB file formats, see the following:

- “Supported USB devices” (p.140)
- “Supported file formats” (p.141)

1 Connect the USB storage device to the USB jack.

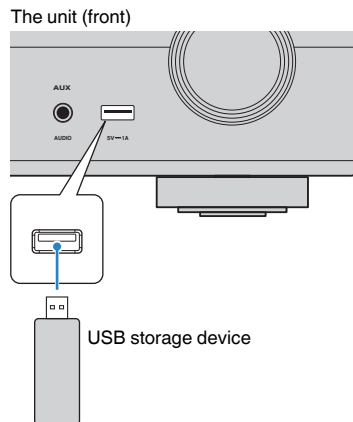

Note

- If the USB storage device contains many files, it may take time to load them. In this case, “Loading...” appears on the front display.
- Stop playback of the USB storage device before disconnecting it from the USB jack.
- Connect a USB storage device directly to the USB jack of the unit. Do not use extension cables.
- The unit cannot charge USB devices while it is in standby mode.

2 Press USB to select “USB” as the input source.

The browse screen is displayed on the TV.

Note

If playback is ongoing, the playback screen is displayed.

3 Use the cursor keys to select an item and press ENTER.

If a song is selected, playback starts and the playback screen is displayed.

Note

- To return to the top level while on the browse screen, hold down RETURN.
- To switch the screen mode browse/playback/off, press DISPLAY.

Note

- You can configure the shuffle/repeat settings for playback of contents. For details, see the following:
 - “Configuring the shuffle setting” (p.83)
 - “Configuring the repeat setting” (p.83)
- You can register contents as shortcuts and access them directly. For details, see the following:
 - “Registering a favorite content as shortcut” (p.72)

Playing back music stored on media servers (PCs/NAS)

Media sharing setup on media servers (PCs/NAS)

To play back music files stored on your media servers, first you need to configure the media sharing setting on each music server.

The setting procedure may vary depending on the media server. The following procedure is a setup example for Windows Media Player 12.

Note

- For a media server with software except Windows Media Player installed, refer to the instruction manual for the device or software and configure the media sharing settings.
- The setting procedure may vary depending on the view setting of Windows Media Player or the settings of PC.

- 1 Start Windows Media Player 12 on your PC.**
- 2 Select “Stream”, then “Turn on media streaming”.**
- 3 Click “Turn on media streaming”.**
- 4 Select “Allowed” from the drop-down list next to the unit’s model name.**
- 5 Click “OK” to exit.**

This completes the settings.

Note

For details on media sharing settings, refer to Windows Media Player help.

Playing back music stored on media servers (PCs/NAS)

You can play back music files stored on your media server on the unit.

Note

- You need to configure the media sharing setting on each music server in advance. For details, see the following:
 - “Media sharing setup on media servers (PCs/NAS)” (p.66)
- To use this function, the unit and your PC must be connected to the same router. You can check whether the network parameters (such as the IP address) are properly assigned to the unit. For details, see the following:
 - “Checking the network information of the unit” (p.107)
- The audio may be interrupted while using the wireless network connection. In this case, use the wired network connection.
- For details on playable file formats, see the following:
 - “Supported file formats” (p.141)

1 Press NET to select “SERVER” as the input source.

The browse screen is displayed on the TV.

Note

If playback of a music file selected from the unit is ongoing on your PC, the playback screen is displayed.

2 Use the cursor keys to select a music server and press ENTER.

3 Use the cursor keys to select an item and press ENTER.

If a song is selected, playback starts and the playback screen is displayed.

Note

- To return to the top level while on the browse screen, hold down RETURN.
- To switch the screen mode browse/playback/off, press DISPLAY.

Note

- You can configure the shuffle/repeat settings for playback of contents. For details, see the following:
 - “Configuring the shuffle setting” (p.83)
 - “Configuring the repeat setting” (p.83)
- You can also use the Digital Media Controller (DMC) to control playback. For details, see the following:
 - “Setting the use of a Digital Media Controller” (p.109)
- You can register contents as shortcuts and access them directly. For details, see the following:
 - “Registering a favorite content as shortcut” (p.72)

Selecting an Internet radio station

Select an Internet radio station and start playback.

Note

- To use this function, the unit must be connected to the Internet. You can check whether the network parameters (such as the IP address) are properly assigned to the unit. For details, see the following:
 - “Checking the network information of the unit” (p.107)
- You may not be able to receive some Internet radio stations.
- The unit uses the `airable.Radio` service. `airable` is a service of Tune In GmbH.
- This service may be discontinued without notice.
- Folder names are different depending on the language.

1 Press NET to select “NET RADIO” as the input source.

The browse screen is displayed on the TV.

2 Use the cursor keys to select an item and press ENTER.

If an Internet radio station is selected, playback starts and the playback screen is displayed.

Note

- To return to the top level while on the browse screen, hold down RETURN.
- To switch the screen mode browse/playback/off, press DISPLAY.

Registering favorite Internet radio stations

You can register the Internet radio station in playback at present to the “Favorites” folder.

1 While listening to Internet radio, press OPTION.

2 Use the cursor keys to select “Add to favorites” and press ENTER.

On the playback screen, the current station is added to the “Favorites” folder. On the browse screen, the station selected in the list is added to the “Favorites” folder.

When the registering process finishes, the “Option” menu closes automatically.

Note

- Radio stations registered to favorites are displayed with “★”.
- To remove a station that is registered to favorites, select the station and then select “Remove from favorites”.
- You can register Internet radio stations as shortcuts and access them directly. For details, see the following:
 - “Registering a favorite content as shortcut” (p.72)

Listening to a streaming service

You can listen to a streaming service with the MusicCast CONTROLLER on your mobile device. On the MusicCast CONTROLLER screen, select the room name that was specified for the unit, and then select the streaming service to be tuned into by its station name. For details, see the MusicCast CONTROLLER app.

Note

- Service is limited to certain areas.
- Services supported with the unit may not be available depending upon some regions where the unit is purchased.
- Service may change or be discontinued without notice.
- After registering the unit in the MusicCast CONTROLLER app, you can use the streaming service. For details, see the following:
 - “Adding the unit to the MusicCast network” (p.37)
- To use this function, the unit must be connected to the Internet. You can check whether the network parameters (such as the IP address) are properly assigned to the unit. For details, see the following:
 - “Checking the network information of the unit” (p.107)
- For details on music streaming services, see the supplements for streaming services. Access the Yamaha Downloads site to download the supplement.
<http://download.yamaha.com/>

Useful playback functions

SCENE function

Selecting the input source and favorite settings with one touch (SCENE)

The SCENE function allows you to select the following settings with just one touch.

- Input source
- Sound program
- Compressed Music Enhancer On/Off
- SCENE link playback

You can register four SCENE functions that are assigned to four SCENE keys on the remote control respectively.

Selecting a registered scene

Press SCENE, and then the input source and settings registered to the corresponding scene are selected. The unit turns on automatically when it is in standby mode.

Note

To control Zone2, set MAIN/ZONE 2 to "ZONE 2".

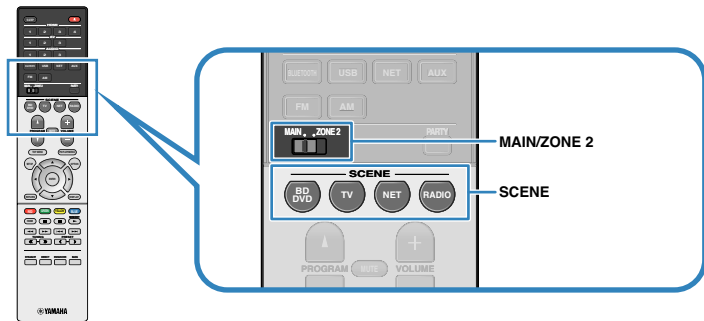

By default, the following settings are registered for each scene.

Main Zone

SCENE	BD DVD	TV	NET	RADIO
Input	HDMI1	AV 1	NET RADIO	TUNER
Sound program	Sci-Fi	STRAIGHT	5ch Stereo	5ch Stereo
Compressed Music Enhancer	Off	On	On	On
SCENE link playback	On	On	Off	Off

Note

- For details on the sound program and Compressed Music Enhancer, see the following:
 - “Enjoying sound field effects optimized for the type of content” (p.39)
 - “Playing back digitally compressed formats with enriched sound (Compressed Music Enhancer)” (p.42)
- The SCENE link playback function allows you to automatically turn on the TV or start playback of an external device connected to the unit via HDMI, in conjunction with a scene selection. For details, see the following:
 - “Setting the use of SCENE link playback” (p.98)

Zone2

SCENE	BD DVD	TV	NET	RADIO
Input	AV 3	AUDIO2	AUX	TUNER

■ Registering a scene

You can change the default setting and register the function that is assigned to each SCENE key.

Note

- We recommend registering the scene with playing back the content that you want to register.
- To control Zone2, set MAIN/ZONE 2 to "ZONE 2".

1 Perform the following operations to prepare the settings you want to assign to a scene.

- Select an input source
- Select a sound program or straight decode
- Enable/disable Compressed Music Enhancer
- Enable/disable SCENE link playback

2 Hold down the desired SCENE key on the remote control until "SET Complete" appears on the front display.



This completes the registers.

Note

For details on the settings, see the following:

- "Enjoying sound field effects optimized for the type of content" (p.39)
- "Playing back digitally compressed formats with enriched sound (Compressed Music Enhancer)" (p.42)
- "Setting the use of SCENE link playback" (p.98)

Shortcut function

■ Registering a favorite content as shortcut

You can register favorite Bluetooth, USB, media server and network content as shortcuts and access them directly by selecting the shortcut numbers.

Note

- You can register up to 40 contents as shortcuts.
- You can also use the “Favorites” feature to register Internet radio stations. For details, see the following:
 - “Registering favorite Internet radio stations” (p.68)
- The unit registers Bluetooth or AirPlay as an input source. No individual content can be registered.

1 Play back a song or a radio station to be registered.

2 Hold down MEMORY for a few seconds.

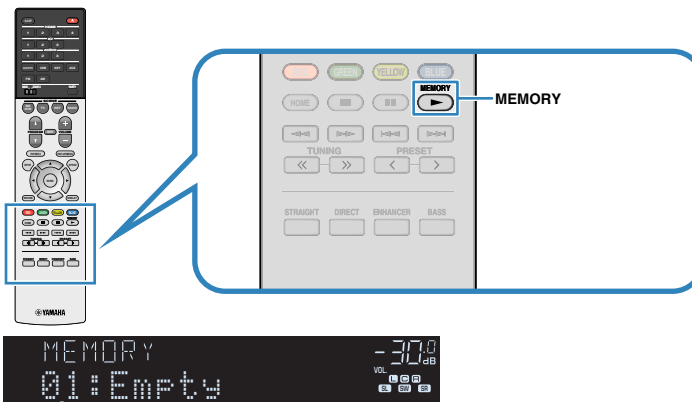

Shortcut number (flashes)

“MEMORY” appears on the front display and the shortcut number to which the item will be registered blinks.

Note

To change a shortcut number to which the item will be registered, use PRESET to select the shortcut number after step 2.



“Empty” (not in use) or item currently registered

3 Press MEMORY.

The registered shortcut number and “Memorized” appear on the front display.

This completes the registers.

■ Recalling a registered content as shortcut

Recall a registered content (Bluetooth, USB, media server and network content) by selecting the shortcut number.

Note

You can register up to 40 contents as shortcuts.

1 Press BLUETOOTH, NET or USB.

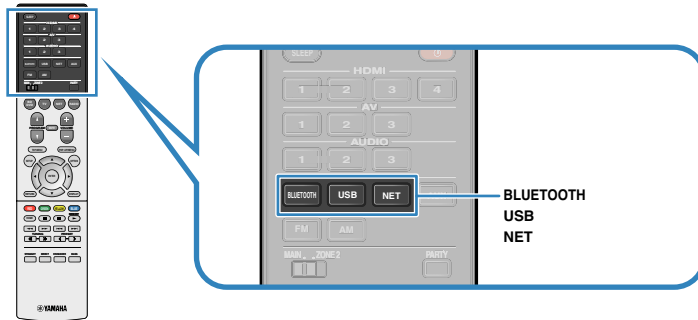

2 Press PRESET to select a desired content.

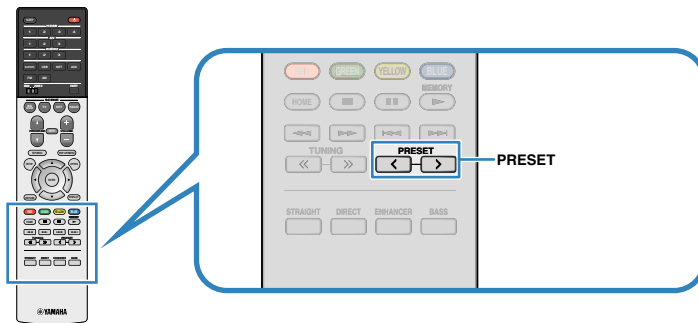

Playback of the selected content starts.

Note

- "No Presets" appears on the front display when no items are registered.
- The registered item cannot be recalled in the following cases.
 - A USB storage device which contains the registered item is not connected to this unit.
 - A PC which contains the registered item is turned off or not connected to the network.
 - The registered network content is temporarily unavailable or out of service.
 - The registered item (file) has been deleted or moved to another location.
 - A Bluetooth connection cannot be established.
- When you register music files stored on a USB storage device or a media server (PC/NAS), this unit memorizes the relative position of the music files in the folder. If you have added or deleted any music files to or from the folder, this unit may not recall the music file correctly. In such cases, register the items again.
- The registered content (songs and Internet radio stations) can be displayed as a list and easily removed by using MusicCast CONTROLLER on your mobile device. For details, see the following:
 - "Using MusicCast CONTROLLER" (p.37)

Configuring playback settings for different playback sources (Option menu)

Basic operation of the Option menu

Perform the following basic procedure to operate the "Option" menu. With the "Option" menu, you can configure different playback settings according to the input source currently being played back.

1 Press OPTION.

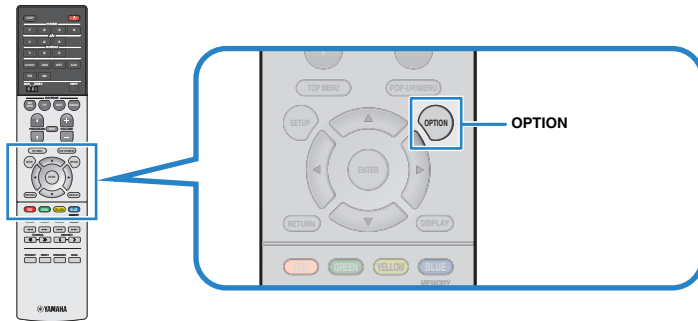

Front display

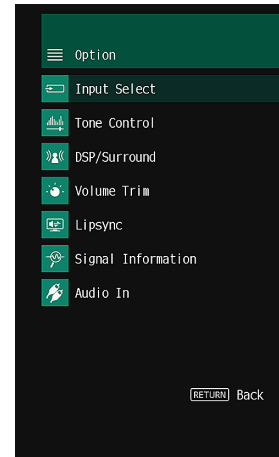

TV screen

- 2 Use the cursor keys to select an item and press ENTER.
- 3 Use the cursor keys to select a setting.
- 4 Press OPTION.

This completes the settings.

Note

For details on the default settings, see the following:

- "Default settings of the Option menu" (p.151)

Option menu items

Use the following table to configure playback settings of the unit.

Note

- Available items vary depending on the selected input source.
- Text in parentheses denotes indicators on the front display.
- Depending on the region of purchase, some menu items for audio streaming services are also available.

Item	Function	Page
Input Select (Input Select)	Switches the input source.	p.76
Tone Control (Tone Control)	Adjusts the level of high-frequency range and low-frequency range individually.	p.76
	Program (PRG) Select the sound programs and stereo playback.	p.76
	Sur.Decode (SrDec) Select which surround decoder is used when Sur.Decode is selected as the program.	p.78
DSP/Surround (DSP/Surround)	DSP Level (DSP Level) Adjusts the sound field effect level.	p.78
	Adaptive DRC (A.DRC) Sets whether the dynamic range (from maximum to minimum) is automatically adjusted to the volume.	p.78
	Enhancer (Enhancer) Enables/disables Compressed Music Enhancer.	p.79
Volume Trim (Volume Trim)	Input Trim (In.Trim) Corrects volume differences between input sources.	p.79
	Subwoofer Trim (SW.Trim) Fine-adjusts the subwoofer volume.	p.79
Lipsync (Lipsync)	Enables/disables the "Lipsync" setting in the "Setup" menu.	p.79
Signal Information (Signal Info.)	Displays information about the video/audio signals.	p.80
Audio In (Audio In)	Combines the video of the selected input source with the audio of a different input source.	p.80
Video Out (Video Out)	Selects a video source to be output together with the selected audio source.	p.81
FM Mode (FM Mode)	Switches between "Stereo" and "Monaural" for FM radio reception.	p.81

Item	Function	Page
Preset (Preset)	Auto Preset (AUTO) Automatically registers FM radio stations with strong signals as presets.	p.82
	Clear Preset (CLEAR) Clear radio stations registered to preset numbers.	p.82
Shuffle (Shuffle)	Configures the shuffle setting.	p.83
Repeat (Repeat)	Configures the repeat setting.	p.83
Volume Interlock (Vol.Interlock)	Enables/disables volume control from iTunes/iPhone via AirPlay.	p.83
Add to favorites (Add to Fav.)	Adds your favorite Internet radio station to the "Favorites" folder, or removes it from the "Favorites" folder.	p.84
Remove from favorites (RemovefromFav.)	(U.K., Europe and Australia models only)	p.84
Init Scan (Init Scan)	Performs an initial scan for DAB radio reception.	p.84
Tune AID (Tune AID)	(U.K., Europe and Australia models only)	p.85
	Checks reception strength of each DAB channel.	

Switching the input source

Switches the input source. Press ENTER to switch to the selected input source.

Option menu

"Input Select"

Adjusting the tone of the audio output

Adjusts the level of high-frequency range (Treble) and low-frequency range (Bass) individually.

Option menu

"Tone Control"

Choices

Treble, Bass

Setting range

-6.0 dB to +6.0 dB (0.5 dB increments)

Note

- When both "Treble" and "Bass" are 0.0 dB, "Bypass" appears.
- If you set an extreme value, sounds may not match those from other channels.

Configuring DSP/Surround

Selecting sound programs

Select sound programs and stereo playback.

Note

You can select a sound program by pressing PROGRAM.

Option menu

"DSP/Surround" > "Program"

MUSIC

Hall in Munich	This program simulates a Munich concert hall with approximately 2,500 seats that uses stylish wood for the interior finishing. Fine, beautiful reverberations spread richly, creating a calming atmosphere. The listener's virtual seat is at the center left of the arena.
Hall in Vienna	This program simulates a 1700-seat, middle-sized concert hall with a shoebox shape that is traditional in Vienna. Pillars and ornate carvings create extremely complex reverberations from all around the audience, producing a very full, rich sound.
Chamber	This program creates a relatively wide space with a high ceiling, like an audience hall in a palace. It offers pleasant reverberations that are suitable for courtly music and chamber music.
Cellar Club	This program simulates an intimate concert venue with a low ceiling and homey atmosphere. A realistic, live sound field delivers powerful sounds that make you feel as if you are sitting in the front row in front of a small stage.
The Roxy Theatre	This program creates the sound field of a 460-seat rock music concert venue in Los Angeles. The listener's virtual seat is at the center left of the hall.
The Bottom Line	This program creates the sound field at stage front in The Bottom Line, a famous New York jazz club once. The floor can seat 300 people to the left and right in a sound field offering real and vibrant sound.

MOVIE

Sports	This program allows listeners to enjoy the rich vividness of sport broadcasts and light entertainment programs. In sports broadcasts, the commentators' voices are positioned clearly at the center, while the atmosphere inside the stadium is realistically conveyed by the peripheral delivery of the sounds of the fans in a suitable space.
Action Game	This program is suitable for action games, such as car racing and fighting games. The reality of, and emphasis on, various effects makes the player feel like they are right in the middle of the action, allowing for greater concentration. Use this program in combination with Compressed Music Enhancer for a more dynamic and strong sound field.
Roleplaying Game	This program is suitable for role-playing and adventure games. This program adds depth to the sound field for natural and realistic reproduction of background music, special effects, and dialogue from a wide variety of scenes. Use this program in combination with Compressed Music Enhancer for a clearer and more spatial sound field.
Music Video	This program allows you to enjoy videos of pop, rock, and jazz concerts, as if you were there yourself. Immerse yourself in the hot concert atmosphere thanks to the vividness of the singers and solos on stage, a presence sound field that emphasizes the beat of rhythm instruments, and a surround sound field that reproduces the space of a big live hall.
Standard	This program creates a sound field that emphasizes the surround feeling without disturbing the original acoustic positioning of multichannel audio. Its design is based on the concept of the ideal movie theater, in which the audience is surrounded by beautiful reverberations from the left, right, and rear.
Spectacle	This program delivers the scale and grandeur of spectacular movie productions. It delivers an expansive sound space to match the cinemascope wide-screen, and boasts a broad dynamic range, providing everything from small delicate sounds to powerful loud booms.
Sci-Fi	This program clearly reproduces the finely elaborated sound design of the latest Sci-Fi and SFX movies. You can enjoy a variety of cinematographically created virtual spaces reproduced with clear separation between dialogue, sound effects, and background music.
Adventure	This program is ideal for reproducing the sound design of action and adventure movies precisely. The sound field restrains reverberations, but puts emphasis on reproducing a sensation of expansiveness on both sides, powerful space expanded widely to the left and right. The restrained depth creates a clear and powerful space, while also maintaining the articulation of the sounds and the separation of the channels.
Drama	This program features stable reverberations that match a wide range of movie genres, from serious dramas to musicals and comedies. The reverberations are modest, but suitably stereophonic. The sound effects and background music are reproduced with a gentle echo that does not impinge on the articulation of the dialogue. You'll never get tired listening for long periods.

Mono Movie

This program reproduces monaural video sources, such as classic movies, in an atmosphere of a good old movie theater. The program creates a pleasant space with depth, by adding breadth and the appropriate reverberation to the original audio.

STEREO

2ch Stereo

Use this program to mix down multichannel sources to 2 channels. When multichannel signals are input, they are down mixed to 2 channels and output from the front speakers (this program does not utilize CINEMA DSP).

5ch Stereo

Use this program to output sound from all speakers. When you play back multichannel sources, the unit mixes down the source to 2 channels, and then outputs the sound from all speakers. This program creates a larger sound field and is ideal for background music at parties.

UNPROCESSED

Sur.Decode

The surround decoder enables multichannel playback from 2-channel sources without sound field effects.

Straight

When the straight decode mode is enabled, the unit produces stereo sound from the front speakers for 2-channel sources such as CDs, and produces unprocessed multichannel sounds for multichannel sources.

Note

For details on "Sur.Decode", see the following:

- "Selecting the surround decoder used in the program" (p.78)

■ Selecting the surround decoder used in the program

Select the surround decoder used when “Sur.Decode” is selected in “Program” in the “Option” menu or selected by pressing PROGRAM.

Note

For details on “Program” in the “Option” menu, see the following:

- “Selecting sound programs” (p.76)

Option menu

“DSP/Surround” > “Sur.Decode”

Settings

DPL Movie	Uses the Dolby Pro Logic II decoder suitable for movies.
DPL Music	Uses the Dolby Pro Logic II decoder suitable for music.
DPL Game	Uses the Dolby Pro Logic II decoder suitable for games.
Neo:6 Cinema	Uses the DTS Neo: 6 decoder suitable for movies.
Neo:6 Music	Uses the DTS Neo: 6 decoder suitable for music.

Note

- For details on each decoder, see the following:
 - “Glossary of audio decoding format” (p.138)
- You can adjust the surround decoder parameters in “DSP Parameter” in the “Setup” menu. For details, see the following:
 - “Setting the broadening effect of the front sound field” (p.99)
 - “Adjusting the broadening effect of the center sound field” (p.99)
 - “Adjusting the difference in level between the front and surround sound fields” (p.99)
 - “Adjusting the center localization (broadening effect) of the front sound field” (p.99)

■ Adjusting the sound field effect level

Adjusts the sound field effect level.

Option menu

“DSP/Surround” > “DSP Level”

Setting range

-6 dB to +3 dB (1 dB increments)

■ Adjusting the dynamic range automatically

Sets whether the dynamic range (from maximum to minimum) is automatically adjusted when the volume level is adjusted. When it is set to “On”, the dynamic range becomes narrow at a low volume and wide at a high volume. It is useful for listening to playback at a low volume at night.

Option menu

“DSP/Surround” > “Adaptive DRC”

Settings

Off	The dynamic range is not automatically adjusted.
On	Automatically adjusts the dynamic range.

■ Setting Compressed Music Enhancer

Enables/disables Compressed Music Enhancer.

Option menu

"DSP/Surround" > "Enhancer"

Settings

Off	Disables Compressed Music Enhancer.
On	Enables Compressed Music Enhancer.

Note

- This setting is applied separately to each input source.
- You can also use ENHANCER on the remote control to enable/disable Compressed Music Enhancer.
- For details on Compressed Music Enhancer, see the following:
 - "Playing back digitally compressed formats with enriched sound (Compressed Music Enhancer)" (p.42)

Correcting volume differences during playback

■ Correcting volume differences between input sources

Corrects volume differences between input sources. If you are bothered by volume differences when switching between input sources, use this function to correct it.

Option menu

"Volume Trim" > "Input Trim"

Setting range

-6.0 dB to +6.0 dB (0.5 dB increments)

Note

This setting is applied separately to each input source.

■ Adjusting the subwoofer volume

Fine-adjusts the subwoofer volume.

Option menu

"Volume Trim" > "Subwoofer Trim"

Setting range

-6.0 dB to +6.0 dB (0.5 dB increments)

Enabling Lipsync adjustment

Enables/disables the adjustment configured in "Lipsync" in the "Setup" menu.

Note

For details on "Lipsync" in the "Setup" menu, see the following:

- "Setting the adjustment method of the Lipsync function" (p.100)

Option menu

"Lipsync"

Settings

Off	Disables the "Lipsync" adjustment.
On	Enables the "Lipsync" adjustment.

Note

This setting is applied separately to each input source.

Checking information about the video/audio signals

Displays information about the video/audio signals.

Option menu

"Signal Information"

Format	Audio format of the input signal
Channel	The number of source channels in the input signal (front/surround/LFE) For example, "3/2/0.1" means 3 front channels, 2 surround channels, and LFE.
Sampling	The number of samples per second of the input digital signal
Video In	Type and resolution of the input digital signal
Video Out	Type and resolution of the output digital signal

Note

To switch the information on the front display, press the cursor keys.

Combining audio of another input source with video of the current input source

Select the audio of a different input source to play back together with the video of the currently selected input source. For example, use this function in the following cases.

- Connecting a playback device that supports HDMI video output, but not HDMI audio output

Option menu

"Audio In"

Input sources

HDMI 1-4, AV 1-3

Settings

AV 1-3, AUDIO 1-3

Video/audio input jacks available on the unit

Output jacks on video device		Input jacks on the unit	
Video	Audio	Video	Audio
HDMI	Digital optical	HDMI 1-4	AV 1 (OPTICAL)
	Digital coaxial	HDMI 1-4	AUDIO 1 (COAXIAL) AV 2 (COAXIAL)
	Analog stereo	HDMI 1-4	AUDIO 2-3 (AUDIO) AV 3 (AUDIO)
Composite video	Digital optical	AV 1-3 (VIDEO)	AV 1 (OPTICAL)
	Digital coaxial	AV 1-3 (VIDEO)	AUDIO 1 (COAXIAL) AV 2 (COAXIAL)
	Analog stereo	AV 1-3 (VIDEO)	AUDIO 2-3 (AUDIO) AV 3 (AUDIO)

Necessary setting

For example, if you have connected a video device to HDMI 2 and AV 3 (AUDIO) jack of the unit, change the combination setting as follows.

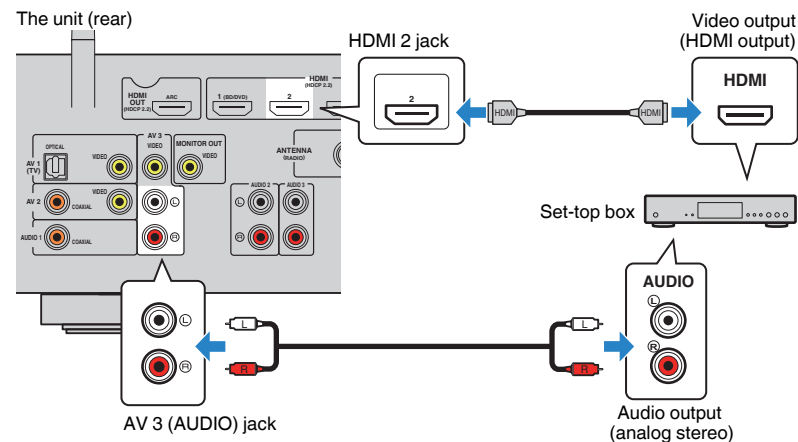

1 Press HDMI2 to select “HDMI2” (video input jack to be used) as the input source.

2 Press OPTION.

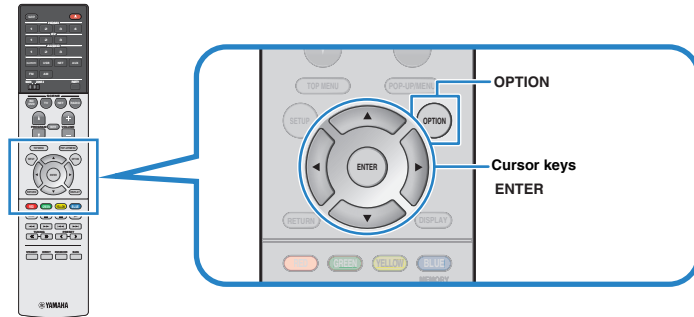

3 Use the cursor keys to select “Audio In” and press ENTER.



4 Use the cursor keys to select “AV 3” (audio input jack to be used).



5 Press OPTION.

This completes the necessary settings.

Selecting a video source to be output with the selected audio source

Selects a video source to be output together with the selected audio source. For example, you can watch the video from a different source while listening to the radio.

Option menu

“Video Out”

Input sources

AUX, AUDIO 1-3, TUNER, (network sources), AirPlay, MusicCast Link, SERVER, NET RADIO, Bluetooth, USB

Settings

Off	Does not output video.
HDMI 1-4, AV 1-3	Outputs video input through the corresponding video input jacks.

Switching between stereo and monaural for FM radio reception

Switch between stereo and monaural for FM radio reception. When the signal reception for an FM radio station is unstable, switching to monaural may improve it.

Option menu

“FM Mode”

Settings

Stereo	Enables stereo for FM radio reception.
Monaural	Enables monaural for FM radio reception.

Setting presets for radio stations

■ Registering radio stations automatically

Automatically register FM radio stations with strong signals.

Note

- You can register up to 40 radio stations as presets.
- To register AM radio stations, see the following:
 - “Registering a radio station manually” (p.52)
- (U.K. and Europe models only)
 - Only Radio Data System broadcasting stations are registered automatically by the Auto Preset function.

Option menu

“Preset” > “Auto Preset”

1 Press FM or AM to select “TUNER” as the input source.

“TUNER” is selected as the input source and the frequency currently selected is displayed on the front display.

2 Press OPTION.

3 Use the cursor keys to select “Preset” and press ENTER.



The preset number from which to start the registration is displayed on the front display.

Note

To specify the preset number from which to start the registration, press cursor keys or PRESET to select a preset number.

4 To start the Auto Preset process, press ENTER.

“SEARCH” appears during Auto Preset



Preset number from which to start the registration

The Auto Preset process starts and “SEARCH” appears during Auto Preset.

Note

To cancel the Auto Preset process, press RETURN.

When the Auto Preset process finishes, “FINISH” appears on the front display and the “Option” menu closes automatically.



■ Clearing preset stations

Clear radio stations registered to the preset numbers.

Option menu

“Preset” > “Clear Preset”

1 Press FM or AM (DAB) to select “TUNER” as the input source.

“TUNER” is selected as the input source and the frequency currently selected is displayed on the front display.

2 Press OPTION.

3 Use the cursor keys to select “Preset” and press ENTER.

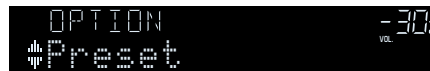

4 Use the cursor keys to select “CLEAR”.

This step is skipped when clearing DAB radio stations.

- 5** Use the cursor keys to select a preset station to be cleared and press **ENTER**.



Preset station to be cleared

If the preset station is cleared, "Cleared" appears and then the next in-use preset number is displayed.



- 6** Repeat step 5 until all desired preset stations are cleared.

- 7** Press **OPTION**.

This completes the clearing preset stations.

Configuring the shuffle setting

Configure the shuffle setting for playback.

Option menu

"Shuffle"

Settings

Off	Turns off the shuffle function.
On	Plays back songs in the current album (folder) in random order.

Note

This setting is available only when "USB" or "SERVER" is selected as the input source.

Configuring the repeat setting

Configure the repeat setting for playback.

Option menu

"Repeat"

Settings

Off	Turns off the repeat function.
One	Plays back the current song repeatedly.
All	Plays back all songs in the current album (folder) repeatedly.

Note

This setting is available only when "USB" or "SERVER" is selected as the input source.

Enabling volume control via AirPlay

Enables/disables volume control from iTunes/iPhone via AirPlay. When other than "Off" is set, you can adjust the unit's volume from the iTunes/iPhone during playback.

Option menu

"Volume Interlock"

Settings

Off	Disables volume control from iTunes/iPhone.
Limited	Enables volume control from iTunes/iPhone within the limited range (-80 dB to -20 dB and mute).
Full	Enables volume control from iTunes/iPhone in the full range (-80 dB to +16.5 dB and mute).

Adding an Internet radio station to the “Favorites” folder

Register the currently playing Internet radio station to the “Favorites” folder.

Option menu

“Add to favorites”

- 1 While listening to Internet radio, press OPTION.**
- 2 Use the cursor keys to select “Add to favorites” and press ENTER.**

When the registering process finishes, the “Option” menu closes automatically.

Removing an Internet radio station from the “Favorites” folder

Remove an Internet radio station from the “Favorites” folder.

Option menu

“Remove from favorites”

- 1 Use the cursor keys to select the station to be removed from the “Favorites” folder.**
- 2 Press OPTION.**
- 3 Use the cursor keys to select “Remove from favorites” and press ENTER.**

When the removing process finishes, the “Option” menu closes automatically.

Performing an initial scan for DAB radio reception

(U.K., Europe and Australia models only)

Perform an initial scan for searching DAB radio stations.

Option menu

“Init Scan”

- 1 Press DAB to select the DAB band.**
- 2 Press OPTION.**
- 3 Use the cursor keys to select “Init Scan” and press ENTER.**
- 4 Press ENTER to start an initial scan.**

When the initial scan finishes, the unit automatically tunes into the first DAB radio station as stored in station order.

Note

- If you perform an initial scan again, the DAB radio stations currently registered to the preset numbers will be cleared.
- If no DAB radio stations are found by an initial scan, press ENTER to start an initial scan again.

Checking reception strength of each DAB channel label

(U.K., Europe and Australia models only)

You can check reception strength of each DAB channel label.

Option menu

“Tune AID”

- 1 Press DAB to select the DAB band.**
- 2 Press OPTION.**
- 3 Use the cursor keys to select “Tune AID” and press ENTER.**
- 4 Use the cursor keys to select the desired DAB channel label.**

The reception strength of DAB channel label is displayed in 0 (none) to 100 (best).

- 5 Press OPTION.**

This completes the checking.

CONFIGURATIONS

Configuring various functions (Setup menu)

Basic operation of the Setup menu

Perform the following basic procedure to operate the “Setup” menu. You can configure the unit’s various functions with the “Setup” menu.

Note

- If new firmware is available, the message screen appears.
- If new firmware is available, the envelope icon (✉) appears in the screen.
- For details on firmware updating, see the following:
 - “Firmware updates” (p.130)

1 Press SETUP.

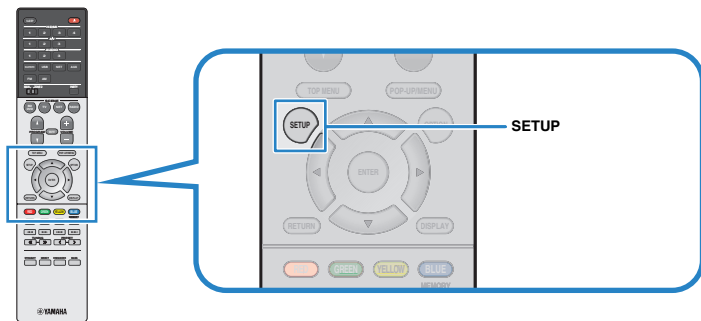

2 Use the cursor keys to select a menu and press ENTER.

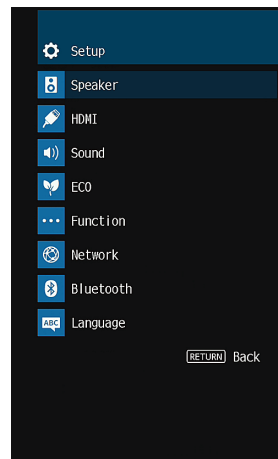

3 Use the cursor keys to select an item and press ENTER.

4 Use the cursor keys to select a setting and press ENTER.

5 Press SETUP.

This completes the settings.

Note

For details on the default settings, see the following:

- “Default settings of the Setup menu” (p.151)

Setup menu items

Use the following table to configure various functions of the unit.

Menu	Item	Function	Page	
Speaker	Configuration	Power Amp Assign	Selects a speaker system.	p.90
		Subwoofer	Selects whether or not a subwoofer is connected.	p.90
		Front	Selects the size of the front speakers.	p.91
		Center	Selects whether or not a center speaker is connected and its size.	p.91
		Surround	Selects whether or not surround speakers are connected and their size.	p.92
		Crossover	Sets the lower limit of the low-frequency component that can be output from speakers whose size is set to "Small".	p.92
		Subwoofer Phase	Sets the phase of the subwoofer.	p.93
		Extra Bass	Enables/disables Extra Bass.	p.93
		Virtual CINEMA FRONT	Enables/disables the front 5-channel speaker (Virtual CINEMA FRONT) configuration.	p.93
		Distance	Sets the distance between each speaker and the listening position.	p.93
		Level	Adjusts the volume of each speaker.	p.94
		Equalizer	Adjusts the tone with an equalizer.	p.94
		Test Tone	Enables/disables the test tone output.	p.95
		HDMI	HDMI Control	Enables/disables HDMI Control.
Audio Output	Enables/disables audio output from a TV.		p.96	
Standby Through	Selects whether to output video/audio (input through HDMI jacks) to the TV when the unit is in standby mode.		p.96	
4K Upscaling	Enables/disables the upscaling function.		p.96	
HDCP Version	Selects the version of HDCP used on the HDMI input jacks.		p.97	
TV Audio Input	Selects an audio input jack of the unit to be used for TV audio input.		p.97	
Standby Sync	Selects whether to use HDMI control to link the standby behavior of the TV and the unit.		p.97	
ARC	Enables/disables ARC.		p.97	
SCENE	Enables/disables SCENE link playback.		p.98	

Menu	Item	Function	Page	
Sound	DSP Parameter	Panorama	Enables/disables the broadening effect of the front sound field.	p.99
		Center Width	Adjusts the broadening effect of the center sound field.	p.99
		Dimension	Adjusts the difference in level between the front and surround sound fields.	p.99
		Center Image	Adjusts the center localization (broadening effect) of the front sound field.	p.99
		Monaural Mix	Enables/disables monaural sound output.	p.100
	Lipsync	Select	Selects the method to adjust the delay between video and audio output.	p.100
		Adjustment	Adjusts the delay between video and audio output manually.	p.100
	Dialogue	Dialogue Level	Adjusts the volume of dialogue sounds.	p.100
		Scale	Switches the scale of the volume display.	p.101
	Volume	Dynamic Range	Selects the dynamic range adjustment method for bitstream audio (Dolby Digital and DTS signals) playback.	p.101
		Main Zone Max Volume	Sets the Main Zone limit value of the volume.	p.101
		Main Zone Initial Volume	Sets the Main zone initial volume when the unit is turned on.	p.101
		Zone2 Max Volume	Sets the Zone2 limit value of the volume.	p.102
ECO	Zone2 Initial Volume	Sets the Zone2 initial volume when the Zone2 output is enabled.	p.102	
	Auto Power Standby	Set the amount of time for the auto-standby function.	p.103	
Function	ECO Mode	Enables/disables the eco mode (power saving mode).	p.103	
	Input Rename	Changes the input source name displayed on the front display.	p.104	
	Input Skip	Set which input sources are skipped when operating the INPUT knob.	p.105	
	Dimmer	Adjusts the brightness of the front display.	p.105	
	Memory Guard	Prevents accidental changes to the settings.	p.105	
	Remote Color Key	Set the unit's functions for the RED/GREEN/YELLOW/BLUE keys of the remote control.	p.106	
	Party Mode Set	Enables/disables switching to the party mode.	p.106	
Network	Information	Displays the network information of the unit.	p.107	
	Network Connection	Selects the network connection method.	p.107	
	IP Address	Configures the network parameters (such as IP address).	p.107	
	MAC Address Filter	Sets the MAC address filter to limit access to the unit from other network devices.	p.108	
	DMC Control	Selects whether to allow a Digital Media Controller (DMC) to control playback.	p.109	
	Network Standby	Selects whether to enable/disable the function that turns on the unit from other network devices.	p.109	
	Network Name	Edits the network name (the unit's name on the network) displayed on other network devices.	p.110	
	MusicCast Link Power Interlock	Selects whether turning on the power of the master device of the MusicCast network (this unit) also turns on the power of other devices of the network.	p.110	
	Network Update	Updates the firmware via the network.	p.110	

Menu	Item	Function	Page
	Bluetooth	Enables/disables the Bluetooth functions.	p.111
Bluetooth	Audio Receive	Disconnect	Terminates the Bluetooth connection between the Bluetooth device (such as smartphones) and the unit.
		Bluetooth Standby	Selects whether to enable/disable the function that turns on the unit from Bluetooth devices (Bluetooth standby).
Language		Select an on-screen menu language.	p.112

Configuring the speaker settings

Setting your speaker system

Select the setting according to the speakers that are connected.

Setup menu

"Speaker" > "Configuration" > "Power Amp Assign"

Settings

Surround	Select this option when you use a normal speaker system (not using Zone2 speakers or a bi-amp connections).
BI-AMP	Select this option when you connect front speakers that support bi-amp connections.
Zone 2	Select this option when you use Zone2 speakers in addition to the speaker system in the Main zone.

Note

For details on the speaker system, see the following:

- "Speaker systems and speakers to be connected" (p.17)
- "Connecting front speakers that support bi-amp connections" (p.23)
- "Playing back music in multiple rooms" (p.43)

Setting the use of a subwoofer

Selects the setting according to the use of your subwoofer.

Setup menu

"Speaker" > "Configuration" > "Subwoofer"

Settings

	Select this option when a subwoofer is connected.
Use	The subwoofer will produce LFE (low-frequency effect) channel audio and low-frequency components from other channels.
	Select this option when no subwoofer is connected.
None	The front speakers will produce LFE (low-frequency effect) channel audio and low-frequency components from other channels.

Setting the size of the front speakers

Selects the setting according to the size of your front speakers.

Setup menu

"Speaker" > "Configuration" > "Front"

Settings

	Select this option for small speakers.
Small	The subwoofer will produce front channel low-frequency components (configurable in "Crossover").
	Select this option for large speakers.
Large	The front speakers will produce all of the front channel frequency components.

Note

- When configuring the speaker size, as a general guideline, select "Large" if the woofer diameter of your speaker is 16 cm (6-1/4") or larger, or "Small" if it is smaller than 16 cm (6-1/4").
- "Front" is automatically set to "Large" when "Subwoofer" is set to "None". For details on "Subwoofer" in the "Setup" menu, see the following:
 - "Setting the use of a subwoofer" (p.90)

Setting the use of a center speaker and its size

Selects the setting according to the use and size of your center speaker.

Setup menu

"Speaker" > "Configuration" > "Center"

Settings

	Select this option for small speakers.
Small	The subwoofer or front speakers will produce center channel low-frequency components (configurable in "Crossover").
	Select this option for large speakers.
Large	The center speaker will produce all of the center channel frequency components.
	Select this option when no center speaker is connected.
None	The front speakers will produce center channel audio.

Note

When configuring the speaker size, as a general guideline, select "Large" if the woofer diameter of your speaker is 16 cm (6.1/4") or larger, or "Small" if it is smaller than 16 cm (6.1/4").

Setting the use of surround speakers and their size

Selects the setting according to the use and size of your surround speakers.

Setup menu

"Speaker" > "Configuration" > "Surround"

Settings

Small	Select this option for small speakers. The subwoofer or front speakers will produce surround channel low-frequency components (configurable in "Crossover").
Large	Select this option for large speakers. The surround speakers will produce all of the surround channel frequency components.
None	Select this option when no surround speakers are connected. The front speakers will produce surround channel audio. Virtual CINEMA DSP works in this case.

Note

- When configuring the speaker size, as a general guideline, select "Large" if the woofer diameter of your speaker is 16 cm (6.1/4") or larger, or "Small" if it is smaller than 16 cm (6.1/4").
- For details on Virtual CINEMA DSP, see the following:
 - "Enjoying sound field effects without surround speakers (Virtual CINEMA DSP)" (p.39)

Setting the crossover frequency of the low-frequency components

Sets the lower limit of the low-frequency components that can be output from a speaker whose size is set to "Small". A frequency sound lower than the specified value will be produced from the subwoofer or front speakers.

Setup menu

"Speaker" > "Configuration" > "Crossover"

Settings

40 Hz, 60 Hz, 80 Hz, 90 Hz, 100 Hz, 110 Hz, 120 Hz, 160 Hz, 200 Hz

Note

If the volume and crossover frequency are adjustable on your subwoofer, set the volume to half and crossover frequency to maximum.

Setting the phase of the subwoofer

Sets the phase of the subwoofer. When the bass sound is lacking or unclear, switch the subwoofer phase.

Setup menu

"Speaker" > "Configuration" > "Subwoofer Phase"

Settings

Normal	Does not reverse the subwoofer phase.
Reverse	Reverses the subwoofer phase.

Note

This setting is not available when "Subwoofer" is set to "None". For details on "Subwoofer" in the "Setup" menu, see the following:

- "Setting the use of a subwoofer" (p.90)

Setting the use of Extra Bass

Enables/disables Extra Bass. When Extra Bass is enabled, you can enjoy enhanced bass sounds, regardless of the size of the front speakers and the presence or absence of the subwoofer.

Setup menu

"Speaker" > "Configuration" > "Extra Bass"

Settings

Off	Disables Extra Bass.
On	Enables Extra Bass.

Note

You can also use BASS on the remote control to enable/disable Extra Bass.

Setting the use of Virtual CINEMA FRONT

Selects whether to use Virtual CINEMA FRONT.

Note

Select "On" only when utilizing the Virtual CINEMA FRONT configuration. For details, see the following:

- "Using Virtual CINEMA FRONT" (p.22)

Setup menu

"Speaker" > "Configuration" > "Virtual CINEMA FRONT"

Settings

Off	Disables Virtual CINEMA FRONT
On	Enables Virtual CINEMA FRONT

Note

This setting is not available when "Surround" is set to "None". For details on "Surround" in the "Setup" menu, see the following:

- "Setting the use of surround speakers and their size" (p.92)

Setting the distance between each speaker and the listening position

Sets the distance between each speaker and the listening position so that sounds from the speakers reach the listening position at the same time.

Setup menu

"Speaker" > "Distance"

Choices

Front L, Front R, Center, Surround L, Surround R, Subwoofer

Setting range

0.30 m to 24.00 m (1.0 ft to 80.0 ft), 0.05 m (0.2 ft) increments

Note

Select the unit of distance from "Meter" or "Feet" in "Unit".

Adjusting the volume of each speaker

Adjusts the volume of each speaker to suit your listening position.

Setup menu

"Speaker" > "Level"

Choices

Front L, Front R, Center, Surround L, Surround R, Subwoofer

Setting range

-10.0 dB to +10.0 dB (0.5 dB increments)

Note

Test tone output helps you to adjust the speaker balance while confirming its effect. For details, see the following:

- "Outputting test tones" (p.95)

Setting the equalizer

Selects the type of equalizer to be used and adjusts the tone.

Setup menu

"Speaker" > "Equalizer" > "EQ Select"

Settings

PEQ	Applies the parametric equalizer values obtained by the YPAO measurement.
GEQ	Select this option when you want to adjust the equalizer manually.
Off	Does not use the equalizer.

When selecting "GEQ"

1 Use the cursor keys to select "Channel" and to select the desired speaker channel.

2 Use the cursor keys to select the desired band (frequency) and to adjust the gain.

Setting range

-6.0 dB to +6.0 dB

3 Press SETUP.

This completes the settings.

Note

- Test tone output helps you to adjust the equalizer while confirming its effect. For details, see the following:
 - "Outputting test tones" (p.95)
- "PEQ" is available only when the YPAO has been performed. For details on the YPAO, see the following:
 - "Optimizing the speaker settings automatically (YPAO)" (p.33)

Outputting test tones

Enables/disables the test tone output. Test tone output helps you to adjust the speaker balance or equalizer while confirming its effect.

Setup menu

“Speaker” > “Test Tone”

Settings

Off	Does not output test tones.
On	Outputs test tones automatically when you adjust the speaker balance or equalizer.

Configuring the HDMI settings

Setting the use of HDMI Control

Enables/disables HDMI Control. HDMI Control allows you to operate external devices via HDMI.

Setup menu

"HDMI" > "HDMI Control"

Settings

Off	Disables HDMI Control.
On	Enables HDMI Control. Configure the settings in "TV Audio Input", "Standby Sync", "ARC", and "SCENE".

Note

To use HDMI control, you need to perform the HDMI Control link setup after connecting HDMI Control-compatible devices. For details, see the following:

- "HDMI Control and synchronized operations" (p.142)

Setting the output of HDMI audio from the TV speaker

Enables/disables audio output from a TV connected to the HDMI OUT jack when "HDMI Control" is set to "Off".

Note

For details on "HDMI Control" in the "Setup" menu, see the following:

- "Setting the use of HDMI Control" (p.96)

Setup menu

"HDMI" > "Audio Output"

Settings

Off	Disables audio output from the TV.
On	Enables audio output from the TV.

Setting the use of HDMI Standby Through

Select whether to output video/audio (input through HDMI jacks) to the TV when the unit is in standby mode.

Note

If this function is set to "On" or "Auto", you can use the input selection keys (HDMI 1–4) to select an HDMI input even when the unit is in standby mode (the standby indicator on the unit blinks).

Setup menu

"HDMI" > "Standby Through"

Settings

Off	Does not output video/audio to the TV.
Auto	Automatically selects whether to output video/audio depending on the status of the connected device.
On	Outputs video/audio to the TV. (The unit consumes more power than when "Off" or "Auto" is selected.)

Note

- "Off" is not selectable when "HDMI Control" is set to "On".
- For details on "HDMI Control" in the "Setup" menu, see the following:
 - "Setting the use of HDMI Control" (p.96)

Setting the use of 4K upscaling of the HDMI video signal

Enables/disables the upscaling function. When it is enabled, 1080p content is displayed at 4K resolution.

Setup menu

"HDMI" > "4K Upscaling"

Settings

Off	Disables the upscaling function.
On	Enables the upscaling function.

Setting the version of HDCP used on the HDMI input jacks

Selects the HDCP version of the HDMI input jacks for watching 4K video content.

Setup menu

"HDMI" > "HDCP Version"

Input sources

HDMI 1-4

Settings

Auto	Automatically sets the version of HDCP according to content.
1.4	Sets the version of HDCP to always be 1.4.

Setting the audio jack used for TV audio input

Selects an audio input jack of the unit to be used for TV audio input when "HDMI Control" is set to "On". The unit's input source automatically switches to TV audio when the TV input is switched to its built-in tuner.

Note

For details on "HDMI Control" in the "Setup" menu, see the following:

- "Setting the use of HDMI Control" (p.96)

Setup menu

"HDMI" > "TV Audio Input"

Settings

AV 1-3, AUDIO 1-3

Note

When using ARC to input TV audio to the unit, the input jacks selected here will be used for TV Audio Input.

Linking the standby modes of the unit and the TV

Select whether to use HDMI control to link the unit's standby mode to the TV's power when "HDMI Control" is set to "On".

Note

For details on "HDMI Control" in the "Setup" menu, see the following:

- "Setting the use of HDMI Control" (p.96)

Setup menu

"HDMI" > "Standby Sync"

Settings

Off	Does not set the unit to standby mode when the TV is turned off.
On	Sets the unit to standby mode when the TV is turned off.
Auto	Sets the unit to standby mode when the TV is turned off only when the unit is receiving TV audio or HDMI signals.

Setting the use of ARC

Select whether to output TV audio to the speakers connected to the unit when "HDMI Control" is set to "On".

Note

For details on "HDMI Control" in the "Setup" menu, see the following:

- "Setting the use of HDMI Control" (p.96)

Setup menu

"HDMI" > "ARC"

Settings

Off	Disables ARC.
On	Enables ARC.

Note

You do not need to change this setting normally. In case noises are produced from the speakers connected to the unit because TV audio signals input to the unit via ARC are not supported by the unit, set "ARC" to "Off" and use the TV's speakers.

Setting the use of SCENE link playback

Enables/disables SCENE link playback when "HDMI Control" is set to "On".

When SCENE link playback is enabled, HDMI Control-compatible devices connected to the unit via HDMI automatically work as follows when a scene is selected.

- TV: turning on and displaying video from the playback device
- Playback device: starting playback

Note

For details on "HDMI Control" in the "Setup" menu, see the following:

- "Setting the use of HDMI Control" (p.96)

Setup menu

"HDMI" > "SCENE"

Choices (SCENE keys)

BD / DVD, TV, NET, RADIO

Settings

Off	Disables SCENE link playback for the selected SCENE key.
On	Enables SCENE link playback for the selected SCENE key.

Note

SCENE link playback may not work properly due to the compatibility between devices. We recommend using TV and playback devices from the same manufacturer so that HDMI Control works more effectively.

Configuring the sound settings

Setting the broadening effect of the front sound field

Enables/disables the broadening effect of the front sound field. When this function is enabled, you can wrap front left/right channel sounds around the sound field and generate a spacious sound field in combination with the surround sound field. This setting is effective when "DPL Music" is selected.

Setup menu

"Sound" > "DSP Parameter" > "Panorama"

Settings

Off	Disables the broadening effect of the front sound field.
On	Enables the broadening effect of the front sound field.

Note

For details on the surround decoder, see the following:

- "Selecting the surround decoder used in the program" (p.78)

Adjusting the broadening effect of the center sound field

Adjusts the broadening effect of the center sound field. Higher to enhance the broadening effect, and lower to reduce it (closer to center). This setting is effective when "DPL Music" is selected.

Setup menu

"Sound" > "DSP Parameter" > "Center Width"

Setting range

0 to 7

Note

For details on the surround decoder, see the following:

- "Selecting the surround decoder used in the program" (p.78)

Adjusting the difference in level between the front and surround sound fields

Adjusts the difference in level between the front and surround sound fields. Higher to strengthen the front sound field and lower to strengthen the surround sound field. This setting is effective when "DPL Music" is selected.

Setup menu

"Sound" > "DSP Parameter" > "Dimension"

Setting range

-3 to +3

Note

For details on the surround decoder, see the following:

- "Selecting the surround decoder used in the program" (p.78)

Adjusting the center localization (broadening effect) of the front sound field

Adjusts the center localization (broadening effect) of the front sound field. Adjust this higher to strengthen the center localization (less broadening effect) or lower to weaken it (more broadening effect). This setting is effective when "Neo:6 Music" is selected.

Setup menu

"Sound" > "DSP Parameter" > "Center Image"

Setting range

0.0 to 1.0

Note

For details on the surround decoder, see the following:

- "Selecting the surround decoder used in the program" (p.78)

Setting the use of Monaural Mix

Enables/disables monaural sound output. This function can be applicable when the sound program is set to "5ch Stereo" only.

Setup menu

"Sound" > "DSP Parameter" > "Monaural Mix"

Settings

Off	Disables monaural sound output.
On	Enables monaural sound output.

Setting the adjustment method of the Lipsync function

Selects the method for adjusting the delay between video and audio output.

Setup menu

"Sound" > "Lipsync" > "Select"

Settings

Manual	Select this option when you want to adjust the delay between video and audio output manually. Adjust the audio output timing in "Adjustment".
Auto	Adjusts the delay between video and audio output automatically when a TV that supports an automatic lipsync function is connected to the unit via HDMI. If necessary, you can fine-adjust the audio output timing in "Adjustment".

Note

- You can enable/disable the Lipsync function by input sources in "Lipsync" in the "Option" menu. For details, see the following:
 - "Enabling Lipsync adjustment" (p.79)
- For details on "Adjustment" in the "Setup" menu, see the following:
 - "Adjusting the delay of the Lipsync function" (p.100)

Adjusting the delay of the Lipsync function

Adjusts the delay between video and audio output manually when "Select" is set to "Manual". You can fine-adjust the audio output timing when "Select" is set to "Auto".

Setup menu

"Sound" > "Lipsync" > "Adjustment"

Setting range

0 ms to 500 ms (1 ms increments)

Note

For details on "Select" in the "Setup" menu, see the following:

- "Setting the adjustment method of the Lipsync function" (p.100)

Adjusting the volume of dialogue sound

Adjusts the volume of dialogue sounds that are hardly heard.

Setup menu

"Sound" > "Dialogue" > "Dialogue Level"

Setting range

0 to 3 (higher to strengthen)

Setting the scale of the volume display

Switches the scale of the volume display.

Setup menu

“Sound” > “Volume” > “Scale”

Settings

dB	Displays the volume in the “dB” unit.
0-97	Displays the volume in the numeric value (0.5 to 97.0).

Setting the dynamic range adjustment method

Selects the dynamic range adjustment method for bitstream audio (Dolby Digital and DTS signals) playback.

Setup menu

“Sound” > “Volume” > “Dynamic Range”

Settings

Maximum	Produces audio without adjusting the dynamic range.
Standard	Optimizes the dynamic range for regular home use.
Min/Auto	Sets the dynamic range for clear sound even at night or at low volumes. When playing back Dolby TrueHD signals, the dynamic range is automatically adjusted based on the input signal information.

Setting the Main zone limit value of the volume

Sets the Main zone limit value of the volume adjusted by using such as VOLUME keys on the remote control.

Setup menu

“Sound” > “Volume” > “Main Zone Max Volume”

Setting range

-60.0 dB to +15.0 dB (5.0 dB increments), +16.5 dB [20.0 to 95.0 (5.0 increments), 97.0]

Setting the Main zone initial volume when the unit is turned on

Sets the Main zone initial volume when the unit is turned on.

Setup menu

“Sound” > “Volume” > “Main Zone Initial Volume”

Settings

Off	Sets the level to the volume level of the unit when it last entered standby mode.
Mute	Sets the unit to mute the audio output.
-80.0 dB to +16.5 dB (0.5 dB increments) [0.5 to 97.0 (0.5 increments)]	Sets the level to the specified volume level.

Note

This setting works only when the volume level is set lower than “Main Zone Max Volume”. For details on “Main Zone Max Volume” in the “Setup” menu, see the following:

- “Setting the Main zone limit value of the volume” (p.101)

Setting the Zone2 limit value of the volume

Sets the Zone2 limit value of the volume adjusted by using such as VOLUME keys on the remote control.

Setup menu

“Sound” > “Volume” > “Zone2 Max Volume”

Setting range

-60.0 dB to +15.0 dB (5.0 dB increments), +16.5 dB [20.0 to 95.0 (5.0 increments), 97.0]

Note

This setting is available only when “Power Amp Assign” is set to “Zone 2”. For details on “Power Amp Assign” in the “Setup” menu, see the following:

- “Setting your speaker system” (p.90)

Setting the Zone2 initial volume when the Zone2 output is enabled

Sets the Zone2 initial volume when the Zone2 output is enabled.

Setup menu

“Sound” > “Volume” > “Zone2 Initial Volume”

Settings

Off	Sets the level to the volume level of the unit when it last entered standby mode.
Mute	Sets the unit to mute the audio output.
-80.0 dB to +16.5 dB (0.5 dB increments) [0.5 to 97.0 (0.5 increments)]	Sets the level to the specified volume level.

Note

- This setting is available only when “Power Amp Assign” is set to “Zone 2”. For details on “Power Amp Assign” in the “Setup” menu, see the following:
 - “Setting your speaker system” (p.90)
- This setting works only when the volume level is set lower than “Zone2 Max Volume”. For details on “Zone2 Max Volume” in the “Setup” menu, see the following:
 - “Setting the Zone2 limit value of the volume” (p.102)

Configuring the power supply settings

Setting the amount of time for the auto-standby function

Set the amount of time for the auto-standby function.

Setup menu

"ECO" > "Auto Power Standby"

Settings

Off	Does not set the unit to standby mode automatically.
5 minutes, 20 minutes	Sets the unit to standby mode when you have not operated the unit and the unit has not detected any input signal for the specified time.
2 hours, 4 hours, 8 hours, 12 hours	Sets the unit to standby mode when you have not operated the unit for the specified time.

Note

Just before the unit enters standby mode, "AutoPowerStdby" appears and then countdown starts in the front display.

Setting the use of the eco mode

You can reduce the unit's power consumption by setting the eco mode to "On". After changing the setting, be sure to press ENTER to restart the unit.

When the eco mode is enabled, you can reduce the unit's power consumption.

Setup menu

"ECO" > "ECO Mode"

Settings

Off	Disables the eco mode.
On	Enables the eco mode.

Note

- When "ECO Mode" is set to "On", the front display may become dark.
- If you want to play audio at high volume, set "ECO Mode" to "Off".

Configuring the function settings

Automatically changing the input source names displayed on the front display

Automatically changes the input source names displayed on the front display. You can select a name created by the Auto Rename function.

Setup menu

"Function" > "Input Rename"

Input sources

HDMI 1-4, AV 1-3, AUDIO 1-2

- 1 Use the cursor keys to select an input source to be renamed.**
- 2 Use the cursor keys to select "Auto".**
- 3 To change another input source name, repeat steps 1 to 2.**
- 4 Press SETUP.**

This completes the settings.

Note

When "Auto" is selected, the created name is saved even after the external device is disconnected. To reset to the default setting, switch the setting to "Manual" and then back to "Auto".

Manually changing the input source names displayed on the front display

Allows the input source names displayed on the front display to be set manually.

Setup menu

"Function" > "Input Rename"

Input sources

HDMI 1-4, AV 1-3, AUX, AUDIO 1-3, TUNER, MusicCast Link, SERVER, NET RADIO, USB

- 1 Use the cursor keys to select an input source to be renamed.**
- 2 Use the cursor keys to select "Manual" and press ENTER.**
The edit screen is displayed.
- 3 Use the cursor keys and ENTER key to edit the name, and then select "OK" and press ENTER.**

Note

- To cancel the entry, select "CANCEL".
- If you select "RESET", the default input name will be inserted into the editing area.

- 4 To change another input source name, repeat steps 1 to 3.**
- 5 Press SETUP.**

This completes the settings.

Setting input sources to be skipped when operating the INPUT knob

Set which input sources are skipped when operating the INPUT knob. You can select the desired input source quickly by using this function.

Setup menu

"Function" > "Input Skip"

Input sources

HDMI 1-4, AV 1-3, AUX, AUDIO 1-3, TUNER, NET, Bluetooth, USB

Settings

Off	Does not skip the selected input source.
On	Skips the selected input source.

Note

When using AV CONTROLLER, you cannot select the input sources set to "On" in this function.

Adjusting the brightness of the front display

Adjusts the brightness of the front display.

Setup menu

"Function" > "Dimmer"

Setting range

-4 to 0 (higher to brighten)

Note

The front display may become dark when "ECO Mode" is set to "On". For details, see the following:

- "Setting the use of the eco mode" (p.103)

Preventing accidental changes to the settings

Prevents accidental changes to the settings.

Setup menu

"Function" > "Memory Guard"

Settings

Off	Does not protect the settings.
On	Protects the settings until "Off" is selected.

Note

When "Memory Guard" is set to "On", the lock icon (🔒) is displayed on the menu screen.

Setting the unit's functions for the RED/GREEN/YELLOW/BLUE keys of the remote control

Set the unit's functions for the RED/GREEN/YELLOW/BLUE keys of the remote control.

Setup menu

"Function" > "Remote Color Key"

Settings

Default	Assigns the functions of devices connected to the unit with an HDMI cable. This setting is effective when "HDMI Control" is set to "On".
Input	Assigns the unit's input sources to each key. The assigned input sources can be set separately. Input sources HDMI 1-4, AV 1-3, AUX, AUDIO 1-3, TUNER, NET, Bluetooth, USB Default RED: HDMI2, GREEN: HDMI4, YELLOW: AV 2, BLUE: AUX
Program	Assigns the functions of sound mode to each key. RED: MOVIE GREEN: MUSIC YELLOW: STEREO BLUE: SUR.DECODE
TV Control	Assigns the functions of TV Control to each key. RED: EXIT (closes the menu on the TV) GREEN: INFO (displays information about the TV such as the resolution) YELLOW: BROADCAST (switches the TV broadcast type) BLUE: INPUT (switches the TV input) This setting is effective when "HDMI Control" is set to "On".

Note

- For details on "HDMI Control" in the "Setup" menu, see the following:
 - "Setting the use of HDMI Control" (p.96)
- To use HDMI control, you need to perform the HDMI Control link setup after connecting HDMI Control-compatible devices. For details, see the following:
 - "HDMI Control and synchronized operations" (p.142)
- HDMI Control might not work properly.

Setting the use of switching to the party mode

Enables/disables switching to the party mode.

Setup menu

"Function" > "Party Mode Set"

Settings

Disable	Disables switching to the party mode.
Enable	Enables switching to the party mode. You can turn on/off the party mode by pressing PARTY on the remote control.

Note

For details on party mode, see the following:

- "Enjoying the same source in multiple rooms (party mode)" (p.44)

Configuring the network settings

Checking the network information of the unit

Displays the network information of the unit.

Setup menu

"Network" > "Information"

Status	The connection status of the NETWORK jack
Connection	Connection method
SSID	The access point to which the unit is connected
MusicCast Network	Readiness or not for the MusicCast Network
MAC Address (Ethernet)	MAC address
MAC Address (Wi-Fi)	
IP Address	IP address
Subnet Mask	Subnet mask
Default Gateway	The IP address of the default gateway
DNS Server (P)	The IP address of the primary DNS server
DNS Server (S)	The IP address of the secondary DNS server

Setting the network connection method (Wired/Wireless)

Selects the network connection method.

Setup menu

"Network" > "Network Connection"

Choices

Wired	Select this option when you want to connect the unit to a network with a commercially-available network cable.
Wireless(Wi-Fi)	Select this option when you want to connect the unit to a network via the wireless router (access point).

Note

For details on the network connection, see the following:

- "Preparing for connecting to a network" (p.29)

Setting the network parameters automatically (DHCP)

Set the network parameters (such as IP address, Subnet Mask, and Default Gateway) automatically using a DHCP server.

Setup menu

"Network" > "IP Address" > "DHCP"

Settings

Off	Does not use a DHCP server. Configure the network parameters manually.
On	Uses a DHCP server to automatically obtain the unit's network parameters (such as IP address).

Setting the network parameters manually

Set the network parameters (such as IP address, Subnet Mask, and Default Gateway) manually.

Setup menu

"Network" > "IP Address"

1 Set "DHCP" to "Off".

2 Use the cursor keys to select a parameter type.

IP Address	Specifies an IP address.
Subnet Mask	Specifies a subnet mask.
Default Gateway	Specifies the IP address of the default gateway.
DNS Server (P)	Specifies the IP address of the primary DNS server.
DNS Server (S)	Specifies the IP address of the secondary DNS server.

3 Use the cursor keys to move the edit position and to select a value.

4 To set another parameter, press RETURN and repeat steps 2 to 3.

5 Press SETUP.

This completes the settings.

Setting the MAC address filter

Sets the MAC address filter to limit access to the unit from other network devices.

Note

- Operation of the AirPlay function or the DMC is not limited by this setting.
- You can specify up to 10 network devices that are permitted to access the unit.

Setup menu

"Network" > "MAC Address Filter" > "Filter"

Settings

Off	Disables the MAC address filter.
On	Enables the MAC address filter. Specify the MAC addresses of the network devices that will be permitted access to the unit.

When selecting "On"

1 Use the cursor keys to select an MAC address number.

2 Use the cursor keys to move the edit position and to select a value.

3 To specify another MAC address, press RETURN and repeat steps 1 to 2.

4 Press SETUP.

This completes the settings.

Setting the use of a Digital Media Controller

Selects whether to allow a Digital Media Controller (DMC) to control playback. A Digital Media Controller (DMC) is a device that can control other network devices through the network. When this function is enabled, you can control playback of the unit from DMCs (such as Windows Media Player 12) on the same network.

Setup menu

"Network" > "DMC Control"

Settings

Disable	Does not allow DMCs to control playback.
Enable	Allows DMCs to control playback.

Setting the use of the Network Standby function

Selects whether the unit can be turned on from other network devices (network standby).

Setup menu

"Network" > "Network Standby"

Settings

Off	Disables the network standby function.
On	Enables the network standby function. (The unit consumes more power than when "Off" is selected.)
Auto	Enables the network standby function. (If "Network Connection" is set to "Wired", the unit is set to the power saving mode when the network cable is disconnected.)



With an advanced energy saving design, this product achieves a low power consumption of not more than two watts when in Network Standby mode.

Setting the network name of the unit

Edits the network name (the unit's name on the network) displayed on other network devices.

Setup menu

"Network" > "Network Name"

- 1 Press ENTER to enter the name edit screen.**
- 2 Use the cursor keys and ENTER key to edit the name.**
- 3 Select "OK" to confirm the new name and press ENTER.**
- 4 Press SETUP.**

This completes the settings.

Setting the power interlock from the unit to MusicCast compatible devices

Selects whether turning on the power of the master device of the MusicCast network (this unit) also turns on the power of other devices of the network.

Setup menu

"Network" > "MusicCast Link Power Interlock"

Settings

Off	Disables the power interlock from the unit (MusicCast master).
On	Enables the power interlock from the unit (MusicCast master).

Updating the firmware via the network

Updates the firmware via the network. You can select "Perform Update" after the unit is ready for firmware update. You can also check the firmware version and system ID.

Setup menu

"Network" > "Network Update"

Note

- Firmware update takes about 20 minutes or more.
- If the Internet connection speed is slow, or the unit is connected to the wireless network, network update may not be possible depending on the condition of the network. In this case, wait until firmware update is ready, or update the firmware using the USB memory device. For details on using the USB memory device, see the following:
 - "Updating the firmware (UPDATE)" (p.116)

Configuring the Bluetooth® settings

Setting the use of Bluetooth®

Enables/disables the Bluetooth function.

Setup menu

"Bluetooth" > "Bluetooth"

Settings

Off	Disables the Bluetooth function.
On	Enables the Bluetooth function.

Terminating the connection between a Bluetooth® device and the unit

Terminates the Bluetooth connection between a Bluetooth device (such as a smartphone) and the unit.

Setup menu

"Bluetooth" > "Audio Receive" > "Disconnect"

Select "Disconnect" and press ENTER to terminate the Bluetooth connection.

Note

This setting is not available when no Bluetooth devices are connected.

Setting the use of the Bluetooth® Standby function

Selects whether to enable/disable the function that turns on the unit from Bluetooth devices (Bluetooth standby). If this function is set to "On", the unit automatically turns on when a connect operation is performed on the Bluetooth device.

Setup menu

"Bluetooth" > "Audio Receive" > "Bluetooth Standby"

Settings

Off	Disables the Bluetooth standby function.
On	Enables the Bluetooth standby function. (The unit consumes more power than when "Off" is selected.)

Note

This setting is not available when "Network Standby" is set to "Off". For details, see the following:

- "Setting the use of the Network Standby function" (p.109)

Configuring the language settings

Setting the on-screen menu language

Select the on-screen menu language.

Setup menu

"Language"

Settings

English	English
日本語	Japanese
Français	French
Deutsch	German
Español	Spanish
Русский	Russian
Italiano	Italian
中文	Chinese

Note

The information on the front display is provided in English only.

Configuring the advanced settings (ADVANCED SETUP menu)

Basic operation of the ADVANCED SETUP menu

Perform the following basic procedure to operate the “ADVANCED SETUP” menu while viewing the front display.

- 1 Set the unit to standby mode.**
- 2 While holding down STRAIGHT on the front panel, press  (power).**

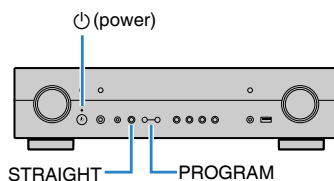

The top item and its setting of the “ADVANCED SETUP” menu appear on the front display.

- 3 Press PROGRAM to select an item.**
- 4 Press STRAIGHT to select a setting.**
- 5 Press  (power) to set the unit to standby mode and turn it on again.**

This completes the settings.

Note

For details on the default settings, see the following:

- “Default settings of the ADVANCED SETUP menu” (p.152)

ADVANCED SETUP menu items

Use the following table to configure system settings of the unit.

Item	Function	Page
SP IMP.	Changes the speaker impedance setting.	p.114
REMOTE ID	Selects the unit's remote control ID.	p.114
TU	(Asia, Taiwan, and Central and South America models only) Changes the FM/AM tuning frequency setting.	p.114
TV FORMAT	Switches the video signal type of HDMI output.	p.114
4K MODE	Selects the HDMI 4K signal format.	p.115
BKUP/RSTR	Backups and restores all the settings for the unit.	p.115
INIT	Restores the default settings.	p.116
UPDATE	Updates the firmware.	p.116
VERSION	Checks the version of firmware currently installed on the unit.	p.116

Changing the speaker impedance setting (SP IMP.)

SP IMP. •• 8ΩMIN

Change the unit's speaker impedance settings depending on the impedance of the speakers connected.

ADVANCED SETUP menu

"SP IMP."

Settings

6 Ω MIN	Select this option when you connect 6-ohm speakers to the unit.
8 Ω MIN	Select this option when you connect 8-ohm or higher speakers to the unit.

Selecting the remote control ID (REMOTE ID)

REMOTE ID •• ID1

Change the unit's remote control ID so that it matches the remote control's ID (default: ID1). When using multiple Yamaha AV receivers, you can set each remote control with a unique remote control ID for its corresponding receiver.

ADVANCED SETUP menu

"REMOTE ID"

Settings

ID1, ID2

Changing the remote control ID of the remote control

- To select ID1, while holding down the left cursor key, hold down SCENE (BD/DVD) for 5 seconds.
- To select ID2, while holding down the left cursor key, hold down SCENE (TV) for 5 seconds.

Changing the FM/AM tuning frequency setting (TU)

(Asia, Taiwan, and Central and South America models only)

TU •••• FM50/AM9

Change the FM/AM tuning frequency setting of the unit depending on your country or region.

ADVANCED SETUP menu

"TU"

Settings

FM100/AM10	Select this when you want to adjust the FM frequency by 100-kHz steps and AM by 10-kHz steps.
FM50/AM9	Select this when you want to adjust the FM frequency by 50-kHz steps and AM by 9-kHz steps.

Switching the video signal type (TV FORMAT)

TV FORMAT • NTSC

Switch the video signal type of HDMI output so that it matches to the format of your TV. Since the unit automatically selects the video signal type so that it matches to the TV, it is unnecessary to change the setting normally. Change the setting only when images on the TV screen do not appear correctly.

ADVANCED SETUP menu

"TV FORMAT"

Settings

NTSC, PAL

Selecting the HDMI 4K signal format (4K MODE)

4K MODE • MODE 1

Selects the format of signals input/output at the unit when HDMI 4K compatible TV and playback device are connected to the unit.

ADVANCED SETUP menu

"4K MODE"

Settings

MODE 1	Inputs/outputs 4K signals shown in the following table. Depending on the connected device or HDMI cables, video may not be displayed correctly. In this case, select "MODE 2".
MODE 2	Inputs/outputs 4K signals shown in the following table.

Note

When "MODE 1" is selected, use a Premium High Speed HDMI Cable or Premium High Speed Cable with Ethernet.

Format

		MODE 1			MODE 2		
		8 bit	10 bit	12 bit	8 bit	10 bit	12 bit
4K/60, 50 Hz	RGB 4:4:4	✓		–			–
	YCbCr 4:4:4	✓		–			–
	YCbCr 4:2:2		✓				–
	YCbCr 4:2:0		✓		✓		–
4K/30, 25, 24 Hz	RGB 4:4:4		✓		✓		–
	YCbCr 4:4:4		✓		✓		–
	YCbCr 4:2:2		✓			✓	

Backuping and restoring all the settings (BKUP/RSTR)

BKUP/RSTR • BKUP

Backups and restores all the unit's setting to a USB memory device. Prepare a USB memory device using FAT16 or FAT32 format in advance.

ADVANCED SETUP menu

"BKUP/RSTR"

Settings

RSTR	Restores all the previous backedup settings.
BKUP	Backups all the settings.

- 1 Connect the USB memory device to the USB jack on the front panel.
- 2 To start the process, press STRAIGHT to select "BKUP" or "RSTR" and then press INFO on the front panel.
- 3 Press INFO again after the confirmation message appears on the front display.
- 4 When "Complete" appears on the front display, press  (power) to set the unit to standby mode and turn it on again.

If "Failed" appears on the front display, check the following and start the process again.

In case of “BKUP”:

- You cannot save by overwriting. If you save the settings repeatedly, please move the file in different folder.
- The file is stored by the name of “MC_backup_(model name).dat” in the route of the USB memory device.

In case of “RSTR”:

- Check that the file is stored in the route of the USB memory device.

Note

- “RSTR” is effective after backuping all the settings.
- Do not turn off the unit during the backuping and restoring process. Otherwise, the settings may not be restored correctly.
- The user information (such as account, password) is not saved.

Restoring the default settings (INIT)



Restores the default settings for the unit.

ADVANCED SETUP menu

“INIT”

Choices

ALL	Restores the default settings for the unit.
CANCEL	Does not perform an initialization.

Updating the firmware (UPDATE)



New firmware that provides additional features or product improvements will be released as needed. Updates can be downloaded from our website to a USB memory device. You can update the firmware using this USB memory device. For details, refer to the information supplied with updates.

ADVANCED SETUP menu

“UPDATE”

Choices

USB	Update the firmware using a USB memory device.
NETWORK	Update the firmware via the network.

Note

Do not perform this menu unless firmware update is necessary. Also, make sure you read the information supplied with updates before updating the firmware.

Checking the firmware version (VERSION)



Check the version of firmware currently installed on the unit.

ADVANCED SETUP menu

“VERSION”

TROUBLESHOOTING

When any problem appears

If trouble occurs, first check the following:

Make sure of the following when the unit does not function properly.

- The power cables of the unit, TV and playback devices (such as BD/DVD players) are connected to AC wall outlets securely.
- The unit, subwoofer, TV and playback devices (such as BD/DVD players) are turned on.
- The connectors of each cable are securely inserted in to jacks on each device.

If there is no problem with the power and cables, refer to the instructions shown in "When any problem appears" corresponding to the trouble of the unit.

If the problem you are experiencing is not listed or if the instructions do not help, turn off the unit, disconnect the power cable, and contact the nearest authorized Yamaha dealer or service center.

Power, system, or remote control trouble

■ The power does not turn on

- **The protection circuitry has been activated three times consecutively.**
If the standby indicator on the unit blinks when you try to turn on the power, as a safety precaution, capability to turn on the power is disabled. Contact your nearest Yamaha dealer or service center to request repair.

■ The power does not turn on in synchronization with the TV

- **HDMI Control on the unit is disabled.**
If turning off the unit is not synchronized to the TV either, check the setting of HDMI Control on the unit. For details on HDMI Control, see the following:
 - "Setting the use of HDMI Control" (p.96)
- **HDMI Control on the TV is disabled.**
If only turning on the unit is not synchronized to the TV, check the setting on the TV. For details, refer to the instruction manual for the TV and set HDMI Control on the TV.
- **Because of a power failure, the unit's power is no longer synchronized.**
Disconnect the HDMI cables and power cables, and after five minutes, reconnect the cables of playback devices first, then the unit, and then the TV. Then, check that the power is synchronized.

■ The power does not turn off

- **The internal microcomputer has frozen, due to an external electric shock (such as lightning or excessive static electricity) or to a drop in the power supply voltage.**
Hold down ⏻ (power) on the front panel for more than 15 seconds to reboot the unit. If the problem persists, disconnect the power cable from the AC wall outlet and plug it again.

■ The power turns off (standby mode) immediately

- **The unit was turned on while a speaker cable was shorted.**

Twist the bare wires of each speaker cable firmly and reconnect to the unit and speakers. For details, see the following:

 - “Connecting the speaker” (p.18)

■ The unit enters standby mode automatically

- **The sleep timer worked.**

Turn on the unit and start playback again.
- **The auto-standby function activated because the unit was not used for the specified time.**

To disable the auto-standby function, set “Auto Power Standby” in the “Setup” menu to “Off”. For details, see the following:

 - “Setting the amount of time for the auto-standby function” (p.103)
- **The speaker impedance setting is incorrect.**

Set the speaker impedance to match your speakers. For details, see the following:

 - “Changing the speaker impedance setting (SP IMP.)” (p.114)
- **The protection circuitry has been activated because of a short circuit.**

Twist the bare wires of each speaker cable firmly and reconnect to the unit and speakers. For details, see the following:

 - “Connecting the speaker” (p.18)

■ The unit is not reacting

- **The internal microcomputer is frozen, due to an external electric shock (such as lightning or excessive static electricity) or to a drop in the power supply voltage.**

Hold down ⏻ (power) on the front panel for more than 15 seconds to reboot the unit. If the problem persists, disconnect the power cable from the AC wall outlet and plug it again.

■ The unit cannot be controlled using the remote control

- **The unit is out of the operating range.**

Use the remote control within the operating range. For details, see the following:

 - “Operating range of the remote control” (p.8)
- **The batteries are weak.**

Replace with new batteries.
- **The unit’s remote control sensor is exposed to direct sunlight or strong lighting.**

Adjust the lighting angle, or reposition the unit.
- **The remote control IDs of the unit and the remote control are not identical.**

Change the remote control ID of the unit or the remote control. For details, see the following:

 - “Selecting the remote control ID (REMOTE ID)” (p.114)
- **The remote control is set to the Zone2 operation mode.**

Set the remote control to the Main zone operation mode. For details, see the following:

 - “Part names and functions of the remote control” (p.15)

■ Cannot select the desired input source even if INPUT knob is turned

- **The function which skips some input sources is set.**
Set "Input Skip" of the desired input source in the "Setup" menu to "Off". For details, see the following:
 - "Setting input sources to be skipped when operating the INPUT knob" (p.105)

■ The RED/GREEN/YELLOW/BLUE keys of the remote control do not operate

- **The device which is connected to the unit via HDMI does not support the operation of the RED/GREEN/YELLOW/BLUE keys.**
Use a device which supports the operation of the RED/GREEN/YELLOW/BLUE keys.
- **The settings of the RED/GREEN/YELLOW/BLUE keys of the unit's remote control have been changed.**
Set the "Remote Color Key" settings in the "Setup" menu to "Default". For details, see the following:
 - "Setting the unit's functions for the RED/GREEN/YELLOW/BLUE keys of the remote control" (p.106)

Audio trouble

■ No sound

- **Another input source is selected.**
Select an appropriate input source with the input selection keys. For details, see the following:
 - "Basic procedure for playing back video and music" (p.45)
- **Signals that the unit cannot reproduce are being input.**
Some digital audio formats cannot be played back on the unit. Ensure that the signals are types that the unit is able to play back. For details on supported file formats, HDMI audio formats or compatible decoding format, see the following:
 - "Supported file formats" (p.141)
 - "Specifications" (p.146)
- **The power of Zone2 is not turned on.**
Slide MAIN/ZONE 2 switch to "ZONE 2", and then press  (receiver power) to the power of Zone2 turns on. For details, see the following:
 - "Controlling Zone2" (p.44)
- **The cable connecting the unit and playback device is defective.**
If there is no problem with the connection, replace with another cable.

■ The volume cannot be increased

- **The Main zone maximum volume is set too low.**
Use "Main Zone Max Volume" in the "Setup" menu to adjust the maximum volume. For details, see the following:
 - "Setting the Main zone limit value of the volume" (p.101)
- **A device connected to the output jacks of the unit is not turned on.**
Turn on all devices connected to the output jacks of the unit.

■ No sound is coming from a specific speaker

- **The playback source does not contain a signal for the channel.**

To check it, use “Signal Information” in the “Option” menu. For details, see the following:

 - “Checking information about the video/audio signals” (p.80)
- **The currently selected sound program/decoder does not use the speaker.**

To check it, use “Test Tone” in the “Setup” menu. For details, see the following:

 - “Outputting test tones” (p.95)
- **Audio output of the speaker is disabled.**

Perform YPAO or use “Configuration” in the “Setup” menu to change the speaker settings. For details, see the following:

 - “Optimizing the speaker settings automatically (YPAO)” (p.33)
 - “Setting the use of a subwoofer” (p.90)
 - “Setting the size of the front speakers” (p.91)
 - “Setting the use of a center speaker and its size” (p.91)
 - “Setting the use of surround speakers and their size” (p.92)
- **The volume of the speaker is set too low.**

Perform YPAO or use “Level” in the “Setup” menu to adjust the speaker volume. For details, see the following:

 - “Optimizing the speaker settings automatically (YPAO)” (p.33)
 - “Adjusting the volume of each speaker” (p.94)
- **The speaker cable connecting the unit and the speaker is defective.**

Check the unit’s SPEAKERS terminals and the speaker’s terminals. If there is no problem with the connection, replace a breaking speaker cable with another speaker cable.
- **The speaker is malfunctioning.**

To check it, replace with another speaker. If the problem persists with using another speaker, the unit may be malfunctioning.

■ No sound is coming from the subwoofer

- **The playback source does not contain Low Frequency Effect (LFE) or low-frequency signals.**

To check it, set “Extra Bass” in the “Setup” menu to “On”, in order to output the front channel low-frequency components from the subwoofer. For details, see the following:

 - “Setting the use of Extra Bass” (p.93)
- **Subwoofer output is disabled.**

Perform YPAO or set “Subwoofer” in the “Setup” menu to “Use”. For details, see the following:

 - “Optimizing the speaker settings automatically (YPAO)” (p.33)
 - “Setting the use of a subwoofer” (p.90)
- **The volume of the subwoofer is too low.**

Adjust the volume on the subwoofer.
- **The subwoofer has been turned off by its auto-standby function.**

Disable the auto-standby function of the subwoofer or adjust its sensitivity level.

■ No sound from the playback device connected to the unit with HDMI

- **The TV does not support HDCP (High-bandwidth Digital Content Protection).**

Refer to the instruction manuals for the TV and check the TV’s specifications.
- **The number of devices connected to the HDMI OUT jack exceeds the limit.**

Disconnect some of the HDMI devices.

■ No sound from the TV when HDMI Control is used

- **The TV is set to output audio from the TV speakers.**
Change the audio output setting on your TV so that the TV audio is output from the speakers connected to the unit.
- **A TV that does not support ARC is connected to the unit only with an HDMI cable.**
Use a digital optical cable to make an audio connection. For details, see the following:
 - “HDMI connection with a TV” (p.24)
- **If the TV is connected to the unit with an audio cable, the TV audio input setting does not match the actual connection.**
Use “TV Audio Input” in the “Setup” menu to select the correct audio input jack. For details, see the following:
 - “Setting the audio jack used for TV audio input” (p.97)
- **If you are trying to use ARC, ARC is disabled on the unit or TV.**
Set “ARC” in the “Setup” menu to “On”, and enable ARC on the TV. For details, see the following:
 - “Setting the use of ARC” (p.97)

■ Only the front speakers work on multichannel audio

- **The playback device is set to output 2-channel audio (such as PCM) only.**
To check it, use “Signal Information” in the “Option” menu. If necessary, change the digital audio output setting on the playback device. For details, see the following:
 - “Checking information about the video/audio signals” (p.80)

■ Noise/hum is heard

- **The unit is too close to another digital or radio frequency device.**
Move the unit further away from the device.
- **The cable connecting the unit and playback device is defective.**
If there is no problem with the connection, replace with another cable.

■ The sound is distorted

- **The volume of the unit is too high.**
Turn down the volume. If “ECO Mode” in the “Setup” menu is set to “On”, set it to “Off”. For details, see the following:
 - “Setting the use of the eco mode” (p.103)
- **A device (such as an external power amplifier) connected to the unit’s audio output jacks is not turned on.**
Turn on all devices connected to the unit’s audio output jacks.

Video trouble

■ No video

- **Another input source is selected on the unit.**
Select an appropriate input source with the input selection keys.
- **Another input source is selected on the TV.**
Switch the TV input to display the video from the unit.
- **The video signal output from the unit is not supported by the TV.**
Check the video output setting of the playback device. For information about video signals supported by the TV, refer to the instruction manuals for the TV.
- **The cable connecting the unit and TV (or playback device) is defective.**
If there is no problem with the connection, replace with another cable.

■ No video from the playback device connected to the unit with HDMI

- **The input video signal (resolution) is not supported by the unit.**
To check the information about the current video signal (resolution) and video signals supported by the unit, see the following:
 - “Checking information about the video/audio signals” (p.80)
 - “HDMI signal compatibility” (p.144)
- **The TV does not support HDCP (High-bandwidth Digital Content Protection).**
Refer to the instruction manuals for the TV and check the TV's specifications.
- **The number of devices connected to the HDMI OUT jack is over the limit.**
Disconnect some of the HDMI devices.

■ No image (contents required the HDCP 2.2 - compatible HDMI device) from the playback device

- **The TV (HDMI input jack) does not support HDCP 2.2.**
Connect the unit to the TV (HDMI input jack) that supports HDCP 2.2. (The Warning message can be displayed on the TV screen.)

■ The menu of the unit is not displayed on the TV

- **The TV is not connected to the unit via HDMI.**
You can display the menu of the unit on the TV only when they are connected with an HDMI cable. If necessary, use an HDMI cable to connect them. For details, see the following:
 - “HDMI connection with a TV” (p.24)
- **Another input source is selected on the TV.**
Switch the TV input to display the video from the unit (HDMI OUT jack).

FM/AM radio trouble (AM radio feature is not available for U.K., Europe and Australia models)

■ FM radio reception is weak or noisy

- **There is multi-path interference.**

Adjust the FM antenna height or orientation, or place it in a different location.

- **Your area is too far from the FM station transmitter.**

To select monaural FM radio reception, set "FM Mode" in the "Option" menu to "Monaural". Or use an outdoor FM antenna. For details on "FM Mode", see the following:

– "Switching between stereo and monaural for FM radio reception" (p.81)

■ AM radio reception is weak or noisy

- **The noises may be caused by fluorescent lamps, motors, thermostats, or other electrical equipment.**

It is difficult to completely eliminate noise. It may be reduced by using an outdoor AM antenna.

■ Radio stations cannot be selected automatically

- **Your area is too far from the FM station transmitter.**

Select the station manually. Or use an outdoor antenna. We recommend using a sensitive multi-element antenna. For details on selecting the station manually, see the following:

– "Selecting a frequency for reception" (p.50)

- **The AM radio signal is weak.**

Adjust the AM antenna orientation. Select the station manually. Use an outdoor AM antenna. For details on selecting the station manually, see the following:

– "Selecting a frequency for reception" (p.50)

■ AM radio stations cannot be registered as presets

- **Auto Preset has been used.**

Auto Preset is for registering FM radio stations only. Register AM radio stations manually. For details, see the following:

– "Registering a radio station manually" (p.52)

DAB radio trouble (U.K., Europe and Australia models)

■ No DAB radio reception

- **An initial scan has not been performed.**

Perform an initial scan to receive DAB radio. For details, see the following:

– "Preparing the DAB tuning" (p.54)

■ No DAB radio reception even after performing an initial scan

- **Reception strength of DAB radio is poor.**

Check reception strength in "Tune AID" in the "Option" menu, and adjust the antenna height or orientation, or place it in a different location. For details, see the following:

– "Checking reception strength of each DAB channel label" (p.58)

- **There is no DAB coverage in your area.**

Check with your dealer or WorldDMB online at "<http://www.worlddab.org>" for a listing of the DAB coverage in your area.

■ DAB radio reception is weak or noisy

- **There is multi-path interference.**

Check reception strength in “Tune AID” in the “Option” menu, and adjust the antenna height or orientation, or place it in a different location. For details, see the following:

– “Checking reception strength of each DAB channel label” (p.58)

- **Your area is too far from the DAB station transmitter.**

Use an outdoor antenna. We recommend using a sensitive multi-element antenna.

■ DAB information is not available or is inaccurate

- **The selected DAB radio station may be temporarily out of service or may not provide information.**

Contact the DAB broadcaster.

■ No DAB radio sound

- **The selected DAB radio station may be temporarily out of service.**

Try the station later or select another station.

USB trouble

■ The unit does not detect the USB device

- **The USB device is not connected to the USB jack securely.**

Turn off the unit, reconnect your USB device, and turn the unit on again.

- **The file system of the USB device is not FAT16 or FAT32.**

Use a USB device with FAT16 or FAT32 format.

■ Folders and files in the USB device cannot be viewed

- **The data in the USB device is protected by the encryption.**

Use a USB device without an encryption function.

■ The unit does not perform continuous playback on files of USB device

- **When the unit detects a series of unsupported files during playback, playback stops automatically.**

Do not save unsupported files (such as images and hidden files) in folders for playback.

Network trouble

■ The network feature does not function

- **The network parameters (IP address) have not been obtained properly.**

Enable the DHCP server function on your router and set “DHCP” in the “Setup” menu to “On” on the unit. If you want to configure the network parameters manually, check that you are using an IP address which is not used by other network devices in your network. For details, see the following:

 - “Setting the network parameters automatically (DHCP)” (p.107)
 - “Setting the network parameters manually” (p.108)
- **The unit does not support IPv6 network.**

Connect IPv4 network.

■ The unit cannot connect to the Internet via a wireless router (access point)

- **The wireless router (access point) is turned off.**

Turn on the wireless router.
- **The unit and the wireless router (access point) are too far apart.**

Place the unit and the wireless router (access point) closer to each other.
- **There is an obstacle between the unit and the wireless router (access point).**

Move the unit and the wireless router (access point) in a location where there are no obstacles between them.
- **The wireless router (access point) is set to use the wireless channel 14.**

Change settings of the wireless router (access point) to use one of the wireless channels from 1 to 13.

■ Wireless network is not found

- **Microwave ovens or other wireless devices in your neighborhood might disturb the wireless communication.**

Turn off these devices.
- **Access to the network is restricted by the firewall settings of the wireless router (access point).**

Check the firewall setting of the wireless router (access point).

■ The unit does not detect the media server (PC/NAS)

- **The media sharing setting is not correct.**

Configure the sharing setting and select the unit as a device to which music contents are shared. For details, see the following:

 - “Media sharing setup on media servers (PCs/NAS)” (p.66)
- **Some security software installed on your media server is blocking the access of the unit to your media server.**

Check the settings of security software installed on your media server.
- **The unit and media server are not in the same network.**

Check the network connections and your router settings, and then connect the unit and the media server to the same network.
- **The MAC address filter is enabled on the unit.**

In “MAC Address Filter” in the “Setup” menu, disable the MAC address filter or specify the MAC address of your media server to allow it to access to the unit. For details, see the following:

 - “Setting the MAC address filter” (p.108)

■ The files in the media server (PC/NAS) cannot be viewed or played back

- **The files are not supported by the unit or the media server.**

Use the file format supported by both the unit and the media server. For information about the file formats supported by the unit, see the following:

 - “Supported file formats” (p.141)

■ The Internet radio cannot be played

- **The selected Internet radio station is currently not available.**

There may be a network problem at the radio station, or the service may have been stopped. Try the station later or select another station.

- **The selected Internet radio station is currently broadcasting silence.**

Some Internet radio stations broadcast silence at certain of times of the day. Try the station later or select another station.

- **Access to the network is restricted by the firewall settings of your network devices (such as the router).**

Check the firewall settings of your network devices. The Internet radio can be played only when it passes through the port designated by each radio station. The port number varies depending on the radio station.

■ The iPhone does not recognize the unit when using AirPlay

- **The unit is connected to a multiple SSID router.**

Access to the unit might be restricted by the network separation function on the router. Connect the iPhone to the SSID which can access the unit. (Connect it to the Primary SSID at the top of the list.)

■ The application for mobile devices does not detect the unit

- **The unit and mobile device are not in the same network.**

Check the network connections and your router settings, and then connect the unit and mobile device to the same network.

- **The MAC address filter is enabled on the unit.**

In "MAC Address Filter" in the "Setup" menu, disable the MAC address filter or specify the MAC address of your mobile device to allow it to access to the unit. For details, see the following:

– "Setting the MAC address filter" (p.108)

- **The unit is connected to a multiple SSID router.**

Access to the unit might be restricted by the network separation function on the router. Connect the iPhone to the SSID which can access the unit. (Connect it to the Primary SSID at the top of the list.)

■ Firmware update via the network is failed

- **It may not be possible depending on the condition of the network.**

Update the firmware via the network again or use a USB memory device. For details, see the following:

– "Updating the firmware via the network" (p.110)

Bluetooth® trouble

■ A Bluetooth® connection cannot be established

- **The Bluetooth function of the unit is disabled.**
Enable the Bluetooth function. For details, see the following:
 - “Setting the use of Bluetooth®” (p.111)
- **Another Bluetooth device is already connected to the unit.**
Terminate the current Bluetooth connection and then establish a new connection.
For details, see the following:
 - “Playback Bluetooth® device music on the unit” (p.63)
- **The unit and the Bluetooth device are too far apart.**
Move the Bluetooth device closer to the unit.
- **There is a device (such as microwave oven and wireless LAN) that outputs signals in the 2.4 GHz frequency band nearby.**
Move the unit and the Bluetooth device away from those devices.
- **The Bluetooth device does not support A2DP.**
Use a Bluetooth device that supports A2DP.
- **The connection information registered on the Bluetooth device is not working for some reason.**
Delete the connection information on the Bluetooth device, and then establish a connection between the Bluetooth device and the unit again. For details, see the following:
 - “Playback Bluetooth® device music on the unit” (p.63)

■ No sound is produced, or the sound is interrupted during playback with Bluetooth® connection

- **The volume of the Bluetooth device is set too low.**
Turn up the volume of the Bluetooth device.
- **The Bluetooth device is not set to send audio signals to the unit.**
Switch the audio output of the Bluetooth device to the unit.
- **The Bluetooth connection has been terminated.**
Establish a Bluetooth connection between the Bluetooth device and the unit again.
For details, see the following:
 - “Playback Bluetooth® device music on the unit” (p.63)
- **The unit and the Bluetooth device are too far apart.**
Move the Bluetooth device closer to the unit.
- **There is a device (such as microwave oven and wireless LAN) that outputs signals in the 2.4 GHz frequency band nearby.**
Move the unit and the Bluetooth device away from those devices.

Error indications on the front display

Error indications on the front display

Refer to the following table when the error message is indicated on the front display.

Message	Cause	Remedy
Access denied	Access to the media servers (PCs/NAS) is denied.	Configure the sharing settings and select the unit as a device to which music contents are shared. For details, see the following: <ul style="list-style-type: none"> “Media sharing setup on media servers (PCs/NAS)” (p.66)
Access error	The unit cannot access the USB device.	Turn off the unit and reconnect your USB device. If the problem persists, try another USB device.
	There is a problem with the signal path from the network to the unit.	Make sure your router and modem are turned on, and check the connection between the unit and your router (or hub). For details, see the following: <ul style="list-style-type: none"> “Connecting a network cable (wired connection)” (p.29) “Preparing wireless antennas (wireless connection)” (p.30)
Check SP Wires	The speaker cables are short circuited.	Twist the bare wires of the cables firmly and connect to the unit and speakers properly. For details, see the following: <ul style="list-style-type: none"> “Connecting the speaker” (p.18)
Internal Error	An internal error has occurred.	Contact the nearest authorized Yamaha dealer or service center.
No content	There are no playable files in the selected folder.	Select a folder that contains files supported by the unit.
No device	The unit cannot detect the USB device.	Turn off the unit and reconnect your USB device. If the problem persists, try another USB device.
Not connected	The network cable is not connected.	Connect the network cable properly.
	The wireless router (access point) is not found.	Make sure the wireless router (access point) is turned on.
Please wait	The unit is preparing for connecting to the network.	Wait until the message disappears. If the message stays more than 3 minutes, turn off the unit and turn it on again.
RemID Mismatch	The remote control IDs of the unit and the remote control are not identical.	Change the remote control ID of the unit or the remote control. For details, see the following: <ul style="list-style-type: none"> “Selecting the remote control ID (REMOTE ID)” (p.114)
Unable to play	The unit cannot play back the songs stored on the iPhone for some reason.	Check the song data. If it cannot be played on the iPhone itself, the song data or storage area may be defective.
	The unit cannot play back the songs stored on the media servers (PCs/NAS) for some reason.	Ensure that the files are types that the unit is able to play back. If the unit supports the file format, but still cannot play back any files, the network may be overloaded with heavy traffic. For information about the formats supported by the unit, see the following: <ul style="list-style-type: none"> “Supported file formats” (p.141)
USB Overloaded	An overcurrent is flowing through the USB device.	Turn off the unit and reconnect your USB device. If the problem persists, try another USB device.
Version error	Firmware update failed.	Update the firmware again. For details, see the following: <ul style="list-style-type: none"> “Updating the firmware (UPDATE)” (p.116) “Updating the unit’s firmware via the network” (p.131)

Message	Cause	Remedy
Update failed.	Firmware update failed.	<p>Press STRAIGHT and select a firmware updating method, then press INFO to update the firmware again. For details, see the following:</p> <ul style="list-style-type: none"> • “Updating the firmware (UPDATE)” (p.116) • “Updating the unit’s firmware via the network” (p.131)
FILE NOT READY	Preparation for firmware update is not finish yet.	Wait a while before updating the firmware again.

APPENDIX

Updating the unit's firmware via the network

Firmware updates

New firmware that provides additional features or product improvements will be released as needed. If the unit is connected to the Internet, new firmware is downloaded via the network. When a firmware update is ready, the following message appears after SETUP is pressed.

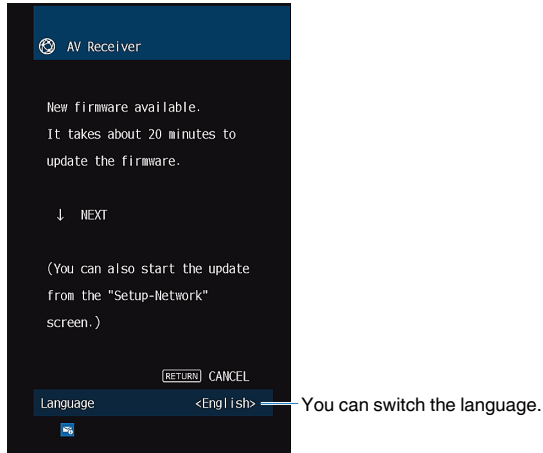

For details on the firmware update, see the following:

- "Updating the unit's firmware via the network" (p.131)

Notice

- Do not operate the unit or disconnect the power cable or network cable during firmware update. If the firmware update is interrupted, there is a possibility that the unit will malfunction. In this case, contact your nearest authorized Yamaha dealer or service center to request repair.

Note

- The firmware update indicator on the front display lights up when a firmware update is ready. This indicator might not light up when the network connection speed is too slow or a later firmware update is available.
- Firmware update takes about 20 minutes or more.
- You might not get the message or the lighting up firmware update indicator on the front display depending on the condition of the network connection. In this case, update the firmware using the USB memory device. For details, see the following:
 - "Updating the firmware (UPDATE)" (p.116)
- For details on firmware updates, visit the Yamaha website.

Updating the unit's firmware via the network

Confirm the on-screen description displayed after SETUP is pressed, and start the firmware update.

1 Read the on-screen description and press the down cursor key.

The next screen appears.

2 To start the firmware update, press ENTER.

The on-screen display turns off.

3 If "UPDATE SUCCESS PLEASE POWER OFF!" appears on the front display, press (power) on the front panel.

The firmware update is complete.

Note

- Firmware update takes about 20 minutes or more.
- You might not get the message or the lighting up firmware update indicator on the front display depending on the condition of the network connection. In this case, update the firmware using the USB memory device. For details on using the USB memory device, see the following:
 - "Updating the firmware (UPDATE)" (p.116)
- For details on update, visit the Yamaha website.
- If you want to perform update when turning off the unit, press not ENTER but the down cursor key in step 2, and follow the on screen instructions. When you turn off the unit, a screen asking you to confirm the firmware update is displayed, and press ENTER to start the firmware update. After the firmware update is complete, the unit will turn off automatically.
- To perform update when turning off the unit, refer to the following instructions and supplementary explanations.
 - The firmware update can be started by pressing INFO on the front panel.
 - The unit turns off automatically without performing the firmware update if two minutes pass after the screen to confirm the firmware update is displayed.
 - To cancel the firmware update process, press RETURN, and the unit will turn off.
 - The unit turns off without performing the firmware update if you turn off the unit with AV CONTROLLER or MusicCast CONTROLLER.

Connecting to a network wirelessly

Selecting a wireless network connection method

Select a wireless connection method according to your network environment.

Note

- You need to configure the network settings if your router does not support DHCP or if you want to configure the network parameters manually. For details, see the following:
 - “Setting the network parameters manually” (p.108)
- When the unit is added to a MusicCast network, the network settings can be configured at the same time. If you use MusicCast, this method is recommended. For details, see the following:
 - “Adding the unit to the MusicCast network” (p.37)

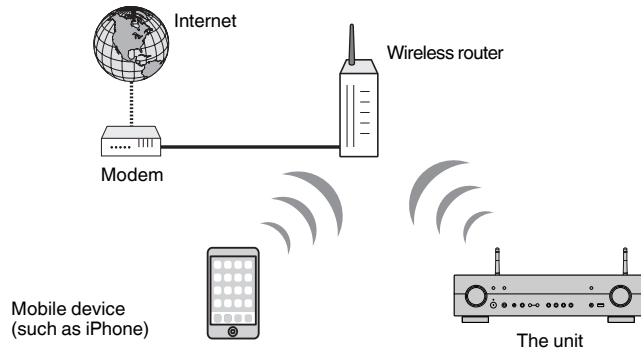

- 1** Press  (receiver power) to turn on the unit.
- 2** Turn on the TV and switch the TV input to display video from the unit (HDMI OUT jack).
- 3** Press **SETUP**.
- 4** Use the cursor keys to select “Network” and press **ENTER**.
- 5** Use the cursor keys to select “Network Connection” and press **ENTER**.
- 6** Use the cursor keys to select “Wireless(Wi-Fi)” and press **ENTER**.

The following connection methods are available.

- “Setting up a wireless connection using the WPS button” (p.133)
- “Setting up a wireless connection using an iOS device” (p.133)
- “Setting up a wireless connection by selecting from the list of available access points” (p.134)
- “Setting up a wireless connection manually” (p.135)
- “Setting up a wireless connection by using the WPS PIN code” (p.136)

Setting up a wireless connection using the WPS button

You can easily set up a wireless connection with one push of the WPS button.

Setup menu

"Network" > "Network Connection" > "Wireless(Wi-Fi)"

- 1 Use the cursor keys to select "WPS Button" and press ENTER.
- 2 Read the on-screen description and push the WPS button on the wireless router (access point).

When the connection process finishes, "Completed" appears on the front display.

If "Not connected" appears, repeat from step 1 or try another connection method.

This completes the network settings.

Note

- The unit may not connect to the wireless router (access point) using WEP as the encryption method. In this case, try another connection method.
- You can use INFO (WPS) on the front panel. Hold down INFO (WPS) for a few seconds to set up a wireless connection and then "Press WPS button on Access Point" appears on the front display, push the WPS button.

About WPS

- WPS (Wi-Fi Protected Setup) is a standard established by the Wi-Fi Alliance, which allows easy establishment of a wireless home network.

Setting up a wireless connection using an iOS device

You can set up a wireless connection by applying the connection settings on iOS devices (iPhone/iPad/iPod touch).

Before proceeding, confirm that your iOS device is connected to a wireless router.

Note

- This process will restore the default settings for the following.
 - Network settings
 - Bluetooth settings
 - Bluetooth, USB, media server and network content registered as shortcuts
 - Internet radio stations registered to "Favorites"
 - Account information for the network services
- You need iOS device with iOS 7 or later. (The following procedure is a setup example for iOS 10.)
- This configuration does not work if the security method of your wireless router (access point) is WEP. In this case, use other connection method.

Setup menu

"Network" > "Network Connection" > "Wireless(Wi-Fi)"

- 1 Use the cursor keys to select "WAC(iOS)" and press ENTER.
- 2 Read the on-screen description and press ENTER.

Note

When you use wired network connection, a warning message is displayed on the screen. Disconnect the network cable from the unit, and then press ENTER.

- 3 On the iOS device, select the unit as the AirPlay speaker in the Wi-Fi screen.

iOS 10 (example of English version)

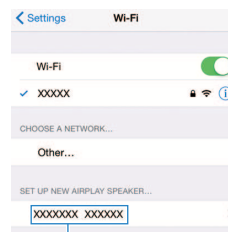

The name of the unit

4 Select the network (access point) of which you want to share the settings with the unit.

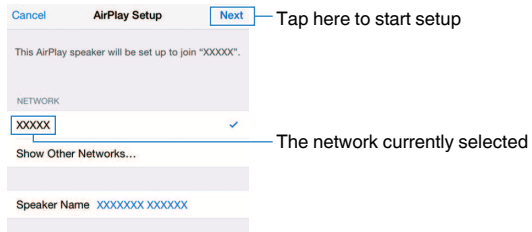

When the sharing process finishes, the unit is automatically connected to the selected network (access point) and “Completed” appears on the front display.

If “Not shared” or “Not connected” appears, press ENTER to repeat from step 1 or try another connection method.

5 Press SETUP.

This completes the network settings.

Setting up a wireless connection by selecting from the list of available access points

You can set up a wireless connection by selecting an access point from the list of wireless LAN routers (access points) found by the unit. You need to manually enter the security key.

Setup menu

“Network” > “Network Connection” > “Wireless(Wi-Fi)”

1 Use the cursor keys to select “Access Point Scan” and press ENTER.

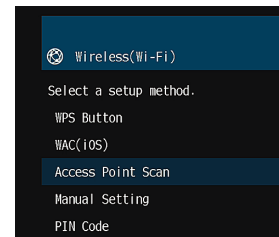

After searching for access points, the list of available access points appears on the TV.

2 Use the cursor keys to select the desired access point and press ENTER.

The wireless connection setting screen appears on the TV.

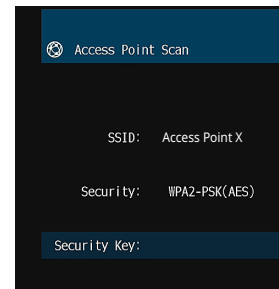

3 Press ENTER.

The edit screen appears.

4 Use the cursor keys and ENTER to enter the security key.

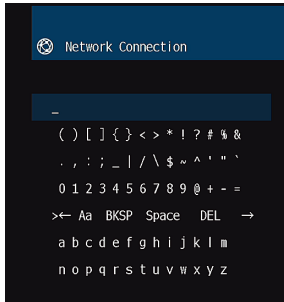

5 When finished entering the key, use the cursor keys to select “OK” and press ENTER.

The previous wireless connection setting screen appears on the TV.

6 Use the cursor keys to select “Connect” and press ENTER to start the connection process.

When the connection process finishes, “Completed” appears on the TV screen.

If “Not connected” appears, repeat from step 2 or try another connection method.

7 Press SETUP.

This completes the network settings.

Setting up a wireless connection manually

You can set up a wireless connection by entering the required information manually. You need to set up the SSID (network name), encryption method and security key for your network.

Setup menu

“Network” > “Network Connection” > “Wireless(Wi-Fi)”

1 Use the cursor keys to select “Manual Setting” and press ENTER.

The manual setting screen appears.

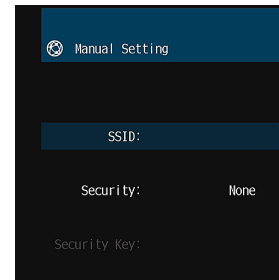

2 Use the cursor keys to select “SSID” and press ENTER.

The edit screen appears.

3 Use the cursor keys and ENTER to enter the SSID of the access point.

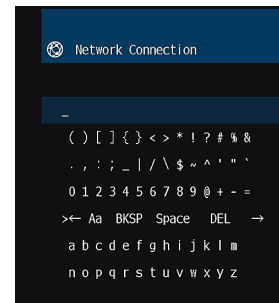

4 When finished entering the key, use the cursor keys to select “OK” and press ENTER.

The previous manual setting screen appears on the TV.

5 Use the cursor keys to select “Security” and select the encryption method.

Choices

None, WEP, WPA-PSK(AES), Mixed Mode

Note

If you select “None”, the connection may be insecure since the communication is not encrypted.

6 Use the cursor keys to select “Security Key” and press ENTER.

The edit screen appears.

Note

If you select “None” in step 5, this item is not available.

7 Use the cursor keys and ENTER to enter the security key.

8 When finished entering the key, use the cursor keys to select “OK” and press ENTER.

The previous manual setting screen appears on the TV.

9 Use the cursor keys to select “Connect” and press ENTER to start the connection process.

When the connection process finishes, “Completed” appears on the TV screen.

If “Not connected” appears, check that all the information is entered correctly, and repeat from step 2.

10 Press SETUP.

This completes the network settings.

Setting up a wireless connection by using the WPS PIN code

You can set up a wireless connection by entering the unit’s PIN code into the wireless router (access point). The method is available if the wireless router (access point) supports the WPS PIN code method.

Setup menu

“Network” > “Network Connection” > “Wireless(Wi-Fi)”

1 Use the cursor keys to select “PIN Code” and press ENTER.

The list of available access points appears on the TV.

2 Use the cursor keys to select the desired access point and press ENTER.

The PIN code of the unit appears on the TV screen.

3 Enter the unit’s PIN code into the wireless router (access point).

For details on settings, refer to the instruction manual of the wireless router (access point).

4 Press ENTER to start the connection process.

When the connection process finishes, “Completed” appears on the TV screen.

If “Not connected” appears, repeat from step 2 or try another connection method.

5 Press SETUP.

This completes the network settings.

Input/output jacks and cables

Video/audio jacks

HDMI jacks

Transmit digital video and digital sound through a single jack. Use an HDMI cable.



Note

- Use a 19-pin HDMI cable with the HDMI logo. We recommend using a cable less than 5.0 m (16.4 ft) long to prevent signal quality degradation.
- The unit's HDMI jacks support the HDMI Control, Audio Return Channel (ARC), and 3D and 4K Ultra HD video transmission (through output) features.
- Use a Premium High Speed HDMI Cable or Premium High Speed Cable with Ethernet to enjoy 3D or 4K Ultra HD videos.

Video jacks

VIDEO jacks

Transmit analog video signals. Use a video pin cable.

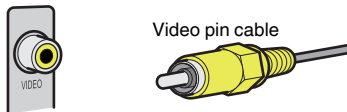

Audio jacks

OPTICAL jack

Transmit digital audio signals. Use a digital optical cable. If there is a protective cap on the tip of the cable, remove it before using the cable.



COAXIAL jacks

Transmit digital audio signals. Use a digital coaxial cable.



AUDIO jacks

Transmit analog stereo audio signals.

(Stereo L/R jacks)

Use a stereo pin cable (RCA cable).

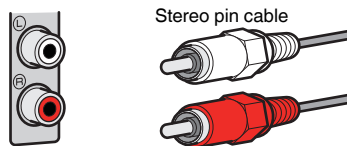

(Stereo mini jack)

Use a stereo mini-plug cable.



Glossary of audio information

Glossary of audio decoding format

This is a glossary of the technical terms related to audio decoding format used in this manual.

Dolby Digital

Dolby Digital is a compressed digital audio format developed by Dolby Laboratories, Inc. that supports 5.1-channel audio. This technology is used for audio on most DVD disc.

Dolby Digital Plus

Dolby Digital Plus is a compressed digital audio format developed by Dolby Laboratories, Inc. that supports 7.1-channel audio. Dolby Digital Plus remains fully compatible with the existing multichannel audio systems that support Dolby Digital. This technology is used for audio streaming services on the Internet and audio on BD (Blu-ray Disc).

Dolby Pro Logic II

Dolby Pro Logic II enables 5-channel playback from 2-channel sources. There are three modes available: "Music mode" for music sources, "Movie mode" for movie sources, and "Game mode" for game sources.

Dolby TrueHD

Dolby TrueHD is an advanced lossless audio format developed by Dolby Laboratories, Inc. to offer a high-definition home theater experience with the quality of the studio master. Dolby TrueHD can carry up to eight channels of 96 kHz/24-bit audio (up to six channels of 192 kHz/24-bit audio) simultaneously. This technology is used for audio on BD (Blu-ray Disc).

DTS 96/24

DTS 96/24 is a compressed digital audio format that supports 5.1-channel and 96 kHz/24-bit audio. This format remains fully compatible with the existing multichannel audio systems that support DTS Digital Surround. This technology is used for music DVDs, etc.

DTS Digital Surround

DTS Digital Surround is a compressed digital audio format developed by DTS, Inc. that supports 5.1-channel audio. This technology is used for audio on most DVD discs.

DTS Express

DTS Express is a compressed digital audio format that supports 5.1-channel audio and allows a higher compression rate than the DTS Digital Surround format developed by DTS, Inc. This technology is developed for audio streaming services on the Internet and secondary audio on BD (Blu-ray Disc).

DTS-HD High Resolution Audio

DTS-HD High Resolution Audio is a compressed digital audio format developed by DTS, Inc. that supports 7.1-channel and 96 kHz/24-bit audio. DTS-HD High Resolution Audio remains fully compatible with the existing multichannel audio systems that support DTS Digital Surround. This technology is used for audio on most BD (Blu-ray Disc).

DTS-HD Master Audio

DTS-HD Master Audio is an advanced lossless audio format developed to offer a high-definition home theater experience with the quality of the studio master by DTS, Inc. DTS-HD Master Audio can carry up to eight channels of 96 kHz/24-bit audio (up to six channels of 192 kHz/24-bit audio) simultaneously. This technology is used for audio on BD (Blu-ray Disc).

DTS Neo: 6

DTS Neo: 6 enables 6-channel playback from 2-channel sources. There are two modes available: "Music mode" for music sources and "Cinema mode" for movie sources. This technology provides discrete full-bandwidth matrix channels of surround sound.

DSD (Direct Stream Digital)

DSD (Direct Stream Digital) technology stores audio signals on digital storage media, such as SACD (Super Audio CDs). The signals are stored at a high-frequency sampling rate (such as 11.2 MHz). The highest frequency response is equal to or higher than 100 kHz, with a dynamic range of 120 dB. This technology offers better audio quality than that used for CDs.

FLAC

FLAC is a file format for lossless audio data compression. FLAC is inferior to lossy compressed audio formats in compression rate but provides higher audio quality.

MP3

One of the compressed digital audio format used by MPEG. With psychoacoustic technologies, this compression method achieves a high compression rate. Reportedly, it is capable of compressing data quantity by about 1/10 maintaining a certain level of audio quality.

MPEG-4 AAC

An MPEG-4 audio standard. It is used for mobile telephones, portable audio players, and audio streaming services on Internet because it allows a high compression rate of data while maintaining better audio quality than MP3.

PCM (Pulse Code Modulation)

PCM is a signal format under which an analog audio signal is digitized, recorded, and transmitted. This technology is the basis of all other audio format. This technology is used as a lossless audio format called Linear PCM for audio on a variety of media, including CDs.

Sampling frequency/Quantization bit

Sampling frequency and quantization bits indicate the quantity of information when an analog audio signal is digitized. These values are noted as in the following example: "48 kHz/24-bit".

- Sampling frequency
Sampling frequency (the number of times the signal is sampled per second) is called the sampling rate. When the sampling frequency is higher, the range of frequencies that can be played back are wider.
- Quantization bit
The number of quantization bits indicate the degree of accuracy when converting the sound level into a numeric value. When the number of quantized bits is higher, the expression of the sound level is more accurate.

WAV

Windows standard audio file format, which defines the method of recording the digital data obtained by converting audio signals. By default, the PCM method (no compression) is used, but you can also use other compression methods.

WMA (Windows Media Audio)

One of the compressed digital audio formats developed by Microsoft Corporation. With psychoacoustic technologies, this compression method achieves a high compression rate. Reportedly, it is capable of compressing data quantity by about 1/20 maintaining a certain level of audio quality.

Glossary of audio information other than audio decoding format

This is a glossary of the technical terms related to audio information used in this manual.

Bi-amplification connection (Bi-amp)

A bi-amplification connection uses two amplifiers for a speaker. When you use the bi-amplification connection, the unit drives the tweeter and woofer in a speaker with the discrete amplifiers. As a consequence, the tweeter and woofer provide clear audio signal without the interference.

LFE (Low Frequency Effects) 0.1 channel

This channel reproduces low-frequency bass signals and has a frequency range from 20 Hz to 120 Hz. This channel is added to the channels for all bands with Dolby Digital or DTS to enhance low frequency audio effects. This channel is labeled 0.1 because it is limited to only low frequency audio.

Lip sync

Video output sometimes lags behind audio output due to the complexity of signal processing caused by an increase in video signal capacity. Lip sync is a technique for automatically correcting the timing lag between audio and video output.

Glossary of HDMI and video information

This is a glossary of the technical terms related to HDMI and video information used in this manual.

Composite video signal

With the composite video signal system, color, brightness, and synchronization data signals are combined and transmitted with a single cable.

Deep Color

Deep Color is a technology that HDMI specification supports. Deep Color increases the number of available colors within the boundaries defined by the RGB or YCbCr color space. Conventional color systems process the color using 8 bits. Deep Color processes the color with 10, 12, or 16 bits. This technology allows HDTVs and other displays to increase from millions of colors to billions of colors and eliminate on-screen color banding for smooth tonal transitions and subtle gradations between colors.

HDMI

HDMI (High-Definition Multimedia Interface) is the world-wide standard interface for digital audio/video signal transmission. This interface transmits both digital audio and digital video signals using a single cable without any loss. HDMI complies with HDCP (High-bandwidth Digital Content Protection) and provides a secure audio/video interface. For further information on HDMI, visit the HDMI website at "<http://www.hdmi.org/>".

x.v.Color

"x.v.Color" is a technology that the HDMI specification supports. It is a more extensive color space than sRGB and allows the expression of colors that were not hitherto possible. While remaining compatible with the color gamut of sRGB standards, "x.v.Color" expands the color space, and thus can produce more vivid, natural images.

Glossary of network information

This is a glossary of the technical terms related to network information used in this manual.

SSID

SSID (Service Set Identifier) is a name that identifies a particular wireless LAN access point.

Wi-Fi

Wi-Fi (Wireless Fidelity) is a technology that allows an electronic device to exchange data or connect to the Internet wirelessly using radio waves. Wi-Fi offers the advantage of eliminating the complexity of making connections with LAN cables by using wireless connection. Only products that complete Wi-Fi Alliance interoperability tests can carry the "Wi-Fi Certified" trademark.

WPS

WPS (Wi-Fi Protected Setup) is a standard established by the Wi-Fi Alliance, which allows easy establishment of a wireless home network.

Glossary of Yamaha technologies

This is a glossary of the technical terms related to Yamaha technologies used in this manual.

CINEMA DSP (Digital Sound Field Processor)

Since the surround sound systems were originally designed for use in movie theaters, their effect is best experienced in a theater that has many speakers designed for acoustic effects. Since home conditions (such as room size, wall material, and number of speakers) can differ so widely, it is inevitable that there are differences in the sound that you hear. Based on a wealth of actually measured data, CINEMA DSP, Yamaha's original DSP technology provides the audiovisual experience of a movie theater in your own home.

CINEMA DSP 3D

The actually measured sound field data contain the information of the height of the sound images. CINEMA DSP 3D mode achieves the reproduction of the accurate height of the sound images so that it creates the accurate and intensive 3D sound fields in a listening room.

Compressed Music Enhancer

The Compressed Music Enhancer feature compensates for missing harmonics in compression music formats (such as MP3). As a result, this technology provides improved performance for the overall sound system.

SILENT CINEMA

Yamaha has developed a natural, realistic sound effect DSP algorithm for headphones. Parameters for headphones have been set for each sound program, so that accurate representations of all the sound programs can be enjoyed on headphones.

Virtual CINEMA DSP

Virtual CINEMA DSP allows the system to virtually reproduce the sound field of the surround speakers with front left and right speakers. Even if the surround speakers are not connected, the unit creates the realistic sound field in a listening room.

Virtual Presence Speaker (VPS)

Virtual Presence Speaker allows the system to virtually reproduce the height of the 3D sound field without presence speakers. Even if the presence speakers are not connected, the unit creates the 3D sound field in your room.

YPAO (Yamaha Parametric room Acoustic Optimizer)

The Yamaha Parametric room Acoustic Optimizer (YPAO) function detects speaker connections, measures the distances from them to your listening position(s), and then automatically optimizes the speaker settings, such as volume balance and acoustic parameters, to suit your room.

Supported devices and file formats

Supported Bluetooth® devices

The following Bluetooth devices can be used by the unit.

- Bluetooth devices that support A2DP can be used.
- Operation of all Bluetooth devices cannot be guaranteed.

Supported USB devices

The following USB devices can be used by the unit.

- This unit is compatible with USB memory devices that are in FAT16 or FAT32 format.
Do not connect any other type of USB devices.
- USB devices with encryption cannot be used.
- Operation of all USB devices cannot be guaranteed.

Supported AirPlay devices

AirPlay works with iPhone, iPad, and iPod touch with iOS 4.3.3 or later, Mac with OS X Mountain Lion or later, and PC with iTunes 10.2.2 or later.

Made for.

iPhone 7 Plus, iPhone 7, iPhone SE, iPhone 6s Plus, iPhone 6s, iPhone 6 Plus, iPhone 6, iPhone 5s, iPhone 5c, iPhone 5, iPhone 4s

iPad Pro (10.5"), iPad Pro (12.9") 2nd Generation, iPad Pro (12.9") 1st Generation, iPad Pro (9.7"), iPad mini 4, iPad Air 2, iPad mini 3, iPad Air, iPad mini 2, iPad mini, iPad (5th generation), iPad (4th generation), iPad (3rd generation), iPad 2

iPod touch (6th generation), iPod touch (5th generation)

(as of February 2018)

Supported file formats

The following file formats can be used by the unit.

File	Sampling frequency (kHz)	Quantization bit (bit)	Bitrate (kbps)	Number of channels	Support for gapless playback
WAV *	32/44.1/48/ 88.2/96/ 176.4/192	16/24/32	-	2	✓
MP3	32/44.1/48	-	8 to 320	2	-
WMA	32/44.1/48	-	8 to 320	2	-
MPEG-4 AAC	32/44.1/48	-	8 to 320	2	-
FLAC	32/44.1/48/ 88.2/96/ 176.4/192	16/24	-	2	✓
ALAC	32/44.1/48/ 88.2/96	16/24	-	2	✓
AIFF	32/44.1/48/ 88.2/96/ 176.4/192	16/24/32	-	2	✓
DSD	2.8 MHz/ 5.6 MHz/ 11.2 MHz	1	-	2	-

* Linear PCM format only. 32 bit-float files cannot be played back.

- The playable file formats differ depending on the software installed on media servers (PCs/NAS). Refer to the instruction manual of the server software for details.
- Digital Rights Management (DRM) contents cannot be played back.

Video signal flow

Video signal flow

Video signals input from a video device to the unit are output to a TV as follows.

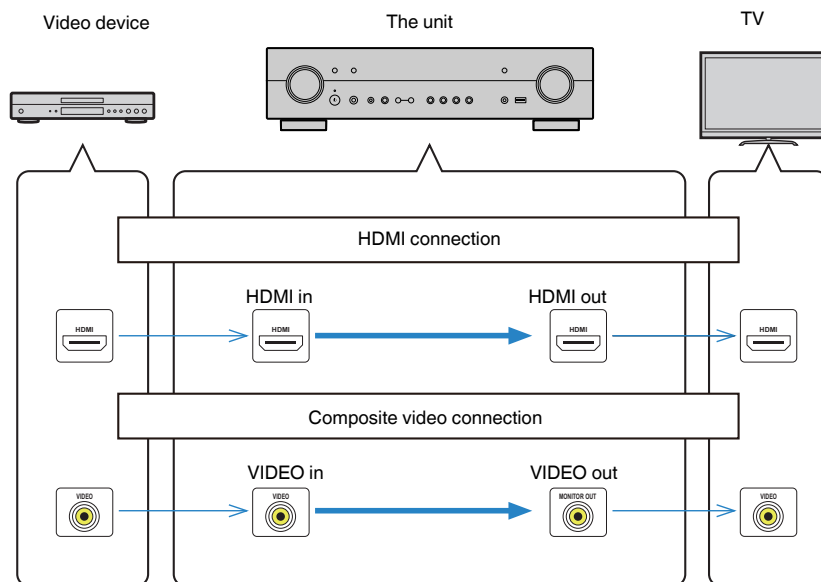

Additional information on HDMI

HDMI Control and synchronized operations

HDMI Control allows you to operate external devices via HDMI. If you connect a TV that supports HDMI Control to the unit with an HDMI cable, you can control the unit (such as power and volume) with TV remote control operations. You can also control external devices (such as HDMI Control-compatible BD/DVD players) connected to the unit with an HDMI cable.

Operations available from the TV's remote control

- Standby
- Volume control including mute
- Switching to input audio from the TV when the TV input is switched to its built-in tuner
- Switching to input video/audio from the selected playback device
- Switching between audio output devices (the unit or TV speaker)

(Example)

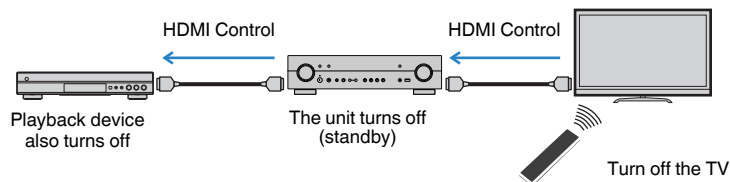

Operations available from the unit's remote control

- Starting playback on the playback device and turning on the TV with a scene selection
- Switching the TV input to display the "Setup" menu (when SETUP is pressed)
- Controlling the external device from which video is displayed on the TV (playback and menu operations)
- Controlling the TV when you select TV audio input that is set in "TV Audio Input" in the "Setup" menu
- Controlling the TV with the color (RED/GREEN/YELLOW/BLUE) keys of the remote control when "TV Control" is set for the color keys

(Example)

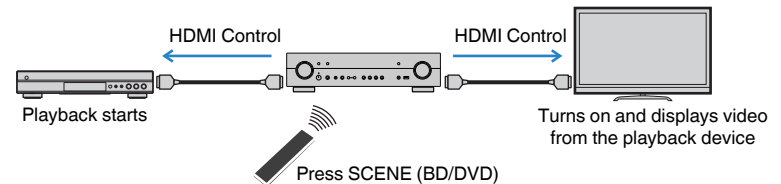

Note

- HDMI Control might not work properly.
- For details on the scene selection, see the following:
 - "Selecting a registered scene" (p.70)
- For details on TV audio input, see the following:
 - "Setting the audio jack used for TV audio input" (p.97)
- For details on the functions for the RED/GREEN/YELLOW/BLUE keys, see the following:
 - "Setting the unit's functions for the RED/GREEN/YELLOW/BLUE keys of the remote control" (p.106)

To use HDMI Control, you need to perform the following HDMI Control link setup after connecting the TV and playback devices.

For details on settings and operating your TV, refer to the instruction manual for the TV.

Note

This setup is required every time you add a new HDMI Control-compatible device to your system.

- 1 Turn on the unit, TV, and playback devices.**
- 2 Enable the HDMI Control function on the unit, TV and HDMI Control-compatible playback devices (such as BD/DVD players).**

In order to enable the HDMI Control function on the unit, set "HDMI Control" in the "Setup" menu to "On", and then configure the settings in related items ("TV Audio Input", "Standby Sync", "ARC" and "SCENE"). For details, see the following:

- "Setting the use of HDMI Control" (p.96)

- 3 Turn off the main power of the TV and then turn off the unit and playback devices.**

- 4 Turn on the unit and playback devices and then turn on the TV.**
- 5 Switch the TV input to display the video from the unit.**
- 6 Check that the input, to which the playback device is connected on the unit, is selected.**
If not, select the input source manually.
- 7 Check that the video from the playback device is displayed on the TV.**
- 8 Check that the unit is properly synchronized with the TV by turning off the TV or adjusting the TV volume with the TV remote control.**

Note

- If HDMI Control does not work properly, the problem may be solved by turning the playback device off and on again, or by unplugging the power plug and plugging it in again. Also, HDMI Control may not work properly if the number of connected devices exceeds the limit. In this case, disable HDMI Control on devices not in use.
- If the unit is not synchronized to the TV's power operations, check the priority of the audio output setting on the TV.
- We recommend using TV and playback devices from the same manufacturer so that HDMI Control works more effectively.

Audio Return Channel (ARC)

ARC allows you to input TV audio to the unit with the HDMI cable which transmits video signal to the TV.

Check the following after the HDMI Control settings.

Note

For details on the HDMI Control settings, see the following:

- "HDMI Control and synchronized operations" (p.142)

- 1 Select a TV program with the TV remote control.**
- 2 Check that the input source of the unit will be automatically switched to "AV 1" and the TV audio will be played back on the unit.**

If you cannot hear the TV audio, check the following:

- "ARC" in the "Setup" menu is set to "On". For details, see the following:
 - "Setting the use of ARC" (p.97)
- The HDMI cable is connected to the ARC-compatible HDMI jack (HDMI jack marked "ARC") on the TV.

Some HDMI jack on the TV is not compatible with ARC. For details, refer to the instruction manual for the TV.

Note

- If the audio is interrupted while using ARC, set "ARC" in the "Setup" menu to "Off" and use a digital optical cable to input TV audio to the unit. For details, see the following:
 - "Setting the use of ARC" (p.97)
 - "OPTICAL jack" (p.137)
- When using ARC, connect a TV with an HDMI cable that supports ARC.
- "AV 1" is set as TV audio input at the factory. If you have connected any external device to the AV 1 jacks, use "TV Audio Input" in the "Setup" menu to change the TV audio input assignment. To use the SCENE function, you also need to change the input assignment for SCENE (TV). For details, see the following:
 - "Setting the audio jack used for TV audio input" (p.97)
 - "Registering a scene" (p.71)

HDMI signal compatibility

Confirm the following HDMI signal used by the unit.

- When CPPM copy-protected DVD-Audio is played back, video/audio signals may not be output, depending on the type of the DVD player.
- The unit is not compatible with HDCP-incompatible HDMI or DVI devices. For details, refer to the instruction manual for each device.
- To decode audio bitstream signals on the unit, set the playback device appropriately so that the device outputs the bitstream audio signals directly (does not decode the bitstream signals on the playback device). For details, refer to the instruction manual for the playback device.
- If the playback device can decode the bitstream audio signals of audio commentaries, you can play back the audio sources with the audio commentaries mixed down by using digital audio input (OPTICAL or COAXIAL jacks). For details, refer to the instruction manual for the playback device. The unit is not compatible with audio commentaries for BD, such as audio content downloaded from the internet.

Trademarks

Trademarks

The trademarks used in this manual are as follows.



Manufactured under license from Dolby Laboratories. Dolby, Dolby Audio, Pro Logic, Dolby Vision, and the double-D symbol are trademarks of Dolby Laboratories.



For DTS patents, see <http://patents.dts.com>. Manufactured under license from DTS Licensing Limited. DTS, DTS-HD, the Symbol, & DTS and the Symbol together are registered trademarks of DTS, Inc. © DTS, Inc. All Rights Reserved.



Use of the Works with Apple badge means that an accessory has been designed to work specifically with the technology identified in the badge and has been certified by the developer to meet Apple performance standards.

Apple, iPad, iPad Air, iPad Pro, iPhone, and iTunes are trademarks of Apple Inc., registered in the U.S. and other countries.

The trademark "iPhone" is used in Japan with a license from Aiphone K.K.

App Store is a service mark of Apple Inc.



The terms HDMI, the HDMI Logo, and High-Definition Multimedia Interface are trademarks or registered trademarks of HDMI Licensing LLC in the United States and other countries.

x.v.Color™

"x.v.Color" is a trademark of Sony Corporation.

Windows™

Windows is a registered trademark of Microsoft Corporation in the United States and other countries.

Internet Explorer, Windows Media Audio and Windows Media Player are either registered trademarks or trademarks of Microsoft Corporation in the United States and/or other countries.

Android™

Google Play™

Android and Google Play are trademarks of Google Inc.



The Wi-Fi CERTIFIED™ Logo and Wi-Fi Protected Setup are certification marks of Wi-Fi Alliance®.

Wi-Fi, Wi-Fi CERTIFIED, Wi-Fi Protected Setup and WPA2 are registered trademarks or trademarks of Wi-Fi Alliance®.



The Bluetooth® word mark and logos are registered trademarks owned by Bluetooth SIG, Inc. and any use of such marks by Yamaha Corporation is under license.



(For U.K., Europe and Australia models)

The unit supports DAB/DAB+ tuning.

SILENT™ CINEMA

"SILENT CINEMA" is a trademark of Yamaha Corporation.



MusicCast is a trademark or registered trademark of Yamaha Corporation.



Yamaha Eco-Label is a mark that certifies products of high environmental performance.

Google Noto Fonts

This product uses the following fonts.

Copyright © June 2015, Google (<https://www.google.com/get/noto/#sans-lgc>), with Reserved Font Name Noto Sans Version 1.004.

Copyright © June 2015, Google (<https://www.google.com/get/noto/help/cjk/>), with Reserved Font Name Noto Sans CJK Version 1.004.

This Font Software is licensed under the SIL Open Font License, Version 1.1.

This license is available with a FAQ at: <http://scripts.sil.org/OFL>

Explanations regarding GPL

This product utilizes GPL/LGPL open-source software in some sections. You have the right to obtain, duplicate, modify, and redistribute this open-source code only. For information on GPL/LGPL open source software, how to obtain it, and the GPL/LGPL license, refer to the Yamaha Corporation website (<http://download.yamaha.com/sourcecodes/musiccast/>).

Licenses

For information on the licenses of the third-party software in this product, refer to the following.

[http://\(IP address of this product*\)/licenses.html](http://(IP address of this product*)/licenses.html)

* IP address of this product is checked with MusicCast CONTROLLER.

Specifications

The specifications of this unit are as follows.

Input jacks

Analog Audio

- Audio x 4 (including AUX)

Digital Audio (Supported frequencies: 32 kHz to 96 kHz)

- Optical x 1
- Coaxial x 2

Video

- Composite x 3

HDMI Input

- HDMI x 4

Other jacks

- USB x 1 (USB2.0)
- NETWORK (Wired) x 1 (100Base-TX/10Base-T)

Output jacks

Analog Audio

- Speaker Out x 5 (FRONT L/R, CENTER, SURROUND L/R*)
* Note: assignment is possible [SURROUND, BI-AMP (FRONT L/R), ZONE 2]
- Subwoofer Out x 1
- Headphone x 1

Video

- Composite x 1

HDMI Output

- HDMI OUT x 1

Other jacks

YPAO MIC x 1

HDMI

HDMI Features:

- 4K UltraHD Video (include 4K/60, 50Hz 10/12bit), 3D Video, ARC (Audio Return Channel), HDMI Control (CEC), Auto Lip Sync, Deep Color, "x.v.Color", HD audio playback, Selectable HDMI input in HDMI standby mode, 21:9 Aspect Ratio, BT.2020 Colorimetry, HDR Compatible (HDR10, Dolby Vision, HLG)

Video Format (Repeater Mode)

- VGA
- 480i/60 Hz
- 576i/50 Hz
- 480p/60 Hz
- 576p/50 Hz
- 720p/60 Hz, 50 Hz
- 1080i/60 Hz, 50 Hz
- 1080p/60 Hz, 50 Hz, 30 Hz, 25 Hz, 24 Hz
- 4K/60Hz, 50Hz, 30 Hz, 25 Hz, 24 Hz

Audio Format

- Dolby TrueHD
- Dolby Digital Plus
- Dolby Digital
- DTS-HD Master Audio
- DTS-HD High Resolution Audio
- DTS Express
- DTS
- DSD 2-ch to 6-ch (2.8 MHz)
- PCM 2-ch to 8-ch (Max. 192 kHz/24-bit)

Content Protection: HDCP 2.2 compatible

Link Function: CEC supported

TUNER

Analog Tuner

- [Other models]
FM/AM x 1 (TUNER)
- [U.K. and Europe models]
DAB/FM with Radio Data System x 1 (TUNER)
- [Australia model]
DAB/FM x 1 (TUNER)

USB

Capable of Mass Storage Class USB Memory

Current Supply Capacity: 1.0 A

Bluetooth

Sink Function

- Source Device to AVR (ex. Smartphone/Tablet)
- Supported profile
 - A2DP, AVRCP
- Supported codec
 - SBC, AAC

Bluetooth version

- Ver. 4.2

Wireless output

- Bluetooth Class 2

Maximum communication distance

- 10 m (33 ft) without interference

Network

PC Client Function

AirPlay supported

Internet Radio

Wi-Fi function

- Capable of WPS by PIN Method and Push-Button-Method
- Capable of sharing with iOS devices by wireless connection
- Available Security Method: WEP, WPA2-PSK (AES), Mixed Mode, None
- Wireless LAN Standards: IEEE 802.11 a/b/g/n/ac*
 - * 20 MHz channel bandwidth only

Compatible Decoding Formats

Decoding Format

- Dolby TrueHD, Dolby Digital Plus
- Dolby Digital
- DTS-HD Master Audio, DTS-HD High Resolution Audio, DTS Express
- DTS, DTS 96/24

Post Decoding Format

- Dolby Pro Logic II Music, Dolby Pro Logic II Movie, Dolby Pro Logic II Game
- DTS Neo: 6 Music, DTS Neo: 6 Cinema

Audio Section

Rated Output Power (2-channel driven)	
<ul style="list-style-type: none"> (20 Hz to 20 kHz, 0.09% THD, 8 Ω) <ul style="list-style-type: none"> – Front L/R (20 Hz to 20 kHz, 0.09% THD, 6 Ω) <ul style="list-style-type: none"> – Front L/R (1 kHz, 0.9% THD, 8 Ω) <ul style="list-style-type: none"> – Front L/R – Center – Surround L/R (1 kHz, 0.9% THD, 6 Ω) <ul style="list-style-type: none"> – Front L/R – Center – Surround L/R 	<p>55 W+55 W</p> <p>60 W+60 W</p> <p>65 W+65 W</p> <p>65 W+65 W</p> <p>80 W+80 W</p> <p>80 W</p> <p>80 W+80 W</p>
Rated Output Power (1-channel driven)	
<ul style="list-style-type: none"> (1 kHz, 0.9% THD, 8 Ω) <ul style="list-style-type: none"> – Front L/R, Center, Surround L/R (1 kHz, 0.9% THD, 6 Ω) <ul style="list-style-type: none"> – Front L/R, Center, Surround L/R 	<p>80 W/ch</p> <p>95 W/ch</p>
Maximum Effective Output Power (1-channel driven)	
<ul style="list-style-type: none"> [Asia, China, Taiwan, and Central and South America models] <ul style="list-style-type: none"> (1 kHz, 10% THD, 8 Ω) <ul style="list-style-type: none"> – Front L/R, Center, Surround L/R (1 kHz, 10% THD, 6 Ω) <ul style="list-style-type: none"> – Front L/R, Center, Surround L/R 	<p>100 W/ch</p> <p>125 W/ch</p>
Dynamic Power (IHF)	
<ul style="list-style-type: none"> Front L/R (8/6/4/2 Ω) 	90/110/140/160 W
Input Sensitivity / Input Impedance	
<ul style="list-style-type: none"> AV 3 etc. (1 kHz, 100 W/6 Ω) 	200 mV/47 kΩ
Maximum Input Signal	
<ul style="list-style-type: none"> AV 3 etc. (1 kHz, 0.5% THD, Effect On) 	2.3 V
Output Level / Output Impedance	
<ul style="list-style-type: none"> SUBWOOFER 	1 V/1.2 kΩ

Headphone Jack Rated Output / Impedance	
<ul style="list-style-type: none"> AV 3 etc. (1 kHz, 50 mV, 8 Ω) 	100 mV/470 Ω
Frequency Response	
<ul style="list-style-type: none"> AV 3 etc. to Front (10 Hz to 100 kHz) 	+0/-3 dB
Signal to Noise Ratio (IHF-A Network)	
<ul style="list-style-type: none"> AV 3 etc. (DIRECT) (Input 1 kΩ Shorted, Speaker Out) 	108 dB or more
Residual Noise (IHF-A Network)	
<ul style="list-style-type: none"> Front L/R (Speaker Out) 	150 μV or less
Channel Separation	
<ul style="list-style-type: none"> AV 3 etc. (Input 1 kΩ Shorted, 1 kHz/10 kHz) 	70 dB/50 dB or more
Volume Control	
<ul style="list-style-type: none"> Range Step 	<p>MUTE, -80 dB to +16.5 dB</p> <p>0.5 dB</p>
Tone Control Characteristics	
<ul style="list-style-type: none"> Bass Boost/Cut Bass Turnover Treble Boost/Cut Treble Turnover 	<p>±6 dB/0.5 dB Step at 50 Hz</p> <p>350 Hz</p> <p>±6 dB/0.5 dB Step at 20 kHz</p> <p>3.5 kHz</p>
Filter Characteristics ($f_c=40/60/80/90/100/110/120/160/200$ Hz)	
<ul style="list-style-type: none"> H.P.F. (Front, Center, Surround) L.P.F. (Subwoofer) 	<p>12 dB/oct.</p> <p>24 dB/oct.</p>

Video Section

Video Signal Type	
• [U.S.A. and Taiwan models]	NTSC
• [Other models]	PAL

Video Signal Level	
• Composite	1 Vp-p/75 Ω

Video Maximum Input Level	
	1.5 Vp-p or more

Video Signal to Noise Ratio	
	50 dB or more

FM Section

Tuning Range	
• [U.S.A. model]	87.5 MHz to 107.9 MHz
• [Asia, Taiwan, and Central and South America models]	87.5/87.50 MHz to 108.0/108.00 MHz
• [U.K. and Europe models]	87.50 MHz to 108.00 MHz
• [Other models]	87.50 MHz to 108.00 MHz

50 dB Quiet Sensitivity (IHF, 1 kHz, 100% MOD.)	
• Monaural	3 μ V (20.8 dBf)

Signal to Noise Ratio (IHF)	
• Monaural	65 dB
• Stereo	64 dB

Harmonic Distortion (IHF, 1 kHz)	
• Monaural	0.5%
• Stereo	0.6%

Antenna Input	
	75 Ω unbalanced

AM Section (Except for U.K., Europe and Australia models)

Tuning Range	
• [U.S.A. model]	530 kHz to 1710 kHz
• [Asia, Taiwan, and Central and South America models]	530/531 kHz to 1710/1611 kHz
• [Other models]	531 kHz to 1611 kHz

DAB Section (U.K., Europe and Australia models)

Tuning Range	
	174 MHz to 240 MHz (Band III)

Support Audio Format	
	MPEG 1 Layer II/MPEG 4 HE-AAC v2

Antenna	
	75 Ω unbalanced

General

Power Supply	
• [U.S.A. model]	AC 120 V, 60 Hz
• [Central and South America models]	AC110 to 120/220 to 240 V, 50/60 Hz
• [Taiwan model]	AC110 to 120/220 to 240 V, 50/60 Hz
• [China model]	AC 220 V, 50 Hz
• [Australia model]	AC 240 V, 50 Hz
• [U.K. and Europe models]	AC 230 V, 50 Hz
• [Asia model]	AC 220 to 240 V, 50/60 Hz

Power Consumption	
	190 W

Standby Power Consumption

• HDMI Control Off, Standby Through Off	0.1 W
• HDMI Control On, Standby Through Auto (No Signals)	1.0 W
• HDMI Control On, Standby Through On (No Signals)	1.0 W
• HDMI Control Off, Standby Through Off, Network Standby On	
– Wired	1.3 W
– Wireless (Wi-Fi)	1.4 W
• HDMI Control On, Standby Through On, Network Standby On	
– Wired	2.1 W
– Wireless (Wi-Fi)	2.1 W
• HDMI Control Off, Standby Through Off, Bluetooth Standby On	1.4 W
• HDMI Control On, Standby Through On, Bluetooth Standby On	2.1 W

Maximum Power Consumption

• [Taiwan, and Central and South America models]	400 W
--	-------

Dimensions (W x H x D)

435 x 111 x 328 mm (17-1/8" x 4-3/8" x 12-7/8")

Reference Dimensions (with wireless antenna upright)

* Including legs and protrusions

435 x 186 x 328 mm (17-1/8" x 7-4/8" x 12-7/8")

Weight

7.8 kg (17.2 lbs)

* The contents of this manual apply to the latest specifications as of the publishing date. To obtain the latest manual, access the Yamaha website then download the manual file.

Default settings

Default settings of the Option menu

The default settings of the "Option" menu are as follows.

Tone Control	Treble, Bass Bypass (0.0 dB)
* When both "Treble" and "Bass" are 0.0 dB, "Bypass" appears.	
DSP/Surround	
• DSP Level	0 dB
• Adaptive DRC	Off
• Enhancer	
– TUNER, (network sources), AirPlay, SERVER, NET RADIO, Bluetooth, USB	On
– Others	Off
Volume Trim	
• Input Trim	0.0 dB
• Subwoofer Trim	0.0 dB
Lipsync	On
Video Out	Off
FM Mode	Stereo
Shuffle	Off
Repeat	Off
Volume Interlock	Limited

Default settings of the Setup menu

The default settings of the "Setup" menu are as follows.

Speaker

Configuration	
• Power Amp Assign	Surround
• Subwoofer	Use
• Front	Small
• Center	Small
• Surround	Small
• Crossover	80 Hz
• Subwoofer Phase	Normal
• Extra Bass	Off
• Virtual CINEMA FRONT	Off
Distance	3.00 m (10.0 ft)
Level	0.0 dB
Equalizer	Off
Test Tone	Off
HDMI	
HDMI Control	Off
Audio Output	Off
Standby Through	Off
4K Upscaling	Off
HDCP Version	
• HDMI 1-4	Auto

TV Audio Input	AV 1
Standby Sync	Auto
ARC	On
SCENE	
• BD / DVD, TV	On
• NET, RADIO	Off

Sound

DSP Parameter	
• Panorama	Off
• Center Width	3
• Dimension	0
• Center Image	0.3
• Monaural Mix	Off
Lipsync	
• Select	Auto
(This setting is effective when a TV that supports an automatic lipsync function is connected to the unit via HDMI.)	
• Adjustment	0 ms
Dialogue	
• Dialogue Level	0
Volume	
• Scale	dB
• Dynamic Range	Maximum
• Main Zone Max Volume	+16.5 dB
• Main Zone Initial Volume	Off
• Zone2 Max Volume	+16.5 dB
• Zone2 Initial Volume	Off

ECO

Auto Power Standby	
• U.K. and Europe models	20 minutes
• Other models	Off
ECO Mode	Off

Function

Input Rename	
• HDMI 1-4	Auto
• Others	Manual
(For AUX, AUDIO3, TUNER, MusicCast Link, SERVER, NET RADIO, USB only "Manual" can be selected.)	
Input Skip	Off
Dimmer	0
Memory Guard	Off
Remote Color Key	Default
Party Mode Set	Enable

Network

Information	-
Network Connection	Wired
IP Address	
• DHCP	On
MAC Address Filter	Off
DMC Control	Enable
Network Standby	Auto
Network Name	-

MusicCast Link Power Interlock	Off
Network Update	-

Bluetooth

Bluetooth	On
Audio Receive	
• Disconnect	-
• Bluetooth Standby	On

Language

English

Default settings of the ADVANCED SETUP menu

The default settings of the "ADVANCED SETUP" menu are as follows.

SP IMP.	8 Ω MIN
REMOTE ID	ID1
TU (Asia, Taiwan, and Central and South America models only)	FM50/AM9
TV FORMAT	
• U.S.A., Taiwan, and Central and South America models	NTSC
• Other models	PAL
4K MODE	MODE 1
BKUP/RSTR	BKUP
INIT	CANCEL
UPDATE	USB
VERSION	-

Yamaha Global Site
<https://www.yamaha.com/>

Yamaha Downloads
<http://download.yamaha.com/>

Manual Development Group
© 2018 Yamaha Corporation

Published 06/2018 NV-A0

AV17-0254