

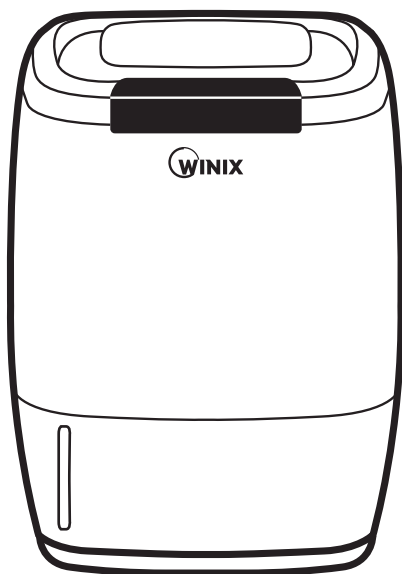

HumidiPür™
Triple Action Humidifier
Model: AW600



Thank you for purchasing this WINIX product

- Read and follow all safety rules and instructions before operating this equipment.
- Please keep this manual for future reference.

HumidiPür

Triple Action Humidifier with **PLASMAWAVE**

HumidiPür™ Model: AW600

Winix HumidiPür™ Triple Action Humidifier simultaneously humidifies and cleans the air. Featuring a 3.17 gallon per day humidification capacity and 3-Stage air purification with PlasmaWave® Technology.



PLASMAWAVE®
PlasmaWave® technology removes air pollutants resulting in cleaner fresher air.



Mist Humidifier
HumidiPür™ generates very fine and light mist to enhance consistent humidity level.



Auto Mode
WINIX's sensor detects room humidity level to control fan speed and optimize the humidity level.



CleanCel® Anti-Bacterial Coating
HumidiPür™ has been treated with CleanCel® antibacterial coating to prevent growth of bacteria in the water tank and cleaning discs.



Timer
The automatic Timer indicator is used to maintain efficiency throughout the lifetime of the product.



Auto Shut-Off
Automatically shuts off when the water bucket is Low.



Sleep Mode
Light sensor detects when the room is dark and adjusts the unit to Sleep Mode to reduce power consumption.

Table of Contents

Safety Instructions	
Warning	3
Product Information	
Unit Diagram	11
Control Panel/Display	12
Installation	
Selecting a Location	13
Set-Up Instructions	14
Operation	
Modes of Operations	15
Care and Maintenance	19
Troubleshooting	
FAQ/Solutions	25
Product Specifications	27

Safety Instructions

Warning

Follow these instructions to avoid any risk of personal injury, property damage, electrical shocks or fire hazard.

Notice

Failure to follow the safety instructions can lead to personal injury or property damage.

 PROHIBITED

 DO NOT DISASSEMBLE

 MUST FOLLOW

 Ground connection protecting from electrical shock

Warning

DON'T unplug the unit by pulling on it's power cord.

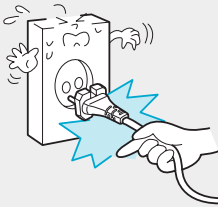

DON'T bend or place heavy object on the power cord.

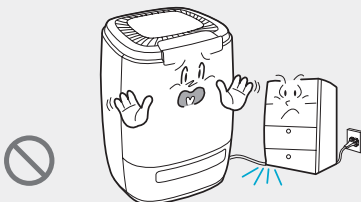

DON'T touch the plug with wet hands.

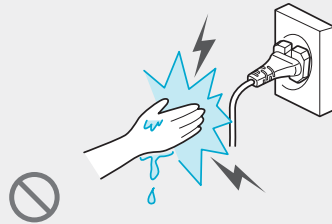

DON'T replace or modify power cord.
If the power cord/plug is damaged, it must be replaced by the manufacturer or a qualified technician.



 Warning

DON'T plug multiple power plugs into an outlet. Plug directly into the wall.

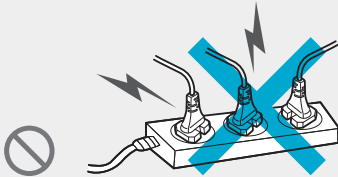

DO unplug the HumidiPür™ when not in use to save on energy consumption.

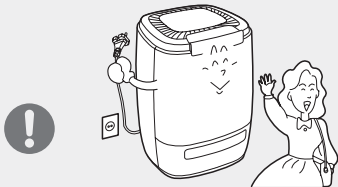

DON'T attempt to repair, alter or disassemble the unit.

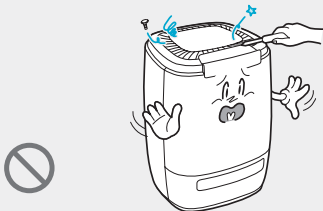

DO connect the power cord to only proper power outlet with a ground connection.

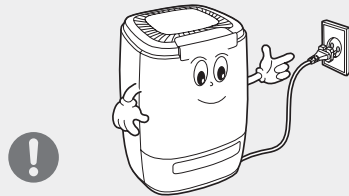

DON'T plug power cord into loose or damaged electrical outlet. (This can lead to overheating or electrical shock)

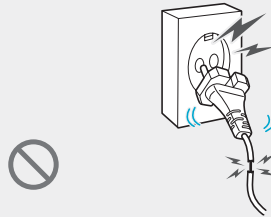

DON'T operate the unit if standing water is present.

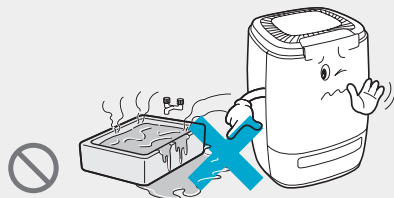

Safety Instructions

 Note

DON'T operate HumidiPür™ on an uneven surface.



DON'T spray liquids directly into air washer.



DON'T place the HumidiPür™ near flammable material (such as gas, aerosols, or benzene).

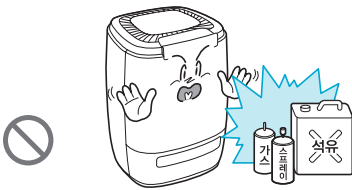

DON'T place the unit on an unstable place such as a table or a sink.

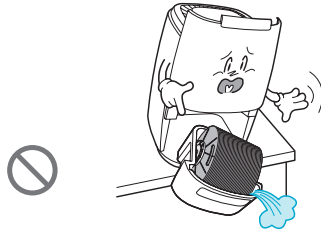

Attempt to change the bucket and refill with clean water every day.

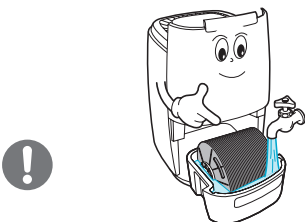

DON'T pour water into the top of the air unit, place in water tank as directed.



! Note

DO unplug the unit and contact your service dealer if the unit comes in contact with water.



DON'T remove the water tank if a child is nearby.



DO unplug the unit and contact your service dealer if it is sunken under water.

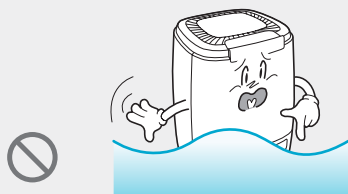

DON'T insert ANYTHING into the air inlet or outlet.

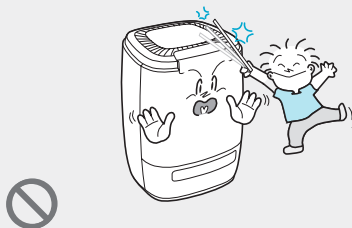

DON'T install the unit in the place full of high humidity or dust.



DON'T place anything around the unit to allow children to play or sit on.



Safety Instructions

! Note

DON'T disconnect the power cord during operation.



DO unplug the appliance during filling and cleaning.

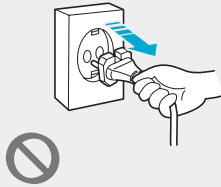

DO unplug the unit and contact your service dealer if any irregular noise or smoke occurs.

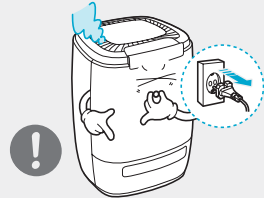

DO use the HumidiPür™ after assembling the Antimicrobial Disk.

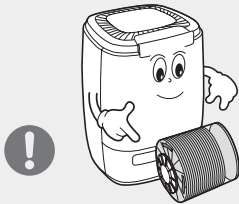

DON'T insert anything into the air inlet or outlet.

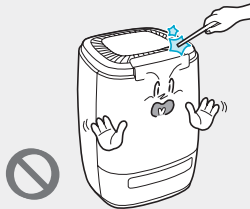

DON'T place the unit near a heat source.

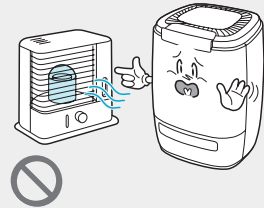

DON'T place hands or any body parts near the air outlet during operation.



DON'T place the unit near curtains or other materials that can block the vents of the unit.

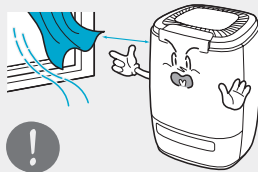

DON'T strike or drop the unit.



! Note

DON'T allow children to play on or near the unit.



DON'T spray flammable liquids or gases into the unit.



DON'T install the unit under direct light.

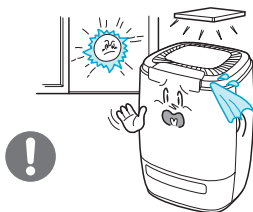

DON'T use hot water in the water tank.

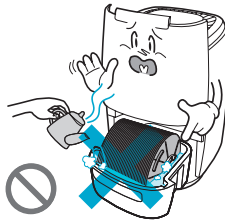

DON'T lift the unit by the top.

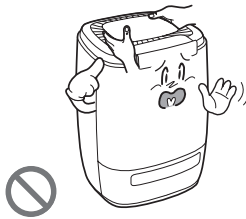

DON'T place clothes and towels on top of air washer while operating.



DO clean Antibacterial disk regularly with warm tap water and allow to air dry.



DON'T use flammable material (such as benzene or alcohol) to clean the unit.

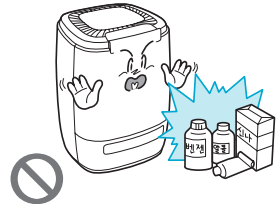

DON'T spray liquids directly into HumidiPür™ during cleaning.

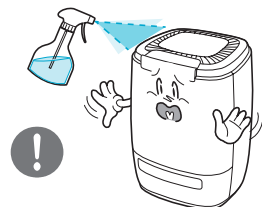

Safety Instructions

! Note

DON'T install the unit near the wall or window.

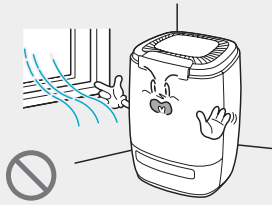

DON'T put the unit near burning cigarette or incense.



After cleaning, allow Antibacterial Discs, water tank, and pre-filter to air dry completely.

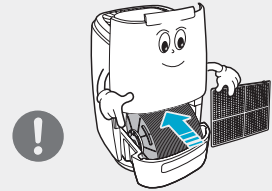

DON'T operate the unit while insecticide is used.



DON'T allow water to stay in the water tank for a long time while not in use.

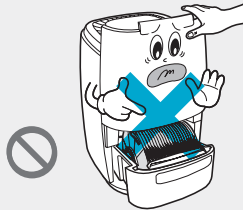

DON'T operate the unit while water tank is damaged.

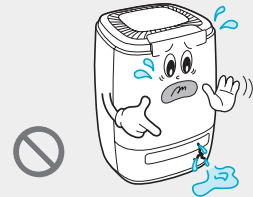

DON'T install the unit whose airflow outlet is facing the wall.

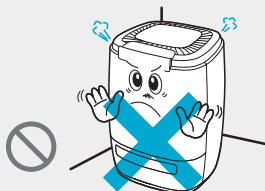

DON'T drink the water left in the water tank or give it to plants or animals.



DON'T put the unit near a microwave oven or TV.

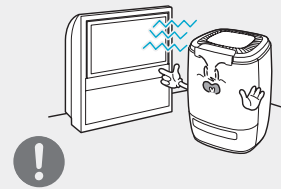

! Note

DON'T overfill the water tank.

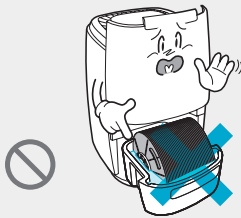

DO dispose of the water to prevent it from freezing in cold weather.



DO unplug the unit and move its water tank when water is removed.

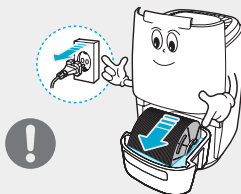

DON'T put the unit near ceilings, walls, furniture, or electronic appliances.

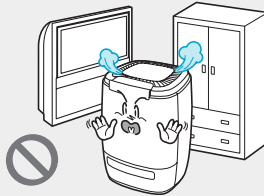

DON'T lift the unit with water still in the water tank.



DO clean the air washer regularly, with a microfiber towel or any other clean wiping material.

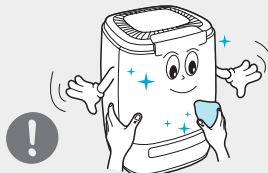

DON'T plug in if the power plug is touched with water.



DON'T put magnet or metal material on the top of the unit.

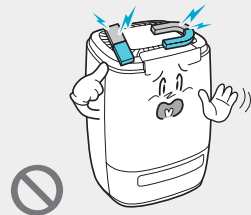

DO use clean tap water without detergent, soap, chemical compounds or hot water (over 104°F).

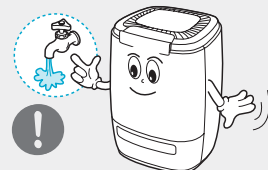

Product Diagram

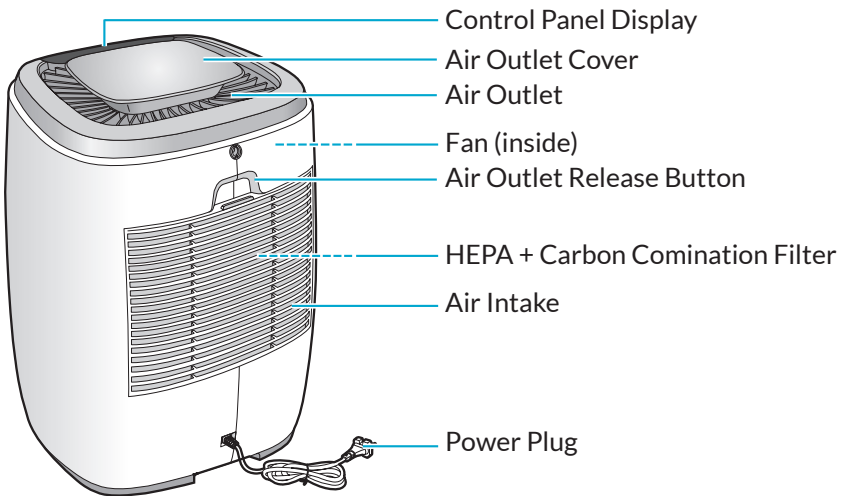
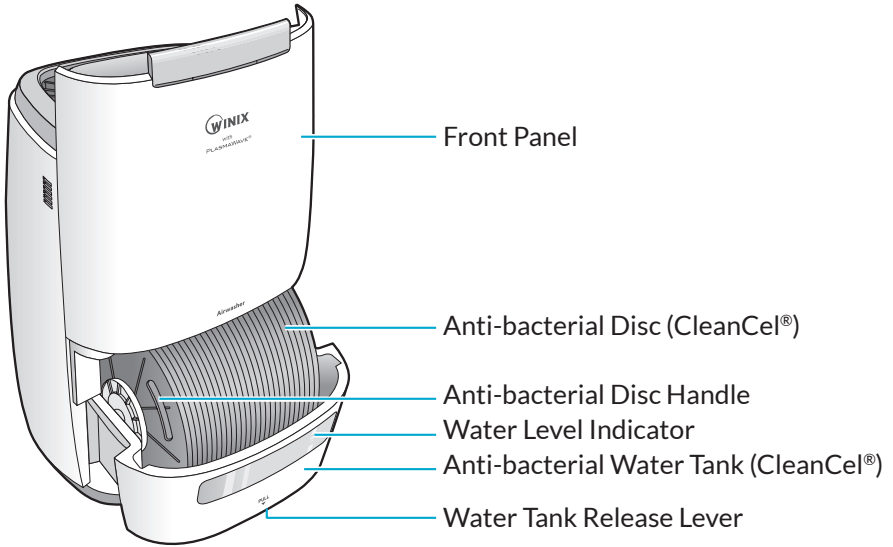

Control Panel

Function Button

1. Continuous Mode
Unit operates continuously on the fan speed selected by user (Low/Mid/High) regardless of ambient humidity.
2. Sleep Mode
Dims control panel lights and sets the unit to operate at lowest fan speed.
3. Auto-Mode
Unit runs until ideal humidity level is reached and shuts off intermittently to save energy (Green "Comfort Zone").

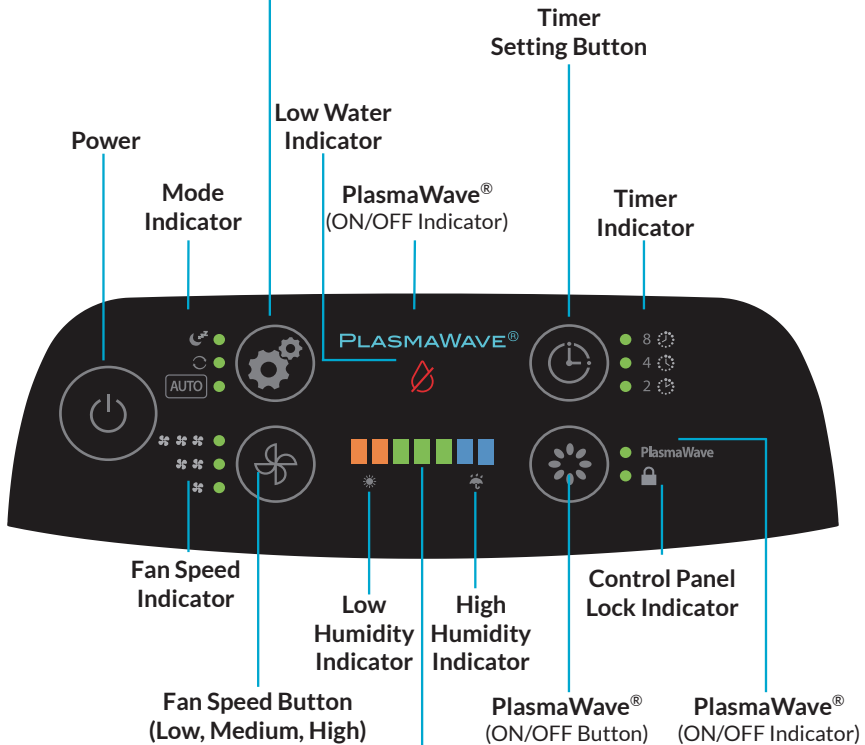

Humidity Level Indicator

Displays humidity level, when desirable level of humidity levels are reached they will be displayed in the green "Comfort Zone"

Orange -> Low Humidity (Below 30% RH)

Blue -> High Humidity (61-70% RH)

Green -> Ideal Humidity (40-60% RH)

Installation

Selecting a Location

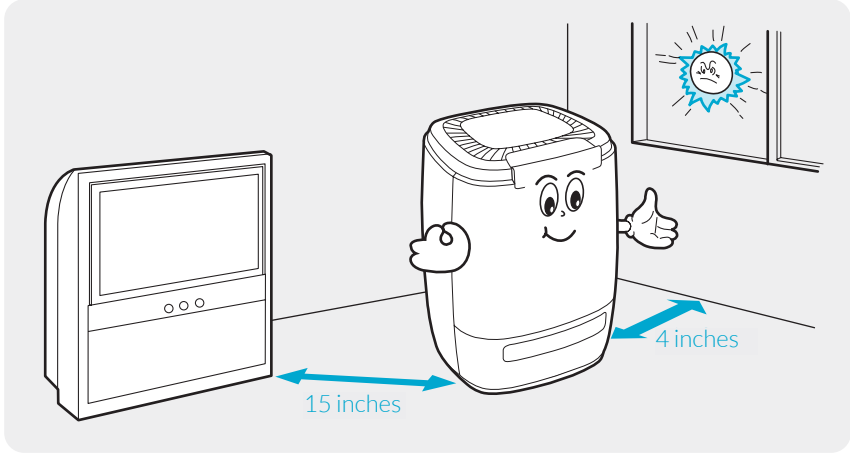

Do not install the unit under direct sunlight.

- Long Exposure to direct sunlight can cause defects.

HumidiPür™ must be installed and operated on an even surface.

- Vibrations and noise can occur on soft or non-flat surfaces.

Product must be Installed approximately 10cm/ 4 inches away from the wall and 30-40cm/ 15 inches from other electronic appliances.

Before operating the HumidiPür™, remove any plastic bags and polyfoams from outside and inside the unit.

Operation

Set-Up Instructions

1. Slide water tank out, by using the release lever located below the water tank on the front of the unit.



2. Fill the water tank with cool tap water up to the indicator line on the inside of water tank.

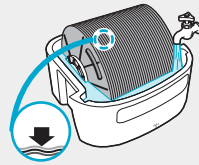

3. Replace the water tank by sliding it back into the unit until you hear it click into place.

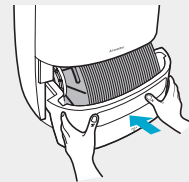

4. Gently slide down the front panel and make sure that it is seated properly and lines up correctly.



- Make sure to unplug the power cord before filling the unit with water.
- We recommend using filtered water to prolong the life of the product.
- Use cautions when moving the unit filled with water.

Operation

Before Turning On

- 1 Plug the power cord into a power outlet.

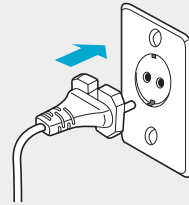

- 2 Push the POWER button.



- 3 The unit will start on AUTO MODE and the PlasmaWave® function will be ON.



- ▶ A soft buzzing or clicking sound may occur during operation; if this is uncomfortable, you can turn off the PlasmaWave® feature by using the PlasmaWave® ON/OFF button.

Auto Mode

- 1 Push FUNCTION button to select Auto Mode

AIR FLOW:

When ambient humidity is sensed at less than 60%, the unit will operate at "High" fan speed. When the ambient humidity is sensed at greater than 60% the unit will operate at "Low" fan speed.

CLEANING DISCS:

When ambient humidity is sensed at greater than 75% humidity the cleaning discs will stop spinning. When ambient humidity is sensed less than 60%, the disc, resumes to circulate.



Continuous Mode

- 1 Push the FUNCTION button to select Continuous Mode.
 - Continuous Mode Indicator will illuminate.
 - The FUNCTION button will cycle the unit between the following: Auto -> Continuous -> Sleep



Operation

Sleep Mode

- 1 Push the FUNCTION button to select Sleep Mode.

The MODE button will cycle the unit between the following:

Auto -> Continuous -> Sleep



- 2 During Sleep Mode the unit will set fan speed to lowest setting and the display will turn off, except for the low fan speed indicator.



Adjust Fan Speed

- Push the FAN SPEED button to change the Fan Speed.

The FAN SPEED button will cycle the unit between the following:

Low -> Med -> High

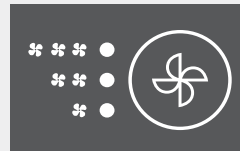

Adjust Timer

- Push TIMER button to set a timer.
 - The TIMER button will cycle through the unit timer settings:
2 hours -> 4 hours -> 8 hours

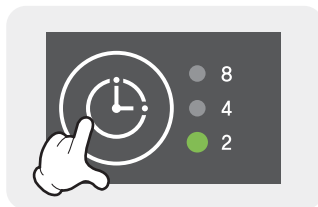

PlasmaWave® Technology

During Humidification process

- Push PLASMAWAVE/LOCK button to operate PlasmaWave®.
 - Use this button to turn PlasmaWave® function ON/OFF

During PlasmaWave® operation only

- Push PLASMAWAVE/LOCK button to operate PlasmaWave® while the unit OFF.
 - Use this button to turn PlasmaWave® function ON/OFF without using the humidification function of the unit.



Lock Button

- Push PLASMAWAVE/LOCK button for more than 3 seconds to activate Lock.



Care & Maintenance

Emptying the Water Tank

- 1 Use the tab on the bottom of the water tank and gently slide it out to open.
- 2 Lift disc assembly by the antibacterial handle and carefully remove it.



- 3 Remove the used water left in the water tank and dispose of it in an appropriate manner. Refill water tank with clean water.

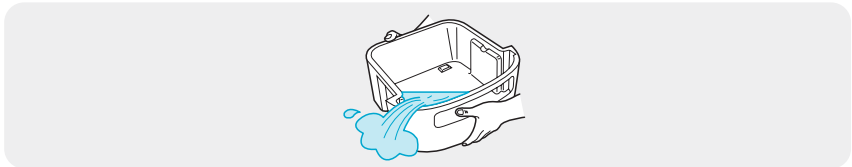

- 4 Replace the water tank with a snap.
- 5 Gently slide down the front panel to close.



- ▶ Be sure to change water frequently to ensure optimal functioning of the unit.
- ▶ Be sure to replace the water tank correctly in order to ensure that the unit functions properly.

Cleaning Surface

- Clean the outside of the unit with a soft cloth and mild detergent. Wipe clean with a dry cloth.

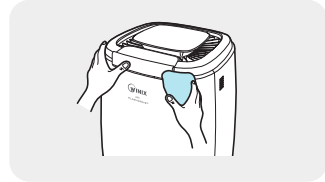

Cleaning Rear Air Intake Grille

Use the tab on the back cover grille To clean the back cover grille rinse and pull up on the Combo Filter. lightly under warm water and air dry.

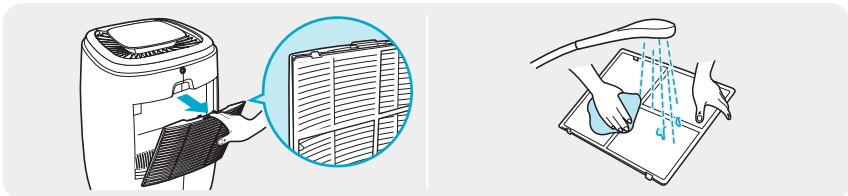

After cleaning, and letting air dry, slide the HEPA + Carbon Filter back into its original location and replace the back cover grille.

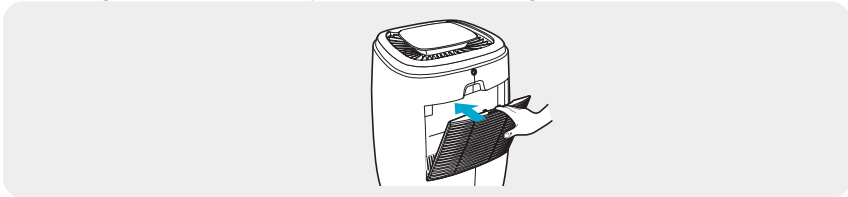

- ▶ Unplug the HumidiPür™ before performing any type of maintenance such as cleaning or disassembling.
- ▶ Do NOT clean the top portion of the unit with water.
- ▶ Empty and unplug if not operating for more than 2 days.

Care & Maintenance

Cleaning Anti-bacterial Discs

Be sure to clean the Anti-bacterial Discs once a week

- Clean Anti-bacterial Discs with warm tap water and a light detergent.

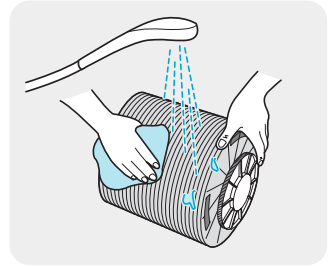

- 1 Fill warm tap water with detergent in the water tank.

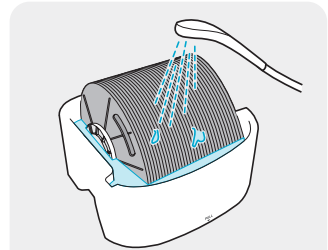

- 2 Clean inside of the cycled Anti-bacterial Discs thoroughly.

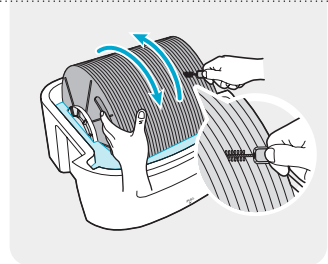

▶ CleanCel® Anti-bacterial Cleaning Discs are dish washer safe and can be washed in temperatures no greater than 176°F

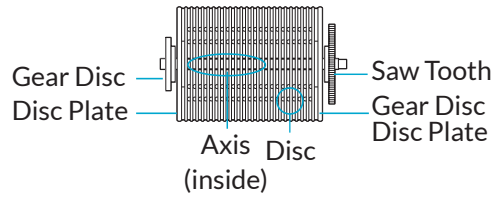

1 Turn Gear of the Antibacterial Disc counterclockwise, and pull the front of the Disc out, and separate axis from the rear Gear Disc, by turning it counterclockwise.

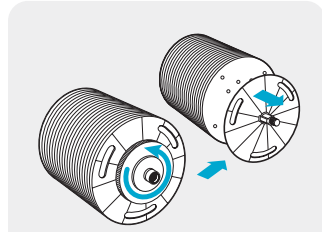

2 Rinse Antibacterial Disc with warm tap water and a mild detergent.

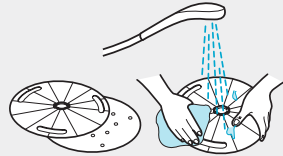

3 Clean the inside of water tank with a soft cloth and mild detergent.

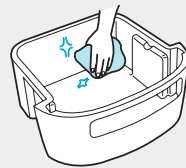

4 After cleaning, assemble the parts (Gear Disc, Discs, and Saw Tooth Gear Disc) in the opposite order.

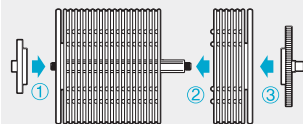

Care & Maintenance

Cleaning Water Tank

- 1 Clean the inside of the water tank with a soft cloth and mild detergent.

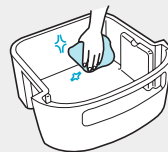

- 2 Place CleanCel® Anti-bacterial Discs back into the water tank aligning with grooves and with handle laid flat.

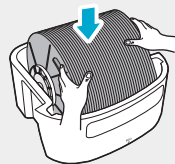

- 3 Replace the Water Tank with a snap.

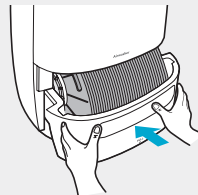

- 4 Gently slide down the front panel to close the unit. Make sure that it is seated properly and lines up correctly.



Cleaning Inner Parts and Fan

- 1 Turn groove to open with a coin or flat tip screw driver, at the rear of the unit, and remove top cover.

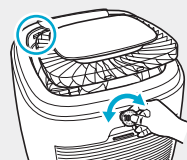

- 2 Holding fan, turn fan cap clockwise.



- 3 Rinse fan and fan cap with warm tap water with detergent.







- 4 Remove dust near airflow inlet of the unit by using vacuum cleaner or soft brush.

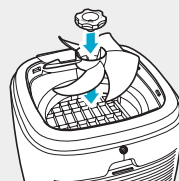

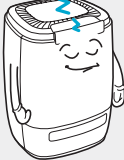

- 5 After cleaning, replace fan and fan cap.



Care & Maintenance

Symptom	Check If:	Solution:
<p>HumidiPür™ does not turn on</p> 	<ul style="list-style-type: none"> ▶ Power cord is plugged in. ▶ Low Water Indicator light is on. ▶ Water is filled inside water tank. 	<ul style="list-style-type: none"> ▶ Plug the power cord in. ▶ Fill the water tank ▶ Make sure the water tank is in place and filled correctly.
<p>Auto Mode is not working</p> 	<ul style="list-style-type: none"> ▶ Power cord is plugged in. ▶ Auto Mode Indicator is on. 	<ul style="list-style-type: none"> ▶ Unplug power cord and plug it back in. ▶ Push FUNCTION button to select Auto Mode.
<p>Vibrates or makes noise</p> 	<ul style="list-style-type: none"> ▶ The unit is located on an uneven surface. 	<ul style="list-style-type: none"> ▶ Move to an even surface.
<p>Power cord is hot</p> 	<ul style="list-style-type: none"> ▶ Power cord is plugged in. 	<ul style="list-style-type: none"> ▶ Unplug the power cord and contact customer support.

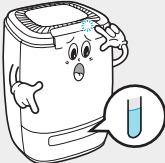
Symptom	Check If:	Solution:
<p>HumidiPür™ does not turn on</p> 	<ul style="list-style-type: none"> ▶ Water is ground water. ▶ Water is too cold or icy. ▶ Fan speed is on low level. 	<ul style="list-style-type: none"> ▶ Change to tap water. ▶ Use 68°F to 77°F temperature water. ▶ Change to high fan speed.
<p>Function button is not working</p> 	<ul style="list-style-type: none"> ▶ Child-Lock mode is on. 	<ul style="list-style-type: none"> ▶ Push Plasma/Child Lock button for 3 seconds to turn OFF Child-Lock mode.
<p>Unpleasant odors are present</p> 	<ul style="list-style-type: none"> ▶ HumidiPür™ is being used where strong odors and/or dust is present 	<ul style="list-style-type: none"> ▶ Replace the water in the water tank and change water more frequently. ▶ Clean water tank and CleanCel® Anti-bacterial Discs.
<p>Water level indicator is on despite water level</p> 	<ul style="list-style-type: none"> ▶ Water is left inside the water tank. 	<ul style="list-style-type: none"> ▶ Refill the water tank.

Specifications

Model No.	AW600
Power Supply	120V / 60 Hz
Power Consumption	16W
Humidifying Capacity	3.17 gallons per day
Tank (Max/Full)	1.3 gallons / 1.85 gallons
Weight	15.4 lbs.
Dimensions	13.4" x 17.7" x 13.4"

Notes

A large rectangular box with rounded corners, containing horizontal dashed lines for writing notes. The box is empty and occupies the central portion of the page.



This marking shown on the product or its literature. Indicates that it should not be disposed with other household wastes at the end of its working life. To prevent possible harm to the environment or human health from uncontrolled waste disposal. Please separate this from other types of wastes and recycle it responsibly to promote the sustainable reuse of material resources.

Household users should contact either the retailer where they purchased this product, or their local government office, for details of where and how they take this item for environmentally safe recycling.

Business users should contact their supplier and check the terms and conditions of the purchase contract. This product should not be mixed with other commercial wastes for disposal.