

**SAMSUNG**

**GT-P5110**  
user manual



# Using this manual

Thank you for choosing this Samsung mobile device. This device will provide you with high-quality mobile communication and entertainment based on Samsung's exceptional technology and high standards.

This manual has been specially designed to guide you through the functions and features of your device.

## Read me first

- Before using your device, read the entire manual and all safety instructions to ensure safe and proper use.
- The descriptions in this manual are based on the default settings of your device.
- The images and screenshots used in this manual may differ from the actual product.
- The contents of this manual may differ from the product, or from software provided by service providers or carriers, and are subject to change without prior notice. Access the Samsung website ([www.samsung.com](http://www.samsung.com)) for the latest version of the manual.
- Available features and additional services may vary by device, software, or service provider.
- Formatting and delivery of this manual is based on Android operating systems and may vary depending on the user's operating system.
- Applications on this device may perform differently from comparable computer applications and may not include all functions available in the computer version.
- Applications and their functions may vary by region or hardware specifications. Samsung is not liable for performance issues caused by third-party applications.

- Samsung is not liable for performance issues or incompatibilities caused by edited registry settings or modified operating system software. Attempting to customise the operating system may cause your device or applications to work improperly.
- You can upgrade your device's software by accessing the Samsung website ([www.samsung.com](http://www.samsung.com)).
- Software, audio, wallpapers, and images provided in this device are licensed for limited use between Samsung and their respective owners. Extracting and using these materials for commercial or other purposes is an infringement of copyright laws. Samsung is not liable for such copyright infringement by users.
- Please keep this manual for future reference.

## Instructional icons

Before you start, familiarise yourself with the icons used in this manual:



**Warning**—situations that could cause injury to yourself or others



**Caution**—situations that could cause damage to your device or other equipment



**Note**—notes, usage tips, or additional information

- ▶ **Refer to**—pages with related information; for example: ▶ p. 12 (represents “refer to page 12”)
- **Followed by**—the order of options or menus you must select to perform a step; for example: In the application list, select **Settings** → **About device** (represents **Settings**, followed by **About device**)

# Copyright

Copyright © 2012 Samsung Electronics

This manual is protected under international copyright laws. No part of this manual may be reproduced, distributed, translated, or transmitted in any form or by any means, electronic or mechanical, including photocopying, recording, or storing in any information storage and retrieval system, without the prior written permission of Samsung Electronics.

# Trademarks

- SAMSUNG and the SAMSUNG logo are registered trademarks of Samsung Electronics.
- The Android logo, Google™, Google Maps™, Google Mail™, YouTube™, Google Play™ Store, Google Latitude™, and Google Talk™ are trademarks of Google, Inc.
- Bluetooth® is a registered trademark of the Bluetooth SIG, Inc. worldwide.
- Windows Media Player® is a registered trademark of the Microsoft Corporation.
- Wi-Fi®, Wi-Fi Protected Setup™, Wi-Fi Direct™, Wi-Fi CERTIFIED™, and the Wi-Fi logo are registered trademarks of the Wi-Fi Alliance.

- DivX<sup>®</sup>, DivX Certified<sup>®</sup> and associated logos are trademarks of Rovi Corporation or its subsidiaries and are used under licence.

**DivX**<sup>™</sup>  
**HD**

- All other trademarks and copyrights are the property of their respective owners.



**CE 0168** 

## **ABOUT DIVX VIDEO**

DivX<sup>®</sup> is a digital video format created by DivX, LLC, a subsidiary of Rovi Corporation. This is an official DivX Certified<sup>®</sup> device that plays DivX video. Visit [www.divx.com](http://www.divx.com) for more information and software tools to convert your files into DivX videos.

## **ABOUT DIVX VIDEO-ON-DEMAND**

This DivX Certified<sup>®</sup> device must be registered in order to play purchased DivX Video-on-Demand (VOD) movies. To obtain your registration code, locate the DivX VOD section in your device setup menu. Go to [vod.divx.com](http://vod.divx.com) for more information on how to complete your registration.

DivX Certified<sup>®</sup> to play DivX<sup>®</sup> video up to HD 720p, including premium content.

# Contents

<b>Assembling .....</b>	<b>11</b>
Unpack .....	11
Device layout .....	12
Keys .....	14
Charge the battery .....	15
Insert a memory card (optional) .....	18
<b>Getting started .....</b>	<b>20</b>
Turn on or off your device .....	20
Use the touch screen .....	20
Lock or unlock the touch screen and the keys .....	22
Get to know the Home screen .....	23
Access applications .....	27
Launch multiple applications .....	29
Customise your device .....	29
Enter text .....	33
<b>Web and GPS-based services.....</b>	<b>36</b>
Internet .....	36
Game Hub .....	40
Latitude .....	40
Maps .....	41
Navigation .....	42
Places .....	43
Play Store .....	43
Readers Hub .....	44
Samsung Apps .....	44

S Suggest .....	45
YouTube .....	45
<b>Communication .....</b>	<b>47</b>
Google Mail .....	47
Email .....	49
Talk .....	51
ChatON .....	52
Messenger .....	52
Google+ .....	52
<b>Entertainment.....</b>	<b>53</b>
Camera .....	53
Video player .....	60
Gallery .....	63
Photo editor .....	65
Video maker .....	66
Music player .....	68
Music Hub .....	72
<b>Personal information .....</b>	<b>73</b>
Contacts .....	73
S Planner .....	75
Memo .....	77
<b>Connectivity.....</b>	<b>78</b>
USB connections .....	78
Wi-Fi .....	80
Wi-Fi Direct .....	83
AllShare .....	84



Bluetooth .....	86
GPS .....	88
VPN connections .....	89
<b>Tools.....</b>	<b>91</b>
Alarm .....	91
Calculator .....	92
Downloads .....	92
My files .....	93
Polaris Office .....	95
Search .....	96
World clock .....	97
<b>Settings .....</b>	<b>98</b>
Access the setting options .....	98
Wi-Fi .....	98
Bluetooth .....	98
Data usage .....	98
More... .....	98
Sound .....	99
Wallpaper .....	99
Lock screen .....	100
Display .....	100
Power saving .....	100
Storage .....	101
Battery .....	101
Applications .....	101
Accounts and sync .....	101
Location services .....	101

Security .....	102
Language and input .....	103
Back up and reset .....	105
Dock .....	105
Date and time .....	106
Accessibility .....	106
Developer options .....	107
About device .....	108
<b>Troubleshooting .....</b>	<b>109</b>
<b>Safety information .....</b>	<b>113</b>
<b>Index .....</b>	<b>123</b>

# Assembling

## Unpack

Check your product box for the following items:

- Mobile device
- Quick start guide

 Use only Samsung-approved software. Pirated or illegal software may cause damage or malfunctions that are not covered by your manufacturer's warranty.

- 
- The items supplied with your device and available accessories may vary depending on your region or service provider.
  - You can buy additional accessories from your local Samsung retailer.
  - The supplied items are designed only for your device and may not be compatible with other devices.
  - Other accessories may not be compatible with your device.

# Device layout

## › Front view

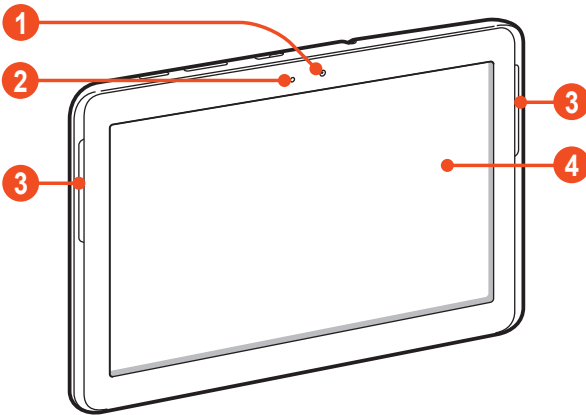

Number	Function
1	Front camera lens
2	Light sensor
3	Speaker
4	Touch screen

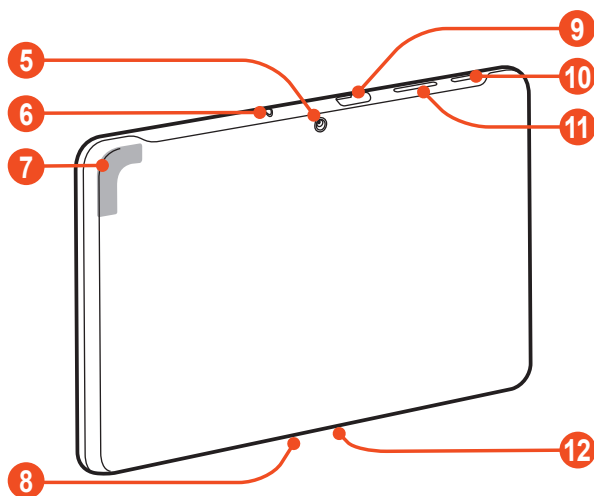

## › Rear view



Number	Function
5	Rear camera lens
6	Headset jack
7	GPS antenna <sup>1</sup>
8	Microphone
9	Memory card slot
10	Power/Reset/Lock key
11	Volume key
12	Multifunction jack

1. Do not touch or cover the area around the antenna with your hands or other objects while using the GPS functions.

# Keys

Key	Function
 Power/ Reset/ Lock	Turn on the device (press and hold); Access the device options (press and hold); Reset the device (press and hold for 8-10 seconds); Turn off and lock the touch screen or turn it on.
 Volume	Adjust the device's volume.

1. If your device experiences fatal errors, hanging, or freezing, you may need to reset the device to regain functionality.

## Charge the battery

Before using the device for the first time or when the battery has been unused for an extended period, you must charge the battery. Charge the battery only with a charger. You cannot charge the battery with a USB cable.

You cannot replace the battery in the device. If you have problems with the battery or need it replaced, take the device to a Samsung Service Centre.





Use only Samsung-approved chargers and cables. Unapproved chargers or cables may cause batteries to explode or damage your device.

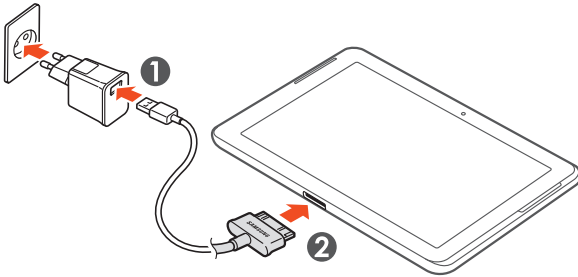

- When your battery is low, the device will emit a warning tone and show a low battery message. Recharge your battery to continue using your device.
- If the battery is completely discharged, you cannot turn on the device, even while it is charging. Allow a depleted battery to charge for a few minutes before you try to turn on the device.
- The shape of the USB power adapter may differ depending on your region.

- 1 Connect the USB cable to the USB power adapter and then plug the end of the USB cable into the multifunction jack.



-  Connecting the USB cable improperly may cause serious damage to the device or USB power adapter. Any damage caused by misuse is not covered by the warranty.

- 2 Plug the USB power adapter into a power outlet.



- If the device receives an unstable power supply while charging, the touch screen may not function. If this happens, unplug the USB cable from the device.
- The device may heat up while charging. This is normal and should not affect your device's lifespan or performance.
- If your device is not charging properly, take your device and the charger to a Samsung Service Centre.



3 When the battery is fully charged, first unplug the USB cable from the device, and then unplug the USB power adapter from the electrical socket.



To save energy, unplug the USB power adapter when not in use. The USB power adapter does not have a power switch, so you must unplug the USB power adapter from the electrical socket when not in use to avoid wasting power. The device should remain close to the electrical socket while charging.

## ▶ Reduce the battery consumption

Your device provides options that help you save battery power. By customising these options and deactivating features in the background, you can use the device longer between charges:

- When you are not using your device, switch to Sleep mode by pressing the Power key.
- Close unnecessary applications with the task manager.
- Deactivate the Bluetooth feature.
- Deactivate the Wi-Fi feature.
- Deactivate auto-syncing of applications.
- Decrease the backlight time.
- Decrease the brightness of the display.

## Insert a memory card (optional)

Your device accepts microSD™ or microSDHC™ memory cards with maximum capacities of 32 GB (depending on the memory card manufacturer and type).

 Samsung uses approved industry standards for memory cards, but some brands may not be fully compatible with your device. Using an incompatible memory card may damage your device or the memory card. It may also corrupt data saved on the memory card.

-  • Your device supports only the FAT file structure for memory cards. If you insert a memory card formatted with a different file structure, your device will ask you to reformat the memory card.
- Frequent writing and erasing of data will shorten the lifespan of your memory cards.
- When you insert a memory card into your device, the memory card's file directory will appear in the extSdCard folder.

1 Open the cover of the memory card slot.

2 Insert a memory card with the gold-coloured contacts facing downwards.

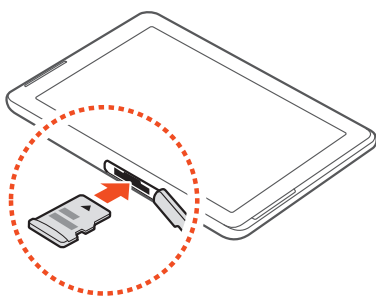

- 3 Push the memory card into the memory card slot until it locks in place.
- 4 Close the cover of the memory card slot.

## › Remove a memory card

Ensure that the device is not currently accessing the memory card.

- 1 In the application list, select **Settings** → **Storage** → **Unmount SD card** → **OK**.
- 2 Open the cover of the memory card slot.
- 3 Push the memory card gently until it disengages from the device.
- 4 Remove the memory card.
- 5 Close the cover of the memory card slot.

 Do not remove a memory card while the device is transferring or accessing information, as this could result in loss of data or damage to the memory card or device.

## › Format a memory card

Formatting your memory card on a computer may cause incompatibilities with your device. Format the memory card only on the device.

In the application list, select **Settings** → **Storage** → **Format SD card** → **Format SD card** → **Erase everything**.

 Before formatting the memory card, remember to make backup copies of all important data. The manufacturer's warranty does not cover loss of data resulting from user actions.

# Getting started

## Turn on or off your device

To turn on your device, press and hold the Power key.



If you are turning on your device for the first time, follow the on-screen instructions to set up your device. You must sign in to Google or create a Google account to use applications that interact with the Google server.

To turn off your device, press and hold the Power key, and then select **Power off** → **OK**.



- Follow all posted warnings and directions from approved personnel in areas where the use of wireless devices is restricted, such as aeroplanes and hospitals.
- To use only your device's non-network features, switch to Flight mode. ► p. 98

## Use the touch screen

Your device's touch screen lets you easily select items or perform functions. Learn basic actions for using the touch screen.



- Do not press the touch screen with your fingertips, or use sharp tools on the touch screen. Doing so may damage the touch screen or cause it to malfunction.
- Do not allow the touch screen to come into contact with other electrical devices. Electrostatic discharges can cause the touch screen to malfunction.
- Do not allow the touch screen to come into contact with liquids. The touch screen may malfunction in humid conditions or when exposed to liquids.



- For optimal use of the touch screen, remove the screen protection film before using your device.
- Your touch screen has a layer that detects small electrical charges emitted by the human body. For best performance, tap the touch screen with your fingertip. The touch screen will not react to touches from sharp objects, such as a stylus or pen.

Control your touch screen with the following actions:

### **Tap**

Touch once to select or launch a menu, option, or application.



### **Tap and hold**

Tap an item and hold it for more than 2 seconds.



### **Drag**

Tap an item and move it to a new location.

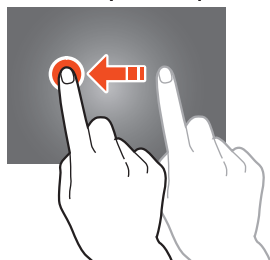

### **Double-tap**

Tap an item twice quickly.



## Flick

Briskly scroll up, down, left, or right to move through lists or screens.

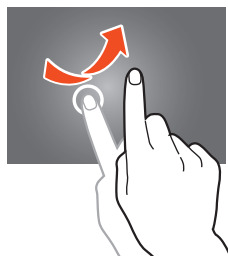

## Pinch

Place two of your fingers far apart, and then pinch them together.

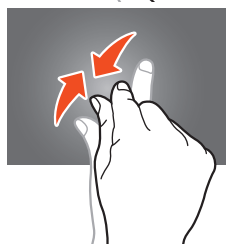

- Your device turns off the touch screen when you do not use it for a specified period. To turn on the screen, press the Power key.
- You can set the length of time that the device waits before turning off the screen. In the application list, select **Settings** → **Display** → **Screen timeout**.

## Lock or unlock the touch screen and the keys

When you do not use the device for a specified period, your device turns off the touch screen and locks the touch screen and the keys automatically to prevent unintended operations. To lock the touch screen and the keys manually, press the Power key.

To unlock them, turn on the screen by pressing the Power key, tap anywhere on the screen, and then drag your finger outside of the large circle.



- You can activate the screen lock feature to prevent others from using or accessing your personal data and information saved in your device. ► p. 31

# Get to know the Home screen

From the Home screen, you can view your device's status and access applications.

The Home screen has multiple panels. Scroll left or right to view the panels on the Home screen. You can also select one of the dots at the top of the screen to move directly to the corresponding panel.

## › System bar

From the system bar at the bottom of the screen, you can quickly navigate screen, view system information, and more.

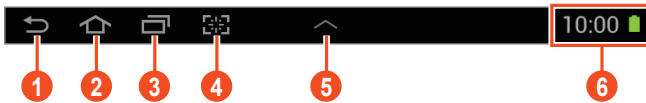









Number	Function
1	Return to the previous screen.
2	Return to the Home screen.
3	Open the list of recent applications; Access the application list (tap and hold).
4	Launch the application that you specified as the quick launch shortcut. You can change this quick launch shortcut by selecting <b>Settings</b> → <b>Display</b> → <b>Quick launch</b> .
5	Open the mini apps panel.
6	View the current time and your device's status; Open the notifications panel.

## › Indicator icons



Icons shown on the display may vary depending on your region or service provider.

Icon	Definition
	Wi-Fi AP connected
	Bluetooth feature activated
	GPS-based services in use
	Connected to computer
	New message
	Alarm activated
	Flight mode activated
	Error occurred or caution required
	Battery power level

## › Use the notifications panel

To open the notifications panel, tap the right bottom of the screen. To hide the panel, select .

From the notifications panel, you can view your device's current status and use the following options:

- **Wi-Fi:** Activate or deactivate the Wi-Fi feature. ► p. 80
- **GPS:** Activate or deactivate the GPS feature. ► p. 88
- **Sound:** Activate or deactivate Silent mode. You can mute your device or set it to vibrate in Silent mode.





- **Screen rotation:** Allow or prevent the interface from rotating when you rotate the device.
- **Power saving:** Activate or deactivate Power saving mode.
- **Notification:** Hide or show notification icons.
- **Bluetooth:** Activate or deactivate the Bluetooth feature.  
▶ p. 86
- **Driving mode:** Activate or deactivate Driving mode.
- **Sync:** Activate or deactivate auto-syncing of applications.



The options available may vary depending on your region or service provider.

## › Move an item on the Home screen

Tap and hold an item, and then drag it to a new location. You can add an item to a new folder or move it to a new panel. Tap and hold the item, and then drag it to  or .

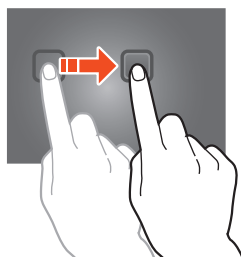

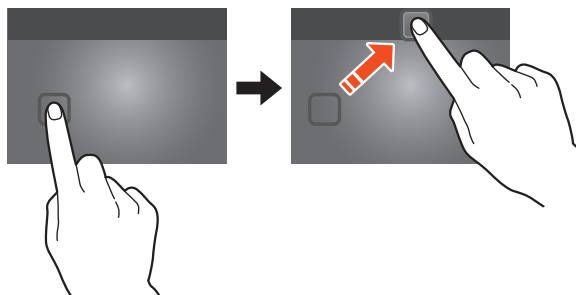

## › Remove an item from the Home screen

Tap and hold an item, and then drag it to the rubbish bin.



## › Add or remove a panel from the Home screen

You can add or remove Home screen panels to organise widgets.

- 1 On the Home screen, place two fingers on the screen and pinch them together to switch to Edit mode.
- 2 Add, remove, or reorganise panels:
  - To remove a panel, tap and hold the panel's thumbnail image, and then drag it to the rubbish bin.
  - To add a new panel, select .
  - To set the main panel of the Home screen, select .
  - To change the order of panels, tap and hold the panel's thumbnail image, and then drag it to a new location.
- 3 Select  to return to the previous screen.

## › Use widgets



Widgets are small applications that provide convenient functions and information on your Home screen.

 The widgets available may vary depending on your region or service provider.

- 1 In the application list, select **Widgets** to open the widget panel.
- 2 Scroll left or right on the widget panel to find a widget.
- 3 Tap and hold a widget to add it to the Home screen.

## Access applications

Launch applications and take full advantage of features on your device. You can reorganise the application list to match your preferences, or download applications from the Internet to enhance your device's functionality.

- 1 On the Home screen, select  to access the application list.
- 2 Scroll left or right to another screen.  
You can also select one of the dots at the bottom of the screen to move directly to the corresponding screen.
- 3 Select an application.
- 4 Select  to return to the previous screen. Select  to return to the Home screen.



- You can add an application shortcut to the Home screen by tapping and holding an icon in the application list.
- If you rotate the device while using some features, the interface will rotate as well. To prevent the interface from rotating, select **Settings** → **Display** → **Auto-rotate screen**.
- Before using location services, such as map and navigation applications, or Internet services, ensure that the wireless connection is active.



## › Organise applications

You can change the order of applications in the application list or group them into categories.

1 In the application list, select  → **Edit**.

2 Tap and hold an application icon.

3 Organise applications:

- To move the application, drag it to a new location.
- To add the application to a new folder, drag it to .
- To move the application to a new panel, drag it to .
- To uninstall the application, drag it to .

 When you drag the application icon to , you can view information about the application.

4 Select **Save**.

## › Download an application

1 In the application list, select **Play Store** or **Samsung Apps**.

2 Search for an application and download it to the device.

 To install applications that you downloaded from other sources, you must select **Settings** → **Security** → **Unknown sources**.

## › Uninstall an application

1 In the application list, select  → **Uninstall**.

2 Select  on an application icon and then select **OK**.

 You can uninstall only the applications that you have downloaded.

## › Access recently-used applications

- 1 Select  to view the applications you have accessed recently.
- 2 Select an application.

## Launch multiple applications

Your device allows you to multitask by running multiple applications at the same time. To launch multiple applications, select  while using an application. Then select another application to launch from the Home screen.

## › Manage applications

You can manage multiple applications with the task manager.

- 1 Select  → **Task manager** → **Active applications**.  
The task manager launches and shows active applications.
- 2 Control active applications:
  - To switch applications, select one from the list.
  - To close an application, select **End**.
  - To close all active applications, select **End all**.

## Customise your device

Get more from your device by changing settings to match your preferences.

## › Change the display language

- 1 In the application list, select **Settings** → **Language and input** → **Language**.
- 2 Select a language.

## › Turn on or off the touch tones

In the application list, select **Settings** → **Sound** → **Touch sounds**.

## › Adjust the device's volume

- 1 Press the Volume key up or down.
- 2 Select  and drag the sliders to adjust the volume level for each sound.

## › Switch to Silent mode

To mute or unmute your device, do one of the following:

- Tap the right bottom of the screen to open the notifications panel, and then select **Sound**.
- Press and hold the Power key, and then select **Silent mode**.

## › Select a wallpaper for the Home screen

- 1 On the Home screen, tap and hold the empty area.
- 2 Select **Home screen** → an image folder → an image.

## › Change the display font

- 1 In the application list, select **Settings** → **Display** → **Font style**.
- 2 Select a font.

## › Adjust the brightness of the display

Your device includes a light sensor, which can detect the level of ambient light and adjust the brightness of the display automatically. You can also manually set the brightness of the display.



The brightness of the display will affect how quickly the device consumes battery power.

## Set your device to adjust the brightness automatically

- 1 In the application list, select **Settings** → **Display** → **Brightness**.
- 2 Select the tick box next to **Automatic brightness**.
- 3 Select **OK**.  
The device will increase the brightness in bright surroundings and decrease the brightness in dim surroundings automatically.

## Adjust the brightness manually

- 1 In the application list, select **Settings** → **Display** → **Brightness**.
- 2 Clear the tick box next to **Automatic brightness**.
- 3 Drag the slider to the left or right.
- 4 Select **OK**.

## › Lock your device

You can lock your device by activating the screen lock feature. Once the screen lock is enabled, your device will require your password each time you turn it on or unlock the touch screen.



- If you forget your password, take your device to a Samsung Service Centre to reset it.
- Samsung is not responsible for the loss of passwords or private information, or other damages caused by illegal software.

## Set a face detection unlock

- 1 In the application list, select **Settings** → **Security** → **Screen lock** → **Face unlock**.
- 2 Select **Set it up** → **Continue**.
- 3 Adjust the device to fit your face inside the figure.
- 4 When your face is captured correctly, select **Continue**.
- 5 Complete the setup of the secondary unlock PIN or pattern.

## Set an unlock pattern

- 1 In the application list, select **Settings** → **Security** → **Screen lock** → **Pattern**.
  - 2 View the on-screen instructions and the example pattern, and then select **Next**.
  - 3 Draw a pattern to connect at least 4 dots and select **Continue**.
  - 4 Draw the pattern again to confirm and select **Confirm**.
  - 5 Complete the setup of the backup PIN.
-  If you forget your unlock pattern, you can deactivate the screen lock feature with a backup PIN.

## Set an unlock PIN

- 1 In the application list, select **Settings** → **Security** → **Screen lock** → **PIN**.
- 2 Enter a new PIN and select **Continue**.
- 3 Enter the PIN again and select **OK**.



## Set an unlock password

- 1 In the application list, select **Settings** → **Security** → **Screen lock** → **Password**.
- 2 Enter a new password (alphanumeric) and select **Continue**.
- 3 Enter the password again and select **OK**.

## ▶ Activate the Find my mobile feature

When your device is lost or stolen, you can view the current location of your device on the SamsungDive website ([www.samsungdive.com](http://www.samsungdive.com)). To use this feature, you must create a Samsung account for controlling the device remotely via the Internet.

- 1 In the application list, select **Settings** → **Security** → **Remote controls** → **OK** → **Add account**.
- 2 Select **Sign in** → your region.  
To create a Samsung account, select **Sign up**.
- 3 Enter the email address and password for your Samsung account, and then select **Sign in**.
- 4 Select the tick box next to **Use wireless networks** → **Agree**.

## Enter text

You can enter text by speaking words into the microphone, selecting characters on the virtual keypad, or by writing on the screen.

-  Text entry is not supported in some languages. To enter text, you must change the input language to one of the supported languages.

## › Change the text input method

Select  on the system bar and select a text input method.

## › Enter text with the Google voice input feature

- 1 To add input languages for voice recognition, select the language → **Add more languages**.
- 2 Speak your text into the microphone.
- 3 When you are finished, select **Done**.

## › Enter text with the Samsung keypad

Enter text by selecting alphanumeric keys or writing on the screen.

You can also use the following keys:

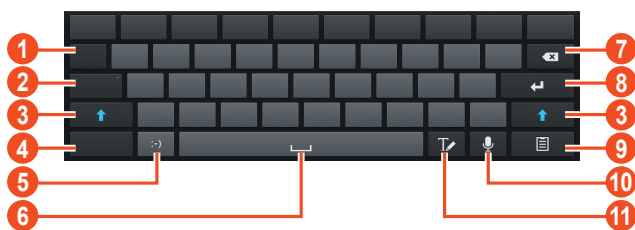



Number	Function
1	Move the cursor to the next text field.
2	Switch to Caps lock mode.
3	Change the case.
4	Switch text input modes.
5	Insert an emoticon; Open the emoticon panel (tap and hold).
6	Insert a space.
7	Clear your input.

Number	Function
8	Start a new line.
9	Add an item from the clipboard.
10	Enter text by voice. This feature is available only when you activate the voice input feature.
11	Switch to Handwriting mode.

## › Copy and paste text

From a text field, you can copy and paste text to another application.

- 1 Tap and hold a passage of text.
- 2 Drag  or  to select the text to be copied.
- 3 Select **Copy** or **Cut** to add the text to the clipboard.
- 4 In another application, place the cursor at the point where the text will be inserted.
- 5 Select  → **Paste** to insert the text from the clipboard into the text field.

# Web and GPS-based services



You may incur additional charges for accessing the Internet and downloading media files. For details, contact your service provider.

## Internet

Learn to access and bookmark your favourite webpages.



- This feature may be labelled differently depending on your region or service provider.
- Available icons may vary depending on your region or service provider.

### › Browse a webpage









- 1 In the application list, select **Internet**.
- 2 To access a specific webpage, select the URL field, enter the web address, and then select **Go**.
- 3 Navigate webpages with the following keys:







Number	Function
1	Open a new window.
2	Close the current tab.
3	Move backwards or forwards to webpages in history.

Number	Function
4	Reload the current webpage. While the device is loading webpages, this icon changes to  .
5	Enter a web address or a keyword.
6	Access web browser options.
7	View your bookmarks, saved pages, and recent Internet history.
8	Activate the URL field.
9	Bookmark the current webpage.

While browsing a webpage, access the following options:

- To zoom in or out, place two fingers on the screen and slowly spread them apart or pinch them together. To return to the original size, double-tap the screen.
- To reload the current webpage, select  → **Refresh**.
- To move backwards or forwards to webpages in history, select  or select  → **Forward**.
- To open a new window, select  → **New tab**.
- To open a new window without saving your browsing data, select  → **New incognito tab**.
- To bookmark the current webpage, select  → **Add bookmark**.
- To send a web address to others, select  → **Share page**.
- To search for text on a webpage, select  → **Find on page**.
- To switch to the desktop view, select  → **Request desktop site**.

- To save the current webpage for reading offline, select  → **Save for offline reading**. You can view the saved pages by selecting  → **Saved pages**.
- To view your download history, select  → **Downloads**.
- To print the webpage via Wi-Fi or USB, select  → **Print**. Your device is compatible only with some Samsung printers.
- To change the browser settings, select  → **Settings**.

## ➤ Search for information by voice





This feature may be unavailable depending on your region or service provider.

- 1 In the application list, select **Internet**.
- 2 Select the URL field.
- 3 Select  and say a keyword into your device's microphone.  
The device searches for webpages related to the keyword.
- 4 Select a search result.

## ➤ Bookmark your favourite webpage

If you know the address of a webpage, you can add a bookmark manually.

- 1 In the application list, select **Internet**.
- 2 Enter a web address or navigate to a webpage.
- 3 Select  → **Add bookmark**.
- 4 Enter a name for the bookmark and select **OK**.

To view your bookmarks, select  → **Bookmarks**. From the bookmark list, tap and hold a bookmark to access the following options:

- To open the webpage in the current window, select **Open**.
- To open a new window, select **Open in new tab**.
- To edit bookmark details, select **Edit bookmark**.
- To add the bookmark shortcut to the Home screen, select **Add shortcut to home**.
- To send the address of the current webpage to others, select **Share link**.
- To copy the address of the current webpage, select **Copy link URL**.
- To delete the bookmark, select **Delete bookmark**.
- To set the webpage as your browser's homepage, select **Set as homepage**.

## ► Download a file from the Internet

When you download files or applications from the Internet, your device saves them to the internal memory.

 Files you download from the Internet can include viruses that will damage your device. To reduce this risk, only download files from sources you trust.

 Some media files include Digital Rights Management to protect copyrights. This protection may prevent you from downloading, copying, modifying, or transferring some files.

- 1 In the application list, select **Internet**.
- 2 Search for a file or application and download it to the device.

## › View your recent history

- 1 In the application list, select **Internet** →  → **History**.
- 2 Select a webpage to access.

## Game Hub

Learn to access and download games.

- 1 In the application list, select **Game Hub**.
- 2 Select and install a game.
- 3 Follow the on-screen instructions.

 The games available may vary depending on your region or service provider.

## Latitude

Learn to share your location with your friends and view their locations with the Google Latitude™ location service.

 This feature may be unavailable depending on your region or service provider.

- 1 In the application list, select **Latitude**.  
The device joins Latitude automatically.
- 2 Select  → **Add friends** → an option.
- 3 Select a friend, or enter an email address and select **Add friends**.
- 4 Select **Yes**.  
When your friend accepts your invitation, you can share locations.





# Maps

Learn to use the Google Maps™ mapping service to find your location, search for places, and get directions.









- This feature may be unavailable depending on your region or service provider.
- You must activate location services to find your location and search the map. ► p. 88



## › Search for a location

- 1 In the application list, select **Maps**.  
The map will show your current location.
- 2 Select **Search Maps**.
- 3 Enter a keyword for the location and select .  
To search for a location by voice, select .
- 4 Select the location to view its details.

While viewing the map, use the following options:

- To zoom in or out, place two fingers on the screen and slowly spread them apart or pinch them together.
- To view all of the search results, select **Search Results**.
- To view your current location, select . To switch to the compass view of the map that changes orientation when you move the device, select .
- To search for a place nearby, select .
- To get directions to a specific destination, select .
- To add layers of additional information to the map or change the view mode, select .
- To add a star to the location, select the balloon with the location name → .

## › Get directions to a specific destination

- 1 In the application list, select **Maps**.
- 2 Select .
- 3 Enter the addresses of the starting location and the destination.  
To enter an address from your contact list or starred places, or select a point on the map, select  → an option.
- 4 Select a travel method and select **Go**.  
The route is indicated on the map. Depending on the selected travel method, you may see multiple routes.
- 5 When you are finished, select  → **Clear Map**.

## Navigation

Learn to get spoken directions to your destination.



- Navigation maps, your current location, and other navigational data may differ from actual location information. You should always pay attention to road conditions, traffic, and any other factors that may affect your driving and follow all safety warnings and regulations while driving.
- This feature may be unavailable depending on your region or service provider.

- 1 In the application list, select **Navigation**.
- 2 Enter your destination with the following methods:
  - **Speak destination:** Enter your destination by voice.
  - **Type destination:** Enter your destination with the virtual keypad.

- **Contacts:** Select your destination from contacts' addresses.
  - **Starred places:** Select your destination from your starred places.
- 3 Install the required software, and then use the navigation features.

## Places

Learn to search for business and attractions.

 This feature may be unavailable depending on your region or service provider.

- 1 In the application list, select **Places**.
- 2 If you want to search for businesses or attractions near a specific location, select your location → **Enter an address**.
- 3 Select a category.  
The device searches for places nearby that are related to the category.
- 4 Select a place name to view its details.

 You can add more categories by selecting  → **Add a search**.

## Play Store

Your device's functionality can be extended by installing additional applications. Play Store provides a quick and easy way to shop for mobile applications.

-  • This feature may be unavailable depending on your region or service provider.
- Your device will save user files from downloaded applications to the internal memory.

## › Download an application

- 1 In the application list, select **Play Store**.
- 2 Search for an application and download it to the device.  
When the download is complete, the device will install the application automatically.

## › Uninstall an application

- 1 In the application list, select **Play Store**.
- 2 Select .
- 3 Select an item.
- 4 Select **Uninstall** → **OK**.

## Readers Hub

Learn to access various reading materials.

- 1 In the application list, select **Readers Hub**.
- 2 Select a type of reading material.
- 3 Search for and download reading material from the online store.

## Samsung Apps

Samsung Apps allows you to easily download a wide range of applications and updates for your device. With fully optimised applications from Samsung Apps, your device becomes even smarter. Explore the useful applications on offer and enhance your mobile life.

- 1 In the application list, select **Samsung Apps**.

2 Search for and download applications to the device.



- This feature may be unavailable depending on your region or service provider.
- For details, please visit [www.samsungapps.com](http://www.samsungapps.com) or refer to the Samsung Apps leaflet.

## S Suggest

Find and download the latest applications suggested by Samsung. In the application list, select **S Suggest**.



- This feature may be unavailable depending on your region or service provider.

## YouTube

Learn to view and upload videos via the YouTube™ video sharing service.



- This feature may be unavailable depending on your region or service provider.

## › Play a video

1 In the application list, select **YouTube**.

2 Select a video.

3 Control playback with the following keys:

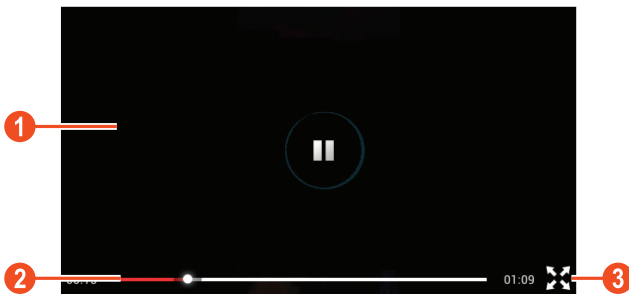

Number	Function
1	Pause or resume playback.
2	Scan forwards or backwards in the file by dragging the bar.
3	Play the video on the full screen.

## › Upload a video

- 1 In the application list, select **YouTube**.
- 2 Select **ACCOUNT**.
- 3 Select your Google account if it is linked to YouTube. Alternatively, you can select **Add account** and set up an account to sign in to YouTube.
- 4 Select **UPLOAD** → a video.  
 If you are uploading a video for the first time, select a network type to upload a video.
- 5 Enter the details of the upload and select **Upload**.

# Communication



## Google Mail

Learn to send or view email messages via the Google Mail™ webmail service.



- This feature may be unavailable depending on your region or service provider.
- This feature may be labelled differently depending on your region or service provider.

### › Send an email message

- 1 In the application list, select **Google Mail** → .
- 2 Select the recipient field and enter an email address.
- 3 Select the subject field and enter a subject.
- 4 Select the text field and enter your email text.
- 5 Select  and attach a file.
- 6 To send the message, select **SEND**.











If you are offline, the message will be held in the message thread until you are online.

### › View an email message

- 1 In the application list, select **Google Mail**.
- 2 Select  to update the message list.
- 3 Select an email message.

From the message view, use the following options:

- To move to the next or previous message, scroll right or left.
- To reply to the message, select .
- To reply to the message and include all recipients, select .
- To forward the message to others, select .
- To add the message to the favourites list, select .
- To view an attachment, select **VIEW**. To save it to your device, select **SAVE**.
- To search for a message, select .
- To archive the message, select .
- To delete the message, select .
- To add a label to the message, select .
- To mark the message as unread, select  → **Mark unread**.
- To mark the message as important, select  → **Mark as important**.
- To hide the message, select  → **Mute**. To view hidden messages, select **All mail** from the label list.
- To add the message to the spam list, select  → **Report spam**.
- To update the message list, select  → **Refresh**.
- To customise the settings for each label, select  → **Manage labels**.
- To change the email settings, select  → **Settings**.



The options available may vary depending on the email account or device's orientation.



# Email



Learn to send or view email messages via your personal or company email account.

## › Set up an email account

- 1 In the application list, select **Email**.
- 2 Enter your email address and password.
- 3 Select **Next**. To enter account details manually, select **Manual setup**.
- 4 Follow the on-screen instructions.

When you are finished setting up the email account, email messages will be downloaded to your device. If you have created two or more accounts, you can switch between them. Select an account name at the top of the screen, and then select the account from which you want to retrieve messages.

## › Send an email message

- 1 In the application list, select **Email** → .
- 2 Add recipients:
  - Enter email addresses manually and separate them with a semicolon or a comma.
  - Select email addresses from your contact list by selecting .
- 3 Select the subject field and enter a subject.
- 4 Select the text field and enter your email text.
- 5 Select  and attach a file.
- 6 To send the message, select **Send**.

















If you are offline, the message will be held in the message thread until you are online.

## › View an email message

- 1 In the application list, select **Email**.
- 2 Select  to update the message list.
- 3 Select an email message.

From the message view, use the following options:

- To reply to the message, select .
- To forward the message to others, select .
- To delete the message, select .
- To mark the message as unread, select  → **Mark as unread**.
- To save the message to your device, select  → **Save email**. The message will be saved in **My files** → **sdcard** → **Saved Email**.
- To sort messages, select  → **Sort by**.
- To change the view mode of the message list, select  → **View mode**.
- To change the font colour of messages, select  → **Font color**.
- To change the background colour of messages, select  → **Background color**.
- To print the message via Wi-Fi or USB, select  → **Print**. Your device is compatible only with some Samsung printers.
- To save the email addresses of the recipients to the phonebook as a group of contacts, select  → **Save as group**.
- To change the email settings, select  → **Settings**.
- To delete all messages, select  → **Delete all**.
- To save an attachment to your device, select the attachment tab → .



The options available may vary depending on the email account or device's orientation.

# Talk

Learn to send and receive instant messages to friends and family with the Google Talk™ instant messaging service.



This feature may be unavailable depending on your region or service provider.





## › Set your status

- 1 In the application list, select **Talk**.
- 2 Select a Google account.
- 3 Customise your status, image, and message.

## › Add a contact to your friend list

- 1 In the application list, select **Talk** → .
- 2 Enter a friend's email address, and then select **DONE**.  
When your friend accepts the invitation, he or she is added to your friend list.

## › Start a conversation

- 1 In the application list, select **Talk**.
- 2 Select a contact from the friend list.  
The conversation screen opens.
- 3 Enter and send your message.
  - To add more contacts to the conversation, select  → **Add to chat**.
  - To use video chat, select .
  - To use voice chat, select .
- 4 Select  → **End chat** to end the conversation.

## ChatON

Learn to use ChatON to send and receive instant messages from any device that has a mobile phone number.

1 In the application list, select **ChatON**.

 If you are launching this application for the first time, follow the on-screen instructions to complete the account setup.

2 Enter and send your message.

## Messenger

Learn to send and receive instant messages from friends and family with the Google+ messenger instant messaging service.

1 In the application list, select **Messenger**.

 If you are launching this application for the first time, follow the on-screen instructions to complete the account setup.

2 Enter and send your message.

## Google+

Learn to access Google's social network service. You can create groups to send and receive instant messages and upload your photos.

1 In the application list, select **Google+**.

 If you are launching this application for the first time, follow the on-screen instructions to complete the account setup.

2 Select a social network feature.

# Entertainment

## Camera

Learn how to take and view photos and videos. You can take photos at resolutions up to 2048 x 1536 pixels (3.2 megapixels) and record videos at resolutions up to 1280 x 720 pixels.





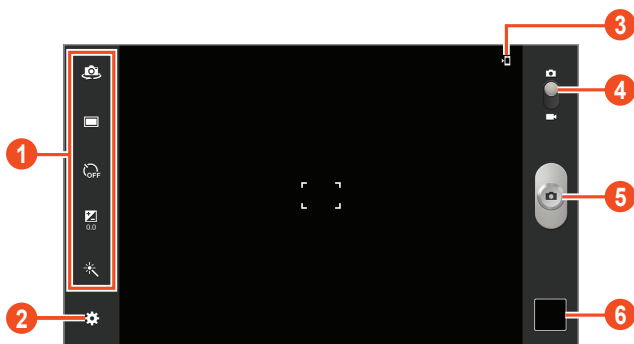

- The camera turns off automatically when you do not use it for a specified period.
- The memory capacity may differ depending on the scene or shooting conditions.

### › Take a photo

- 1 In the application list, select **Camera**.
- 2 Aim the camera lens at the subject and make any necessary adjustments.















Number	Function
1	<p>Use camera shortcuts.</p> <ul style="list-style-type: none"> <li>• : Switch to the front camera to take a photo of yourself.</li> <li>• : Change the shooting mode. ► p. 55</li> <li>• : Select the length of the delay before the camera takes a photo.</li> <li>• : Adjust the exposure value to change the brightness.</li> <li>• : Apply a special effect.</li> </ul> <p>You can add or remove shortcuts to frequently-used options. ► p. 60</p>
2	Change the camera settings.
3	View the storage location.
4	Switch to the camcorder.
5	Take a photo.
6	View photos you have taken.

3 Select  to take a photo.

The photo is saved automatically.

After taking a photo, select the image viewer to view it.

- To view more photos, scroll left or right.
- To zoom in or out, place two fingers on the screen and slowly spread them apart or pinch them together. To return to the original size, double-tap the screen.
- To send the photo to others, select .

- To view the photo on a DLNA certified device, select .
- To delete the photo, select .
- To add the photo to the clipboard, select  → **Copy to clipboard**.
- To rotate the photo anti-clockwise, select  → **Rotate left**.
- To rotate the photo clockwise, select  → **Rotate right**.
- To crop a section from the image, select  → **Crop**.
- To edit the photo with the image editor, select  → **Edit**.  
▶ p. 65
- To set the photo as your wallpaper or a contact image, select  → **Set picture as**.
- To start a slide show, select  → **Slideshow**. Tap the screen to stop the slide show.
- To print the photo via Wi-Fi or USB, select  → **Print**. Your device is compatible only with some Samsung printers.
- To change the name of a file, select  → **Rename**.
- To view photo details, select  → **Details**.

## › Change the shooting mode

You can take photos with various shooting modes. To change the shooting mode, select  → **Shooting mode** → an option.

Option	Function
Smile shot	Set the device to recognise people's faces and help you take photos of them when they smile.
Panorama	Take panoramic photos.

## › Customise camera settings

Before taking a photo, select  to access the following options:

Option	Function
Edit shortcuts	Edit shortcuts to frequently-used options.
Self portrait	Take photos of yourself with the front camera.
Shooting mode	Change the shooting mode. ► p. 55
Scene mode	Change the scene mode.
Exposure value	Adjust the exposure value to change the brightness.
Timer	Select the length of the delay before the camera takes a photo.
Effects	Apply a special effect.
Resolution	Select a resolution option.
White balance	Adjust the colour balance according to the lighting conditions.
Metering	Select a type of exposure metering.
Guidelines	Set to view the grid lines on the preview screen.







Option	Function
GPS tag	<p>Set the camera to include location information for your photos.</p>  <ul style="list-style-type: none"> <li>To improve GPS reception, avoid shooting in locations where the signal may be obstructed, such as between buildings or in low-lying areas, or in poor weather conditions.</li> <li>Your location may appear on your photos when you upload them to the Internet. To avoid this, deactivate the GPS tag setting.</li> </ul>
Storage	Select a memory location for saving captured photos.
Reset	Reset camera settings.

## ► Record a video

- 1 In the application list, select **Camera**.
- 2 Drag the slider to switch to the camcorder.
- 3 Aim the lens at the subject and make any necessary adjustments.



Number	Function
1	<p>Use camcorder shortcuts.</p> <ul style="list-style-type: none"> <li>•  : Switch to the front camera to record a video of yourself.</li> <li>•  : Change the recording mode (for attaching to a message or for saving normally).</li> <li>•  : Select the length of the delay before the camcorder records a video.</li> <li>•  : Adjust the exposure value to change the brightness.</li> <li>•  : Apply a special effect.</li> </ul> <p>You can add or remove shortcuts to frequently-used options. ► p. 60</p>
2	Change the camcorder settings.
3	View the storage location.
4	Switch to the camera.
5	Record a video.
6	View videos you have recorded.

4 Select  to start recording.



5 Select  to stop recording.





The video is saved automatically.



The camcorder may not be able to properly record videos on memory cards with slow transfer speeds.

After recording a video, select the image viewer to view it.

- To view more videos, scroll left or right.
- To play the video, select .
- To send the video to others, select .
- To play the video on a DLNA certified device, select .

- To delete the video, select .
- To start a slide show, select  → **Slideshow**. Tap the screen to stop the slide show.
- To change the name of a file, select  → **Rename**.
- To view video details, select  → **Details**.

## › Customise camcorder settings

Before recording a video, select  to access the following options:

Option	Function
Edit shortcuts	Edit shortcuts to frequently-used options.
Self recording	Switch to the front camera to record a video of yourself.
Recording mode	Change the recording mode (for attaching to a message or for saving normally).
Exposure value	Adjust the exposure value to change the brightness.
Timer	Select the length of the delay before the camcorder starts recording a video.
Effects	Apply a special effect.
Resolution	Select a resolution option.
White balance	Adjust the colour balance according to the lighting conditions.
Guidelines	Set to view the grid lines on the preview screen.
Storage	Select a memory location for saving recorded videos.
Reset	Reset camcorder settings.

## › Edit the shortcut icons

You can add or remove shortcuts to frequently-used options.

- 1 From the preview screen, select  → **Edit shortcuts**.
- 2 Tap and hold an icon from the option list, and then drag it to the shortcut area.  
To remove shortcuts, tap and hold an icon, and then drag it to the option list.
- 3 Tap the screen to return to the preview screen.

## Video player

Learn to use the video player.



- Some file formats are not supported depending on the device's software.
- If a file size exceeds the memory available, an error may occur when you try to open the file.
- Playback quality may vary by content type.
- Some files may not play properly depending on how they are encoded.

## ▶ Play a video

1 In the application list, select **Video player**.

2 Select a video.

3 Control playback with the following keys:

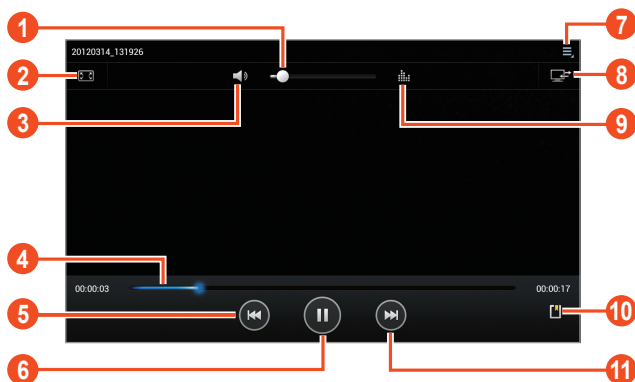

Number	Function
1	Adjust the volume.
2	Change the ratio of the video screen.
3	Mute the sound.
4	Scan forwards or backwards in the file by dragging or tapping the bar.
5	Restart playback; Skip to the previous file (tap within 3 seconds); Scan backwards in the file (tap and hold).

Number	Function
6	Pause playback; Select  to resume playback.
7	Access video player options.
8	Play the video on a DLNA certified device.
9	Select a sound effect.
10	Insert a bookmark.
11	Skip to the next file; Scan forwards in the file (tap and hold).

During playback, select  to access the following options:

- To listen to audio via a Bluetooth headset, select **Via Bluetooth**. You cannot use this option if you connect a headset to your device's headset jack.
- To send the video to others, select **Share via**.
- To trim a segment of the video, select **Trim**.
- To change the playback speed, select **Play speed**.
- To view your bookmarks, select **Bookmarks**. This option appears if you have inserted a bookmark during playback.
- To change the settings for the current subtitle file, select **Subtitles**. To open a subtitle file, select **Select subtitles**.
- To set the video player to play the next file automatically, select **Auto play next**.
- To edit the video with the video editor, select **Video maker**.
- To view video details, select **Details**.

## Gallery

Learn to view images and play videos saved in your device.











- Some file formats are not supported depending on the device's software.
- If a file size exceeds the memory available, an error may occur when you try to open the file.
- Playback quality may vary by content type.
- Some files may not play properly depending on how they are encoded.





### › View an image

1 In the application list, select **Gallery**.

2 Select a folder → an image.

While viewing an image, use the following options:



- To view more images, scroll left or right.
- To zoom in or out, place two fingers on the screen and slowly spread them apart or pinch them together. To return to the original size, double-tap the screen.
- To send the image to others, select .
- To view the image on a DLNA certified device, select .
- To delete the image, select .
- To add the image to the clipboard, select  → **Copy to clipboard**.
- To rotate the image anti-clockwise, select  → **Rotate left**.
- To rotate the image clockwise, select  → **Rotate right**.
- To crop a section from the image, select  → **Crop**.
- To edit the image with the image editor, select  → **Edit**.  
▶ p. 65
- To set the image as your wallpaper or a contact image, select  → **Set picture as**.

- To start a slide show, select  → **Slideshow**. Tap the screen to stop the slide show.
- To print the image via Wi-Fi or USB, select  → **Print**. Your device is compatible only with some Samsung printers.
- To change the name of a file, select  → **Rename**.
- To view image details, select  → **Details**.



The options available may vary depending on the selected folder.

## › Play a video

- 1 In the application list, select **Gallery**.
- 2 Select a folder → a video (indicated by the  icon).
- 3 Select  to begin playback.
- 4 Control playback with the keys. ▶ p. 60



During playback, select  to access the following options:



- To listen to audio via a Bluetooth headset, select **Via Bluetooth**. You cannot use this option if you connect a headset to your device's headset jack.
- To send the video to others, select **Share via**.
- To trim a segment of the video, select **Trim**.
- To change the playback speed, select **Play speed**.
- To view your bookmarks, select **Bookmarks**. This option appears if you have inserted a bookmark during playback.
- To change the settings for the current subtitle file, select **Subtitles**. To open a subtitle file, select **Select subtitles**.
- To edit the video with the video editor, select **Video maker**.
- To view video details, select **Details**.



## Photo editor

You can edit images and apply various effects.

- 1 In the application list, select **Photo editor**.
- 2 Select an image, or select **Select picture** → a folder → an image.  
To take a new photo, select **Take picture**.
- 3 Select **Selection** → **OK**.
- 4 Draw a border around the area you want to select, and then select **Done**.
  - To change the type of selection tool, select **Selection**.
  - To edit the selection border, select , , or . If you select **Magnetic** or **Brush**, you can adjust the border size by selecting **Selection size**.
  - To reverse the selection, select **Inverse**.
- 5 Edit the image with the following tools:

Tool	Function
Rotate	Rotate or flip the image.
Resize	Resize the image by dragging the rectangle or selecting <b>100%</b> → an option.
Crop	Crop the image by moving or dragging the rectangle.
Colour	Apply a colour effect.
Effect	Apply a filter effect.
Tools	Use additional tools.
	Undo your last action.
	Redo your last action.

- 6 When you are finished, select .
- 7 Enter a name for the image and select **OK**.

## Video maker

You can edit videos and apply various effects. The video editor supports the following video resolutions: 176 x 144, 320 x 240, 640 x 480, 720 x 480, 1280 x 720, 1920 x 1080 (Import up to 1920 x 1080, export up to 1280 x 720).

### › Create a video

- 1 In the application list, select **Video maker**.
- 2 Select **New Project**.
- 3 Select a frame theme.
- 4 Select a category.
- 5 Tap and hold a file, and then drag it to the bottom of the screen.
  - To set the length of time that an image appears, select the thumbnail, and then drag the left or right border of the thumbnail.
  - To delete images or videos, tap and hold an item, and then drag it to the rubbish bin.
  - To rearrange images or videos, tap and hold an item, and then drag it to a new location.
  - To add a caption to an image or video, drag the thumbnail to place the yellow line at the desired point, and then select **T** on the preview image.
- 6 Select **Transition** and drag an effect option to a transition effect icon between images or videos.
- 7 When you are finished, select  → **Export**.
- 8 Select a resolution option.
- 9 Enter a name for the video and select **OK**.

## › Trim a segment of a video

- 1 Launch the video editor and open a video file.
- 2 Select the thumbnail.
- 3 Move the start bracket to the point where trimming should begin.
- 4 Move the end bracket to the point where the trimming should end.
- 5 Save the edited video.

## › Split a video

- 1 Launch the video editor and open a video file.
- 2 Select the thumbnail.
- 3 Drag the thumbnail at the bottom of the screen to place the yellow line.
- 4 Select .
- 5 Save the edited video.

## › Apply an effect to a video

- 1 Launch the video editor and open a video file.
- 2 Drag the thumbnail at the bottom of the screen to place the yellow line.
- 3 Select **Effect** → an effect option.
- 4 Save the edited video.

## Music player

Learn to listen to your favourite music while on the go.



- Some file formats are not supported depending on the device's software.
- If a file size exceeds the memory available, an error may occur when you try to open the file.
- Playback quality may vary by content type.
- Some files may not play properly depending on how they are encoded.

### › Add music files to your device

Start by transferring files to your device or memory card:

- Download from the Internet. ► p. 36
- Download from a computer with Samsung Kies. ► p. 78
- Download from a computer with Windows Media Player. ► p. 78
- Receive via Bluetooth. ► p. 87
- Copy to your memory card. ► p. 79

### › Play music

- 1 In the application list, select **Music player**.
- 2 Select a music category → a music file.
- 3 Select the album image to open the music player screen.

#### 4 Control playback with the following keys:



Number	Function
1	Adjust the volume.
2	Set the file as your favourite track.
3	Mute the sound.
4	Scan forwards or backwards in the file by dragging or tapping the bar.
5	Activate Shuffle mode.
6	Restart playback; Skip to the previous file (tap within 3 seconds); Scan backwards in the file (tap and hold).
7	Pause playback; Select ▶ to resume playback.

Number	Function
8	View music details.
9	Open the playlist.
10	Access music options.
11	Play the music file on a DLNA certified device.
12	Select a sound effect.
13	Change the repeat mode.
14	Skip to the next file; Scan forwards in the file (tap and hold).





You can control the music player with a headset. On the Home screen, press and hold the headset button to launch the music player. Then, press the headset button to start or pause playback.

During playback, select  to access the following options:

- To add the music file to a playlist, select **Add to playlist**.
- To listen to music via a Bluetooth headset, select **Via Bluetooth**. You cannot use this option if you connect a headset to your device's headset jack.
- To send the music file to others, select **Share via**.
- To set the music file as your alarm tone, select **Set as alarm tone**.
- To change the music player settings, select **Settings**.

## › Create a playlist

- 1 In the application list, select **Music player**.
- 2 Select  → **New playlist**.
- 3 Enter a title for your new playlist and select **OK**.
- 4 Select a music category and select  next to the files to include.
- 5 Select **Done**.

## › Customise music player settings

- 1 In the application list, select **Music player**.
- 2 Select  → **Settings**.
- 3 Change the following options:

Option	Function
Advanced → SoundAlive	Select a sound effect.
Advanced → Play speed	Change the playback speed.
Advanced → Lyrics	Set to show song lyrics during playback.
Advanced → Music auto off	Set the music player to turn off automatically after a specific period of time.
Music menu	Select music categories to show in the music library.

## Music Hub

You can access the online music store to search for and buy your favourite songs. You can also add music files to your wish list and play them.



This feature may be unavailable depending on your region or service provider.

- 1 In the application list, select **Music Hub**.
- 2 Search for, preview, or buy your favourite songs.



# Personal information

## Contacts

Learn to create and manage a list of your personal or business contacts. You can save names, phone numbers, email addresses, and more for your contacts.



### › Create a contact

- 1 In the application list, select **Contacts** → **Contacts** → **+**.
- 2 Select a memory location.
- 3 Enter contact information.
- 4 Select **Save** to add the contact to memory.

### › Find a contact

- 1 In the application list, select **Contacts** → **Contacts**.
- 2 Scroll up or down the contact list.
- 3 Select a contact's name.

From the contact view, use the following options:

- To send an email message, select .
- To set a favourite number, select .
- To edit the contact information, select .

## › Create your namecard

- 1 In the application list, select **Contacts** → **Contacts**.
- 2 Select your name at the top of the contact list.
- 3 Select .
- 4 Enter your personal details and select **Save**.

 You can send your namecard to others by selecting  → **Share namecard via**.

## › Create a group of contacts

By creating groups of contacts, you can manage multiple contacts and send a message to an entire group.

- 1 In the application list, select **Contacts** → **Groups** → .
- 2 Enter a name for the group.
- 3 Add members to the group.
- 4 Select **Save**.

## › Import or export a contact

You can import or export files (in vcf format) to or from your device's USB storage or a memory card.

### Import contact files

- 1 In the application list, select **Contacts** → **Contacts**.
- 2 Select  → **Import/Export** → **Import from SD card** or **Import from USB storage**.
- 3 Select a memory location.

- 4 Select an option for importing a single contact file, multiple contact files, or all contact files, and then select **OK**.
- 5 Select contact files to import, and then select **OK**.

## Export contacts

- 1 In the application list, select **Contacts** → **Contacts**.
- 2 Select  → **Import/Export** → **Export to SD card** or **Export to USB storage**.
- 3 Select **OK** to confirm.

## S Planner

Your device includes a powerful planner to help you organise your schedules more conveniently and effectively. Learn to create and manage events and tasks, and set alarms to remind yourself of important events and tasks.

### › Create an event or task

- 1 In the application list, select **S Planner**.
- 2 Select .
- 3 Select an event type at the top of the screen.
- 4 Enter the details of the event and select **Save**.

## › Change the view mode

1 In the application list, select **S Planner**.

2 Select a view mode.

- **Year:** All months in the year
- **Month:** A full month in one view
- **Week:** Hourly blocks for the days in one full week
- **Day:** Hourly blocks for one full day
- **Agenda:** A list of all the events and holidays scheduled for a specific period
- **Task:** A list of tasks



You can also change the view mode by placing two fingers on the screen and spreading them apart or pinching them together.

## › View an event or task



1 In the application list, select **S Planner**.

2 Select a date on the calendar.

- To move to a specific day, select  → **Go to** and enter the date.
- To move to today's date, select **Today**.

3 Select an event to view its details.



You can send the event to others by selecting  → **Share via** or selecting  → .

## › Stop an event or task alarm

If you set a reminder for a calendar event or task, an alarm will sound at the specified time.

- 1 Tap the right bottom of the system bar to open the notifications panel.
- 2 Select the event notification.
- 3 Select an event to view more details.  
To snooze the event alarm, select **Snooze**.

## Memo

Learn to record important information for viewing at a later date.















### › Create a memo

- 1 In the application list, select **Memo**.
- 2 Select **+**.
- 3 Enter your memo text.
- 4 Select **Done**.

### › View a memo

- 1 In the application list, select **Memo**.
- 2 Select a memo to view its details.

While viewing the memo, use the following options:

- To delete the memo, select   .
- To change the background colour, select   .
- To protect the memo from accidental deletion, select   .
- To print the memo via Wi-Fi or USB, select   . Your device is compatible only with some Samsung printers.
- To send the memo to others, select   .

# Connectivity

## USB connections

Learn to connect your device to a computer with a USB cable.

 Do not disconnect the USB cable from a computer while the device is transferring or accessing data. Doing so may result in data loss or damage to the device.

 For best results, connect the USB cable directly to a USB port on a computer. Data transfers may fail when using a USB hub.

### › Connect with Samsung Kies

Ensure that Samsung Kies is installed on your computer. You can download the program from the Samsung website.

 Samsung Kies will work on both Windows and Macintosh computers.

- 1 Connect your device to a computer with a USB cable. Samsung Kies launches on the computer automatically. If Samsung Kies does not launch, double-click the Samsung Kies icon on the computer.
- 2 Transfer files between your device and the computer. Refer to the Samsung Kies help for more information.

### › Connect with Windows Media Player

Ensure that Windows Media Player is installed on your computer.

- 1 Connect your device to a computer with a USB cable.
- 2 Open Windows Media Player and synchronise music files.

## ➤ Connect as a media device

You can connect your device to a computer and access media files stored on your device.

- 1 Connect your device to a computer with a USB cable.
- 2 Tap the right bottom of the screen to open the notifications panel.
- 3 Select **Connected as a media device** → **Media device (MTP)**.
- 4 Transfer files between your device and the computer.

## ➤ Connect as a camera device

You can connect your device to a computer as a camera and access files in your device.

 Use this USB connection mode when your computer does not support the media transfer protocol (MTP) or does not have the USB driver for your device installed.

- 1 Connect your device to a computer with a USB cable.
- 2 Tap the right bottom of the screen to open the notifications panel.
- 3 Select **Connected as a media device** → **Camera (PTP)**.
- 4 Transfer files between your device and the computer.

## Wi-Fi

Learn to use your device's wireless networking capabilities to activate and connect to any wireless local area network (WLAN) compatible with the IEEE 802.11 standards.

You can connect to the Internet or other network devices anywhere an access point or wireless hotspot is available.

 Your device uses a non-harmonised frequency and is intended for use in all European countries. The WLAN can be operated in the EU without restriction indoors, but cannot be operated outdoors in France.

### › Activate the Wi-Fi feature

In the application list, select **Settings** and then select **OFF** in **Wi-Fi**.

 The Wi-Fi feature running in the background will consume battery power. To preserve battery power, activate the feature only when needed.

### › Find and connect to a Wi-Fi AP

- 1 In the application list, select **Settings** → **Wi-Fi**.  
Your device searches for available Wi-Fi APs automatically.
- 2 Select an AP.
- 3 Enter the password for the AP (if necessary).
- 4 Select **Connect**.



## ➤ Add a Wi-Fi AP manually

- 1 In the application list, select **Settings** → **Wi-Fi** → **Add network**.
- 2 Enter an SSID for the AP and select a security type.
- 3 Set the security settings according to the security type you selected, and then select **Save**.

## ➤ Connect to a Wi-Fi AP with a protected setup

You can connect to a secured AP with a WPS button or WPS PIN. To use this method, your wireless access point must have a WPS button.

### Connect with a WPS button

- 1 In the application list, select **Settings** → **Wi-Fi**.
- 2 Select an AP that has WPS available, and then select **Show advanced options**.
- 3 Select the **WPS** drop-down menu.
- 4 Select **Push button** → **Connect**.
- 5 Press the WPS button on the AP within 2 minutes.

### Connect with a WPS PIN

- 1 In the application list, select **Settings** → **Wi-Fi**.
- 2 Select an AP that has WPS available, and then select **Show advanced options**.
- 3 Select the **WPS** drop-down menu.
- 4 Select **PIN from access point** to enter a WPS PIN of the AP or select **PIN from this device** to use a WPS PIN of your device.
- 5 Select **Connect**.
- 6 On the AP, press the WPS button or enter the PIN of your device.

## › Set the static IP settings

- 1 In the application list, select **Settings** → **Wi-Fi**.
- 2 Select an AP → **Show advanced options**.
- 3 Select the **IP settings** drop-down menu.
- 4 Select **Static**.
- 5 Change the IP settings.
- 6 Select **Connect**.

## › Customise Wi-Fi settings

- 1 In the application list, select **Settings** → **Wi-Fi** →  → **Advanced**.
- 2 Change the following options:

Option	Function
Network notification	Set the device to notify you when an open Wi-Fi AP is available.
Keep Wi-Fi on during sleep	Set whether or not to keep the Wi-Fi feature active in Sleep mode.
MAC address	View the MAC address.
IP address	View the IP address.

## Wi-Fi Direct

Learn to use the Wi-Fi Direct feature to connect two devices via Wi-Fi without requiring an AP.

### › Connect your device to another device

- 1 In the application list, select **Settings** → **More...** → **Wi-Fi Direct**.
- 2 Select **OFF** in **Wi-Fi Direct** and then select **OK**.
- 3 Select **Scan**.
- 4 Select a device.  
When the owner of the other device accepts the connection, the devices are connected.

### › Send data via Wi-Fi

- 1 Select a file or item from an appropriate application.
- 2 Select an option for sending data via Wi-Fi.  
 The method for selecting an option may vary by data type.
- 3 Search for and select another device.

### › Receive data via Wi-Fi

When you receive data, it is saved to your device automatically. Received data is saved to the ShareViaWifi folder.

## AllShare

Learn to use the Digital Living Network Alliance (DLNA) service that enables you to share media files between DLNA certified devices in your home via Wi-Fi.



- Some files may not play on some DLNA certified devices.
- Sharing media files may be buffered depending on the network connection.

### ▶ Play your files on another device

- 1 In the application list, select **AllShare**.
- 2 Select **My device**.
- 3 Select a media category → a file.
- 4 Select a player.  
Playback begins on the selected player.
- 5 Control playback with the keys on your device.

### ▶ Play a file from another device on your device

- 1 In the application list, select **AllShare**.  
Your device searches for DLNA certified devices automatically.
- 2 Select a device that contains media files.
- 3 Select a media category → a file.
- 4 Control playback with the keys on your device.

## › Play a file from one device on another device

- 1 In the application list, select **AllShare**.  
Your device searches for DLNA certified devices automatically.
- 2 Select a device that contains media files.
- 3 Select a media category → a file.
- 4 Select .
- 5 Select a player.  
Playback begins on the selected player.
- 6 Control playback with the keys on your device.

## › Customise settings for sharing media files

To allow other DLNA certified devices to access media files on your device, you must activate media sharing.

- 1 In the application list, select **AllShare** → .
- 2 Change the following options:

Option	Function
Media server name	Enter a media server name for your device.
Share media	Set to share your videos, images, or music with other devices.
Access point network	Select a connection profile to use for DLNA connections.
Upload from other devices	Set to accept uploads from other devices.
Default memory	Select a memory location for saving downloaded media files.

# Bluetooth

Learn to exchange data or media files with other devices via Bluetooth.



- Samsung is not responsible for the loss, interception, or misuse of data sent or received via the Bluetooth feature.
- Always ensure that you share and receive data with devices that are trusted and properly secured. If there are obstacles between the devices, the operating distance may be reduced.
- Some devices, especially those that are not tested or approved by the Bluetooth SIG, may be incompatible with your device.
- Do not use the Bluetooth feature for illegal purposes (for example, pirating copies of files or illegally tapping communications for commercial purposes). Samsung is not responsible for the repercussions of illegal use of the Bluetooth feature.

## › Activate the Bluetooth feature

In the application list, select **Settings** and then select **OFF** in **Bluetooth**.

## › Find and pair with another device



- 1 In the application list, select **Settings** → **Bluetooth** → **Scan for devices**.
- 2 Select a device.

- 3 Select **OK** to match the Bluetooth PIN between two devices. Alternately, enter a Bluetooth PIN and select **OK**. When the owner of the other device accepts the connection or enters the same PIN, pairing is complete. If the pairing is successful, the device will search for available services automatically.
-  Some devices, especially headsets or hands-free car kits, may have a fixed Bluetooth PIN, such as 0000. If the other device has a PIN, you must enter it.

## › Send data via Bluetooth

- 1 Select a file or item from an appropriate application.
  - 2 Select an option for sending data via the Bluetooth feature.
-  The method for selecting an option may vary by data type.
- 3 Search for and pair with a Bluetooth device.

## › Receive data via Bluetooth

- 1 In the application list, select **Settings** → **Bluetooth** and then select the tick box next to your device.
-  To select the length of time that your device will be visible, select  → **Visible time-out**.
- 2 When prompted, select **OK** to match the Bluetooth PIN or enter the Bluetooth PIN and select **OK** (if necessary).
  - 3 Select **Accept** to confirm that you are willing to receive data.

Received data is saved to the bluetooth folder. If you receive a contact, it is saved to the phonebook automatically.

## GPS

Your device is equipped with a global positioning system (GPS) receiver. Learn to activate location services and use additional GPS functions.

For better reception of GPS signals, avoid using your device in the following conditions:

- Between buildings, in tunnels or underground passages, or inside buildings
- In poor weather
- Around high voltage or electromagnetic fields
- In a vehicle with sun protection film

 Do not touch or cover the area around the antenna with your hands or other objects while using the GPS functions.

 This feature may be unavailable depending on your region or service provider.

### ▶ **Activate location services**

You must activate location services to receive location information or search the map.

1 In the application list, select **Settings** → **Location services**.

2 Change the following options:

Option	Function
Use wireless networks	Set to use Wi-Fi to find your location.
Use GPS satellites	Set to use GPS satellites to find your location.



Option	Function
Location and Google search	Set the device to use your current location for Google search and other Google services.

## VPN connections

Learn to create virtual private networks (VPNs) and connect to them securely over the Internet.



- Your device should already be configured with Internet access. If you have trouble accessing the Internet, you must edit the connections. If you are not sure what information to enter, ask your VPN administrator.
- To use this feature, you must activate the screen lock feature.

### > Set up a VPN profile

1 In the application list, select **Settings** → **More...** → **VPN** → **Add VPN network**.

2 Change the following options:

Option	Function
Name	Enter a name for the VPN server.
Type	Select a VPN type.
Server address	Enter the IP address of the VPN server.
L2TP secret	Enter an L2TP secret password.
IPSec identifier	Enter a user name.
IPSec pre-shared key	Enter a pre-shared security key.

Option	Function
IPSec user certificate	Select a user certificate that the VPN server will use to identify you. You can import certificates from the VPN server or download them from the Internet.
IPSec CA certificate	Select a certificate authority (CA) certificate that the VPN server will use to identify you. You can import certificates from the VPN server or download them from the Internet.
IPSec server certificate	Select a server certificate that the VPN server will use to identify you. You can import certificates from the VPN server or download them from the Internet.
PPP encryption (MPPE)	Set to encrypt data before sending it to the VPN server.
Show advanced options	Set to change the advanced network settings.



The options available may vary depending on the VPN type.

3 When you are finished, select **Save**.

## ➤ Connect to a private network

1 In the application list, select **Settings** → **More...** → **VPN**.

2 Select a private network.

3 Enter the user name and password, and then select **Connect**.

# Tools

## Alarm

Learn to set and control alarms for important events.



### › Set an alarm

1 In the application list, select **Alarm**.

2 Select .



3 Set the details of the alarm.

4 When you are finished, select **Done**.

 To deactivate an alarm, select the clock icon next to the alarm. To delete an alarm, select .

### › Stop an alarm

When the alarm sounds,

- To stop the alarm, select  and then drag your finger outside of the large circle.
- To silence the alarm for the snooze period, select  and then drag your finger outside of the large circle.

## Calculator

Learn to perform calculations with your device.

### › Perform a calculation

- 1 In the application list, select **Calculator**.
- 2 Use the keys on the screen to perform basic calculations.

### › View the calculation history

- 1 In the application list, select **Calculator**.
- 2 Perform a calculation.
- 3 Select  to hide the calculator keypad.  
The calculation history appears.

## Downloads

Learn to manage logs of files you have downloaded from the web or email.

- 1 In the application list, select **Downloads**.
- 2 Select a download category.
- 3 To open a downloaded file, select the log.  
To delete a log, select the tick box and select .

## My files

Learn to access various types of files saved in your device.

### › Supported file formats



Your device supports the following file formats:

Type	Format
Image	bmp, gif, jpg, png
Video	avi, 3gp/mp4, wmv, flv, mkv, webm
Music	m4a, wma, mp3, flac, ogg, aac
Sound	amr-nb/wb, wav, mid, midi, xmf, mxmf, i-melody (imy), sp-midi, rtttl/rtx, ota
Others	doc, docx, txt, hwp, rtf, ppt, pptx, pps, xls, xlsx, csv, pdf, htm, html, webm, flac, ogg













- Some file formats are not supported depending on the device's software.
- If a file size exceeds the memory available, an error may occur when you try to open the file.

## › View a file

- 1 In the application list, select **My files**.
- 2 Select a folder.
  - To move up one level in the file directory, select .
  - To return to the Home directory, select .
- 3 Select a file.

From the folder list, access the following options:

- To search for files saved in your device, select .
- To view the files in the thumbnail view, select .
- To create folders for managing files, select .
- To change the file manager settings, select  → **Settings**.
- To sort files or folders, select the **Name** drop-down menu and select an option.
- To send a file to others, select the tick box and select .
- To copy or move the files or folders to another file folder, select the tick boxes and select  or .
- To delete files or folders, select the tick boxes and select .
- To change the name of a file or a folder, select the tick box and select  → **Rename**.
- To view file or folder details, select the tick box and select  → **Details**.

# Polaris Office

Learn to create or view documents with your device.



This feature may be unavailable depending on your region or service provider.

## › Create a document

1 In the application list, select **Polaris Office**.



If you are launching this application for the first time, register as an online user or skip the registration.

2 Select  → a document type.

3 Select a template (if necessary).

4 Create the document.

5 When you are finished, select .

6 Enter a name for the document and select a memory location for saving the document, and then select **Save**.

## › Open a document



1 In the application list, select **Polaris Office**.





2 Select **Browser** → a document file.

To open a recently-used file, select a file under **Recent documents**.

3 View the document.

From the document view, access the following options:

- To zoom in or out, place two fingers on the screen and slowly spread them apart or pinch them together.
- To undo your last action, select .
- To redo your last action, select .
- To add an item to the document, select .

- To open the editing toolbar, select .
- To start a slide show in a PowerPoint document, select . Tap the screen to move to the next slide. Select  to exit the slide show.
- To search for text in a Text document, select .
- To use additional options with the document, select .





The options available may vary depending on the document type.

## › Manage documents online

- 1 In the application list, select **Polaris Office**.
- 2 Select **Clouds** → **Add account** → a cloud service.
- 3 Enter your email address and password to access your account, and then select **OK**.
- 4 View and manage your documents on the server.

## Search

Learn to search for data in your device or information on the Internet.

- 1 In the application list, select **Search**.
- 2 Enter a keyword and select .  
To search for data by voice, select  and say a keyword into your device's microphone.
- 3 Select a search result.



## World clock

Learn to view the time in another region and set world clocks to appear on your display.

1 In the application list, select **World clock** → .

2 Enter a city name or select one from the globe.

3 Select .

 To apply summer time to the clock, tap and hold the clock, and then select **DST settings**.

# Settings

## Access the setting options

- 1 In the application list, select **Settings**.
- 2 Select a setting category, and then select an option.

## Wi-Fi

Activate the Wi-Fi feature to connect to a Wi-Fi AP and access the Internet or other network devices.

## Bluetooth

Activate the Bluetooth feature to exchange information over short distances.

## Data usage

Keep track of your data usage amount.

## More...

Change the settings to control connections with other devices or networks.

## › Flight mode

Activate Flight mode to disable all wireless functions on your device. You can use only non-network features.

## › Kies via Wi-Fi

Connect your device to Samsung Kies via Wi-Fi.

## › VPN

Set up and manage virtual private networks (VPNs).

## › Wi-Fi Direct

Activate the Wi-Fi Direct feature to connect two devices via Wi-Fi without requiring an AP.

## Sound

Change the settings for various sounds on your device.

- **Volume:** Adjust the volume for various sounds on your device.
- **Default notifications:** Select a ringtone to alert you to events.
- **Touch sounds:** Set the device to sound when you select an application or option.
- **Screen lock sound:** Set the device to sound when you lock or unlock the touch screen.

## Wallpaper

Change the wallpaper settings.

- **Home screen:** Select a background image for the Home screen.
- **Lock screen:** Select a background image for the locked screen.
- **Home and lock screens:** Select a background image for the Home screen and the locked screen.

## Lock screen

**Clock:** Set to show the clock on the locked screen.

## Display

Change the settings to control the display and backlight on your device.

- **Brightness:** Adjust the brightness of the display.
- **Auto-rotate screen:** Set the interface to rotate automatically when you rotate the device.
- **Quick launch:** Select an application to launch with the quick launch shortcut. The shortcut icon will change according to the application you specify.
- **Screen timeout:** Select the length of time that the device waits before turning off the display backlight.
- **Font style:** Change the font type for the display text.
- **Font size:** Change the font size for creating or showing items in applications.

## Power saving

Activate Power saving mode. To change the following settings for Power saving mode, deactivate Power saving mode.

- **CPU power saving:** Set the device to limit some system resource usage.
- **Screen power saving:** Set the device to decrease the brightness of the display.
- **Background colour:** Set the device to decrease the brightness of the email background colour.
- **Learn about power saving:** View information for saving battery power.

## Storage

View memory information for your device and memory card. You can also format the memory card.

 Formatting a memory card will permanently delete all data from the memory location.

 The actual available capacity of the internal memory is less than the specified capacity because the operating system and default applications occupy part of the memory.

## Battery

View the amount of battery power consumed by your device.

## Applications

View and manage the applications on your device.

## Accounts and sync

Change the settings for the auto sync feature or manage accounts for synchronisation.

## Location services

Change the settings for location services.

- **Use wireless networks:** Set to use Wi-Fi for finding your location.
- **Use GPS satellites:** Set to use GPS satellites for finding your location.
- **Location and Google search:** Set the device to use your current location for Google search and other Google services.

## Security

Change the settings for securing your device.

- **Screen lock:** Activate the screen lock feature.
- **Owner information:** Enter your information that is shown on the locked screen.
- **Encrypt device:** Set a password to encrypt data saved on the device. You must enter the password each time you turn on the device.



Charge the battery before enabling this setting because it may take more than an hour to encrypt your data.

- **Encrypt SD card:**
  - **Encrypt SD card:** Set to encrypt files when you save them to a memory card.
  - **Full encryption:** Set to encrypt all files on a memory card.
  - **Exclude multimedia files:** Set to encrypt all files on a memory card, except for media files.



If you reset your device to the factory defaults with this setting enabled, the device will not be able to read your encrypted files. Disable this setting before resetting the device.

- **Remote controls:** Set to allow remote control of your device via the Internet when your device is lost or stolen.
- **SamsungDive web page:** Access the SamsungDive website to register your Samsung account.
- **Make passwords visible:** Set to show your passwords as you enter them.
- **Device administrators:** View the administrators you have approved for your device. You can allow device administrators to apply new policies to your device.

- **Unknown sources:** Set to download applications from any source. If you do not select this option, you can download applications only from Play Store.
- **Trusted credentials:** Set to use certificates and credentials to ensure the secure use of applications.
- **Install from device storage:** Install encrypted certificates that are saved in the device's USB storage.
- **Clear credentials:** Delete credentials from the device and reset the password.

## Language and input

Change the settings for languages and text input.

### › Language

Select a display language.

### › Default

Select a text input method.

### › Google voice typing

Activate the Google voice input feature to enter text by voice. To change the voice input settings, select .

- **Select input languages:** Select input languages for Google voice recognition.
- **Block offensive words:** Set to prevent the device from recognising offensive words in voice inputs.

## › Samsung keyboard

To change the Samsung keypad settings, select .

- **Input language:** Select input languages to use with the keypad.
- **Predictive text:** Activate XT9 mode to predict words based on your input and show word suggestions.
- **Handwriting:** Change the settings for Handwriting mode, such as recognition time, pen thickness, or pen colour.
- **Voice input:** Activate the voice input feature to enter text by voice.
- **Auto capitalisation:** Set to capitalise the first letter of a sentence automatically.
- **Auto-punctuate:** Set the device to insert a full stop when you double-tap the space bar.
- **Key-tap sound:** Set the device to sound when you tap a key.
- **Tutorial:** View the tutorial for using the Samsung keypad.
- **Reset settings:** Reset the Samsung keypad settings to the factory defaults.

## › Voice Search

- **Language:** Select a language for Google voice recognition.
- **SafeSearch:** Select a level for filtering out explicit text and images from voice search results.
- **Block offensive words:** Set to hide offensive words from voice search results.



## › Text-to-speech output

- **Preferred TTS engine:** Select a speech synthesis engine. To change the settings for speech synthesis engines, select .
- **Speech rate:** Select a speed for the TTS feature.
- **Listen to an example:** Listen to the spoken text for an example.
- **Driving mode:** Activate Driving mode to provide audible notifications for event details.

## › Pointer speed

Adjust the pointer speed for the mouse or trackpad connected to your device.

## Back up and reset

Change the settings for managing settings and data.

- **Back up my data:** Set to back up your settings and application data to the Google server.
- **Backup account:** Set up or edit your Google backup account.
- **Automatic restore:** Set to restore your settings and application data when you must reinstall an application.
- **Factory data reset:** Reset your settings to the factory defaults and delete all your data.

## Dock

**Dock sound:** Set the device to play a sound when your device is connected to or removed from a desktop dock.

## Date and time

Change the settings to control how time and date appears on your device.



If the battery remains fully discharged or removed from the device, the time and date will be reset.

- **Set date:** Set the current date manually.
- **Set time:** Set the current time manually.
- **Select time zone:** Select a time zone.
- **Use 24-hour format:** Set to show the time in 24-hour format or 12-hour format.
- **Select date format:** Select a date format.

## Accessibility

Accessibility services are special features for those with physical challenges. Change the settings to improve accessibility to the device's interface and features.

- **Auto-rotate screen:** Set the interface to rotate automatically when you rotate the device.
- **Speak passwords:** Set the device to read aloud passwords you enter on websites with TalkBack.
- **Accessibility shortcut:** Add a shortcut to accessibility settings that appears when you press and hold the Power key.
- **Screen timeout:** Select the length of time that the device waits before turning off the display backlight.
- **TalkBack:** Activate TalkBack, which provides voice feedback.
- **Install web scripts:** Set applications to install web scripts to make their web content more accessible.

- **Font size:** Change the font size in the calendar, email, phonebook, and memo applications.
- **Mono audio:** Enable mono sound when you listen to audio with one earbud.
- **Tap and hold delay:** Set the recognition time for tapping and holding the screen.

## Developer options

Change the settings for application development.

- **USB debugging:** Activate USB debugging mode to connect your device to a computer with a USB cable.
- **Development device ID:** View your device's development ID.
- **Allow mock locations:** Allow mock locations and service information to be sent to a Location Manager service for testing.
- **Desktop backup password:** Set a password to secure your backup data.
- **Strict mode:** Set the device to flash the screen when applications perform long operations.
- **Show pointer location:** Set to show the coordinates and traces of the pointer when you touch the screen.
- **Show touches:** Set to show the pointer when you touch the screen.
- **Show screen updates:** Set to flash areas of the screen when they are updated.
- **Show CPU usage:** Set to list all active processes.
- **Force GPU rendering:** Set to use 2D hardware acceleration to improve graphic performance.
- **Window animation scale:** Select a speed for opening and closing pop-up windows.

- **Transition animation scale:** Select a speed for switching between screens.
- **Do not keep activities:** Set to end a running application when you launch a new application.
- **Limit background processes:** Set to limit the number of processes that can run in the background.
- **Show all ANRs:** Set the device to alert you to unresponsive applications that are running in the background.

## About device

View information about your device, such as model number and version.



You can download and install firmware update with the firmware over-the-air (FOTA) service. To check for firmware updates, select **Software update** → **Update**.

# Troubleshooting

## Your device displays network or service error messages

- When you are in areas with weak signals or poor reception, you may lose reception. Move to another area and try again.
- You cannot access some options without a subscription. Contact your service provider for more details.

## The touch screen responds slowly or improperly

If your device has a touch screen and the touch screen is not responding properly, try the following:

- Remove any protective covers from the touch screen. Protective covers may prevent the device from recognising your inputs and are not recommended for touch screen devices.
- Ensure that your hands are clean and dry when tapping the touch screen.
- Restart your device to clear any temporary software bugs.
- Ensure that your device's software is upgraded to the latest version.
- If the touch screen is scratched or damaged, take your device to a Samsung Service Centre.

## Your device freezes or has fatal errors

If your device freezes or hangs, you may need to close applications or reset the device to regain functionality. If your device is still responsive and an application is frozen, close the application with the task manager. If your device is frozen and unresponsive, press and hold the Power key for 8-10 seconds.

If this problem persists, perform a factory data reset. In the application list, select **Settings** → **Back up and reset** → **Factory data reset** → **Reset device** → **Erase everything**.

## The device beeps and the battery icon is empty

Your battery is low. Recharge the battery to continue using the device.

## The battery does not charge properly or the device turns off

If the battery will no longer charge completely, you need to replace it with a new battery. Take your device to your local Samsung Service Centre.

## Your device is hot if touched

When you use applications that require more power or use applications on your device for an extended period of time, your device may feel hot. This is normal and should not affect your device's lifespan or performance.

## Error messages appear when launching the camera

Your device must have sufficient memory and battery power available to operate the camera application. If you receive error messages when launching the camera, try the following:

- Charge the battery.
- Free some memory by transferring files to a computer or deleting files from your device.
- Restart the device. If you are still having trouble with the camera application after trying these tips, contact a Samsung Service Centre.

## Error messages appear when opening music files

Some music files may not play on your device for a number of reasons. If you receive error messages when opening music files on your device, try the following:

- Free some memory by transferring files to a computer or deleting files from your device.
- Ensure that the music file is not Digital Rights Management (DRM)-protected. If the file is DRM-protected, ensure that you have the appropriate licence or key to play the file.
- Ensure that your device supports the file type.

## Another Bluetooth device is not located

- Ensure that the Bluetooth feature is activated on your device.
- Ensure that the Bluetooth feature is activated on the device you wish to connect to, if necessary.
- Ensure that your device and the other Bluetooth device are within the maximum Bluetooth range (10 m).

If the tips above do not solve the problem, contact a Samsung Service Centre.

## A connection is not established when you connect the device to a computer

- Ensure that the USB cable you are using is compatible with your device.
- Ensure that you have the proper drivers installed and updated on your computer.
- If you are a Windows XP user, ensure that you have Windows XP Service Pack 3 or higher installed on your computer.
- Ensure that you have Samsung Kies 2.0 or Windows Media Player 10 or higher installed on your computer.



# Safety information

To prevent injury to yourself and others, or damage to your device, read all of the following information before using your device.

## Warning: Prevent electric shock, fire, and explosion

**Do not use damaged power cords or plugs, or loose electrical sockets**

**Do not touch the power cord with wet hands or disconnect the charger by pulling the cord**

**Do not bend or damage the power cord**

**Do not use your device while it is charging or touch your device with wet hands**

**Do not short-circuit the charger**

**Do not drop or cause an impact to the charger or the device**

**Do not charge the battery with chargers that are not approved by the manufacturer**

**Do not use your device during a thunderstorm**

Your device may malfunction and your risk of electric shock is increased.

**Handle and dispose of the device and chargers with care**

- Use only Samsung-approved chargers specifically designed for your device. Incompatible chargers can cause serious injuries or damage to your device.
- Never dispose of devices in a fire. Follow all local regulations when disposing of used devices.
- Never place devices on or in heating devices, such as microwave ovens, stoves, or radiators. Batteries may explode when overheated.
- Never crush or puncture the device. Avoid exposing the device to high external pressure, which can lead to an internal short circuit and overheating.

## **Protect the device and chargers from damage**

- Avoid exposing your device to very cold or very hot temperatures.
- Extreme temperatures can damage the device and reduce the charging capacity and life of your device and batteries.
- Never use a damaged charger.

## **Caution: Follow all safety warnings and regulations when using your device in restricted areas**

### **Do not use your device near other electronic devices**

Most electronic devices use radio frequency signals. Your device may interfere with other electronic devices.

### **Do not use your device near a pacemaker**

- Avoid using your device within a 15 cm range of a pacemaker, if possible, as your device can interfere with the pacemaker.
- To minimise possible interference with a pacemaker, use your device only on the side of your body that is opposite the pacemaker.

### **Do not use your device in a hospital or near medical equipment that can be interfered with by radio frequency**

If you use medical equipment, contact the equipment manufacturer before using your device to determine whether or not the equipment will be affected by radio frequencies emitted by the device.

### **If you use a hearing aid, contact the manufacturer for information about radio interference**

The radio frequency emitted by your device may interfere with some hearing aids. Before using your device, contact the manufacturer to determine whether or not your hearing aid will be affected by radio frequencies emitted by the device.

### **Turn off the device in potentially explosive environments**

- Always comply with regulations, instructions and signs in potentially explosive environments.
- Do not use your device at refuelling points (petrol stations), near fuels or chemicals, or in blasting areas.
- Do not store or carry flammable liquids, gases, or explosive materials in the same compartment as the device, its parts, or accessories.

## **Turn off your device when on an aircraft**

Your device may interfere with the aircraft's electronic navigation instruments.

## **Your device may interfere with automotive equipment**

Electronic devices in your car may malfunction, due to radio interference from your device. Contact the manufacturer for more information.

## **Comply with all safety warnings and regulations regarding mobile device usage while operating a vehicle**

While driving, safely operating the vehicle is your first responsibility. Never use your mobile device while driving, if it is prohibited by law. For your safety and the safety of others, use your common sense and remember the following tips:

- Position your device within easy reach. Make sure you can access your wireless device without taking your eyes off the road.
- Suspend calls in heavy traffic or hazardous weather conditions. Rain, sleet, snow, ice, and heavy traffic can be hazardous.
- Do not take notes or look up phone numbers. Jotting down a "to do" list or flipping through your address book takes attention away from your primary responsibility of driving safely.
- Dial sensibly and assess the traffic. Place calls when you are not moving or before pulling into traffic. Try to plan calls when your car will be stationary.
- Do not engage in stressful or emotional conversations that may be distracting. Make the person you are talking to aware that you are driving and suspend conversations that could potentially divert your attention from the road.
- Use your device to call for help. Dial a local emergency number in the case of fire, traffic accidents, or medical emergencies.
- Use your device to help others in emergencies. If you see a car accident, a crime in progress, or a serious emergency where lives are in danger, call a local emergency number.
- Call roadside assistance or a special, non-emergency assistance number when necessary. If you see a broken-down vehicle posing no serious hazard, a broken traffic signal, a minor traffic accident where no one appears injured, or a vehicle that you know to be stolen, call a number that is designated for reporting these types of situations.

## Proper care and use of your mobile device

### Keep your device dry

- Humidity and liquids may damage the parts or electronic circuits in your device.
- Do not turn on your device if it is wet. If your device is already on, turn it off and remove the battery immediately (if the device will not turn off or you cannot remove the battery, leave it as-is). Then, dry the device with a towel and take it to a service centre.
- Liquids will change the colour of the label that indicates water damage inside the device. Water damage to your device can void your manufacturer's warranty.

### Do not use or store your device in areas with high concentrations of dust or airborne materials

Dust or foreign materials can cause your device to malfunction and may result in fire or electric shock.

### Store your device only on flat surfaces

If your device falls, it may be damaged.

### Do not store your device in very hot or very cold areas. Use your device at temperatures from -20 °C to 45 °C

- Your device can explode if left inside a closed vehicle, as the internal temperature can reach up to 80 °C.
- Do not expose your device to direct sunlight for extended periods of time (on the dashboard of a car, for example).
- Store the battery at temperatures from -20 °C to 45 °C.

### Do not store your device with metal objects, such as coins, keys, and necklaces

Your device may be scratched or may malfunction.

### Do not store your device near magnetic fields

- Your device may malfunction or the battery may discharge from exposure to magnetic fields.
- Magnetic stripe cards, including credit cards, phone cards, passbooks, and boarding passes, may be damaged by magnetic fields.
- Do not use carrying cases or accessories with magnetic closures or allow your device to come into contact with magnetic fields for extended periods of time.

## **Do not store your device near or in heaters, microwaves, hot cooking equipment, or high pressure containers**

- The battery may leak.
- Your device may overheat and cause a fire.

## **Do not drop your device or cause impacts to your device**

- The screen of your device may be damaged.
- If bent or deformed, your device may be damaged or parts may malfunction.

## **Do not use your device or applications for a while if the device is overheated**

Prolonged exposure of your skin to an overheated device may cause low temperature burn symptoms, such as red spots and pigmentation.

## **If your device has a camera flash or light, do not use it close to the eyes of people or pets**

Using a flash close to the eyes may cause temporary loss of vision or damage to the eyes.

## **Use caution when exposed to flashing lights**

- While using your device, leave some lights on in the room and do not hold the screen too close to your eyes.
- Seizures or blackouts can occur when you are exposed to flashing lights while watching videos or playing Flash-based games for extended periods. If you feel any discomfort, stop using the device immediately.

## **Reduce the risk of repetitive motion injuries**

When you repetitively perform actions, such as pressing keys, drawing characters on a touch screen with your fingers, or playing games, you may experience occasional discomfort in your hands, neck, shoulders, or other parts of your body. When using your device for extended periods, hold the device with a relaxed grip, press the keys lightly, and take frequent breaks. If you continue to have discomfort during or after such use, stop using the device and consult a physician.

## **Ensure maximum battery and charger life**

- Avoid charging batteries for more than a week, as overcharging may shorten battery life.
- Over time, unused batteries will discharge and must be recharged before use.
- Disconnect chargers from power sources when not in use.

## **Use manufacturer-approved, chargers, accessories, and supplies**

- Using generic chargers may shorten the life of your device or cause the device to malfunction.
- Samsung cannot be responsible for the user's safety when using accessories or supplies that are not approved by Samsung.

## **Do not bite or suck the device**

- Doing so may damage the device or cause an explosion.
- If children use the device, make sure that they use the device properly.

## **Do not insert the device or supplied accessories into the eyes, ears, or mouth**

Doing so may cause suffocation or serious injuries.

## **When using the device:**

- Speak directly into the microphone.
- Do not touch the device's internal antenna. Doing so may cause the device to emit unintended levels of radio frequency (RF) energy.

## **Protect your hearing and ears when using a headset**



- Excessive exposure to loud sounds can cause hearing damage.
- Exposure to loud sounds while driving may distract your attention and cause an accident.
- Always turn the volume down before plugging the earphones into an audio source and use only the minimum volume setting necessary to hear your conversation or music.
- In dry environments, static electricity can build up in the headset. Avoid using headsets in dry environments or touch a metal object to discharge static electricity before connecting a headset to the device.

## **Use caution when using the device while walking or moving**

- Always be aware of your surroundings to avoid injury to yourself or others.
- Make sure the headset cable does not become entangled in your arms or on nearby objects.

## **Do not carry your device in your back pockets or around your waist**

You could be injured or damage the device if you fall.

## **Do not disassemble, modify, or repair your device**

Any changes or modifications to your device can void your manufacturer's warranty. If your device needs servicing, take your device to a Samsung Service Centre.

## **Do not paint or put stickers on your device**

Paint and stickers can clog moving parts and prevent proper operation. If you are allergic to paint or metal parts of the device, you may experience itching, eczema, or swelling of the skin. When this happens, stop using the device and consult your physician.

## **When cleaning your device:**

- Wipe your device or charger with a towel or an eraser.
- Do not use chemicals or detergents.

## **Do not use the device if the screen is cracked or broken**

Broken glass or acrylic could cause injury to your hands and face. Take the device to a Samsung Service Centre to have it repaired.

## **Do not use the device for anything other than its intended use**

## **Avoid disturbing others when using the device in public**

## **Do not allow children to use your device**

Your device is not a toy. Do not allow children to play with it as they could hurt themselves and others, or damage the device.

## **Install mobile devices and equipment with caution**

- Ensure that any mobile devices or related equipment installed in your vehicle are securely mounted.
- Avoid placing your device and accessories near or in an airbag deployment area. Improperly installed wireless equipment can cause serious injury when airbags inflate rapidly.

## **Allow only qualified personnel to service your device**

Allowing unqualified personnel to service your device may result in damage to your device and will void your manufacturer's warranty.

## **Handle memory cards with care**

- Do not remove a card while the device is transferring or accessing information, as this could result in loss of data and/or damage to the card or device.
- Protect cards from strong shocks, static electricity, and electrical noise from other devices.
- Do not touch gold-coloured contacts or terminals with your fingers or metal objects. If dirty, wipe the card with a soft cloth.

## **Keep your personal and important data safe**

- While using your device, be sure to back up important data. Samsung is not responsible for the loss of any data.
- When disposing of your device, back up all data and then reset your device to prevent misuse of your personal information.
- Carefully read the permissions screen when downloading applications. Be particularly cautious with applications that have access to many functions or to a significant amount of your personal information.
- Check your accounts regularly for unapproved or suspicious use. If you find any sign of misuse of your personal information, contact your service provider to delete or change your account information.
- In the event your device is lost or stolen, change the passwords on your accounts to protect your personal information.
- Avoid using applications from unknown sources and lock your device with a pattern, password, or PIN.

## **Do not distribute copyright-protected material**

Do not distribute copyright-protected material without the permission of the content owners. Doing this may violate copyright laws. The manufacturer is not liable for any legal issues caused by the user's illegal use of copyrighted material.



## Correct disposal of this product

(Waste Electrical & Electronic Equipment)



(Applicable in the European Union and other European countries with separate collection systems)

This marking on the product, accessories or literature indicates that the product and its electronic accessories (e.g. charger, headset, USB cable) should not be disposed of with other household waste.

To prevent possible harm to the environment or human health from uncontrolled waste disposal, please separate these items from other types of waste and recycle them responsibly to promote the sustainable reuse of material resources.

Household users should contact either the retailer where they purchased this product, or their local government office, for details of where and how they can take these items for environmentally safe recycling.

Business users should contact their supplier and check the terms and conditions of the purchase contract. This product and its electronic accessories should not be mixed with other commercial wastes for disposal.

This EEE is compliant with RoHS.

## Correct disposal of batteries in this product



(Applicable in the European Union and other European countries with separate battery return systems)

The marking on the battery, manual or packaging indicates that the battery in this product should not be disposed of with other household waste. Where marked, the chemical symbols Hg, Cd or Pb indicate that the battery contains mercury, cadmium or lead above the reference levels in EC Directive 2006/66.

The battery incorporated in this product is not user replaceable. For information on its replacement, please contact your service provider. Do not attempt to remove the battery or dispose it in a fire. Do not disassemble, crush, or puncture the battery. If you intend to discard the product, the waste collection site will take the appropriate measures for the recycling and treatment of the product, including the battery.

## Disclaimer

Some content and services accessible through this device belong to third parties and are protected by copyright, patent, trademark and/or other intellectual property laws. Such content and services are provided solely for your personal non-commercial use. You may not use any content or services in a manner that has not been authorised by the content owner or service provider. Without limiting the foregoing, unless expressly authorised by the applicable content owner or service provider, you may not modify, copy, republish, upload, post, transmit, translate, sell, create derivative works, exploit, or distribute in any manner or medium any content or services displayed through this device.

“THIRD PARTY CONTENT AND SERVICES ARE PROVIDED “AS IS.” SAMSUNG DOES NOT WARRANT CONTENT OR SERVICES SO PROVIDED, EITHER EXPRESSLY OR IMPLIEDLY, FOR ANY PURPOSE. SAMSUNG EXPRESSLY DISCLAIMS ANY IMPLIED WARRANTIES, INCLUDING BUT NOT LIMITED TO, WARRANTIES OF MERCHANTABILITY OR FITNESS FOR A PARTICULAR PURPOSE. SAMSUNG DOES NOT GUARANTEE THE ACCURACY, VALIDITY, TIMELINESS, LEGALITY, OR COMPLETENESS OF ANY CONTENT OR SERVICE MADE AVAILABLE THROUGH THIS DEVICE AND UNDER NO CIRCUMSTANCES, INCLUDING NEGLIGENCE, SHALL SAMSUNG BE LIABLE, WHETHER IN CONTRACT OR TORT, FOR ANY DIRECT, INDIRECT, INCIDENTAL, SPECIAL OR CONSEQUENTIAL DAMAGES, ATTORNEY FEES, EXPENSES, OR ANY OTHER DAMAGES ARISING OUT OF, OR IN CONNECTION WITH, ANY INFORMATION CONTAINED IN, OR AS A RESULT OF THE USE OF ANY CONTENT OR SERVICE BY YOU OR ANY THIRD PARTY, EVEN IF ADVISED OF THE POSSIBILITY OF SUCH DAMAGES.”

Third party services may be terminated or interrupted at any time, and Samsung makes no representation or warranty that any content or service will remain available for any period of time. Content and services are transmitted by third parties by means of networks and transmission facilities over which Samsung has no control. Without limiting the generality of this disclaimer, Samsung expressly disclaims any responsibility or liability for any interruption or suspension of any content or service made available through this device. Samsung is neither responsible nor liable for customer service related to the content and services. Any question or request for service relating to the content or services should be made directly to the respective content and service providers.

# Index

- alarms 91
- AllShare (DLNA) 84
- applications
  - closing 29
  - downloading 28
  - launching 27
  - multitasking 29
  - organising 28
  - uninstalling 28
- battery
  - charging 15
- Bluetooth 86
- calculator 92
- calendar
  - creating events 75
  - viewing events 76
- camera
  - changing camcorder settings 59
  - changing camera settings 56
  - recording videos 57
  - taking photos 53
- connectivity
  - AllShare (DLNA) 84
  - Bluetooth 86
  - GPS connections 88
  - USB connections 78
  - VPN connections 89
  - Wi-Fi 80
- contacts
  - creating 73
  - creating groups 74
  - finding 73
  - importing/exporting 74
- device lock 31
- display
  - brightness 30
  - font style 30
  - language 29
  - settings 100
  - wallpaper 30
- file manager 93
- find my mobile 33
- flight mode 20
- gallery 63
- Google+ 52
- Google Latitude 40
- Google Mail 47
- Google Maps 41
- Google Messenger 52
- Google Talk 51
- home screen
  - adding panels 26
  - moving items 25
  - removing items 25
  - removing panels 26
  - using the notifications panel 24
  - using widgets 26

- indicator icons 24
- Internet 36
- key functions 14
- maps
  - getting directions 42
  - searching for locations 41
  - searching for places nearby 43
  - sharing locations 40
  - using the navigation 42
- memory card
  - formatting 19
  - inserting 18
  - removing 19
- memos
  - creating 77
  - viewing 77
- messages
  - sending email 49
  - sending Google Mail 47
  - viewing email 50
  - viewing Google Mail 47
- music player 68
- photo editor 65
- photos
  - editing 65
  - taking 53
  - viewing 63
- Play Store 43
- Polaris Office 95
- power saving 17, 100
- Samsung Apps 44
- settings 98
- silent mode 30
- sound
  - device volume 30
  - settings 99
  - touch tone 30
- task manager 29
- text input
  - copy and paste 35
  - with Google voice input 34
  - with Samsung keypad 34
- touch screen
  - locking/unlocking 22
  - using 20
- touch tone 30
- unpack 11
- USB connections
  - as camera device 79
  - as media device 79
  - with Samsung Kies 78
  - with Windows Media Player 78
- video editor 66
- video player 60
- videos
  - playing 60, 64
  - recording 57
  - uploading to YouTube 46
- VPN connections 89
- web browser 36
- Wi-Fi 80
- world clock 97
- YouTube 45

Some contents in this manual may differ from your device depending on the software of the device or your service provider.

### **To install Samsung Kies (PC Sync) Kies**

1. Download the latest version of Samsung Kies from the Samsung website ([www.samsung.com/kies](http://www.samsung.com/kies)) and install it on your computer.
2. Connect your device to a computer with a USB cable.  
Refer to the Samsung Kies help for more information.