

Operating instructions for washing machines



To avoid the risk of accidents or damage to the machine, it is **essential** to read these instructions before it is installed and used for the first time.

Contents

Caring for the environment	6
Warning and Safety instructions	7
Operating the washing machine	14
Control panel.....	14
Touch display and sensors	15
Main menu	15
Examples on how to operate the machine	17
Before using for the first time	19
Removing the detergent cartridges from the drum.....	19
Running the first programme	21
TwinDos	22
Inserting cartridges/containers	23
Using cartridges.....	23
Using containers	24
Setting the electronic unit to liquid detergent and/or fabric conditioner	25
Settings for UltraPhase 1 and UltraPhase 2	26
Settings for other types of detergent.....	27
Running the first programme	28
Washing environmentally and economically	29
Energy and water consumption	29
Detergent	29
When drying with a tumble dryer	29
EcoFeedback	30
1. Prepare the laundry	31
2. Select a programme	32
3. Select programme settings	33
4. Load the washing machine	36
5. Add detergent	38
TwinDos	38
CapDosing	38
Detergent dispenser drawer.....	40
6. Start the programme - the end of a programme	41
Degree of soiling	42

Garment care label symbols	43
Spinning	44
Programme chart	46
Programme sequence	52
Changing the programme sequence	55
Cancelling a programme	55
Interrupting a programme	55
Changing a programme	55
Adding or removing laundry after the programme has started	56
Safety lock	57
ProgrammeManager	58
Intensive	58
ECO	58
Extra gentle	58
Extra quiet	58
AllergoWash	58
Options	60
Steam smoothing	60
Short	60
Rinse hold	60
Pre-wash	60
Water plus	60
Extra rinse	60
Delay start	62
Favourite programmes	64
Washing assistant	66
Mixed items	67
Miele@home	68
Detergent	70
The correct detergent	70
Water softeners	70
Dispensing aids	70
Fabric conditioner and liquid starch	70
Miele recommended detergents	71

Contents

Recommended detergents in accordance with Directive (EU) Nr. 1015/2010	72
Cleaning and care	75
Cleaning the drum (Hygiene info).....	75
External casing and fascia panel	75
Cleaning the detergent dispenser drawer.....	75
Cleaning the TwinDos system.....	77
Cleaning the water inlet filter	78
Problem solving guide	79
The programme does not start	79
The following fault messages appear in the display and the programme stops	80
The following fault messages appear in the display at the end of the programme ..	81
Problems with TwinDos.....	83
General problems with the washing machine.....	84
An unsatisfactory wash result	86
The door will not open	87
Opening the door in the event of a blocked drain outlet and/or power failure	88
After sales service	90
Repairs	90
Guarantee: U.K.....	90
Guarantee: Other countries.....	90
Optional accessories	90
Installation and connection	91
Front view.....	91
Rear view	92
Installation surface	93
Transporting the washing machine to its installation site	93
Removing the transit bars	93
Re-fitting the transit bars	95
Levelling the machine	96
Screwing out and adjusting the feet	96
Building under a continuous worktop/ in a kitchen run	97
Washer-dryer stack.....	97
The water protection system	98
Connection to the water supply.....	100
Connection to the drainage system	102
Electrical connection U.K.....	103

Consumption data	104
Note for test institutes.....	105
Technical data	106
Settings	107
Selecting and changing settings.....	107
Exiting the Settings menu	107
Language 	108
TwinDos	108
Degree of soiling	108
Time of day	108
Buzzer volume	109
Keypad tone.....	109
Total consumption	109
Code	109
Temperature unit	109
Display brightness	110
Display switch-off setting	110
Machine switch-off setting.....	110
Display maximum load.....	110
Memory.....	111
Longer pre-wash Cottons	111
Soak duration.....	111
Gentle action.....	111
Reduce temp.....	111
Water plus level.....	112
Maximum rinse level	112
Suds cooling	112
Anti-crease.....	112
Delay start	113
Optional accessories	114
Detergent	114
Specialist detergents	114
Fabric care	115
Additives	115

Caring for the environment

Disposal of the packing material

The packaging is designed to protect the washing machine from damage during transportation. The packaging materials used are selected from materials which are environmentally friendly for disposal and should be recycled.

Recycling the packaging reduces the use of raw materials in the manufacturing process and also reduces the amount of waste in landfill sites. Ensure that any plastic wrappings, bags etc. are disposed of safely and kept out of the reach of babies and young children. Danger of suffocation.

Disposal of your old machine

Electrical and electronic machines often contain valuable materials. They also contain materials which, if handled or disposed of incorrectly, could be potentially hazardous to human health and to the environment. They are, however, essential for the correct functioning of your machine. Please do not therefore dispose of it with your household waste.

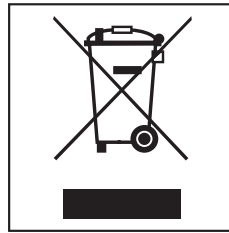

Please dispose of it at your local community waste collection / recycling centre or contact your Dealer for advice.

Ensure that it presents no danger to children while being stored for disposal.

Warning and Safety instructions

This washing machine complies with current safety requirements. Inappropriate use can, however, lead to personal injury and damage to property.

To avoid the risk of accidents and damage to the machine, please read these instructions carefully before using it for the first time. They contain important information on its safety, use and maintenance.

Keep these instructions in a safe place and ensure that new users are familiar with the content. Pass them on to any future user.

Correct application

- ▶ This washing machine is intended for use in domestic households and similar working and residential environments.
- ▶ The washing machine is not intended for outdoor use.
- ▶ It must be used only as a domestic appliance to wash items which are specified by the manufacturer as being washable on the wash care label. Miele cannot be held liable for damage resulting from incorrect or improper use or operation.
- ▶ The washing machine can only be used by people with reduced physical, sensory or mental capabilities, or lack of experience or knowledge, if they are supervised whilst using it or have been shown how to use it safely and recognise and understand the consequences of incorrect operation.

Warning and Safety instructions

Safety with children

- ▶ Children under 8 years of age must be kept away from the washing machine unless they are constantly supervised.
- ▶ Children 8 years and older may only use the washing machine unsupervised if they have been shown how to use it safely and recognise and understand the consequences of incorrect operation.
- ▶ Children must not be allowed to clean or maintain the washing machine unsupervised.
- ▶ Please supervise children in the vicinity of the washing machine and do not let them play with it.

Technical safety

- ▶ Please observe the instructions in "Installation and connection" and "Technical data".
- ▶ Before setting up the washing machine, check it for any externally visible damage. Do not install or use a damaged machine.
- ▶ Before connecting the washing machine, ensure that the connection data on the data plate (fuse rating, voltage and frequency) match the mains electricity supply. If in any doubt, consult a qualified electrician.
- ▶ Reliable and safe operation of this washing machine can only be assured if it has been connected to the mains electricity supply.

Warning and Safety instructions

▶ The electrical safety of this washing machine can only be guaranteed when correctly earthed.

It is essential that this standard safety requirement is met. If in any doubt, please have the wiring system of the building tested by a qualified electrician.

Miele cannot be held liable for the consequences of an inadequate earthing system (e.g. electric shock).

▶ Do not connect the washing machine to the mains electricity supply by a multi-socket adapter, extension lead or similar. These do not guarantee the required safety of the machine (fire hazard due to the risk of overheating).

▶ Faulty components must only be replaced by genuine Miele original spare parts. Only when these parts are fitted can Miele guarantee the safety standards of the machine.

▶ The electrical socket must be easily accessible after installation so that the machine can be disconnected from the electricity supply if necessary.

▶ Unauthorised repairs could result in unforeseen dangers for the user, for which the manufacturer cannot accept liability. Repairs should only be undertaken by a Miele authorised service technician, otherwise any subsequent damage will not be covered by the guarantee.

▶ If the electrical connection cable is faulty it must only be replaced by a Miele authorised service technician to protect the user from danger.

Warning and Safety instructions

- ▶ The machine must be isolated from the electricity supply when cleaning and maintaining the machine and in the event of a fault.
- ▶ The Miele "Water protection system" protects from water damage provided the following conditions are met:
 - the machine is correctly plumbed in and connected to the electricity supply.
 - if a fault or damage has been identified, the machine must be examined by a competent person before further use, and repaired if necessary.
- ▶ The water flow pressure must be at least 100 kPa and should not exceed 1000 kPa.
- ▶ In areas which may be subject to infestation by cockroaches or other vermin, pay particular attention to keeping the machine and its surroundings in a clean condition at all times. Any damage which may be caused by cockroaches or other vermin will not be covered by the guarantee.
- ▶ The machine must not be used in a non-stationary location (e.g. on a ship).
- ▶ Do not make any alterations to the machine, unless authorised to do so by Miele.

Correct use

- ▶ Do not install the washing machine in a room where there is a risk of frost. Frozen hoses may burst or split. The reliability of the electronic control unit may be impaired at temperatures below freezing point.
- ▶ Before using the machine for the first time, check that the transit bars at the rear of the machine have been removed (see "Installation and connection - Removing the transit bars"). During spinning, a transit bar which is still in place may result in damage to both the machine and adjacent furniture or appliances.
- ▶ Turn off the stopcock if the machine is to be left for any length of time (e.g. holiday), especially if there is no floor drain (gully) in the immediate vicinity.
- ▶ Flooding danger.
If hooking the drain hose into a wash basin, check that the water can drain off quickly enough to prevent the sink from overflowing. Make sure the drain hose is secure, so that the force of the water flowing out of the hose does not dislodge it.
- ▶ Take care to ensure that foreign objects (e.g. nails, pins, coins, paper clips) do not find their way into the machine with the laundry. These may damage components of the machine (e.g. suds container, drum), which in turn can result in damage to the laundry.

Warning and Safety instructions

- ▶ Take care when opening the drum door after using the steam function. Danger of burning due to escaping steam and the high temperature of the surface of the drum as well as the porthole glass. Stand back away from the machine and wait until the steam has dissipated.
- ▶ The maximum load for this washing machine is 9 kg (dry weight). See the "Programme chart" for the maximum recommended loads for individual programmes.
- ▶ If the correct amount of detergent is dispensed, the machine should not need to be descaled. If, however, you do wish to descale it, only use a proprietary natural citric acid based descaling agent. Miele recommends using Miele descaling agent which is available to order online at www.miele-shop.com or from Miele. Strictly observe the instructions on the packaging.
- ▶ Textiles which have been pre-treated in solvent based cleaning agents must be thoroughly rinsed in clean water before being washed in the machine.
- ▶ Do not use solvent based cleaning agents, e.g. those containing benzene, in this machine, as this may result in damage to component parts and create toxic fumes. Such agents also pose a fire and explosion hazard.
- ▶ Do not use solvent based cleaning agents, e.g. those containing benzene, to clean the surfaces of the machine. They can cause damage to plastic surfaces.
- ▶ Only use dyes specified by the manufacturer as being suitable for use in a domestic washing machine. Always observe the manufacturer's instructions carefully.

Warning and Safety instructions

- ▶ Colour run and dye removers contain sulphur compounds which can cause damage such as corrosion. Do not use these products in this machine.
- ▶ If detergent comes into contact with the eyes, rinse them thoroughly with lukewarm water immediately. If swallowed, seek medical assistance immediately and retain the packaging or label for reference. Those with skin problems or sensitive skin should avoid their skin coming into contact with detergent.

Accessories

- ▶ Accessory parts may only be fitted when expressly approved by Miele. If other parts are used, guarantee, performance and product liability claims will be invalidated.
- ▶ A Miele tumble dryer can be stacked on top of a Miele washing machine using the appropriate stacking kit (available as an optional accessory). Please make sure you order the correct one for the Miele washing machine and Miele tumble dryer.
- ▶ If installing the machine on a Miele plinth, (available as an optional accessory, depending on country), please make sure you order the correct one for this washing machine.

Miele cannot be held liable for damage caused by non-compliance with these Warning and Safety instructions.

Operating the washing machine

Control panel

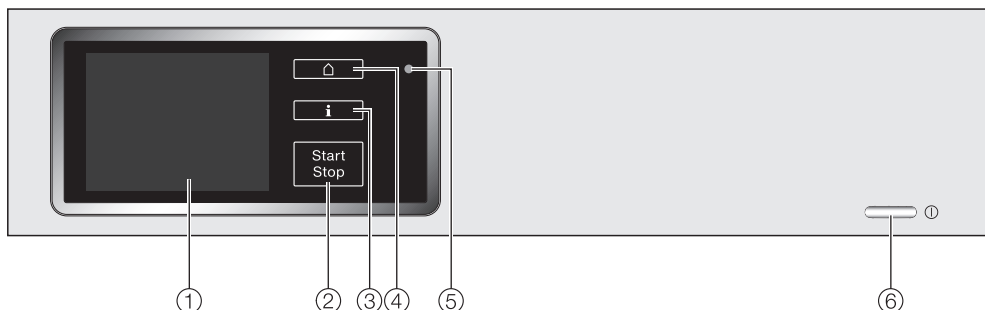

① Touch display

See the next page for more information.

② Start/Stop sensor

For starting the programme selected and cancelling a programme once it has started. The programme selected can be started as soon as the sensor starts flashing.

③ i sensor

The sensor lights up when information about the menu in the display is available.

④ sensor

For returning to the main menu. Values set previously are not saved.

⑤ Optical interface



For service technicians.

⑥ button

For switching the washing machine on and off. To save energy the washing machine will switch off automatically 15 minutes after the end of the programme/anti-crease phase or after being switched on if no other selection is made.

Operating the washing machine

Touch display and sensors

The ,  and *Start/Stop* sensors and the sensors in the display react to finger tip contact.

The display can be scratched by pointed or sharp objects, e.g. pens. Only touch the touch display with your finger tips.

Touching the sensors in the display reveals a list of options or a sub-menu and also takes you to another menu.

In some instances, if you do not touch one of the sensors for several seconds, the display will revert to the previous menu. You may then need to enter the settings again.

Main menu

After switching on the washing machine the main menu will appear in the display.

You access all the important sub-menus from the main menu.

You can return to the main menu at any time by touching the  sensor. Values set previously are not saved.

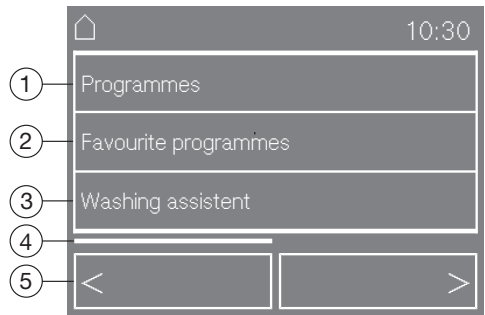

① Programmes

For selecting the wash programme.

② Favourite programmes

You can save up to ten of your own customised wash programmes.

See "Favourite programmes" for more information.

Operating the washing machine

③ Washing assistant

The Washing assistant guides you step by step so that you can select the optimum wash programme for your laundry.

See "Washing assistant" for more information.

④ Scroll bar

The scroll bar indicates that further options or more text follows.

The width of the scroll bar changes depending on the length of the option list or information.

The position of the scroll bar indicates where you are in a list or piece of information.

⑤ Navigation sensors

You can use the < and > sensors to scroll through a list or piece of information.

Touch the > sensor to scroll to the second page of the main menu.

⑥ Mixed items

Use this programme if you do not have enough laundry to run a standard programme but you want to wash a few lightly soiled items with different garment care instructions.

The washing machine will use the list of items to put together a suitable wash programme.

See "Mixed items" for more information.

⑦ Settings

You can alter the washing machine's electronics to suit changing requirements in the Settings  menu.

See "Settings 

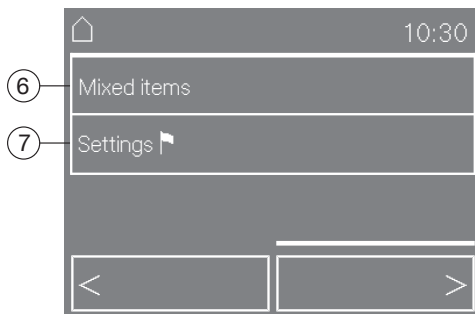

Operating the washing machine

Examples on how to operate the machine

Option lists

Programmes menu (single option list):

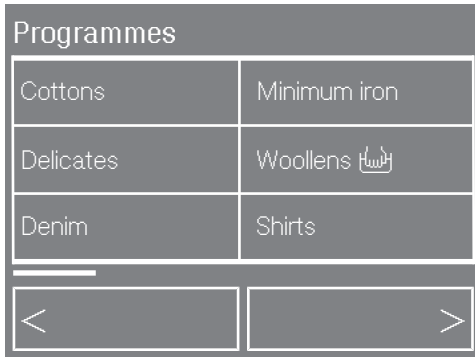

Touching the < or > sensor scrolls to the left or right of the list.

The scroll bar shows you that further options are available.

Touch a programme name to select the wash programme.

The load for the programme selected will appear in the display.

After a few seconds or if you confirm with the OK sensor, the display will change to show the standard menu for the programme selected.

Options menu (multiple option list):

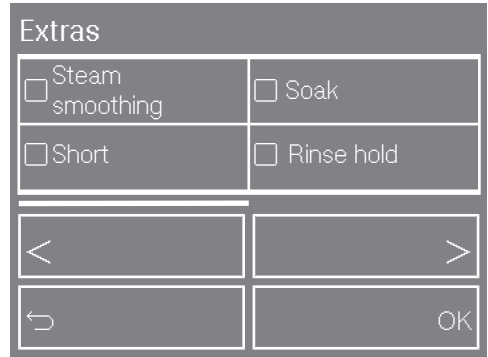

Touching the < or > sensor scrolls to the left or right of the list.

The ↶ sensor takes you back a menu level.

The scroll bar shows you that further options are available.

Touch one or several options to select it/them.

The option currently selected will be marked with a ✓.

Touch the option again to deselect it.

The OK sensor activates or saves the marked option.

Operating the washing machine

Setting numerical values

You can set numerical values in some menus.

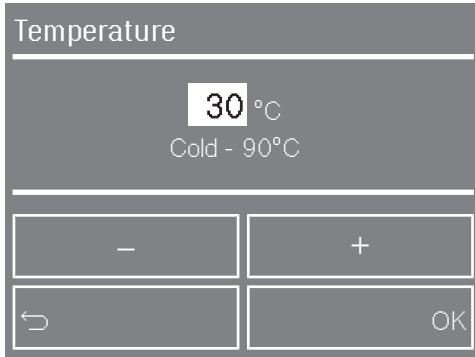

The numerical value is highlighted in white. Touching the - sensor decreases the value and touching the + sensor increases it. The OK is used to adopt the selected value.

Tip: The values will count upwards and downwards automatically if you touch the + or - sensor continuously.

Before using for the first time

Removing the protective foil and stickers

- Remove
 - the protective foil from the door.
 - any stickers from the front and the lid.

 Please do not remove any labels (e.g. the data plate), visible when you open the door.

Removing the detergent cartridges from the drum

There are two cartridges containing UltraPhase1 and UltraPhase2 detergent for automatic detergent dispensing in the drum.

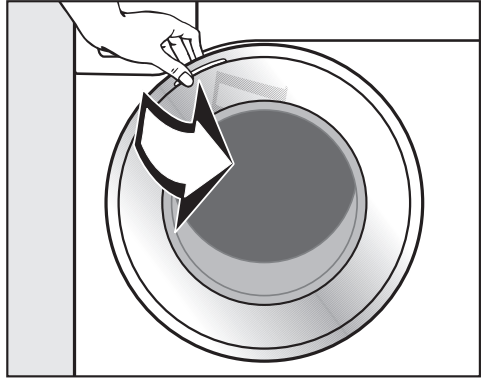

- Pull open the door.
- Take the two cartridges out of the drum.

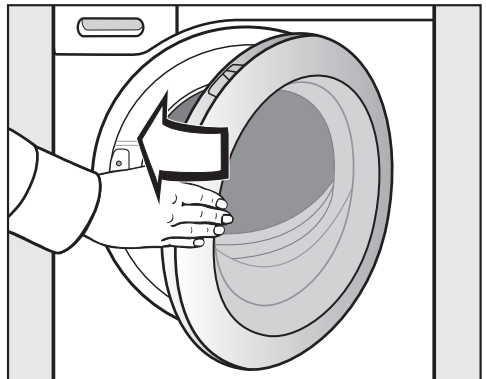

- Shut the door with a gentle swing.

Before using for the first time

After installing the washing machine

 Before using the machine for the first time ensure that it is correctly installed and connected. See "Installation and connection". Also check that the drain filters are securely tightened to prevent the risk of water leaks during use.

This washing machine has undergone a complete functional test at the factory and there will be some residual water in the drum from this process.

For safety reasons, spinning is not possible until the machine has been prepared for using for the first time. To activate the spinning function you must run a wash programme without laundry and without detergent.

Using detergent could result in an excessive build-up of foam.

- Press the  button.

Setting the language

You will be asked to select the language you want for the display. It is possible to change the language at any time subsequently via the Settings menu.

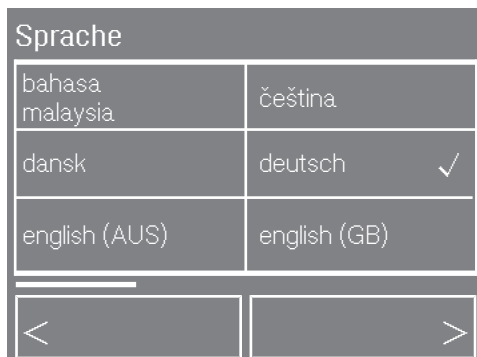

- Touch the < or > sensor until the language you want appears.
- Touch the sensor for the language you want.

The language selected will be marked with a tick ✓ and the display for setting the Clock format will appear.

Before using for the first time

Setting the clock format

Clock format



- Select the clock format you want.

The clock format selected will be marked with a tick ✓ and the display for setting the Time of day will appear.

Setting the time of day

Time of day

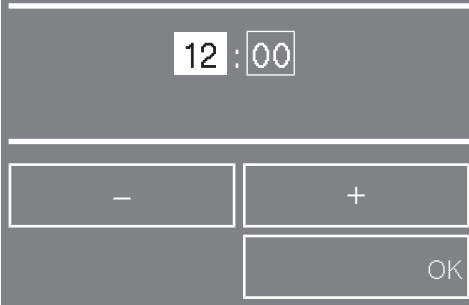

- Use the – and + sensors to set the current hour and confirm with OK.
- Set the minutes in the same way and confirm with OK.

Tip: If you have selected the 12 hour clock format you can then select am or pm.

The display will change to show Miele@home.

Miele@home

The display indicates that this washing machine can be connected to the Miele@home system via a communication module.

- Confirm the information with OK.

The display will change to show Setting up.

Setting up the washing machine.

More information will appear.

- Follow the instructions and confirm the information with OK.

The display will change to show the main menu.

Running the first programme

The TwinDos unit needs to be activated before running the first programme.

- Please see "TwinDos".

TwinDos

The washing machine has an integrated detergent dispensing unit.

The detergent dispensing unit can be used with

1. the Miele 2 Phase System
or
2. any other liquid detergent and/or fabric conditioner.

The Miele 2 Phase System

The Miele 2 Phase System uses a base detergent (UltraPhase 1) and a detergent enhancer (UltraPhase 2). In order to achieve optimum results, the agents are dispensed separately during the wash process. The 2 Phase System cleans both white and coloured textiles thoroughly. UltraPhase 1 and UltraPhase 2 single use cartridges are available to order from Miele or via the internet at www.miele-shop.com (see end of this booklet for contact details).

Liquid detergent/Fabric conditioner

The washing machine is supplied with two refillable containers which you can fill with liquid detergent and/or fabric conditioner.

How TwinDos works

When a programme is selected, the TwinDos programme setting can be activated for this wash process.

To use the TwinDos function, you need to specify the following information for the electronic unit:

1. The **detergent type** and/or **fabric conditioner** with which the containers are filled.
2. The **dosage amount** of the liquid detergent or fabric conditioner. The dosage amount for Miele products is pre-set at the factory.

Do not fill the containers with any specialist detergents. Use CapDosing or the detergent dispenser drawer for these.

Automatic dispensing cannot be selected with some programmes, depending on the detergent present in the TwinDos system. For example, automatic dispensing cannot be activated for the Woollens programme if the Miele 2 Phase System is being used. This prevents woollen garments being damaged by a detergent which is not suitable for washing wool.

Inserting cartridges/containers

! Keep filled containers or cartridges out of the reach of children. Observe the instructions for use and warning instructions given by the detergent manufacturer.

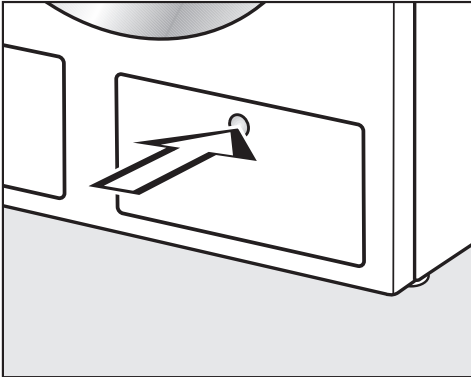

- Press the TwinDos container access panel.

The panel will spring open.

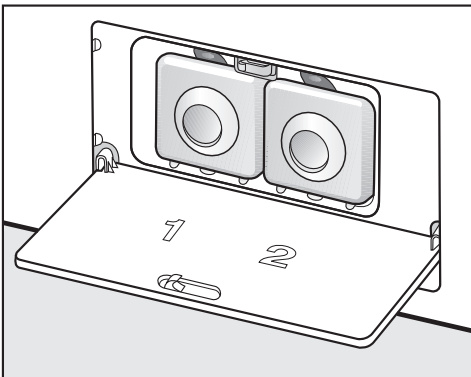

- Drop the panel down.

Using cartridges

UltraPhase 1 and UltraPhase 2 are supplied in single use cartridges.

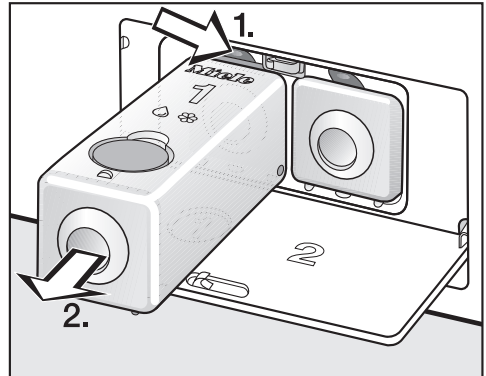

- Press the yellow release button (1.) and pull the container out (2.).

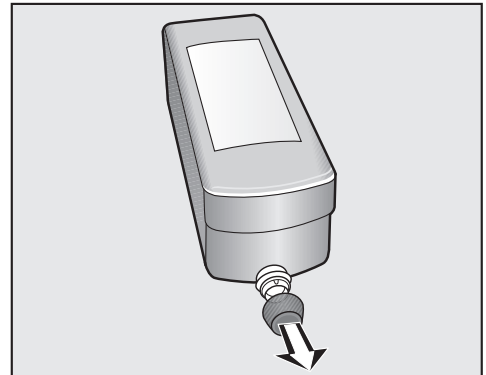

- Remove the cap from the cartridge.

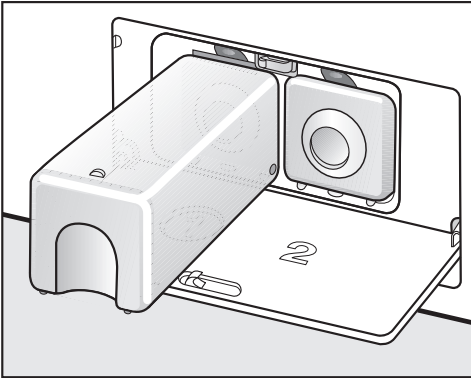

- Push the **UltraPhase 1** cartridge into **Compartment 1** until it locks into position.
- Remove container 2 and push the **UltraPhase 2** cartridge into **Compartment 2** until it locks into position.

Keep the containers in a safe place. They can be used for other types of detergent.

Using containers

- Take the containers out of the compartments.
- Open the yellow stopper and fill the container with your detergent of choice.
- Close the stopper and push the container back into the compartment. Make sure that it locks into position.

Tip: Make a note of which detergents you have filled the containers with so that you then enter the correct settings in the electronics later on.

The following liquid detergents and/or fabric conditioners can be used in the containers:

- Miele Ultra Color
- Miele wool and delicates detergent
- Miele fabric conditioner
- Universal detergent
- Detergent for coloureds
- Detergent for delicates
- Wool and delicates detergent
- Fabric conditioner

Setting the electronic unit to liquid detergent and/or fabric conditioner

- Switch on the washing machine and wait until the main menu appears in the display.
- Use the > sensor to scroll to the second page of the main menu.

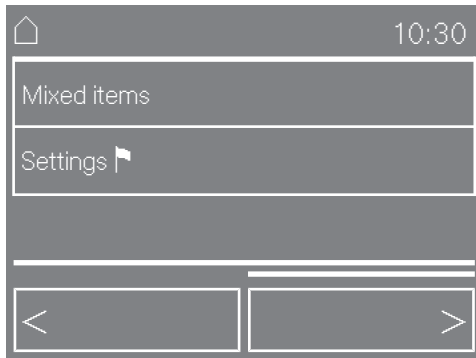

- Touch the Settings  sensor.

The display will change to show the Settings  menu.

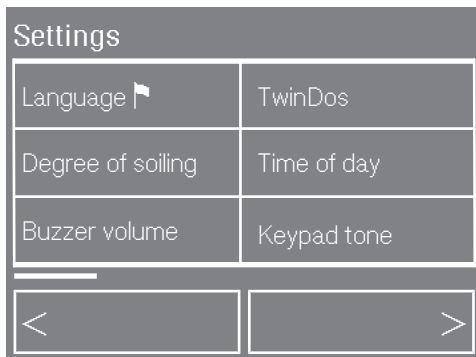

- Touch the TwinDos sensor.

The display will change to the TwinDos setting.

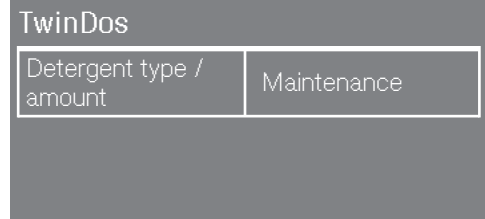

- Touch the Detergent type / amount sensor.

The display will change to show the Detergent type menu.

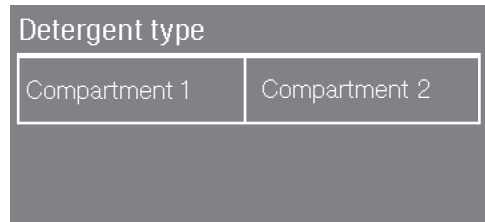

- Touch the Compartment 1 sensor.

The display will change to the screen for selecting the type of detergent.

TwinDos

Settings for UltraPhase 1 and UltraPhase 2

The dosage amounts for UltraPhase 1 and UltraPhase 2 are pre-set for hardness range II (🔧).

Compartment 1

Not defined ✓	Miele UltraPhase 1
Miele UltraColor	Miele WoolCare



- Touch the Miele UltraPhase 1 sensor.

The detergent type selected will be marked with a tick ✓ and the display will change to the screen for setting the Dosage amount.

Dosage amount

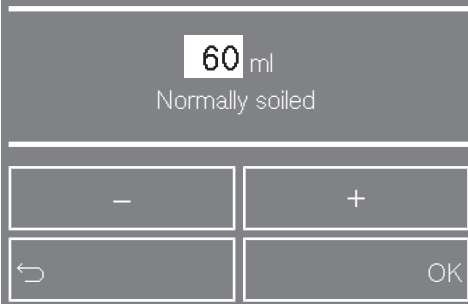

Tip: If you live in an area with water hardness levels I (🔧) or III (🔧), adjust the dosage for Miele products according to the information given on the packaging.

- Use the OK sensor to confirm the pre-set dosage amount or use the – and + sensors to change the amount. Then confirm the new amount.

The washing machine will automatically assign UltraPhase 2 to compartment 2. You just need to confirm or change the dosage amount.

Dosage amount

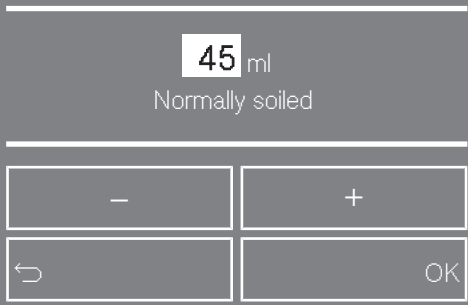

- Use the OK sensor to confirm the pre-set dosage amount or use the – and + sensors to change the amount. Then confirm the new amount.
- Touch the 🏠 sensor to return to the main menu.

Settings for other types of detergent

The dosage amount for Miele products is pre-set for water hardness level II (👉).

Compartment 1

Not defined ✓	Miele UltraPhase 1
Miele UltraColor	Miele WoolCare



- Use the < or > sensors to scroll through the display until the type of detergent you want appears.
- Touch the sensor for the detergent type you want.

The detergent type selected will be marked with a tick ✓ and the display will change to the screen for setting the Dosage amount.

Dosage amount

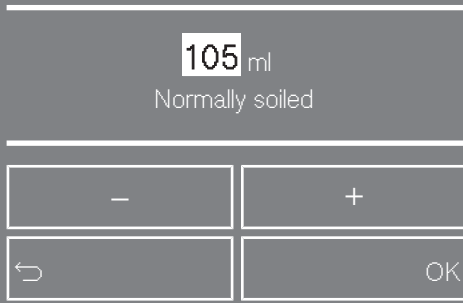

Tip: If you live in an area with water hardness levels I (👉) or III (👉), adjust the dosage for Miele products according to the information given on the packaging.

- Use the OK sensor to confirm the pre-set dosage amount or use the – and + sensors to change the amount. Then confirm the new amount.
- Set compartment 2 as described above.

When adding universal liquid detergent or liquid detergent for coloureds do not load more than 9 kg of laundry and when adding liquid detergent for wool and delicates do not load more than 3 kg of laundry.

- Touch the 🏠 sensor to return to the main menu.

TwinDos

Running the first programme

The TwinDos system needs to be primed before you can use the washing machine.

To do this you **must** run a wash programme **without laundry**.

- Open the stopcock.

Make sure that the washing machine door is closed properly.

- Touch the Programmes sensor.
- Select the Cottons programme.

First the load will appear and then the display will change to show the standard menu for the programme.

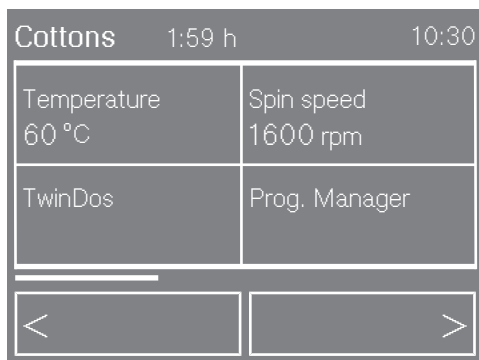

- Select TwinDos.

The display will change to show the Degree of soiling menu.

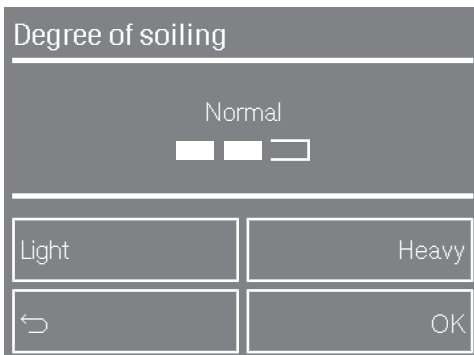

- Use the Heavy sensor to select the Heavy setting and confirm your selection with OK.

If the Miele 2 Phase System is being used:

- Confirm for whites by touching the for whites sensor.

If using other detergents:

- Confirm the marked detergent by touching the relevant sensor.

If using detergent and fabric conditioner:

- Confirm with the OK sensor.
- Touch the flashing Start/Stop sensor.
- Switch the washing machine off at the end of the programme.

The TwinDos unit is now ready for use.

Washing environmentally and economically

Energy and water consumption

- Water consumption and energy usage are determined by the size of the load.
To make the most of your machine, load the maximum dry load for the programme you are using.
- When smaller amounts of laundry are washed, the automatic load recognition system will reduce the amount of water and energy used.
- Use the *Express 20* programme for small, lightly soiled loads.
- Modern detergents make it possible to wash at lower temperatures (e.g. 20°C). Washing using lower temperature settings will save energy.
- To maintain the hygiene of the machine, carry out a hot wash (60°C or above) using powder detergent at regular intervals. Hygiene info will appear in the display to remind you to carry out a hot wash.

Detergent

- For precise dispensing use automatic detergent dispensing.
- Adjust the dosage to the degree of soiling of the laundry.
- Do not exceed the amounts of detergent recommended by the manufacturer on the packaging.

When drying with a tumble dryer

Selecting the highest possible spin speed for the wash programme will save energy when drying in a tumble dryer afterwards.

Washing environmentally and economically

EcoFeedback

You can view information about the energy and water consumption of your washing machine with the ECO Feedback sensor.

The following information will appear in the display:

- an estimate of the energy and water consumption before the programme begins.
- the energy and water consumption and the cost during the programme or at the end of the programme.

1. Estimate

- After selecting a programme, touch the ECO Feedback sensor.

The estimated energy and water consumption levels will be displayed as bar charts.



The more bars (■) visible, the higher the energy or water consumption.

The estimate will vary depending on the wash programme, temperature and any options selected.

2. Actual consumption

You can view the actual energy and water consumption and the cost during the programme and at the end of the programme. See "Settings, Total consumption" for further information on setting the cost.

- Touch the Change sensor.
- In the standard menu of the programme, select the ECO Feedback sensor.

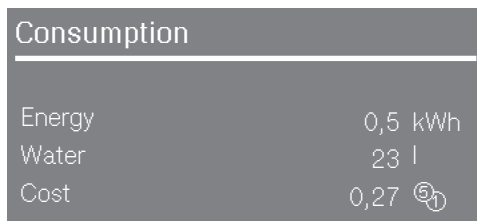

The consumption and cost will alter as the programme progresses.

If the door is opened or the washing machine has switched off automatically at the end of the programme, the data will revert to the estimated consumption.

1. Prepare the laundry

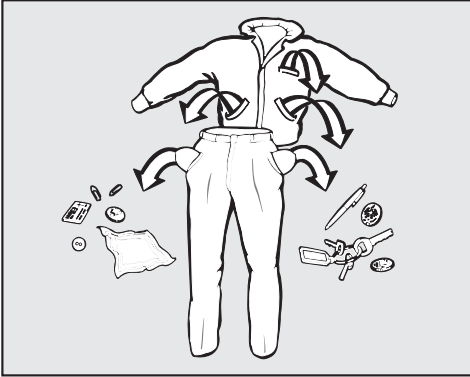

- Empty all pockets.

⚠ Foreign objects (e.g. nails, coins, paper clips, etc.) can cause damage to garments and to components in the machine.

Sort the laundry

- Sort the laundry by colour and by care label. Most garments have a textile care label in the collar or side seam.

Tip: Dark textiles often contain excess dye and should be washed separately several times before being included in a mixed load. Always wash whites and coloureds separately.

Pre-treat stains

- Badly soiled areas, stains etc. should be cleaned as soon as possible, preferably whilst still fresh. Spillages should be carefully dabbed off using a soft, colourfast cloth. Do not rub.

Tip: Badly soiled areas can be pre-treated with liquid detergent, stain removers etc. first, following the manufacturer's instructions. With particularly stubborn stains ask your dry cleaner for advice.

⚠ If you use a solvent-based cleaning agent (e.g. one containing benzene) to pre-treat a stain, make sure that any plastic parts (e.g. buttons) are protected, and that the cleaning agent is rinsed off before washing the garment in the machine.

⚠ Do not use solvent-based cleaning agents in or on this machine.

General tips

- Curtains: Remove lead weights first or place in a laundry bag.
- Underwiring and collar stiffeners: Any loose wiring in bras, shirt collar stiffeners, etc. should be removed or sewn in.
- Close any zips, attach velcro fasteners, fasten hooks and eyes etc. before washing.
- Fasten duvet covers, pillow cases etc. to prevent small items from being rolled up inside them.

Do not wash any items in this washing machine which are specified by the manufacturer as **not washable** on the care label (⊗ symbol).

2. Select a programme

Switch on the washing machine

In order for the load display to function correctly, the drum must be empty before the washing machine is switched on.

- Press the  button.

The interior drum lighting will come on.



The drum lighting will go out automatically after five minutes.

The main menu will appear in the display.

Selecting a programme

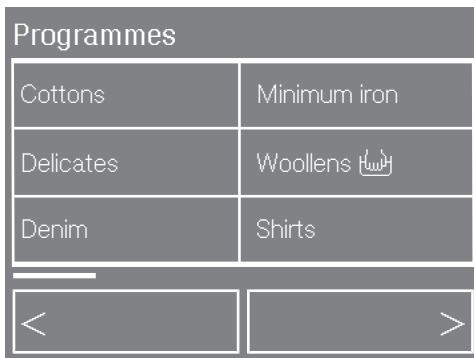
- Touch the Programmes sensor.



- Scroll with the  or  sensor until the programme you want appears in the display.
- Touch the sensor for the programme.

The load for the programme selected will appear in the display.

- Confirm with the OK sensor or wait a few seconds until the display changes to show the standard menu for the programme.

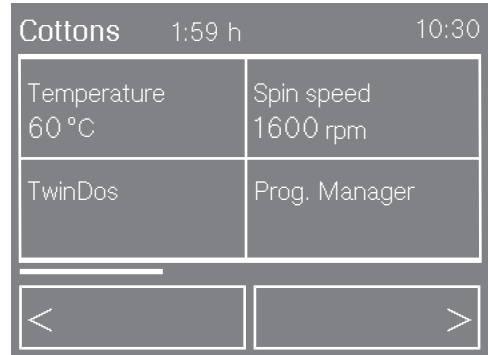

Alternatively you can select a programme via

- Favourite programmes,
- the Washing assistant,
- Mixed items

3. Select programme settings

Temperature

You can alter the pre-set temperature of a wash programme.

- Touch the **Temperature sensor**.
- Set the temperature you want with **-** and **+** and confirm with **OK**.

Spin speed

You can alter the pre-set spin speed of a wash programme.

- Touch the **Spin speed sensor**.
- Set the spin speed you want with **-** and **+** and confirm with **OK**.

TwinDos

You can switch on Automatic dispensing.

- Touch the **TwinDos sensor**.

The display will ask you to enter the degree of soiling of the laundry.

See "Degree of soiling" for more information.

- Enter the degree of soiling with the **Light** or **Heavy** sensor and confirm with **OK**.

If the Miele 2 Phase System is being used, a query about the colour mix of the items will also appear.

- Select for **whites** or **For coloureds**.

If other types of detergent or fabric conditioner are being used, these will appear in the display.

The most suitable detergent will appear in the display, marked with a tick (✓).

If both the detergent and the fabric conditioner are suitable (e.g. detergent for coloureds and fabric conditioner) then both will be selected.

- Confirm or change the selection.

Automatic dispensing is now switched on.

3. Select programme settings

ProgrammeManager

The ProgrammeManager option can be used to customise the washing programmes to suit your requirements.

- Touch the Prog. Manager sensor.
- Select the option you want.

ProgrammeManager is switched on.

See "ProgrammeManager" for more information.

Options

You can use the extra options to augment the wash programmes.

- Touch the Extras sensor.
- Select one or several options.
- Confirm with the OK sensor.

The option is selected.

See "Options" for further information.

Stains

In order to clean stained laundry more effectively you can choose from a list of various types of stains. The wash programme will then adapt to the types of stains selected.

- Touch the Stains sensor.
- Select the type of stains from the list.

You can select a maximum of three types of stain per wash cycle.

With some stains, helpful information will also appear in the display when they are selected.

- Confirm the information with OK.
- Confirm selection of the stains with the OK sensor.

More information may appear in the display which must be confirmed with OK.

The selection is saved.

Switching on delay start

You can use delay start to set the finish time or the start time for a wash programme.

- Touch the Finish at sensor.
- Use the – and + sensors to set the time you want and confirm with the OK sensor.

The delay start time is saved. See "Delay start" for more information.

3. Select programme settings

CapDosing

You can use CapDosing with this wash programme.

- Touch the CapDosing sensor.

The types of capsules which can be used with the programme will appear in the display.

- Select the type of capsule you want.

CapDosing is activated.

See "5. Add detergent, CapDosing" for more information.

Eco Feedback

You can view information about the energy and water consumption of your washing machine with the ECO Feedback sensor.

- Touch the ECO Feedback sensor.

The estimated consumption will appear in the display.

See "Washing environmentally and economically, Eco Feedback" for more information.

Load / Dosage

After loading the washing machine you can check the load quantity, the degree of soiling set and the detergent dosage.

- Touch the Load / Dosage sensor.

The actual load will appear in the display.

- Confirm with OK.

The display will change to show the Degree of soiling menu.

If necessary, you can change the degree of soiling once more.

See "Degree of soiling" for more information.

- Confirm with OK.

The display will change to show the Dosage menu.

Dosage will not appear if TwinDos or CapDosing has been selected for the main wash cycle.

4. Load the washing machine

Open the door

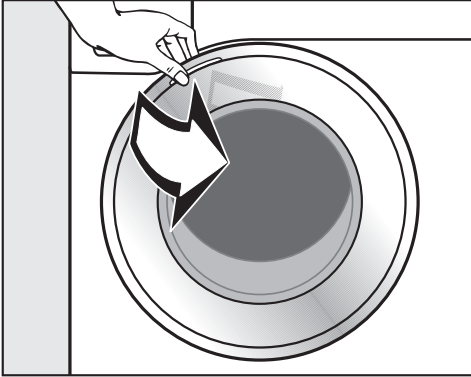

- Take hold of the door and pull it open.

The load display will now appear.

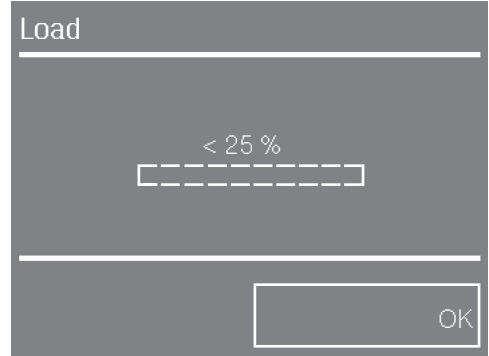

The display shows the amount of laundry loaded in the drum as a % (in 25% steps) of the maximum load permissible for the programme selected.

- Unfold the laundry and load loosely into the drum.

Mixing both large and small items gives better wash results and also helps distribute the load evenly during spinning.

The most efficient use of energy and water is achieved when a full load is washed. However, do not overload as this reduces cleaning efficiency and causes creases.

4. Load the washing machine

Close the door

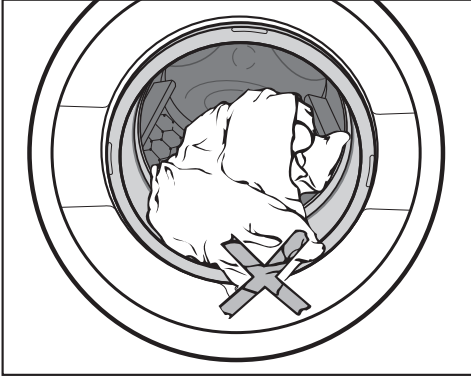

- Make sure that no items are caught between the door and the seal.

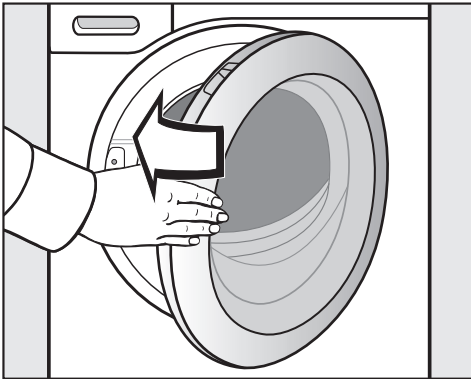

- Shut the door with a gentle swing.

The display will ask you to enter the degree of soiling of the laundry.

- Enter the degree of soiling with the **Light** or **Heavy** sensor and confirm with **OK**.

See "Degree of soiling" for more information.

The dosage display will now appear.

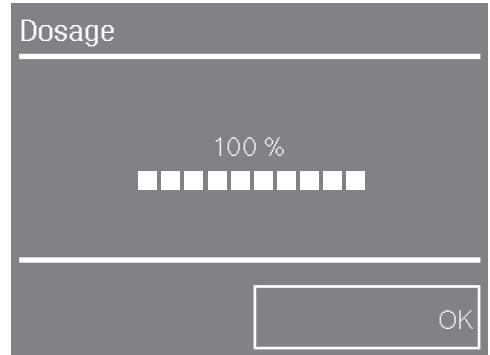

- Confirm with **OK**.

Dosage will not appear if **TwinDos** or **CapDosing** has already been selected for the main wash cycle.

5. Add detergent

There are several options for adding detergent.

TwinDos

If you selected **TwinDos** when setting the programme, detergent will be dispensed automatically for this wash programme.



The detergent dispensed will depend on which agents have been added to the TwinDos unit.

CapDosing

If you selected **CapDosing** when setting the programme, detergent will be dispensed via the capsule for this wash programme.

Only one capsule can be selected per wash programme.

Three different types of capsule are available:

-  = Fabric care (e.g. fabric conditioner, proofing agent)
-  = Additives (e.g. detergent enhancers)
-  = Detergent (for the main wash only)

Depending on the setting selected, the detergent, additive or fabric care agent will be dispensed via the capsule.

Each capsule contains the correct amount for one wash cycle.

You can order the capsules online at www.miele-shop.com or from Miele (see the end of this booklet for contact details).

 Keep capsules out of the reach of children.

Inserting a capsule

- Open the detergent dispenser drawer.

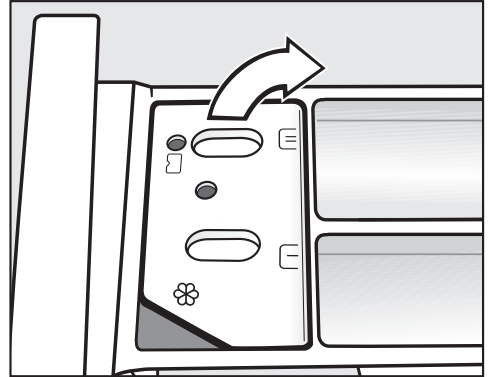

- Open the lid of the  compartment.

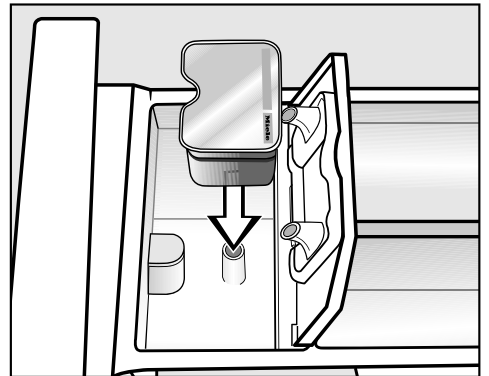

- Press the capsule in firmly.

5. Add detergent

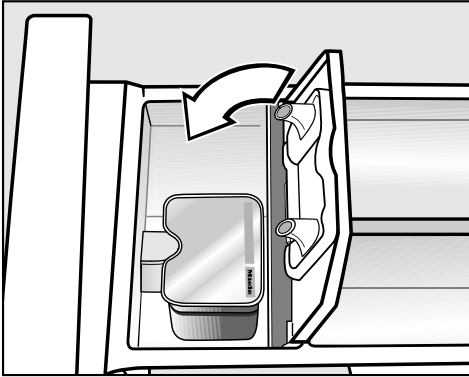

- Close the lid and press it firmly shut.
- Close the detergent dispenser drawer.

The capsule is opened by the act of inserting it in the detergent dispenser drawer. The contents can run out of the capsule if you then remove it from the drawer before it is used. In this case, dispose of the capsule and do not re-use it.

The wash programme will dispense the contents of the capsule at the correct time.

Water intake to the ☼ compartment is solely via the capsule.

No additional fabric conditioner may be added to the ☼ compartment when using a capsule.

- Remove the empty capsule at the end of the programme.

For technical reasons a small amount of water will remain in the capsule.

5. Add detergent

Detergent dispenser drawer

Add detergent in accordance with the value in the dosage display.

The percentage shown relates to the amount of detergent recommended by the manufacturer on the packaging.

- 40% = Add slightly less than half the amount recommended
- 50% = Add half the amount recommended
- 60% = Add slightly more than half the amount recommended
- 75% = Add three quarters of the amount recommended
- 100% = Add the full amount of the detergent recommended

Take the hardness level of your water into account.

Too little detergent results in:

- Laundry not getting properly clean and with time it may become grey and hard to the touch.
- Greasy particles clinging to laundry.
- Limescale deposits on the heater elements.

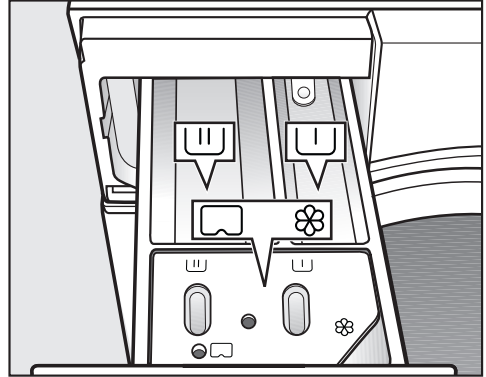

Too much detergent results in:

- Excessive foam which causes a low level of agitation and poor wash, rinse and spin results.
- High water consumption (an additional rinse cycle will automatically switch in).
- A burden to the environment.



- Pull out the detergent dispenser drawer and add detergent to the compartments as follows:



Detergent for the pre-wash (divide the total recommended amount as follows: add $\frac{1}{3}$ to compartment  and $\frac{2}{3}$ to compartment )



Detergent for the main wash, including Soak, if selected



Fabric conditioner, liquid starch or capsules.

See "Detergent" for further information.

6. Start the programme - the end of a programme

Starting the programme

- Touch the flashing *Start/Stop* sensor.

The door will lock (the  symbol will appear in the display to show this) and the programme will start.

The programme status will appear in the display.

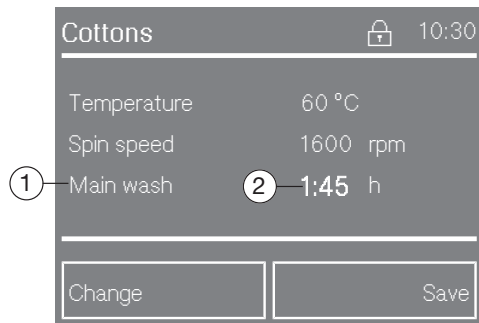

The washing machine lets you know which section of the programme has been reached ① and the programme duration remaining ②. If a delay start time has been selected, then this will appear in the display.

The drum lighting switches off once the programme has started.

At the end of a programme

The door is still locked during the anti-crease phase and the following will appear alternately in the display: Anti-crease and Finished.

The following information will also appear: Press the Stop button, then unload the drum.

- Touch the *Start/Stop* sensor. This will unlock the door.

The door unlocks automatically at the end of the anti-crease phase.

- Pull open the door.
- Remove the laundry.

Check that all items have been removed from the drum. Items left in the drum could discolour other items in the next wash or become discoloured themselves.

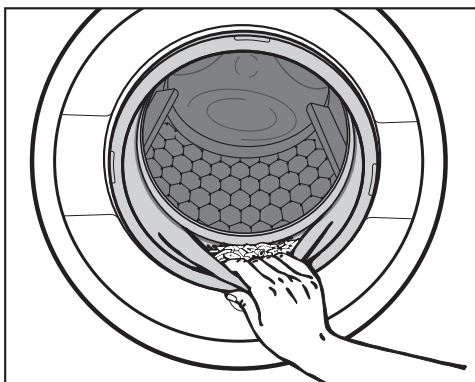

- Check the folds in the door seal for any small articles, e.g. buttons, which might be lodged there.
- Switch the washing machine off with the ① button.
- Close the door. Otherwise there is a danger of objects being placed inadvertently in the drum. If these remained unnoticed and were washed in the next load, they could damage the laundry.
- If applicable, remove the used capsule from the detergent dispensing drawer.

Degree of soiling

If you have selected automatic dispensing or loaded the washing machine, the display will then prompt you to enter the degree of soiling.

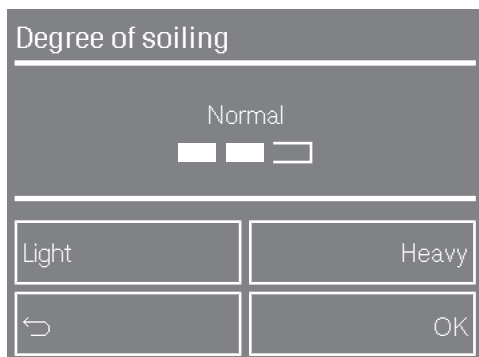

You can set the degree of soiling with the **Light** or **Heavy** sensor. Your selection is confirmed with the **OK** sensor.

Lightly soiled

No visible dirt or stains. Possibly slight body odour.

Normally soiled

Visibly dirty and/or just a few slight stains.

Heavily soiled

Soiling and/or stains clearly visible.

The following parameters will change depending on the degree of soiling selected:

- detergent dosage
- rinse water level
- programme duration (with light soiling the programme duration will be shorter)

The degree of soiling cannot be selected for some programmes. These programmes are designed for normally soiled laundry.

Tip: You can alter the default setting for the degree of soiling or switch off the degree of soiling query in Settings (see "Settings - Degree of soiling").

Garment care label symbols

Washing	
The figure quoted in the bucket is the maximum temperature the garment can be washed at. The number of bars under the symbol indicates the level of agitation permitted.	
	No bar under the symbol: = normal agitation
	One bar under the symbol: = reduced agitation
	Two bars under the symbol: = much reduced agitation
	Hand wash (if no temperature is specified, use the lowest temperature or cold)
	Do not wash

Programme selection examples

Programme	Garment care label symbols
Cottons	
Minimum iron	
Delicates	
Woolens	
Silks	
Express 20	
Automatic plus	

Drying	
The number of dots indicates the drying temperature	
	Normal temperature
	Low temperature
	Do not tumble dry



Ironing	
The number of dots indicates the ironing temperature	
	Hot iron (max. sole plate temp. approx. 200°C)
	Medium hot iron (max. sole plate temp. approx. 150°C)
	Cool iron (max. sole plate temp. approx. 110°C). Do not steam iron garments carrying this symbol as this could cause irreversible damage.
	Do not iron

Professional cleaning	
	Dry clean only. The letters indicate the type of cleaning agent required.
	Professional Wet Clean only
	Do not dry clean

Bleaching	
	Any oxidising bleaching agent can be used
	Only use an oxygen based bleach or a non-chlorine bleach
	Do not bleach

Spinning

Final spin speed

Programme	rpm
Cottons	1600
Minimum iron	1200
Delicates	900
Woolens 	1200*
Denim	900
Shirts	900
Steam care	–
Express 20	1200
QuickPower wash	1600
Automatic plus	1400
Freshen up	–
Dark garments	1200
Down duvets	1200
Outerwear	800
Proofing	1000
Separate rinse	1600*
Starch	1400*
Silks 	600*
Sportswear	1200
Down filled items	1200
Curtains	600
First wash	1200
Pillows	1200
Drain / Spin	1600
Cottons 	1600
Maintenance wash	900

Final spin speed in the programme

When a programme is selected the optimum spin speed for that programme will appear in the display. For programmes marked with a * in the chart, the optimum spin speed is not the maximum spin speed.

You can reduce the final spin speed.

However, you cannot select a final spin speed higher than that shown in the chart.

Rinse and interim spin

There is a spin after the main wash and between the rinses. A reduction in the final spin speed will also reduce the interim spin speed. If a spin speed of less than 700 rpm is selected for the *Cottons* programme, an additional rinse is introduced.

To omit the final spin (Rinse hold)

- Select the Rinse hold option. The laundry is not spun after the final rinse and remains in the final rinse water. This helps prevent creasing if the laundry is not going to be removed from the drum immediately after the end of the programme.

To start the final spin:

- Touch the Change sensor.
- Select Spin speed and set the spin speed you want.
- Start the final spin with the *Start/Stop* sensor.

To end the programme:

- Touch the Change sensor.
- Select Spin speed and set the spin speed to 0 rpm (no spin).
- Touch the *Start/Stop* sensor.

The water will drain away.



To omit rinse and interim spin and the final spin

- Touch the Spin speed sensor.
- Select the 0 rpm setting.

After the last rinse, the water will be pumped away and the anti-crease phase will switch in.

In some programmes an additional rinse is introduced with this setting.





Programme chart

Cottons		cold to 90°C	Max. load 9.0 kg
Use for	Cotton, linen or mixed fibre fabric, e.g. table linen, towelling, underwear, T-shirts etc.		
Note	Where particularly high levels of hygiene are required please select a temperature of 60°C or higher.		
Minimum iron		cold to 60°C	Max. load 4.0 kg
Use for	Synthetic, mixed fibre and easy care cotton.		
Note	Reduce the spin speed for fabric which creases easily.		
Delicates		cold to 60°C	Max. load 3.0 kg
Use for	Delicate garments made from synthetic fibre, mixed fibre, rayon and viscose.		
Note	– Deselect the spin for items which crease easily.		
Woollens 		cold to 40°C	Max. load 2.0 kg
Use for	Machine-washable or hand-washable wool or wool blend fabric. If the care label does not specify a temperature, wash using the cold setting.		
Note	Reduce the spin speed for items which crease easily.		
Denim		cold to 60°C	Max. load 3.0 kg
Notes	<ul style="list-style-type: none"> – Wash denim inside-out. – Denim often contains excess dye and may run during the first few washes. Wash light and dark coloured items separately. – Close any zips, do up buttons etc. before washing. 		
Shirts		cold to 60°C	Max. load 2.0 kg
Use for	Shirts and blouses made of cotton and mixed fibre.		
Notes	<ul style="list-style-type: none"> – Pre-treat soiled cuffs and collars if necessary. – Wash silk shirts and blouses in the <i>Silks</i>  programme. 		

Programme chart

Steam care		Max. load 2.0 kg
Use for	<p>Reducing the amount of creasing in damp, freshly washed and spun cotton or linen garments.</p> <p>The garments must be suitable for drying in a tumble dryer ☼ ☼ and suitable for ironing ☼ ☼.</p>	
Notes	<ul style="list-style-type: none"> – 5-6 shirts make up a load of approx. 2.0 kg. – Smaller loads give a better result. – Remove garments as soon as the programme has finished and then tumble dry using the Gentle smoothing programme or place on a hanger to dry. – Not suitable for garments made of wool or wool blend fabric. 	
Express 20		Max. load 3.5 kg
	cold to 40°C	
Use for	Cotton garments that have hardly been worn or are only very lightly soiled.	
Note	The <i>Short</i> option is activated automatically.	
QuickPower wash		Max. load 5.0 kg
	60°C – 40°C	
Use for	Normally soiled garments which are also suitable for washing in the <i>Cottons</i> programme.	
Note	– A special saturation process and wash rhythm ensure that the laundry is cleaned particularly quickly and thoroughly.	
Automatic plus		Max. 6.0 kg
	cold to 40°C	
Use for	Mixed loads of garments suitable for the <i>Cottons</i> and <i>Minimum iron</i> programmes.	
Note	The wash parameters (e.g. water level, wash rhythm and spin speed) are adjusted automatically in this programme to ensure the best possible care and wash result for each item.	

Programme chart

Freshen up		Max. load 1.0 kg
Use for	Dry, clean cotton, linen or mixed fibre garments which are slightly creased. The garments must be suitable for drying in a tumble dryer   and suitable for ironing   .	
Notes	<ul style="list-style-type: none"> – Smaller loads give a better result. – Remove garments as soon as the programme has finished and then tumble dry using the Gentle smoothing programme or place on a hanger to dry. – Not suitable for garments made of wool or wool blend fabric. 	
Dark garments		cold to 60°C
		Max. load 3.0 kg
Use for	Black and dark items made of cotton or mixed fibres.	
Note	Wash inside out.	
Down duvets		cold to 60°C
		Max. load 2.5 kg 1 down duvet 2.20 m x 2.00 m
Use for	Quilts, duvets and pillows with feather or down filling.	
Notes	<ul style="list-style-type: none"> – Remove air from the items before washing to prevent an excessive build-up of foam. To do this either push the items into a narrow laundry bag to compress them or tie the items together with a washable strap. – Observe the instructions on the wash care label. 	
Outerwear		cold to 40°C
		Max. load 2.5 kg
Use for	Performance outerwear (e.g. jackets and trousers) made from membrane fabric such as Gore-Tex®, SYMPATEX®, WINDSTOPPER® etc.	
Notes	<ul style="list-style-type: none"> – Zip up or close jackets before washing. – Do not use fabric conditioner. – If wished, these garments can also be re-proofed using the <i>Proofing</i> programme. Proofing should not be done every time the garment is washed. 	





Programme chart

Proofing		40°C	Max. load 2.5 kg
Use for	Treating microfibre fabric, skiwear and table linen made from mainly synthetic fibres to provide a water and dirt resistant finish.		
Notes	<ul style="list-style-type: none"> – The items should be freshly laundered and spun or dried before proofing. – For best results, the items should be heat-treated afterwards either in a tumble dryer or by ironing. 		
Separate rinse			Max. load 9.0 kg
Use for	Rinsing handwashed items.		
Note	Reduce the spin speed for items which crease easily.		
Starch			Max. load 9.0 kg
Use for	Starching table cloths, serviettes and workwear.		
Notes	<ul style="list-style-type: none"> – Reduce the spin speed for items which crease easily. – The laundry should be washed but not treated with fabric conditioner. 		
Silks 		cold to 30°C	Max. load 1.0 kg
Use for	Silks and other handwashable fabric with no wool content.		
Note	Place tights, bras etc. in a laundry bag.		
Sportswear		cold to 60°C	Max. load 3.0 kg
Use for	Sportswear such as singlets and leggings as well as microfibre and fleece garments.		
Notes	<ul style="list-style-type: none"> – Do not use fabric conditioner. – Observe the manufacturer's care label. 		

Programme chart



Down filled items		cold to 60°C	Max. load 2.0 kg
Use for	Jackets, sleeping bags, pillows and other down-filled items.		
Notes	<ul style="list-style-type: none"> – Remove air from the items before washing to prevent an excessive build-up of foam. To do this either push the items into a narrow laundry bag to compress them or tie the items together with a washable strap. – Observe the instructions on the wash care label. 		
Curtains		cold to 40°C	Max. load 2.0 kg
Use for	Curtains, including net curtains, specified as machine-washable by the manufacturer.		
Notes	<ul style="list-style-type: none"> – To remove dust, the <i>Pre-wash</i> option is selected automatically. – For curtains which crease easily, reduce the spin speed or deselect the spin. – Remove weights from curtains. 		
First wash		cold to 40°C	Max. load 3.0 kg
Use for	New cotton, towelling and synthetic items.		
Note	Use this programme to wash any manufacturing residues out of new items.		
Pillows		cold to 60°C	2 pillows (40 x 80 cm) or 1 pillow (80 x 80 cm)
Use for	Synthetic filled washable pillows.		
Note	<ul style="list-style-type: none"> – Remove air from the pillow before washing to prevent an excessive build-up of foam. To do this either push the pillow into a narrow laundry bag to compress it or tie the pillow together with a washable strap. – Observe the instructions on the wash care label. 		
Drain / Spin			–
Notes	<ul style="list-style-type: none"> – Drain only: Select 0 rpm for the spin speed. – Make sure you select the appropriate spin speed. 		

Programme chart

Cottons 		 / 	Max. load 9.0 kg
Use for	Normally soiled cotton garments.		
Notes	<ul style="list-style-type: none"> – These settings are the most efficient in terms of energy and water consumption for washing cottons. – With  the actual wash temperature reached will be lower than 60°C although the wash performance is the same as with the Cottons 60°C programme. 		
<p>Note for test institutes:</p> <p>The test programme conforms to EN 60456 and the energy label to Directive 1061/2010.</p>			
Maintenance wash		75°C	Empty
<p>With frequent washing at low temperatures there is a danger of a build-up of bacteria in the washing machine.</p> <p>Cleaning the washing machine will significantly reduce bacteria, fungus and bio-film and prevent the build-up of unpleasant odours.</p>			
Notes	<ul style="list-style-type: none"> – Optimum results can be achieved by using Miele machine cleaner. Alternatively, a universal powder detergent can be used. – Dispense the machine cleaner or universal powder via the detergent dispenser drawer. – Do not load any laundry. The drum must be empty for the maintenance wash. 		

Programme sequence

	Main wash		Rinses		Spinning
	Water level	Wash rhythm	Water level	Rinses	
Cottons		(A)		2-5 ¹⁾²⁾³⁾	✓
Minimum iron		(B)		2-4 ²⁾³⁾	✓
Delicates		(C)		2-4 ²⁾³⁾	✓
Woolens		(E)		2	✓
Denim		(B)		2-4 ²⁾³⁾	✓
Shirts		(C)		3-4 ³⁾	✓
Express 20		(A)		1	✓
QuickPower wash		(A)		1	✓
Automatic plus		(A)(B)		2-4 ²⁾³⁾	✓
Dark garments		(B)		3-5 ²⁾³⁾	✓
Down duvets		(C)		3-4 ³⁾	✓
Outerwear		(C)		3-4 ³⁾	✓
Proofing	-	(B)		1	✓
Separate rinse	-	-		2	✓
Starch		(B)	-	-	✓
Silks		(E)		2	✓
Sportswear		(C)		2-3 ³⁾	✓
Down filled items ⁴⁾		(C)		3-4 ³⁾	✓
Curtains		(C)		3-4 ³⁾	✓
First wash		(B)		2-3 ³⁾	✓
Pillows ⁴⁾		(C)		3-4 ³⁾	✓
Drain / Spin	-	-	-	-	✓
Cottons		(A)		2-5 ²⁾³⁾	✓
Maintenance wash		(A)		3	✓

-  = Low water level
 = Medium water level
 = High water level
Ⓐ = Intensive rhythm
Ⓑ = Normal rhythm
Ⓒ = Sensitive rhythm
Ⓓ = Ultra sensitive rhythm
Ⓔ = Handwash rhythm
✓ = Carried out
– = Not carried out

The washing machine has fully electronic controls with automatic load recognition. It takes in the right amount of water required for the programme depending on the amount of laundry and its absorbency rate.

The programme sequences shown in the chart are based on the standard programme with a full load.

The washing machine programme sequence display shows which stage of the programme has been reached.

Special features in the programme sequence

Anti-crease:

At the end of the programme the drum continues to turn at intervals for up to 30 minutes to help prevent creasing.

Exception: There is no anti-crease phase in the *Woolens* programme.

The door can be opened at any time during the anti-crease phase.

¹⁾ A second rinse is carried out when a temperature of 60°C or above is selected. A third rinse is carried out when a temperature below 60°C is selected.

²⁾ An additional rinse is carried out if:

- there is too much foam in the drum
- a spin speed lower than 700 rpm has been selected
- the spin speed has been deselected

³⁾ An additional rinse is carried out if:

- the Extra rinse option is selected.

⁴⁾ Run-up to spin: A run-up to spin is carried out before the wash process begins to deflate down filled items. Subsequent water intake for the main wash is through compartment .

Programme sequence

Cottons and Minimum iron

PowerWash 2.0, the washing technique developed by Miele, is activated in the *Cottons* programme with small and medium-sized loads and in the *Minimum iron* programme

How it works

Conventional washing techniques wash with more water than the laundry can absorb. This total volume of water needs to be heated.

The PowerWash 2.0 washing technique only uses slightly more water than the laundry can absorb. The water which has not been absorbed by the laundry heats up the drum and the laundry and is sprayed into the laundry over and over again. This reduces the amount of energy used.

Activation

The washing machine calculates the load at the beginning of the wash programme. PowerWash 2.0 is activated if the following conditions are present:

- there is a small to medium-sized laundry load in the *Cottons* programme and in the *Minimum iron* programme.
- the temperature selected must not be more than 60°C.
- the final spin speed selected must not be lower than 600 rpm.
- CapDosing (☺, ☹) has not been selected for the main wash.

With some options (e.g. Pre-wash, Water plus) PowerWash 2.0 is not activated.

Special features

– Drenching phase

The washing machine will spin a few times at the beginning of the programme. During spinning, the water discharged is sprayed back into the laundry in order to achieve optimum moisture penetration.

The optimum water level is set at the end of the drenching phase. If necessary, the washing machine will pump water away or take in a little more fresh water.

– Noises during the heating phase

Unusual bubbling noises can occur while the laundry and the drum are being heated.

– Use of detergent

Make sure you add the correct amount of detergent (for smaller loads).

For optimum detergent application, use the TwinDos function.

Changing the programme sequence

Cancelling a programme

You can cancel a programme at any time after it has started:

- Touch the *Start/Stop* sensor.
- Select *Cancel programme*.

The suds will be pumped away. The programme is now cancelled. The door lock will be released.

- Pull open the door.
- Remove the laundry.

If you want to select a different programme

- Close the door.
- Select the programme you want.
- Add detergent to the detergent dispenser drawer, if necessary.
- Touch the *Start/Stop* sensor.

The new programme will begin.

Interrupting a programme

- Switch the washing machine off with the ① button.
- Switch the washing machine back on with the ① button to continue with the same programme.

Changing a programme

After the start of a programme it is no longer possible to select a different programme.

Temperature

With the exception of the *Cottons* programme, it is possible to select a different temperature up to five minutes after the programme has started.

- Touch the *Change* sensor.
- Touch the *Temperature* sensor.
- Set the temperature you want with – and + and confirm with OK.

Spin speed

It is possible to change the spin speed up until the final spin begins.

- Touch the *Change* sensor.
- Touch the *Spin speed* sensor.
- Set the spin speed you want with – and + and confirm with OK.

Options

It is possible to select or deselect certain options up to five minutes after the programme has started.

It is not possible to make any changes to the programme or to cancel it if the safety lock has been activated.

Changing the programme sequence

Adding or removing laundry after the programme has started

You can add or remove items during the first few minutes after the programme has started.

- Touch the *Start/Stop* sensor.

The following will appear in the display:

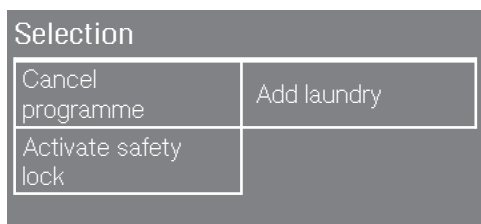

- Touch the *Add laundry* sensor.

The programme will stop and the door will unlock.

- Pull open the door.
- Add laundry or remove individual items.
- Close the door.
- Touch the *Start/Stop* sensor.

The programme will continue.

Please note the following:

Once a programme has started successfully the washing machine cannot recognise any adjustment to the load.

For this reason, if laundry is added or removed after the start of a programme, the machine will always complete the programme cycle assuming a full load.

The door cannot be opened, if:

- the suds temperature is above **55°C**.
- the water is above a certain level.
- the programme has reached the *Spin* stage.

If you want to open the door when the above conditions are present you will need to cancel the programme.

The safety lock will remain activated if the temperature in the drum is above 55°C. The lock will not deactivate until the temperature has dropped to below 55°C.

Safety lock

The safety lock prevents the temperature, spin speed or options being altered during a wash programme.

To activate the safety lock

- Touch the *Start/Stop* sensor.
- Select *Activate safety lock*.

Locked will appear in the display.

The safety lock is activated.

To deactivate the safety lock

- Touch the *Start/Stop* sensor.

Deactivate safety lock? will appear in the display.

- Confirm that you want to deactivate the safety lock with the *Deactivate sensor*.

Unlocked will appear in the display.

The safety lock is now deactivated.

ProgrammeManager

The ProgrammeManager option can be used to customise the washing programmes to suit your requirements.

Intensive

For hard-wearing laundry that is very heavily soiled. Cleaning efficiency is increased through more intense mechanical action and the application of more heat energy.

ECO

This option reduces energy consumption whilst maintaining cleaning efficiency. This is achieved by increasing the wash duration and at the same time reducing the wash temperature selected.





Extra gentle

This option decreases mechanical action in order to reduce creasing.

Extra quiet

This option reduces noise levels during the programme. Use this if you want to wash during quiet periods (for instance when children are sleeping). The machine will activate the "Rinse hold" option and not spin. The programme duration is longer.



AllergoWash

This option should be used where high standards of hygiene are required. More energy is used to lengthen temperature holding times and more water is used to increase rinsing efficiency. The items must be suitable for drying in a tumble dryer   and suitable for ironing  .

Not all ProgrammeManager options are suitable for use with every programme. Please refer to the "Wash programme chart - ProgrammeManager" on the following page for a list of suitable programmes.

Wash programme chart - ProgrammeManager





ProgrammeManager cannot be selected with programmes which are **not** listed in the chart below.

	Intensive	ECO	Extra gentle	Extra quiet	Allergo-Wash
Cottons	X	X	X	X	X
Minimum iron	X	X	X	X	X
Delicates	X	X	X	X	X
Woolens 	-	-	-	X	-
Denim	X	X	X	X	X
Shirts	X	X	X	X	X
Express 20	-	-	-	X	-
Automatic plus	X	X	X	X	X
Dark garments	X	X	X	X	X
Down duvets	X	X	X	-	X
Outerwear	X	X	X	X	X
Proofing	-	-	-	X	-
Separate rinse	-	-	-	X	-
Starch	-	-	-	X	-
Silks 	-	-	-	X	-
Sportswear	X	X	X	X	X
Down filled items	X	X	X	X	X
Curtains	X	X	X	X	X
First wash	-	-	X	X	-
Pillows	X	X	X	X	X
Cottons 	-	-	X	X	X

Options

Steam smoothing

Steam is injected into the drum at the end of the wash process. Reducing the maximum load by 50% will give a better result. For steam smoothing to work properly there needs to be a certain amount of residual moisture still present in the laundry and so the final spin speed is adjusted accordingly.

The garments must be suitable for drying in a tumble dryer   and suitable for ironing  .

Soak

For heavily soiled and stained items with protein stains.

A duration of between 30 minutes and 5 hours in 30 minute increments can be chosen for the soak process. See "Settings" for more information.

The factory default setting is 30 minutes.

Short

Use this option for light soiling with no visible staining.

The wash duration is reduced.

Rinse hold

The laundry is not spun after the final rinse and remains in the final rinse water. This helps prevent creasing if the laundry is not going to be removed from the drum immediately after the end of the programme.

Pre-wash

For laundry with large amounts of dirt, e.g. dust and sand.

Water plus

The water level in the wash and rinse stages is increased.

You can select by how much the water level is increased, see "Settings, Water plus level".

Extra rinse

An additional rinse cycle is carried out to give a better rinse result.

Not all options are suitable for use with every programme. You can only select options which are compatible with the programme being used. Please refer to the "Wash programme chart - Options" on the following page for a list of suitable programmes.

Wash programme chart - Options

None of the options can be selected with programmes which are not listed in the chart below.

	Steam smoothing	Soak	Short	Rinse hold	Pre-wash	Water plus	Extra rinse
Cottons	X	X	X	X	X	X	X
Minimum iron	X	X	X	X	X	X	X
Delicates	X	X	X	X	X	X	X
Woolens (👉)	-	-	-	X	-	-	-
Denim	X	X	X	X	X	X	X
Shirts	X ¹⁾	X	X	X	X	X	X
Express 20	X	-	X ¹⁾	X	-	-	-
QuickPower wash	X	-	-	X	-	-	-
Automatic plus	X	X	-	X	X	-	-
Dark garments	X	X	X	X	X	X	X
Down duvets	-	-	-	X	X	X	X
Outerwear	-	X	X	X	X	X	X
Proofing	-	-	-	X	-	-	-
Separate rinse	X	-	-	X	-	-	-
Starch	-	-	-	X	-	-	-
Silks (👉)	-	-	-	X	-	-	-
Sportswear	-	X	X	X	X	X	X
Down filled items	-	-	-	X	X	X	X
Curtains	X	-	-	X	X ¹⁾	X	X
First wash	-	-	-	X	-	X	X
Pillows	-	-	-	X	X	X	X
Cottons (👈)	X	X	X	X	X	X	X

X = Can be selected / - = Cannot be selected / ¹⁾ = Can be deselected

Delay start

With delay start you can choose when you want the programme to start. You can delay the start of the programme from 15 minutes up to a maximum of 24 hours, allowing you to make use of night-time economy electricity rates, for example.

To select delay start

The time of day needs to be set for delay start to work correctly.

- After selecting the programme touch the Finish at sensor.

Tip: Via Settings you can select a time for the programme to start at, instead of finish at. In this case Start at will light up in the display.

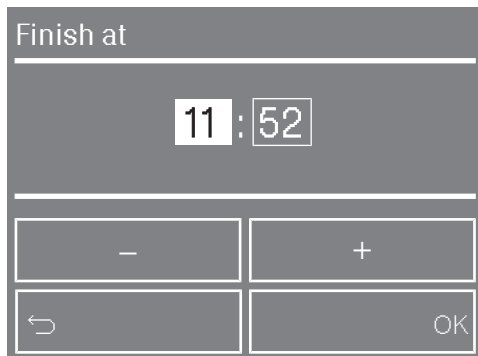

- Use the + and - sensors to set the hour and confirm with the OK sensor.

The minutes are now highlighted in white and can be set.

The minutes entry moves to 00 and can then be adjusted in 15 minute increments.

- Confirm with the OK sensor.

To begin delay start

- Touch the Start/Stop sensor to begin delay start.

The door will lock and the following will appear in the display:

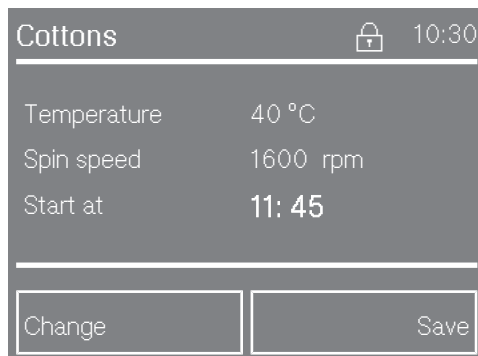

To change delay start

- Touch the Change sensor.
- Select Finish at.
- Select Change the time.
- Now set the time you want and confirm with OK.

To begin the programme straight away

- Touch the Change sensor.
- Select Finish at.
- Select Start now.

The programme will start.

To cancel delay start

- Touch the *Start/Stop* sensor.

The Selection menu will appear:

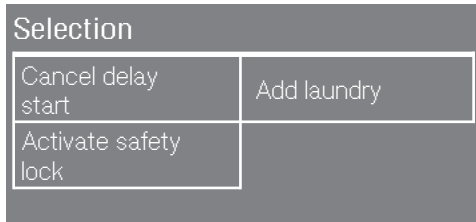

- Select Cancel delay start.

The basic programme menu will appear and the *Start/Stop* sensor will flash.

Adding or removing laundry

- Touch the *Start/Stop* sensor.
- Touch the Add laundry sensor.

The door will unlock.

- Pull open the door.
- Add laundry or remove individual items.
- Close the door.
- Touch the *Start/Stop* sensor.

Delay start will continue.

Favourite programmes

You can save your own customised wash programmes under names of your choice.

The saved favourite programmes will be sorted alphabetically.

To create a favourite programme

There are two ways of creating a favourite programme.

Option 1

- With the main menu showing in the display, touch the **Favourite programmes** sensor.

The display will change to show the **Favourites** menu **Favourite programmes**.

- Touch the **Create** sensor.

The **Create** sensor will not appear if the maximum number of 10 favourite programmes has already been reached.

The display will change to show the **Select a programme** menu.

- Select the programme you want.

The display will guide you automatically through all the further programme settings.

A summary of the selected parameters will then appear in the display.

Tip: If a parameter is not correct it can be changed. Touch the **↔** sensor repeatedly until the programme setting you want appears in the display and then change it.

When all the parameters are correct:

- Select **OK**.

Option 2

You can save a programme which has been selected and started as a **Favourite** programme.

- After the programme has started successfully, touch the **Save** sensor.
- Enter a name.

Entering names/saving favourite programmes

You can enter a name of up to 10 characters.

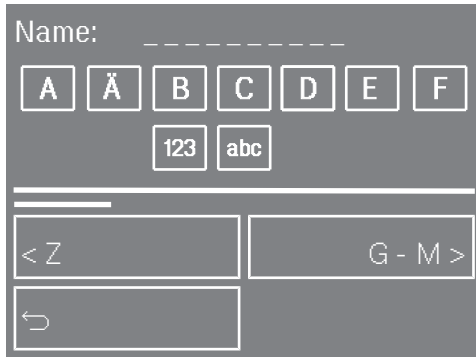

- Touch the sensor of the first letter of the word you want to enter.
- Add the next characters in exactly the same way.

By selecting one of the following symbols you can select upper or lower case and also delete or change characters:

- _ = enter a space
- 123 = enter a number
- abc/ABC = enter letters as lower/upper case
- ☒ = delete all characters
- ↶ = delete the last character
- Finally confirm *Save*.

The programme will be saved as a favourite.

To change a favourite programme

You can change a saved favourite programme and then save it again under the same or a different name.

- Select *Favourite programmes* from the main menu.
- Select the *Change sensor*.
- Select the favourite programme you want to change.
- Select the same programme in order to change a few programme settings or select a new programme.

The display will guide you through all the further programme settings.

To delete a favourite programme

If you have already saved ten favourite programmes, you will need to delete one of these before you can save a new one.

- Select *Favourite programmes* from the main menu.
- Select the *Delete sensor*.
- Select the favourite programme you want to delete.
- Confirm with the *Delete sensor* and then with the *OK sensor*.

The favourite programme is now deleted.

Washing assistant

The Washing assistant guides you step by step so that you can select the optimum wash programme for your laundry.

- Touch the Washing assistant sensor in the main menu.

The display will show a list of types of textile.

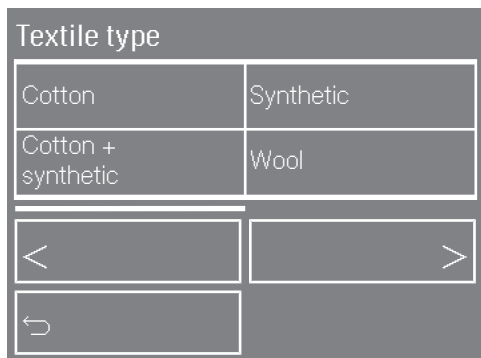

- Touch the sensor for the textile type which matches your laundry.

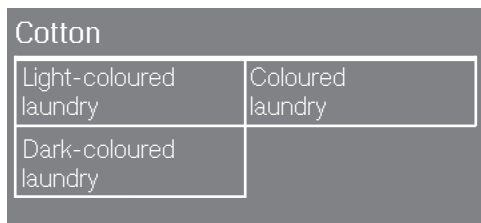

- Select the colour of the items.

Cotton



- Select the degree of soiling of the items.

Cotton



- Select how you want the items to be spun.

A summary of the selected parameters will then appear in the display.

- Confirm with the OK sensor.

The programme which has been tailored to your laundry is ready to start.

Tip: You can add individual programme settings, e.g. TwinDos before you start the programme.

Use this programme if you do not have enough laundry to run a standard programme but you want to wash a few lightly soiled items with different garment care instructions.

The washing machine will use the list of items to put together a suitable wash programme.

Selecting items

- Touch the **Mixed items** sensor in the main menu.

A list of items will appear.

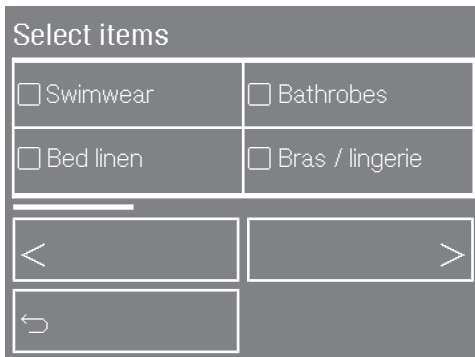

- Touch the appropriate sensor for your item of laundry.

The item selected will be marked with ✓. You can select several items.

- Confirm with the OK sensor.

Information regarding the programme may appear in the display, e.g. use of detergent.

- Confirm the information with OK.

The washing machine has put together the optimum programme for these items.

Tip: You can add individual programme settings, e.g. **TwinDos** before you start the programme.

The list of items selected will be deleted at the end of the programme and you will need to select a new list the next time you use this programme.

Changing / deleting / displaying the list of items selected

The **Item** sensor will show how many articles have been selected.

By touching the **Item** sensor you can display the items again, delete or change them.

Changing an item

- Confirm an item which you have already selected in order to deselect it.

The tick ✓ will go out.

- Select more items.
- Confirm with the OK sensor.
- You can also change other programme settings, e.g. temperature, spin speed or delay start.

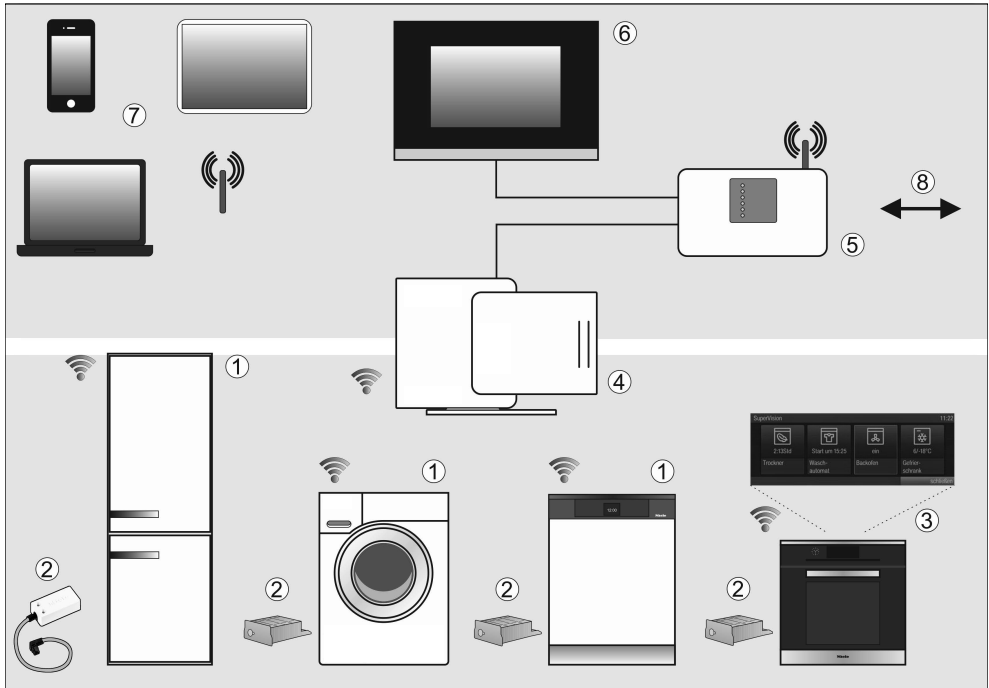

- ① Miele@home communication enabled appliance
- ② Miele@home communication stick XKS3000Z or communication module XKM3000Z
- ③ Miele@home communication enabled Master appliance with SuperVision functionality
- ④ Miele@home Gateway XGW3000
- ⑤ WiFi router
- ⑥ Connection to a Home automation system
- ⑦ Smartphone, Tablet PC, Laptop
- ⑧ Internet connection

Please note that the Miele@home and SuperVision system is currently only available in selected countries.

This appliance ①/③ is network enabled and can be connected to the Miele@home system via a communication module or communication stick ② and a conversion kit where required.

The Miele@home system enables network enabled appliances to send information via the household wiring network to a master appliance ③ such as an oven with SuperVision functionality, about their operational status, as well as information about the progress of the programme.

Displaying information and controlling appliances

- SuperVision master appliance ③
The status of other signed on appliances can be shown in the display of some network enabled appliances.
- Mobile device ⑦
A PC, Notebook, Tablet PC or a Smartphone can be used within the reception area of a household WLAN ⑤ to display status information about signed on appliances and carry out certain functions.
- Household network ⑥
The Miele@home system enables smart living. The Miele@home Gateway ④ allows other network enabled appliances to integrate into the household bus system.

- In Germany, network enabled appliances can be integrated into the QIVICON Smart Home Platform instead of the Miele@home Gateway (www.qivicon.de).

SmartStart (depending on household appliance)

Smart grid enabled appliances can be started automatically at a time when electricity costs are favourable or when a favourable supply of electricity is available (e.g. from a solar power system).

Optional accessories (depending on household appliance)

- Communication module XKM3000Z or communication stick XKS3000Z
- Conversion kit for communication system XKV
- Miele@home Gateway XGW3000

These accessories are supplied with their own installation and operating instructions.

Further information

Further information regarding Miele@home is available on the internet and in the instruction manuals of the various Miele@home components.

Detergent

The correct detergent

All detergents produced for automatic washing machines are suitable. Follow the manufacturer's instructions and dosage recommendations on the packaging.

The right amount to dispense will depend on the following:

- the soiling level of the load
- the quantity of the laundry
- the water hardness level.
Check with your local water supplier if you do not know the hardness level in your area.

Water softeners

A water softener can be used to cut down on the use of detergents in areas with water hardness levels II and III. Dispense according to the amount specified on the packaging. First add detergent and then the water softener.

You can then use the recommended amount of detergent for water hardness level I.

Water hardness levels

Hardness scale	Hardness level in mmol/l	German scale °d
I (soft)	0 – 1.5	0 – 8.4
II (medium)	1.5 – 2.5	8.4 – 14
III (hard)	above 2.5	above 14

Dispensing aids

Use dispensing aids, (e.g. balls) if these are supplied with the detergent, particularly when using liquid detergent.

Refill packs of detergent

When purchasing detergent buy refill packs wherever possible. This helps reduce the amount of waste packaging.







Fabric conditioner and liquid starch

Fabric conditioner makes garments soft to handle and helps prevent static cling when tumble drying.

Starch stiffens and gives body to items of laundry, e.g. shirts, tablecloths and bed linen.

Miele recommended detergents

Miele detergents and care products have been specially designed for Miele washing machines. They are available to order via the internet at www.miele-shop.com or from Miele.

	Miele UltraPhase 1 / 2	Miele Cap 	Miele Cap 	Miele Cap 
Cottons	✓	–	(F)	(H)
Minimum iron	✓	–	(F)	(H)
Delicates	✓	–	(F)	–
Woolens 	–	(D)	–	–
Denim	✓	–	(F)	–
Shirts	✓	–	(F)	(H)
Express 20	✓	–	(F)	–
QuickPower wash	✓	–	–	–
Automatic plus	✓	–	(F)	(H)
Dark garments	✓	–	(F)	–
Down duvets	–	(B)	–	–
Outerwear	–	(C)	–	–
Proofing	–	–	(G)	–
Silks 	–	(E)	–	–
Sportswear	–	(A)	–	–
Down filled items	–	(B)	–	–
Curtains	✓	–	–	(H)
First wash	✓	–	(F)	–
Pillows	✓	–	–	–
Cottons 	✓	–	(F)	(H)
Mixed items	✓	–	(F)	–

✓ Recommended

– Not recommended

(A) Sport

(B) Down

(C) Outdoor

(D) WoolCare

(E) SilkCare

(F) Fabric conditioner

(G) Reproofing

(H) Booster

Detergent

Recommended detergents in accordance with Directive (EU) Nr. 1015/2010

The recommendations apply to the temperature ranges given in the Programme chart.

	Universal	Coloureds	Delicates and woollens	Specialist
	detergent			
Cottons	✓	✓	-	-
Minimum iron	-	✓	-	-
Delicates	-	-	✓	-
Woollens (👕)	-	-	✓	✓
Denim	-	✓ ¹⁾	-	✓
Shirts	✓	✓	-	-
Express 20	-	✓ ¹⁾	-	-
QuickPower wash	✓	✓	-	-
Automatic plus	-	✓	-	-
Dark garments	-	✓ ¹⁾	-	✓
Down duvets	-	-	✓	✓
Outerwear	-	-	✓	✓
Silks (👗)	-	-	✓	✓
Sportswear	-	-	✓	✓
Down filled items	-	-	✓ ¹⁾	✓
Curtains	✓ ²⁾	-	-	✓
First wash	-	✓	-	-
Pillows	-	-	✓ ¹⁾	✓
Cottons (👕)	✓	✓	-	-
Mixed items	depending on the items selected - observe the information in the display			

✓ Recommended

- Not recommended

1) Liquid detergent

2) Powder detergent

Fabric conditioner and liquid starch at the end of the programme

You can dispense fabric conditioner either by using automatic dispensing or via the detergent dispenser compartment.

Automatic dispensing

One of the automatic dispensing containers must be filled with fabric conditioner.

- Select the programme required.
- Select TwinDos.
- Select the degree of soiling level of the load.

The display will change to show the Select agent menu.

- Make sure that *Fabric conditioner* is marked and confirm selection with the OK sensor.

Fabric conditioner will be dispensed in the last rinse.

Manual dispensing

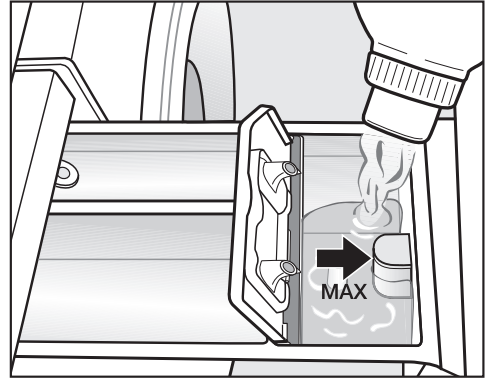



- Add the fabric conditioner or liquid starch to the ☼ compartment or insert the appropriate capsule. **Do not exceed the maximum level mark.**

The agent will be automatically dispensed in the last rinse. At the end of the programme a small amount of water will remain in the ☼ compartment.



If starching frequently, thoroughly clean the dispenser compartment, especially the siphon tube regularly.

Detergent

Adding fabric conditioner separately

- Add fabric conditioner to the  compartment or insert the appropriate capsule.
- Select the *Separate rinse* programme.
- Change the spin speed if necessary.
- If using a capsule, activate the *Cap-Dosing* sensor and select  *Cap*.
- Touch the *Start/Stop* sensor.

Adding starch separately

- Add liquid starch to the  compartment and powder or viscous starch to the  compartment.
- Select the *Starch* programme.
- Change the spin speed if necessary.
- Touch the *Start/Stop* sensor.

Colour run and dye removers/dyes

 **Do not use** colour run or dye removers in this washing machine. They can cause corrosion in the machine.

Dyes suitable for use in domestic washing machines can be used. However, please note that the salt used in the dyeing process can cause corrosion to stainless steel components in the machine if you dye frequently. Always observe the manufacturer's instructions carefully.

 When using the washing machine to dye fabric it is essential to select the *Water plus* option.

Cleaning the drum (Hygiene info)

Washing at low temperatures and/or using liquid detergent can cause bacteria and unpleasant odours to build up in the washing machine. Use the Maintenance wash programme to clean the machine. Run this programme regularly or at the latest when Hygiene info: Start a programme with a minimum temperature of 75°C. appears the display.

External casing and fascia panel

⚠ Disconnect the machine from the mains electricity supply before cleaning or maintenance.

⚠ The washing machine must not be hosed down.

- Clean the casing and fascia panel with a mild non-abrasive cleaning agent or soap and water using a well wrung-out cloth. Wipe dry with a soft cloth.
- The drum can be cleaned with a proprietary stainless steel cleaning agent, following the manufacturer's instructions on the packaging.

⚠ Do not use solvents, abrasive cleaners, glass cleaners or multi-purpose cleaning agents. These could damage plastic surfaces and other parts.

Cleaning the detergent dispenser drawer

Washing at low temperatures and the use of liquid detergent can lead to a build-up of mould and bacteria in the detergent dispenser drawer.

- Clean the entire drawer at regular intervals for hygiene reasons, even if you are using the TwinDos system exclusively.

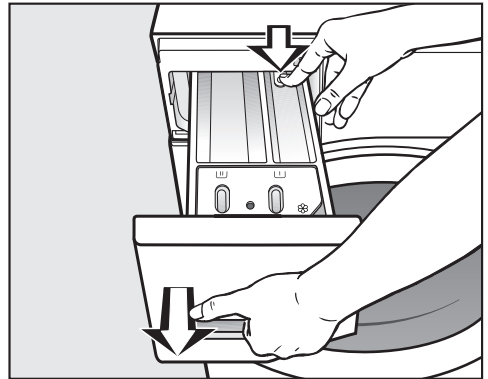

- Pull out the detergent dispenser drawer until a resistance is felt. Press down the release button and at the same time pull the drawer right out of the machine.
- Clean the drawer with hot water.

Cleaning and care

Cleaning the siphon tube and the channel

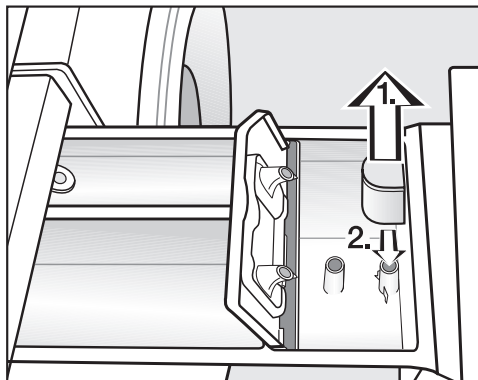

■ Clean the siphon.

1. Remove the siphon from the ☒ compartment and rinse under hot running water. Clean the siphon tube at the same time.
2. Replace the siphon.

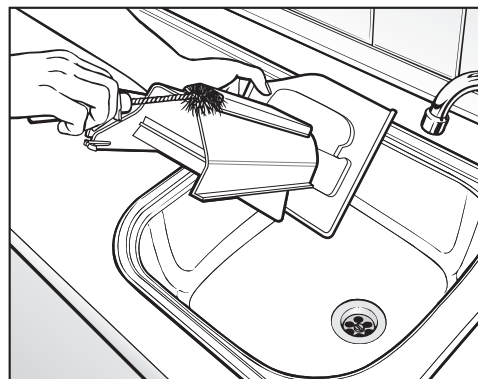

■ Clean the fabric conditioner channel with a brush and hot water.

Liquid starch can cause the siphon to become clogged. Make sure that you clean the siphon and siphon tube particularly thoroughly after using liquid starch a few times.

Cleaning the detergent dispenser drawer housing

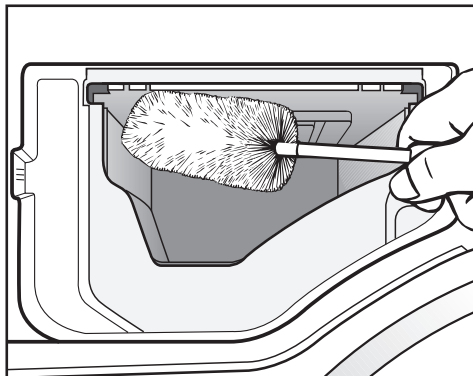

■ Use a bottle brush to remove detergent residues and limescale from the jets inside the detergent dispenser drawer housing.

Cleaning the TwinDos system

The washing machine has a cleaning programme for cleaning the TwinDos system containers and the hoses inside the washing machine.

Miele 2 Phase System cartridges do not need to be cleaned.

Cleaning the containers and hoses

Clean the container or containers and hoses every time you change brand of liquid detergent or fabric conditioner or if the system has not been used for a long period of time (more than three months).

If the system has not been used for a long time the detergent in the hoses can become viscous.

The hoses could become blocked and would then need to be cleaned by a service technician.

- Switch on the washing machine.
- Touch the > sensor to scroll to the second page of the main menu.
- Touch the Settings  sensor.

The display will change to show the Settings menu.

- Select the TwinDos setting.
- Select the Maintenance option.

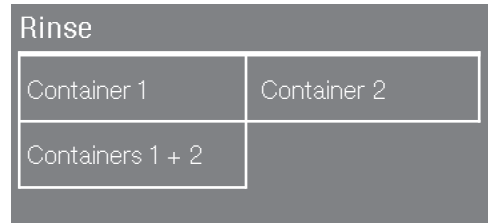

- Touch the sensors to clean the containers.
- Follow the instructions in the display.

After cleaning you can fill one or both containers with new liquid detergent and/or fabric conditioner.

Cleaning the compartments

Detergent residue can cause clogging.

- Use a damp cloth to clean the compartment interior when you change the cartridge or container.

Cleaning and care

Cleaning the water inlet filter

The washing machine has a filter to protect the water inlet valve. The accessible filter in the union at the open end of the inlet hose should be checked every six months or so, or more often if there are frequent interruptions to the water supply.

- First turn off the stopcock.
- Unscrew the inlet hose from the stopcock.

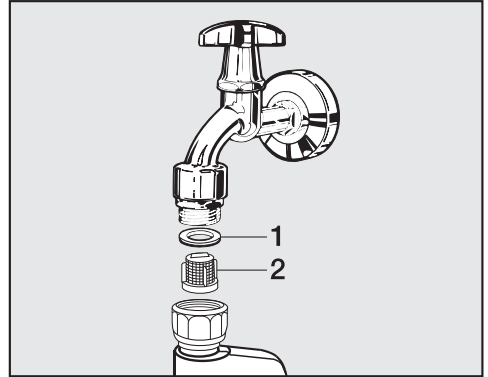

- Remove the rubber seal **1** from the recess.
- Using pointed pliers, take hold of the plastic filter bar **2** and remove it. Clean the plastic filter.
- Put the filter and seal back in the reverse order and reconnect the hose.

Turn on the stopcock and check the connection is watertight. If water drips out, tighten the connection.

The filter **must** be put back in place after cleaning.



Problem solving guide

Minor faults in the performance of the washing machine, some of which may result from incorrect operation, can be put right without contacting the Service Department.

The following guide may help you to find the reason for a fault, and to correct it. You should, however, note the following:





 Repair work to electrical appliances should only be carried out by a suitably qualified person in strict accordance with current local and national safety regulations. Repairs and other work by unqualified persons could be dangerous. The manufacturer cannot be held liable for unauthorised work.

The programme does not start

Problem	Cause and remedy
The display remains dark, and the Start/Stop button indicator light does not come on.	There is no power to the machine. <ul style="list-style-type: none">■ Check whether the mains plug is plugged in and switched on.■ Check whether the fuse or circuit breaker has tripped.
	The washing machine has switched off automatically to save energy. <ul style="list-style-type: none">■ Switch it back on with the  button.
The display prompts you to enter a code.	Access via a code has been activated. <ul style="list-style-type: none">■ Enter the code and confirm the entry. Deactivate the code if you do not wish this message to appear in the display the next time the machine is switched on.
The following appears in the display:  Door lock	The door is not closed properly. The door lock could not engage. <ul style="list-style-type: none">■ Close the door again.■ Start the programme again. If the fault message appears again, contact the Service Department.

Problem solving guide

The following fault messages appear in the display and the programme stops

Problem	Cause and remedy
 Drainage fault	The water outlet is blocked or restricted. The drain hose has been fixed too high. <ul style="list-style-type: none">■ Clean the drain filters and the drain pumps.■ The maximum delivery head is 1.8 m.
 Water intake fault	The water inlet is blocked or restricted. <ul style="list-style-type: none">■ Check whether the stopcock is opened properly.■ Check whether the inlet hose is kinked.■ Check whether the water pressure is too low.
	The filter in the water inlet is blocked. <ul style="list-style-type: none">■ Clean the filter.
 Technical fault F	There is a fault. <ul style="list-style-type: none">■ Start the programme again. If the fault message appears again, contact the Service Department.
 Waterproof system reacted	The water protection system has reacted. <ul style="list-style-type: none">■ Close the stopcock.■ Call the Service Department.

To switch off the fault messages: Switch the washing machine off with the  button.

The following fault messages appear in the display at the end of the programme

Problem	Cause and remedy
<p>i Check dosage</p>	<p>Excessive foam has built up during washing.</p> <ul style="list-style-type: none"> ■ Check the amount of detergent dispensed. ■ With automatic detergent dispensing check the dosage amount set. ■ Observe the instructions on the detergent packaging and the degree of soiling of the laundry. ■ If necessary, reduce the dosage amount by increments of 10%.
<p>i Hygiene info: Start a programme with a minimum temperature of 75°C.</p>	<p>A programme using a temperature above 60°C has not been run for a long time.</p> <ul style="list-style-type: none"> ■ In order to prevent bacteria and unpleasant odours building up in the machine, run the <i>Maintenance wash</i> programme using Miele machine cleaner or powder detergent.
<p>The display prompts you to refill one or both detergent containers.</p>	<p>The TwinDos container (or containers) is empty.</p> <ul style="list-style-type: none"> ■ Fill the container or containers with liquid detergent or fabric conditioner or replace the cartridge(s). ■ Check if the laundry is clean. There may not have been enough detergent. If necessary, wash the items again.

The messages will appear at the end of the programme and when the washing machine is switched on and need to be confirmed with the OK sensor.

Problem solving guide

The following fault messages appear in the display at the end of the programme

Problem	Cause and remedy
<p>i Intensive flow: Clean the filter and jets or remove foreign objects from the pump housing.</p>	<p>The pumps are dirty.</p> <ul style="list-style-type: none">■ Clean the pumps as described in "Problem solving guide - Opening the door in the event of a blocked drain outlet and/or power failure".■ Start the programme again after cleaning the pumps.
	<p>The jet in the top of the door ring is blocked with fluff.</p> <ul style="list-style-type: none">■ Remove the fluff with your finger. Do not use any sharp or pointed tools to do this.■ Start the programme again after cleaning the jet.
	<p>If the fault message appears again, contact the Service Department. The washing machine can still be used but with reduced functionality.</p>
<p>i Align the washing machine</p>	<p>The smoothing process which the laundry undergoes at the end of the programme could not be carried out properly.</p> <ul style="list-style-type: none">■ Check whether the washing machine is aligned correctly as described in "Installation and connection - Levelling the machine".■ Check whether the maximum delivery height has been exceeded.
	<p>If the fault message appears again, contact the Service Department. The washing machine can still be used but with reduced functionality.</p>

The messages will appear at the end of the programme and when the washing machine is switched on and need to be confirmed with the OK sensor.

Problems with TwinDos

Problem	Cause and remedy
There are dark specks in the liquid detergent.	Mould has developed in the detergent. ■ Pour the liquid detergent out of the container and then clean the container thoroughly.
No detergent and/or fabric conditioner was dispensed.	Automatic dispensing has not been activated. ■ Touch the TwinDos sensor before running the next programme. Automatic dispensing will be activated.
	No detergent/fabric conditioner was dispensed even although automatic dispensing was activated. ■ Try again. ■ If detergent is still not dispensed, call the Service Department.

Problem solving guide

General problems with the washing machine

Problem	Cause and remedy
The machine shakes during the spin cycle.	The machine feet are not level. ■ Level the machine and adjust the feet correctly.
The laundry has not been spun properly and is still wet.	The machine detected an imbalance during the final spin cycle and reduced the spin speed automatically. ■ Include both large and small items in the load as this will give better distribution during spinning.
Strange pump noises can be heard.	This is not a fault. These slurping noises occur at the end of the pump sequence as a normal part of operation.
Large amounts of detergent residue remain in the detergent dispenser drawer.	The water pressure is too low. ■ Clean the water inlet filter. ■ It may be useful to select the <i>Water plus</i> option.
	Powder detergent used in conjunction with water softeners tends to become sticky. ■ In future, add washing powder into the dispenser drawer first, and then add the water softener.
Fabric conditioner is not completely dispensed or too much water remains in the compartment. ☼	The siphon tube is not correctly positioned or is clogged. ■ Clean the siphon, see "Cleaning and care - Cleaning the detergent dispenser drawer".
The display is in a different language.	A different language has been selected in "Settings, Language" 🚩. ■ Set the language you want. The flag symbol will guide you.
Noises while steam is being generated.	This is not a fault. These noises occur when steam is being generated and when steam is being injected into the drum.

General problems with the washing machine

Problem	Cause and remedy
At the end of the programme there is still liquid in the capsule.	The small pipe in the detergent dispenser drawer onto which the capsule is placed is blocked. <ul style="list-style-type: none"> ■ Clean the small pipe.
	This is not a fault. For technical reasons a small amount of water will remain in the capsule.
There is water next to the capsule in the fabric conditioner compartment.	The CapDosing sensor was not activated or an empty capsule was not removed at the end of the last programme. <ul style="list-style-type: none"> ■ Make sure that you remember to activate the CapDosing sensor the next time you insert a capsule. ■ Remove and then dispose of the empty capsule at the end of each programme.
	The small pipe in the detergent dispenser drawer onto which the capsule is placed is blocked. <ul style="list-style-type: none"> ■ Clean the small pipe.
Steam comes out of the detergent dispenser drawer while steam is being generated.	This is not a fault. Steam may emerge from the detergent dispenser drawer, depending on the amount of laundry and the ambient temperature.
The display is dark.	The display has switched off automatically to save energy (Standby mode). <ul style="list-style-type: none"> ■ Press a button. Standby comes to an end.
When the drum is empty a load appears in the display or when the drum is full the load is displayed as <25%.	There was laundry in the drum when the washing machine was switched on. This decalibrated the load sensor from the zero setting. <ul style="list-style-type: none"> ■ Empty the drum and switch the washing machine off and back on again.

Problem solving guide

An unsatisfactory wash result

Problem	Cause and remedy
Liquid detergent does not give the required result.	<p>Liquid detergents usually contain no bleaching agents. They do not remove fruit, coffee and tea stains.</p> <ul style="list-style-type: none">■ Use the Miele 2 Phase System. The targeted addition of UltraPhase 2 during the wash process removes stains effectively.■ Use a general purpose powder detergent containing a bleaching agent.
White residues which look like powder detergent are seen on dark textiles after washing.	<p>The detergent contained compounds (zeolites) to aid water softening which are not soluble in water. These have ended up on the laundry.</p> <ul style="list-style-type: none">■ Try and brush off the residues with a soft brush once the laundry is dry.■ Wash dark textiles using a detergent which contains no zeolites. Liquid detergents usually contain no zeolites.■ Use the <i>Dark garments</i> programme.
Grey, greasy particles cling to washed laundry.	<p>Insufficient amounts of detergent were used to break down the particles of grease in heavily soiled laundry.</p> <ul style="list-style-type: none">■ Use more detergent.■ Before washing the next load, run the <i>Maintenance wash</i> using Miele machine cleaner or a powder detergent.

The door will not open

Problem	Cause and remedy
<p>The door cannot be pulled open during a programme.</p>	<p>The drum is locked during a programme.</p> <ul style="list-style-type: none"> ■ Touch the <i>Start/Stop</i> sensor. ■ Select the <i>Cancel programme</i> or <i>Add laundry</i> sensor. <p>The door will unlock and you will be able to pull it open.</p> <hr/> <p>There is still water in the drum and the machine is unable to drain.</p> <ul style="list-style-type: none"> ■ Clean the drain filters and the drain pumps as described in "Opening the door in the event of a blocked drain outlet and/or power failure". <hr/> <p>The water level in the drum is too high.</p> <ul style="list-style-type: none"> ■ Cancel the programme. The water will be pumped away.
<p>Comfort cooling appears in the display after a programme has been cancelled.</p>	<p>For safety reasons the drum door cannot be opened if the suds temperature is higher than 55°C.</p> <ul style="list-style-type: none"> ■ Wait until the temperature in the drum has decreased and the message has gone out in the display.
<p>The door will not open after the <i>Steam care</i> or <i>Freshen up</i> programme has finished.</p>	<p>The <i>Steam care</i> or <i>Freshen up</i> programme has been started several times one after the other. The steam has caused the temperature in the drum to rise above 55°C and the door is locked to prevent the risk of burning.</p> <ul style="list-style-type: none"> ■ Wait a few minutes until the temperature in the drum has decreased.
<p>The following appears in the display:  Door lock faulty. Call Service.</p>	<p>The door lock has jammed.</p> <ul style="list-style-type: none"> ■ Call the Service Department.

Problem solving guide

Opening the door in the event of a blocked drain outlet and/or power failure

- Switch off the washing machine.

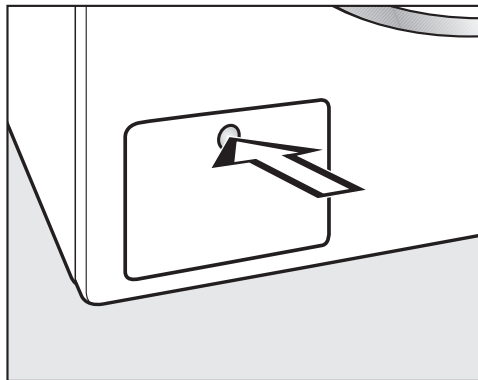

- Press the drain pump access panel.

The panel will spring open.

Blocked drain outlet

If the drain outlet is blocked, a large quantity of water can remain in the washing machine.

 **Caution:** If laundry has been washed at a high temperature, water draining out of the machine will still be hot. Danger of scalding!

Procedure for draining the washing machine

When draining water from the machine, do not unscrew the drain filters completely or take them right out.

- Place a suitable container, e.g. a Miele universal oven tray under the access panel.

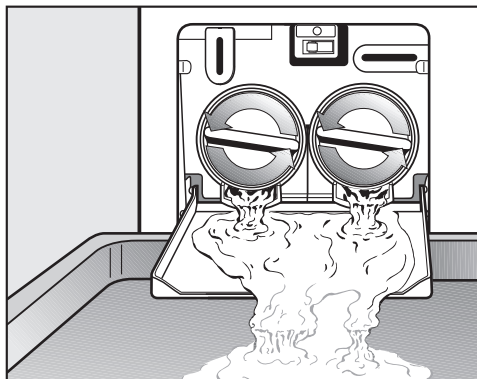

- Slowly and carefully unscrew the filters to let the water out. Be careful not to release too much water at once. If the flow of water is too strong, some water can seep into the washing machine base and activate the water protection float switch. This will prevent the washing machine from functioning.
- Tighten the drain filters back up again if you need to interrupt the flow of water.

Once the flow of water ceases:

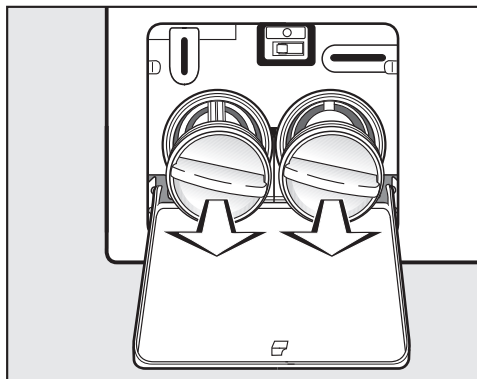

- Remove the drain filters completely.

Problem solving guide

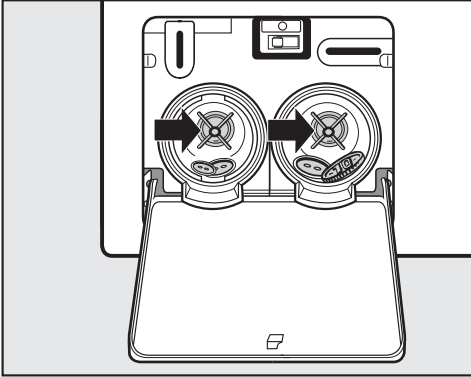

- Clean them thoroughly.
- Remove any foreign objects (e.g. buttons, coins, etc.) and fluff from the filter housing. Turn the impellers by hand to check that they rotate freely.

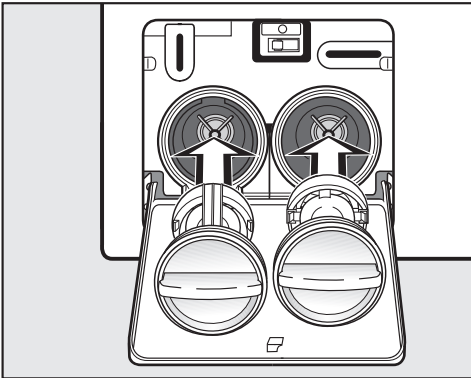

- Replace the drain filters correctly (on the right and left) and tighten them securely.

⚠ Make sure the drain filters are securely tightened. Otherwise there is a risk of water leakage during use.

Opening the door

⚠ Always make sure that the drum is stationary before reaching in to remove laundry. Reaching into a moving drum is extremely dangerous.

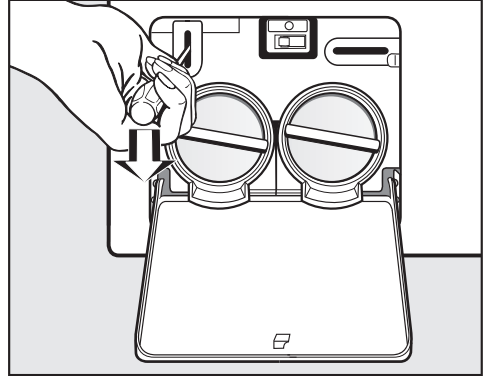

- Use a screwdriver to unlock the door.
- Pull open the door.

After sales service

Repairs

In the event of any faults which you cannot remedy yourself, please contact:

- your Miele Dealer, or
- Miele (Contact details for Miele are given at the end of this booklet).

When contacting your Dealer or Miele, please quote the model and serial number of your machine, both of which are shown on the data plate visible above the porthole glass when the door is open.

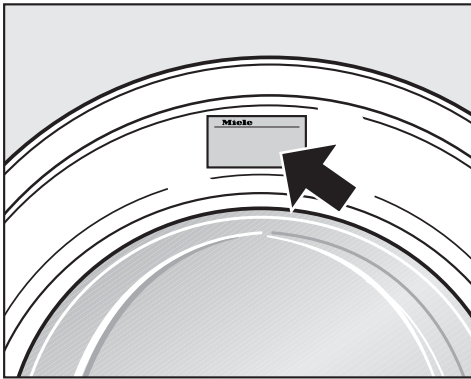

N.B. A call-out charge will be applied for service visits where the problem could have been resolved as described in these instructions.

Guarantee: U.K.

In the U.K, the washing machine is guaranteed for 2 years from the date of purchase.

In the U.K. you must activate your cover by calling 0330 160 6640 or registering online at www.miele.co.uk.

Guarantee: Other countries

For information on the appliance guarantee specific to your country please contact Miele. See end of this booklet for contact details.

Optional accessories

Optional spare parts and accessories for this washing machine are available from your Miele Dealer, the Miele Spare Parts Department or via the internet at www.miele-shop.com.

Please note that telephone calls may be monitored and recorded for training purposes.

Front view

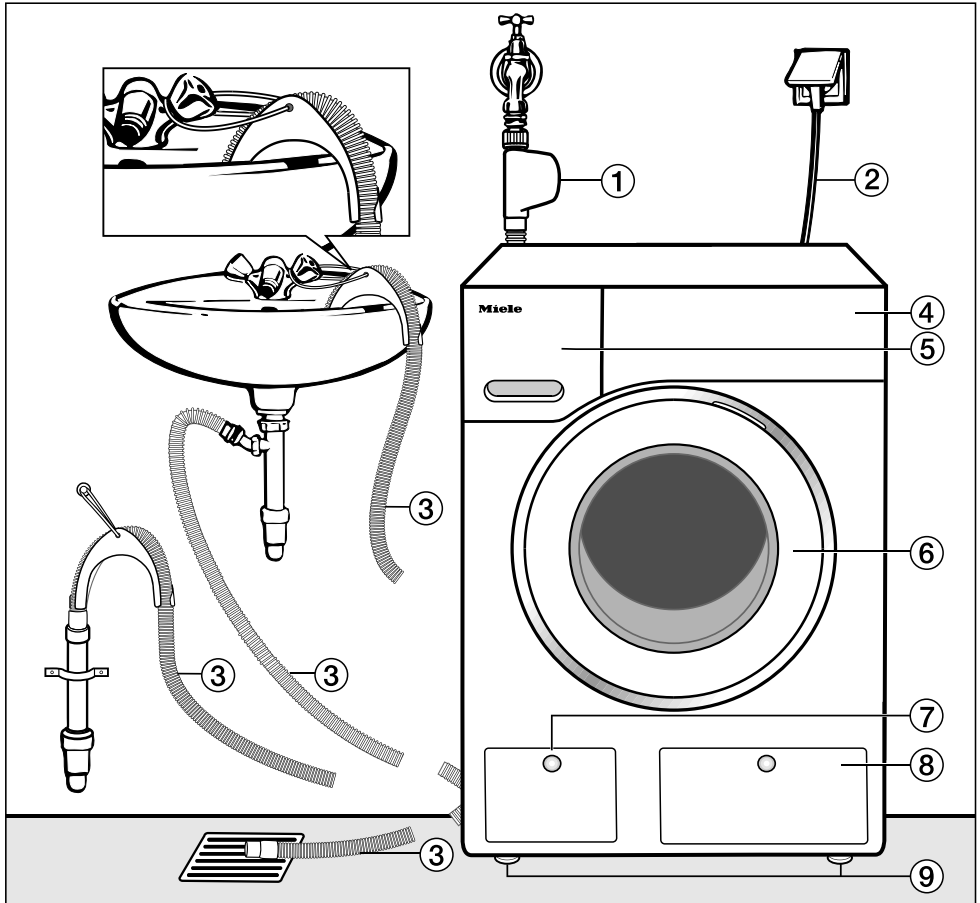

- ① Inlet hose with Waterproof system
- ② Electrical supply cable
- ③ Flexible drain hose (with detachable swivel elbow)
- ④ Control panel
- ⑤ Detergent dispenser drawer
- ⑥ Door
- ⑦ Access to drain filter, drain pump and emergency release
- ⑧ Access panel for TwinDos containers
- ⑨ Four height adjustable feet

Installation and connection

Rear view

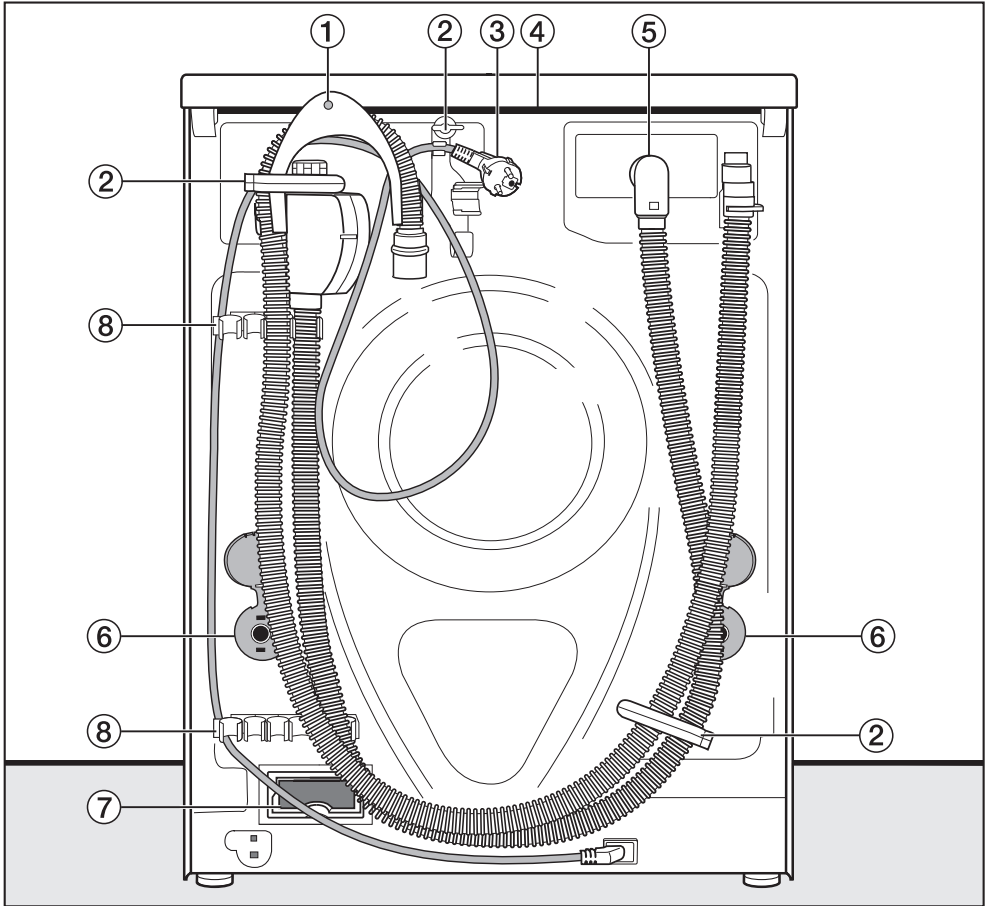

- ① Drain hose
- ② Transport clips for electrical supply cable, inlet and drain hoses
- ③ Electrical supply cable
- ④ Protruding lid for holding when moving the machine
- ⑤ Inlet hose with Waterproof system
- ⑥ Safety caps for transit bars
- ⑦ Miele@home communication module slot
- ⑧ Transport clips for inlet and drain hoses and for storing transit bars when not in use

Installation surface

A concrete floor is the most suitable installation surface for a washing machine, being far less prone to vibration during the spin cycle than wooden floorboards or a carpeted surface.

Please note:

- The machine must be level and securely positioned.
- To avoid vibrations during spinning, the machine should not be installed on soft floor coverings.

If installing on a wooden joist floor:

- We recommend a plywood base at least 59 x 52 x 3 cm). The base should span several joists and be bolted to the joist and not only the floorboards. Check for the presence of pipes and cables first.

Tip: If possible, install the machine in a corner, as this is usually the most stable part of the floor.

⚠ If the machine is installed on a raised plinth, it has to be secured against slippage during spinning using retaining clips (available from Miele). Otherwise there is the danger of the machine moving and falling off the plinth.

Transporting the washing machine to its installation site

To manoeuvre the washing machine out of its packing case to its installation site, hold it by the front feet as well as by the edge of the lid where it protrudes to the rear of the machine.

⚠ Ensure that the machine feet and the floor are dry to prevent the machine from slipping during the spin cycle.

Removing the transit bars

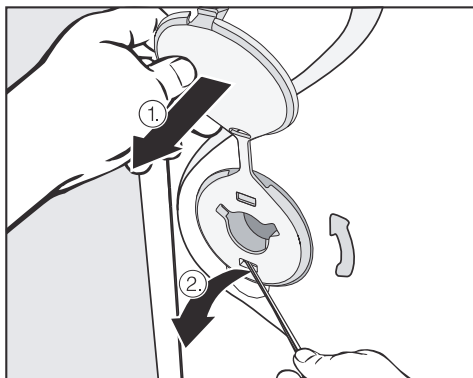

- To remove the left and right covers
 1. Pull on the attached stopper,
 2. then use a screwdriver to release the catches at the top and bottom.

Installation and connection

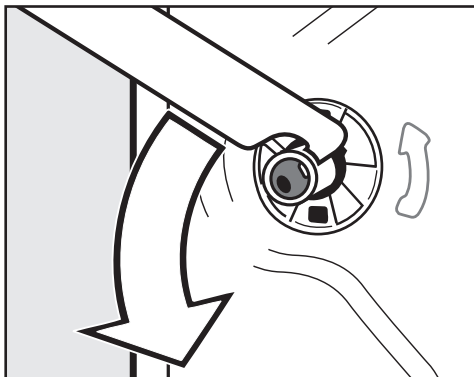

- Using the spanner supplied, turn the left-hand transit bar 90°, then

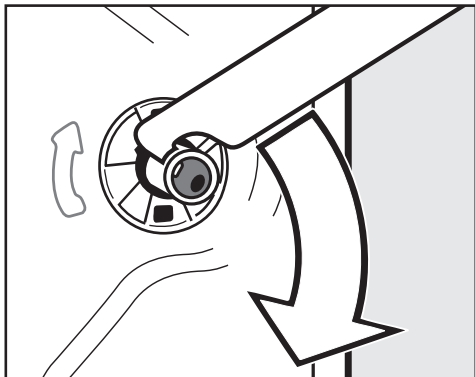

- Turn the right-hand transit bar 90°, then

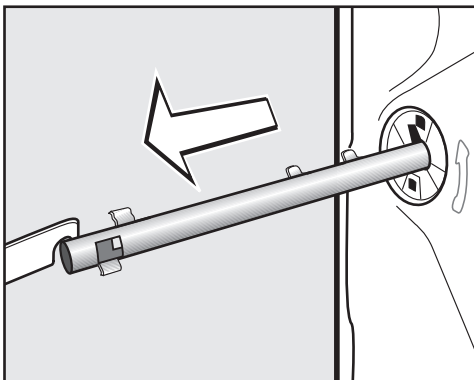

- pull the transit bar out.

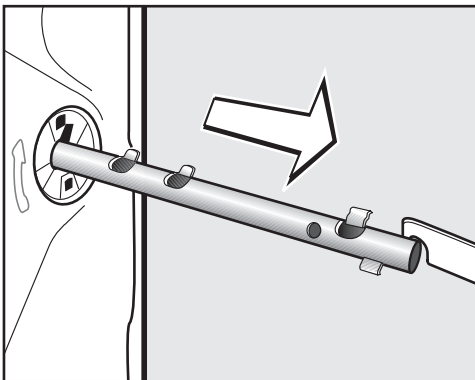

- pull the transit bar out.

Installation and connection

 To avoid the risk of injury, the holes for the transit bars must be covered after the transit bars have been removed.

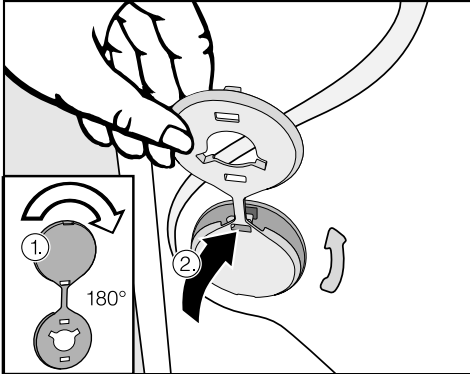

- Plug the holes with the plastic caps as illustrated.

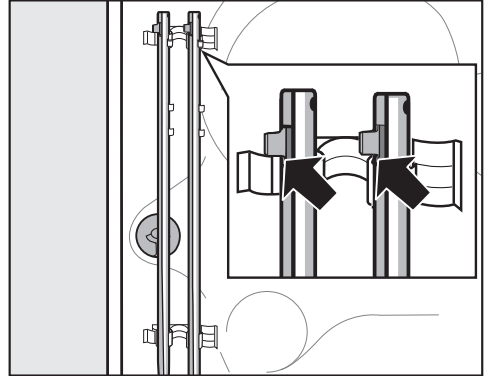

- Secure the transit bars to the back of the washing machine. Make sure the top catch is located above the holder.

 The washing machine must not be moved without the transit bars in place. Store them as shown or keep them in a safe place for future use. They must be re-fitted if the machine is to be moved again (e.g. when moving house).

Re-fitting the transit bars

Re-fitting is carried out by reversing the procedure.

Installation and connection

Levelling the machine

The washing machine must stand perfectly level on all four feet to ensure safe and proper operation.

Incorrect installation may increase electricity and water consumption and may cause the machine to move about.

Screwing out and adjusting the feet

The four adjustable screw feet are used to level the machine. All four feet are screwed in when the machine is delivered.

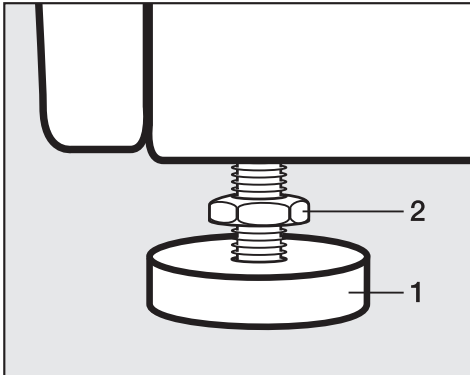

- Using the spanner supplied turn counter nut **2** in a clockwise direction. Then turn counter nut **2** together with foot **1** to unscrew.

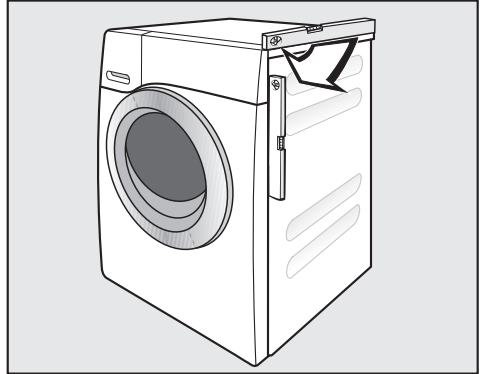

- Use a spirit level to check that the washing machine is standing level.
- Hold foot **1** securely with a pipe wrench. Turn counter nut **2** again using the spanner supplied until it sits firmly up against the housing.

 All four counternuts must be firmly up against the housing. Please also check this for the feet which did not need adjustment. Otherwise there is a danger of the machine moving about.

Building under a continuous worktop/ in a kitchen run

 The washing machine lid cannot be removed.

This washing machine (with lid intact) can be pushed under a worktop if there is space to do so.

Washer-dryer stack

The washing machine can be combined with a Miele tumble dryer in a washer-dryer stack. The appropriate "WTV" stacking kit* to match your dryer is required.

All parts marked* are available from your Dealer or Miele.

Please note:

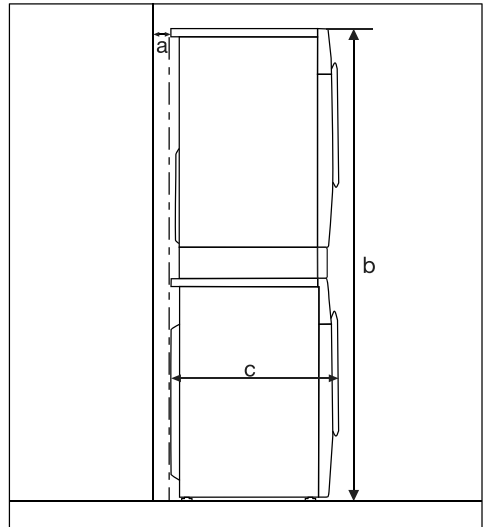

a = at least 2 cm

b = WTV without drawer: 172 cm
WTV with drawer: 181 cm

c = 65 cm

Installation and connection

The water protection system

The Miele water protection system protects all parts of the washing machine from water damage.

The system consists of three main components:

- the inlet hose
- the electronic unit and drainage and overflow protection
- the drain hose

The Waterproof System (WPS)

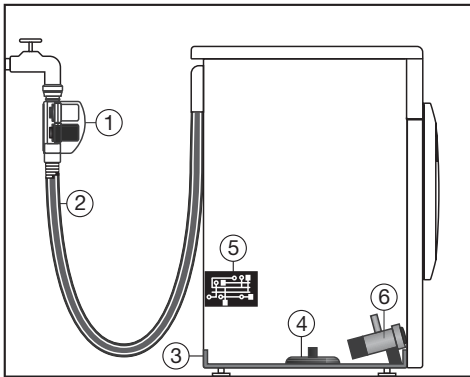

- ① Two solenoid valves
- ② Double-skinned inlet hose
- ③ Sump
- ④ Float switch
- ⑤ Electronic unit
- ⑥ Drain pump

Inlet hose

- The casing on the inlet hose contains two solenoid valves (1), which cut off the water intake directly at the stopcock. These valves provide two-fold protection. In the event that one of the valves is faulty, the other valve will cut off the water intake.

Blocking the water intake at the stopcock means that the inlet hose is only under pressure whilst water is being taken into the machine. For the remainder of the time, pressure on the inlet hose is negligible.

- Protection against the solenoid valves bursting
The solenoid valves are pressure tested to between 7,000 kPa and 10,000 kPa against bursting.
- The double-skinned inlet hose (2) has a pressure-resistant inner hose and a protective sleeve. Any leaking water is fed into the sump (3) through this protective sleeve. A float switch (4) closes the solenoid valves, preventing any more water flowing into the machine and water in the suds container is pumped away.

The electronic unit ⑤ and drainage and overflow protection

- Drainage protection
Any leaking water is collected in the sump ③ in the base of the machine. A float switch ④ closes the solenoid valves ①, preventing any more water from flowing into the machine and water in the suds container is pumped away.
- Overflow protection
If the water level exceeds a certain level, the drain pump ⑥ switches in and pumps the excess water away in a controlled manner. Should the water level rise repeatedly in an uncontrolled way, the drain pump ⑥ will switch on continuously, the washing machine will indicate that there is a fault and a tone will sound.

Drain hose

The drain hose is protected by a ventilation system which prevents the washing machine from being emptied completely.

Installation and connection

Connection to the water supply

⚠ The casing on the water inlet hose contains electrical components. It must not be connected in areas where there is the risk of water or other liquids reaching it, e.g. bathrooms.

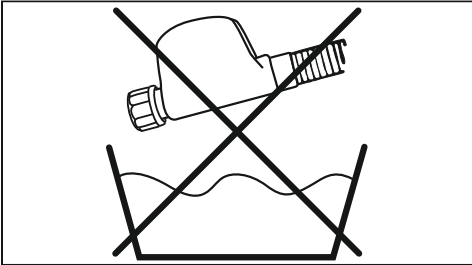

The casing on the water inlet hose must not get wet.

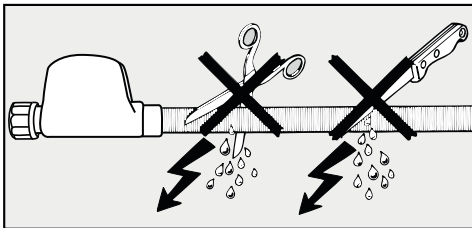

The protective sleeve of the hose must not be damaged or kinked.

The washing machine should be connected to a mains water supply in accordance with current local and national safety regulations. The German authorities do not require it to have a non-return valve as the washing machine has been designed to comply with DIN regulations.

The machine is designed to operate with a flow pressure of between 100 and 1,000 kPa. If it is higher than 1,000 kPa it is essential to fit a pressure reducing valve.

Connection to the mains water supply should incorporate a mains stopcock with a $\frac{3}{4}$ " threaded union. The stopcock should be fitted by a qualified plumber.

⚠ The connection point is subject to mains water pressure. Turn on the stopcock slowly and check for leaks. Correct the position of the washer and union if appropriate.

The washing machine is **not** suitable for connection to a hot water supply.

Maintenance

Only use a **Miele Waterproof system** hose should you need a replacement. Disconnect the machine from the electricity supply before unscrewing the waterproof system inlet hose from the stopcock.

In order to protect the water inlet valve, the dirt filter in the water inlet valve connection must not be removed.

Extension hose

A 1.5 metre long (metal) extension hose is available from your Miele dealer or the Miele Spare Parts Department as an optional extra. This hose is tested to withstand pressures of up to 14,000 kPa and can be used as a flexible extension to the water supply. N.B. Using this hose will render the Water system safety valve on the inlet hose ineffective.

Installation and connection

Connection to the drainage system

The machine drains via a drain pump with a delivery head of 1.8 m. The drain hose must not be kinked as this restricts drainage. The swivel elbow at the end of the hose can be turned in either direction, or can be detached if required, with a sharp twist and pull. The drain hose can be extended to a length of 2.5 m. The necessary parts can be purchased from your Miele Dealer or Miele.

If required, the drain hose can be extended to a length of 5 m. In this case, the delivery head must not be more than 1 m. The necessary parts can be purchased from your Miele Dealer or Miele.

Drain hose connection:

1. Direct into a sink or basin.

Please note the following:

- Hook the hose over the edge and secure.
- Make sure that the water can drain away freely without hindrance. Otherwise there is a risk of water overflowing or of some of the drained water being sucked back into the machine.

2. Connected securely to a plastic drain pipe with a rubber nipple. There is no need to use a non-return valve.

3. Connected securely to a floor gully.

4. Connected securely to a standpipe.

Please note:

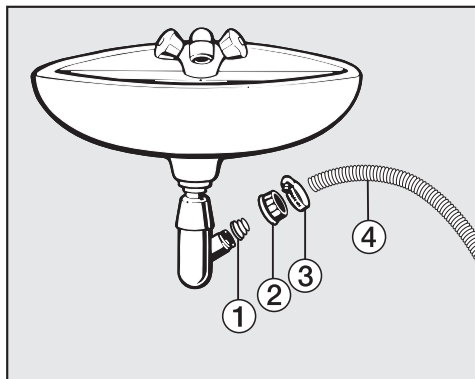

① Adapter

② Nut

③ Hose clip

④ End of the hose

■ Fit adapter ① to the sink drain outlet using nut ②.

■ Attach the end of hose ④ to adapter ①.

■ Use a screwdriver to tighten hose clip ③ up close to the nut.

Electrical connection U.K.

All electrical work should be carried out by a suitably qualified and competent person, in strict accordance with current national and local safety regulations (BS 7671 in the UK).

Ensure power is not supplied to the appliance until after installation work has been carried out.

The appliance is supplied with a mains cable with moulded plug ready for connection to a 230-240V mains supply.

Please ensure the connection data quoted on the data plate match the household mains supply.

Connection should be made via a suitable switched socket which is easily accessible after installation.

For extra safety it is advisable to protect the machine with a suitable residual current device (RCD). Contact a qualified electrician for advice.

Do not connect via an extension lead. Extension leads do not guarantee the required safety of the appliance (e.g. danger of overheating).



Non-rewireable plugs BS 1363

The fuse cover must be refitted when changing the fuse, and if the fuse cover is lost, the plug must not be used until a suitable replacement is obtained. The colour of the correct replacement cover is that of the coloured insert in the base of the plug, or the colour that is embossed in words on the base of the plug (as applicable to the design of plug fitted).

Replacement fuses should be ASTA approved to BS 1362 and have the correct rating. Replacement fuses and fuse covers may be purchased from your local electrical supplier.

WARNING: THIS APPLIANCE MUST BE EARTHED

Consumption data

		Load	Consumption data			
			Energy in kWh	Water in l	Duration	Residual moisture
Cottons	90°C	9.0 kg	2.40	65	2 h 34 min	50%
	60°C	9.0 kg	1.45	65	2 h 04 min	50%
	60°C	4.5 kg	0.90	52	2 h 04 min	50%
	40°C	9.0 kg	0.99	72	2 h 40 min	46%
	40°C	4.5 kg	0.60	52	2 h 35 min	46%
Cottons 	<60°C*	9.0 kg	0.80	54	2 h 59 min	44%
	<60°C*	4.5 kg	0.50	49	2 h 59 min	44%
	<40°C*	4.5 kg	0.35	42	2 h 59 min	44%
Minimum iron	40°C	4.0 kg	0.40	47	2 h 01 min	30%
Delicates	30°C	3.0 kg	0.40	40	1 h 09 min	–
Woollens 	30°C	2.0 kg	0.25	44	38 min	–
Shirts ²⁾	40°C	2.0 kg	0.40	35	1 h 11 min	–
Express 20 ¹⁾	40°C	3.5 kg	0.34	30	20 min	–
QuickPower wash	40°C	5.0 kg	0.90	36	59 min	–
Automatic plus	40°C	6.0 kg	0.77	55	1 h 59 min	–

1) Short option activated

2) Steam smoothing option deactivated

Note for test institutes

*Test programme in accordance with EN 60456 and energy label with Directive 1061/2010

Consumption data can vary from the nominal values given depending on water pressure, water hardness, water inlet temperature, room temperature, type and volume of load, fluctuations in the electricity supply and any options selected.

With the *PowerWash 2.0* washing technique, during the heating phase, the temperature measured by the sensor in the suds container is higher than the actual temperature of the laundry.

The temperature measured there **does not** reflect the temperature of the laundry.

The consumption data shown in the EcoFeedback display can vary from the consumption data quoted here. The variations arise from component tolerances and on-site conditions e.g. fluctuations in the pressure of the water supply, mains voltage and fluctuations in the mains voltage.

Technical data

Height	850 mm
Width	596 mm
Depth	643 mm
Depth with door open	1077 mm
Height for building under	850 mm
Width for building under	600 mm
Weight	Approx. 96 kg
Capacity	9 kg dry laundry
Voltage	See data plate
Connected load	See data plate
Fuse rating	See data plate
Consumption data	See "Consumption data"
Minimum flow pressure	100 kPa
Maximum flow pressure	1000 kPa
Inlet hose length	1.60 m
Drain hose length	1.50 m
Mains connection cable length	1.60 m
Delivery head max.	1.80 m
Maximum drainage length	5.00 m
LEDs	Class 1
Test certificates awarded	See data plate
Power consumption when switched off	0.1 W
Power consumption when not switched off	5.0 W

You can use the settings menu to alter the machine's electronics to suit changing requirements.

Settings can be altered at any time.

Opening the Settings menu

Before you begin, ensure that:

- The washing machine is switched on.
- The main menu is showing in the display.
- Touch the $\>$ sensor to scroll to the second page of the main menu.
- Touch the Settings  sensor.

The display will change to show the Settings menu.

Selecting and changing settings

- Touch the $<$ or $>$ sensor until the setting you want appears in the list of options.
- Touch the sensor to select the setting in the display.
- Change the value displayed and confirm with OK.

or

- Touch an option to select it or change the value displayed

An option which is selected will be marked with a tick \checkmark .

The option selected will be saved. The display will change to the Settings menu or back to the previous menu level.

Exiting the Settings menu

- Touch the  sensor.

The display will change to show the main menu.

Settings

Language

The display can be set to appear in one of several different languages.

The flag  after the word *Language* acts as a guide to prevent a language which will not be understood from being set.

The selected language will be stored in memory.

TwinDos

For adjusting the standard setting of the detergent dispensing unit or for activating maintenance of the containers.

Options

- Detergent / amount
For specifying the type of detergent in the containers and the dosage amount.
- Maintenance
For starting the procedure for cleaning the containers.

Please see "TwinDos" and "Cleaning and care, Cleaning the TwinDos system" for more information.

Degree of soiling

You can select the default setting for the degree of soiling or switch off the degree of soiling query.

Options

- Default setting
You can choose between the Light, Normal or Heavy degree of soiling settings.
Factory default setting: Normal.
- Query
You can switch the degree of soiling query on or off.
Factory default setting: On

Time of day

For adjusting the clock display.

Options

- Clock format
The time of day can be displayed as a 24 hour or 12 hour clock.
- Set the time of day
For setting the current time of day.

Buzzer volume

You can select one of seven different settings for the buzzer volume.

The settings are represented by a bar chart. At the lowest setting, the buzzer is switched off.

Keypad tone

Each touch of a sensor is confirmed with an audible tone.

Factory default setting: the keypad tone is switched on.

Total consumption

In this setting you can check the saved energy and water consumption values and enter the energy cost.

Options

- Display
Shows the sum of the energy and the sum of the water used by the previous programmes.
- Set the cost
You can enter the cost for energy (electricity) and water.
- Reset function
The energy consumption and water consumption totals are reset to zero.

Code

The code prevents the washing machine being used without your knowledge.

Options

- Activate
The code is 125 and can be activated.
When the code has been activated, you have to enter the code after switching the washing machine on. Otherwise the washing machine cannot be operated.
- Deactivate
For using the washing machine without entering the code. This only appears if the code has been activated previously.
- Change
You can enter a code of your own.

Important. Make a note of your new code. If you forget the code, the washing machine will need to be unlocked by Miele Service.

Temperature unit

The temperature can be displayed as degrees Celsius (°C) or Fahrenheit (°F).

Factory default setting: Celsius (°C).

Settings

Display brightness

There are seven different display brightness settings.

The brightness changes as soon as you select a different setting.

Display switch-off setting

To save energy, the display will go out and the *Start/Stop* button will flash slowly.

Options

- On
The display will go out after 10 minutes.
- On (not in current programme) (Factory default setting)
The display will remain on while the programme is running but will go out 10 minutes after the end of the programme.
- Off
The display will remain on.

Machine switch-off setting

The washing machine will switch off automatically after the end of the programme/anti-crease phase or after being switched on if no further selection is made.

Options

- 15 minutes (Factory default setting)
The washing machine will switch itself off after 15 minutes.
- 20 minutes
The washing machine will switch itself off after 20 minutes.
- 30 minutes
The washing machine will switch itself off after 30 minutes.

Display maximum load

After a programme is selected the maximum load appears in the display for a short time. You can switch this off.

Factory default setting: *Display maximum load* is switched on.

Memory

The washing machine will save the settings (temperature, spin speed and some of the options) which have been selected for a programme after the programme has started.

When this programme is chosen again, these saved settings will appear in the display.

Factory default setting: the Memory function is switched off.

Longer pre-wash Cottons

If you require a longer pre-wash you can extend the Cottons programme's standard pre-wash time of 25 minutes

Options

- No increase (Factory default setting)
25 minute pre-wash
- +6 min
31 minute pre-wash
- +9 min
34 minute pre-wash
- +12 min
37 minute pre-wash

Soak duration

You can set a duration for the soak process of between 30 minutes and 5 hours.

You can select the duration in 30 minute increments. When the *Soak* option is selected the laundry will be soaked for the duration selected.

Gentle action

Activating gentle action reduces the drum action and is suitable for washing slightly soiled items more gently.

Gentle action can be activated for the *Cottons* and *Minimum iron* programmes.

Factory default setting: Gentle action is switched off.

Reduce temp.

The boiling point for water is lower at altitudes of more than 1000 m above sea level. In order to avoid water boiling, the maximum temperature is reduced to 80°C even when a higher temperature is selected.

Factory default setting: the reduce temperature setting is switched off.

Settings

Water plus level

The water level can be increased in 4 stages by activating the Water plus option.

Stages:

- Normal (Factory default setting)
- Plus δ
- Plus δδ
- Plus δδδ

Maximum rinse level

The water level in the rinse cycle can be permanently set to the highest value.

This function is useful for allergy sufferers as it achieves an excellent rinse result. Water consumption will increase.

Factory default setting: the maximum rinse level setting is switched off.

Suds cooling

When this is activated, additional water flows into the drum at the end of the main wash to cool the suds down. Hot suds can damage plastic drainage pipes.

Suds cooling takes place when a temperature of 70°C or higher is selected for the Cottons programme.

Suds cooling should be activated:

- to prevent the danger of scalding if the drain hose is hooked over the edge of a sink or basin.
- where drainage pipes do not comply with DIN 1986.

Factory default setting: Suds cooling is switched off.

Anti-crease

The anti-crease function helps prevent creasing if laundry is not going to be removed immediately after the end of the programme.

The drum continues to turn at intervals for up to 30 minutes at the end of the programme. The door can be opened at any time.

Factory default setting: anti-crease is switched on.

Delay start

For specifying which time prompt should appear with the delay start function.

Options

- Start at
With the Delay start function you specify at what time the wash programme should begin.
- Finish at (Factory default setting)
With the Delay start function you specify at what time the wash programme should end.

Optional accessories

Detergent, fabric care, additives and machine care products are available for this washing machine. All the products have been designed for Miele washing machines.

These and many other useful products can be ordered via the internet at www.miele-shop.com or from Miele (see end of this booklet for contact details).



Detergent

UltraPhase 1 and UltraPhase 2

- universal liquid detergent and detergent enhancer dispensed as two components.
- suitable for white and coloured laundry
- no need to refill as the components for the TwinDos system are supplied in single use cartridges.

UltraWhite

- powder detergent
- suitable for white and light coloured laundry as well as heavily soiled cotton items
- effective stain removal even at low temperatures

UltraColor

- liquid detergent for coloureds
- suitable for coloured and dark/black garments
- protects bright colours from fading
- effective stain removal even at low temperatures

Wool and delicates detergent

- liquid detergent for delicates
- particularly suitable for woollen and silk garments
- cleans at temperatures as low as 20°C, helps retain the shape of delicate garments and protect colours

Specialist detergents

Specialist detergents are available as capsules  in convenient single dose amounts or in a handy bottle.

Outerwear

- liquid detergent for outerwear and performance clothing
- cleans with care and is gentle on colours
- with lanolin to care for and condition membrane fabric

Sports

- liquid detergent for sportswear and fleece garments
- neutralises unpleasant odours
- retains the shape of the textiles

Down items

- liquid detergent suitable for pillows, sleeping bags and down filled items
- retains the elasticity of down and feather filled items
- retains the breathability of down filled items
- prevents down filling clumping together

WoolCare

- liquid detergent for woollens and delicates
- with a special wheat protein conditioning formula
- helps prevent pilling
- gentle on colours
- only available as capsules 

SilkCare

- liquid detergent for silks
- with a special silk protein conditioning formula
- gentle on colours
- only available as capsules 

Fabric care

Fabric care agents are available as capsules  in convenient single dose amounts or in a handy bottle.

Reproofing agent

- for reproofing microfibre garments e.g. rain coats etc.
- retains the breathability of garments

Fabric conditioner

- fresh, natural fragrance
- makes laundry soft to handle

Additives

Booster

- for removing stains
- suitable for white and coloured laundry
- available as capsules  in convenient single dose amounts

Machine care products

Machine cleaner

- for cleaning the washing machine thoroughly and effectively
- removes grease, bacteria and unpleasant odours

Descaling agent

- removes heavy limescale deposits
- mild and gentle with natural citric acid

United Kingdom

Miele Co. Ltd.
Fairacres, Marcham Road
Abingdon, Oxon, OX14 1TW
Customer Contact Centre Tel: 0330 160 6600
E-mail: mielecare@miele.co.uk
Internet: www.miele.co.uk

Australia

Miele Australia Pty. Ltd.
ACN 005 635 398
ABN 96 005 635 398
1 Gilbert Park Drive, Knoxfield, VIC 3180
Tel: 1300 464 353
Internet: www.miele.com.au

China

Miele (Shanghai) Trading Ltd.
1-3 Floor, No. 82 Shi Men Yi Road
Jing' an District
200040 Shanghai, PRC
Tel: +86 21 6157 3500, Fax: +86 21 6157 3511
E-mail: info@miele.cn, Internet: www.miele.cn

Miele (Hong Kong) Limited

41/F - 4101, Manhattan Place
23 Wang Tai Road
Kowloon Bay, Hong Kong
Tel: (852) 2610 1331, Fax: (852)2610 1013
Email: mielehk@miele.com.hk

India

Miele India Pvt. Ltd.
Ground Floor, Copia Corporate Suites
Plot No. 9, Jasola
New Delhi - 110025
Tel: 011-46 900 000, Fax: 011-46 900 001
E-mail: customercare@miele.in, Internet: www.miele.in

Ireland

Miele Ireland Ltd.
2024 Bianconi Avenue
Citywest Business Campus, Dublin 24
Tel: (01) 461 07 10, Fax: (01) 461 07 97
E-Mail: info@miele.ie, Internet: www.miele.ie

Manufacturer: Miele & Cie. KG

Carl-Miele-Straße 29, 33332 Gütersloh, Germany

Miele

Malaysia

Miele Sdn Bhd
Suite 12-2, Level 12
Menara Sapura Kencana Petroleum
Solaris Dutamas No. 1, Jalan Dutamas 1
50480 Kuala Lumpur, Malaysia
Phone: +603-6209-0288
Fax: +603-6205-3768

New Zealand

Miele New Zealand Limited
IRD 98 463 631
Level 2, 10 College Hill
Freemans Bay, Auckland 1011, NZ
Tel: 0800 464 353
Internet: www.miele.co.nz

Singapore

Miele Pte. Ltd.
163 Penang Road
04 - 03 Winsland House II
Singapore 238463
Tel: +65 6735 1191, Fax: +65 6735 1161
E-Mail: info@miele.com.sg
Internet: www.miele.sg

South Africa

Miele (Pty) Ltd
63 Peter Place, Bryanston 2194
P.O. Box 69434, Bryanston 2021
Tel: (011) 875 9000, Fax: (011) 875 9035
E-mail: info@miele.co.za
Internet: www.miele.co.za

United Arab Emirates

Miele Appliances Ltd.
P.O. Box 11 47 82
Gold & Diamond Park, Sheikh Zayed Road
Building 6 / Offices Nos. 6-214 to 6-220
Dubai
Tel: +971-4-341 84 44
Fax: +971-4-341 88 52
E-Mail: info@miele.ae
Internet: www.miele.ae

WMV 960 WPS



en-GB

M.-Nr. 10 165 850 / 00