

Register your product and get support at  
[www.philips.com/welcome](http://www.philips.com/welcome)

HR1572  
HR1574

---

EN User manual

---

**PHILIPS**

# Contents

---

<b>1 Important</b>	<b>4</b>
Electromagnetic fields (EMF)	4
Recycling	4
<hr/>	
<b>2 Introduction</b>	<b>5</b>
<hr/>	
<b>3 Overview</b>	<b>6</b>
<hr/>	
<b>4 Use the appliance</b>	<b>7</b>
Before the first use	7
Wire beaters/strip beaters/kneading hooks	7
Bar blender	8
Quantity and processing time	9
Recipe	9
<hr/>	
<b>5 Cleaning</b>	<b>10</b>
<hr/>	
<b>6 Storage</b>	<b>10</b>
<hr/>	
<b>7 Guarantee and service</b>	<b>11</b>

# 1 Important

Read this user manual carefully before you use the appliance, and save the user manual for future reference.

## Warning

- Do not immerse the motor unit in water nor rinse it under the tap.
- Before you connect the appliance to the power, make sure that the voltage indicated on the bottom of the appliance corresponds to the local power voltage.
- If the power cord, the plug, or other parts are damaged, do not use the appliance.
- If the power cord is damaged, you must have it replaced by Philips, a service center authorized by Philips, or similarly qualified persons to avoid a hazard.
- This appliance is not intended for use by persons (including children) with reduced physical, sensory or mental capabilities, or lack of experience and knowledge, unless they have been given supervision or instruction concerning use of the appliance by a person responsible for their safety.
- For their safety, do not allow children to play with the appliance.
- Do not touch the blades, especially when the appliance is plugged in. The blades are very sharp.
- If the blades get stuck, unplug the appliance before you remove the ingredients that block the blades.
- Before you connect the mixer to the mains, insert the beaters, kneading hooks, or blender bar into the mixer.
- Before you switch on the appliance, lower the beaters, kneading hooks, or blender bar into the ingredients.
- Before you remove or clean the beaters, kneading hooks, or blender bar, unplug the mixer.

## Caution

- Never use any accessories or parts from other manufacturers or that Philips does not specifically recommend. If you use such accessories or parts, your guarantee becomes invalid.
- This appliance is intended for household use only.
- Do not exceed the quantities and processing time indicated in the user manual.
- Do not process more than one batch without interruption. Let the appliance cool down for five minutes before you continue processing.

## Note

- Noise level = 85 dB [A]

---

## Electromagnetic fields (EMF)

This Philips appliance complies with all standards regarding electromagnetic fields (EMF). If handled properly and according to the instructions in this user manual, the appliance is safe to use based on scientific evidence available today.

---

## Recycling



Your product is designed and manufactured with high quality materials and components, which can be recycled and reused.

When you see the crossed-out wheel bin symbol attached to a product, it means the product is covered by the European Directive 2002/96/EC:



Never dispose of your product with other household waste. Please inform yourself about the local rules on the separate collection of electrical and electronic products. The correct disposal of your old product helps prevent potentially negative consequences on the environment and human health.

## 2 Introduction

Congratulations on your purchase and welcome to Philips! To fully benefit from the support that Philips offers, register your product at [www.philips.com/welcome](http://www.philips.com/welcome).

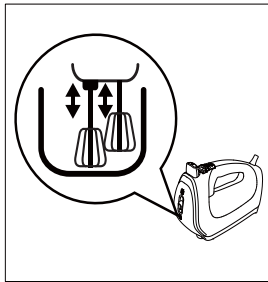

The Philips mixer with bar blender can confidently handle a large variety of ingredients. With the powerful 5 speeds and turbo, the stainless steel wire beaters/strip beaters and kneading hooks make light work of the toughest dough.

HR1574 is equipped with the innovative FlexiMix system, which allows the beaters and dough hooks to move up and down when they touch the bowl. The two wire beaters/strip beaters (or kneading hooks) move independently of each other, which allows them to adjust to the shape of every bowl. As a result, it is much easier to reach every part of the bowl and to mix all ingredients thoroughly. The FlexiMix system makes the mixer easier to handle and gives you better control over the mixing process.

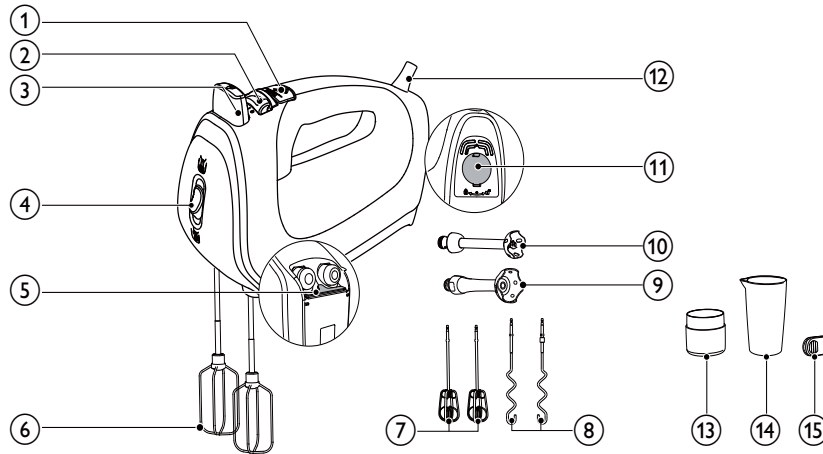

### 3 Overview



- ① **Turbo knob**
  - (For the wire beaters/strip beaters/ kneading hooks only) Press and hold to increase the speed for a heavy job
  - (For the bar blender only) Press and hold to switch on the bar blender
- ② **Speed control**
  - 0: Switch off the wire beaters/strip beaters/kneading hooks
  - 1 2 3 4 5: Switch on the wire beaters/strip beaters/ kneading hooks and select a proper speed
- ③ **Eject button**
  - Press to release the inserted wire beaters/strip beaters/kneading hooks
- ④ **FlexiMix switch (For HR1574 only)**
  -  : FlexiMix off
  -  : FlexiMix on
- ⑤ **Door for the wire beaters/strip beaters/ kneading hooks**
- ⑥ **Two wire beaters (Depending on country)**
- ⑦ **Two strip beaters (Depending on country)**
- ⑧ **Two kneading hooks**
- ⑨ **Plastic bar blender (For HR1572 only)**
- ⑩ **Metal bar blender (For HR1574 only)**
- ⑪ **Door for bar blender**
- ⑫ **Power cord**
- ⑬ **Cover of storage beaker (For HR1574)**
- ⑭ **Storage beaker**
- ⑮ **Cord clip**

## 4 Use the appliance

### Before the first use

Before you use the appliance for the first time, thoroughly clean the parts that come into contact with food (see 'Cleaning' on page 12).

- 1 Clean the motor unit with a moist cloth.
- 2 Clean the beaters, kneading hooks, bar blender, and beaker in warm water with some washing-up liquid or in a dishwasher.

### Wire beaters/strip beaters/kneading hooks

- 1 Insert the wire/strip beaters or kneading hooks into the main unit until you hear a click.

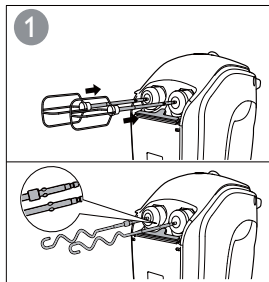

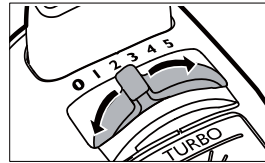

- 2 Insert the plug in the power outlet.
- 3 Put the ingredients in a bowl.
- 4 Lower the inserted wire/strip beaters or kneading hooks into the ingredients.

- 5 Select a proper speed, from 1 to 5, to switch on the wire/strip beaters or kneading hooks. To avoid splashing, start mixing at a low speed, and then switch to a higher speed.

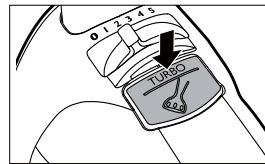

- For a heavy job, press and hold  while processing.



- (For HR1574) If you want to use the FlexiMix function, set the FlexiMix button to .

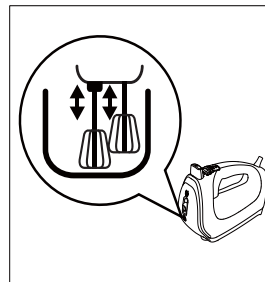

- 6 After use, turn the speed selector to 0, and then unplug the appliance.

- 7 Press ▲ to release the wire/strip beaters or kneading hooks.

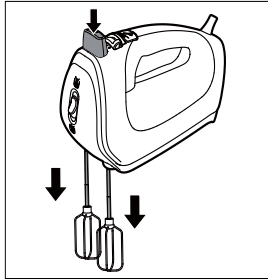

**Tip**

- If the door for the wire beaters, strip beaters, or kneading hooks is blocked, close the bar blender door to open it.

## Bar blender

- 1 Make sure that the speed selector is turned to 0.

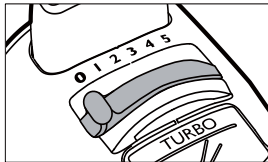

- 2 Open the door for the bar blender.

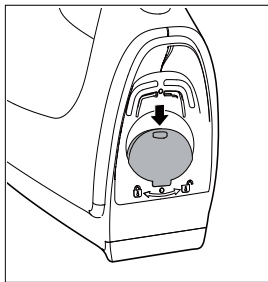

- 3 Insert the bar blender into the back of the main unit, and then turn it clockwise until the indication on the bar blender and the one on the main unit align.  
↳ When the bar blender is installed properly, you can hear a click.

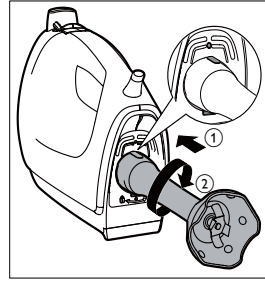

- 4 Insert the plug in the power outlet.  
5 Put the ingredients in the storage beaker, and then lower the bar blender into the ingredients.  
6 Press and hold  to switch on the bar blender.

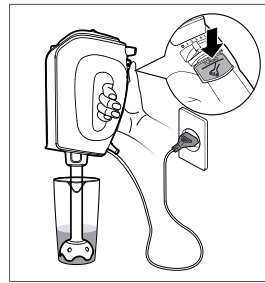

- 7 After use, turn the speed selector to 0, and then unplug the appliance.  
8 Turn the bar blender anticlockwise to release it.  
9 Close the bar blender door:

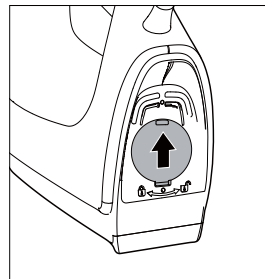

## Quantity and processing time

- Wire beaters/Strip beaters (FlexiMix on , Speed 5)

Ingredients	Quantity	Time
Batters for waffles or pancakes	Approx. 750 g	Approx. 3 minutes
Thin sauces, creams, or soups	Approx. 750 g	Approx. 3 minutes
Mayonnaise	Max. 3 egg yolks	Approx. 15 minutes
Pureeing potatoes	Max. 750 g	Max. 3 minutes
Whipping cream	Max. 500 g	Max. 3 minutes
Whiskines	Max. 5 egg whites	Approx. 3 minutes
Cake mixture	Approx. 750 g	Approx. 3 minutes

- Kneading hooks (FlexiMix on or off, Speed 5)

Ingredients	Quantity	Time
Yeast dough	Max. 500 g flour	Max. 5 minutes

- Bar blender (FlexiMix off )

Ingredients	Quantity	Time
Fruits or vegetables	100-200 g	30 seconds
Baby food, soup, or sauces	100-300 ml	90 seconds
Batters	100-300 ml	60 seconds
Shakes or mixed drinks	100-300 ml	60 seconds

## Recipe



Tip

- For more recipes, visit [www.philips.com/kitchen](http://www.philips.com/kitchen).

## Spice Bread

### Ingredients

- 250 g flour
- 150 g rye flour
- 250 g honey (cold)
- 150 g sugar
- 11 g yeast
- 4 g cinnamon
- 50 ml milk
- 1 egg

**1** Put the ingredients in a bowl.

**2** Turn the speed selector to **1**.

**3** Knead the dough with the wire beaters/strip beaters for 1 minute.

**4** Put the bowl with the dough in warm place for 20 minutes.

**5** Press and hold  to mix the ingredients for 10 seconds.

**6** Bake the spice bread in a baking tin at 180°C for approximately 1 hour.



Tip

- This recipe is extremely heavy for your mixer. Let your mixer cool down to room temperature.

## Pizza

### Ingredients

- 500 g flour
- 3 g dried yeast
- 3 tablespoons olive oil
- 1 tablespoon sea salt

**1** Put all the dry ingredients in the bowl.

**2** Turn the speed selector to **5**, and mix the ingredients for about 5 minutes.

**3** Pour in water and oil slowly.

**4** Knead until a well mixed ball is formed.

**5** Leave the dough to rise at room temperature under a clean cloth for half an hour.

**6** Knead the dough well and leave to rise for another half an hour.

**7** Preheat the oven to 230-250°C.

**8** Roll out the dough to the desired size. Cover with tomato sauce and decorate with ingredients, like cheese, salami, anchovies, or grilled vegetables.

**9** Bake the pizza for 10-15 minutes until it golden brown.















## 5 Cleaning

### ! Caution

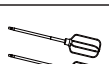
- Before you clean the appliance or release any accessory, unplug it.

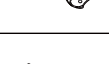
- 1 Clean the motor unit with a moist cloth.
- 2 Clean the beaters, kneading hooks, blender bar, and beaker in warm water with some washing-up liquid or in a dishwasher:

			
			✓
	✓	✓	✓
	✓	✓	✓
	✓	✓	✓
	✓	✓	✓
	✓	✓	✓
	✓	✓	✓
	✓	✓	✓

## 6 Storage

- 1 Wind the power cord round the heel of the appliance.

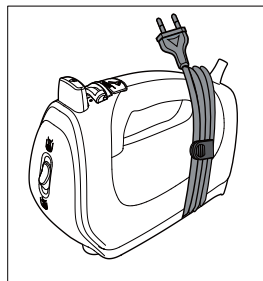

- 2 Put the beaters, kneading hooks, and blender bar in the storage beaker:

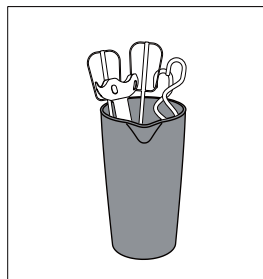

- 3 (For HR1574) Cover the storage beaker.

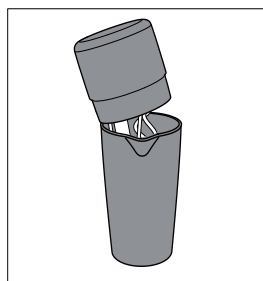

- 4 Store the appliance in a dry place away from direct sunlight or other sources of heat.

## 7 Guarantee and service

If you have a problem, need service, or need information, see [www.philips.com/support](http://www.philips.com/support) or contact the Philips Consumer Care Center in your country. The phone number is in the worldwide guarantee leaflet. If there is no Consumer Care Center in your country, go to your local Philips dealer.



© 2011 Koninklijke Philips Electronics N.V.  
All rights reserved.  
HR1572 HR1574\_UM\_V0.3

