

**SAMSUNG**

# FULL MANUAL

---

**HW-MS6500 / HW-MS6501**

Imagine the possibilities









Thank you for purchasing this Samsung product.

To receive more complete service, please register  
your product at [www.samsung.com/register](http://www.samsung.com/register)

# SAFETY INFORMATION

## SAFETY WARNINGS

TO REDUCE THE RISK OF ELECTRIC SHOCK, DO NOT REMOVE THE COVER (OR BACK). NO USER-SERVICEABLE PARTS ARE INSIDE. REFER SERVICING TO QUALIFIED SERVICE PERSONNEL.

	<b>CAUTION</b> <b>RISK OF ELECTRIC SHOCK.</b> <b>DO NOT OPEN.</b>	
	This symbol indicates that high voltage is present inside. It is dangerous to make any kind of contact with any internal part of this product.	
	This symbol indicates that important literature concerning operation and maintenance has been included with this product.	
	Class II product : This symbol indicates that it does not require a safety connection to electrical earth (ground).	
	AC voltage : This symbol indicates that the rated voltage marked with the symbol is AC voltage.	
	DC voltage : This symbol indicates that the rated voltage marked with the symbol is DC voltage.	
	Caution, Consult instructions for use : This symbol instructs the user to consult the user manual for further safety related information.	

## WARNING

- To reduce the risk of fire or electric shock, do not expose this appliance to rain or moisture.

## CAUTION

- TO PREVENT ELECTRIC SHOCK, MATCH WIDE BLADE OF PLUG TO WIDE SLOT, FULLY INSERT.
- This apparatus shall always be connected to a AC outlet with a protective grounding connection.
- To disconnect the apparatus from the mains, the plug must be pulled out from the mains socket, therefore the mains plug shall be readily operable.
- Do not expose this apparatus to dripping or splashing. Do not put objects filled with liquids, such as vases on the apparatus.
- To turn this apparatus off completely, you must pull the power plug out of the wall socket. Consequently, the power plug must be easily and readily accessible at all times.

## Wiring the Main Power Supply Plug (UK Only)

### IMPORTANT NOTICE

The mains lead on this equipment is supplied with a moulded plug incorporating a fuse. The value of the fuse is indicated on the pin face of the plug and if it requires replacing, a fuse approved to BS1362 of the same rating must be used. Never use the plug with the fuse cover removed. If the cover is detachable and a replacement is required, it must be of the same colour as the fuse fitted in the plug. Replacement covers are available from your dealer. If the fitted plug is not suitable for the power points in your house or the cable is not long enough to reach a power point, you should obtain a suitable safety approved extension lead or consult your dealer for assistance.

However, if there is no alternative to cutting off the plug, remove the fuse and then safely dispose of the plug. Do not connect the plug to a mains socket as there is a risk of shock hazard from the bared flexible cord. Never attempt to insert bare wires directly into a mains socket. A plug and fuse must be used at all times.

### **IMPORTANT**

The wires in the mains lead are coloured in accordance with the following code:– BLUE = NEUTRAL BROWN = LIVE As these colours may not correspond to the coloured markings identifying the terminals in your plug, proceed as follows:– The wire coloured BLUE must be connected to the terminal marked with the letter N or coloured BLUE or BLACK. The wire coloured BROWN must be connected to the terminal marked with the letter L or coloured BROWN or RED.

**WARNING : DO NOT CONNECT EITHER WIRE TO THE EARTH TERMINAL WHICH IS MARKED WITH THE LETTER E OR BY THE EARTH SYMBOL , OR COLOURED GREEN OR GREEN AND YELLOW.**

## **PRECAUTIONS**

1. Ensure that the AC power supply in your house complies with the power requirements listed on the identification sticker located on the back of your product. Install your product horizontally, on a suitable base (furniture), with enough space around it for ventilation (7–10 cm). Make sure the ventilation slots are not covered. Do not place the unit on amplifiers or other equipment which may become hot. This unit is designed for continuous use. To fully turn off the unit, disconnect the AC plug from the wall outlet. Unplug the unit if you intend to leave it unused for a long period of time.
2. During thunderstorms, disconnect the AC plug from the wall outlet. Voltage peaks due to lightning could damage the unit.
3. Do not expose the unit to direct sunlight or other heat sources. This could lead to overheating and cause the unit to malfunction.
4. Protect the product from moisture (i.e. vases), and excess heat (e.g. a fireplace) or equipment creating strong magnetic or electric fields. Unplug the power cable from the AC wall socket if the unit malfunctions. Your product is not intended for industrial use. It is for personal use only. Condensation may occur if your product has been stored in cold temperatures. If transporting the unit during the winter, wait approximately 2 hours until the unit has reached room temperature before using.
5. The battery used with this product contains chemicals that are harmful to the environment. Do not dispose of the battery in the general household trash. Do not expose the battery to excess heat, direct sunlight, or fire. Do not short circuit, disassemble, or overheat the battery. Danger of explosion if the battery is replaced incorrectly. Replace only with the same or equivalent type.

# ABOUT THIS MANUAL

The user manual has two parts: this simple paper USER MANUAL and a detailed FULL MANUAL you can download.



## USER MANUAL

See this manual for safety instructions, product installation, components, connections, and product specifications.



## FULL MANUAL

You can access the Full Manual on Samsung's on-line customer support centre by scanning the QR code. To see the manual on your PC or mobile device, download the manual in document format from the website. (<http://www.samsung.com/support>)

Design, specifications and App screen are subject to change without prior notice.

# CONTENTS

<b>01</b>	<b>Checking the Components</b>	<b>2</b>
	Inserting Batteries before using the Remote Control (AA batteries X 2)	2
<b>02</b>	<b>Product Overview</b>	<b>3</b>
	Front Panel / Right Side Panel of the Soundbar	3
	Bottom Panel of the Soundbar	4
<b>03</b>	<b>Connecting the Soundbar</b>	<b>5</b>
	Connecting Electrical Power	5
<b>04</b>	<b>Connecting to your TV</b>	<b>7</b>
	Method 1. Connecting with a Cable	7
	– Connecting a TV using an HDMI Cable	7
	– Connecting using an Optical Cable	8
	Method 2. Connecting Wirelessly	9
	– Connecting a TV via Bluetooth	9
	– Connecting via Wi-Fi	11

<b>05</b>	<b>Connecting an External Device</b>	<b>13</b>
	Connecting using an HDMI Cable	13
	Connecting using an Optical or Analogue Audio (AUX) Cable	14
<b>06</b>	<b>Connecting a Mobile Device</b>	<b>15</b>
	Method 1. Connecting via Bluetooth	15
	Method 2. Connecting via Wi-Fi (Wireless Network)	18
<b>07</b>	<b>Using the Remote Control</b>	<b>20</b>
	How to Use the Remote Control	20
	Adjusting the Soundbar volume with a TV remote control	23
	Using the Hidden Buttons	24
	Output specifications for the different sound effect modes	24
<b>08</b>	<b>Installing the Wall Mount</b>	<b>25</b>
	Installation Precautions	25
	Wallmount Components	25
	Assembling the Holder-Cable	27
	Installing the Holder Foot	28
<b>09</b>	<b>Software Update</b>	<b>28</b>
<b>10</b>	<b>Troubleshooting</b>	<b>29</b>
<b>11</b>	<b>Licence</b>	<b>30</b>
<b>12</b>	<b>Open Source Licence Notice</b>	<b>30</b>
<b>13</b>	<b>Important Notes About Service</b>	<b>31</b>
<b>14</b>	<b>Specifications and Guide</b>	<b>31</b>
	Specifications	31

# 01 CHECKING THE COMPONENTS

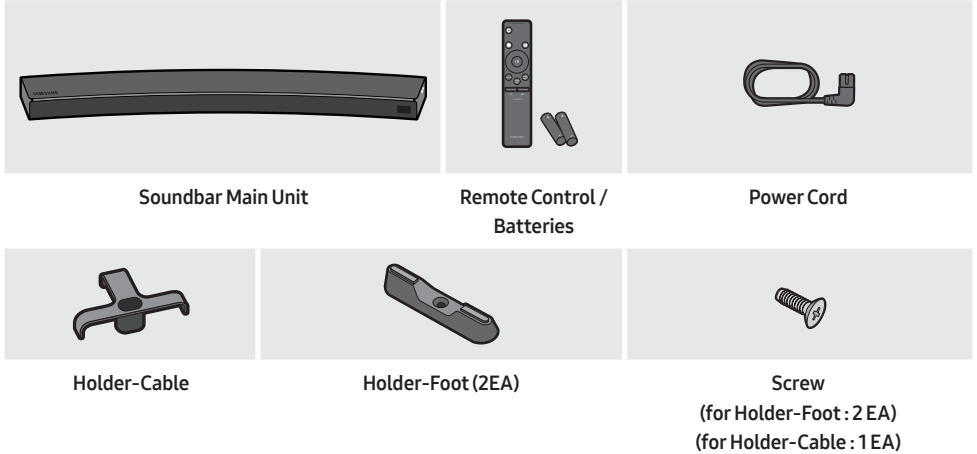

- For Soundbar wall mounting components, see page 25.
- See page 27 for instructions on how to use the **Holder-Cable**.
- To purchase additional components or optional cables, contact a Samsung Service Centre or Samsung Customer Care.
- The appearance of the accessories may differ slightly from the illustrations above.

## Inserting Batteries before using the Remote Control (AA batteries X 2)

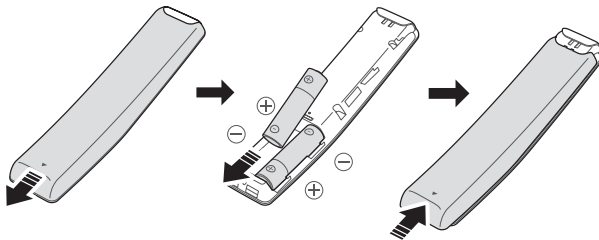

Slide the battery cover in the direction of the arrow until it is completely removed. Insert 2 AA batteries (1.5V) oriented so that their polarity is correct. Slide the battery cover back into position.

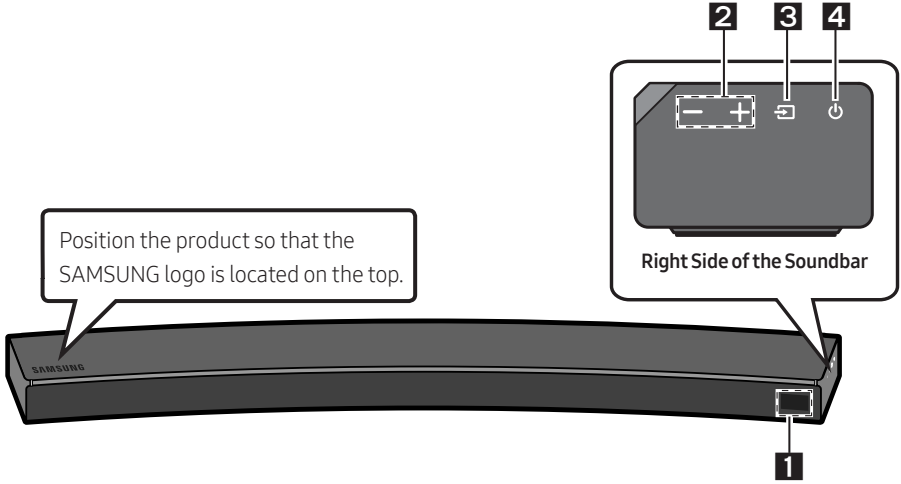

# 02 PRODUCT OVERVIEW

## Front Panel / Right Side Panel of the Soundbar



<b>1</b>	<p><b>Display</b> Displays the product's status and current mode.</p>														
<b>2</b>	<p><b>-/+ (Volume) Button</b> Adjusts the volume.</p> <ul style="list-style-type: none"> <li>When adjusted, the volume level appears on the Soundbar's front display.</li> </ul>														
<b>3</b>	<p> <b>(Source) Button</b> Selects the source input mode.</p> <table border="1" data-bbox="151 1002 863 1264"> <thead> <tr> <th>Input mode</th> <th>Display</th> </tr> </thead> <tbody> <tr> <td>Optical Digital input</td> <td>D.IN</td> </tr> <tr> <td>ARC (HDMI OUT) input</td> <td>D.IN → TV ARC (Auto conversion)</td> </tr> <tr> <td>AUX input</td> <td>AUX</td> </tr> <tr> <td>HDMI input</td> <td>HDMI</td> </tr> <tr> <td>Wi-Fi mode</td> <td>WIFI</td> </tr> <tr> <td>BLUETOOTH mode</td> <td>BT</td> </tr> </tbody> </table> <ul style="list-style-type: none"> <li>To turn on "<b>BT PAIRING</b>" mode, change the source to "<b>BT</b>" mode, and then press and hold the  <b>(Source)</b> button for more than 5 seconds.</li> </ul>	Input mode	Display	Optical Digital input	D.IN	ARC (HDMI OUT) input	D.IN → TV ARC (Auto conversion)	AUX input	AUX	HDMI input	HDMI	Wi-Fi mode	WIFI	BLUETOOTH mode	BT
Input mode	Display														
Optical Digital input	D.IN														
ARC (HDMI OUT) input	D.IN → TV ARC (Auto conversion)														
AUX input	AUX														
HDMI input	HDMI														
Wi-Fi mode	WIFI														
BLUETOOTH mode	BT														
<b>4</b>	<p> <b>(Power) Button</b> Turns the power on and off.</p>														

- When you plug in the AC cord, the power button will begin working in 4 to 6 seconds.
- When you turn on this unit, there will be a 4 to 5 second delay before it produces sound.
- If you want to enjoy sound only from the Soundbar, you must turn off the TV's speakers in the Audio Setup menu of your TV. Refer to the owner's manual supplied with your TV.

## Bottom Panel of the Soundbar

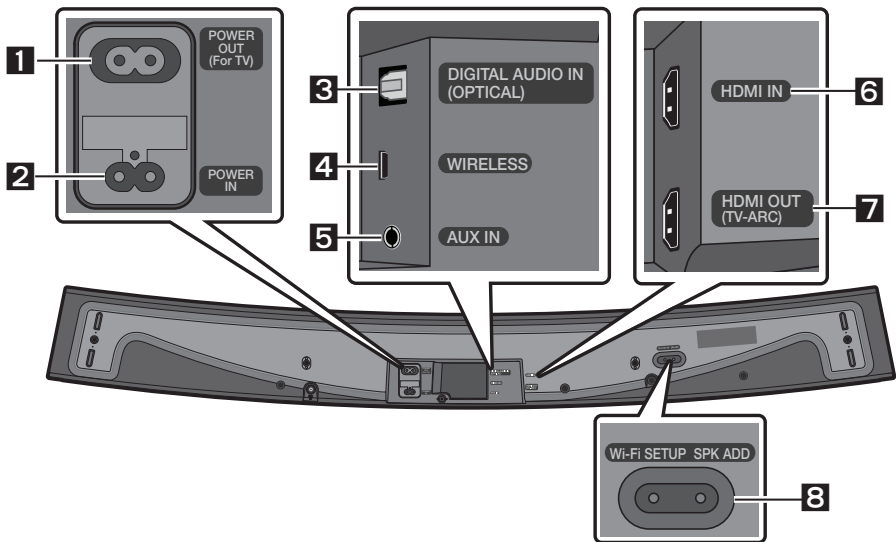

<p><b>1</b></p>	<p><b>POWER OUT (For TV)</b> Connect the power cord of a Samsung TV connected to the Soundbar and mounted on the wall using a Wall Mount Kit (WMN300SB - not supplied).</p>
<p><b>2</b></p>	<p><b>POWER IN</b> Connect the Soundbar's AC power cable.</p>
<p><b>3</b></p>	<p><b>DIGITAL AUDIO IN (OPTICAL)</b> Connect to the digital (optical) output of an external device.</p>
<p><b>4</b></p>	<p><b>WIRELESS</b> Attach the wireless dongle that connects the Soundbar to surround speakers and a subwoofer wirelessly. (The surround speaker, subwoofer, and wireless dongle are sold separately.)</p> <ul style="list-style-type: none"> <li>• The <b>WIRELESS</b> jack is not USB-compatible.</li> <li>• The availability of subwoofers differs by area. Check the availability at <a href="http://www.samsung.com/support">http://www.samsung.com/support</a>.</li> </ul>
<p><b>5</b></p>	<p><b>AUX IN</b> Connect to the Analogue output of an external device.</p>



<b>6</b>	<b>HDMI IN</b> Inputs digital video and audio signals simultaneously using an HDMI cable. Connect to the HDMI output of an external device.
<b>7</b>	<b>HDMI OUT (TV-ARC)</b> Connect to the HDMI (ARC) jack on a TV.
<b>8</b>	<b>Wi-Fi SETUP / SPK ADD</b> Connect to a wireless network (Wi-Fi) via the <b>Samsung Multiroom</b> app.

- When disconnecting the power cable from a wall outlet, pull the plug. Do not pull the cable.
- Do not connect this unit or other components to an AC outlet until all connections between components are complete.

## 03 CONNECTING THE SOUNDBAR

### Connecting Electrical Power

- For more information about the required electrical power and power consumption, refer to the label attached to the product. (Label : Bottom of the Soundbar Main Unit)

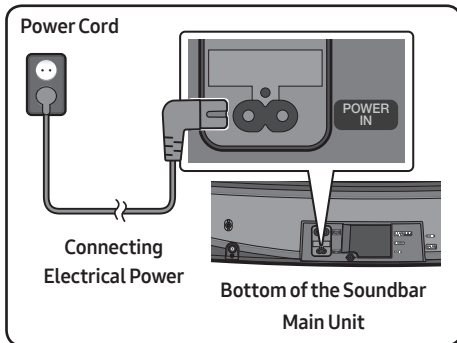

- Connect the supplied power cable to the **POWER IN** jack.

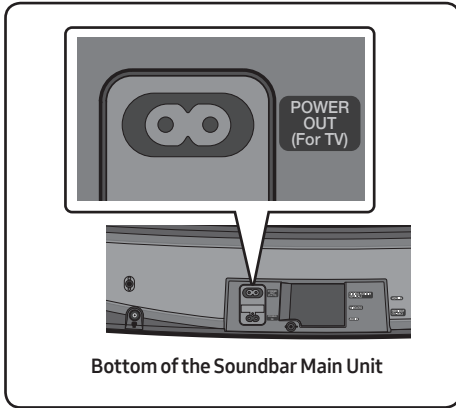

- The **POWER OUT** jack is used to provide power to a Samsung TV mounted on the wall using a Wall Mount Kit (WMN300SB - not supplied).
- The **POWER OUT** jack can connect only to Samsung TVs that use a 2-pin power cord and consume 400 W or less. (Connecting the jack to a device that consumes more than 400 W may damage the Soundbar or cause a malfunction.)



For a list of Samsung TVs that are compatible with the WMN300SB Wall Mount Kit and the **POWER OUT** jack, see the WMN300SB Wall Mount Kit user manual.

You can view the manual on line at <http://www.samsung.com/support>.

# 04 CONNECTING TO YOUR TV

Hear TV sound from your Soundbar through wired or wireless connections.

- When the Soundbar is connected to a Samsung smart TV released in 2017 or later, the Soundbar can be controlled using the TV's remote control.
  - This function also allows you to use the TV menu to adjust the sound field and various settings as well as the volume and mute.

## Method 1. Connecting with a Cable

### Connecting a TV using an HDMI Cable

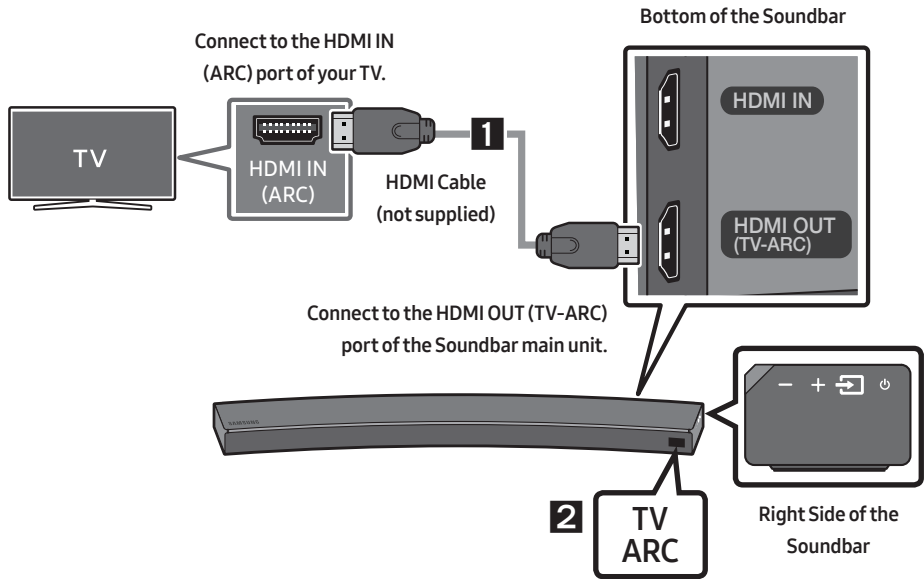

1. With the Soundbar and TV turned on, connect the HDMI cable (not supplied) as shown in the figure.
2. "TV ARC" appears in the display window of the Soundbar main unit and the Soundbar plays TV sound.
  - If TV sound is inaudible, press the  (**Source**) button on the remote control or on the right side of the Soundbar to switch to "D.IN" mode. The screen displays "D.IN" and "TV ARC" in sequence, and TV sound is played.

- If “**TV ARC**” does not appear in the display window of the Soundbar main unit, confirm that the cable is connected to the correct port.
- Use the volume buttons on the TV’s remote control to change the volume of the Soundbar.

## NOTES

- HDMI is an interface that enables the digital transmission of video and audio data with just a single connector.
- If the TV provides an ARC port, connect the HDMI cable to the HDMI IN (ARC) port.
- We recommend you use a coreless HDMI cable if possible. If you use a cored HDMI cable, use one whose diameter is less than 14 mm.
- Anynet+ must be turned on.
- This function is not available if the HDMI cable does not support ARC.

## Connecting using an Optical Cable

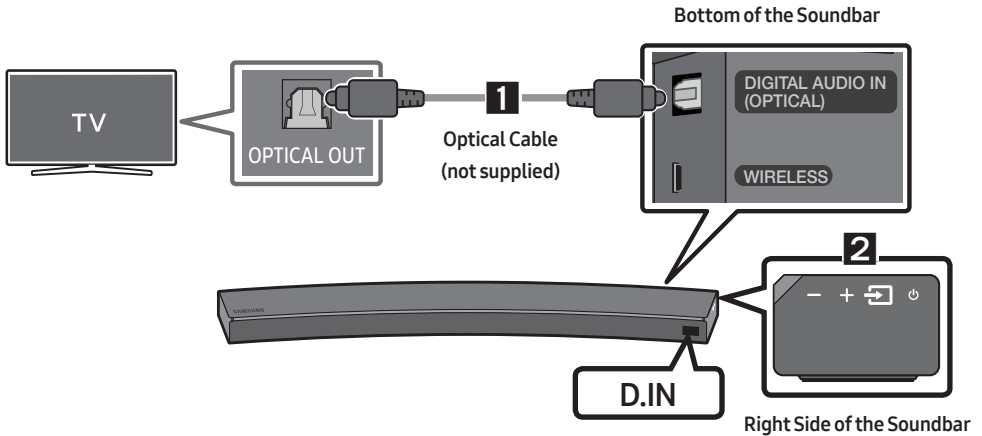

1. Connect the **DIGITAL AUDIO IN (OPTICAL)** jack on the Soundbar to the OPTICAL OUT jack of the TV with a digital optical cable (not supplied).
2. Press the  (**Source**) button on the right side panel or remote control, and then select the “**D.IN**” mode.

## Auto Power Link

Auto Power Link automatically turns on the Soundbar when the TV is turned on.

1. Connect the Soundbar and a TV with a digital optical cable (not supplied).
2. Press the  (**Source**) button on the right side panel or on the remote control, and then select “**D.IN**”.

3. Press the **Left** button on the remote control for 5 seconds to turn Auto Power Link on or off.
  - Auto Power Link is set to ON by default.  
(To turn off this function, turn off Auto Power using the Soundbar.)
  - Depending on the connected device, Auto Power Link may not function.
  - This function is only available in the **“D.IN”** mode.



## Method 2. Connecting Wirelessly



### Connecting a TV via Bluetooth

When a TV is connected using Bluetooth, you can hear stereo sound without the hassle of cabling.

- Only one TV can be connected at a time.



### The initial connection

1. Press the  (**Source**) button on the right side panel or on the remote control, and then select **“BT”**.
2. Change **“BT”** to **“BT PAIRING”**.
  - If **“BT READY”** appears, press and hold the  (**Source**) button on the right side panel of the Soundbar or on the remote control for more than 5 seconds to display **“BT PAIRING”**.
3. Select Bluetooth mode on the TV. (For more information, see the TV’s manual.)
4. Select **“[AV] Samsung Soundbar MSxxx”** from the list on TV’s screen.  
An available Soundbar is indicated with **“Need Pairing”** or **“Paired”** on the TV Bluetooth device list.  
To connect to the Soundbar, select the message and establish a connection.
  - When the TV is connected, **[TV Name] → “BT”** appears on the Soundbar’s front display.
5. You can now hear TV sound from the Soundbar.

## If the device fails to connect

- If the previously connected Soundbar listing (e.g. “[AV] Samsung Soundbar MSxxxx”) appears in the list, delete it.
- In “BT” mode, press and hold the  (Source) button for more than 5 seconds on the right side panel of the Soundbar or on the remote control to switch to “BT PAIRING” mode. Then, select “[AV] Samsung Soundbar MSxxxx” from the TV’s search list.

## What are the BT READY and BT PAIRING statuses?

- **BT READY** : In this mode, you can search for previously connected TVs or connect to the Soundbar from a previously connected mobile device.
- **BT PAIRING** : In this mode, you can connect to a new device. (While in “BT” mode, press and hold the  (Source) button for more than 5 seconds on the right side of the Soundbar or on the remote control.)

## NOTES

- If asked for a PIN code when connecting a Bluetooth device, enter <0000>.
- In Bluetooth connection mode, the Bluetooth connection will be lost if the distance between the Soundbar and the Bluetooth device exceeds 10 meters.
- The Soundbar automatically turns off after 5 minutes in the Ready state.
- The Soundbar may not perform Bluetooth search or connection correctly under the following circumstances:
  - If there is a strong electrical field around the Soundbar.
  - If several Bluetooth devices are simultaneously paired with the Soundbar.
  - If the Bluetooth device is turned off, not in place, or malfunctions.
- Electronic devices may cause radio interference. Devices that generate electromagnetic waves must be kept away from the Soundbar main unit - e.g., microwaves, wireless LAN devices, etc.

## Disconnecting the Soundbar from the TV

Press the  (Source) button on the right side panel or on the remote control and switch to any mode but “BT”.

- Disconnecting takes time because the TV must receive a response from the Soundbar. (The time required may differ, depending on the TV model.)

## Connecting via Wi-Fi

### Pre-connection Checklist

1. Confirm that your **Samsung smart TV was released after 2014**. This function is compatible only with Samsung smart TVs released after 2014.
2. Make sure your **Wireless router (Wi-Fi)** is ready and working.
3. Make sure that the **TV is connected to the Wireless router (your Wi-Fi network)**.

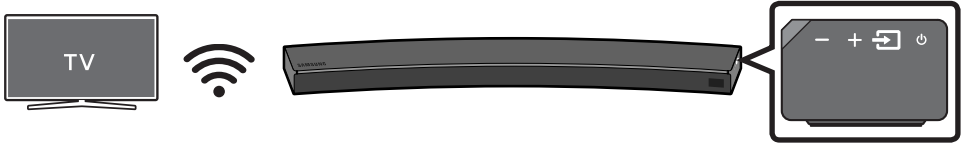

### Step 1 : Connecting the Soundbar to Wi-Fi

1. Press the  (**Source**) button on the right side of the Soundbar or on the remote control to select **"WIFI"** mode.
  - When using a Samsung smart TV released in 2016 or 2017,
    - If you select **"WIFI"** mode when the TV is turned on, the TV screen displays a pop-up window providing instructions on how to automatically connect the Soundbar to a wireless router (Wi-Fi). Refer to instructions in the pop-up window of TV.



2. Connect your mobile device (smartphone, tablet etc.) to the Wi-Fi network the TV is connected to.
3. Install and launch the **Samsung Multiroom** app on your mobile device (smartphone, tablet etc.).

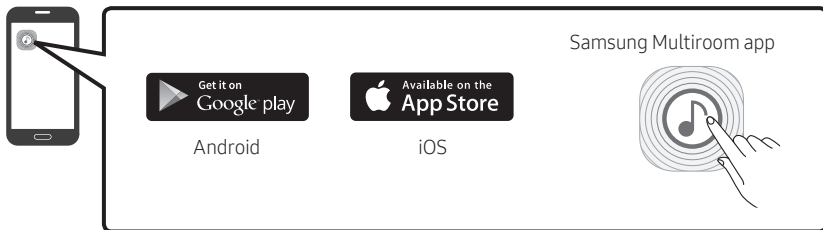

4. Follow the instructions in the app screen on the mobile device to connect the Soundbar to your Wi-Fi network.

## Step 2 : Configuring Settings on the TV

- If the TV disconnects from your wireless network after you change the input source to the Soundbar, use the TV menu to connect the TV to the network again.

### For TVs released in 2017

1. Home menu → Settings (⚙️) → Sound → Sound Output → Select [AV] Soundbar MSxxxx (Wi-Fi)
2. The Soundbar outputs TV sound.

### For TVs released in 2016

1. Home menu → Settings (⚙️) → Sound → Sound Output → Select [AV] Samsung Soundbar MSxxxx (Wi-Fi)
2. The Soundbar outputs TV sound.

### For TVs released in 2015

1. Home menu → Sound → Speaker List → Select [AV] Samsung Soundbar MSxxxx (Wi-Fi)
2. The Soundbar outputs TV sound.

### For TVs released in 2014

1. Home menu → Sound → Speaker Settings → Select **Multiroom Link - Settings** → **Soundbar+Surround**.
2. From the Soundbar menu item, select "[AV] Samsung Soundbar MS6500" and then select "OK".
3. Home menu → Sound → Speaker Settings → Select **TV Sound Output** → **Multiroom Link**

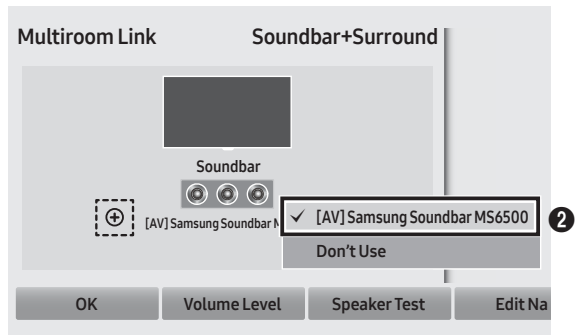
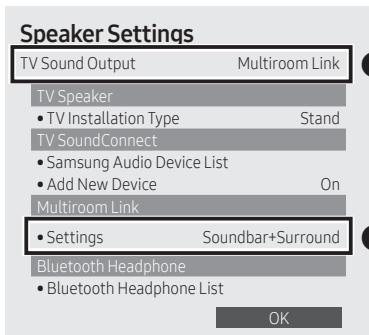

4. The Soundbar outputs TV sound.

## NOTES

- The TV and Soundbar must be connected to the same wireless network (Wi-Fi).
- If your wireless router (Wi-Fi) uses a DFS channel, you will not be able to establish a Wi-Fi connection between the TV and Soundbar. Contact your Internet service provider for details.



# 05 CONNECTING AN EXTERNAL DEVICE

Connect to an external device via a wired or wireless network to play the external device's sound through the Soundbar.

## Connecting using an HDMI Cable

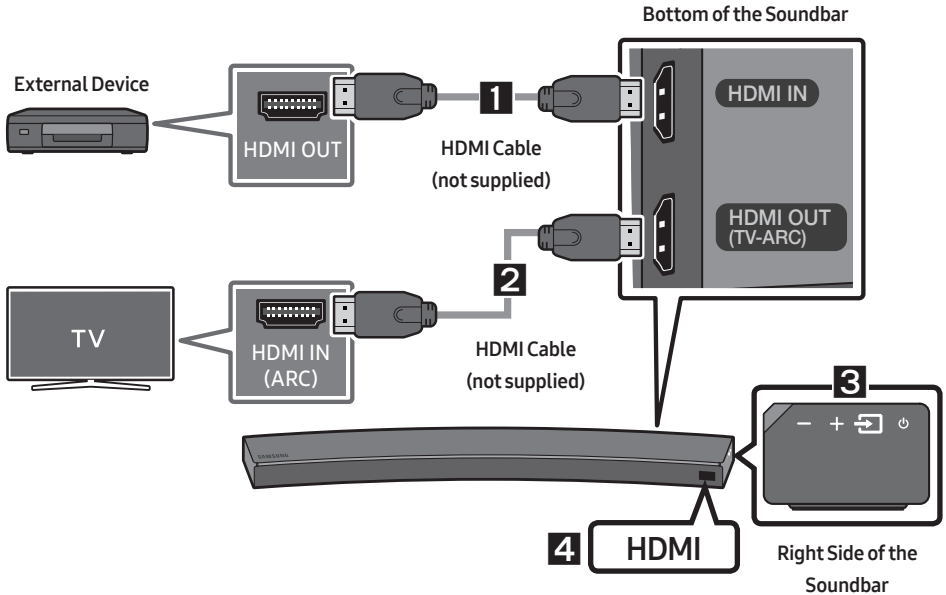

1. Connect an HDMI cable (not supplied) from the **HDMI IN** jack on the back of the product to the **HDMI OUT** jack on your digital device.
2. Connect an HDMI cable (not supplied) from the **HDMI OUT (TV-ARC)** jack on the back of the product to the **HDMI IN** jack on your TV.
3. Press the **Source** button on the right side panel or on the remote control, and then select **"HDMI"**.
4. **"HDMI"** mode is displayed on the Soundbar display panel and sound plays.

# Connecting using an Optical or Analogue Audio (AUX) Cable

BD / DVD player / Set-top box /  
Game console

Right Side of the Soundbar

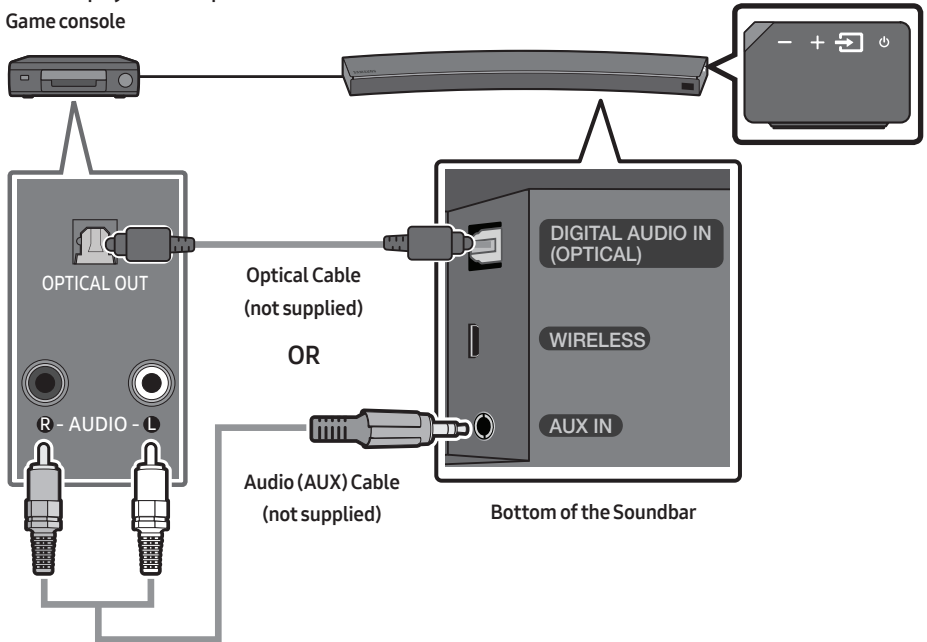

## Optical Cable

- 1 Connect **DIGITAL AUDIO IN (OPTICAL)** on the main unit to the OPTICAL OUT jack of the Source Device using a digital optical cable (not supplied).
- 2 Select “**D.IN**” mode by pressing the  (**Source**) button on the right side panel or on the remote control.

OR

## Audio (AUX) Cable

- 1 Connect **AUX IN** (Audio) on the main unit to the AUDIO OUT jack of the Source Device using an audio cable.
- 2 Select “**AUX**” mode by pressing  (**Source**) button on the right side panel or on the remote control.

# 06 CONNECTING A MOBILE DEVICE



## Method 1. Connecting via Bluetooth

When a mobile device is connected using Bluetooth, you can hear stereo sound without the hassle of cabling.

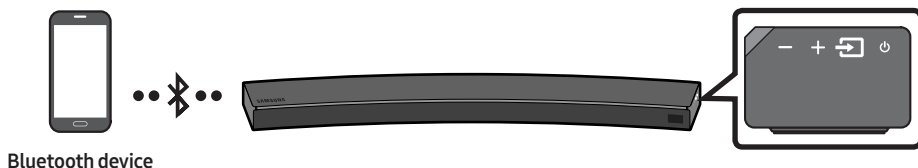
- You cannot connect more than one Bluetooth device at a time.



### The initial connection

1. Press the  (**Source**) button on the right side panel or on the remote control, and then select “BT”.
2. Change “BT” to “BT PAIRING”.
  - If “BT READY” appears, press and hold the  (**Source**) button on the right side panel of the Soundbar or on the remote control for more than 5 seconds to display “BT PAIRING”.
3. Select “[AV] Samsung Soundbar MSxxxx” from the list.
  - When a Soundbar is connected to the Bluetooth device, [Bluetooth Device Name] → “BT” appears in the front display.
4. Play music files from the device, connected via Bluetooth, through the Soundbar.

### If the device fails to connect

- If the previously connected Soundbar listing (e.g. “[AV] Samsung Soundbar MSxxxx”) appears in the list, delete it.
- In “BT” mode, press and hold the  (**Source**) button for more than 5 seconds on the right side panel of the Soundbar or on the remote control to switch to “BT PAIRING” mode. Then, select “[AV] Samsung Soundbar MSxxxx” from the Bluetooth device search list.

## What are the BT READY and BT PAIRING statuses?

- **BT READY** : In this mode, you can search for previously connected TVs or connect to the Soundbar from a previously connected mobile device.
- **BT PAIRING** : In this mode, you can connect to a new device. (While in “BT” mode, press and hold the  (Source) button for more than 5 seconds on the right side of the Soundbar or on the remote control.)

## NOTES

- If asked for a PIN code when connecting a Bluetooth device, enter <0000>.
- In Bluetooth connection mode, the Bluetooth connection will be lost if the distance between the Soundbar and the Bluetooth device exceeds 10 meters.
- The Soundbar automatically turns off after 5 minutes in the Ready state.
- The Soundbar may not perform Bluetooth search or connection correctly under the following circumstances:
  - If there is a strong electrical field around the Soundbar.
  - If several Bluetooth devices are simultaneously paired with the Soundbar.
  - If the Bluetooth device is turned off, not in place, or malfunctions.
- Electronic devices may cause radio interference. Devices that generate electromagnetic waves must be kept away from the Soundbar main unit - e.g., microwaves, wireless LAN devices, etc.
- The Soundbar supports SBC data (44.1kHz, 48kHz).
- Connect only to a Bluetooth device that supports the A2DP (AV) function.
- You cannot connect the Soundbar to a Bluetooth device that supports only the HF (Hands Free) function.
- Once you have paired the Soundbar to a Bluetooth device, selecting “[AV] Samsung Soundbar MSxxxx” from the device’s scanned devices list will automatically change the Soundbar to “BT” mode.
  - Available only if the Soundbar is listed among the Bluetooth device’s paired devices.  
(The Bluetooth device and the Soundbar must have been previously paired at least once.)
- The Soundbar will appear in the Bluetooth device’s searched devices list only when the Soundbar is displaying “BT READY”.

## Disconnecting the Bluetooth device from a Soundbar

You can disconnect a Bluetooth device from the Soundbar. For instructions, see the Bluetooth device's user manual.

- The Soundbar will be disconnected.
- When the Soundbar is disconnected from the Bluetooth device, the Soundbar will display **"BT DISCONNECTED"** on the front display.

## Disconnecting the Soundbar from the Bluetooth device

Press the  (**Source**) button on the right side panel or on the remote control, and then change to any mode except **"BT"**.

- Disconnecting takes time because the Bluetooth device must receive a response from the Soundbar. (Disconnection time may differ, depending on the Bluetooth device)
- When the Soundbar is disconnected from the Bluetooth device, the Soundbar will display **"BT DISCONNECTED"** on the front display.

### **NOTES**

- In Bluetooth connection mode, the Bluetooth connection will be lost if the distance between the Soundbar and the Bluetooth device exceeds 10 meters.
- The Soundbar automatically turns off after 5 minutes in the Ready state.

### **More About Bluetooth**

Bluetooth is a technology that enables Bluetooth-compliant devices to interconnect easily with each other using a short wireless connection.

- A Bluetooth device may cause noise or malfunction, depending on usage, if:
  - A part of your body is in contact with the receiving/transmitting system of the Bluetooth device or the Soundbar.
  - It is subject to electrical variation from obstructions caused by a wall, corner, or office partition.
  - It is exposed to electrical interference from same frequency-band devices including medical equipment, microwave ovens, and wireless LANs.
- Pair the Soundbar with the Bluetooth device while they are close together.
- The further the distance between the Soundbar and Bluetooth device, the worse the quality is. If the distance exceeds the Bluetooth operational range, the connection is lost.
- In poor reception areas, the Bluetooth connection may not work properly.
- The Bluetooth connection only works when it is close to the unit. The connection will be automatically cut off if the Bluetooth device is out of range. Even within range, the sound quality may be degraded by obstacles such as walls or doors.
- This wireless device may cause electric interference during its operation.

## Method 2. Connecting via Wi-Fi (Wireless Network)

- Connect a single Soundbar to Wi-Fi to access a variety of music streaming services and Internet radio. Connect multiple Soundbars to Wi-Fi to use grouped playback or stereo sound mode.
- To connect a Soundbar to a mobile device via a wireless network (Wi-Fi), the **Samsung Multiroom** app is required.

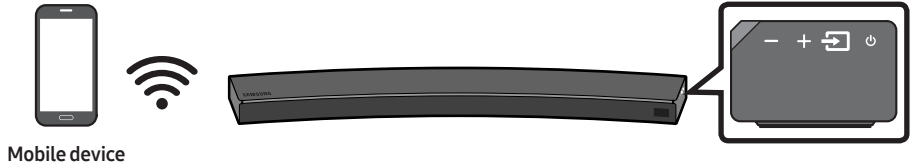

### The initial connection

1. Press the  (**Source**) button on the right side of the Soundbar or on the remote control to select "WIFI" mode.

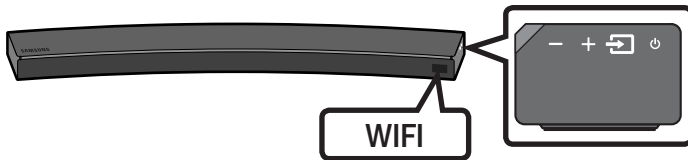

2. Install and launch the **Samsung Multiroom** app on your mobile device (e.g. smartphone or tablet).

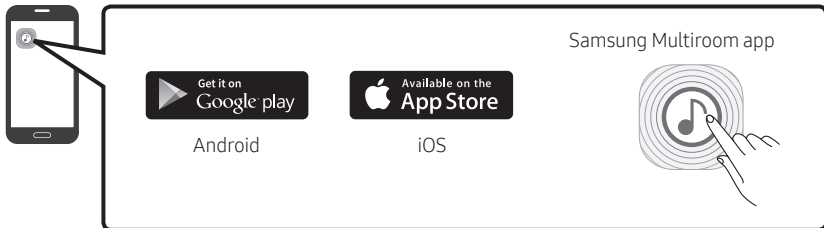

3. Follow the instructions in the app screen on the mobile device to connect the Soundbar to Wi-Fi.

## Installing an additional Soundbar when Samsung wireless speakers are already in use

1. On the Home screen of the **Samsung Multiroom** app, select **Settings** (⚙️) at the top, and then select **"Add Speaker"**.

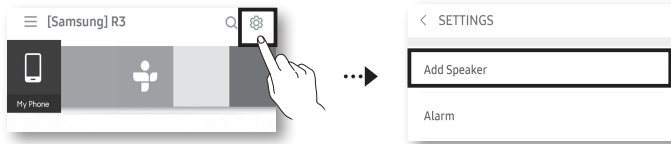

2. To connect the Soundbar to **2 Samsung wireless speakers** and configure a surround sound system, follow the steps shown below. (You cannot set up a surround sound system using one audio device and one Soundbar.)

- 1 Touch ≡ to go to the list of all speakers.
- 2 Touch ⋮ on the right of the Soundbar model name.
- 3 Touch **Surround Setup**. Select **Done** after dragging the speaker to the desired location.
- 4 The Surround connection is complete.

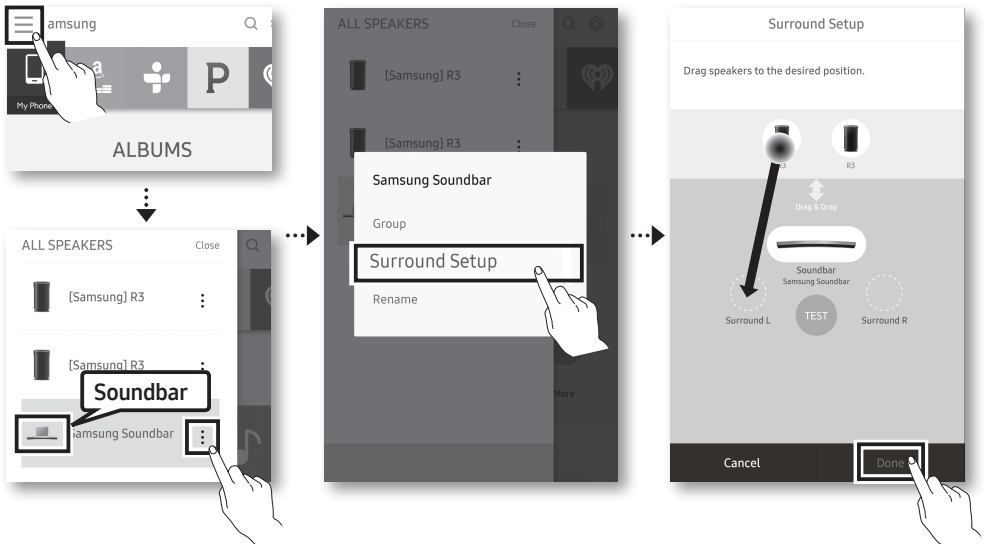





### NOTE

- To connect an additional SWA-9000S (not supplied), disconnect the Samsung wireless speakers from the Soundbar to disable the surround sound system. (If connecting the surround speakers without disconnecting SWA-9000S, sound is played via both the Samsung wireless speaker and the Surround speaker.)

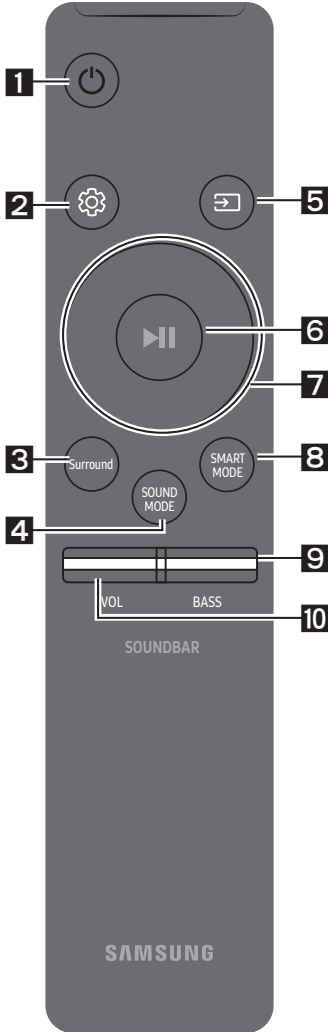



# 07 USING THE REMOTE CONTROL

## How to Use the Remote Control



<b>1</b>	 Power	Turns the Soundbar on and off.
<b>2</b>	 Sound Control	You can select from <b>TREBLE</b> , <b>SYNC</b> , <b>REAR LEVEL</b> , or <b>REAR SPEAKER ON/OFF</b> . <ul style="list-style-type: none"><li>• To adjust the <b>TREBLE</b> volume, select Sound Control <b>TREBLE</b>, and then use the <b>Up/Down</b> buttons to adjust the volume within the -6 to +6 range.</li><li>• Press and hold the  (<b>Sound Control</b>) button for about 5 seconds to adjust the sound for each frequency band. 150Hz, 300Hz, 600Hz, 1.2KHz, 2.5KHz, 5KHz, and 10KHz are selectable (<b>Left/Right</b>) and each can be adjusted to a setting between -6 to +6 (<b>Up/Down</b>).</li><li>• If the video and audio between the TV and your Soundbar are not synchronised, select <b>SYNC</b> in Sound Control, and then set audio delay between 0~300 milliseconds by using the <b>Up/Down</b> buttons.</li><li>• If surround speakers (not supplied) are connected, select <b>REAR LEVEL</b> and use the <b>Up/Down</b> buttons to adjust the volume within the -6 to +6 range. The <b>REAR SPEAKER</b> function can be turned <b>ON/OFF</b> by using the <b>Up/Down</b> buttons.</li><li>• Audio Sync is only supported in some functions.</li></ul>



<p><b>3</b></p>	 <p><b>Surround</b></p>	<p>The Surround Sound function adds depth and a sense of space to sound. Each time you press this button, ON and OFF alternate.</p> <ul style="list-style-type: none"> <li>• ON : Play sound over all the speakers.</li> <li>• OFF : You can hear the sound of the original source channel from several speakers.</li> </ul>
<p><b>4</b></p>	 <p><b>SOUND MODE</b></p>	<p>You can select the desired sound effect by choosing <b>STANDARD</b>, <b>MUSIC</b>, <b>CLEAR VOICE</b>, <b>SPORTS</b>, or <b>MOVIE</b>. Select the “<b>STANDARD</b>” mode if you want to enjoy the original sound.</p> <ul style="list-style-type: none"> <li>• <b>DRC (Dynamic Range Control)</b> Lets you apply dynamic range control to Dolby Digital tracks. If you press and hold the <b>SOUND MODE</b> button while in standby mode, DRC (Dynamic Range Control) turns on or off. With the DRC turned on, loud sound is reduced. (The sound may be distorted.)</li> </ul>
<p><b>5</b></p>	 <p><b>Source</b></p>	<p>Press to select a source connected to the Soundbar.</p> <ul style="list-style-type: none"> <li>• <b>BT PAIRING mode</b> To turn on “<b>BT PAIRING</b>” mode in “<b>BT</b>” mode, press and hold the  (<b>Source</b>) button for more than 5 seconds. See page 15 for details.</li> <li>• <b>Auto Power Down Function</b> The unit turns off automatically in the following situations. <ul style="list-style-type: none"> <li>– <b>D.IN / WIFI / BT Mode</b> : If there is no audio signal for 5 minutes.</li> <li>– <b>HDMI Mode</b> : If there is no audio signal for 15 minutes.</li> <li>– <b>AUX Mode</b> : <ul style="list-style-type: none"> <li>– If the Audio (AUX) Cable is disconnected for 5 minutes.</li> <li>– If there is no KEY input for 8 hours when the Audio (AUX) Cable is connected. (Auto Power Down function can be turned off only in that case.)</li> <li>– To turn off Auto Power Down function, while in “<b>AUX</b>” mode, press and hold the <b>▶  </b> button for 5 seconds. “<b>ON - AUTO POWER DOWN</b>” / “<b>OFF - AUTO POWER DOWN</b>” appears on the display.</li> </ul> </li> </ul> </li> </ul>
<p><b>6</b></p>	 <p><b>Play / Pause (BT/Wi-Fi)</b></p>	<p>Press the <b>▶  </b> button to pause a music file temporarily. If you press the button again, the music file plays.</p>

**7**

Up/Down/  
Left/Right



Press the indicated areas to select Up/Down/Left/Right.

Press Up/Down/Left/Right on the button to select or set functions.

- **Repeat**

To use the repeat function, press the **Up** button.

- **Music Skip**

Press the **Right** button to select the next music file. Press the **Left** button to select the previous music file.

- **Anynet+ / Auto Power Link**

You can turn Anynet+ and Auto Power Link on or off.

Anynet+ and Auto Power Link are controlled by the **Right** and **Left** buttons respectively.

- Anynet+ : If the Soundbar is connected to a Samsung TV through an HDMI cable, you can control your Soundbar with the Samsung TV's remote control. Press and hold the **Right** button for 5 seconds to toggle Anynet+ ON and OFF.
- Auto Power Link : If the Soundbar is connected to your TV through a digital optical cable, the Soundbar can automatically turn on when you turn on your TV. Press and hold the **Left** button for 5 seconds to toggle Auto Power Link ON and OFF.
- Anynet+ / Auto Power Link are set to ON by default.

**8**

SMART MODE

Automatically optimises sound effects to suit the scene currently playing. The mode turns on or off each time the button is pressed.

**9**

BASS

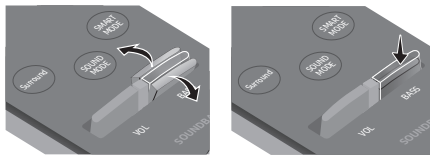

Push the button up or down to adjust the BASS volume within the -6 to +6 range.

To set the BASS volume level to 0, press the button.

- When a Subwoofer (not supplied) is connected, the BASS button switches to the Subwoofer Key. Push the button up or down to adjust the subwoofer volume either to -12 or within the -6 to +6 range. To set the subwoofer volume level to 0, press the button.

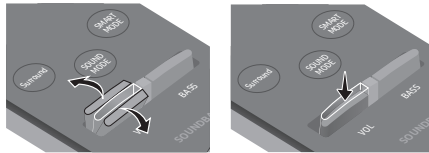
**10****VOL**

Push the button up or down to adjust the volume.

- **Mute**



Press the **VOL** button to mute the sound. Press it again to unmute the sound.

## Adjusting the Soundbar volume with a TV remote control



**Use the TV menu to set the TV speaker on a Samsung TV to external speakers.  
(For more information, see the TV's user manual.)**

- After installing the Soundbar, you can adjust the Soundbar's volume using the IR remote control that came with a Samsung TV. (If you do not want to use this function, when the Soundbar is on, press and hold the **Surround** button for 5 seconds. "**OFF-TV REMOTE**" appears in the Soundbar's display and the function turns off.) To adjust the volume using only the Samsung TV remote control, press and hold the **Surround** button for more than 5 seconds until "**SAMSUNG-TV REMOTE**" appears in the Soundbar display.
  - Each time the **Surround** button is held for 5 seconds, the mode switches in the following order: "**SAMSUNG-TV REMOTE**" (Default mode) → "**OFF-TV REMOTE**" → "**ALL-TV REMOTE**".
- To adjust the Soundbar volume with the remote control that came with a TV made by a third party manufacturer, turn the Soundbar on, press and hold the **Surround** button for 5 seconds ("**OFF-TV REMOTE**" appears on the Soundbar's display), release the **Surround** button, and then press and hold the **Surround** button again for more than 5 seconds. ("**ALL-TV REMOTE**" appears on the Soundbar's display.)
  - This function may not be available, depending on the remote control.
  - Manufacturers supporting this function:  
VIZIO, LG, Sony, Sharp, PHILIPS, PANASONIC, TOSHIBA, GRUNDIG, Hisense, RCA

## Using the Hidden Buttons

Hidden Button		Reference page
Remote Control Button	Function	
Surround	TV remote control On/Off	page 23
 (Source)	BT Paring	page 15
 (Play / Pause)	Auto Power Down On/Off (AUX mode)	page 21
Left	Auto Power Link ON/OFF	page 8
Right	Anynet+ ON/OFF	page 22
 (Sound Control)	7 Band EQ	page 20
SOUND MODE	DRC ON/OFF (Standby)	page 21

## Output specifications for the different sound effect modes

Effect		Input	Output	
			Except Wireless Rear Speaker Kit	Include Wireless Rear Speaker Kit
 Surround	ON	2.0 ch	2.0 ch	4.0 ch
		5.1 ch	3.0 ch	5.0 ch
 SOUND MODE	STANDARD	2.0 ch	2.0 ch	4.0 ch
		5.1 ch	3.0 ch	5.0 ch
	MUSIC	2.0 ch	2.0 ch	2.0 ch
		5.1 ch	3.0 ch	5.0 ch
	CLEAR VOICE	2.0 ch	3.0 ch	5.0 ch
		5.1 ch	3.0 ch	5.0 ch
	SPORTS	2.0 ch	3.0 ch	5.0 ch
		5.1 ch	3.0 ch	5.0 ch
	MOVIE	2.0 ch	3.0 ch	5.0 ch
		5.1 ch	3.0 ch	5.0 ch

- Samsung Wireless Rear Speaker Kit can be purchased separately. To purchase a Kit, contact the vendor you purchased the Soundbar from.

# 08 INSTALLING THE WALL MOUNT

## Installation Precautions

- Install on a vertical wall only.
- Do not install in a place with high temperature or humidity.
- Verify whether the wall is strong enough to support the product's weight. If not, reinforce the wall or choose another installation point.
- Purchase and use the fixing screws or anchors appropriate for the kind of wall you have (plaster board, iron board, wood, etc.). If possible, fix the support screws into wall studs.
- Purchase wall mounting screws according to the type and thickness of the wall you want to mount the Soundbar on.
  - Diameter: M5
  - Length: 35 mm or longer recommended.
- Connect cables from the unit to external devices before you install the Soundbar on the wall.
- Make sure the unit is turned off and unplugged before you install it. Otherwise, it may cause an electric shock.

## Wallmount Components

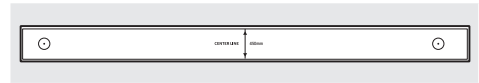

Wall Mount Guide



Holder-Screw (2 EA)

Screw (2EA)



Bracket-Wall Mount (2EA)

1. Place the **Wall Mount Guide** against the wall surface.
  - The **Wall Mount Guide** must be level.
  - If your TV is mounted on the wall, install the Soundbar at least 5 cm below the TV.

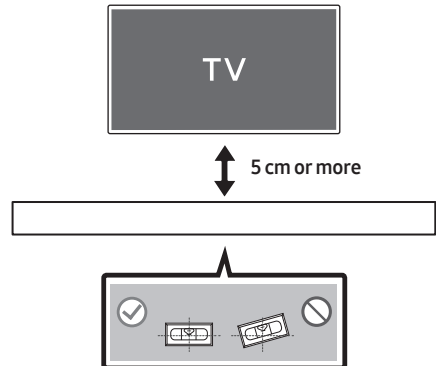

- Align the Paper Template's **Centre Line** with the centre of your TV (if you are mounting the Soundbar below your TV), and then fix the **Wall Mount Guide** to the wall using tape.
  - If you are not mounting below a TV, place the **Centre Line** in the centre of the installation area.

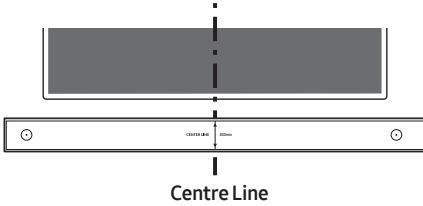

- Use a sharp object, such as a pen or pencil, to mark the holes' positions, and then remove the **Wall mount Guide**.

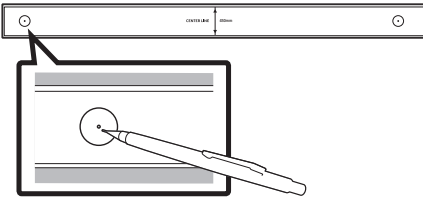

- Using an appropriately sized drill bit, drill a hole in the wall at each marking.
  - If the markings do not correspond to the positions of studs, make sure you insert appropriate anchors or mollies into the holes before you insert the support screws. If you use anchors or mollies, make sure the holes you drill are large enough for the anchors or mollies you use.

- Push a screw (not supplied) through each **Holder-Screw**, and then screw each screw firmly into a support screw hole.

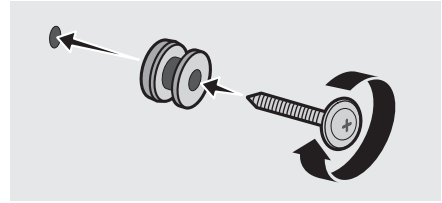

- Install the 2 **Bracket-Wall Mounts** in the correct orientation on the bottom of the Soundbar, using 2 **Screws**.

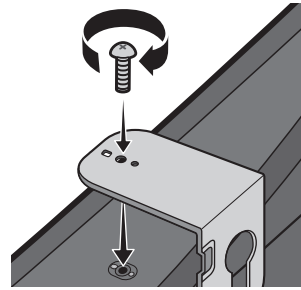

- When assembling, make sure the hanger part of the **Bracket-Wall Mounts** are located behind the rear of the Soundbar.

Rear of Soundbar

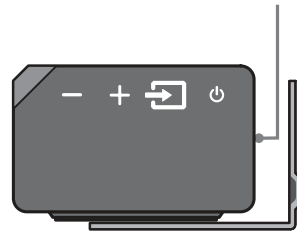

Right end of Soundbar

7. Install the Soundbar with the attached **Bracket-Wall Mounts** by hanging the **Bracket-Wall Mounts** on the **Holder-Screws** on the wall.

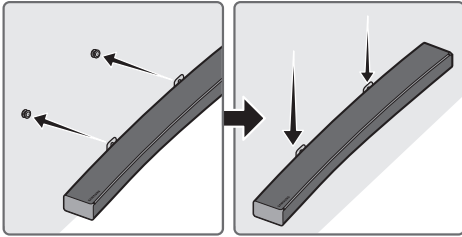

8. Slide the Soundbar down as shown below so that the **Bracket-Wall Mounts** rest securely on the **Holder-Screws**.
- Insert the **Holder-Screws** into the wide (bottom) part of the **Bracket-Wall Mounts**, and then slide the **Bracket-Wall Mounts** down so that **Bracket-Wall Mounts** rest securely on the **Holder-Screws**.

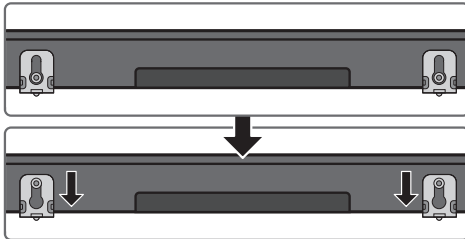

## Assembling the Holder-Cable

As shown in the image, use the supplied **Screw** to fix the **Holder-Cable** to the Soundbar, and then use the **Holder-Cable** to organise any cables.

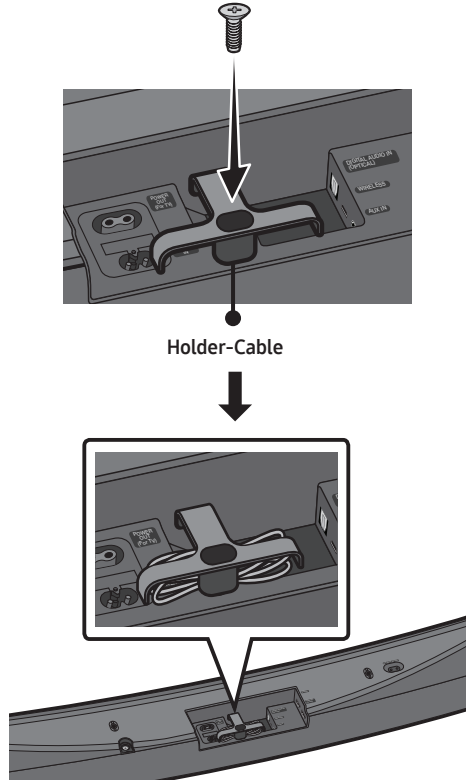

## Installing the Holder Foot

If you are not mounting the Soundbar on the wall, use the 2 provided screws to attach the 2 **Holder Feet** to the bottom of the Soundbar as shown below.

- Note that the stands of certain Samsung TVs are designed to provide a fixed place for the Soundbar. To finalise the installation of the Soundbar, you place the **Holder Feet** of the Soundbar on the legs of the stand.

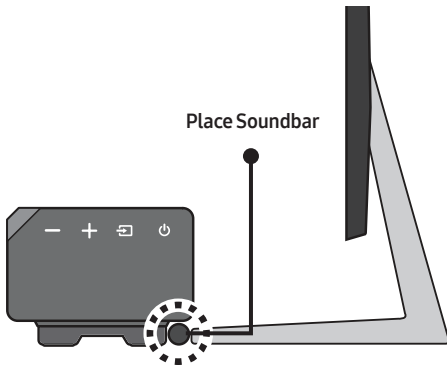
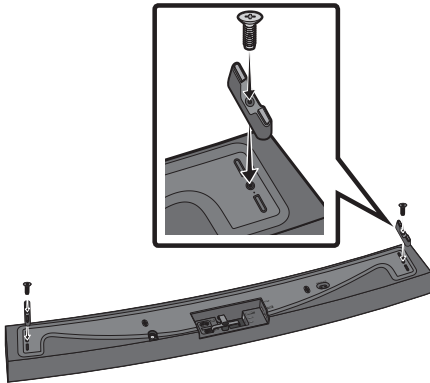

## 09 SOFTWARE UPDATE

When the Soundbar is connected to the Internet, software updates automatically occur even when the Soundbar is turned off.

- To use the Auto Update function, the Soundbar must be connected to the Internet. The Wi-Fi connection to the Soundbar will be terminated if its power cord is disconnected or the power is cut off. If the power is cut off, turn on the Soundbar and reconnect it.



# 10 TROUBLESHOOTING

Before seeking assistance, check the following.

## The unit will not turn on.

### Is the power cord plugged into the outlet?

- Connect the power plug to the outlet.

## A function does not work when the button is pressed.

### Is there static electricity in the air?

- Disconnect the power plug and connect it again.

## Sound dropouts occur in BT mode.

- See the Bluetooth connection sections on pages 9 and 15.

## Sound is not produced.

### Is the Mute function on?

- Press the **VOL** button to cancel the function.

### Is the volume set to minimum?

- Adjust the Volume.

## The remote control does not work.

### Are the batteries drained?

- Replace with new batteries.

### Is the distance between the remote control and Soundbar main unit too far?

- Move the remote control closer to the Soundbar main unit.

## Cannot connect to the TV.

### If connected via a wired network

- Check if the cable is connected correctly. (Check the port name to make sure that the cable is connected to the correct port.) (See the corresponding page regarding each connection method.)
- Press the  (**Source**) button on the right side of the Soundbar or on the remote control to check if the mode is correct.

### If connected via a wireless network

#### → Connected via Bluetooth

1. Switch the Soundbar to “**BT PAIRING**” mode, and then use the TV to search again. (See page 9 for details.)

#### → Connected via Wi-Fi

1. Check if the TV is a compatible model.
  - Only **Samsung smart TVs** released after 2014 are supported.
2. Check if the TV is connected to Wi-Fi.
  - If the TV is not connected to Wi-Fi, use the network menu on the TV to establish a connection. (See the TV user manual.)

3. Check if the Soundbar is connected to Wi-Fi.
  - When connected, the Soundbar is found in the list of speakers when **Samsung Multiroom** app is run on the mobile device (e.g. smartphone or tablet). (See page 18 for details.)
4. Check for a DFS channel.
  - If your wireless router (Wi-Fi) is using a DFS channel, you cannot establish a Wi-Fi connection between the TV and Soundbar. Contact your Internet service provider for details.

---

## HDMI

---

The terms HDMI and HDMI High-Definition Multimedia Interface, and the HDMI Logo are trademarks or registered trademarks of HDMI Licencing LLC in the United States and other countries.



- The Spotify Software is subject to third party licences found here : [www.spotify.com/connect/third-party-licenses](http://www.spotify.com/connect/third-party-licenses).
- For more information about Spotify Connect, please visit [www.spotify.com/connect](http://www.spotify.com/connect)

---

## 11 LICENCE

---



Manufactured under licence from Dolby Laboratories. Dolby, Dolby Audio and the double-D symbol are trademarks of Dolby Laboratories.



For DTS patents, see <http://patents.dts.com>.  
Manufactured under licence from DTS Licencing Limited. DTS, the Symbol, & DTS and the Symbol together are registered trademarks, and DTS 2.0 Channel is a trademark of DTS, Inc. © DTS, Inc.  
All Rights Reserved.

---

---

## 12 OPEN SOURCE LICENCE NOTICE

---

For further information on Open Sources used in this product, please visit the website: <http://opensource.samsung.com>

# 13 IMPORTANT NOTES ABOUT SERVICE

- Figures and illustrations in this User Manual are provided for reference only and may differ from actual product appearance.
- An administration fee may be charged if either
  - (a) an engineer is called out at your request and there is no defect with the product (i.e. where the user manual has not been read).
  - (b) you bring the unit to a repair centre and there is no defect with the product (i.e. where the user manual has not been read).
- You will be informed of the administration fee amount before a technician visits.

# 14 SPECIFICATIONS AND GUIDE

## Specifications

<b>GENERAL</b>	<b>Weight</b>	6.5 kg
	<b>Dimensions (W x H x D)</b>	1160.0 x 80.0 x 168.0 mm
	<b>Operating Temperature Range</b>	+5°C to +35°C
	<b>Operating Humidity Range</b>	10 % ~ 75 %
<b>HDMI</b>	<b>Video</b>	1080p, 1080i, 720p, 576p, 480p 2160p@24/25/30Hz 4:4:4 2160p@60/50Hz 4:2:0
<b>Speaker</b>		Woofer x 6, Tweeter x 3, 4ohm
<b>Supported play formats</b> (DTS 2.0 sound is played in DTS format.)		LPCM 2ch, Dolby Audio™ (supporting Dolby® Digital), DTS

## NOTES

- Samsung Electronics Co., Ltd reserves the right to change the specifications without notice.
- Weight and dimensions are approximate.
- For more information about the power supply and power consumption, refer to the label attached to the product. (Label : Bottom of the Soundbar Main Unit)

**Precaution : The product will restart automatically if you turn on/off Wi-Fi/Ethernet.**

<b>Overall Standby Power Consumption (W) (All the network ports are "ON" condition)</b>		4.0W
<b>Wi-Fi/Ethernet</b>	<b>Port deactivation method</b>	Press <b>Wi-Fi SETUP</b> button on the product for 30 seconds to turn Wi-Fi/Ethernet On / Off.
<b>Bluetooth</b>	<b>Port deactivation method</b>	Press <b>SPK ADD</b> button on the product for 30 seconds to turn Bluetooth On / Off.

### **Wireless Models (including the frequency of 5.15GHz-5.35GHz)**

- Hereby, Samsung Electronics, declares that this equipment is in compliance with the essential requirements and other relevant provisions of Directive 1999/5/EC. The original Declaration of Conformity may be found at <http://www.samsung.com>, go to Support > Search Product Support and enter the model name. This equipment may be operated in all EU countries. This equipment may only be used indoors.



### **Wireless Models (excluding the frequency of 5.15GHz-5.35GHz)**

- Hereby, Samsung Electronics, declares that this equipment is in compliance with the essential requirements and other relevant provisions of Directive 1999/5/EC. The original Declaration of Conformity may be found at <http://www.samsung.com>, go to Support > Search Product Support and enter the model name. This equipment may be operated in all EU countries.





### **[Correct disposal of batteries in this product]**

#### **(Applicable in countries with separate collection systems)**

This marking on the battery, manual or packaging indicates that the batteries in this product should not be disposed of with other household waste at the end of their working life. Where marked, the chemical symbols Hg, Cd or Pb indicate that the battery contains mercury, cadmium or lead above the reference levels in EC Directive 2006/66.

If batteries are not properly disposed of, these substances can cause harm to human health or the environment.

To protect natural resources and to promote material reuse, please separate batteries from other types of waste and recycle them through your local, free battery return system.



### **Correct Disposal of This Product (Waste Electrical & Electronic Equipment)**

#### **(Applicable in countries with separate collection systems)**

This marking on the product, accessories or literature indicates that the product and its electronic accessories (e.g. charger, headset, USB cable) should not be disposed of with other household waste at the end of their working life. To prevent possible harm to the environment or human health from uncontrolled waste disposal, please separate these items from other types of waste and recycle them responsibly to promote the sustainable reuse of material resources.

Household users should contact either the retailer where they purchased this product, or their local government office, for details of where and how they can take these items for environmentally safe recycling.

Business users should contact their supplier and check the terms and conditions of the purchase contract. This product and its electronic accessories should not be mixed with other commercial wastes for disposal.

For information on Samsung's environmental commitments and product specific regulatory obligations e.g. REACH visit:

[samsung.com/uk/aboutsamsung/samsungelectronics/corporatecitizenship/data\\_corner.html](https://samsung.com/uk/aboutsamsung/samsungelectronics/corporatecitizenship/data_corner.html)



**UNITED KINGDOM**



**EIRE**

This Samsung product is warranted for the period of twelve (12) months from the original date of purchase, against defective materials and workmanship. In the event that warranty service is required, you should return the product to the retailer from whom it was purchased. However, Samsung Authorised Dealers and Authorised Service Centres in other EC Countries will comply with the warranty on the terms issued to purchasers in the country concerned. In case of difficulty, details of our Authorised Service Centres are available from:

**Samsung Electronics U.K. Ltd**  
**Samsung Customer Support Centre**  
**Selectapost 38, Sheffield, S97 3FJ**  
**United Kingdom**

**United Kingdom**  
**Tel : 0330 SAMSUNG (7267864)**  
**[www.samsung.com/uk/support](http://www.samsung.com/uk/support)**

**EIRE**  
**Tel : 0818 717100**  
**[www.samsung.com/ie/support](http://www.samsung.com/ie/support)**

#### ■ WARRANTY CONDITIONS

1. The warranty is only valid if, when warranty service is required, the warranty card is fully and properly completed and is presented with the original invoice or sales slip or confirmation, and the serial number on the product has not been defaced.
2. Samsung's obligations are limited to the repair or, at its discretion, replacement of the product or the defective part.
3. Warranty repairs must be carried out by Authorised Samsung Dealers or Authorised Service Centres. No re-imbusement will be made for repairs carried out by non Samsung Dealers and, any such repair work and damage to the products caused by such repair work will not be covered by this warranty.

4. This product is not considered to be defective in materials nor workmanship by reason that it requires adaptation in order to conform to national or local technical or safety standards in force in any Country other than the one for which the product was originally designed and manufactured. This warranty will not cover, and no re-imbusement will be made for such adaptation nor any damage which may result.
5. This warranty covers none of the following:
  - a) Periodic check ups, maintenance and repair or replacement of parts due to normal wear and tear.
  - b) Cost relating to transport, removal or installation of the product.
  - c) Misuse, including the failure to use this product for its normal purposes or incorrect installation.
  - d) Damage caused by Lightning, Water, Fire, Acts of God, War, Public Disturbances, incorrect mains voltage, improper ventilation or any other cause beyond the control of Samsung.
6. This warranty is valid for any person who legally acquired possession of the product during the warranty period.
7. The consumers statutory rights in any applicable national legislation whether against the retailer arising from the purchase contract or otherwise are not affected by this warranty. Unless there is national legislation to the contrary, the rights under this warranty are the consumers sole rights and Samsung, its subsidiaries and distributors shall not be liable for indirect or consequential loss or any damage to records, compact discs, videos or audio taper or any other related equipment or material.

**SAMSUNG ELECTRONICS (U.K.) LTD.**

# SAMSUNG

© 2017 Samsung Electronics Co., Ltd. All rights reserved.

## Contact SAMSUNG WORLD WIDE

If you have any questions or comments relating to Samsung products, please contact the SAMSUNG customer care Centre.

Country	Contact Centre ☎	Web Site
■ Europe		
U.K	0330 SAMSUNG (7267864)	<a href="http://www.samsung.com/uk/support">www.samsung.com/uk/support</a>
EIRE	0818 717100	<a href="http://www.samsung.com/ie/support">www.samsung.com/ie/support</a>
GERMANY	0180 6 SAMSUNG bzw. 0180 6 7267864* (*0,20 €/Anruf aus dem dt. Festnetz, aus dem Mobilfunk max. 0,60 €/Anruf)	<a href="http://www.samsung.com/de/support">www.samsung.com/de/support</a>
FRANCE	0148 63 00 00	<a href="http://www.samsung.com/fr/support">www.samsung.com/fr/support</a>
ITALIA	800-SAMSUNG (800.7267864)	<a href="http://www.samsung.com/it/support">www.samsung.com/it/support</a>
SPAIN	34902172678	<a href="http://www.samsung.com/es/support">www.samsung.com/es/support</a>
PORTUGAL	808 20 7267	<a href="http://www.samsung.com/pt/support">www.samsung.com/pt/support</a>
LUXEMBURG	261 03 710	<a href="http://www.samsung.com/be_fr/support">www.samsung.com/be_fr/support</a>
NETHERLANDS	0900-SAMSUNG (0900-7267864) (€ 0,10/Min)	<a href="http://www.samsung.com/nl/support">www.samsung.com/nl/support</a>
BELGIUM	02-201-24-18	<a href="http://www.samsung.com/be/support">www.samsung.com/be/support</a> (Dutch) <a href="http://www.samsung.com/be_fr/support">www.samsung.com/be_fr/support</a> (French)
NORWAY	815 56480	<a href="http://www.samsung.com/no/support">www.samsung.com/no/support</a>
DENMARK	70 70 19 70	<a href="http://www.samsung.com/dk/support">www.samsung.com/dk/support</a>
FINLAND	030-6227 515	<a href="http://www.samsung.com/fi/support">www.samsung.com/fi/support</a>
SWEDEN	0771 726 7864 (0771-SAMSUNG)	<a href="http://www.samsung.com/se/support">www.samsung.com/se/support</a>
POLAND	801-172-678* lub +48 22 607-93-33* * (koszt połączenia według taryfy operatora)	<a href="http://www.samsung.com/pl/support">www.samsung.com/pl/support</a>
HUNGARY	0680SAMSUNG (0680-726-786) 0680PREMIUM (0680-773-648)	<a href="http://www.samsung.com/hu/support">www.samsung.com/hu/support</a>

Country	Contact Centre ☎	Web Site
AUSTRIA	0800-SAMSUNG (0800-7267864) [Only for Premium HA] 0800-366661 [Only for Dealers] 0810-112233	<a href="http://www.samsung.com/at/support">www.samsung.com/at/support</a>
SWITZERLAND	0800 726 78 64 (0800-SAMSUNG)	<a href="http://www.samsung.com/ch/support">www.samsung.com/ch/support</a> (German) <a href="http://www.samsung.com/ch_fr/support">www.samsung.com/ch_fr/support</a> (French)
CZECH	800 - SAMSUNG (800-726786)	<a href="http://www.samsung.com/cz/support">www.samsung.com/cz/support</a>
SLOVAKIA	0800 - SAMSUNG (0800-726 786)	<a href="http://www.samsung.com/sk/support">www.samsung.com/sk/support</a>
CROATIA	072 726 786	<a href="http://www.samsung.com/hr/support">www.samsung.com/hr/support</a>
BOSNIA	055 233 999	<a href="http://www.samsung.com/support">www.samsung.com/support</a>
MONTENEGRO	020 405 888	<a href="http://www.samsung.com/support">www.samsung.com/support</a>
SLOVENIA	080 697 267 (brezplačna številka)	<a href="http://www.samsung.com/si">www.samsung.com/si</a>
SERBIA	011 321 6899	<a href="http://www.samsung.com/rs/support">www.samsung.com/rs/support</a>
BULGARIA	*3000 Цена в мрежата 0800 111 31, Безплатна телефонна линия	<a href="http://www.samsung.com/bg/support">www.samsung.com/bg/support</a>
ROMANIA	*8000 (apel in retea) 08008-726-78-64 (08008-SAMSUNG) Apel GRATUIT	<a href="http://www.samsung.com/ro/support">www.samsung.com/ro/support</a>
CYPRUS	8009 4000 only from landline, toll free	<a href="http://www.samsung.com/gr/support">www.samsung.com/gr/support</a>
GREECE	80111-SAMSUNG (80111 726 7864) only from land line (+30) 210 6897691 from mobile and land line	<a href="http://www.samsung.com/gr/support">www.samsung.com/gr/support</a>
LITHUANIA	8-800-77777	<a href="http://www.samsung.com/lt/support">www.samsung.com/lt/support</a>
LATVIA	8000-7267	<a href="http://www.samsung.com/lv/support">www.samsung.com/lv/support</a>
ESTONIA	800-7267	<a href="http://www.samsung.com/ee/support">www.samsung.com/ee/support</a>