

UBD-K8500

Ultra HD Blu-ray Player

user manual

imagine the possibilities

Thank you for purchasing this Samsung product.
To receive more complete service,
please register your product at
www.samsung.com/register

SAMSUNG

Safety Information

Warning

CAUTION

RISK OF ELECTRIC SHOCK. DO NOT OPEN.

CAUTION : TO REDUCE THE RISK OF ELECTRIC SHOCK, DO NOT REMOVE THE COVER (OR BACK). THERE ARE NO USER SERVICEABLE PARTS INSIDE. REFER ALL SERVICING TO QUALIFIED PERSONNEL.



This symbol indicates that high voltage is present inside. It is dangerous to make any kind of contact with any internal part of this product.



This symbol indicates that important literature concerning operation and maintenance has been included with this product.

- The slots and openings in the cabinet and in the back or bottom are provided for necessary ventilation. To ensure reliable operation of this apparatus, and to protect it from over heating, these slots and openings must never be blocked or covered.
 - Do not place this apparatus in a confined space, such as a bookcase, or built-in cabinet, unless proper ventilation is provided.
 - Do not place this apparatus near or over a radiator or heat register, or where it is exposed to direct sunlight.
 - Do not place vessels (vases etc.) containing water on this apparatus. A water spill can cause a fire or electric shock.
- Do not expose this apparatus to rain or place it near water (near a bathtub, washbowl, kitchen sink, or pool, etc.). If this apparatus accidentally gets wet, unplug it and contact an authorized dealer immediately.
- This apparatus uses batteries. In your community, there might be environmental regulations that require you to dispose of these batteries properly. Please contact your local authorities for disposal or recycling information.
- Do not overload wall outlets, extension cords or adaptors beyond their capacity, since this can result in fire or electric shock.
- Route power-supply cords so that they are not likely to be walked on or pinched by items placed on or against them. Pay particular attention to cords at the plug end, at wall outlets, and the point where they exit from the apparatus.
- To protect this apparatus from a lightning storm, or when it is left unattended and unused for long periods of time, unplug it from the wall outlet and disconnect the antenna or cable system. This will prevent damage to the set due to lightning and power line surges.
- Before connecting the AC power cord to the DC adaptor outlet, make sure the voltage designation of the DC adaptor corresponds to the local electrical supply.
- Never insert anything metallic into the open parts of this apparatus. Doing so may create a danger of electric shock.
- To avoid electric shock, never touch the inside of this apparatus. Only a qualified technician should open this apparatus.
- Make sure to plug the power cord in until it is firmly seated. When unplugging the power cord from a wall outlet, always pull on the power cord's plug. Never unplug by pulling on the power cord. Do not touch the power cord with wet hands.
- If this apparatus does not operate normally - in particular, if there are any unusual sounds or smells coming from it - unplug it immediately and contact an authorized dealer or service center.

- Maintenance of Cabinet.
 - Before connecting other components to this product, be sure to turn them off.
 - If you move your product suddenly from a cold place to a warm place, condensation may occur on the operating parts and lens and cause abnormal disc playback. If this occurs, unplug the product, wait for two hours, and then connect the plug to the power outlet. Then, insert the disc, and try to play back again.
- Be sure to pull the power plug out of the outlet if the product is to remain unused or if you are leaving the house for an extended period of time (especially when children, elderly, or disabled people will be left alone in the house).
 - Accumulated dust can cause an electric shock, an electric leakage, or a fire by causing the power cord to generate sparks and heat or the insulation to deteriorate.
- Contact an authorized service center for information if you intend to install your product in a location with heavy dust, high or low temperatures, high humidity, chemical substances, or where it will operate 24 hours a day such as in an airport, a train station, etc. Failing to do so may lead to serious damage to your product.
- Use only a properly grounded plug and wall outlet.
 - An improper ground may cause electric shock or equipment damage. (Class 1 Equipment only)
- To turn this apparatus off completely, you must disconnect it from the wall outlet. Consequently, the wall outlet and power plug must be readily accessible at all times.
- Do not allow children to hang on the product.
- Store the accessories (battery, etc.) in a location safely out of the reach of children.
- Do not install the product in an unstable location such as a shaky self, a slanted floor, or a location exposed to vibration.
- Do not drop or strike the product. If the product is damaged, disconnect the power cord and contact a service center.
- To clean this apparatus, unplug the power cord from the wall outlet and wipe the product using a soft, dry cloth. Do not use any chemicals such as wax, benzene, alcohol, thinners, insecticide, air fresheners, lubricants, or detergent. These chemicals can damage the appearance of the product or erase the printing on the product.
- Do not expose this apparatus to dripping or splashing. Do not put objects filled with liquids, such as vases on the apparatus.
- Do not dispose of batteries in a fire.
- Do not plug multiple electric devices into the same wall socket. Overloading a socket can cause it to overheat, resulting in a fire.
- There is danger of an explosion if you replace the batteries used in the remote with the wrong type of battery. Replace only with the same or equivalent type.
- **WARNING - TO PREVENT THE SPREAD OF FIRE, KEEP CANDLES AND OTHER ITEMS WITH OPEN FLAMES AWAY FROM THIS PRODUCT AT ALL TIMES.**

- **WARNING**
 - This product contains chemicals known to the State of California to cause cancer and birth defects or other reproductive harm.
 - To reduce the risk of fire or electric shock, do not expose this appliance to rain or moisture.

FCC NOTE (for U.S.A)

This equipment has been tested and found to comply with the limits for a Class B digital device, pursuant to Part 15 of the FCC rules. These limits are designed to provide reasonable protection against harmful interference in a residential installation. This equipment generates, uses and can radiate radio frequency energy and, if not installed and used in accordance with the instructions, may cause harmful interference to radio or television reception, which can be determined by turning the equipment off and on. The user is encouraged to try to correct the interference by one or more of the following measures.

Safety Information

- Reorienting or relocating the receiving antenna.
- Increasing the separation between the equipment and receiver.
- Connecting this equipment to an outlet that is on a different circuit than the one the receiver is connected to.
- Consulting the dealer or an experienced radio/TV technician for help.

This class B digital product meets all requirements of the Canadian Interference - Causing Equipment Regulations.

CLASS 1 LASER product

This Compact Disc player is classified as a CLASS 1 LASER product. Use of controls, adjustments or performance of procedures other than those specified herein may result in hazardous radiation exposure.

Complies with 21CFR 1040.10 except for deviations pursuant to Laser Notice No. 50, dated June 24, 2007.

DANGER :

- VISIBLE AND INVISIBLE LASER RADIATION WHEN OPEN. AVOID DIRECT EXPOSURE TO BEAM. (FDA 21 CFR)

CAUTION :

- CLASS 3B VISIBLE AND INVISIBLE LASER RADIATION WHEN OPEN. AVOID EXPOSURE TO THE BEAM. (IEC 60825-1)
- THIS PRODUCT UTILIZES A LASER. USE OF CONTROLS OR ADJUSTMENTS OR PERFORMANCE OF PROCEDURES OTHER THAN THOSE SPECIFIED HEREIN MAY RESULT IN HAZARDOUS RADIATION EXPOSURE. DO NOT OPEN THE COVER. DO NOT REPAIR THE PRODUCT YOURSELF. REFER SERVICING TO QUALIFIED PERSONNEL.

CLASS 1	LASER PRODUCT
KLASSE 1	LASER PRODUKT
LUOKAN 1	LASER LAITE
KLASS 1	LASER APPARAT
PRODUCTO	LÁSER CLASE 1

| NOTE |

- ▶ If the Region number of an Ultra HD Blu-ray Disc/Blu-ray Disc/DVD does not correspond to the Region number of this product, the product cannot play the disc.

Precautions

Important Safety Instructions

Read these operating instructions carefully before using the unit. Follow all the safety instructions listed below.

Keep these operating instructions handy for future reference.

1. Read these instructions.
2. Keep these instructions.
3. Heed all warnings.
4. Follow all instructions.
5. Do not use this apparatus near water.
6. Clean only with a dry cloth.
7. Do not block any ventilation openings. Install in accordance with the manufacturer's instructions.
8. Do not install near any heat sources such as radiators, heat registers, stoves, or other apparatus (including AV receivers) that produce heat.
9. Do not defeat the safety purpose of the polarized or grounding-type plug. A polarized plug has two blades with one wider than the other. A grounding type plug has two blades and a third grounding prong. The wide blade or the third prong are provided for your safety. If the provided plug does not fit into your outlet, consult an electrician for replacement of the obsolete outlet.
10. Protect the power cord from being walked on or pinched particularly at plugs, convenience receptacles, and the point where it exits the apparatus.
11. Only use attachments/accessories specified by the manufacturer.

12. Use only with the cart, stand, tripod, bracket, or table specified by the manufacturer, or sold with the apparatus. When a cart is used, use caution when moving the cart/apparatus combination to avoid injury from tip-over.
13. Unplug this apparatus during lightning storms or when unused for long periods of time.
14. Refer all servicing to qualified service personnel. Servicing is required when the apparatus has been damaged in any way, such as when the power-supply cord or plug is damaged, liquid has been spilled or objects have fallen into the apparatus, the apparatus has been exposed to rain or moisture, does not operate normally, or has been dropped.



- Do not use the 3D function or 3D Active Glasses while walking or moving around. Using the 3D function or 3D Active Glasses while moving around may cause you to bump into objects, trip, and/or fall, and cause serious injury.
- If you want to enjoy 3D content, connect a 3D device (3D compliant AV receiver or TV) to the player's HDMI OUT port using a high-speed HDMI cable. Put on 3D glasses before playing the 3D content.
- The player outputs 3D signals only through an HDMI cable connected to the HDMI OUT port.
- The video resolution in 3D play mode is determined by the resolution of the original 3D video. You can not change the resolution.
- Some functions such as BD Wise, screen size adjustment, and resolution adjustment may not operate properly in 3D play mode.
- You must use a high-speed HDMI cable for proper output of the 3D signal.
- Stay at least three times the width of the screen from the TV when watching 3D images. For example, if you have a 46-inch screen, stay 138 inches (11.5 feet) from the screen.
- Place the 3D video screen at eye level for the best 3D picture.
- When the player is connected to some 3D devices, the 3D effect may not function properly.
- This player does not convert 2D content into 3D.
- "Blu-ray 3D" and "Blu-ray 3D" logo are trademarks of the Blu-ray Disc Association.

Using the 3D function

IMPORTANT HEALTH AND SAFETY INFORMATION FOR 3D PICTURES.

Read and understand the following safety information before using the 3D function.

- Some viewers may experience discomfort while viewing 3D TV such as dizziness, nausea, and headaches.
If you experience any such symptom, stop viewing 3D TV, remove the 3D Active Glasses, and rest.
- Watching 3D images for an extended period of time may cause eye strain. If you feel eye strain, stop viewing 3D TV, remove your 3D Active Glasses, and rest.
- A responsible adult should frequently check on children who are using the 3D function.
If there are any reports of tired eyes, headaches, dizziness, or nausea, have the child stop viewing 3D TV and rest.
- Do not use the 3D Active Glasses for other purposes (such as general eyeglasses, sunglasses, protective goggles, etc.).

Contents

SAFETY INFORMATION

- 2 Warning
- 4 Precautions
- 4 Important Safety Instructions
- 5 Using the 3D function

GETTING STARTED

- 8 Accessories
- 9 Front Panel
- 9 Rear Panel
- 10 Remote Control
- 10 Tour of the Remote Control

CONNECTIONS

- 12 Connecting to a TV
- 13 Connecting to an Audio System
- 13 **Method 1** Connecting to an HDMI (HDR) compatible AV receiver that supports pass through
- 14 **Method 2** Connecting to an HDMI compatible AV receiver that does not support pass through
- 15 **Method 3** Connecting to an AV receiver with a Digital Optical Cable
- 16 Connecting to a Network Router
- 16 Wired Network
- 16 Wireless Network

SETTINGS

- 17 The Initial Settings Procedure
- 17 The Home Screen
- 18 Accessing the Settings Screen
- 18 Buttons on the Remote Control Used for the Settings Menu
- 19 Settings Menu Functions
- 19 Picture
- 20 Sound
- 21 Network
- 21 Smart Hub
- 21 System
- 23 Support
- 23 Networks and the Internet
- 23 Configuring Your Network Connection
- 26 Upgrading Software
- 27 Update now
- 27 Auto Update

MEDIA PLAY

- 28 Playing Commercial Discs
- 28 Disc Storage & Management
- 28 Playing Photos, Videos, and Music (Multimedia)
 - 29 Playing Media Content Saved on a USB Device
 - 29 Playing Media Content Saved in a Computer/Mobile Device
- 30 Playing a Disc with User Recorded Content
- 31 Controlling Video Playback
 - 31 Buttons on the Remote Control used for Video Playback
 - 32 Using the Settings Menu During Playback
 - 34 Using the Sort by & Options Menus
- 34 Controlling Music Playback
 - 34 Buttons on the Remote Control used for Music Playback
 - 35 Using the Options Menu During Playback
 - 35 Using the Sort by & Options Menus on a File Screen
 - 36 Repeating Tracks on an Audio CD
 - 36 Shuffling Tracks on an Audio CD
 - 36 Creating a Playlist from an Audio CD
 - 37 Ripping
- 37 Playing Photo Contents
 - 37 Using the Tools Menu During Playback
 - 38 Using the Sort by & Options Menus
- 39 Send files
 - 39 Copying Videos, Music or Photos
 - 39 Using the Send Function

NETWORK SERVICES

- 40 Creating a Samsung Account
- 40 Before Using Samsung Apps
- 41 Using Samsung Apps
 - 41 The Samsung Apps Screen at a Glance
 - 42 Starting an Application
- 43 Screen Mirroring
- 44 Using the Web Browser
 - 44 Link Browsing and Pointer Browsing
 - 44 The Control Panel at a Glance
 - 46 Using the Setting Menu
- 48 Linking Your Internet Service Accounts to the Product
- 48 BD-LIVE™



APPENDIX

- 49 Additional Information
 - 49 Notes
 - 52 Resolution according to the contents type
 - 53 Digital Output Selection
- 54 Troubleshooting
 - 57 Disc and Format Compatibility
 - 57 Disc types and contents your product can play
 - 57 Disc types your product cannot play
 - 58 Region Code
 - 58 Logos of Discs the product can play
 - 59 Supported Formats
- 63 Compliance and Compatibility Notice
- 64 Copy Protection
- 64 Network Service Disclaimer
- 65 Licenses
- 66 Specifications

Getting Started

Accessories

Check for the supplied accessories shown below.

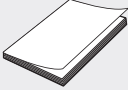
	
<p>Lithium Battery (4301-001042)</p>	
	
<p>Power Cable (3903-000853)</p>	
	<p>Remote Control (AK59-00179A)</p>
<p>User Manual (AK68-02641A)</p>	



WARNING, DO NOT INGEST BATTERY, CHEMICAL BURN HAZARD,

The remote control supplied with this product contains a coin/button cell battery.

If the coin/button cell battery is swallowed, it can cause severe internal burns in just 2 hours and can lead to death. Keep new and used batteries away from children. If the battery compartment does not close securely, stop using the remote control and keep it away from children. If you think a child has swallowed a coin/button battery or placed it inside any part of his or her body, seek immediate medical attention.

Front Panel

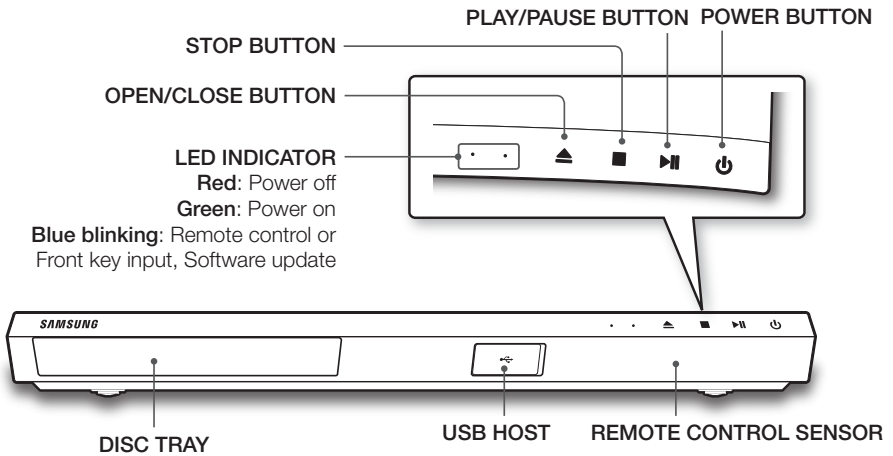

| NOTES |

- ▶ To upgrade the product's software through the **USB HOST** jack, you must use a USB memory stick.
- ▶ When the product displays an Ultra HD Blu-ray or standard Blu-ray Disc's menu, you cannot start the movie by pressing the Play button on the product or the remote control. To play the movie, you must select Play Movie or Start in the disc's menu, and then press the **OK** button on the remote control.

Rear Panel

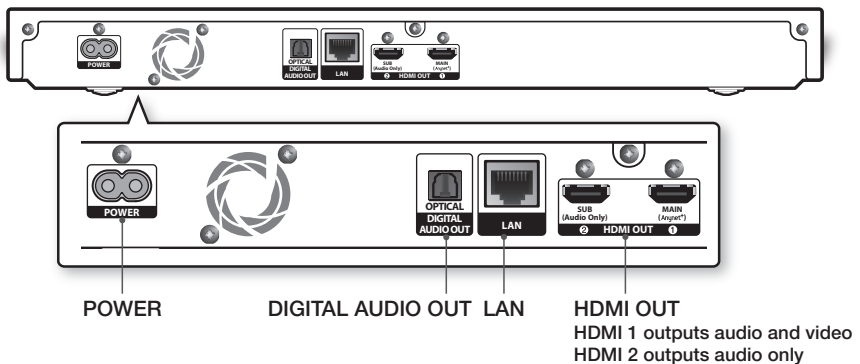

| NOTE |

- ▶ To use the **Anynet+ (HDMI-CEC)** function, connect an HDMI cable to the HDMI 1 terminal. If you connect the cable to the HDMI 2 terminal, the **Anynet+ (HDMI-CEC)** function will not be available.

Getting Started

Remote Control

| NOTE |

- ▶ Previous BD-Player remote controls may not be compatible with this player.

Tour of the Remote Control

Turns the player on and off.

Press to play disc or files.
or
Press to pause playing.

Press to move to the Home screen.

Use to enter the disc menu.

Use to select menu items and change menu values.

Return to the previous menu.

Turns the TV on and off.

After setup, allows you to set the input source on your TV.

Press to open and close the disc tray.

Press to stop a disc or file.

Press to skip chapters. Press and hold to search backwards (◀◀) or forwards (▶▶).

Use to enter the Popup menu/Title menu.

Use to display playback information.
or
Press and hold this button to display the number keypad on the screen.

Press to use the Tools menu.

These buttons are used both for menus on the player and also several Ultra HD Blu-ray Disc or Blu-ray Disc functions.

TV volume adjustment.

| NOTE |

- ▶ Out of the box, the TV volume, source, and on/off buttons only work with Samsung TVs. To use these buttons with another TV brand, enter the appropriate TV Control Code listed on page 11.

Installing Batteries

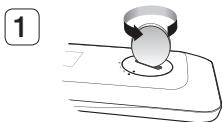

Use a coin to turn the remote control cover counterclockwise to remove it as shown in the figure above.

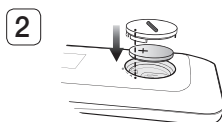

Insert a 3V lithium battery. Keep the positive (+) pole facing up when inserting the battery. Put the battery cover on and align the '●' marks side by side as shown in the figure above.

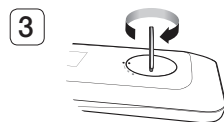

Use a coin to turn the cover clockwise as far as it will go to fix it in place.

Using Remote Control Buttons to Enter TV Codes

1. Press and hold the **TV POWER** button.
2. While holding the **TV POWER** button, press the buttons on the remote that correspond to a two-digit TV Code from the list below. Use the illustration to the right as a guide.



For example: To enter **01**, press the **TOOLS** button and then press the **DISC MENU** button. Note that some TV brands have more than one 2-digit code. If the first code does not work, try the next.

TV Control Codes

Brand	Codes
SAMSUNG	01, 02, 03, 04, 05, 06, 07, 08, 09
AIWA	82
ANAM	10, 11, 12, 13, 14, 15, 16, 17, 18
BANG & OLUFSEN	57
BLAUPUNKT	71
BRANDT	73
BRIONVEGA	57
CGE	52
CONTINENTAL EDISON	75
DAEWOO	19, 20, 23, 24, 25, 26, 27, 28, 29, 30, 31, 32, 33, 34
EMERSON	64
FERGUSON	73
FINLUX	06, 49, 57
FORMENTI	57
FUJITSU	84
GRADIENTE	70
GRUNDIG	49, 52, 71
HITACHI	60, 72, 73, 75
IMPERIAL	52
JVC	61, 79
LG	06, 19, 20, 21, 22, 78

Brand	Codes
LOEWE	06, 69
LOEWE OPTA	06, 57
MAGNAVOX	40
METZ	57
MITSUBISHI	06, 48, 62, 65
MIVAR	52, 77
NEC	83
NEWSAN	68
NOBLEX	66
NOKIA	74
NORDMENDE	72, 73, 75
PANASONIC	13, 53, 54, 74, 75
PHILIPS	06, 56, 57
PHONOLA	72, 73, 75
PIONEER	58, 59, 73, 74
RADIOLA	06, 56
RADIOMARELLI	57
RCA	45, 46
REX	74
SABA	57, 72, 73, 74, 75
SALORA	74
SANYO	41, 42, 43, 44, 48
SCHNEIDER	06
SELECO	74
SHARP	36, 37, 38, 39, 48
SIEMENS	71
SINGER	57
SINUDYNE	57
SONY	35, 48
TELEAVA	73
TELEFUNKEN	67, 73, 75, 76
THOMSON	72, 73, 75
THOMSON ASIA	80, 81
TOSHIBA	47, 48, 49, 50, 51, 52
WEGA	57
YOKO	06
ZENITH	63

Connections

Connecting to a TV

Connect an HDMI cable (not supplied) from the **HDMI OUT** jack on the back of the product to the **HDMI IN** jack on your TV.

- Do not connect the power cord to the wall outlet until you have made all the other connections.
- When you change the connections, turn off all devices before you start.

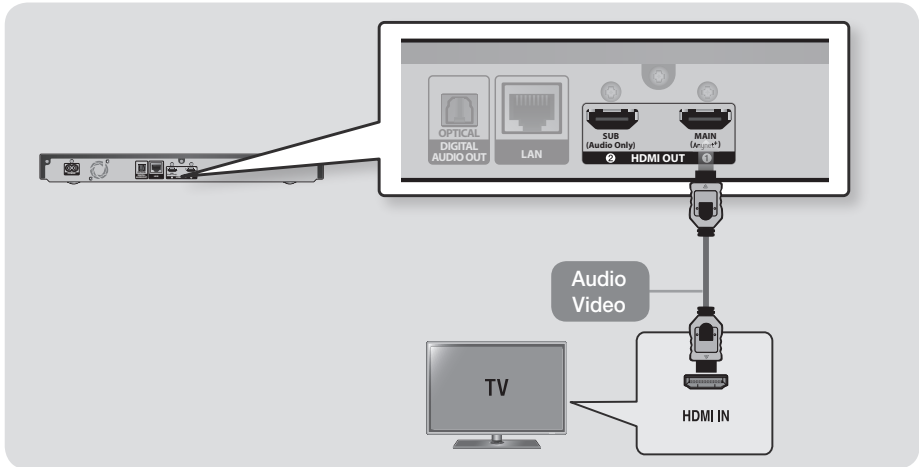

| NOTES |

- ▶ To use the **Anynet+ (HDMI-CEC)** function, connect the HDMI cable to the HDMI 1 terminal.
If you connect the cable to the HDMI 2 terminal, the **Anynet+ (HDMI-CEC)** function will not be available.
 - The HDMI 2 terminal does not output a video signal.
- ▶ If you use an HDMI-to-DVI cable to connect to your display device, you must also connect the **DIGITAL AUDIO OUT** on the product to an audio system to hear audio.
- ▶ An HDMI cable outputs digital video and audio, so you don't need to connect an audio cable.
- ▶ Depending on your TV, certain HDMI output resolutions may not work. Please refer to the user manual of your TV.
- ▶ When you connect the product to your TV using an HDMI cable or to a new TV, and then turn it on for the first time, the product automatically sets the HDMI output resolution to the highest supported by the TV.
- ▶ A long HDMI cable may cause screen noise. If this occurs, set **HDMI Deep Color** to **Off** in the menu.
- ▶ To view video in the HDMI 720p, 1080i, 1080p or 2160p output mode, you must use a high speed (category 2) HDMI cable.
- ▶ HDMI outputs only a pure digital signal to the TV.
If your TV does not support HDCP (High-bandwidth Digital Content Protection), random noise appears on the screen.
- ▶ If your TV does not support HDCP (High-bandwidth Digital Content Protection) version 2.2, some of Ultra HD Blu-ray titles may play at the 1080p resolution.

- ▶ This product supports the HDR function. (HDR: High Dynamic Range is a technique used in imaging to reproduce a greater dynamic range of luminosity than is possible with conventional imaging devices.)
 - To take advantage of the HDR function, you need HDR content, a TV supporting HDR, and a high-speed HDMI cable.
 - Connect the player to an HDMI input terminal on the TV that supports the HDR function using the high speed HDMI cable.
 - Use the TV's menu to activate the HDR related function. For further information, refer to the TV's user manual.

Connecting to an Audio System

You can connect this product to an audio system using the methods illustrated below.

- Do not connect the power cord to the wall outlet until you have made all the other connections.
- When you change the connections, turn off all devices before you start.

Method 1 Connecting to an HDMI (HDR) compatible AV receiver that supports pass through

- Connect an HDMI cable (not supplied) from the **HDMI OUT 1** jack on the back of the product to the **HDMI IN** jack on your receiver. Connect another HDMI cable from the **HDMI OUT** jack of your receiver to the **HDMI IN** jack of your TV.
- Your receiver must have UHD pass through capability to pass through UHD video content.

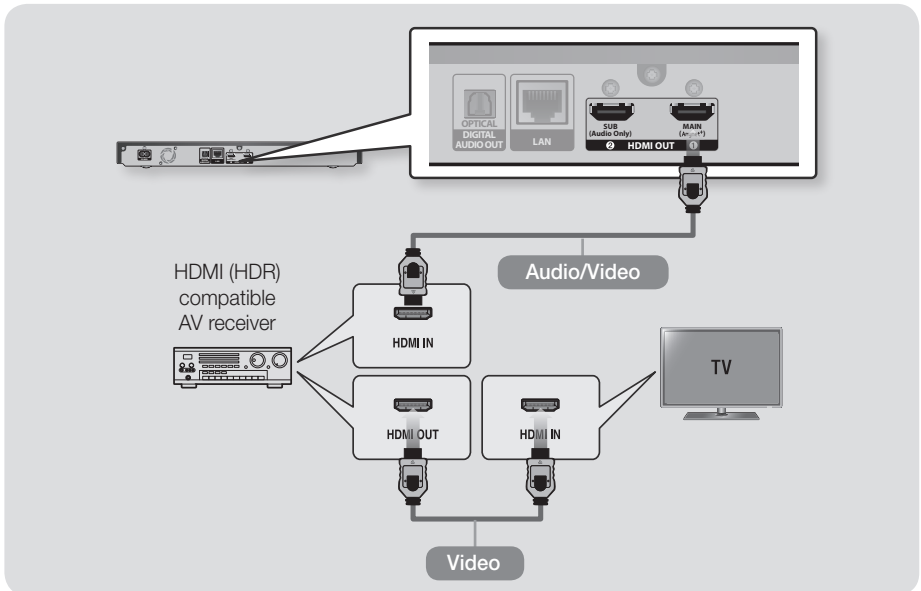

| NOTE |

- ▶ If the AAC 2.0 was applied to the contents that you want to play, it may not be displayed on the screen depending on the AV receiver connected. For more detailed information, refer to the user manual of your AV receiver.

Connections

Method 2 Connecting to an HDMI compatible AV receiver that does not support pass through

- Connect an HDMI cable (not supplied) from the **HDMI OUT 1** jack on the back of the product to the **HDMI IN** jack on your TV. Connect another HDMI cable from the **HDMI OUT 2** jack on the product to the **HDMI IN** jack on your receiver.

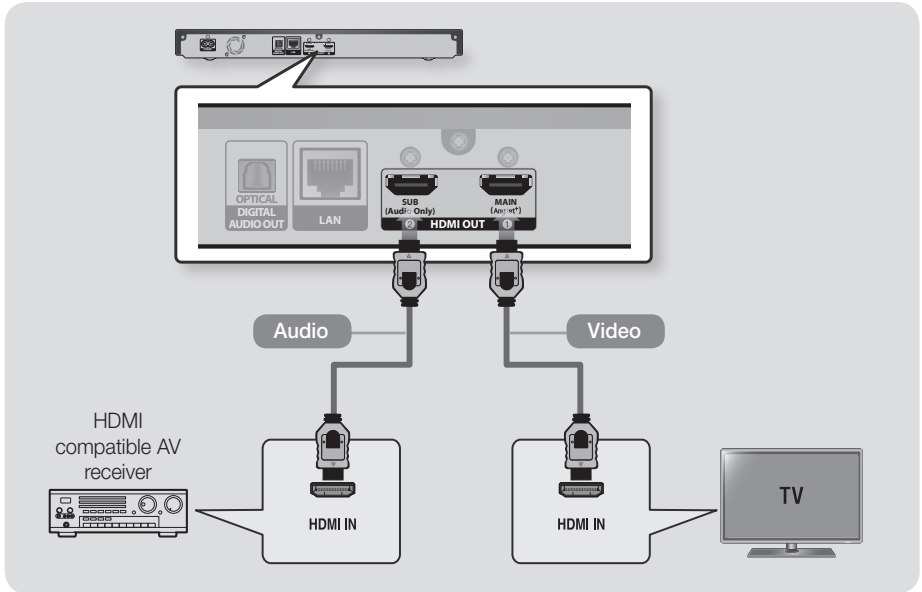

| CAUTION |

- ▶ Do not connect the **HDMI OUT 1** and **HDMI OUT 2** terminals of the product together with an HDMI cable.

Method 3 Connecting to an AV receiver with a Digital Optical Cable

- Using a digital Optical cable (not supplied), connect the **OPTICAL DIGITAL AUDIO OUT** jack on the product to the **DIGITAL OPTICAL IN** jack of the receiver.
- You will hear sound only through the front two speakers with **Digital Output** set to **PCM**.

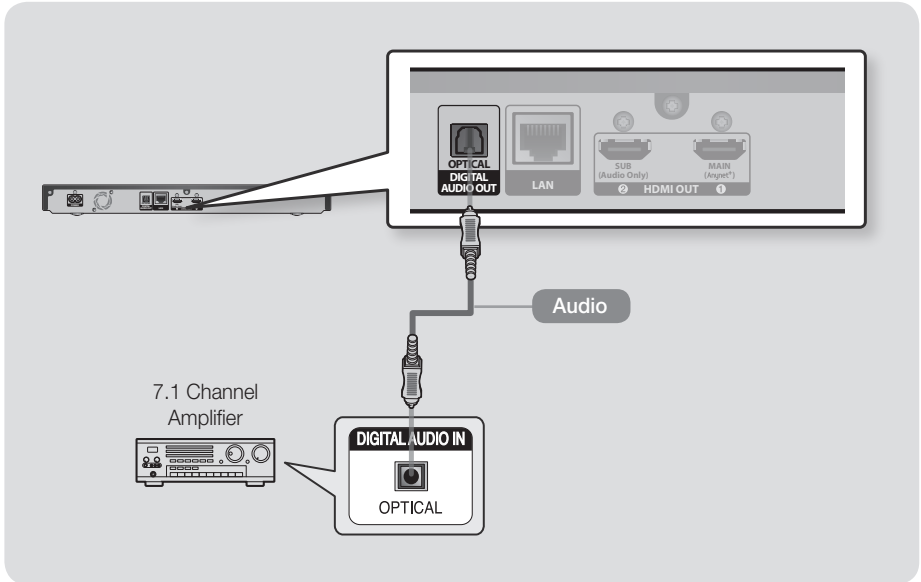

| NOTE |

- ▶ If you connect a receiver to the player's **OPTICAL DIGITAL AUDIO OUT** port, the receiver's audio reproduction may not synchronize with that of the TV.

Connections

Connecting to a Network Router

You can connect your product to your network router using one of the methods illustrated below. To use the DLNA network functionality, you must connect your PC to your network as shown in the illustrations.

The connection can be wired or wireless.

Wired Network

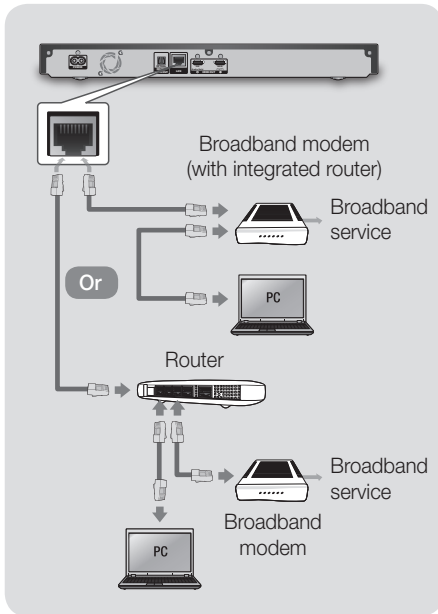

| NOTES |

- ▶ Your router or your Internet Service Provider's policies may prevent the product from accessing Samsung's software update server. If this occurs, contact your Internet Service Provider (ISP) for more information.
- ▶ DSL users, please use a router to make a network connection.

Wireless Network

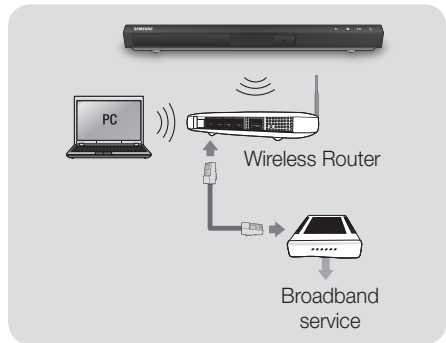

| NOTES |

- ▶ If your wireless router supports DHCP, this product can use a DHCP or static IP address to connect to the wireless network.
- ▶ Set your wireless router to Infrastructure mode. Ad-hoc mode is not supported.
- ▶ The product supports only the following wireless security key protocols:
 - WEP (OPEN/SHARED), WPA-PSK (TKIP/AES), WPA2-PSK (TKIP/AES)
- ▶ Select a channel on the wireless router that is not currently being used. If the channel set for the wireless router is currently being used by another device nearby, it will result in interference and communication failure.
- ▶ If you select the Pure High-throughput (Greenfield) 802.11n mode and set the Encryption type on your router to WEP, TKIP or TKIP-AES (WPS2Mixed), the product will not support a connection in compliance with new Wi-Fi certification specifications.
- ▶ Wireless LAN, by its nature, may cause interference, depending on the operating conditions (router performance, distance, obstacles, interference by other radio devices, etc).

The Initial Settings Procedure

- The Home screen will not appear if you do not configure the initial settings.
- The OSD (On Screen Display) may change in this product after you upgrade the software version.
- The access steps may differ depending on the menu you selected.

After you have connected the product to your TV, turn on the TV and product. When you turn on the product the first time, the product's Initial Settings screen appears on the TV. The Initial Settings procedure lets you set the On Screen Display (OSD) and menu languages, the aspect ratio (screen size), and network configuration, and connect the player to the Internet. Follow the directions on the screen.

When the initial setup is completed, a tutorial screen explaining how to use the Home menu will appear. To exit this screen, press the **(RETURN)** button on the remote.

| NOTES |

- ▶ If you skip Network Setup during the Initial Settings procedure, you can configure your network settings later. See "Configuring Your Network Connection" on pages 23~26 for instructions.
- ▶ If you want to display the Initial Settings screen again and make changes, select **Settings > System > Setup** in the Home screen or select the **Reset** option. (See page 23)
- ▶ If you want to use the **Anynet+ (HDMI-CEC)** function, please follow the instructions below.
 - 1) Connect the product to an **Anynet+ (HDMI-CEC)**-compliant Samsung TV using an HDMI Cable.
 - 2) Set the **Anynet+ (HDMI-CEC)** feature to **On** in both the TV and the product.
 - 3) Set the TV to the Initial Settings Procedure.

The Home Screen

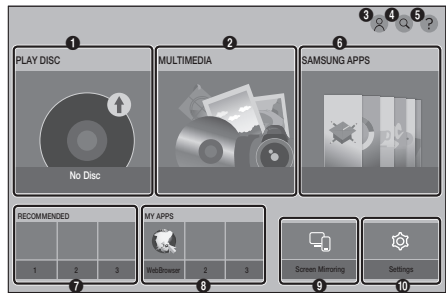

1	PLAY DISC : Lets you play photos, videos, or music content from a Disc.
2	MULTIMEDIA : Lets you play photos, videos, or music content from USB or mobile devices or PCs.
3	Sign In : Lets you log into your Samsung account.
4	Search : Lets you search for content in Apps and YouTube by entering corresponding search words.
5	Help : The tutorial screen explaining how to use the Home menu will appear.
6	SAMSUNG APPS : Gives you access to various applications you can download.
7	RECOMMENDED : Gives you direct access to recommended applications.
8	MY APPS : Apps downloaded from MY APPS are displayed.
9	Screen Mirroring : Lets you view the screen of your smart phone or android tablet on a TV you have connected to this product.
10	Settings : Opens the product's menu. In the menu, you can set various functions to suit your personal preferences.

Settings

| NOTE |

- ▶ If you leave the product in the stop mode for more than 5 minutes without using it, a screen saver will appear on your TV. If the product is left in the screen saver mode for more than 20 minutes, the power will automatically turn off.

Accessing the Settings Screen

1. Select **Settings** on the Home screen, and then press **OK** button. The **Settings** screen appears.

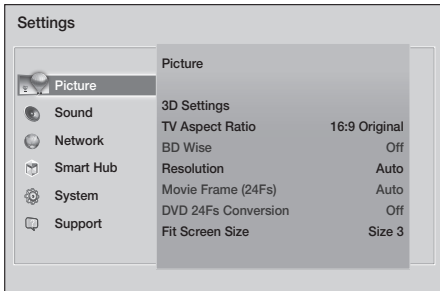

2. To access the menus, sub-menus, and options on the **Settings** screen, please refer to the remote control illustration in the next column.

Buttons on the Remote Control Used for the Settings Menu

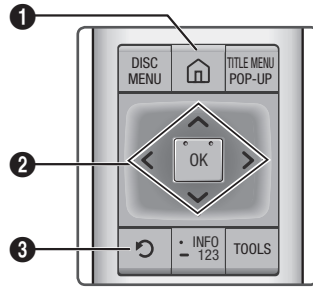

1	HOME (HOME) button : Press to move to the Home screen.
2	RETURN (RETURN) button : Press to return to the previous menu.
3	OK / DIRECTION buttons : <ul style="list-style-type: none">• Press ^ v < > to move the cursor or select an item.• Press the OK button to activate the currently selected item or confirm a setting.

Detailed Function Information

Each Settings function, menu item, and individual option is explained in detail on-screen. To view an explanation, use the **^ v < >** buttons to select the function, menu item, or option.

The explanation will usually appear on the right side of the screen.

A short description of each Settings function starts on the next page. Additional information on some of the functions is also in the Appendix of this manual.

Settings Menu Functions

Picture

3D Settings

Select whether to play an Ultra HD Blu-ray Disc or Blu-ray Disc with 3D content in 3D Mode.

- ✓ If you move to the Home or **SAMSUNG APPS** screen while in 3D mode, the product will switch to 2D mode automatically.

TV Aspect Ratio

Lets you adjust the output of the product to the screen size and screen format of your TV.

BD Wise

BD Wise is Samsung's latest inter-connectivity feature.

When you connect a Samsung product and a Samsung TV with **BD Wise** to each other via HDMI, and **BD Wise** is on in both the product and TV, the product outputs video at the video resolution and frame rate of the Ultra HD Blu-ray Disc, Blu-ray Disc, or DVD disc.

Resolution

Set the output resolution of the HDMI video signal to **BD Wise, Auto, 2160p, 1080p, 1080i, 720p** or **480p**.

The number indicates the number of lines of video per frame.

The i and p indicate interlaced and progressive scan, respectively. Generally, the more lines, the higher quality.

Movie Frame (24Fs)

If the product is connected to a 24Fs compatible TV, setting the **Movie Frame (24Fs)** feature to **Auto** lets the product adjust its HDMI output to 24 frames per second automatically for improved picture quality.

- You can enjoy the **Movie Frame (24Fs)** feature only on a TV supporting this frame rate.
- **Movie Frame** is only available when the product is in the HDMI 1080i, 1080p or 2160p output resolution modes.

DVD 24Fs Conversion

Converts DVD playback to 24 frames per second and outputs it via HDMI. This option is only available when **Movie Frame (24Fs)** is set to **On**.

| NOTE |

- ▶ This feature applies to NTSC discs only.

Fit Screen Size

Set the screen to the optimal size. (Available for **Smart Hub** and **Screen Mirroring** only)

HDMI Color Format

Lets you set the color space format for the HDMI output so that it matches the capabilities of the connected device (TV, monitor, etc). The screen goes black momentarily after you have selected a format.

HDMI Deep Color

Lets you set the product to output HDMI video with Deep Color. Deep Color provides more accurate color reproduction with greater color depth.

Settings

Sound

Speaker Settings

You can configure this product to connect to a Multiroom Link compatible speaker wirelessly and enjoy rich sound.

✓ **Speaker Settings** : You can set up speakers that are connected via your home network.

| NOTES |

- ▶ To use this feature, you must connect at least one Multiroom Link speaker.
- ▶ Sound quality may be affected by the condition of your wireless network.
- ▶ The network connection can be negatively affected and even lost if the network environment deteriorates over time.
- ▶ Activating **Screen Mirroring** disables **Multiroom Link**.
- ▶ For further details, refer to the Multiroom Link manual on the Samsung web site:
www.samsung.com → → Search for Product name: UBD-K8500 → Manuals → Multiroom Link → Download PDF
- ▶ The audio from each connected device may lag behind the video and audio of the device which is playing the source contents.

Digital Output

Lets you select the digital audio output format that is suitable for your TV or AV Receiver. For more details, see the digital output selection table on page 53.

PCM Downsampling

Lets you choose to have 96kHz PCM signals downsampled to 48kHz before they are outputted to an amplifier. Choose **On** if your amplifier or receiver is not compatible with a 96kHz signal.

Dynamic Range Control

Lets you apply dynamic range control to Dolby Digital, Dolby Digital Plus, and Dolby TrueHD audio.

- ✓ **Auto** : Automatically controls the dynamic range of Dolby TrueHD audio, based on information in the Dolby TrueHD soundtrack. Also turns dynamic range control on for Dolby Digital and Dolby Digital Plus.
- ✓ **Off** : Leaves the dynamic range uncompressed, letting you hear the original sound.
- ✓ **On** : Turns dynamic range control on for all three Dolby formats. Quieter sounds are made louder and the volume of loud sounds is reduced.

Downmixing Mode

Lets you select the multi-channel downmix method that is compatible with your stereo system.

You can choose to have the product downmix to normal stereo or to surround compatible stereo.

DTS Neo:6 Mode

You can enjoy multichannel sound via HDMI output from a 2 channel audio source.

Audio Sync

In some cases, when the product is connected to a digital TV, the audio signal may not synchronize with the video signal. If this occurs, adjust the audio delay time to match the video signal.

- You can set the audio delay time between 0 ms and 250 ms. Adjust it to the optimal setting.

| NOTE |

- ▶ The audio delay time you specify may not be exact depending on the content played.

HDMI Audio Output

Set HDMI audio to output through **HDMI1** or **HDMI2**.

- ✓ **Auto** : Audio output will be set automatically based on the devices connected to HDMI1 and HDMI2.
- ✓ **HDMI1** : Audio will output to the device connected to HDMI1.
- ✓ **HDMI2** : Audio will output to the device connected to HDMI2.

Network

Network Status

Lets you check the current network and Internet status.

Network Settings

Configure the network connection so you can enjoy various features such as Internet services or DLNA functionality, and perform Software Updates.

Multimedia Device Settings

Lets you control which devices on your network, such as smart phones and tablets, can share content with your product.

Device Name

Lets you input a name for the product that will identify it on your network.

BD-Live Settings

Set various BD-Live functions. BD-Live allows you to access extra features available on some Ultra HD Blu-ray Discs or Blu-ray Discs if you are connected to the Internet.

| NOTE |

- ▶ To use this function, connect the USB storage device first and select it from the **BD Data Management** menu.

- ✓ **BD-Live Internet Connection** : Lets you fully allow, partly allow, or prohibit a BD-Live Internet connection.
- ✓ **BD Data Management** : Manage BD data downloaded from a BD-Live service or Ultra HD Blu-ray Disc/Blu-ray Disc.

Smart Hub

Caption

The function is used for VOD playback that supports closed caption display. Use it to change the displayed caption's font color and size.

| NOTES |

- ▶ This function does not work with VOD services that don't support closed caption display.
- ▶ For certain VOD services, the function's settings may not be applied.

Terms & Policy

You must review and agree to both the App Terms & Conditions and the privacy policy to use App services.

Reset Smart Hub

Resets all Smart Hub settings to their default settings. To use, you must enter the security PIN. The default security PIN is 0000.

System

Accessibility

- ✓ **Voice Guide** : You can activate voice guides that describe the menu options aloud to aid the visually impaired.
- ✓ **High Contrast** : Set up the background and font in high contrast color in Samsung Apps (Smart Hub) and Multimedia.
- ✓ **Enlarge** : Set whether to enlarge the highlighted item in Samsung Apps (Smart Hub) and Multimedia.

Settings

Setup

Lets you re-run the Initial Settings procedure.

Language

You can select the language you prefer for the On-screen menu, disc menu, audio, subtitles, etc.

- The language you select for the disc menu, disc audio, or subtitles will only appear if it is supported on the disc.

Device Manager

You can connect a wireless USB keyboard or mouse to the USB port on the front of the product.

- ✓ **Keyboard Settings** : Lets you configure a wireless USB keyboard connected to the product.

| NOTE |

- ▶ You can use the keyboard only when a QWERTY keyboard screen or window appears in the Web Browser.
- ✓ **Mouse Settings** : Lets you configure a wireless USB mouse connected to the product. You can use the mouse in the product's menu and the Web Browser in the same way you use a mouse on your PC.

▪ To use a mouse with the product's menu:

1. Connect the USB mouse to the product.
2. Click the primary button you selected in **Mouse Settings**. The Simple Menu appears.
3. Click the menu options you want.

| NOTES |

- ▶ Some USB HID keyboards and mice may not be compatible with your product.
- ▶ Some HID keyboard keys may not work.
- ▶ Wired USB keyboards are not supported.
- ▶ Some applications may not be supported.
- ▶ If a wireless HID Keyboard does not operate because of interference, move the keyboard closer to the product.

Security

The default security PIN is 0000. Enter the default PIN to access the security function if you haven't created your own PIN. After you have accessed the security function for the first time, change the PIN using the **Change PIN** function.

- ✓ **BD Parental Rating** : Prevents playback of Ultra HD Blu-ray Discs or Blu-ray Discs with a rating equal to or above a specific age rating you have set unless you enter the PIN.
- ✓ **DVD Parental Rating** : Prevents playback of DVDs with a rating above a specific numerical rating you have set unless you enter the PIN.
- ✓ **Change PIN** : Change the 4-digit PIN used to access security functions.

▪ If you forget your PIN:

1. Remove any disc or USB storage device.
2. Press and hold the **■** button on the top panel for 5 seconds or more.
The initialization message appears on the screen, and the power will turn off automatically.
When you turn your product on again, all the settings will be reset.

General

You can change the options listed below to match your preferences.

- ✓ **Time Zone** : Select the time zone in which you live.
- ✓ **Menu Transparency** : Lets you adjust the transparency of the menu box.

Anynet+ (HDMI-CEC)

Anynet+ is a convenient function that offers linked operations with other Samsung product that have the Anynet+ feature and lets you control those products with one Samsung TV remote. To operate this function, you must connect this product to an Anynet+ Samsung TV using an HDMI cable.

Support

Remote Management

When activated, lets Samsung Call Center agents diagnose and fix problems with your player remotely. Requires an active Internet connection.

| NOTES |

- ▶ Remote Management service might not be available in some countries.
- ▶ To use Remote Management:
 - 1) Call the Samsung Contact Center and ask for remote support.
 - 2) Open the player's menu on your TV and go to the Support section.
 - 3) Select **Remote Management**, and then read and agree to the service agreements. When the PIN screen appears, provide the PIN number to the agent.
 - 4) The agent accesses your player.

Software Update

This menu allows you to upgrade the product's software for performance improvements or additional services.

Contact Samsung

Provides contact information for assistance with your product.

Reset

Resets all settings to their default settings except for the network and Smart Hub settings, and then starts the Setup function. To use, you must enter the security PIN. The default security PIN is 0000.

Networks and the Internet

When you connect this product to a network, you can use network based applications and functions such as Smart Hub and BD-LIVE, and upgrade the product's software through the network connection. For more information about accessing and using Internet services, see the Network Services chapter of this manual on pages 40~48. Instructions for configuring the network connection start below.

Configuring Your Network Connection

Before you begin, determine if your IP address is static or dynamic. (Most are dynamic.) If it is dynamic, and you have a wired or wireless network, we recommend using the Automatic configuration procedures described below.

If you are connecting to a wired network, connect the product to your router using a LAN cable before you start the configuration procedure. If you are connecting to a wireless network, disconnect any wired network connections before you begin.

To begin configuring your network connection, follow these steps:

Wired Network

□ Wired - Automatic

1. In the Home screen, select **Settings**, and then press the **OK** button.
2. Select **Network**, and then press the **OK** button.
3. Select **Network Settings**, and then press the **OK** button.
4. Select **Wired** in the **Network Settings** screen, and then press the **OK** button.
5. Select the **Connect** button, and then press the **OK** button. The product detects the wired connection, verifies the network connection, and then connects to the network.

Settings

❑ Wired - Manual

If you have a static IP address or the Automatic procedure does not work, you'll need to set the **Network Settings** values manually.

Follow Steps 1 and 2 in Wired - Automatic, and then follow these steps:

1. Select **Network Status**. The product searches for a network, and then displays the connection failed message.
2. On the bottom of the screen, select **IP Settings**, and then press the **OK** button. The **IP Settings** screen appears.
3. Select the **IP Settings** field, and then press the **OK** button.
4. Select **Enter manually** in the **IP Settings** field, and then press the **OK** button.
5. Select a parameter to enter (**IP Address**, for example), and then press the **OK** button. Use the **^** **v** buttons on the remote control to enter the numbers for the parameter. Use the **<** **>** buttons on the remote control to move from entry field to entry field within a parameter. When done with one parameter, press the **OK** button.
6. Press the **^** or **v** button to move to another parameter, and then enter the numbers for that parameter following the instructions in Step 5.
7. Repeat Steps 5 and 6 until you have filled in all parameters.

| NOTE |

- ▶ You can get the Network parameters from your Internet provider.
8. When finished entering all the parameters, select **OK**, and then press the **OK** button. The product verifies the network connection and then connects to the network.

Wireless Network

You can set up a wireless network connection in four ways:

- Wireless Automatic
- Wireless Manual
- WPS(PBC)
- WPS PIN

When you configure the wireless network connection, any wireless network devices currently connected through the product or, if applicable, the product's current wired connection, will be disconnected.

❑ Wireless - Automatic

1. In the Home screen, select **Settings**, and then press the **OK** button.
2. Select **Network**, and then press the **OK** button.
3. Select **Network Settings**, and then press the **OK** button.
4. Select **Wireless** in the **Network Settings** screen, and then press the **OK** button. The product searches for and then displays a list of the available networks.

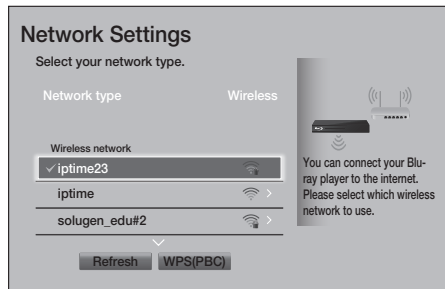

5. Select the desired network, and then press the **OK** button.
6. On the Security screen, enter your network's Security Code or Pass Phrase. Enter letters by selecting a letter with an arrow button, and then pressing **OK** button.

| NOTE |

- ▶ To view the password as you enter it, use the arrow buttons to select **Show Password** on the right side, and then press **OK** button.
7. When finished, select **Done** and then press the **OK** button. The product verifies the network connection and then connects to the network.
 8. When verification is complete, select **OK**, and then press the **OK** button.

| NOTE |

- ▶ You should be able to find the Security Code or Pass Phrase on one of the set up screens you used to set up your router or modem.

□ Wireless - Manual

If you have a static IP address or the Automatic procedure does not work, you'll need to set the **Network Settings** values manually.

1. Follow the directions in Wireless - Automatic through Step 5.
2. The product searches for a network, and then displays the connection failed message.
3. On the bottom of the screen, select **IP Settings**, and then press the **OK** button. The **IP Settings** screen appears.
4. Select the **IP Settings** field, and then press the **OK** button.
5. Select **Enter manually** in the **IP Settings** field, and then press the **OK** button.
6. Select a parameter to enter (**IP Address**, for example), and then press the **OK** button. Use the **^** **v** buttons on the remote control to enter the numbers for the parameter. Use the **<** **>** buttons on the remote control to move from entry field to entry field within a parameter. When done with one parameter, press the **OK** button.
7. Press the **^** or **v** button to move to another parameter, and then enter the numbers for that parameter following the instructions in Step 6.
8. Repeat Steps 6 and 7 until you have filled in all parameters.

| NOTE |

- ▶ You can get the Network parameters from your Internet provider.
9. When finished, select **OK**, and then press the **OK** button. The Security Screen appears.
 10. On the Security screen, enter your network's Security Code or Pass Phrase. Enter letters by selecting a letter with the **^** **v** **<** **>** buttons, and then pressing the **OK** button.
 11. When finished, select **Done** at the right of the screen, and then press the **OK** button. The product verifies the network connection and then connects to the network.
 12. After the product verifies the network, select **OK**, and then press the **OK** button.

□ WPS(PBC)

1. In the Home screen, select **Settings**, and then press the **OK** button.
2. Select **Network**, and then press the **OK** button.
3. Select **Network Settings**, and then press the **OK** button.
4. Select **Wireless** in the **Network Settings** screen, and then press the **OK** button.
5. Press the **^** button on your remote, and then press the **>** button to select **WPS(PBC)**.
6. Press the **OK** button on your remote. The "Press the PBC button on your wireless router within the next two minutes." message appears.

Settings

7. Press the **WPS(PBC)** button on your router within two minutes. Your product automatically acquires all the network settings values it needs and connects to your network. The **Network Status** screen appears. The product connects to the network after the network connection is verified.

□ WPS PIN

Before you begin, open the router's setup menu on your PC and access the screen with the **WPS PIN** entry field.

1. In the Home screen, select **Settings**, and then press the **OK** button.
2. Select **Network**, and then press the **OK** button.
3. Select **Network Settings**, and then press the **OK** button.
4. Select **Wireless** in the **Network Settings** screen, and then press the **OK** button. The product searches for and then displays a list of the available networks.
5. Select the desired network, and then press the **OK** button.
6. Select the **WPS PIN**, and then press the **OK** button. The PIN pop-up appears.
7. Enter the PIN into the **WPS PIN** entry field in the router's set up screen and then save the the screen.

| NOTES |

- ▶ Contact the manufacturer of the router for instructions explaining how to access the route's set up screens or refer to the router's user's manual.
- ▶ For a WPS connection, set your wireless router's security encryption method to AES. WPS connections do not support WEP security encryption.

Upgrading Software

This menu allows you to upgrade the product's software for performance improvements or additional services.

- Never turn the product off or back on manually during the update process.

1. In the Home screen, select **Settings**, and then press the **OK** button.
2. Select **Support**, and then press the **OK** button.
3. Select **Software Update**, and then press the **OK** button.
4. To download update software and update now, select **Update now**, and then press the **OK** button.
5. To let the product download update software automatically when available, select **Auto Update**, and then press the **OK** button. See "Auto Update" on page 27 for details.

| NOTES |

- ▶ The upgrade is complete when the product turns off, and then turns on again by itself.
- ▶ Samsung Electronics takes no legal responsibility for any product malfunction caused by an unstable Internet connection or consumer negligence during a software Update.
- ▶ If you want to cancel the upgrade while the upgrade software is downloading, press the **OK** button.

Update now

1. Select **Support > Software Update > Update now.**
2. An online update function downloads and installs the update software directly from the Internet.
 - This option requires an Internet connection.

| NOTES |

- ▶ When the system update is done, check the software details in the Product Information section of the Contact Samsung screen.
- ▶ Do not turn off the product during the Software Update. It may cause the product to malfunction.

Auto Update

You can set the **Auto Update** function so that the product downloads new upgrade software when it is in Auto Update mode.

This allows the product to download upgrade software automatically, when you are not using it.

1. Press the **^v** buttons to select **Auto Update**, and then press the **OK** button.
2. Select **On / Off.**

| NOTE |

- ▶ To use the **Auto Update** function, your product must be connected to the Internet.

Update by USB

To upgrade by USB, follow these steps:

1. Visit www.samsung.com.
2. Click **OWNERS & SUPPORT > GET SUPPORT** on the top right of the page.
3. Enter the product's model number into the search field in the upper right of the screen. As you enter the model number, a drop down will display products that match the model number.
4. Click your product's model number in the drop down list.
5. On the page that appears, scroll down to **Manuals & Downloads.**

6. Find Upgrade File (USB type) under Downloads.
7. Click **DOWNLOAD (ZIP).**
8. On the page that appears, click **CONTINUE.** The download begins. Click the faint **X** in the upper right corner of the white area in the center of the window. Then, click the **Download icon** on your browser to display the download in progress.
9. When the download is done, unzip the zip archive to your computer. You should have a single folder with the same name as the zip file.
10. Copy the folder to the top level folder of a USB flash drive.
11. Make sure no disc is inserted in the product, and then insert the USB flash drive into the USB port of the product.
12. In the product's menu, go to **Settings > Support > Software Update.**
13. Select **Update now.**
14. The product searches for the software on the USB drive. When it finds the software, the Update Request pop-up appears.
15. Select **OK.** The product upgrades the software, turns off, and then turns on automatically.

| NOTES |

- ▶ There should be no disc in the product when you upgrade the software using the USB jack.
- ▶ When the system upgrade is done, check the software details in the Product Information section of the Contact Samsung screen.
- ▶ Do not turn off the product during the Software Update. It may cause the product to malfunction.
- ▶ Software Updates using the USB jack must be performed with a USB flash memory stick only.

Media Play

Your Ultra HD Blu-ray Player can play content located on Ultra HD Blu-ray/Blu-ray/DVD/CD discs, USB devices, PCs, smart phones, tablets, and on the Web.

To play content located on your PC or a mobile device, you must connect the PC or mobile device and the product to your network. To play content on your PC, you must install DLNA software or already have DLNA software installed on your PC and connect the Ultra HD Blu-ray Player to your PC via your network.

| NOTE |

- ▶ PCs running Windows 7 and Windows 8 have DLNA software (Windows Media Player) built in.

Playing Commercial Discs

1. Press the **▲** button to open the disc tray.
2. Place a disc gently into the disc tray with the disc's label facing up.

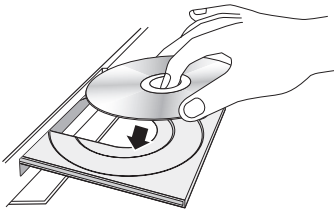

3. Press the **▲** button to close the disc tray. Playback starts automatically.
4. If playback does not start automatically, press the **HOME** button, select **PLAY DISC** on the upper left of the Home screen, and then press the **OK** button on the remote.

Disc Storage & Management

• Holding Discs

- Fingerprints or scratches on a disc may reduce sound and picture quality or cause skipping.
- Avoid touching the surface of a disc where data has been recorded.
- Hold the disc by the edges so that fingerprints will not get on the surface.
- Do not stick paper or tape on the disc.



• Cleaning Discs

- If you get fingerprints or dirt on a disc, clean it with a mild detergent diluted in water and wipe with a soft cloth.
- When cleaning, wipe gently from the inside to the outside of the disc.



• Disc Storage

- Do not keep in direct sunlight.
- Keep in a cool ventilated area.
- Keep in a clean protective jacket and store vertically.

Playing Photos, Videos, and Music (Multimedia)

You can play media content saved on a USB device, smartphone, camera, or computer on the product.

| NOTES |

- ▶ You cannot play media content if the content or the storage device is not supported by the product.
- ▶ Backup important files before connecting a USB device. Samsung is not responsible for damaged or lost files.

Playing Media Content Saved on a USB Device

1. Connect your USB device to the product.
2. Press the **HOME** button. Select **MULTIMEDIA**, and then **Storage**. The USB devices connected to the product are listed.
3. Select the device you that has the files you want to play. The folders and files in the selected USB are listed.
4. Select the media content you want to play from the list. The media content plays.

| NOTE |

- ▶ Alternatively, select the Media Type you want to play (Videos, for example), then select the file you want to play, and then press the **▶** button to play the content.
- 5. To exit, press the **■** button or **RETURN** button.

| NOTE |

- ▶ If you connect a USB device to the product, a popup window appears on the screen so that you can easily navigate the folders and files of the USB device.

Playing Media Content Saved in a Computer/Mobile Device

You can play media content on the product that is stored on a computer or mobile device connected to the same network as the product.

| NOTES |

- ▶ Only available with Samsung phones supporting DLNA functionality.
- ▶ You may experience compatibility issues when attempting to play media files via a third-party DLNA server.
- ▶ The content shared by a computer or a mobile device may not play depending on the encoding type and file format of the content. In addition, some functions may not be available.

- ▶ The media content may not play smoothly depending on the network status. If the content does not play smoothly, transfer the content to a USB device, connect the USB device to the player, and then play the content from the USB device.

1. Connect the smart device and product to the same network.
2. Press the **HOME** button. Select **MULTIMEDIA**, and then **Storage**. Storage devices connected to the same network as the product are listed.
3. Select a desired storage device. The folders and files shared by the selected storage device are listed.
4. Select the media content you want to play from the list. The media content plays.

| NOTES |

- ▶ Alternatively, select the Media Type you want to play (Videos, for example), select the file you want to play, and then press the **▶** button to play the content.
- ▶ Playing UHD BD content may require a network connection. Depending on the network environment and status of Contents Server (Studio), playback may not be successful.
- 5. To exit, press the **■** button or **RETURN** button.

Allowing a Connection with a Mobile Device

(HOME → Settings → Network → Multimedia Device Settings)

To play the media content stored on a mobile device, you must allow the connection between the mobile device and the product.

| NOTE |

- ▶ You can connect a mobile device to any DLNA DMC device, such as your player. The DLNA DMC function enables you to connect a mobile device to the product, search for media content, and control play operations on the product.
1. Navigate to **Settings > Network** and select **Multimedia Device Settings**. The mobile devices connected to the same network as the product are listed.
 2. Allow connection with the device you wish to connect to the product. You can only play media files from devices that have been allowed to connect to the product.

| NOTE |

- ▶ If a mobile device requests to play media content, the connection confirmation window appears on the TV connected to the product so that you can easily connect the mobile device.

Playing a Disc with User Recorded Content

You can play multimedia files you have recorded on Blu-ray, DVD, or CD discs.

1. Place a user recorded disc into the disc tray with the disc's label facing up, and then close the tray. The Device Connected pop-up appears.
2. Use the **^ v** buttons to select the type of content you want to view or play - **All**, **Photos**, **Videos** or **Music** - and then press the **OK** button.

| NOTE |

- ▶ Even though the product will display folders for all content types, it will only display files of the Content Type you selected in Step 2. For example, if you selected music, you will only be able to see music files. You can change this selection by returning to the **MULTIMEDIA** screen and repeating Step 2.
3. A screen appears listing the contents of the disc. Depending on how the contents are arranged, you will see either folders, individual files, or both.
 4. If necessary, use the **^ v < >** buttons to select a folder, and then press the **OK** button.
 5. Use the **^ v < >** buttons to select a file to view or play, and then press the **OK** button.
 6. Press the **⏪ (RETURN)** button one or more times to exit a current screen, exit a folder, or to return to the Home screen.
 7. Go to pages 31~39 for instructions that explain how to control playback of videos, music, and pictures on a disc.

Controlling Video Playback

You can control the playback of video content located on a Disc, USB, mobile device, or PC. Depending on the disc or contents, some of the functions described in this manual may not be available.

Buttons on the Remote Control used for Video Playback

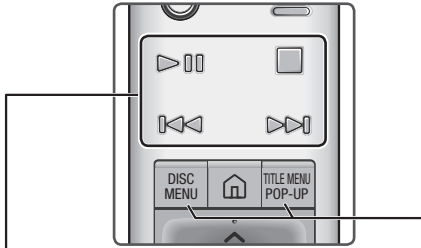

■ Playback related buttons

The product does not play sound in Search, or Step mode.

- To return to normal speed playback, press the **▶||** button.

▶ button	Starts playback. When a disc is playing, push to pause playback. Push again to restart.
■ button	Stops playback.
Fast Motion Play	During playback, press and hold the ⏮ or ⏭ button. Each time you press and hold the ⏮ or ⏭ button, the playback speed will change.
Slow Motion Play	In pause mode, press and hold the ▶ button. Each time you press and hold the ▶ button, the playback speed will change.
Skip Motion Play	During playback, press the ⏮ or ⏭ button. Each time you press the ⏮ or ⏭ button, the disc moves to the previous or next chapter or file.

■ Using the disc menu, title menu, popup menu, and title list

DISC MENU button	During playback, press this button to display the Disc menu.
TITLE MENU button	During playback, press this button to display the Title menu. <ul style="list-style-type: none"> • If your disc has a playlist, press View to go to the playlist.
POPUP MENU button	During playback, press this button to display the Popup menu.

Using the Settings Menu During Playback

During playback or in pause mode, press the **TOOLS** button.

Use the **^ v < >** buttons to select the **ⓘ** and then press the **OK** button.

Play from the Beginning	Select to return to the beginning of the movie, and then press the OK button.
3D	<p>Use the 3D menu when playing a 3D file.</p> <p> NOTES </p> <ul style="list-style-type: none"> ▶ The 3D menu becomes available only when you are playing a 3D video file. ▶ If you move to the Home or Smart Hub Home screen while in 3D mode, the product will switch to 2D automatically.
Select Scene	<ul style="list-style-type: none"> - Search Titles : If there is more than one movie on the disc or device, select to start a different title. <ol style="list-style-type: none"> 1. Select Search Titles, and then press the OK button. 2. Use the ^ v buttons to select a title, and then press the OK button. <p> NOTE </p> <ul style="list-style-type: none"> ▶ When searching DVD titles in stop mode, press the INFO button, and then enter the title number (01,02,...) you want. <ul style="list-style-type: none"> - Search Chapters : Select to play the chapter of your choice. <ol style="list-style-type: none"> 1. Select Search Chapters, and then press the OK button.

Select Scene	<ol style="list-style-type: none"> 2. Use the ^ v buttons to select a chapter, and then press the OK button. <ul style="list-style-type: none"> - Search Time Bar : Select to play the movie from a selected time point. <ol style="list-style-type: none"> 1. Select Search Time Bar, and then press the OK button. 2. Using the < > buttons, enter the time point you want to go to. <p> NOTES </p> <ul style="list-style-type: none"> ▶ You can also use the < > buttons to advance or rewind the movie. The movie advances or rewinds one minute each time you press the < > buttons. ▶ If the index information in the file is damaged or the file does not support indexing, you will not be able to use the Select Scene function. ▶ If you run files on a network device after you have connected the player to a computer on your network, Select Scene may not work.
Search	<ul style="list-style-type: none"> - Search Scene : You can use the Search Scene function during playback to view or start a movie from the scene of your choice. - Search Titles : If there is more than one movie on the disc or device, select to start a different title. - Search Time Bar : Select to play the movie from a selected time point.
Subtitle Settings	Lets you set the desired subtitle options.

Repeat Mode	Lets you repeat a title, chapter, or specific section.
Full Screen	Lets you set the size of the video image.
Picture Mode	<p>Lets you set the picture mode.</p> <ul style="list-style-type: none"> - Dynamic : Increases sharpness and brightness. - Standard : Choose this setting for most viewing applications. - Movie : The best setting for watching movies. - User : Lets you adjust the sharpness and noise reduction function respectively. <p> NOTE </p> <ul style="list-style-type: none"> ▶ When you use the BD wise function, this menu will not appear.
Multiroom Link	<p>Select to control the volume of Multiroom speakers.</p> <ul style="list-style-type: none"> - Volume : Adjusts the volume level. Press the < > buttons on the remote control. - Mute : Mutes the sound from this player. Press again to restore the sound to the previous volume level. <p> NOTE </p> <ul style="list-style-type: none"> ▶ This menu is only available when you connect to a Multiroom Link compatible speaker.
Audio	Use to set the desired audio language.
Audio Sync	Select to adjust the audio sync.
Subtitle	Use to set the desired subtitle language.

Angle	Lets you view a scene from another angle. The Angle option displays the number of angles available to view. When an Ultra HD Blu-ray Disc/Blu-ray Disc/DVD contains multiple angles of a particular scene, you can change to another angle.
Information	Lets you view video file information.
BONUSVIEW Video	Use to set the desired bonusview option.
BONUSVIEW Audio	

| NOTES |

- ▶ Depending on the disc or storage device, the menu may differ.
- ▶ Video files with high bitrates of 20Mbps or more strain the product's capabilities and may stop playing during playback.

Media Play

Using the Sort by & Options Menus

Using the Sort by Menu

On a file screen containing video files, select  and then press the **OK** button.

Date	Groups all the the video files on the media or storage device by date. Click a group to see the videos in that group.
Title	Displays all the video files on the media or storage device by title.
Folder	Displays all the folders on the media or storage device in alphabetical order.

| NOTE |

- ▶ Depending on the disc or storage device, the menu may differ.

Using the Options Menu

On a file screen containing video files, select  and then press the **OK** button.

Play Selected	Lets you select specific files to play. It works essentially the same for all media.
Send	Select this menu to upload selected files to a web site (Picasa, Facebook etc) or device. To use this menu, you need to establish an account with the on-line site, and then log in using the Log In function. See "Using the Send Function" on page 39.

Controlling Music Playback

You can control the playback of music content located on a Disc, USB, mobile device, or PC. Depending on the disc or contents, some of the functions described in this manual may not be available.

Buttons on the Remote Control used for Music Playback

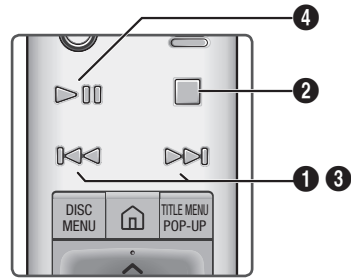





1	◀▶ buttons : Move to the previous/next track.
2	■ button : Stops a track.
3	Fast Play (Audio CD [CD-DA] only) During playback, press and hold the ◀▶ or ▶▶ button. Each time you press and hold the ◀▶ or ▶▶ button, the playback speed will change.
4	▶ button : Plays/Pauses a track.

| NOTE |

- ▶ If you don't press a button within five seconds of inserting an Audio CD, the screen is displayed in Full Screen mode.
To go back to the Play List screen, press the  (**RETURN**) button on the remote control.

Using the Options Menu During Playback

On the music file playback screen, use the     buttons to select the  and then press the **OK** button.

Play Selected	Lets you create a playlist by selecting specific tracks to play. It works essentially the same way for all media. See "Creating a Playlist from an Audio CD" on page 36.
Ripping	This function converts CD audio to the mp3 or wav format, as selected by the user, and saves the converted files on a USB device or a mobile device connected to the product. See "Ripping" on page 37.
Information	Select to see the Contents information.

| NOTE |

- ▶ Depending on the disc or storage device, the menu may differ.

Using the Sort by & Options Menus on a File Screen

Using the Sort by Menu

On a file screen containing music files, select the  and then press the **OK** button.

Track	Displays all the music tracks on the media or storage device in alphabetical order.
Album	Displays all music on the media or storage device by album.
Artist	Displays all the the music files on the media or storage device by artis.

Genre	Displays all the music on the media or storage device by genre.
Folder	Displays all the folders on the media or storage device.

| NOTE |

- ▶ Depending on the disc or storage device, the menu may differ.

Using the Options Menu

On a file screen containing music files, select the  and then press the **OK** button.

Play Selected	Lets you select specific tracks to play. It works essentially the same for all media. See the "Repeating Tracks on an Audio CD" on page 36.
Send	Select to send selected files to other devices. See "Using the Send Function" on page 39.
Encoding	Select to manage the text encoding options.
Add to Playlist	Select to create a playlist.
Index	Select to display the list of music titles with the same initial letter as that selected.

| NOTE |

- ▶ Depending on the disc or storage device, the menu may differ.

Repeating Tracks on an Audio CD

You can set the product to repeat tracks on an audio CD (CD-DA/MP3).

1. On the Playback screen, use the **^ v < >** buttons to select  in the lower left corner of the screen, and then press the **OK** button.
2. Use the **^ v** buttons to select the repeat mode you want - **Off**, **One Song**, or **All** - and then press the **OK** button.

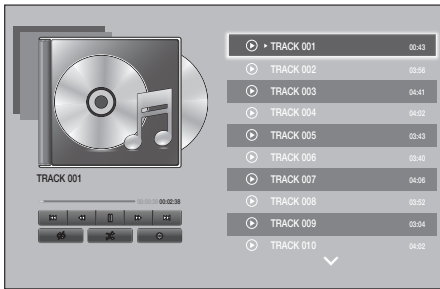

Shuffling Tracks on an Audio CD

You can set the product to play tracks on an audio CD (CD-DA/MP3) at random.

1. On the Playback screen, use the **^ v < >** buttons to select  in the lower left corner of the screen, and then press the **OK** button.
2. Use the **^ v** to set the Shuffle mode **On** or **Off**, and then press the **OK** button.

Creating a Playlist from an Audio CD

1. With the Playback screen displayed, select the  and then press the **OK** button. The **Settings** menu appears.
2. Use the **^ v** buttons to select **Play Selected**, and then press the **OK** button.
3. Use the **^ v** buttons to select a track, and then press the **OK** button. A check appears to the left of the track.

4. Repeat Step 3 to select and check additional tracks.
5. To remove a track from the list, move to the track, and then press the **OK** button again. The check on the track is removed.
6. When done, press the **^ v** buttons to select **Play**, and then press the **OK** button. The Music Playback screen reappears listing only the tracks you checked. The selected tracks play automatically.

| NOTES |

- ▶ You can create a playlist with up to 99 tracks on Audio CDs (CD-DA).
- ▶ On the Selection Play screen, you can also choose **Select All**, **Clear All**, and **Cancel**.
 - Use **Select All** to select all tracks. This cancels your individual track selections. When you press the **RETURN** button on your remote control or select the **Play** button, and then press the **OK** button, all tracks will appear on the Music Playback screen, and the product will begin to play all tracks from Track 001.
 - Use **Clear All** to deselect all selected tracks at once. Then, select individual tracks or use **Select All** to select all the tracks, and then press the **RETURN** button on your remote control. If you do not use **Select All** or select individual tracks, the Playlist will not change.
 - **Cancel** cancels any changes you made on the Play Select screen. When you return to the Playback screen, the Playlist will be unchanged.

Ripping

1. Insert a USB device into the USB jack on the front of the product.
2. With the Playback screen displayed, select the  and then press the **OK** button. The **Settings** menu appears.
3. Use the **^** **v** buttons to select **Ripping**, and then press the **OK** button.
4. Select the ripping encoding type from the list. Ripping types supported are:
WAV Lossless Copy
MP3 320 kbps
MP3 192 kbps
5. Use the **^** **v** buttons to select a track, and then press the **OK** button. A check appears to the left of the track.
6. Repeat Step 5 to select and check additional tracks.
7. To remove a track from the list, move to the track, and then press the **OK** button again. The check on the track is removed.
8. When done, select **Rip** using the **^** **v** buttons, and then press the **OK** button. The Rip pop-up appears.
9. Use the **^** **v** buttons to select the device to store the ripped files to, and then press the **OK** button.

| NOTE |

- ▶ Do not disconnect the device while ripping is in progress.
10. If you want to cancel ripping, press the **OK** button and then select **Yes**. Select **No** to continue ripping.
 11. When ripping is complete, the "Successfully Ripped." message appears. Press the **OK** button.
 12. Press the **⏪** (**RETURN**) button or select **Cancel**, and then press the **OK** button to go back to the Playback screen.

| NOTES |

- ▶ This function does not work with DTS Audio CDs.
- ▶ This function may not be supported by some discs.
- ▶ Ripping encodes music into the .mp3 format at 192kbps and 320kbps.
- ▶ On the Ripping screen, you can also choose **Select All** and **Clear All**.
- ▶ Use **Select All** to select all tracks and press the **OK** button. This cancels your individual track selections.
- ▶ Use **Clear All** to deselect all selected tracks at once.

Playing Photo Contents

You can play photo contents located on a DVD, USB, mobile device, or PC.

Using the Tools Menu During Playback

During playback or in pause mode, press the **TOOLS** button.

Use the **^** **v** **<** **>** buttons to select the  and then press the **OK** button.

Slideshow Settings	Select to change the Slide Show settings. - Speed : Select to set the slide show speed. - Effects : Select to set the slide show effect.
Rotate	Select to rotate the picture. (This can rotate the picture either clockwise or counter clockwise.)
Zoom	Select to enlarge the current picture. (Enlarge up to 4 times)

<p>Picture Mode</p>	<p>Select to set the picture mode.</p> <ul style="list-style-type: none"> - Dynamic : Choose this setting to increase sharpness. - Standard : Choose this setting for most viewing applications. - Movie : This is the best setting for watching movies. - User : Lets you adjust the sharpness and noise reduction function respectively. <p> NOTE </p> <ul style="list-style-type: none"> ▶ This menu cannot be displayed when you use the BD Wise function.
<p>Background Music</p>	<p>Select to listen to music while viewing a slide show.</p> <p> NOTE </p> <ul style="list-style-type: none"> ▶ The number of music files available from external devices will differ depending on the device.
<p>Multiroom Link</p>	<p>Select to control the volume of Multiroom speakers</p> <ul style="list-style-type: none"> - Volume : Adjusts the volume level. Press the ▲▼ buttons on the remote control. - Mute : Mutes the sound from this player. Press again to restore the sound to the previous volume level. <p> NOTE </p> <ul style="list-style-type: none"> ▶ This menu is only available when you connect to a Multiroom Link compatible speaker.
<p>Send</p>	<p>Select to send the selected file to other devices.</p>
<p>Information</p>	<p>Select to see the Contents information.</p>

| NOTES |

- ▶ Depending on the disc or storage device, the menu may differ.
- ▶ To enable the **Background Music** function, the photo file must be on the same storage media as the music file.
Note that the sound quality can be affected by the bitrate of the MP3 file, the size of the photo, and the encoding method.
- ▶ You can't enlarge the subtitle and PG graphic in the full screen mode.

Using the Sort by & Options Menus

Using the Sort by Menu

On a file screen containing photo files, select the  and then press the **OK** button.

<p>Date</p>	<p>Groups all the the photo files on the media or storage device by date. Click a group to see the photos in that group.</p>
<p>Title</p>	<p>Displays all the photo files on the media or storage device by title.</p>
<p>Folder</p>	<p>Displays all the folders on the media or storage device.</p>

| NOTE |

- ▶ Depending on the disc or storage device, the menu may differ.

Using the Options Menu

On a file screen containing photo files, select the  and then press the **OK** button.

Slide Show	Starts the slide show. Shows all the files in the current folder, one after another. If you want to create a slide show with a selected group of photos, see Play Selected below.
Play Selected	Lets you select specific photos to see. It works essentially the same for all media. See "Creating a Playlist from an Audio CD" on page 36 for instructions.
Send	Select this menu to upload selected files to a web site (Picasa, Facebook, etc.) or device. To use this menu, you need to establish an account with the on-line site, and then log in using the Log In function. See "Using the Send Function" on page 39.

| NOTE |

- ▶ Depending on the disc or storage device, the menu may differ.

Send files

Copying Videos, Music or Photos

Contents	DISC/Network Device → USB	DISC/USB → Network Device
Music	Supported	Supported
Photos	Supported	Supported
Videos	Supported	Supported

- Disc (CD-DA/CD-R/CD-RW, DVD±R (Finalized)/DVD+RW/DVD-RW (Finalized)) → USB
- PTP USB is not available when you copy to USB.

Using the Send Function

You can upload files to a device connected to your network or an on-line site.

1. With the Videos, Music or Photos file screen displayed, and then press the . The **Options** menu appears.
2. Use the **^** **v** buttons to select **Send**, and then press the **OK** button.
3. Use the **^** **v** **<** **>** buttons to select a file, and then press the **OK** button. A check appears to the left of the file.
4. Repeat Step 3 to select and check additional files.
5. To remove a file from the list, move to the file, and then press the **OK** button again. The check on the file is removed.
6. When done, press the **^** **v** **<** **>** buttons to select **Send**, and then press the **OK** button. The Send pop-up appears listing the on-line sites (Picasa, Facebook, etc.) or devices that you can send the files to.
7. Select a destination, and then press the **OK** button.
8. If you are sending the files to an on-line site, the site starts. Log in and follow the directions on the screen.

| NOTE |

- ▶ To send files to an on-line site you must have an account with that site.

Network Services

You can enjoy various network services such as streaming video or on-line apps by connecting the product to your network.

To use network services, you must first:

1. Connect the product to a network.
(See page 16)
2. Configure the network settings.
(See pages 23-26)

Creating a Samsung Account

Create a Samsung account so you can take advantage of all Samsung has to offer on line. Set up accounts for each household member so each member can access their own accounts on Facebook, Twitter, etc. You also need a Samsung account if you want to download for-pay apps and rent movies.

1. On the Home screen, press the . The **Sign In** screen appears.
2. Select **Create Account**, and then press the **OK** button.
The **Samsung account Terms & Conditions, Privacy Policy** screen appears.
3. Press the **OK** button to agree, press the **>** button, and then press the **OK** button.
The **Create Account** screen appears.
4. Select the ID field, and then press the **OK** button. The keyboard pop-up appears.
5. Enter your e-mail address using the keyboard. Use the arrow buttons to move from character to character.
Press **OK** to select a character. Select the **Caps** on the left to enter capitals. Select the **123#&** to select additional symbols.
6. When finished, select the **Done** on the keyboard, and then press the **OK** button. The **Create Account** screen reappears.
7. Enter a password, your first name, and last name in the same fashion.

8. Select the Date of Birth field, and then select numbers using the up and down arrow buttons or by pressing numbers on your remote. Press the **OK** button when done.
9. After you have finished with all the fields, press the **>** button, and then press the **OK** button. Connecting appears, and then the account confirmation message.
10. Press the **OK** button. The **Set Profile Picture** screen appears.

| NOTE |

- ▶ Samsung sends a confirming e-mail to the address you entered. You must open the e-mail and respond as requested to finalize your account.
11. Select a picture to identify your account, and then press the **OK** button. The **Account Created** screen appears.
 12. Press the **OK** button. The Home screen appears.

Before Using Samsung Apps

If you haven't set up Smart Hub, when you use Apps for the first time, the product will ask you to perform the Smart Hub set up procedure.

1. On the Home screen, select **SAMSUNG APPS**, and then press the **OK** button.
2. If you haven't set up Smart Hub, the Smart Hub pop-up appears asking if you want to set up Smart Hub. Select **Yes**, and then press the **OK** button.
3. Select **Start**, and then press the **OK** button. The **Terms and Policy** screen appears.
4. On the **Additional Services, Terms and Conditions and Choices** screen, you must review and agree to both the Smart Hub Terms and Conditions and the Privacy Policy to use Smart Hub.
5. Scroll down, and then click the **View details** to review the full documents.

| NOTE |

- ▶ You do not need to consent to the Supplemental Privacy Notice, but one or more Smart Hub features or functionalities may not be available if you do not.
6. Select **I agree to all**, and then press the **OK** button. The Setup Complete screen appears. Press the **OK** button.

Using Samsung Apps

You can download applications from the Internet, and access various applications and view them on your TV. To access some applications, you need to have a Samsung account.

| NOTE |

- ▶ For some 4K streaming service Apps (Netflix, Amazon, etc.), the use of 4K service is enabled if the TV supports HDCP 2.2. If the TV (or the HDMI terminal connected) does not support HDCP 2.2, the 4K category will not be displayed.

The Samsung Apps Screen at a Glance

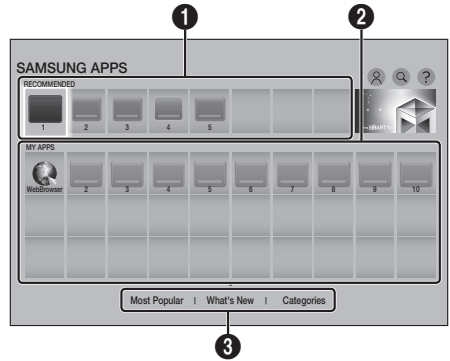

1	RECOMMENDED : Displays recommended contents managed by Samsung. You cannot delete Recommended Apps.
2	MY APPS : Displays your personal gallery of applications modifiable on the MY APPS screen.
3	Most Popular , What's New and Categories : Select to view and download additional apps.

The first time you open the **SAMSUNG APPS** screen, the Ultra HD Blu-ray Player automatically downloads a group of free apps. Once these apps have been downloaded, they appear on the **SAMSUNG APPS** screen.

To see additional apps, select **Most Popular**, **What's New**, or **Categories** on the bottom of the screen, and then press the **OK** button.

Most Popular displays the most popular apps, **What's New** the newest. **Categories** displays a series of icons representing categories such as Videos, Games, and Sports. Select a category icon, and then press the **OK** button. The Ultra HD Blu-ray Player displays the apps in that category.

Network Services

Downloading an App

1. Select **Most Popular, What's New**, or **Categories**, and then press the **OK** button.
2. If you selected **Categories**, select a category icon, and then press the **OK** button. Otherwise, go to Step 3.

| NOTE |

- ▶ On the **Most Popular, What's New**, and **Categories** screens, an orange arrow is displayed on apps you have already downloaded.
3. Select an app you want to download, and then press the **OK** button. The Detail Information screen for the app appears.
 4. Select **Download** on the screen, and then press the **OK** button. Download changes to **Cancel** and the app begins to download.
 5. If you want to cancel the download, select **Cancel**, and then press the **OK** button.
 6. When the download is complete, **Cancel** changes to **Open**. Select **Open**, and then press the **OK** button to start the application. Alternately, press the **⏪ (RETURN)** button until the **SAMSUNG APPS** screen reappears. The app you downloaded will be displayed on the **SAMSUNG APPS** screen under **MY APPS**.

| NOTE |

- ▶ If the App cannot be downloaded due to insufficient remaining internal memory, connect a USB storage device and try again.

Starting an Application

1. Select **SAMSUNG APPS** on the Home screen, and then press the **OK** button.
2. On the **SAMSUNG APPS** screen, use the **^ v < >** buttons to select an app, and then press the **OK** button. The app starts.

The Options Menu

Move

1. On the **MY APPS** screen, select the app you want to move, and then press the **OK** button for 3 seconds.
2. Select **Move**, and then press the **OK** button.
3. Use the **^ v < >** buttons to move the app.
4. When the app is where you want it, press the **OK**.

Delete

1. On the **MY APPS** screen, select the app you want to delete, and then press the **OK** button for 3 seconds.
2. Select **Delete**, and then press the **OK** button.
3. Use the **^ v < >** buttons to select **Yes**, and then press the **OK** button.

Multi Delete

1. On the **MY APPS** screen, select an app you want to delete, and then press the **OK** button for 3 seconds.
2. Select **Multi Delete**, and then press the **OK** button.
3. Use the **^ v < >** buttons to select apps you want to delete, and then press the **OK** button. A check appears next to each app you select.

| NOTE |

- ▶ You can deselect an app by highlighting it again, and then pressing the **OK** button.
4. Use the **v** button to select **Delete** at the bottom of the screen, and then press the **OK** button.

| NOTE |

- ▶ You can also select **Cancel**, **Select All**, or **Deselect All** at the bottom of the screen.

View Details

1. On the **MY APPS** screen, select the app you want to see detailed information for, and then press the **OK** button for 3 seconds.
2. Select **View Details**, and then press the **OK** button.

Change View

This function toggles the Apps screen between the Most Played view and the Custom View, which lets you arrange the apps to your liking.

1. On the **MY APPS** screen, select an app, and then press the **OK** button for 3 seconds.
2. Select **Change View**, and then press the **OK** button.
3. Select **Yes** if you want to change the view. Select **No** if you want to keep the current view.
4. Press **OK** button.

Lock/Unlock

This function blocks access to an app unless you enter your PIN. Unlock removes the lock.

1. On the **MY APPS** screen, select an app you want to lock, and then press the **OK** button for 3 seconds.
2. Select **Lock/Unlock**, and then press the **OK** button. Enter your PIN.
3. Use the **^ v < >** buttons to select an app you want to lock.
4. Press the **OK** button. A check appears next to the app.
5. To de-select an app, highlight the app, and then press the **OK** button.
6. After you have selected all the apps you want to lock, select **Save** at the bottom of the screen, and then press the **OK** button. Locks appear next to all the apps you selected.

| NOTE |

- ▶ You can also select **Cancel**, **Select All**, or **Deselect All** at the bottom of the screen.

To unlock apps, follow essentially the same directions, but select apps that have locks. When you select **Save** and then press the **OK** button, the locks are removed.

Update Apps

1. On the **MY APPS** screen, select any app, and then press the **OK** button for 3 seconds.
2. Select **Update Apps**, and then press the **OK** button.
3. The Update Samsung Apps screens lists all the apps that have updates available. Select each app you want to update, and then press the **OK** button. You can also choose **Select All** to update all the apps listed.
4. Select **Update**, and then press the **OK** button.

Screen Mirroring

The **Screen Mirroring** function lets you view the screen of your smart phone or Android tablet on the TV that you have connected to the product.

1. On the Home screen, select **Screen Mirroring**, and then press the **OK** button.
2. Launch **AllShare Cast** or **Screen Mirroring** on your device.
3. On your device, find the name of the player in the list of available devices and then select it.
4. The TV displays a connecting message (for example, Connecting to Android_92gb..) and then displays the connected message.
5. In a few moments, the screen of your device appears on the TV screen.
6. To stop **Screen Mirroring**, press the **⏪ (RETURN)** on the remote control, or exit the **Screen Mirroring** function on your smart phone.

Network Services

| NOTES |

- ▶ You can connect your Player to a device that supports AllShare Cast. Note that all devices that have AllShare Cast may not be fully supported, depending on the manufacturer. For further information on mobile connection support, refer to the manufacturer's web site.
- ▶ When you are using the **Screen Mirroring** function, video stuttering or audio dropouts may occur, depending on your environment.
- ▶ Bluetooth transmissions can interfere with the Screen Mirroring signal. Before using the **Screen Mirroring** function, we strongly recommend that you turn off the Bluetooth function on your smart phone or smart device (tablet, etc.).

Using the Web Browser

You can access the Internet using the Web Browser application.

Select **WebBrowser** on the Home screen, and then press the **OK** button.

| NOTES |

- ▶ When you run the Web Browser with the product connected by HDMI to a BD Wise compatible TV - and **BD Wise** is on - the browser is maximized to fill the screen and the TV's resolution is set to the optimal resolution automatically.
- ▶ The Web Browser is not compatible with Java applications.
- ▶ If you attempt to download a file, and the file cannot be saved, an error message will appear.
- ▶ E-commerce (purchasing products online) is not supported.
- ▶ ActiveX is not supported.
- ▶ Access may be blocked to some websites or to web browsers operated by certain businesses.
- ▶ Playing Flash videos is not supported.

Link Browsing and Pointer Browsing

The Web Browser provides two types of browsing, Pointer Browsing and Link Browsing. When you launch the browser for the first time, Pointer Browsing is active. If you are using a mouse to navigate in the Web Browser, we recommend leaving Pointer Browsing active. If you are using your remote to navigate in the Web Browser, we recommend that you replace Pointer Browsing with Link Browsing. Link Browsing moves a highlight from one link to the next in the Web Browser and is much faster than Pointer Browsing if you are using your remote.









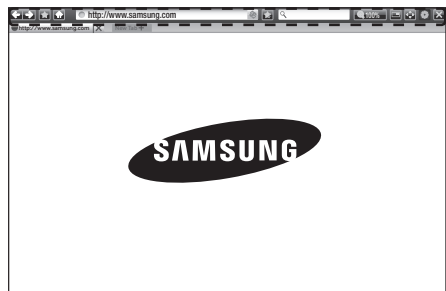





To activate Link Browsing, follow these steps:

1. Use the **^ v < >** buttons on your remote to move the pointer to the Link Browser icon on the top right of the screen. The Link Browser icon is the third icon from the right. The pointer will be in the correct position if the icon turns blue and the words "Link Browsing" appear on the screen.
2. Press the **OK** button. Link Browsing is activated and will remain active whenever you bring up the Web Browser.



The Control Panel at a Glance

The Control Panel, which runs across the top of the screen, has a series of icons which start a number of useful functions. The icons are described on the next page, starting with the icon on the far left of the screen.







-  : Moves to the previous page.
-  : Moves to the next web page.
-  : Displays the Bookmarks and History screen. You can bookmark the current page, select an existing bookmark, and edit and delete bookmarks. You can also view your browsing history and select a page to revisit.
-  : Moves to the Home screen of the Web Browser.
-  <http://www.samsung.com> : Lets you enter a page address manually using the keyboard pop-up.
-  : Reloads the current page so that it is refreshed on the screen.
-  : Adds the current page to your bookmarks.
-  : Lets you search for information by entering words or characters using the keyboard pop-up. See "Using the Keyboard Pop-up" on the right.
-  100% : Lets you enlarge or shrink the screen by various percentages.
-  /  : Lets you switch between Pointer Browsing and Link Browsing.
-  : Lets you configure the Browser's settings. See "Using the Setting Menu" on pages 46~48.
-  : Closes the Web Browser.
-  <http://www.samsung.com>  : Opens a new web browser tab.

Using the Keyboard Pop-up

When you click the  <http://www.samsung.com>, the  or access a data or text entry field, and then press the **OK** button, the keyboard pop-up appears.

To use the keyboard pop-up with your remote, follow these steps:



1. Use the     buttons on your remote to move the highlight to a letter or number of your choice.
2. Press the **OK** button to enter the letter or number into the entry field.
3. To access capital letters, move the highlight to the **Caps** key on the top left, and then press the **OK** button. Press the **OK** button again with the **Caps** key highlighted to access small letters again.
4. To access symbols and additional punctuation marks, highlight the **123#&** on the left, and then press the **OK** button.
5. To delete a character you entered, move the highlight to the  , and then press the **OK** button.
6. To delete all the characters you entered, move the highlight to **Clear**, and then press the **OK** button.
7. When finished entering, move the highlight to **Done**, and then press the **OK** button.

Network Services

| NOTE |

- ▶ If you have a wireless keyboard connected to your product, you can use the wireless keyboard to enter letters, numbers, symbols, and punctuation. Note that the wireless keyboard will work only when the keyboard popup appears and can only be used to enter letters, numbers, symbols, and punctuation.

Options on the Keyboard Pop-Up

To access the keyboard pop-up options, highlight the  on the bottom left of the keyboard, and then press the **OK** button.

Language	Select the language for the keyboard. You can select English, French, Russian, etc.
Recommended text	The keyboard suggests recommended words as you enter text. You can turn this function On or Off .
Reset recommended text data	Reset erases the Samsung Keyboard's memory. Select Reset to erase everything that the Samsung Keyboard has learned about your writing style, including any new words you have used.
Predict Next Letter	The keyboard predicts the next letter as you enter letters. The predictions appear in a ring around the letter you have just entered. You can select a predicted letter or move to another letter. You can turn this function On or Off .

Using the Setting Menu

The Setting menu contains functions that control how the Browser operates and Browser security functions. To open the Setting menu, highlight the  icon in the Control Panel, and then press the **OK** button. To select an option in the Setting menu, highlight the option, and then press the **OK** button.

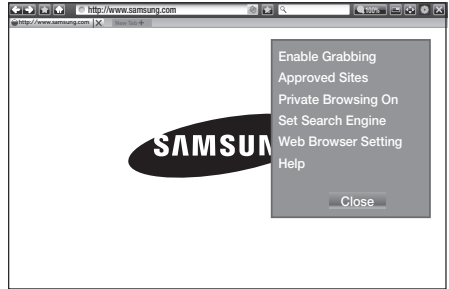

Enable Grabbing / Disable Grabbing	Turns the Grabber function on and off. When the Grabber function is on, you can move a web page up and down without dragging the scroll bar. The Grabber function is only available in Pointer Browsing.
Approved Sites	Lets you restrict your children's access to inappropriate web pages by allowing access only to the web sites you have registered. Every time you access this function, the PIN screen appears. The first time you access this function, enter the default PIN, 0000 using the number buttons on your remote.

Approved Sites	<p>You can change the PIN using the Reset password for the Approved Sites function. See below.</p> <p>Approved Sites feature : Turns the Approved Sites function on or off.</p> <p>Reset password for Approved Sites : Change the Approved Sites password.</p> <p>Add current site : Lets you add the currently displayed web site to the Approved Sites list.</p> <p>Manage Approved Sites : Lets you key in URLs to add to the Approved Sites List and delete sites from the Approved Sites list.</p> <p>If you turn this function on and have not added any sites to the Approved Sites list, you will not be able to access any Internet sites.</p>
Private Browsing Off/ Private Browsing On	<p>Enable or disable the Privacy mode.</p> <p>When the Privacy mode is enabled, the browser does not retain the URLs of sites you visit. If you want to enable Privacy mode, select Yes.</p> <p>If the Privacy mode is running, the “Stop” icon appears in front of the URL at the top of the screen. To disable Privacy mode, select it again when Privacy mode is enabled.</p>
Set Search Engine	<p>You can set the desired Search Engine.</p>

Web Browser Setting	<p>Set as homepage : You can set the Browser's home page.</p> <p>Pop-up Block : Turns the Pop-up Block on and off.</p> <p>Page Block : You can determine whether to block advertisements and select the URLs for which advertisements are blocked.</p> <p>General : You can delete personal information such as website history and browsing data (cookies, etc.), and reset all web browser settings to their factory defaults. You can also set the Security Mode.</p> <p> NOTE </p> <ul style="list-style-type: none"> ▶ Set the Security Mode to On to avoid accessing malicious/ phishing sites and prevent malicious code from running. <p>Privacy & Security : Prevents access to inappropriate web pages. Also allows you to select not to save your browsing history.</p> <p>Encoding : You can set the Encoding setting for web pages to Automatic or select the encoding format manually from a list.</p> <p>Pointer : You can set the speed of the cursor when the cursor is set to Pointer and turn Smart Cursor On and Off.</p> <p>Browser Information : Displays the version number and copyright information for the Web Browser.</p>
Help	<p>Provides basic information about the operation of the Web Browser.</p>

Network Services

| NOTE |

- ▶ Depending on the web site, some of the **Web Browser Setting** functions may not be activated. Functions that are not activated are greyed out and cannot be used.

Linking Your Internet Service Accounts to the Product

The Link Service Accounts function lets you link your product to your accounts with Internet services such as Pandora so that the product can log you in to the service automatically when you start the app for that service.

Register your account by going to **HOME → Sign In → Create with Facebook**.

BD-LIVE™

Once the product is connected to your network, you can enjoy various movie-related service content available on BD-LIVE compliant discs.

1. Attach a USB flash memory drive to the USB jack on the front of the product, and then check its remaining memory. The memory device must have at least 1GB of free space to accommodate the BD-LIVE services.
2. Select **Settings** on the Home screen, and then press the **OK** button.
3. Select **Network**, and then press the **OK** button.
4. Select **BD-Live Settings**, and then press the **OK** button.
5. Select **BD Data Management**, and then press the **OK** button.
6. Select **Select Device**, and then press the **OK** button.
7. Select USB device, and then press the **OK** button.
8. Insert an Ultra HD Blu-ray Disc or Blu-ray Disc that supports BD-LIVE.
9. Select an item from the list of BD-LIVE service contents provided by the disc manufacturer.

| NOTE |

- ▶ The way you use BD-LIVE and the provided contents may differ, depending on the disc manufacturer.

Additional Information

Notes

Settings	3D Settings
	<ul style="list-style-type: none"> • For some 3D discs, to stop a movie during 3D playback, press the ■ button once. The movie stops and the 3D mode option is de-activated. To change a 3D option selection when you are playing a 3D movie, press the ■ button once. The Home Screen menu appears. Press the ■ button again, then select 3D Settings in the Ultra HD Blu-ray menu. • Depending on the content and the position of the picture on your TV screen, you may see vertical black bars on the left side, right side, or both sides.
	TV Aspect Ratio
	<ul style="list-style-type: none"> • Depending on the disc type, some aspect ratios may not be available. • If you select an aspect ratio and option that is different than the aspect ratio of your TV screen, the picture might appear to be distorted. • If you select the 16:9 Original, your TV may display 4:3 Pillarbox (black bars on the sides of the picture).
	BD Wise (Samsung Products only)
<ul style="list-style-type: none"> • When BD Wise is On, the Resolution setting automatically defaults to BD Wise and BD Wise appears in the Resolution menu. • If the product is connected to a device that does not support BD Wise, you cannot use the BD Wise function. • For the proper operation of BD Wise, set the BD Wise option of both the product and the TV to On. 	
Digital Output	
<ul style="list-style-type: none"> • Be sure to select the correct Digital Output or you will hear no sound or just loud noise. • If the HDMI device (AV receiver, TV) is not compatible with compressed formats (Dolby Digital, DTS), the audio signal outputs as PCM. • Regular DVDs do not have BONUSVIEW audio and Navigation Sound Effects. • Some Ultra HD Blu-ray Discs and standard Blu-ray Discs do not have BONUSVIEW audio and Navigation Sound Effects. • The Digital Output setup does not affect the HDMI audio output to your TV. It affects the optical and HDMI audio output when your product is connected to an AV receiver. • If you play MPEG audio soundtracks, the audio signal outputs as PCM regardless of your Digital Output selections (PCM or Bitstream). 	

Settings	PCM Downsampling
	<ul style="list-style-type: none"> • Even when PCM Downsampling is set to Off, some discs will only output downsampled audio through the optical digital output. • HDMI <ul style="list-style-type: none"> - If your TV is not compatible with compressed multi-channel formats (Dolby Digital, DTS), the product may output PCM 2ch downmixed audio even though you selected Bitstream (either Reencoded or Unprocessed) in the setup menu. - If your TV is not compatible with PCM sampling rates over 48kHz, the product will output at 48kHz.
	BD-Live Internet Connection
	<ul style="list-style-type: none"> • What is a valid certificate? When the product uses BD-LIVE to send the disc data and a request to the server to certify the disc, the server uses the transmitted data to check if the disc is valid and sends the certificate back to the product. • The Internet connection may be restricted while you are using BD-LIVE contents.
	BD Data Management
<ul style="list-style-type: none"> • In the external memory mode, disc playback may be stopped if you disconnect the USB device in the middle of playback. • Only those USB devices formatted in the FAT file system (DOS 8.3 volume label) are supported. We recommend you use USB devices that support the USB 2.0 protocol with 4 MB/sec or faster read/write speed. • The Resume Play function may not work after you format the storage device. • The total memory available to BD Data Management may differ, depending on conditions. 	
Anynet+ (HDMI-CEC)	
<ul style="list-style-type: none"> • Depending on your TV, certain HDMI output resolutions may not work. Please refer to the user manual of your TV. • This function is not available if the HDMI cable does not support CEC. • If your Samsung TV has an Anynet+ logo, then it supports the Anynet+ function. 	

Media Play	Selecting the Audio Language
	<ul style="list-style-type: none"> • The < > indicator will not appear on the screen if the BONUSVIEW section does not contain any BONUSVIEW audio settings. • The languages available through the Audio Language function depend on the languages that are encoded on the disc. This function or certain languages may not be available. • Some Ultra HD Blu-ray Discs and standard Blu-ray Discs may allow you to select either the PCM or Dolby Digital audio soundtrack in English.
	Selecting the Subtitle Language
	<ul style="list-style-type: none"> • Depending on the Ultra HD Blu-ray Disc/Blu-ray Disc / DVD Disc, you may be able to change the subtitle language in the Disc Menu. Press the DISC MENU button. • This function depends on the selection of subtitles that are encoded on the disc and may not be available on all Ultra HD Blu-ray Discs/Blu-ray Discs/ DVDs. • Information about the main feature BONUSVIEW mode will also appear if the Ultra HD Blu-ray Disc or Blu-ray Disc has a BONUSVIEW section. • This function changes both the primary and secondary subtitles at the same time. • The total number of primary and secondary subtitles, respectively, is displayed.

Resolution according to the contents type

Contents Type		Ultra HD Blu-ray Disc/Blu-ray Disc	E-contents/ Digital contents	DVD Disc
BD Wise		Resolution of Disc	2160p@60/24	480p@60
Auto	Movie Frame : Auto	2160p(1080p)@24	2160p(1080p)@24	2160p(1080p)@24
	Movie Frame : Off	Max. Resolution of TV input	Max. Resolution of TV input	Max. Resolution of TV input
Movie Frame : Auto (24Fs) ※ 2160p, 1080p & 1080i only		2160p(1080p)@24	2160p(1080p)@24	2160p(1080p)@24
2160p		2160p@60	2160p@60	2160p@60
1080p		1080p@60	1080p@60	1080p@60
1080i		1080i@60	1080i@60	1080i@60
720p		720p@60	720p@60	720p@60
480p		480p@60	480p@60	480p@60

| NOTES |

- ▶ If the TV you connected to the product does not support Movie Frame or the resolution you selected, the message *"If no pictures are shown after selecting 'Yes', please wait for 15 seconds to return to the previous resolution. Do you want to change the resolution?"* appears. If you select **Yes**, the TV's screen will go blank for 15 seconds, and then the resolution will revert to the previous resolution automatically.
- ▶ If the screen stays blank after you have changed the resolution, remove all discs, and then press and hold the **■** button on the top of the product for more than 5 seconds. The initialization message appears on the screen and the player turns off automatically. When you turn your product on again, all the settings will be reset. Run the Initial Settings procedure again. Then, go to **Settings > Picture > Resolution** in the Menu, and select the correct resolution for your TV.
- ▶ When you run the Initial Settings procedure, re-select the language and aspect ratio (screen size and format) only. Resetting does not affect your network settings, so you should be able to skip Network Setup and Software Update.
- ▶ When the factory default settings are restored, all stored user BD data is deleted.
- ▶ An Ultra HD Blu-ray Disc or standard Blu-ray Disc must have the 24 frame feature for the product to use the **Movie Frame (24Fs)** mode.

Digital Output Selection

Setup		PCM		Bitstream (Unprocessed)		Bitstream (Re-encoded DTS)	Bitstream (Re-encoded Dolby D)
Connection		HDMI supported AV receiver	Optical	HDMI supported AV receiver	Optical	HDMI supported AV receiver or Optical	HDMI supported AV receiver or Optical
Audio Stream on Ultra HD Blu-ray Disc/ Blu-ray Disc	PCM	Up to PCM 7.1ch	PCM 2ch	PCM	PCM 2ch	DTS re-encoded	Re-encoded Dolby Digital *
	Dolby Digital	Up to PCM 7.1ch	PCM 2ch	Dolby Digital	Dolby Digital	DTS re-encoded	Re-encoded Dolby Digital *
	Dolby Digital Plus	Up to PCM 7.1ch	PCM 2ch	Dolby Digital Plus	Dolby Digital	DTS re-encoded	Re-encoded Dolby Digital *
	Dolby TrueHD	Up to PCM 7.1ch	PCM 2ch	Dolby TrueHD	Dolby Digital	DTS re-encoded	Re-encoded Dolby Digital *
	DTS	Up to PCM 6.1ch	PCM 2ch	DTS	DTS	DTS re-encoded	Re-encoded Dolby Digital *
	DTS-HD High Resolution Audio	Up to PCM 7.1ch	PCM 2ch	DTS-HD High Resolution Audio	DTS	DTS re-encoded	Re-encoded Dolby Digital *
	DTS-HD Master Audio	Up to PCM 7.1ch	PCM 2ch	DTS-HD Master Audio	DTS	DTS re-encoded	Re-encoded Dolby Digital *
Audio Stream on DVD	PCM	PCM 2ch	PCM 2ch	PCM 2ch	PCM 2ch	PCM 2ch	PCM 2ch
	Dolby Digital	Up to PCM 5.1ch	PCM 2ch	Dolby Digital	Dolby Digital	Dolby Digital	Dolby Digital
	DTS	Up to PCM 6.1ch	PCM 2ch	DTS	DTS	DTS	DTS
Definition for Ultra HD Blu-ray Disc/ Blu-ray Disc	Any	Decodes the main feature audio and BONUSVIEW audio stream together into PCM audio and adds Navigation Sound Effects.		Outputs only the main feature audio stream so that your AV receiver can decode the audio bitstream. You will not hear BONUSVIEW audio or Navigation Sound Effects.		Decodes the main feature audio and BONUSVIEW audio stream together into PCM audio and adds Navigation Sound Effects, then re-encodes the PCM audio into DTS bitstream.	Decodes the main feature audio and BONUSVIEW audio stream together into PCM audio and adds Navigation Sound Effects, then re-encodes the PCM audio into Dolby Digital bitstream or PCM.

* If the Source Stream is 2ch or mono, "Re-encoded Dolby D" Settings are not applied. Output will be PCM 2ch.

Ultra HD Blu-ray Discs and standard Blu-ray Discs may include three audio streams :

- Main Feature Audio : The audio soundtrack of the main feature.
- BONUSVIEW audio : An additional soundtrack such as the director or actor's commentary.
- Navigation Sound Effects : When you choose some menu navigation functions, Navigation Sound Effects may sound. Navigation Sound Effects are different on each Ultra HD Blu-ray Disc/Blu-ray Disc.

Appendix

Troubleshooting

Refer to the table below if this product does not function properly. If the problem you are experiencing is not listed below or if the instructions below do not help, turn off the product, disconnect the power cord, and contact Samsung Electronics at 1-800-SAMSUNG (1-800-726-7864).

PROBLEM	SOLUTION
No operation can be performed with the remote control.	<ul style="list-style-type: none"> • Check the batteries in the remote control. They may need replacing. • Operate the remote control at a distance of no more than 20 feet from the product. • Remove the batteries and hold down one or more buttons for several minutes to drain the microprocessor inside the remote control to reset it. Reinstall the batteries and try to operate the remote control again.
The disc does not play.	<ul style="list-style-type: none"> • Ensure that the disc is installed with the label side facing up. • Check the region number of the Ultra HD Blu-ray Disc/Blu-ray Disc/DVD.
The disc Menu does not appear.	<ul style="list-style-type: none"> • Confirm that the disc has disc menus.
The prohibition message appears on the screen.	<ul style="list-style-type: none"> • This message appears when an invalid button is pressed. • The Ultra HD Blu-ray Disc/Blu-ray Disc/DVD's software doesn't support the feature (e.g., angles). • You've requested a title or chapter number or search time that is out of range.
Play mode differs from the Setup Menu selection.	<ul style="list-style-type: none"> • Some of the functions selected in the Setup Menu may not work properly if the disc is not encoded with the corresponding function.
The screen ratio cannot be changed.	<ul style="list-style-type: none"> • The Screen Ratio on your Ultra HD Blu-ray Disc/Blu-ray Disc/DVD Disc is fixed and cannot be changed. • This is not a problem with the product.
No audio.	<ul style="list-style-type: none"> • Make sure you have selected the correct Digital Output in the Audio Options Menu.
The screen is blank.	<ul style="list-style-type: none"> • If the HDMI output is set to a resolution your TV cannot support (for example, 1080p), you may not see a picture on your TV. • Press the ■ button (on top panel) for more than 5 seconds with no disc inside. The initialization message appears on the screen, and the player turns off automatically. When you turn your product on again, all the settings will be reset. • When the factory default settings are restored, all stored user BD data will be deleted.

PROBLEM	SOLUTION
Forgot password.	<ul style="list-style-type: none"> • Press the ■ button (on the top panel) for more than 5 seconds with no disc inside. The initialization message appears on the screen, and the player turns off automatically. When you turn your product on again, all the settings will be reset. Don't use this unless absolutely necessary. • When the factory default settings are restored, all stored user BD data will be deleted.
The picture is noisy or distorted.	<ul style="list-style-type: none"> • Make sure that the disc is not dirty or scratched. • Clean the disc.
No HDMI output.	<ul style="list-style-type: none"> • Check the connection between the TV and the HDMI jack of the product. • Check if your TV supports the 480p, 720p, 1080i, 1080p, or 2160p HDMI input resolution.
Abnormal HDMI output appears on the screen.	<ul style="list-style-type: none"> • If random noise appears on the screen, it means that TV does not support HDCP (High-bandwidth Digital Content Protection).
If you experience other problems.	<ul style="list-style-type: none"> • Go to the table of contents and find the section of the user manual that contains information about the feature you are having the problem with, and then follow the procedure again. • If you still cannot resolve the problem, please contact your nearest Samsung authorized service center.
Play Multimedia on network devices	
You can see folders shared on network devices, but cannot see the files.	<ul style="list-style-type: none"> • The multimedia list only shows Video, Photo, and Music files. Other types of files are not displayed.
Video plays intermittently.	<ul style="list-style-type: none"> • Check if the network is stable. • Check if the network cable is properly connected and if the network is not overloaded. • The wireless connection between the DLNA compatible device and the product is unstable. Check the connection.
The Network connection between the product and the PC is unstable.	<ul style="list-style-type: none"> • IP addresses within the same subnetwork should be unique. If they are not, IP interference can cause this phenomenon. • Check if you have a firewall enabled. If so, disable the firewall function.

Appendix

PROBLEM	SOLUTION
BD-LIVE	
This product cannot connect to the BD-LIVE server.	<ul style="list-style-type: none">• Test whether the network connection is working using the Network Status function. (See page 21)• Check whether a USB memory device is connected to the product.• The memory device must have at least 1GB of free space to accommodate the BD-LIVE service. You can check the available size in BD Data Management. (See page 21)• See if the BD-Live Internet Connection option is set to Allow(All).• If all above fails, contact the content provider or update the product to the latest firmware.
When using the BD-LIVE service, an error occurs.	<ul style="list-style-type: none">• The memory device must have at least 1GB of free space to accommodate the BD-LIVE service. You can check the available size in BD Data Management. (See page 21)

| NOTE |

- ▶ When the factory default settings are restored, all stored user BD data will be deleted.

Disc and Format Compatibility

Disc types and contents your product can play

Media	Disc Type	Details
VIDEO	Ultra HD Blu-ray Disc	Ultra HD BD-ROM format.
	Blu-ray Disc 3D Blu-ray Disc	BD-ROM or BD-RE/-R recorded in the BD-RE format.
	DVD-VIDEO DVD-RW DVD-R DVD+RW DVD+R	DVD-VIDEO, recorded DVD+RW/DVD-RW(V)/DVD-R/+R that have been recorded and finalized, or a USB storage media containing MKV, MP4 contents.
MUSIC	CD-RW/-R, DVD-RW/-R, BD-RE/-R	Music recorded on CD-RW/-R, DVD-RW/-R, BD-RE/-R or a USB storage media containing MP3 or WMA contents.
PHOTO	CD-RW/-R, DVD-RW/-R, BD-RE/-R	Photos recorded on CD-RW/-R, DVD-RW/-R, BD-RE/-R or a USB storage media containing JPEG contents.

| NOTES |

- ▶ The product may not play certain CD-RW/-R and DVD-R because of the disc type or recording conditions.
- ▶ If a DVD-RW/-R has not been recorded properly in DVD video format, it will not be playable.
- ▶ Your product will not play content that has been recorded on a DVD-R at a bit-rate that exceeds 10 Mbps.
- ▶ Your product will not play content that has been recorded on a BD-R or USB device at a bitrate that exceeds 25 Mbps.
- ▶ Playback may not work for some types of discs, or when you use specific functions, such as angle change and aspect ratio adjustment. Information about the discs is written in detail on the disc box. Please refer to this if necessary.
- ▶ When you play a BD-J title, loading may take longer than a normal title. Also, some functions may perform slowly.

Disc types your product cannot play





- HD DVD
- DVD-ROM/PD/MV, etc
- DVD-RAM
- Super Audio CD (except CD layer)
- DVD-RW (VR mode)
- CVD/CD-ROM/CDV/CD-G/CD-I/LD (CD-Gs play audio only, not graphics.)
- 3.9 GB DVD-R for Authoring.

Appendix

Region Code

Both products and discs are coded by region. These regional codes must match for a disc to play. If the codes do not match, the disc will not play.

The region number for this product is displayed on the rear panel of the product.

Disc Type	Region Code	Area
Blu-ray Disc		North America, Central America, South America, Korea, Japan, Taiwan, Hong Kong and South East Asia.
		Europe, Greenland, French territories, Middle East, Africa, Australia and New Zealand.
		India, China, Russia, Central and South Asia.
DVD-VIDEO		The U.S., U.S. territories and Canada
		Europe, Japan, the Middle East, Egypt, Africa, Greenland
		Taiwan, Korea, the Philippines, Indonesia, Hong Kong
		Mexico, South America, Central America, Australia, New Zealand, Pacific Islands, Caribbean
		Russia, Eastern Europe, India, North Korea, Mongolia
		China

Logos of Discs the product can play

	
Blu-ray Disc	3D Blu-ray Disc
	
BD-LIVE	Ultra HD Blu-ray Disc
	
NTSC broadcast system in U.S.A, Canada, Korea, Japan	

Supported Formats

Supported Video File Formats

File Extension	Container	Video Codec	Resolution	Frame rate (fps)	Bit rate (Mbps)	Audio Codec					
*.avi *.mkv *.asf *.wmv *.mp4 *.mov *.3gp *.vro *.mpg *.mpeg *.ts *.tp *.trp *.mov *.flv *.vob *.svi *.m2ts *.mts *.divx	AVI MKV ASF MP4 3GP MOV FLV VRO VOB PS TS SVAF	H.264 BP/MP/HP	4096x2160	4096X2160: 30	60	Dolby Digital LPCM ADPCM (IMA, MS) AAC HE-AAC WMA DD+ MPEG(MP3) DTS (Core , LBR) G.711 (A-Law, μ -Law)					
		HEVC (H.265 - Main, Main10, Main4:2:2 10)		3840X2160: 60							
		Motion JPEG		60	80						
		MVC	1920x1080	60	20		20				
		DivX 3.11 / 4 / 5 / 6									
		MPEG4 SP/ASP									
		Window Media Video v9(VC1)									
		MPEG2									
		MPEG1									
		Microsoft MPEG-4 v1, v2, v3									
		Window Media Video v7(WMV1), v8(WMV2)									
		H 263 Sorrenson									
		VP6									
		VP8						1920x1080	60	20	Vorbis
		VP9						4096x2160	4096X2160: 30	3840X2160: 60	
*.rmvb	RMVB	RV8/9/10 (RV30/40)	1920x1080	60	20	RealAudio 6					

Appendix

■ Limitations

- Even when a file is encoded by a supported codec listed in the Video File Support table, the file might not play if its content has a problem.
- Normal playback is not guaranteed if the file's container information is wrong or the file itself is corrupted.
- Playing back contents having higher rates than the base bit rate/frame rate may cause stuttering sound or video.
- The Seek (Jump) function is not available if the file's index table is damaged.
- When you playback a file remotely through a network connection, video playback may stutter depending on the network conditions.
- Some USB/Digital camera devices may not be compatible with the product.
- The RMVB format is supported only by models made for China and Hong Kong.
- HEVC codec is supported only for MKV, MP4, and TS containers.
- The DivX codec is not supported by models made for the U.S. or Canada.

■ Video decoder

- Supports up to H.264 Level 4.1. (Does not support FMO/ASO/RS)
- Does not support VC1/AP/L4.
- CODECs except for WMV v7, v8, MSMPEG4 v3, MVC, VP6
 - 1) Below 1280 x 720 : 60 frames max.
 - 2) Above 1280 x 720 : 30 frames max.
- Does not support GMC 2 or higher.
- Supports SVAF Top/Bottom, Side by Side, Left/Right view sequence type(2 ES)
- Supports BD MVC Spec.

■ Audio decoder

- Supports WMA 10 PRO (Up to 5.1).
- Does not support WMA lossless audio.
- Also supports the M2 profile.
- The RealAudio 10 lossless format is not supported by models made for China and Hong Kong.
- Does not support QCELP/AMR NB/WB.
- Supports vorbis (Up to 2ch).

- Supports DD+ (Up to 7.1ch)
- The DTS LBR codec is supported only for MKV / MP4 / TS containers.

| NOTE |

- ▶ Some MKV and MP4 format discs may not play, depending on their video resolution and frame rate.

Supported Subtitle File Formats

	Name	File Extension
External	MPEG-4 Timed text	.txt
	SAMI	.smi
	SubRip	.srt
	SubViewer	.sub
	Micro DVD	.sub or .txt
	SubStation Alpha	.ssa
	Advanced SubStation Alpha	.ass
	Powerdivx	.psb
	SMPTE-TT Text	.xml
Internal	Xsub	AVI
	SubStation Alpha	MKV
	Advanced SubStation Alpha	MKV
	SubRip	MKV
	VobSub	MKV
	MPEG-4 Timed text	MP4
	TTML in smooth streaming	MP4
	SMPTE-TT TEXT	MP4
	SMPTE-TT PNG	MP4

Supported Music File Formats

File Extension	Type	Codec	Support Range
*.mp3	MPEG	MPEG1 Audio Layer 3	-
*.m4a *.mpa *.aac	MPEG4	AAC	-
*.flac	FLAC	FLAC	Supports up to two channels.
*.ogg	OGG	Vorbis	Supports up to two channels.
*.wma	WMA	WMA	For WMA 10 Pro supports up to M2 profile and 5.1 channels. WMA lossless audio is not supported.
*.wav	wav	wav	-
*.mid *.midi	midi	midi	Type 0, type 1 and Seek is not supported. Only available with USB.
*.ape	ape	ape	-
*.aif *.aiff	AIFF	AIFF	-
*.m4a	ALAC	ALAC	-

Supported Picture File Formats

File Extension	Type	Resolution
*.jpg *.jpeg	JPEG	15360x8640
*.png	PNG	4096x4096
*.bmp	BMP	4096x4096
*.mpo	MPO	15360x8640

Notes on the USB connection

- Your player supports USB storage media, MP3 players, digital cameras, and USB card readers.
- Some USB/digital camera devices may not be compatible with the player.
- Your player supports the FAT16, FAT32, and NTFS file systems.
- Connect USB devices directly to the player's USB port. Connecting through a USB cable may cause compatibility problems.
- Inserting more than one memory device into a multi-card reader may cause the reader to operate improperly.
- The player does not support the PTP (Peer to Peer) protocol.
- Do not disconnect a USB device while it is transferring or recording data.
- The bigger the image resolution, the longer the image takes to display.
- This player cannot play MP3 files with DRM (Digital Rights Management) downloaded from commercial sites.
- Your player only supports video that is under 30fps (frame rate).
- Your player only supports USB Mass Storage Class (MSC) devices such as thumb drives and USB HDD. (HUB is not supported.)
- Certain USB HDD Devices, multi-card readers and thumb drives may not be compatible with this player.
- If some USB devices require excessive power, they may be limited by the circuit safety device.

Appendix

- If playback from a USB HDD is unstable, provide additional power by plugging the HDD into a wall socket.
If the problem continues, contact the USB HDD manufacturer.
- SAMSUNG is not responsible for any data file damage or data loss.
- Your player does not support NTFS compressed, sparse, or encrypted files.
 - You can repair or format a USB device on your Desktop PC. (MS-Windows OS only)

AVCHD (Advanced Video Codec High Definition)

- This player can play back AVCHD format discs. These discs are normally recorded and used in camcorders.
- The AVCHD format is a high definition digital video camera format.
- The MPEG-4 AVC/H.264 format compresses images with greater efficiency than the conventional image compressing format.
- Some AVCHD discs use the "x.v.Color" format. This player can play back AVCHD discs that use "x.v.Color" format.
- "x.v.Color" is a trademark of Sony Corporation.
- "AVCHD" and the AVCHD logo are trademarks of Matsushita Electronic Industrial Co., Ltd. and Sony Corporation.

| NOTES |

- ▶ Some AVCHD format discs may not play, depending on the recording conditions. AVCHD format discs need to be finalized.
- ▶ "x.v.Color" offers a wider color range than normal DVD camcorder discs.

Compliance and Compatibility Notice

NOT ALL discs are compatible

- Subject to the restrictions described below and those noted throughout this Manual, including the Disc Type and Characteristics section of this user manual, disc types that can be played are: pre-recorded commercial Ultra HD BD-ROM, BD-ROM, DVD-VIDEO, and Audio CD (CD-DA); BD-RE/-R, DVD-RW/-R; and CD-RW/-R.
- Discs other than the above cannot and/or are not intended to be played by this player. And some of the above discs may not play due to one or more reasons provided below.
- Samsung cannot assure that this player will play every disc bearing the Ultra HD BD-ROM, BD-ROM, BD-RE/-R, DVD-VIDEO, DVD-RW/-R, DVD+RW/+R and CD-RW/-R logos, and this player may not respond to all operating commands or operate all features of every disc. These and other disc compatibility and player operation issues with new and existing format discs are possible because:
 - Ultra HD Blu-ray/Blu-ray is a new and evolving format and this player may not operate all features of Ultra HD Blu-ray Discs/Blu-ray Discs because some features may be optional, additional features may have been added to the Ultra HD Blu-ray Disc/Blu-ray Disc format after the production of this player, and certain available features may be subject to delayed availability;
 - not all new and existing disc format versions are supported by this player;
 - new and existing disc formats may be revised, changed, updated, improved and/or supplemented;
 - some discs are produced in a manner that allows specific or limited operation of certain features during playback;
 - some features may be optional, additional features may have been added after the production of this player or certain available features may be subject to delayed availability;
 - some discs bearing the Ultra HD BD-ROM, BD-ROM, BD-RE/-R, DVD-VIDEO, DVD-RW/-R, DVD+RW/+R and CD-RW/-R logos may still be non-standardized discs;
 - some discs may not be played depending on their physical state or recording conditions;
 - problems and errors can occur during the creation of Ultra HD Blu-ray Disc, Blu-ray Disc, or DVD disc software and/or during the manufacture of discs;
 - this player operates differently than a standard DVD player and other AV equipment for reasons noted throughout this user manual and for other reason(s) discovered and posted by the SAMSUNG customer care center.
- If you encounter disc compatibility or player operation problems, please contact the SAMSUNG customer care center.
You can also contact the SAMSUNG customer care center for possible updates for this player.
- For additional information on playback restrictions and disc compatibility, refer to the Precautions, Before Reading the user manual, Disc Types and Characteristics, and Before Playing sections of this user manual.
- **For product progressive scan output** : CONSUMERS SHOULD NOTE THAT NOT ALL HIGH DEFINITION TELEVISION SETS ARE FULLY COMPATIBLE WITH THIS PRODUCT AND MAY CAUSE ARTIFACTS TO BE DISPLAYED IN THE PICTURE. IN CASE OF PROGRESSIVE SCAN PICTURE PROBLEMS, IT IS RECOMMENDED THAT THE USER SWITCH THE CONNECTION TO 'STANDARD DEFINITION' OUTPUT. IF THERE ARE QUESTIONS REGARDING YOUR TV SET'S COMPATIBILITY WITH THIS PRODUCT, PLEASE CONTACT OUR CUSTOMER SERVICE CENTER.

Copy Protection

- Because AAC (Advanced Access Content System) is approved as content protection system for Ultra HD Blu-ray Disc and Blu-ray Disc format, similar to use of CSS (Content Scramble System) for DVD format, certain restrictions are imposed on playback, analog signal output, etc., of AAC protected contents.
The operation of this product and restrictions on this product may vary depending on your time of purchase as those restrictions may be adopted and/or changed by AAC after the production of this product. Furthermore, BD-ROM Mark and BD+ are additionally used as content protection systems for Ultra HD Blu-ray Disc and Blu-ray Disc formats, which imposes certain restrictions including playback restrictions for BD-ROM Mark and/or BD+ protected contents. To obtain additional information on AAC, BD-ROM Mark, BD+, or this product, please contact the SAMSUNG customer care center.
- Many Ultra HD Blu-ray Discs/Blu-ray Discs/DVDs are encoded with copy protection. Because of this, you should only connect your Player directly to your TV, not to a VCR. Connecting to a VCR results in a distorted picture from copy-protected Ultra HD Blu-ray Discs/Blu-ray Discs/DVDs.
- Under the U.S. Copyright laws and Copyright laws of other countries, unauthorized recording, use, display, distribution, or revision of television programs, videotapes, Ultra HD Blu-ray Discs, Blu-ray Discs, DVDs, and other materials may subject you to civil and/or criminal liability.
- **Cinavia Notice** : This product uses Cinavia technology to limit the use of unauthorized copies of some commercially-produced film and videos and their soundtracks. When a prohibited use of an unauthorized copy is detected, a message will be displayed and playback or copying will be interrupted.

More information about Cinavia technology is provided at the Cinavia Online Consumer Information Center at <http://www.cinavia.com>. To request additional information about Cinavia by mail, send a postcard with your mailing address to: Cinavia Consumer Information Center, P.O. Box 86851, San Diego, CA, 92138, USA.

This product incorporates proprietary technology under license from Verance Corporation and is protected by U.S. Patent 7,369,677 and other U.S. and worldwide patents issued and pending as well as copyright and trade secret protection for certain aspects of such technology. Cinavia is a trademark of Verance Corporation. Copyright 2004-2015 Verance Corporation. All rights reserved by Verance. Reverse engineering or disassembly is prohibited.

Network Service Disclaimer





All content and services accessible through this device belong to third parties and are protected by copyright, patent, trademark and/or other intellectual property laws. Such content and services are provided solely for your personal noncommercial use. You may not use any content or services in a manner that has not been authorized by the content owner or service provider. Without limiting the foregoing, unless expressly authorized by the applicable content owner or service provider, you may not modify, copy, republish, upload, post, transmit, translate, sell, create derivative works, exploit, or distribute in any manner or medium any content or services displayed through this device.

THIRD PARTY CONTENT AND SERVICES ARE PROVIDED "AS IS." SAMSUNG DOES NOT WARRANT CONTENT OR SERVICES SO PROVIDED, EITHER EXPRESSLY OR IMPLIEDLY, FOR ANY PURPOSE. SAMSUNG EXPRESSLY DISCLAIMS ANY IMPLIED WARRANTIES, INCLUDING BUT NOT LIMITED TO, WARRANTIES OF MERCHANTABILITY OR FITNESS FOR A PARTICULAR PURPOSE. SAMSUNG DOES NOT GUARANTEE THE ACCURACY, VALIDITY, TIMELINESS, LEGALITY, OR COMPLETENESS OF ANY CONTENT OR SERVICE MADE AVAILABLE THROUGH THIS DEVICE AND UNDER NO CIRCUMSTANCES, INCLUDING NEGLIGENCE, SHALL SAMSUNG BE LIABLE, WHETHER IN CONTRACT OR TORT, FOR ANY DIRECT, INDIRECT, INCIDENTAL, SPECIAL OR CONSEQUENTIAL DAMAGES, ATTORNEY FEES, EXPENSES, OR ANY OTHER DAMAGES ARISING OUT OF, OR IN CONNECTION WITH, ANY INFORMATION CONTAINED IN, OR AS A RESULT OF THE USE OF ANY CONTENT OR SERVICE BY YOU OR ANY THIRD PARTY, EVEN IF ADVISED OF THE POSSIBILITY OF SUCH DAMAGES.

Third party services may be terminated or interrupted at any time, and Samsung makes no representation or warranty that any content or service will remain available for any period of time. Content and services are transmitted by third parties by means of networks and transmission facilities over which Samsung has no control. Without limiting the generality of this disclaimer, Samsung expressly disclaims any responsibility or liability for any interruption or suspension of any content or service made available through this device.

Samsung is neither responsible nor liable for customer service related to the content and services. Any question or request for service relating to the content or services should be made directly to the respective content and service providers.

Licenses

- Manufactured under license from Dolby Laboratories. Dolby and the double-D symbol are registered trademarks of Dolby Laboratories. 
- For DTS patents, see <http://patents.dts.com>. Manufactured under license from DTS Licensing Limited. DTS, the Symbol, DTS in combination with the Symbol, and DTS Digital Surround are registered trademarks or trademarks of DTS, Inc. in the United States and/or other countries. © DTS, Inc. All Rights Reserved. 
- The terms HDMI and HDMI High-Definition Multimedia Interface, and the HDMI Logo are trademarks or registered trademarks of HDMI Licensing LLC in the United States and other countries. 
- Oracle and Java are registered trademarks of Oracle and/or its affiliates. Other names may be trademarks of their respective owners. 
- Open Source License Notice
 - In the case of using open source software, Open Source Licenses are available on the product menu.
- Blu-ray Disc™, Blu-ray™, Ultra HD Blu-ray Disc™, Ultra HD Blu-ray™ and the logos are trademarks of the Ultra HD Blu-ray Disc/Blu-ray Disc Association.

Appendix

Specifications

General	Weight	4.2 lbs
	Dimensions	16.0 (W) X 1.8 (H) X 9.1 (D) inches
	Operating Temperature Range	+41°F to +95°F
	Operating Humidity Range	10 % to 75 %
USB	Type A	USB 3.0
	DC output	5V 1A Max.
HDMI	Video	2D : 2160p, 1080p, 1080i, 720p, 480p 3D : 1080p, 720p
	Audio	PCM, Bitstream
Audio Output	Digital Audio Output	Optical
Network	Ethernet	100BASE - TX Terminal
	Wireless LAN	Built-in
	Security	WEP (OPEN/SHARED) WPA-PSK (TKIP/AES) WPA2-PSK (TKIP/AES)
	WPS(PBC)	Supported

- Network speeds equal to or below 10Mbps are not supported.
- Design and specifications are subject to change without prior notice.
- For information about the power supply and power consumption, refer to the label attached to the product.
- Weight and dimensions are approximate.
- Dispose unwanted electronics through an approved recycler.
To find the nearest recycling location, go to our website: www.samsung.com/recyclingdirect or call, (877) 278 - 0799.

LIMITED WARRANTY TO ORIGINAL PURCHASER

This SAMSUNG brand product, as supplied and distributed by SAMSUNG and delivered new, in the original carton to the original consumer purchaser, is warranted by SAMSUNG against manufacturing defects in materials and workmanship for a limited warranty period of:

One (1) Year Parts and Labor*
(*90 Days Parts and Labor for Commercial Use)

This limited warranty begins on the original date of purchase, and is valid only on products purchased and used in the United States. To receive warranty service, the purchaser must contact SAMSUNG for problem determination and service procedures. Warranty service can only be performed by a SAMSUNG authorized service center. The original dated bill of sale must be presented upon request as proof of purchase to SAMSUNG or SAMSUNG's authorized service center. Transportation of the product to and from the service center is the responsibility of the purchaser.

SAMSUNG will repair or replace this product, at our option and at no charge as stipulated herein, with new or reconditioned parts or products if found to be defective during the limited warranty period specified above. All replaced parts and products become the property of SAMSUNG and must be returned to SAMSUNG. Replacement parts and products assume the remaining original warranty, or ninety (90) days, whichever is longer.

SAMSUNG's obligations with respect to software products distributed by SAMSUNG under the SAMSUNG brand name are set forth in the applicable end user license agreement. Non-SAMSUNG hardware and software products, if provided, are on an "AS IS" basis. Non-SAMSUNG manufacturers, suppliers, publishers, and service providers may provide their own warranties.

This limited warranty covers manufacturing defects in materials and workmanship encountered in normal, and except to the extent otherwise expressly provided for in this statement, noncommercial use of this product, and shall not apply to the following, including, but not limited to: damage which occurs in shipment; delivery and installation; applications and uses for which this product was not intended; altered product or serial numbers; cosmetic damage or exterior finish; accidents, abuse, neglect, fire, water, lightning or other acts of nature; use of products, equipment, systems, utilities, services, parts, supplies, accessories, applications, installations, repairs, external wiring or connectors not supplied and authorized by SAMSUNG, or which damage this product or result in service problems; incorrect electrical line voltage, fluctuations and surges; customer adjustments and failure to follow operating instructions, cleaning, maintenance and environmental instructions that are covered and prescribed in the instruction book; product removal or reinstallation; reception problems and distortion related to noise, echo, interference or other signal transmission and delivery problems. SAMSUNG does not warrant uninterrupted or error-free operation of the product.

THERE ARE NO EXPRESS WARRANTIES OTHER THAN THOSE LISTED AND DESCRIBED ABOVE, AND NO WARRANTIES WHETHER EXPRESS OR IMPLIED, INCLUDING, BUT NOT LIMITED TO, ANY IMPLIED WARRANTIES OF MERCHANTABILITY OR FITNESS FOR A PARTICULAR PURPOSE, SHALL APPLY AFTER THE EXPRESS WARRANTY PERIODS STATED ABOVE, AND NO OTHER EXPRESS WARRANTY OR GUARANTY GIVEN BY ANY PERSON, FIRM OR CORPORATION WITH RESPECT TO THIS PRODUCT SHALL BE BINDING ON SAMSUNG. SAMSUNG SHALL NOT BE LIABLE FOR LOSS OF REVENUE OR PROFITS, FAILURE TO REALIZE SAVINGS OR OTHER BENEFITS, OR ANY OTHER SPECIAL, INCIDENTAL OR CONSEQUENTIAL DAMAGES CAUSED BY THE USE, MISUSE OR INABILITY TO USE THIS PRODUCT, REGARDLESS OF THE LEGAL THEORY ON WHICH THE CLAIM IS BASED, AND EVEN IF SAMSUNG HAS BEEN ADVISED OF THE POSSIBILITY OF SUCH DAMAGES. NOR SHALL RECOVERY OF ANY KIND AGAINST SAMSUNG BE GREATER IN AMOUNT THAN THE PURCHASE PRICE OF THE PRODUCT SOLD BY SAMSUNG AND CAUSING THE ALLEGED DAMAGE. WITHOUT LIMITING THE FOREGOING, PURCHASER ASSUMES ALL RISK AND LIABILITY FOR LOSS, DAMAGE OR INJURY TO PURCHASER AND PURCHASER'S PROPERTY AND TO OTHERS AND THEIR PROPERTY ARISING OUT OF THE USE, MISUSE OR INABILITY TO USE THIS PRODUCT SOLD BY SAMSUNG NOT CAUSED DIRECTLY BY THE NEGLIGENCE OF SAMSUNG. THIS LIMITED WARRANTY SHALL NOT EXTEND TO ANYONE OTHER THAN THE ORIGINAL PURCHASER OF THIS PRODUCT, IS NONTRANSFERABLE AND STATES YOUR EXCLUSIVE REMEDY.

Some states do not allow limitations on how long an implied warranty lasts, or the exclusion or limitation of incidental or consequential damages, so the above limitations or exclusions may not apply to you. This warranty gives you specific legal rights, and you may also have other rights which vary from state to state.

To obtain warranty service, please contact SAMSUNG customer care center.

The benefits of this Limited Warranty extend only to the original purchaser of Samsung products from an authorized Samsung reseller.

THIS LIMITED WARRANTY SHALL NOT APPLY TO ANY SAMSUNG PRODUCTS PURCHASED FROM UNAUTHORIZED RESELLERS OR RETAILERS, EXCEPT IN STATES WHERE SUCH RESTRICTION MAY BE PROHIBITED.

For a list of Samsung authorized retailers, please go to: http://www.samsung.com/us/peaceofmind/authorized_resellers.html.

SAMSUNG

The party responsible for product compliance:
Samsung Electronics Co., LTD.
America QA lab of Samsung
19 Chapin Rd. Building D,
Pine Brook New Jersey 07058

QUESTIONS OR COMMENTS?

Country	CALL	OR VISIT US ONLINE AT	WRITE
IN THE US	1-800-SAMSUNG (726-7864)	www.samsung.com/us/support	Samsung Electronics America, Inc. 85 Challenger Road Ridgefield Park, NJ 07660