

## Technical description and operating instructions

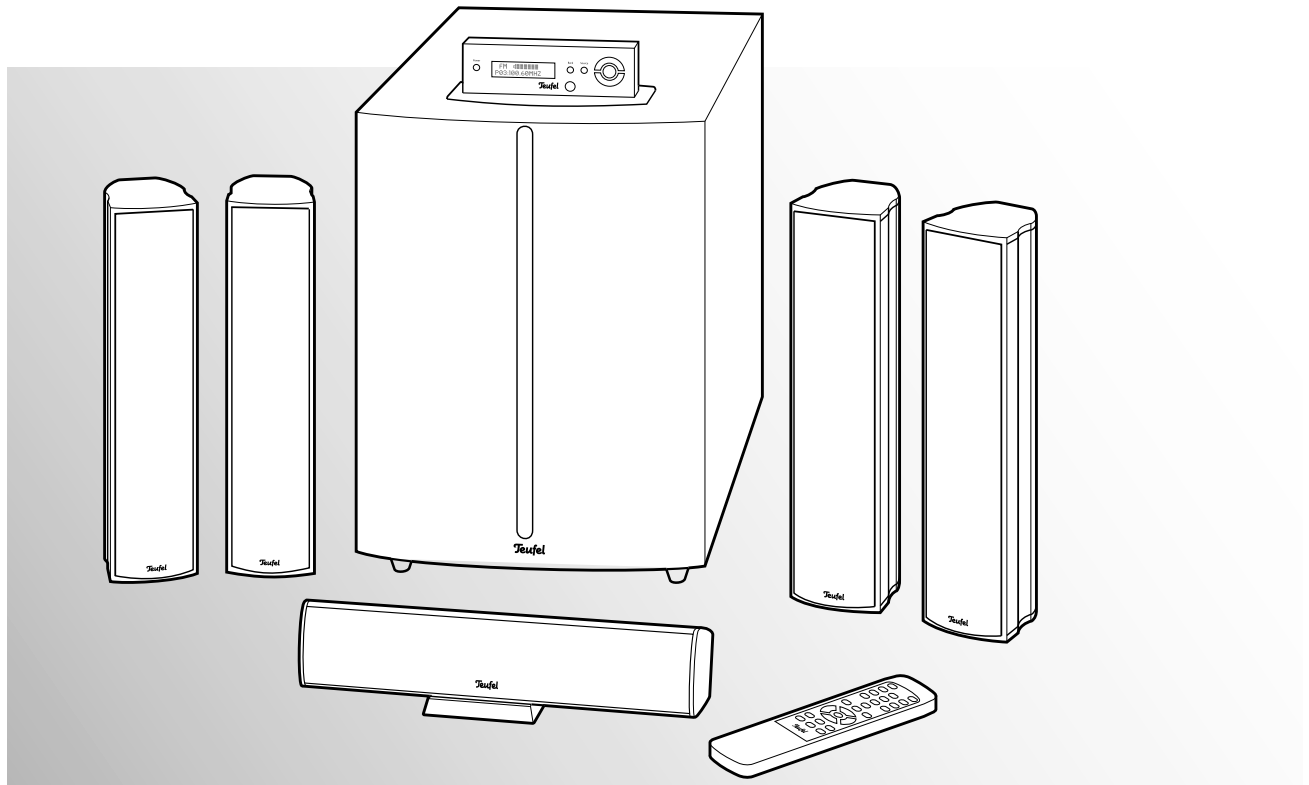

# Columa 300 R

5.1 Home Cinema System

**Teufel**

# Contents

<b>General notes and information</b> . . . . .	<b>3</b>	<b>Special function buttons</b> . . . . .	<b>16</b>
<b>Safety notes</b> . . . . .	<b>4</b>	Surround mode . . . . .	16
<b>Overview</b> . . . . .	<b>5</b>	Dolby Digital 5.1 and DTS . . . . .	16
<b>Control elements and connections</b> . . . . .	<b>6</b>	Test tone . . . . .	16
Subwoofer back side . . . . .	6	Channel level buttons . . . . .	16
Display/control panel . . . . .	6	Display . . . . .	16
Remote control . . . . .	7	Phase . . . . .	16
<b>Remote control</b> . . . . .	<b>7</b>	<b>Radio playback</b> . . . . .	<b>17</b>
<b>Setup</b> . . . . .	<b>8</b>	Setting the radio stations . . . . .	17
<b>Assembly</b> . . . . .	<b>9</b>	Stereo/mono . . . . .	17
<b>Connecting</b> . . . . .	<b>10</b>	Station memory . . . . .	17
Speakers . . . . .	10	Automated program search . . . . .	17
Antennas . . . . .	11	Saving stations manually . . . . .	17
FM antenna . . . . .	11	Selecting stations from the memory . . . . .	17
AM antenna . . . . .	11	<b>Care and cleaning</b> . . . . .	<b>18</b>
Inputs for source devices . . . . .	12	<b>Protecting the environment</b> . . . . .	<b>18</b>
Control panel . . . . .	12	Disposing of the unit . . . . .	18
Headphones . . . . .	12	Batteries and rechargeable batteries . . . . .	18
Connecting to a power supply . . . . .	12	<b>Troubleshooting</b> . . . . .	<b>19</b>
<b>Basic functions</b> . . . . .	<b>13</b>	<b>Trademarks</b> . . . . .	<b>20</b>
Activating and deactivating . . . . .	13	<b>Technical data</b> . . . . .	<b>20</b>
Automatic activation . . . . .	13		
Selecting a source . . . . .	13		
Adjusting the volume . . . . .	13		
Mute . . . . .	13		
<b>Menu functions</b> . . . . .	<b>14</b>		
"INPUT" menu . . . . .	14		
"SURROUND" menu . . . . .	14		
Dolby Digital 5.1 and DTS . . . . .	14		
"LEVEL" menu . . . . .	14		
"DELAY" menu . . . . .	15		
"SPEAKER" menu . . . . .	15		

## General notes and information

### Notice

The information in this document may be changed without prior notice and in no way constitutes any liability on the part of Lautsprecher Teufel GmbH.

No part of these instructions may be reproduced in any form or be broadcasted in any way electronically, mechanically, by photocopy or recording without the written permission of Lautsprecher Teufel GmbH.

© Lautsprecher Teufel GmbH  
Version 1.1  
July 2010

### Original packaging

If you wish to exercise your eight-week right of return, we ask that you be absolutely sure to hold onto the packaging. We can only accept the return of the speakers WITH THE ORIGINAL PACKAGING.

Empty boxes are not available!

### Complaints

In case of complaint we will need the following information to process your enquiry:

#### 1. Invoice number

Can be found on the sales slip (enclosed with the product) or on the order confirmation received as a PDF document, e.g. 4322543

#### 2. Serial number and/or batch number

Can be found on the back of the device, e.g. serial number: CL30000240129A-123.

Many thanks for your support!

### Contact

For questions, suggestions or other issues please contact our customer service department:

Lautsprecher Teufel GmbH  
Gewerbehof Buelowbogen · Buelowstrasse 66  
10783 Berlin (Germany)

**Tel.: 00800 200 300 40 (free of charge)**

**Fax: +49 (0) 30 / 300 930 930**

**www.teufelaudio.com**

### Warranty conditions

12 year warranty for speakers and 2 year warranty for amplifiers and electronic equipment from date of purchase covers materials and workmanship, excludes damage caused by improper use or electrical or mechanical overload. Proof of warranty is the original of our invoice. This warranty applies solely to speakers, amplifiers and electronics purchased from Teufel by an end user for private use. The warranty is not valid for loudspeakers,

amplifiers and electronics, which pass to an end user via a third party merchant. In the case of a private re-sale of Teufel products, the warranty may be transferred to the purchaser as long as the original proof of purchase is also passed on to the purchaser.

### Returns

Teufel provides the right to exchange or return within eight weeks with refund of the purchase price paid. Return of individual components sold as a package is only possible if these components are also sold individually by Lautsprecher Teufel. In the case of the return of one or more individual components the package price reduction offered by Lautsprecher Teufel on all components in a package no longer applies. The amount refunded to the customer for the components returned will therefore only be the difference between the package price and the purchase price of the individual parts. The economic result for the customer is that it is as if he/she had originally bought the remaining components at their individual prices.

Further information on the subject of returns may be found on the back of the return form enclosed with the order or online in the support area of our website [www.teufelaudio.com](http://www.teufelaudio.com).

**If you need to return your goods please do not act without first speaking to Lautsprecher Teufel.**

**We can only process or accept your returns if you give us prior notification by telephone and discuss how to proceed!**

### Proper use

Only use the unit as described in these instructions. Any other use will be deemed as not in accordance with the instructions and may lead to damage to property or even persons. The manufacturer accepts no liability for damage caused by use not in accordance with the instructions.

The unit is intended for private use.



Before operating the unit for the first time please read the safety notes and operating instructions carefully. This is the only way to use all functions safely and reliably.

Keep the operating instructions safe and pass them on to anyone who may own the unit after you.

## Safety notes

### Caution icons

You will find the following caution icons used in these instructions:

---

**Danger High risk!**

Failure to observe the warning may result in severe personal injury or death.

---

**Attention Moderate risk!**

Failure to observe the warning may result in property damage.

**Minor risk!**

Points which should be observed when handling the unit.

---

### Safety notes

---

**Danger Risk of electric shock!**

Faulty installation of electrical equipment or mains voltage which is too high can cause

electric shocks.

- The device is only suitable for use with a power supply voltage of 230V~/50 Hz.
  - If the unit's case or mains cable is defective or shows other signs of visible damage, disconnect the mains adapter immediately from the socket and do not operate the device.
  - If the unit emits smoke or smells of burning or other unusual odours, disconnect it immediately from the power supply and do not operate it.
  - Never open the unit case.  
Repairs may only be carried out by an authorised specialist workshop. Only use parts which conform with the original unit specifications. There are electrical and mechanical parts in this unit which are essential in order to avoid exposure to sources of danger.
  - Do not insert any object through the vent slots in the case.
  - Only use the unit in indoor areas.
  - Do not operate the unit in moist areas and protect it from drops of water or splash water.  
Also take care not to stand vases or other containers of liquid on or near the unit in order to avoid liquid getting into the case. If water or other foreign objects should enter the case, disconnect the device immediately from the mains power supply and remove any batteries. Send the unit to our service address.
  - Never touch the plug with wet hands.
  - Check the unit regularly for damage.
- 

---

**Danger Danger to children!**

Children can become trapped in the packing film when playing and suffocate.

- Do not allow children to play with the unit or the packing film. Danger of suffocation.
  - Ensure that children do not remove small parts from the unit or take them off of the unit (e.g. control knobs or plug adapters). They could swallow the parts and choke. Never allow children to use electrical devices without supervision.
- 

---

**Danger Danger to hearing!**

Loud noise may lead to hearing loss.

There is a potential risk of sudden very high noise pressure especially when activating the subwoofer which is set to full volume. This may have psychological consequences and also cause physical injury. Children and pets are particularly at risk.

- Set your signal source unit volume control to a low setting.
  - When the volume is set high, always keep a certain distance from the unit and never place your ear directly on the speaker.
  - To avoid damage to health, avoid extended listening at high volume.
- 

---

**Danger Danger of chemical burns!**

Leaking battery acid may lead to chemical burns.

- Do not allow battery acid to come into contact with skin, eyes or mucus membranes. In case of contact with acid rinse the affected location immediately with plenty of plain water and if necessary see a doctor.
- 

---

**Danger Danger of injury/damage!**

Incorrect location may result in damage.

- Never use the unit unmounted in vehicles, in unstable locations, on wobbly tripods or furniture, on underdimensioned brackets etc. The speakers could tip or fall down and cause injury to persons or be damaged.
  - Arrange the speakers so that they cannot be knocked over accidentally and make sure that the cables do not pose a trip hazard.
  - Ensure that any wall mounting is performed in a professional manner.
  - Use suitable wall brackets for mounting only. Check the carrying capacity of the walls.
  - Do not place the unit near sources of heat (e.g. heaters, ovens, other heat generating equipment such as amplifiers etc.)
-

### Attention Fire hazard!



Improper use may lead to damage or fire.

- Do not place open flames such as burning candles or similar on the unit.
- Ensure sufficient ventilation.
- Do not place the unit in direct sunlight.
- Do not cover the ventilation slots with curtains, cloths, newspapers or similar. Heat build-up inside the unit can shorten the lifetime of the unit.

### Attention Risk of damage!



Power overload due to lightning strike may damage or destroy the unit.

- If the unit is to be left unsupervised for a long period (e.g. during a holiday), or if a thunderstorm is forecast, disconnect it from the mains power supply.

## Overview

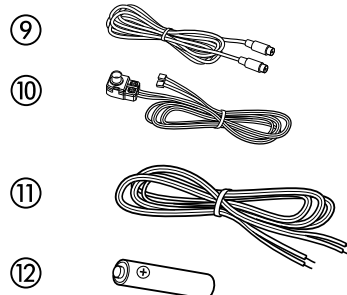
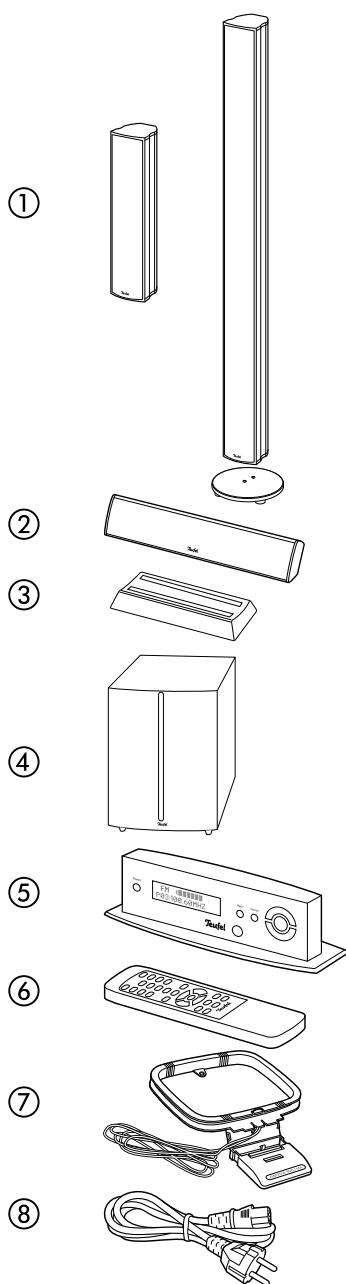

### Product contents

- ① 4 x satellite speakers (exact types depend on the ordered set). Following combinations are possible:
  - 4 wall speakers CL 300 FCR or
  - 4 floor speakers CL 300 FR or
  - 2 wall and 2 floor speakers each
- ② 1 x center speaker CL 300 C
- ③ 1 x base for the center speakers ②
- ④ 1 x active subwoofer US 6110/6 R
- ⑤ 1 x control unit
- ⑥ 1 x remote control
- ⑦ 1 x AM antenna
- ⑧ 1 x power cord
- ⑨ 1 x system cable for control panel ⑤
- ⑩ 1 x FM antenna
- ⑪ 1 x speaker cable (appr. 30 m)
- ⑫ 2 x batteries for the remote control

### Check to be sure

- Check that all items have been delivered and that nothing is damaged.
- If the delivery is incomplete or you find damage sustained in transit, do not operate the unit but contact our service department (see page 3).

# Control elements and connections

## Subwoofer back side

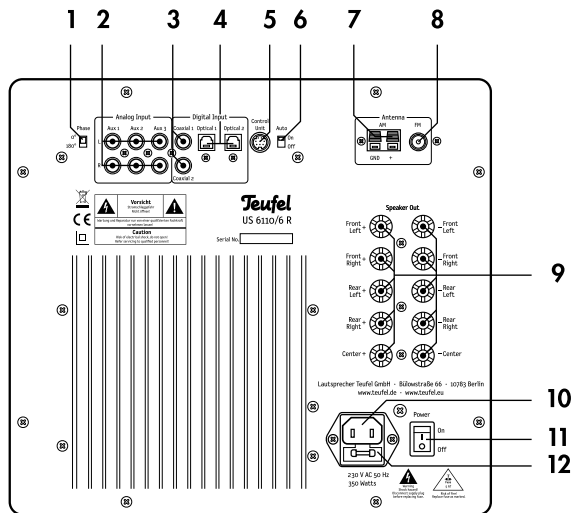

Pos	Name	Description
1	Phase	Activate/deactivate phase shift (180°) of the subwoofer
2	Analog Input Aux 1 - 3	Analogue input jacks
3	Digital Input Coaxial 1 - 2	Digital audio input jacks for coax cables
4	Digital Input Optical 1 - 2	Digital audio input jacks for optical cables
5	Control Unit	Connector for control unit ⑤
6	Auto	Switch to enable/disable automatic wake-up
7	AM GND/+	Connector jacks for AM antenna ⑦
8	FM	Connector for FM antenna ⑩
9	Speaker Out	Cable terminals for satellite speakers ① and ②
10	-	Connector jack for mains cord ⑧
11	Power	Mains switch
12	-	Mains fuse

## Display/control unit

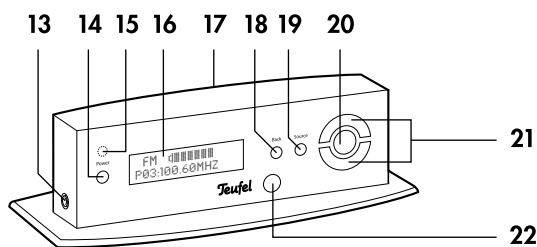

Pos	Name	Description
13	🎧	Connector for headphones
14	Power	Turn the subwoofer on or to standby
15	-	Standby indicator
16	-	Display
17	-	Connector for system cable to subwoofer
18	↩ Back	Return to parent menu
19	🔑 Source	Switch signal source
20	○	Selection key (OK)
21	▲ / ▼	Set buttons +/-
22	-	Infrared receiver for remote control

## Remote control

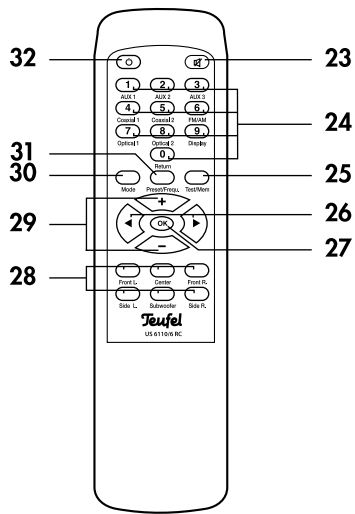

Pos	Name	Description
23	🔇	Mute speakers
24	0...9	Number and function buttons
25	Test/Mem	Activate test tone/store station to memory slots
26	◀/▶	Set buttons left/right
27	OK	Select button
28	Front L. ... Side R.	Adjust channel level
29	+/-	Set buttons +/-
30	Mode	Select surround/stereo mode
31	Presets/Frequ.	In Radio mode: Select station memory slot or tuning frequency
32	🔌	Turn the subwoofer on or to standby

## Remote control

Two 1.5 Volt type AAA batteries (included in the product contents) are required to operate the remote control.

### Inserting the batteries

- Gently press down the arrow section of the battery compartment cover on the back of the remote control. Push the cover down and slide it out.
- If applicable, remove any old batteries (please observe the disposal notes on page 16).
- Insert the batteries in the battery compartment as shown in the figure.
- Place the cover back on the compartment and push it into the closed position.

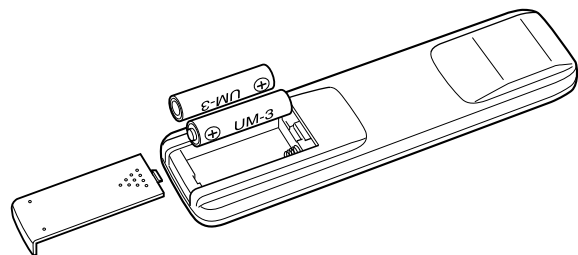

### Functionality

The remote control transmits infrared control signals. For proper reception it is necessary to point the remote control towards the control unit (see next page). Make sure that no objects block the infrared signal.

# Setup

## Setup tips

- Select a stable, level base.
- Make sure that the environment is clean and free of dust.
- Avoid placing the unit close to sources of heat or in direct sunlight.
- Do not place any heavy objects on the cables or the speakers.

The following information refers to an "ideal home cinema", in which the viewer and/or listener sits in a central position at sufficient distance in front of the television and/or screen (see graphic on the right) and no objects (tables or the like) are located in between. Unfortunately, the room, furnishings or one's partner do not always allow for optimum arrangement.

Just follow this general rule: Always experiment on what works best in your listening room in terms of sound and appearance based on our recommendations. Let your ears (and eyes) be the judge!

## Center speakers

Place the center speaker ② on its support foot ③ in an intermediate position under the monitor and/or screen.

## Front speakers

The front speakers are set up to the right and left of the screen or hung at a height of approximately 40 to 120 cm. They should be in line with the center speaker and form an equilateral triangle with the listener – the so called stereo triangle (distance from the listener = distance between the speakers). The speakers should project sound directly into the room or slightly towards the listener.

## Rear speakers

The rear speakers are set up or hung at head level to the side (a) or behind (b) the listener and directed towards the listener. The distance from the listener should be at least 100 cm and the distance to the back wall of the room should be at least 10 cm.

## Subwoofer

You should position the subwoofer on the floor close to the television. A location somewhere between the front speakers is quite common.

## Control unit

The separate control unit ⑤ contains the receiver for the remote control signals. Therefore you should set up the control unit so that it is visible from your sitting position. The system cable to the subwoofer is approximately 5 metres in length.

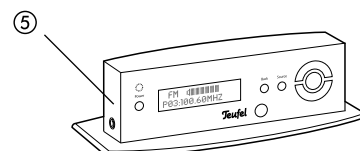
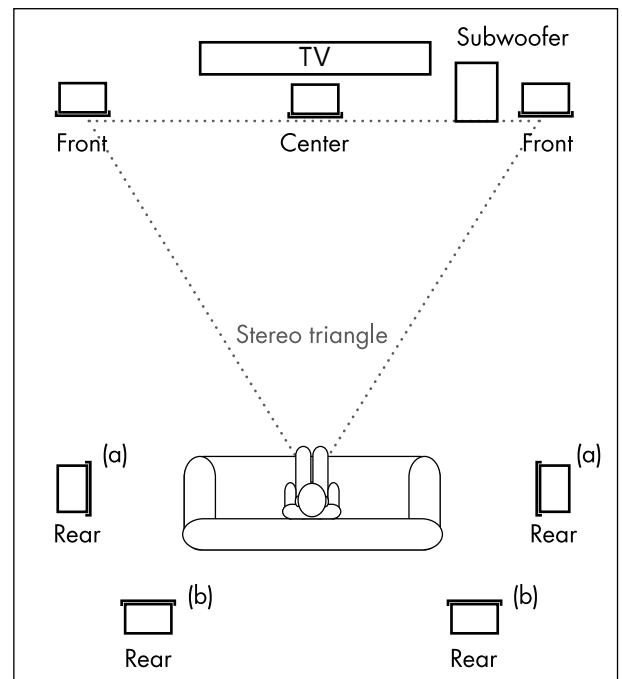



## Assembly

### Wall speakers CL 300 FCR

- The brackets on the back of the satellite speakers are for mounting them on a wall or on a support foot. You can purchase installation materials (cables, support feet, wall brackets and resonance dampers) especially designed for to these speakers in our webshop ([www.teufelaudio.com](http://www.teufelaudio.com)) in the "Accessories" area.

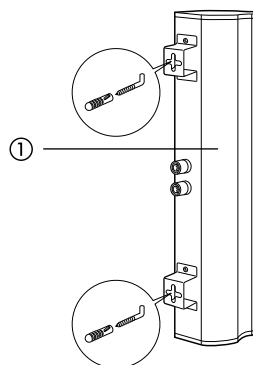

### Center speaker CL 300 C

- Simply place the center speaker ② on the enclosed support foot ③.

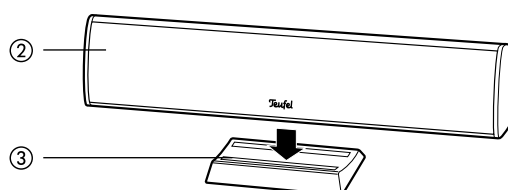

### Floor speakers CL 300 FR

The floor speakers have been prepared to be mounted on the enclosed base plates.

- Screw the base plate onto the bottom of the speaker cabinet with the enclosed bolts.

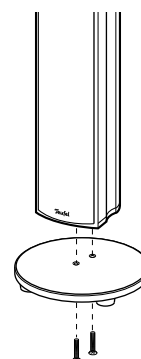

# Connecting

**Danger Danger of injury/damage!**



Arrange the cables so that they do not pose a trip hazard.

**Speakers**

- Lay the speaker cables from your subwoofer to each of the satellite speakers. This cable should be high-quality double-core speaker cable with marked wires.
- A connector terminal with two terminal clips is located on the back of each speaker. You optionally can connect the speaker cables using pin plugs. Here we describe the direct connection without using pin plugs.
- The terminals are each marked red (+) and black (-).



**Make sure the polarity is correct!**

Always connect terminals with the same colour with each other. Otherwise the sound quality will suffer. The wires of the speaker cables are marked with different colours or shapes.

- Split the single wires on both ends for approximately 30 mm and remove 10 mm of the insulation on each wire. Twist the copper core so that no strands are protruding.
  - Turn the connector terminal counterclockwise until it's loose. Run the stripped cable into the hole that is now visible. Turn the terminal clockwise until closed. The cable is now clamped in place.
  - Connect all speaker cables this way.
- The connector terminals 9 "Speaker Out" for the five satellite speakers are located on the back of the subwoofer:
- Front – front speakers, "Left" and "Right".
  - Rear – rear speakers, "Left" and "Right".
  - Center – center speakers.

Like the speakers, these terminals are each marked red (+) and black (-). Connect all cables from the corresponding speakers here.

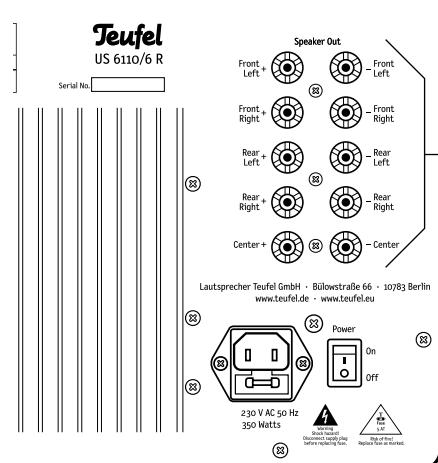
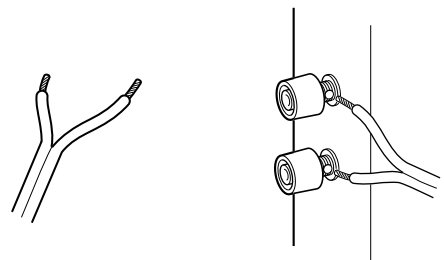
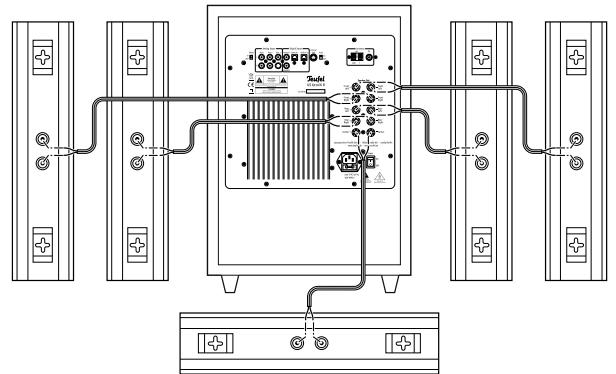

## Antennas

### **Danger Risk associated with lightning strike!**



If you are using outdoor or roof antennas, be absolutely sure that the antenna is equipped with a lightning rod.

### **FM antenna**

Connect the antenna for receiving FM stations to the jack **8** "FM". This can be a roof/outdoor antenna or a cable television connection. You will need a coaxial cable for this.

If an antenna connection is not available at your setup location, you can use the enclosed throw-out aerial **10**. Insert the antenna plug into the jack **8** "FM" and adjust the position of the throw-out aerial until you have the best possible reception. Then fix the antenna in place with tape or nails.

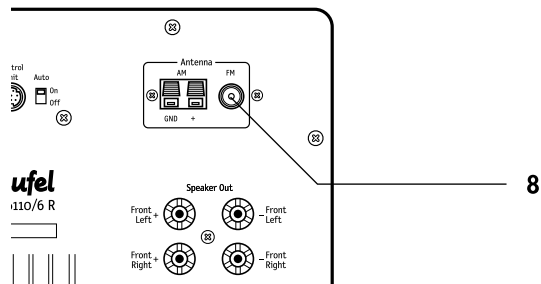
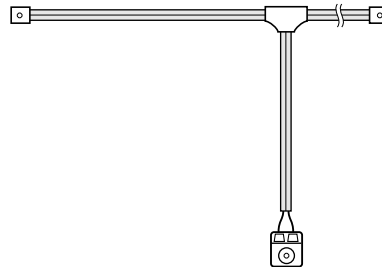

### **AM antenna**

The enclosed antenna **7** is intended for receiving AM stations. You can setup this antenna to be freestanding or screw it onto a (cabinet) wall.

Connect the antenna connector cable with the jacks **7** "AM" on the back of the subwoofer. Push down the lever of each connector terminal and insert the cable end into the underneath opening. The cable is clamped in place when the lever is released.

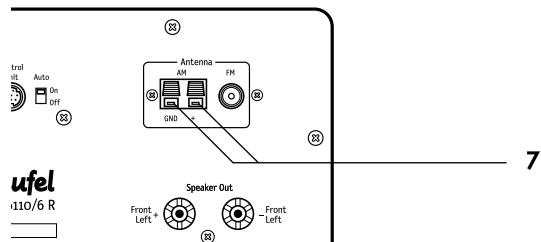
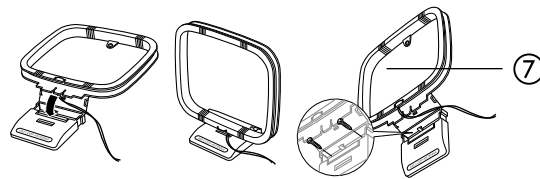

## Inputs for source devices

The subwoofer offers you three inputs for analogue source devices (Aux 1 – 3) as well as two optical and two coaxial digital sound inputs.

### AUX 1, AUX 2 and AUX 3

You can connect three source devices with analogue sound to the jacks **2**. To do so, you will need a double RCA cable (L and R) for each device.

### Coaxial 1 + 2

You can connect the coaxial digital sound outputs from two different source devices to the jacks **3**. Please use a coaxial cable with RCA plugs for each of the devices.

### Optical 1 + 2

You can connect the optical digital sound outputs of two different source devices to the jacks **4**. Please use an optical cable with Toslink plugs for each device. Your source device requires either an optical 3.5 mm plug or may also require a Toslink plug.

## Control panel

The system cable **9** connects jack **17** of the control unit **5** with jack **5** "Control Unit" of the subwoofer.



The small plugs only fit in the jacks in the correct rotational position with the groove facing down.

Only use minimal force when inserting the plugs. Otherwise the thin contacts could bend or even break off.

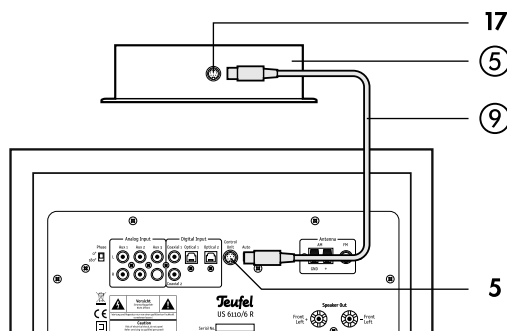
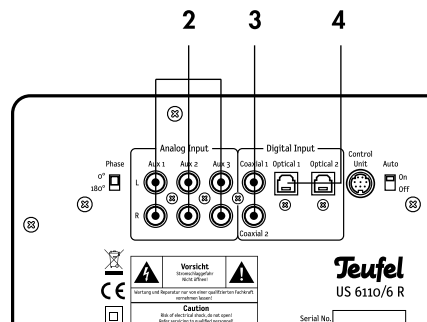

## Headphones

You can connect stereo headphones with a 3.5 mm plug to jack **13** "Headphones" – the speakers will automatically be muted while headphones are plugged in.

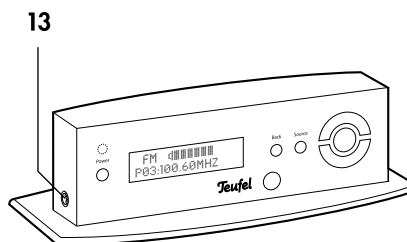

## Connecting to main power

- Ensure that the mains switch **11** "Power" on the subwoofer is switched off ("O OFF" position).
- Connect the mains connector jack **10** with a mains socket via the mains cord **8**.

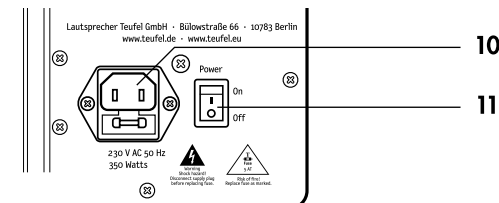



## Menu functions

Set the different subwoofer functions using the menu. You can navigate through the menu as follows:

- Push the select button **20** and/or **27** "OK". The main menu will appear in the display **16**.
- Select the desired submenu with the set buttons **21** and/or **26** "◀/▶" and push the select button **20** and/or **27** "OK".  
The submenu will open and you can change the values with the set buttons **21** and/or **26** "◀/▶".
- With the select button **20** and/or **27** "OK" you apply the setting.
- Push the button **18** "Back" and/or the function button **24** "0/Return" to return to the previous menu.
- If no entry is made for a few seconds, the device automatically switches back to the previous menu.

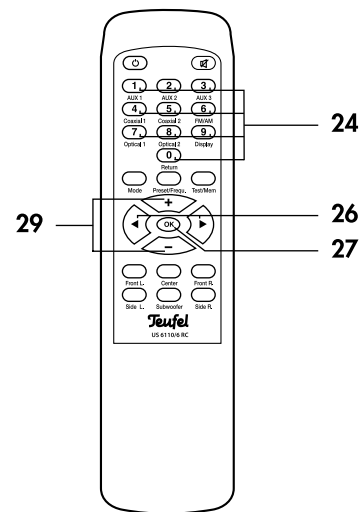
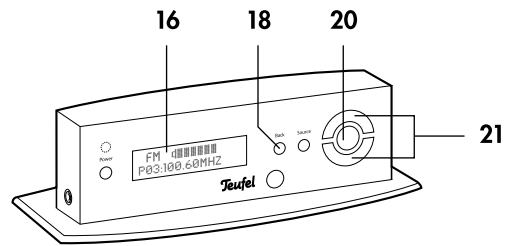

### "INPUT" menu

With the set buttons you can select the active source device: FM (Radio FM), AM (Radio AM), AUX 1, AUX 2, AUX 3, COAX 1, COAX 2, OPT 1, OPT 2.

The input is immediately switched – it is not necessary to press the select button **20** and/or **27** "OK".

### "SURROUND" menu

With the set buttons you can select the surround mode for 2 channel sources in the following order:

- PLII Movie**      Dolby ProLogic II for movies
- PLII Music**      Dolby ProLogic II for music
- 2.1 Stereo**      Stereo via front left/right and subwoofer
- 5.1 Stereo**      Stereo via all channels

Some options may not be available if not all satellite speakers are connected.

### Dolby Digital 5.1 and DTS

When playing back Dolby Digital or DTS encoded multichannel tracks, surround decoding is locked to these standards; so this button is disabled.

### "LEVEL" menu

You can increase or decrease the relative volume for each speaker here. Select the desired speaker with the set buttons **26** "◀/▶":

- Front L** – Front left
- Center** – Center
- Front R** – Front right
- Rear L** – Rear left
- Subwoofer** – Subwoofer
- Rear R** – Rear right

With the set buttons **29** "+/-" you can now set the relative volume within the range of "-12" to "+12". If no button is pressed for three seconds, the device will exit this mode.

## “DELAY” menu

When the speakers are located at different distances to the listening position, the surround sound may be compromised. To compensate such run-time differences, you can set a slight delay in the signal for the center and both rear channels in relation to the two stereo channels front left/right here.

- Measure the distance from the listening position to the front speakers.
- Measure the distance from the listening position to the center speaker.
- Subtract the distance to the center speaker from the distance to the front speakers and enter this value for “Center Spk”.

### **Example:**

Distance to the front speakers: 3.5 metres

distance to the center speaker: 2.6 metres

$3.5\text{ m} - 2.6\text{ m} = 0.9\text{ m}$

- Repeat the above steps for the rear speakers.

## “SPEAKER” menu

Here you can set which satellite speakers are connected to the subwoofer:

**5.1 Channel** All satellite speakers are connected

**3.1 Channel** Only the front speakers left, center, right

**2.1 Channel** Only the stereo speakers left and right

# Special function buttons

## Surround mode

With the button **30** "Mode" you can select the surround mode in this order:

- PLII Movie**      Dolby ProLogic II for movies
- PLII Music**      Dolby ProLogic II for music
- 5.1 Stereo**      Stereo via all channels
- 2.1 Stereo**      Stereo via front left/right and subwoofer

Some options may not be available if not all satellite speakers are connected.

## Dolby Digital 5.1 and DTS

When playing back Dolby Digital or DTS encoded multichannel tracks, surround decoding is locked to these standards; so this button is disabled.

## Test tone

With this function you can monitor and set the level for the speaker channels.

- Push the button **25** "Test/Mem". A test tone ("pink noise") is emitted from each of the speakers in sequential order.
- With the set buttons **29** "+/—" you can adjust the volume of the channel that is currently active.
- Push the button **30** "Mode" to stop the test tone.

## Channel level buttons

You can increase or decrease the relative volume for each speaker here. Select the desired speaker by tipping the corresponding button **28**:

- Front L** – Front left
- Center** – Center
- Front R** – Front right
- Rear L** – Rear left
- Subwoofer** – Subwoofer
- Rear R** – Rear right

With the set buttons **29** "+/—" you can now set the relative volume within the range of "–12" to "+12". If no button is pressed for three seconds, the device will exit this mode.

## Display

With the function button **24** "9/Display" you can control the brightness of the display panel. The display is adjusted each time the button is pressed: bright, dark, off.

## Phase

With switch **1** "Phase" you activate and deactivate the phase shift (180°) of the subwoofer, which may improve the sound under certain circumstances.

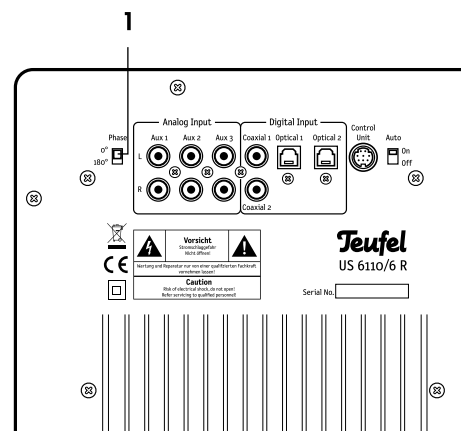
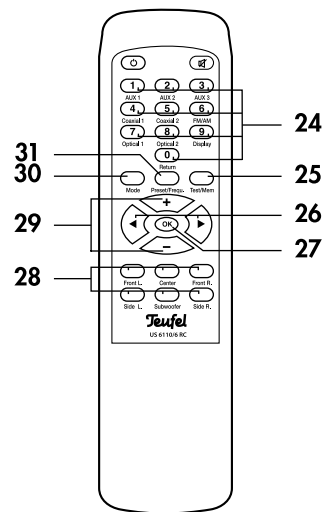



# Radio playback

Select one of the two radio frequency modes (FM/AM) as source (see page 12):

**FM** – Reception of stereo and mono stations in the range of 87.5 to 108 MHz, RDS mode is possible.

**AM** – Reception of mono stations in the range of 522 to 1,629 kHz.

## Setting the radio stations

Direct entry of the tuning frequency:

- Tip the button **31** "Presets/Frequ." twice so that the tuning frequency appears in the display panel.
- Enter the frequency without any decimals or commas using the number buttons **24** "0...9".
- Push the select button **27** "OK".

Station search:

Change the tuning frequency with the buttons **21** and/or **26** "◀/▶":

- **Manually:** The frequency is increased and/or decreased by one step each time the button is tipped (FM: 0.05 MHz, AM: 9 kHz).
- **Automatically:** Holding down the button for a prolonged period of time starts station scanning in the desired direction until a station with sufficiently strong signal is found.

The current tuning frequency is shown in the display **16**. If the station is received in stereo, the symbol "◻◻◻" is also shown. If the station is broadcasting an RDS signal, the station name is displayed in alternation with the frequency after a short time.

### Stereo/mono

With weak FM stereo stations interferences may be heard. If this occurs, you can switch to mono (and back to stereo) reception using the button **30** "Mode".

## Station memory

The device can save 30 FM stations and 10 AM stations. You can conveniently recall saved stations by RC control.

### Automated program search

- Set the desired reception range (FM or AM).
- Push the button **25** "Test/Mem" for approximately three seconds.

The device will automatically save the first 30 stations for FM and/or 10 stations for AM. Memory slots that are already occupied are overwritten in the process.

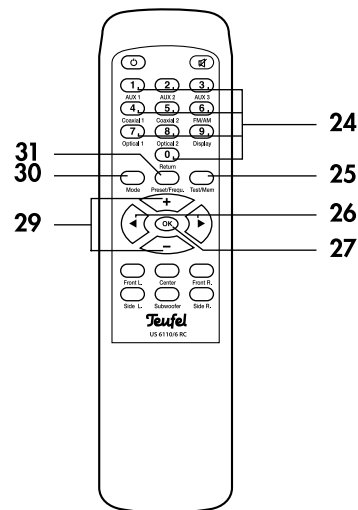

### Saving stations manually

- Set the desired station as described above.
- Push the button **25** "Test/Mem".  
The number of the selected memory slot blinks in the display panel, e.g. "P01".
- With the number buttons **24** "0...9" you can enter the desired memory slot number or select the desired number with the set buttons **26** "◀/▶".
- Push the select button **27** "OK".
- If the memory slot is already occupied, the question "Overwrite?" will appear.  
If you want to select another memory slot, push the function button **24** "0/Return" and enter another number.
- To save, press the select button **27** "OK". The notice "SAVE OKAY" will appear briefly in the display panel.

The station has now been saved. If no button is pushed for five seconds, the device switches back to normal mode.

### Selecting stations from the memory

- Push the button **31** "Presets/Frequ.".  
The number of the last-used memory slot appears in the display panel, e.g. "P03".
- Enter the two-digit number of the desired memory slot with the number buttons **24** "0...9".
- Push the select button **27** "OK".

## Care and cleaning

Clean the subwoofer and the satellites regularly with a soft, damp microfiber cloth. When doing so, please be absolutely sure to observe the following instructions:

### **Danger Risk of electric shock!**



In contact with live parts, water can lead to electric shock or short circuit.

- Make sure that no liquid penetrates the unit.
- Disconnect the mains plug before cleaning.

### **Attention Risk of damage!**



Using the wrong cleaning materials may damage the delicate surface of the case.

- If possible use only plain water with no cleaning products. In case of stubborn marks, a mild soap solution may be used.
- In no circumstances should caustic cleaning products, white spirit, thinners, petrol or similar be used for cleaning.

## Protecting the environment

### Disposing of the unit



**Used units must not be disposed of with household waste.**

If the unit is no longer operational, every consumer is required by law to dispose of used devices separate from household waste, e.g. at a collection point run by the communal authority/borough. In this way, used devices can be recycled and waste materials disposed of in an environmentally friendly manner.

For this reason, electrical equipment is labelled with the displayed symbol.

### Batteries and rechargeable batteries



**Batteries and rechargeable batteries must not be disposed of with household waste!**

Every consumer is required by law to bring all batteries and rechargeable batteries, whether they contain harmful substances\*) or not, to a collection point run by the communal authority or borough or run commercially, so that they can be disposed of in an environmentally friendly manner.

Please only hand in fully discharged batteries and storage batteries!

## Troubleshooting

The following instructions should help you to solve problems. If this doesn't work, please contact our hotline (see page 3). Mind the warranty instructions.

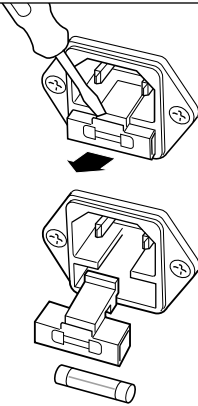
Problem	Possible cause	Solution
The subwoofer doesn't work, the power LED <b>14</b> or the display panel are not illuminated.	The subwoofer is switched off or doesn't have any power.	Turn on the switch <b>11</b> ("On I"). Check the mains cord and socket.
	Fuse is defective.	Replace the fuse: Disconnect the mains cord. Carefully pull out the fuse holder <b>12</b> on the mains connection jack <b>10</b> . Push out the old fuse to the bottom. If necessary, insert a new fuse (2 A delay-action), close the holder. 
The subwoofer is not working, but the display panel is on.	The volume has been set too low.	Increase the volume with the button <b>21</b> and/or <b>29</b> "+".
The subwoofer hums.	The subwoofer is connected to another circuit than the rest of the system.	Connect the subwoofer and source device to the same electric circuit.
	The buzzing is caused by problems with the power supply.	Buy a line filter and connect both devices to it.
	The buzzing is caused by a multi-way socket.	Use another multi-way socket or plug the subwoofer directly into the wall socket. In the case of two-pin plugs it may help to insert the plug into the socket the other way around.
Playback is noisy.	Generally speaking, the system has a very low noise level. In the high range area, very good-quality high-resolution speaker systems can expose the poor quality of a signal source (e.g. from MP3 files).	Ensure that the source is sending a clean signal.
The sound seems dull.	Satellite has been connected with incorrect polarity.	Make sure the speaker cables of all satellites are connected properly.
		To conduct a test, turn the switch 1 "Phase" on and off. Select the setting with the best sound.

## Trademarks

### Dolby

Manufactured under license from Dolby Laboratories. Dolby, Pro Logic, and the double-D symbol are trademarks of Dolby Laboratories.

### DTS

Manufactured under license under U.S. Patent#'s: 5,451,942; 5,956,674; 5,974,380; 5,978,762; 6,487,535 & other U.S. and worldwide patents issued & pending. DTS and DTS Digital Surround are registered trademarks and the DTS logos and Symbol are trademarks of DTS, Inc. ©1996-2009 DTS, Inc. All Rights Reserved.

## Technical data

### Active subwoofer

Operating voltage: 230 V~, 50/60 Hz  
Max. power consumption during operation: 300 Watts  
Standby: < 1 Watt  
Dimensions (W x H x D): 34 x 52 x 49 cm  
Net weight: 20 kg

### Wall and center speakers

Impedance: 4–8 Ohm  
Dimensions (W x H x D): 39.9 x 8.6 x 12.4 cm  
Net weight: 1.4 kg

### Floor speakers

Impedance: 4–8 Ohm  
dimensions (W x H x D): 8.6 x 111.4 x 22.0  
Net weight: 4.4 kg

Technical changes reserved!



This product conforms with Council of the European Union guidelines 2004/108/EC and 2006/95/EC

# Teufel

For questions, suggestions or other issues please contact our customer service department:

**Lautsprecher Teufel GmbH**  
Gewerbehof Buelowbogen - Ausgang D1  
10783 Berlin (Germany), Buelowstr. 66

Tel.: 00800 200 300 40  
Fax: +49 (0)30 - 300 930 930  
[www.teufelaudio.com](http://www.teufelaudio.com)

No liability is accepted for the accuracy of this information. Technical changes, typographical errors and other errors reserved.