

AVR 700/AVR 70/AVR 70C

Audio/video receiver

Owner's Manual

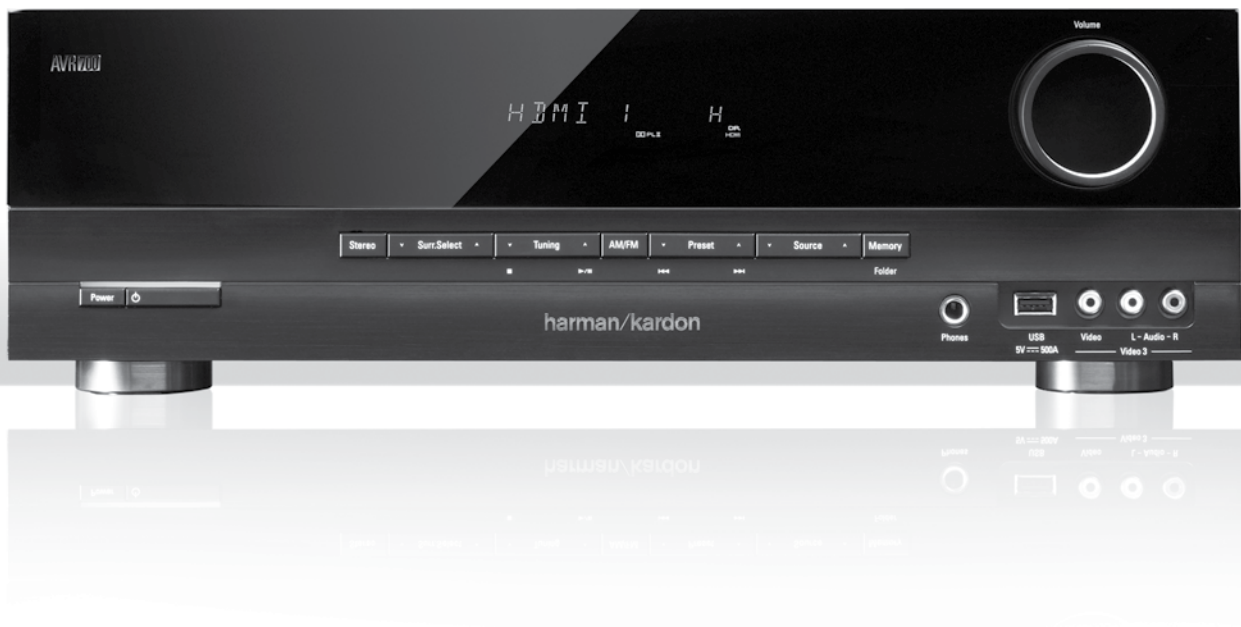

harman/kardon
by HARMAN

INTRODUCTION	3	OPERATING YOUR AVR	16
SUPPLIED ACCESSORIES	3	CONTROLLING THE VOLUME	16
IMPORTANT SAFETY INFORMATION	3	MUTING THE SOUND	16
PLACE THE AVR	3	LISTENING THROUGH HEADPHONES	16
FRONT-PANEL CONTROLS	4	SELECTING A SOURCE	16
REAR-PANEL CONNECTORS	5	VIDEO TROUBLESHOOTING TIPS	16
SYSTEM REMOTE CONTROL FUNCTIONS	6	LISTENING TO FM AND AM RADIO	16
INTRODUCTION TO HOME THEATER	8	LISTENING TO MEDIA ON A USB DEVICE	16
TYPICAL HOME THEATER SYSTEM	8	SELECTING A SURROUND MODE	17
MULTICHANNEL AUDIO	8	ADVANCED FUNCTIONS	17
SURROUND MODES	8	AUDIO PROCESSING AND SURROUND SOUND	17
PLACE YOUR SPEAKERS	8	ADJUSTING THE CHANNEL VOLUMES	17
PLACING THE LEFT, CENTER AND RIGHT SPEAKERS	8	RECORDING	17
PLACING THE SURROUND SPEAKERS	8	SLEEP TIMER	18
PLACING THE SUBWOOFER	8	PROCESSOR RESET	18
TYPES OF HOME THEATER SYSTEM CONNECTIONS	9	MEMORY	18
SPEAKER CONNECTIONS	9	TROUBLESHOOTING	19
SUBWOOFER CONNECTIONS	9	SPECIFICATIONS	20
SOURCE DEVICE CONNECTIONS	9	APPENDIX	21
VIDEO CONNECTIONS	10		
RADIO CONNECTIONS	10		
USB PORT	10		
MAKING CONNECTIONS	11		
CONNECT YOUR SPEAKERS	11		
CONNECT YOUR SUBWOOFER	11		
CONNECT YOUR TV OR VIDEO DISPLAY	11		
CONNECT YOUR SOURCE DEVICES	11		
CONNECT THE RADIO ANTENNAS	13		
CONNECT TO AC POWER	13		
INSTALL BATTERIES IN THE REMOTE CONTROL	13		
SET UP THE AVR	14		
TURN ON THE AVR	14		
USING THE ON-SCREEN MENU SYSTEM	14		
CONFIGURE THE AVR FOR YOUR SPEAKERS	15		
ADDITIONAL SETUP MENU ITEMS	15		

AVR 700/AVR 70/AVR 70C

Introduction, Supplied Accessories, Important Safety Information and Place the AVR

Introduction

Thank you for choosing this Harman Kardon product!

For more than fifty years, the Harman Kardon mission has been to share a passion for music and entertainment, using leading-edge technology to achieve premium performance. Sidney Harman and Bernard Kardon invented the receiver, a single component designed to simplify home entertainment without compromising performance. Over the years, Harman Kardon products have become easier to use while offering more features and sounding better than ever.

The AVR 70, AVR 700 and AVR 70C 5.1-channel digital audio/video receivers (AVRs) continue this tradition with some of the most advanced audio and video processing capabilities yet and a wealth of listening and viewing options.

To obtain the maximum enjoyment from your new AVR, please read this manual and refer back to it as you become more familiar with its features and their operation.

If you have any questions about this product, its installation or its operation, please contact your Harman Kardon retailer or custom installer, or visit our Web site at www.harmankardon.com.

Supplied Accessories

The following accessory items are supplied with your AVR. If any of these items are missing, please contact your Harman Kardon dealer, or Harman Kardon customer service at www.harmankardon.com.

- IR remote control
- AM loop antenna
- FM wire antenna
- Three AAA batteries
- AC power cord

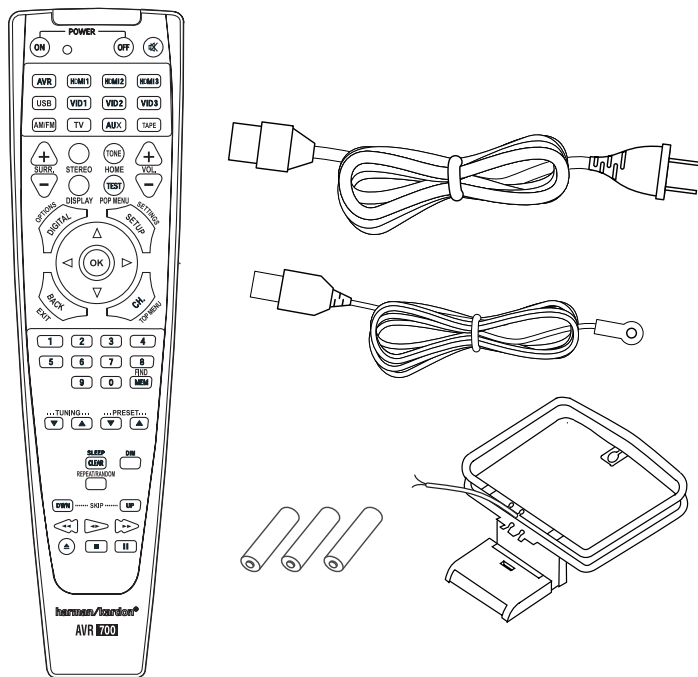

IMPORTANT SAFETY INFORMATION

Verify Line Voltage Before Use

The AVR 700 has been designed for use with 120-volt alternating current (AC). The AVR 70 and AVR 70C have been designed for use with 220 – 240-volt AC. Connection to a line voltage other than that for which your AVR is intended can create a safety and fire hazard, and may damage the unit. If you have any questions about the voltage requirements for your specific model or about the line voltage in your area, contact your selling dealer before plugging the unit into a wall outlet.

Do Not Use Extension Cords

To avoid safety hazards, use only the power cord supplied with your unit. We do not recommend that extension cords be used with this product. As with all electrical devices, do not run power cords under rugs or carpets, or place heavy objects on them. Damaged power cords should be replaced immediately by an authorized service center with a cord meeting factory specifications.

Handle the AC Power Cord Gently

When disconnecting the power cord from an AC outlet, always pull the plug; never pull the cord. If you do not intend to use your AVR for any considerable length of time, disconnect the plug from the AC outlet.

Do Not Open the Cabinet

There are no user-serviceable components inside this product. Opening the cabinet may present a shock hazard, and any modification to the product will void your warranty. If water or any metal object such as a paper clip, wire or staple accidentally falls inside the unit, disconnect it from the AC power source immediately, and consult an authorized service center.

CATV or Antenna Grounding (AVR 700)

If an outside antenna or cable system is connected to this product, be certain that it is grounded so as to provide some protection against voltage surges and static charges. Section 810 of the United States National Electrical Code, ANSI/NFPA No. 70-1984, provides information with respect to proper grounding of the mast and supporting structure, grounding of the lead-in wire to an antenna discharge unit, size of grounding conductors, location of antenna discharge unit, connection to grounding electrodes and requirements of the grounding electrode.

NOTE TO CATV SYSTEM INSTALLER: This reminder is provided to call the CATV (cable TV) system installer's attention to article 820-40 of the NEC, which provides guidelines for proper grounding and, in particular, specifies that the cable ground shall be connected to the grounding system of the building, as close to the point of cable entry as possible.

Place the AVR

- Place the AVR on a firm and level surface. Be certain that the surface and any mounting hardware can support the AVR's weight.
- Provide proper space above and below the AVR for ventilation. Recommended clearance distances are 30cm above the unit, 10cm behind the unit and 20cm on each side of the unit.
- If you install the AVR in a cabinet or other enclosed area, provide cooling air within the cabinet. Under some circumstances, a fan may be required.
- Do not obstruct the ventilation slots on the top of the AVR or place objects directly over them.
- Do not place the AVR directly on a carpeted surface.
- Do not place the AVR in moist or humid locations, in extremely hot or cold locations, in areas near heaters or heat registers, or in direct sunlight.

Front-Panel Controls

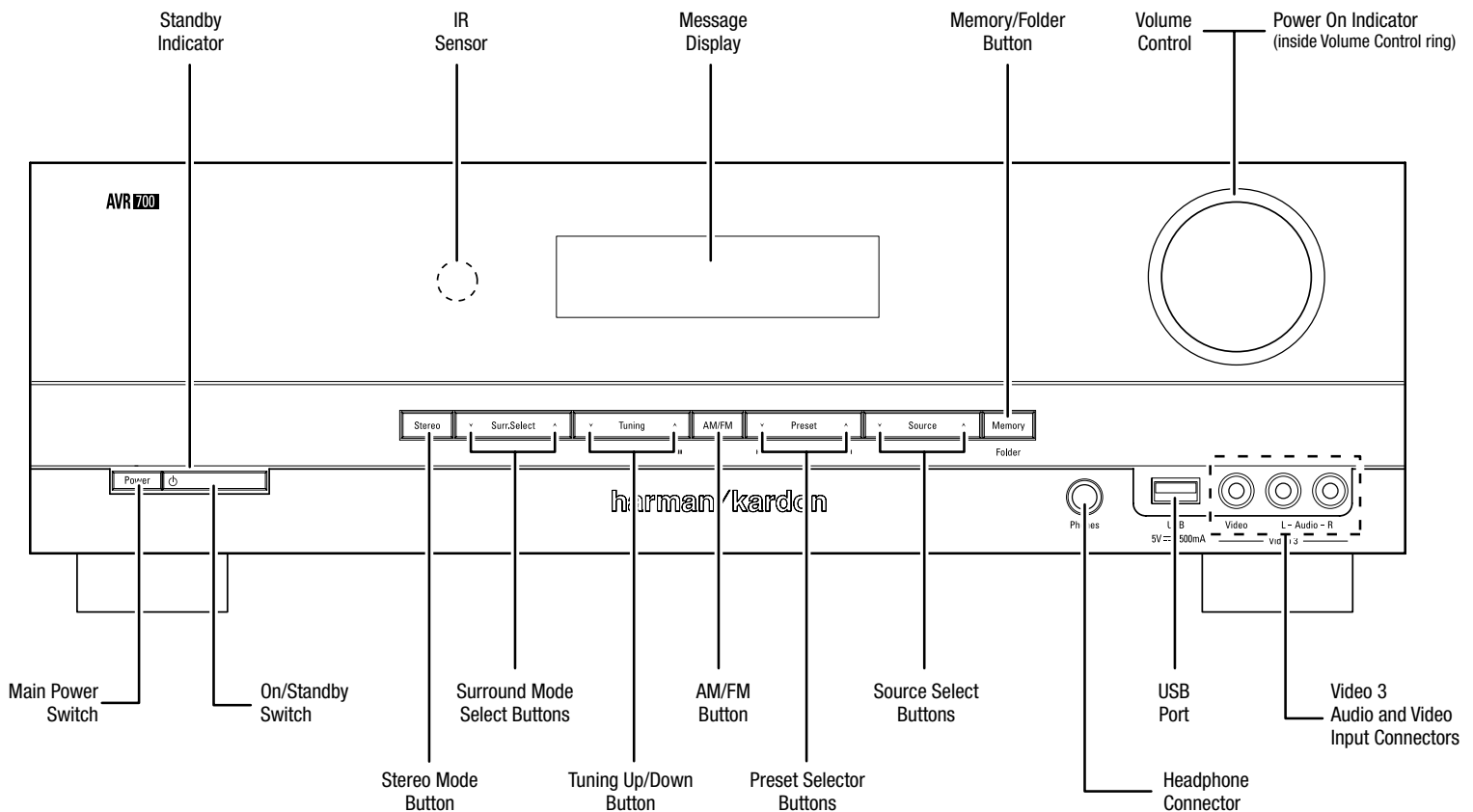

Main Power switch: This mechanical switch turns the AVR's power supply on or off. It is usually left on and cannot be turned on or off using the remote control.

Standby indicator: This LED glows amber to indicate that the AVR is in the Standby mode.

Power On/Standby button: Press this button to turn the AVR on and put it into the Standby mode. When the AVR is on the Power On indicator glows blue and the Standby indicator turns off.

Stereo Mode button: Places the AVR in the stereo listening mode.

IR Sensor: This sensor receives infrared (IR) commands from the remote control. It is important to ensure that the sensor is not blocked.

Surround Mode Select buttons: Press these buttons to select a surround listening mode. Surround-mode availability depends on the nature of the source input signal, i.e., digital versus analog, and the number of channels encoded within the signal.

Tuning Up/Down buttons: Use these buttons to tune radio stations according to the setting of the AM/FM button (see below).

AM/FM button: Press this button to listen to the radio. Pressing this button when the radio is in use will select among the FM Stereo, FM Mono and AM bands. See *Listening to FM and AM Radio*, on page 16, for more information.

Message display: Various messages appear in this display in response to commands and changes in the incoming signal. In normal operation, the current source device name, surround mode and active input appear. When the on-screen display menu system (OSD) is in use, the current menu settings appear.

IMPORTANT NOTE: If the PROTECT message ever appears on the Message Display, turn off the AVR and unplug it from the AC outlet. Check all speaker wires for a possible short circuit (the "+" and "-" conductors touching each other or both touching the same piece of metal). If a short circuit is not found, bring the unit to an authorized Harman Kardon service center for inspection and repair before using it again.

Preset Selector buttons: When the radio is in use, press these buttons to cycle through your preset radio stations. (See *Listening to FM and AM Radio*, on page 16, for more information.) NOTE: When you're listening to files on a USB device, the Tuning Up/Down buttons and the Preset Selector buttons serve as the USB device's transport control buttons. (See *Playing Files on a USB Device*, on page 16, for more information.)

Source Select buttons: Press these buttons to select the active source device.

Memory/Folder button: When the radio is in use, press this button to set the current station as a preset. See *Listening to FM and AM Radio*, on page 16, for more information. When a USB device is the active source device, press this button to display the contents of the current folder or to display all of the folders in the current directory level. See *Playing files on a USB Device*, on page 16, for more information.

Headphone connector: Connect a 1/4" stereo headphone plug to this jack for private listening.

USB Port: Insert a flash drive or HDD disk drive with a USB Standard-A cable to this port.

Volume control: Turn this knob to raise or lower the volume.

Video 3 Audio and Video Input connectors: Connect an auxiliary audio/video source component that will be used only temporarily, such as a camcorder, portable music player or game console, here.

Rear-Panel Connectors

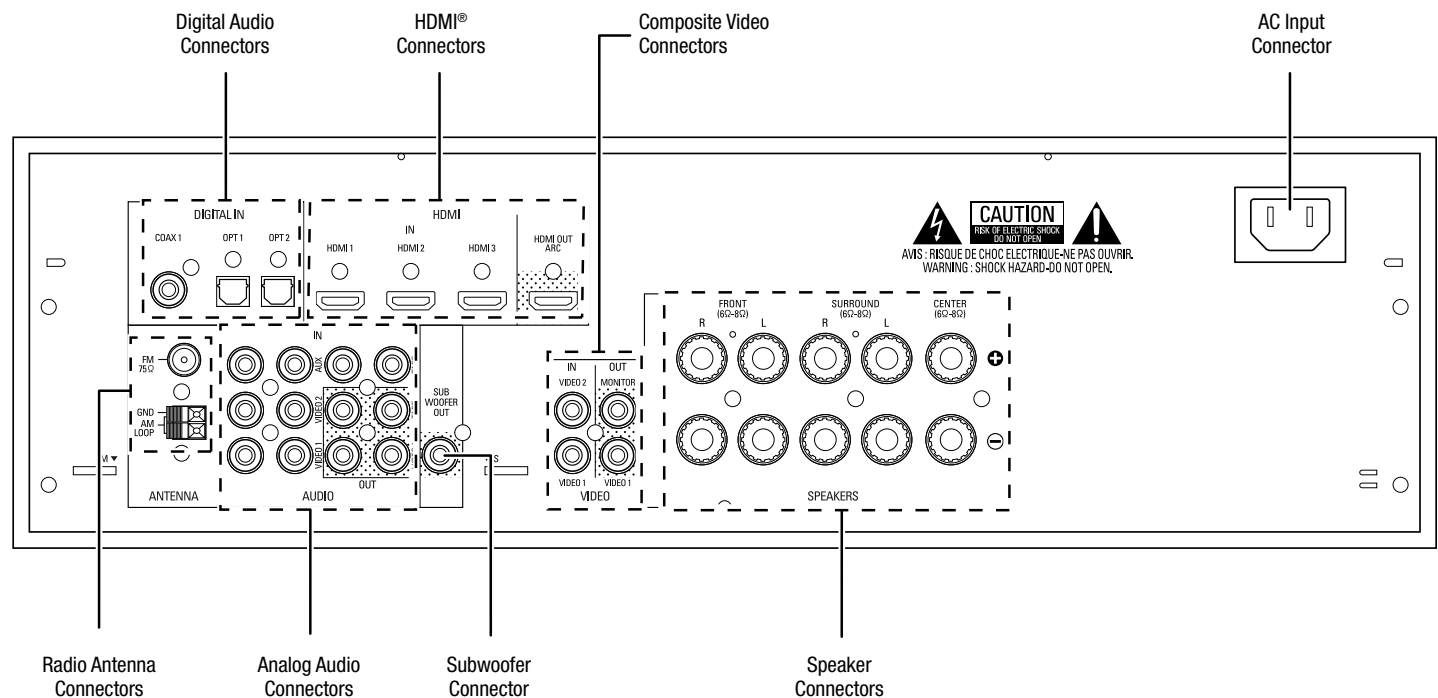

Radio Antenna connectors: Connect the included AM and FM antennas to their respective terminals for radio reception. See *Connect the Radio Antennas*, on page 13, for more information.

Digital Audio connectors: If your non-HDMI source devices have digital outputs, connect them to the AVR's digital audio connectors. See *Connect Your Source Devices*, on page 11, for more information.

Analog Audio connectors: Use the AVR's Analog Audio connectors for source devices that don't have HDMI or digital audio connectors. Use the Video 1 Out, Video 2 Out and Tape Out connectors to connect to the audio inputs of VCRs, tape decks or other analog recorders. See *Connect Your Source Devices*, on page 11, for more information.

HDMI connectors: The HDMI (High-Definition Multimedia Interface®) feature is a connection for transmitting digital audio and video signals between devices. If your source devices and TV have HDMI connectors, using them will provide the best possible video and audio performance quality. Since the HDMI cable carries both digital video and digital audio signals, you do not have to make any additional audio connections for devices you connect via HDMI connections. See *Connect Your Source Devices*, on page 11, for more information.

Notes on using the HDMI Out connector:

- When connecting a DVI-equipped display to the HDMI Monitor Out connector, use an HDMI-to-DVI adapter and make a separate audio connection.
- Make sure the HDMI-equipped display is HDCP-compliant. If it isn't, do not connect it via HDMI; use an analog video connection instead and make a separate audio connection.

Subwoofer connector: Connect this jack to a powered subwoofer that has a line-level input connector. See *Connect Your Subwoofer*, on page 11, for more information.

Composite Video connectors: Use composite video connectors for video source devices and a TV that don't have HDMI connectors. You will also need to make audio connections from the source devices to the AVR. See *Connect Your Source Devices*, on page 11, for more information.

IMPORTANT: The AVR's on-screen display (OSD) only appears through the Composite Monitor Out connector. If you want to use the AVR's OSD menus you need to connect its Composite Monitor Out connector to your TV even if you are not connecting any composite video source devices to the AVR.

Speaker connectors: Use two-conductor speaker wire to connect each set of terminals to the correct speaker. See *Connect Your Speakers*, on page 11, for more information.

AC Input connector: After you have made all other connections, plug the supplied AC power cord into this receptacle and into an unswitched wall outlet.

Remote Control Functions

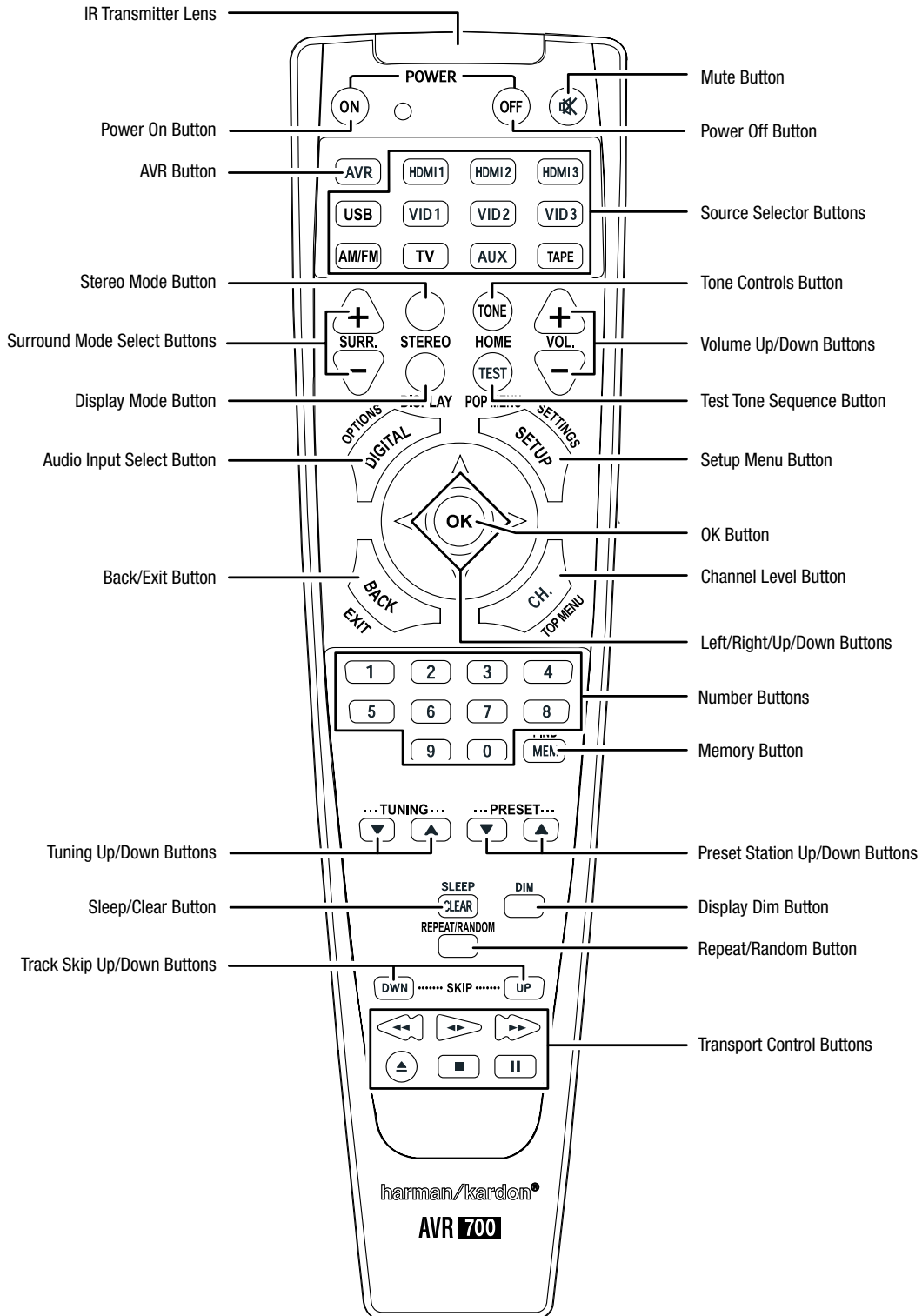

Remote Control Functions, continued

In addition to controlling the AVR, the AVR remote can also control a Harman Kardon Blu-ray Disc® or DVD player that is connected to the HDMI 1 connector. The remote control buttons will have different functions depending on if the remote is controlling the AVR or a Blu-ray Disc or DVD player. Appendix A5, *Remote Control Function List*, on page 25, provides a list of the different remote control button functions when controlling a Blu-ray Disc or DVD player.

IR Transmitter lens: As buttons are pressed on the remote, infrared codes are emitted through this lens.

Power On/Off buttons: Press these buttons to turn the AVR on and off. The Main Power switch on the AVR's front panel must be on for these buttons to turn the AVR on and off.

Mute button: Press this button to mute the AVR's speaker-output connectors and Headphone jack. To restore the sound, press this button or adjust the volume.

AVR button: Press this button to switch the remote's control mode to operate the AVR. Pressing this button when the AVR is in the Standby mode will turn it on.

Source Selector buttons: Press one of these buttons to select a source device. This action will also turn on the AVR and switch the AVR to the selected input.

- Pressing the TV Source Selector button plays the sound from the HDMI Audio Return Channel, so you can listen to sources connected directly to the TV or to the TV itself through the AVR. See *Additional Setup Menu Items: HDMI Set*, on page 15, for more information.
- The first press of the Radio Source Selector button switches the AVR to the last-used tuner band (AM or FM). Successive presses cycle through AM, FM stereo and FM mono.

Stereo Mode button: Press this button to switch to the stereo listening mode.

Tone Controls button: Press this button to activate or bypass the bass and treble controls. When the tone controls are set to "ON", use the up, down, left and right arrow buttons to vary the tone quality by adjusting the bass and treble.

Surround Mode Select buttons: Press these buttons to select a surround listening mode. Surround-mode availability depends on the nature of the source input signal, i.e., digital versus analog, and the number of channels encoded within the signal. See *Selecting a Surround Mode and Audio Processing and Surround Sound*, on page 17, for more information.

Volume Up/Down buttons: Press these buttons to raise or lower the volume.

Display Mode button: Press this button to display the active surround mode and current volume control setting on the AVR's Message Display. After five seconds the display will revert back to showing the currently-active source.

Test Tone sequence button: Press this button to activate the test tone for calibrating channel volume levels by ear.

Audio Input Select button: Press this button to select the specific digital audio input (or analog audio input) to which the current source is connected. Each press of the button advances through the following inputs: Optical Digital 1, Optical Digital 2, Coaxial Digital, HDMI (for HDMI 1 – HDMI 3 only) and Analog. This button does not function for the AM/FM and USB sources.

Setup Menu button: Press this button to activate the setup menus. See *Set Up the AVR*, on page 14, for more information.

OK button: This button is used to select items from the menu system.

Back button: When you're using the setup menus, press this button to return to the previous menu screen.

Channel Level button: Press this button to activate the individual channel-level adjustment. It lets you easily change the channel balance while you're listening to suit different programs or seating arrangements. See *Set Up the AVR*, on page 14, for more information.

Left/Right/Up/Down buttons: These buttons are used to navigate the menu system.

Number buttons: Use these buttons to enter numbers for radio-station frequencies or to select station presets.

Memory button: To save the currently tuned radio station as a preset, press this button, then a Number button.

Tuning Up/Down buttons: Press these buttons to tune a radio station. When you're listening to an FM station, each press will either change one tuning frequency increment at a time or seek the next higher or lower station with acceptable signal strength, depending on whether you are listening in FM mono or FM stereo.

Preset Station Up/Down buttons: Press these buttons to cycle through your preset radio stations.

Sleep/Clear button: Press this button to activate the Sleep Timer function. See *Sleep Timer*, on page 18, for more information. When controlling a Harman/Kardon Blu-ray Disc or DVD player, press this button to clear an entry.

Display Dimmer button: Press this button to dim the AVR's front-panel display partially or fully.

Repeat/Random button: This button has no effect on the AVR but can be used to activate the repeat function when you're listening to media on a device inserted into the AVR's USB port and the repeat and random functions on a Harman Kardon Blu-ray Disc or DVD player. See *Listening to Media on a USB Device*, on page 16, for more information.

Track Skip Up/Down buttons: These buttons have no effect on the AVR but are used to change tracks or chapters when you're listening to media on a device inserted into the AVR's USB port, or on a Harman Kardon Blu-ray Disc or DVD player.

Transport Control buttons: These buttons have no effect on the AVR but are used to control a Harman Kardon Blu-ray Disc player or DVD player or a device inserted in the AVR's USB port.

Introduction to Home Theater

This introductory section will help you to familiarize yourself with some basic concepts unique to multichannel surround-sound AVRs, which will make it easier for you to set up and operate your AVR.

Typical Home Theater System

A home theater typically includes an audio/video receiver (AVR), which controls the system and supplies amplification for the loudspeakers; a disc player; a source component for television broadcasts (cable box, satellite dish AVR, HDTV tuner or antenna connected to the TV); a TV or video display; and multiple loudspeakers.

Multichannel Audio

The main benefit of a home theater system is its ability to produce "surround sound." Surround sound uses multiple speakers and amplifier channels to immerse you in the audio/video presentation for a dramatically increased sense of realism.

Your AVR can have up to five main speakers connected directly to it, plus a subwoofer. Each main speaker is powered by its own amplifier channel inside the AVR. A system with more than two speakers is called a multichannel system. The different main speaker types in a home theater system are:

- **Front Left and Right:** The front left and right speakers are used as in a 2-channel system. In many surround-sound modes, these speakers are secondary, while the main action, especially dialogue, is reproduced by the center speaker.
 - **Center:** When you are watching movies and television programs, the center speaker reproduces most of the dialogue and other soundtrack information that occurs on the screen, anchoring it with the picture. When you are listening to a musical program, the center speaker helps to create a seamless front soundstage, creating a more realistic "you-are-there" listening experience.
 - **Surround Left and Right:** The surround left and right speakers produce ambient sounds that help create a realistic and immersive surround-sound environment. They also help recreate directional sound effects such as aircraft flyovers.
- Many people expect the surround speakers to play as loudly as the front speakers. Although you will calibrate all of the speakers in your system to sound equally loud at the listening position, most artists use the surround speakers for ambient effects only, and they create their programs to steer relatively little sound to these speakers.
- **Subwoofer:** A subwoofer is designed to play only the lowest frequencies (the deep bass). It augments smaller, limited-range main speakers that are usually used for the other channels. Many digital-format programs, such as movies recorded in Dolby Digital, contain a low-frequency effects (LFE) channel that is directed to the subwoofer. The LFE channel packs the punch of a rumbling train or airplane, or the power of an explosion, adding realism and excitement to your home theater. Some people use two subwoofers for additional power and for even distribution of the sound.

Surround Modes

There are different theories as to the best way to present surround sound and to distribute the individual channel information to the surround-sound system's speakers. A variety of algorithms have been developed in an effort to recreate the way we hear sounds in the real world, resulting in a rich variety of options. Several companies have developed different surround-sound technologies, all of which can be accurately reproduced by your AVR:

- **Dolby Laboratories:** Dolby TrueHD, Dolby Digital Plus, Dolby Digital, Dolby Pro Logic II, Dolby Pro Logic.
- **DTS:** DTS-HD™ High Resolution Audio, DTS-HD Master Audio™, DTS, DTS 96/24™, DTS Neo: 6.
- **HARMAN International:** Analog Surround Modes (Theater Hall, Stadium, Club, Arena).
- **Stereo Modes:** 2-channel stereo and 5-channel stereo.

Appendix Table A4, on page 22, contains detailed explanations of the different surround-sound options available on your AVR. Digital surround-sound modes, such as Dolby Digital and DTS systems, are available only with specially encoded programs, such as those available via HDTV, DVD and Blu-ray Disc media and digital cable or satellite television. Other surround modes may be used with digital and analog signals to create a different surround presentation or to use a different number of speakers. Surround-mode selection depends upon the number of speakers in your system, the programs you are watching or listening to, and your personal tastes.

Place Your Speakers

Determine the locations for your system's speakers according to their manufacturer's directions and the layout of your listening room. Use the illustration below as a guide for 5.1-channel systems.

To create the most realistic surround-sound environment possible, you should place your speakers in a circle with the listening position at its center. You should angle each speaker so it directly faces the listening position. Use the diagram below as a guide.

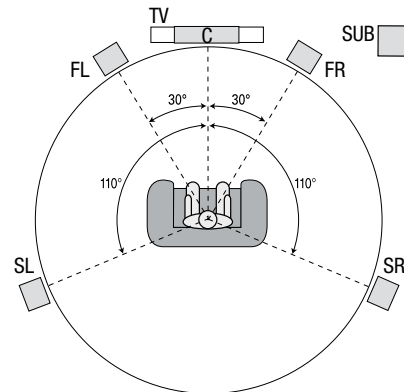

Placing the Left, Center and Right Speakers

Place the center speaker either on top of, below or mounted on the wall above or below the TV or video-display screen. Place the front left and right speakers along the circle, about 30 degrees from the center speaker and angled toward the listener.

Place the front left, front right and center speakers at the same height, preferably at about the same height as the listener's ears. The center speaker should be no more than 2 feet (0.6m) above or below the left/right speakers. If you're using only two speakers with your AVR, place them in the front left and front right positions.

Placing the Surround Speakers

You should place the left and right surround speakers approximately 110 degrees from the center speaker, slightly behind and angled toward the listener. Alternatively, you can place them behind the listener, with each surround speaker facing the opposite-side front speaker. You should place the surround speakers 2 feet – 6 feet (0.6m – 1.8m) higher than the listener's ears.

NOTE: Your AVR will sound its best when the same model or brand of loudspeaker is used for all positions.

Placing the Subwoofer

Because a room's shape and volume can have a dramatic effect on a subwoofer's performance, it is best to experiment with placement so that you will find the location that produces the best results in your particular listening room. With that in mind, these rules will help you get started:

- Placing the subwoofer next to a wall generally will increase the amount of bass in the room.
- Placing the subwoofer in a corner generally will maximize the amount of bass in the room.
- In many rooms, placing the subwoofer along the same plane as the left and right speakers can produce the best integration between the sound of the subwoofer and that of the left and right speakers.
- In some rooms, the best performance could even result from placing the subwoofer behind the listening position.

A good way to determine the best location for the subwoofer is by temporarily placing it in the listening position and playing music with strong bass content. Move around to various locations in the room while the system is playing (putting your ears where the subwoofer would be placed), and listen until you find the location where the bass performance is best. Place the subwoofer in that location.

Types of Home Theater System Connections

There are different types of audio and video connections used to connect the AVR to your speakers, your TV or video display, and your source devices. The Consumer Electronics Association has established the CEA® color-coding standard.

Connection Color Guide Table

Analog Audio Connection	Color
Front Left/Right	White/Red
Center	Green
Surround Left/Right	Blue/Gray
Subwoofer	Purple
Digital Audio Connection	Color
Coaxial (input or output)	Orange
Optical Input	Black
Analog Video Connection	Color
Composite Video	Yellow

Speaker Connections

Speaker cables carry an amplified signal from the AVR's speaker terminals to each loudspeaker. Each cable contains two wire conductors, or leads, that are differentiated in some way, such as with colors or stripes.

The differentiation helps you maintain proper polarity, without which your system's low-frequency performance can suffer. Each speaker is connected to the AVR's speaker-output terminals using two wires, one positive (+) and one negative (-). Always connect the positive terminal on the speaker, which is usually colored red, to the positive terminal on the AVR, which is colored as indicated in the Connection Color Guide Table, above. The negative terminals on the speakers and the AVR are black.

Your AVR uses binding-post speaker terminals that can accept bare-wire cables or banana plugs. Bare-wire cables are installed as shown below:

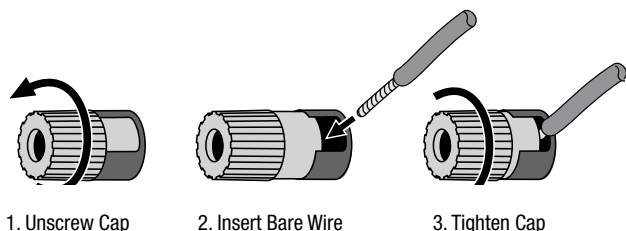

Banana plugs are inserted into the hole in the middle of the terminal cap, as shown below:

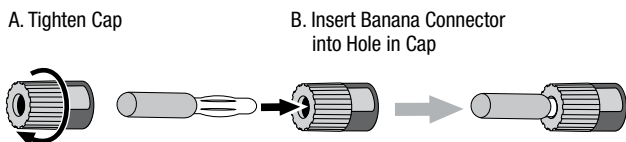

Always connect the colored (+) terminal on the AVR to the (+) terminal on the speaker (usually red), and the black (-) terminal on the AVR to the (-) terminal on the speaker (usually black).

IMPORTANT: Make sure the (+) and (-) bare wires do not touch each other or the other terminal. Touching wires can cause a short circuit that can damage your AVR or amplifier.

Subwoofer Connections

The subwoofer is a speaker dedicated to reproducing only the low (bass) frequencies, which require more power. To obtain the best results, most speaker manufacturers offer powered subwoofers that contain their own amplifiers. Use a single RCA audio cable (not included) to make a line-level (non-amplified) connection from the AVR's Subwoofer connector to a corresponding input jack on the subwoofer.

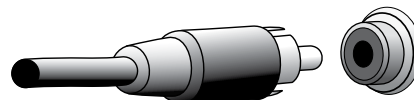

Although the AVR's purple subwoofer output looks similar to a full-range analog audio jack, it is filtered so that only the low frequencies pass through it. Don't connect this output to any device other than a subwoofer.

Source Device Connections

Audio and video signals originate in source devices (components where a playback signal originates) such as your Blu-ray Disc or DVD player, CD player, DVR (digital video recorder) or other recorder, tape deck, game console, cable or satellite television tuner, MP3 player or a device docked in the AVR's USB port. The AVR's FM/AM tuner also counts as a source, even though no external connectors are needed other than the AVR's FM and AM antennas. Separate connectors are required for the audio and video portions of the source device's signal, except for digital HDMI connectors. The types of connectors you use will depend upon the capabilities of the source device and of your TV or video display.

Digital Audio Connections – HDMI

There are two types of audio connections – digital and analog. Digital audio signals are required for listening to sources encoded with digital surround modes, such as Dolby Digital and DTS, or for uncompressed PCM digital audio. Your AVR has three types of digital audio connectors: HDMI, coaxial and optical. Do not use more than one type of digital audio connector for each source device. However, it's okay to make both analog and digital audio connections to the same source.

Your AVR is equipped with four rear-panel HDMI input connectors and one HDMI monitor output connector. HDMI technology enables digital audio and video information to be carried using a single cable, delivering the highest quality picture and sound. If your TV or video-display device has an HDMI input connector, make a single HDMI connection from each source device to the AVR. Usually, a separate digital audio connection is not required.

The AVR's HDMI Monitor Output connector contains an Audio Return Channel (ARC) that carries a digital audio signal from your TV or video display back to the AVR. It allows you to listen to HDMI devices that are connected directly to your TV (such as an Internet connection) without making an additional connection from the device to the AVR. The ARC signal is active when the TV source is selected. See *Additional Setup Menu Items*, on page 15, for more information.

The HDMI connector is shaped for easy plug-in (see illustration, below), and HDMI cable runs are limited to about 10 feet (3m). If your video display has a DVI input and is HDCP-compliant, use an HDMI-to-DVI adapter (not included), and make a separate audio connection.

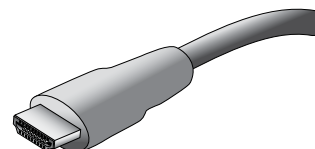

Digital Audio Connections – Coaxial

Coaxial digital audio jacks are usually color-coded orange. Although they look like standard RCA-type analog jacks, you should not connect coaxial digital audio outputs to analog inputs or vice versa.

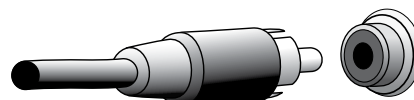

Digital Audio Connections – Optical

Optical digital audio connectors are normally covered by a shutter to protect them from dust. The shutter opens as the cable is inserted. Optical input connectors are color-coded using a black shutter.

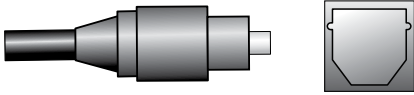

Analog Audio Connections

Two-channel analog connections require a stereo audio cable, with one connector for the left channel (white) and one for the right channel (red). These two connectors are attached to each other.

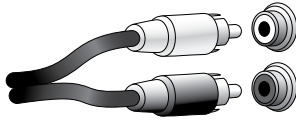

For source devices that have both digital and analog audio outputs, you may make both connections.

The analog connections also feed the Analog Record Output connectors. You may record materials from Blu-ray Disc recordings, DVDs or other copy-protected sources using only analog connections. Remember to comply with all copyright laws if you choose to make a copy for your own personal use.

Video Connections

Many source devices output both audio and video signals (e.g., Blu-ray Disc, DVD player, cable television box, HDTV tuner, satellite box, VCR, DVR). In addition to an audio connection as described above, make a video connection for each of these source devices. Make only one type of video connection for each device.

Digital Video Connections

If you have already connected a source device to one of the AVR's HDMI input connectors, you have automatically made a video connection for that device, since the HDMI cable carries both digital audio and digital video signals.

Analog Video Connections – Composite Video

Composite video is the basic connection most commonly available. Both the chrominance (color) and the luminance (intensity) components of the video signal are transmitted using a single cable. The jack is usually color-coded yellow and looks like an analog audio jack. Do not connect a composite video jack to an analog audio or coaxial digital audio jack, or vice versa.

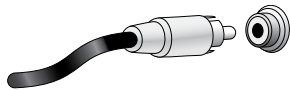

Radio Connections

Your AVR uses separate terminals for the included FM and AM antennas. The FM antenna uses a 75-ohm F-connector.

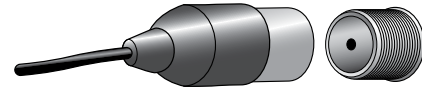

The AM antenna connector uses spring-clip terminals. After assembling the antenna as shown below, press the levers to open the connectors, insert the bare wires into the openings, and release the levers to secure the wires.



USB Port

The AVR can play MP3 and WMA audio files from a USB device inserted into the USB port. Insert the device into the USB port oriented so it fits all the way into the port. You may insert or remove the device at any time – there is no installation or ejection procedure.

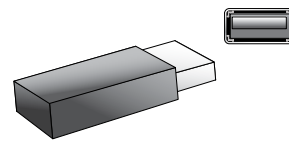

IMPORTANT: Do not connect a PC or other USB host/controller to the AVR's USB port, or you may damage both the AVR and the other device.

Making Connections

CAUTION: Before making any connections to the AVR, ensure that the AVR's AC power cord is unplugged from the AVR and the AC outlet. Making connections with the AVR plugged in and turned on could damage the speakers.

Connect Your Speakers

After you have placed your loudspeakers in the room as explained in *Place Your Speakers*, on page 8, connect each speaker to its color-coded terminal on the AVR as explained in *Speaker Connections*, on page 9. Connect the speakers as shown in the illustration.

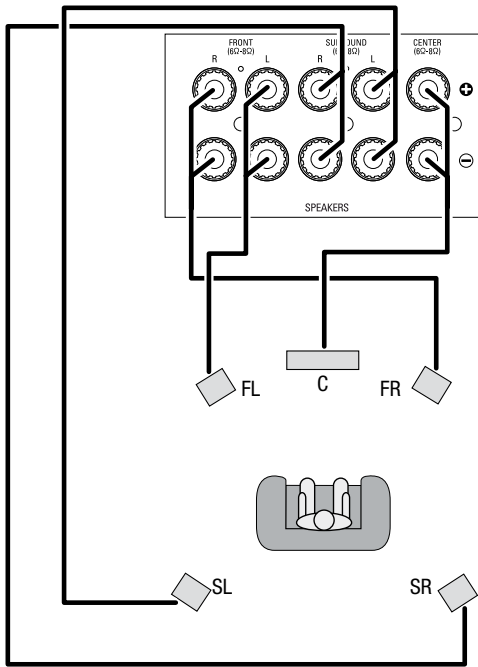

Connect Your Subwoofer

Use a single RCA audio cable to connect the AVR's Subwoofer Out connector to your subwoofer. Consult your subwoofer's user manual for specific information about making connections to it.

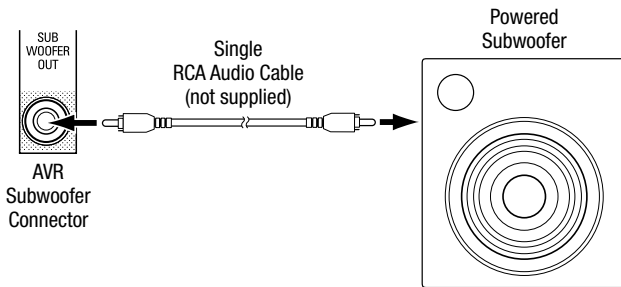

Connect Your TV or Video Display

HDMI Monitor Out connector

If your TV has an HDMI connector and you have HDMI or component video source devices, use an HDMI cable (not included) to connect your TV to the AVR's HDMI Monitor Out connector. It will provide the best possible picture quality.

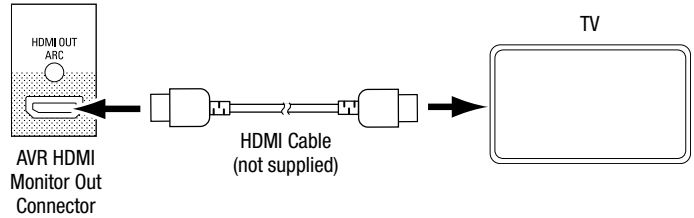

Composite Video Monitor Out connector

If your TV does not have an HDMI connector, or if your TV does have an HDMI connector but you are connecting some source devices with only composite video connectors, use a composite video cable (not included) to connect the AVR's Composite Monitor Out connector to your TV's composite video connector.

IMPORTANT: The AVR's on-screen display (OSD) only appears through the Composite Monitor Out connector. If you want to use the AVR's OSD menus you need to connect its Composite Monitor Out connector to your TV even if you are not connecting any composite video source devices to the AVR.

AVR Composite Monitor Out Connector

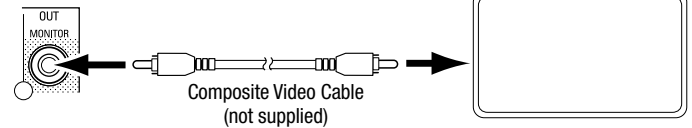

Connect Your Source Devices

Source devices are components where a playback signal originates, such as a Blu-ray Disc or DVD player, or a cable, satellite or HDTV tuner. Your AVR has several different types of input connectors for your audio and video source devices: HDMI, composite video, optical digital audio, coaxial digital audio and analog audio.

Each of your AVR's source buttons is assigned to an HDMI connector or an analog audio input connector (listed in the "AVR Source Button/Analog Audio Connector" column of the table below). The digital inputs are not assigned to any specific sets of analog inputs. Once you select a source device you can use the remote control's Audio Input Select (DIGITAL) button to select the specific audio input connection (HDMI, coaxial digital, optical digital, analog) that you want to listen to. (Note: You cannot select an audio input connection for the FM/AM or USB source buttons.)

As you connect your various source components, fill out the "Source Device Connected" and "Digital Audio Input Connector Used" columns in the following table – it will make it easy to keep track of which devices you have connected to which connectors. Note: The AVR remote is pre-programmed to control a Harman/Kardon Blu-ray Disc or DVD player connected to HDMI 1.

AVR Source Button/ Analog Audio Connector	Source Device Connected	Digital Audio Input Connector Used
Video 1		
Video 2		
Video 2		
Tape		
Aux		
AVR Source Button/ HDMI Connector	Source Device Connected	Digital Audio Input Connector Used
*HDMI 1		
HDMI 2		
HDMI 3		

*The AVR remote is pre-programmed to control a Harman/Kardon Blu-ray Disc or DVD player connected to HDMI 1.

HDMI devices

If any of your source devices have HDMI connectors, using those connectors will provide the best possible video and audio performance quality. Since the HDMI cable carries both digital video and digital audio signals, you do not have to make any additional audio connections for devices you connect via HDMI cables.

- The AVR remote control is pre-programmed to control a Harman/Kardon Blu-ray Disc or DVD player when the HDMI 1 Source Selector button is pressed.

If you have a TV equipped with the HDMI Audio Return Channel function, its sound is fed to the AVR via the HDMI Out connector's Audio Return Channel, and it will not require additional audio connections to the AVR.

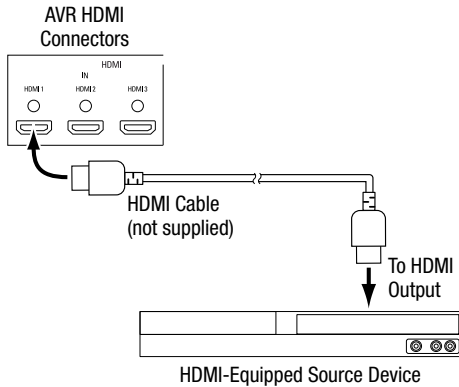

Composite video devices

You will need to make composite video connections from your source devices that do not have HDMI connectors. You will also need to make an audio connection from the device to the AVR.

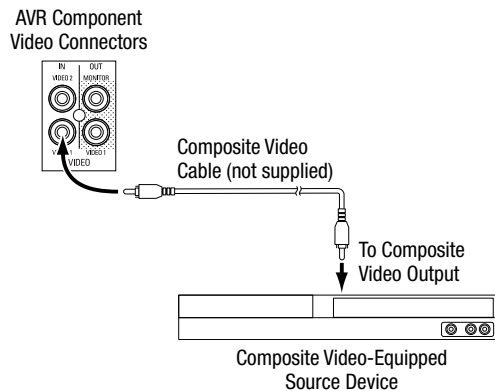

Optical digital audio devices

If your source devices have optical digital outputs, connect them to the AVR's Optical Digital Audio connectors. NOTE: Make only one type of digital connection (HDMI, optical or coaxial) from each device.

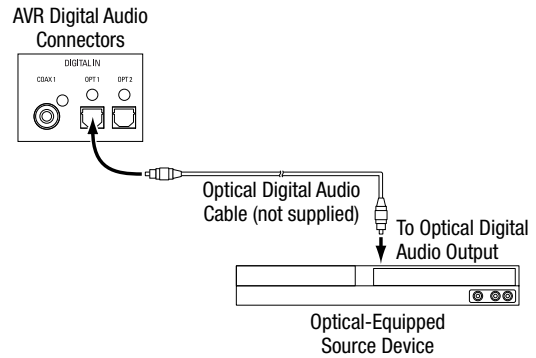

Coaxial digital audio devices

If your source devices have coaxial digital outputs, connect them to the AVR's Coaxial Digital Audio connectors. NOTE: Make only one type of digital connection (HDMI, optical or coaxial) from each device.

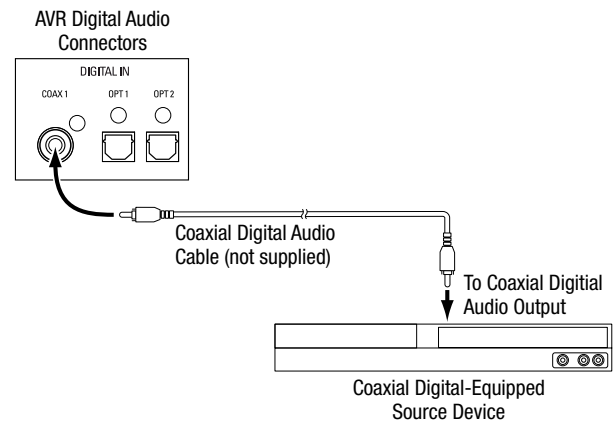

Analog audio devices

Make analog audio connections from your source devices that do not have HDMI or digital audio connectors. If you're connecting video sources to the Video 1, Video 2 or Video 3 audio inputs, you must also connect the source device's composite video output to the corresponding composite video connector.

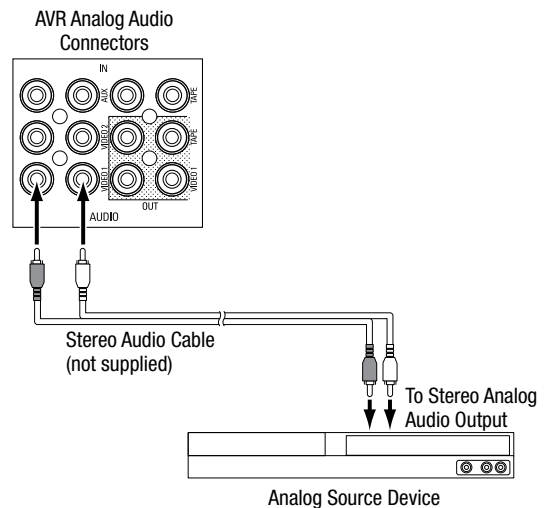

Audio recorders

Connect an analog audio recorder's inputs to the AVR's analog audio Tape Out connectors. You can record any analog audio input signal except for the Tape 1 input.

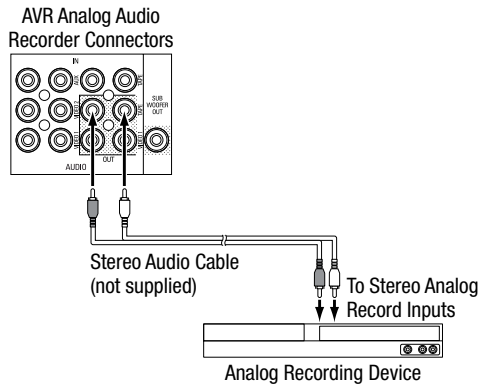

Connect to AC Power

Connect the AC power cord to the AVR's AC Input connector and then to a working AC power outlet.

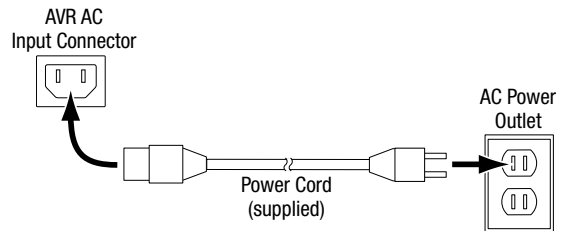

Install the Batteries in the Remote Control

Remove the remote control's battery cover, insert the three supplied AAA batteries as shown in the illustration, and replace the battery cover.

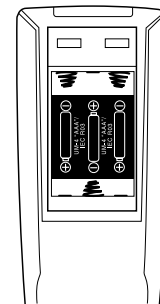

NOTE: Remove the protective plastic from the AVR's front panel to keep it from reducing the remote control's effectiveness.

Video recorders

Connect an analog video recorder's video input connector to the AVR's Video 1 Out Composite Video connector, and its audio input connectors to the AVR's Video 1 Out Analog Audio connectors. You can record the Video 2 or Video 3 composite video input signals.

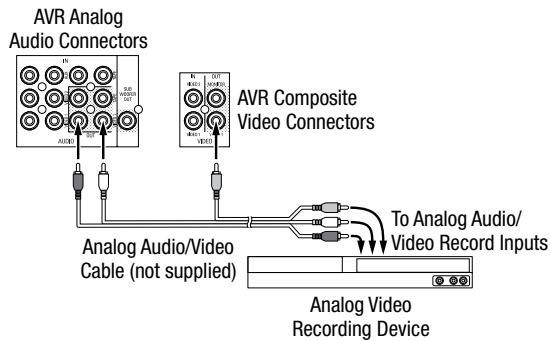

Connect the Radio Antennas

- Connect the supplied FM antenna to the AVR's FM 75Ω Radio Antenna connector. For the best reception, extend the FM antenna as far as possible.
- Bend and fold the base of the supplied AM antenna as shown and connect the antenna wires to the AVR's AM and Gnd connectors. Rotate the antenna as necessary to minimize background noise.

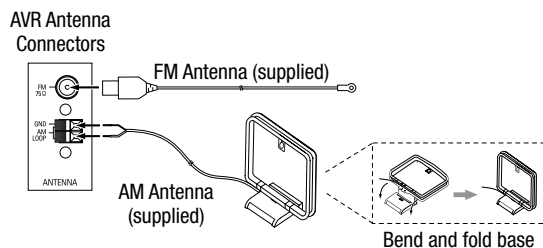

Set Up the AVR

Turn On the AVR

1. Set the front-panel Main Power switch to "On." (The front-panel Standby indicator will glow amber.)
2. Press the front-panel On/Standby switch.

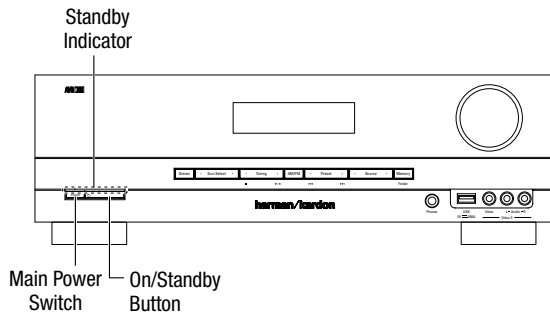

Unless you will not be using the AVR for an extended period of time, leave the Main Power switch set to "On." When the Main Power switch is turned off, any settings you have programmed will be preserved for up to two weeks.

IMPORTANT NOTE: If the PROTECT message ever appears in the Message display, turn off the AVR and unplug it. Check all speaker wires for a short circuit ("+" and "-" wires touching). If none is found, bring the unit to an authorized Harman Kardon service center for inspection and repair before using it again.

Using the On-Screen Menu System

Although it's possible to configure the AVR using only the remote and the front-panel Message display, it is easier to use the on-screen menu system.

To access the menu system, turn on your TV and select the TV's composite video input where you connected the AVR in *Connect Your TV or Video Display*, on page 11.

Press the remote control's SETUP button. The AVR's on-screen display (OSD) System Setup menu will appear on the TV.

System Setup

1. Speaker Setup
2. HDMI Setup
3. Audio Settings
4. Audio Power Control
5. Speaker On/Off

The System Setup menu consists of five submenus: Speaker Set, HDMI Set, Parameter, Auto Power Control and Speaker On/Off.

Use the Up/Down/Left/Right buttons on the remote to navigate the menu system, and press the OK button to select a menu or setting line, or to enter a new setting.

The current menu, setting line or setting will appear in the front-panel Message display, as well as on screen.

To return to the previous menu, press the remote's BACK button. To exit the menu system, press the SETUP button.

Follow the instructions in this *Set Up the AVR* section to configure your home theater system. You may return to these menus at any time to make additional adjustments.

Before you begin initial setup, all loudspeakers, a video display and all source devices should be connected to the AVR. You should be able to turn on the AVR and view the System Setup menu when you press the SETUP button. If necessary, reread the *Making Connections* section and the beginning of this section before continuing.

Configure the AVR for Your Speakers

1. Turn on your TV and select the TV's composite video input where you connected the AVR in *Connect Your TV or Video Display*, on page 11.
2. Press the remote control's SETUP button. The AVR's on-screen display (OSD) System Setup menu will appear on the TV.

System Setup

1. Speaker Setup
2. HDMI Setup
3. Audio Settings
4. Audio Power Control
5. Speaker On/Off

3. Use the remote's arrow and OK buttons to select "Speaker Setup." The *Speaker Setup* menu will appear.

1. Speaker Setup

- a. Speaker Settings
- b. Crossover
- c. Channel Level
- d. Speaker Distance

4. Select "Speaker Settings." The Speaker Settings menu will appear.

1a. Speaker Settings

```

Front      < LARGE >
Center     [ LARGE ]
Surround L/R [ LARGE ]
Subwoofer  [ YES ]
    
```

5. Use the remote's left and right arrow buttons to select OFF, SMALL or LARGE for the Front, Center and Surround speaker positions, depending on the speakers you have connected to the receiver.

OFF: Select this setting if you have not connected a speaker in that position (not available for the Front speakers).

SMALL: Select this setting if the speaker is not capable of producing clean, deep bass energy at output levels that match those produced by a powered subwoofer. All bass below the crossover frequency (see Step 6, below) in that channel is removed from that speaker and is sent to the subwoofer (or to the Front speakers if Subwoofer is set to NO). Most speakers (unless they are large and powerful) should be considered SMALL.

LARGE: Select this setting if the speaker is capable of producing clean, deep bass energy at output levels that match those produced by a powered subwoofer. All bass in that channel is sent to that speaker.

NOTE: If your system has a subwoofer and you set the Front speakers to LARGE, the subwoofer may not output audio except for Dolby Digital- and DTS-encoded program material that contains LFE channel information. If you set your Front speakers to LARGE and you want your subwoofer to reproduce bass from all program material, set the Subwoofer to PLUS (see below).

For Subwoofer, select YES (if your system has a subwoofer), NO (if your system does not have a subwoofer), or PLUS (if your system has a subwoofer, you set your Front speakers to LARGE and you want your subwoofer to reproduce bass from all program material).

When you're finished, record your settings in Table A2 of the Appendix, on page 21, then press the remote control's BACK button to return to the Speaker Setting menu.

6. (Note: If your system does not have a subwoofer, skip to step 7.) Press the BACK button and select "Crossover." The Crossover menu will appear

2b. Crossover

```

Frequency < 100Hz >
    
```

Consult the technical specifications for your system's main left and right speakers and locate the frequency response, usually given as a range, e.g., 80Hz – 20kHz (± 3 dB). Note the lowest frequency that the speakers are capable of playing (80Hz in the above example). NOTE: This frequency is not the same as the crossover frequency that may also be listed in the specifications.

Use the remote's left and right arrow buttons to select the crossover frequency that most closely matches the low frequency specification that you noted above. The AVR will divide the source signal at this crossover point, will send all information above the crossover point to your system's speakers, and all information below the crossover point to the subwoofer. This way, each loudspeaker in your system will perform at its best, delivering a more powerful and enjoyable sound experience. Record the setting in Table A2 of the Appendix, on page 21.

- Press the BACK button and select "Speaker Distance." The Speaker Distance menu will appear.

2d. Speaker Distance

```

Front L   < 10.0ft >
Center   [ 10.0ft ]
Front R   [ 10.0ft ]
Surround R [ 10.0ft ]
Surround L [ 10.0ft ]
Subwoofer [ 10.0ft ]

```

- Measure the distance from each speaker in your system to the listening position. Record the distances in Table A3 of the Appendix, on page 21.
- Use the remote's left and right arrow buttons to change the distance setting for each speaker so it matches the distance you wrote down in step 8. When you're finished, press the remote control's BACK button to return to the Speaker Setting menu.
- Select "Channel Level." The Channel Level menu will appear. Use the remote's left and right arrow buttons to set Test Tone to "Manual" and press the remote's OK button. After the on-screen countdown you will hear test noise through the front left speaker.

2c. Channel Level

```

Test Tone < Manual >

```

- Sit in the main listening position and adjust the AVR's volume control so the test noise is moderately loud. Note the volume of the test noise through the first speaker. Press the remote's down arrow button to advance the test noise to each of your system's speakers and note the volume level of the noise in each speaker.
- As you advance the test noise through the speakers, use the remote's left and right arrow buttons to adjust the volumes of the channels until all of them play at the same volume.

Notes on Setting Speaker Volumes in Home Theater Systems:

While setting your system's individual speaker volume levels is ultimately up to your personal taste, here are some ideas you may find helpful:

- For films and video-music programs, your overall goal should be to create an enveloping, realistic sound field that draws you into the film or music program without drawing your attention away from the action on the screen.
- For multichannel music recordings, some music producers will create a sound field that places the musicians all around you; others will create a sound field that places the musicians in front of you, with more subtle ambience in the surround speakers (as you would experience in a concert hall).
- In most 5.1-channel film soundtracks, the surround speakers are not intended to be as loud or as active as the front speakers. Adjusting the surround speakers so they are always as loud as the front speakers could make dialogue difficult to understand and will make some sound effects sound unrealistically loud.

Notes on Setting Subwoofer Volume:

- Sometimes the ideal subwoofer volume setting for music is too loud for films, while the ideal setting for films is too quiet for music. When setting the subwoofer volume, listen to both music and films with strong bass content and find a "middle ground" volume level that works for both.
 - If your subwoofer always seems too loud or too quiet, you may want to place it in a different location. Placing the subwoofer in a corner will always tend to increase its bass output, while placing it away from any walls or corners will always tend to lessen its bass output.
- When you're finished, record the settings in Table A3 of the Appendix, on page 21, then press the remote's SETUP button to turn off the on-screen menus.

Additional Setup Menu Items

You can also adjust the following settings:

HDMI Set: Selecting ARC/CEC On will send audio from the TV to the AVR via the HDMI Audio Return Channel (ARC) connection (which is in the HDMI cable connecting the AVR to the TV). This way, whenever you're watching a source that is connected directly to your TV (such as an Internet connection), you can listen to the sound through the AVR by selecting TV as the AVR source device. Selecting On also allows the communication of control information among the HDMI devices in your system (CEC).

Audio Settings: Selecting Audio Settings allows you to adjust the following audio settings:

- Night Mode works with specially encoded Dolby® Digital discs or broadcasts, compressing the audio so that louder passages are reduced in volume to avoid disturbing others, while dialogue remains intelligible. Press the left/right arrow buttons to advance through the following DRC (Dynamic Range Control) settings:

Off: No compression is applied. Loud passages in the program remain as they were recorded.

Mid: Loud passages in the program are reduced moderately in volume.

Max: Loud passages in the program are reduced more in volume.

Auto: Automatically compresses the audio a specific amount in response to instructions encoded in the Dolby Digital program.

- PLII Music: Additional adjustments are available that allow you to fine-tune the Dolby Pro Logic II Music surround mode's performance for your listening room and personal taste:

Panorama: With the Panorama mode turned on, some of the sound from the front speakers is moved to the surround speakers, creating an enveloping "wraparound" effect. Each press of the left or right arrow buttons toggles the setting On or Off.

Center Width: This setting affects how vocals sound through the three front speakers. A lower number focuses the vocal information tightly on the center channel. Higher numbers (up to 7) broaden the vocal soundstage. Use the left/right arrow buttons to adjust this setting.

Dimension: This setting affects the depth of the surround presentation, allowing you to "move" the sound toward the front or rear of the room. The setting of "0" is a neutral default. "+" settings move the sound toward the front of the room, while "-" settings move the sound toward the rear. Use the left/right arrow buttons to adjust it.

See *Audio Processing and Surround Sound*, on page 17, for more information about Dolby Pro Logic II.

Auto Power Control: This setting allows you to set the AVR to automatically enter the Standby mode after a period of inactivity, saving energy. The available settings are Off (default), 2 hours, 4 hours and 6 hours.

Speaker On/Off: Use this setting to turn the speakers off when you are listening through headphones.

Operating Your AVR

Now that you have installed your components and completed a basic configuration, you are ready to begin enjoying your home theater system.

Controlling the Volume

Adjust the volume either by turning the front-panel Volume knob (clockwise to increase volume or counterclockwise to decrease volume) or by pressing the Volume Up/Down buttons on the remote.

Muting the Sound

To mute all speakers and the headphones, press the Mute button on the remote. Any recording in progress will not be affected. The MUTE message will appear in the front-panel display as a reminder. To restore the sound, press the Mute button again, or adjust the volume.

Listening Through Headphones

Plug the 1/4-inch stereo plug on a pair of headphones into the front-panel Phones jack for private listening. Note: For information about turning off the speakers during headphone listening, see *Additional Setup Menu Items – Speaker On/Off*, on page 15.

Selecting a Source

There are two different ways to select a source:

- Press the front-panel Source Select buttons.
- Directly select any source by pressing its Source Selector button on the remote.

The AVR selects the analog audio and video inputs assigned to the source and any other settings you made during setup.

The digital audio inputs are not assigned to any specific sets of analog inputs. Once you select a source device you can use the remote control's Audio Input Select (DIGITAL) button to select the specific audio input connection (HDMI, coaxial digital, optical digital, analog) that you want to listen to. (Note: You cannot select an audio input connection for the FM/AM or USB source buttons.)

The source name, the selected audio input and the surround mode will appear on the front panel.

Video Troubleshooting Tips

If there is no picture:

- Check the source selection.
- Check all connections for a loose or incorrect connection.
- Check the video-input selection on the TV/display device.

Additional Tips for Troubleshooting HDMI Connections

- Turn off all devices (including the TV, the AVR and any source components).
- Unplug the HDMI cables, starting with the cable between the AVR and the TV, and continuing with the cables between the AVR and each source device.
- Carefully reconnect the cables from the source devices to the AVR. Connect the cable from the AVR to the TV last.
- Turn on the devices in this order: TV, AVR, source devices.

NOTE: Depending upon the particular components involved, the complexity of the required communication between HDMI components may cause delays of up to a minute in the completion of some actions, such as input switching or switching between SD and HD channels.

Listening to FM and AM Radio

Select the AM/FM source. Use the Tuning Up/Down buttons to tune a station, which will be shown on the front-panel display and the TV screen.

In the FM Stereo mode, the radio uses automatic tuning, meaning each press of the Tuning Up/Down buttons scans until a station with acceptable signal strength is found. In the FM Mono mode, the radio uses manual tuning, in which each press of a Tuning button steps through a single frequency increment. (Using the FM Mono mode may improve the reception of weaker stations.)

Preset Stations

A total of 30 stations (AM and FM combined) may be stored as presets. When the desired station has been tuned in, press the Memory button and the preset number will flash on the front-panel Message display. Use the remote's Number buttons to enter the desired preset number.

To tune a preset station, press the Preset Up/Down buttons or enter the preset number using the remote's Number buttons.

Listening to Media on a USB Device

Your AVR is compatible with USB 2.0 or USB 1.1 media in the FAT 16 or FAT 32 file format and is compatible with the following MP3 and WMA media:

- MP3: Bit rates between 96 – 320kbps. Fixed bit-rates at 44.1kHz sampling is recommended. Variable bit-rates (VBR) are playable, but playing time may be displayed incorrectly. Files must have a “.mp3” file extension.
- WMA: Bit rates of 64kbps or higher. NOTE: Bit rates of 80kbps and 256kbps are not compatible. Files must have a “.wma” file extension.

A maximum number of 65,536 folders and files can be supported.

Playing files on a USB device

1. Insert the USB drive into the AVR's front-panel USB port. **IMPORTANT:** Do not connect a personal computer or peripheral to the USB port. USB hubs are not supported.
2. Select USB as the source device. “USB” will appear on the front-panel display, and after the AVR loads the contents of the current folder the USB playback screen will appear on the OSD.

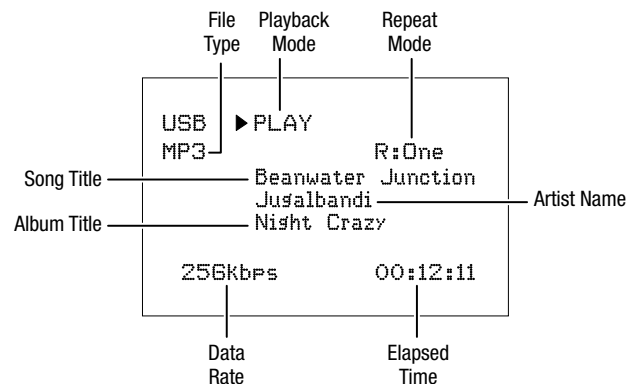

Use the remote's Transport Control buttons to control playback.

To browse the contents of the current folder, press the remote's BACK button. The USB folder screen will appear on the OSD for 20 seconds.

```

USB
  ▲ Last      002/010
[Ants Ate My Silkworms.mp3 ]
[Night Crazy.mp3           ]
[Beanwater Junction, Part 1]
[Yarmishun Jim.mp3        ]
[Successfully Assimilated, P]
[The Lost Transit Center.mp]
[Successfully Assimilated, P]
[Beanwater Junction, Part 2]
ENTER ▼ Next
    
```

Use the remote's up, down and OK buttons to highlight and select tracks.

IMPORTANT: To prevent damage or malfunction, press the remote's Stop (■) Transport Control button before removing the USB device from the AVR's USB port.

Selecting a Surround Mode

Selecting a surround mode can be as simple or sophisticated as your individual system and tastes. Feel free to experiment, and you may find a few favorites for certain sources or program types. You can find more detailed information on surround modes in *Audio Processing and Surround Sound*, below.

To select a surround mode, press the Surround Mode Select buttons. Each press advances to the next available surround mode.

Digital surround-sound modes, such as Dolby Digital and DTS systems, are available only with specially encoded programs, such as those available via HDTV, DVD and Blu-ray Disc media and digital cable or satellite television. Other surround modes such as Dolby Pro Logic II may be used with digital or analog signals to create a different surround presentation or to use a different number of speakers.

Surround mode selection depends upon the number of speakers in your system, the programs you are watching or listening to, and your personal tastes.

Advanced Functions

Much of the adjusting and configuration your AVR requires is handled automatically, with little intervention required on your part. You can also customize your AVR to suit your system and your tastes. In this section, we will describe some of the more advanced adjustments available to you.

Audio Processing and Surround Sound

Audio signals can be encoded in a variety of formats that affect not only the quality of the sound but also the number of speaker channels and the surround mode. You may also manually select a different surround mode, when available.

Analog Audio Signals

Analog audio signals usually consist of two channels – left and right. Your AVR offers several options for analog playback:

- **Stereo:** When you want conventional 2-channel playback, press the STEREO button. Sound will be output from the front left and right speakers.
- **5-Ch Stereo:** When you want to hear stereo sound through all of the system's speakers (such as during a party), select 5CH STEREO via the Surround Mode Select buttons. This plays the left-channel signal through the front left and surround left speakers, the right-channel signal through the front right and surround right speakers, and a summed mono signal through the center speaker.
- **Analog Surround Modes:** Your AVR is able to process 2-channel audio signals to produce multi-channel surround sound, even when no surround sound has been encoded in the recording. Among the available modes are Dolby Pro Logic II, Dolby Pro Logic, DTS Neo: 6, Theater, Hall, Stadium, Club and Arena modes. Use the Surround Mode Select buttons to select one of these modes. See Table A5 in the Appendix, on page 25, for brief explanations of each of these surround modes.

Digital Audio Signals

Digital audio signals offer greater flexibility and capacity than analog signals and allow the encoding of up to 5.1 channels of discrete channel information directly into the signal. The result is improved sound quality and startling directionality, since each channel's information is transmitted independently of the other channels. High-resolution recordings sound extraordinarily distortion-free, especially in the high frequencies.

Digital surround-sound formats include Dolby Digital 2.0 (two channels only), Dolby Digital 5.1, Dolby Digital EX (6.1), Dolby Digital Plus (7.1), Dolby TrueHD (7.1), DTS-HD High-Resolution Audio (7.1), DTS-HD Master Audio (7.1), DTS 5.1, DTS 96/24 (5.1), 2-channel PCM modes in 44.1kHz, 48kHz, 88.1kHz, 96kHz or 176.4kHz, and 5.1 or 7.1 multichannel PCM. (Your AVR will downmix the discrete surround back-channel information in 6.1-channel and 7.1-channel recordings into your system's surround left and surround right channels.)

Surround Mode Selection

Surround-mode selection depends upon the format of the incoming audio signal as well as your personal taste. Although there is never a time when all of the AVR's surround modes are available, the table below indicates which surround modes are available for a given input.

Input Signal Format	Available Surround Modes
Dolby True HD, Dolby Digital Plus, Dolby Digital (7.1-channel/5.1-channel)	Corresponding Dolby True HD or Dolby Digital mode (Theater, Hall, Stadium, Club, Arena and 5-Ch Stereo are also available for 5.1-channel programs)
Dolby Digital (2.0-channel)	Dolby Pro Logic II Movie, Dolby Pro Logic II Music, Dolby Pro Logic II Game, Dolby Pro Logic
DTS HD Master Audio, DTS, DTS 96/24	Corresponding DTS Mode (Theater, Hall, Stadium, Club, Arena and 5-Ch Stereo are also available for 5.1-channel programs)
PCM (2-channel), Analog (2-channel)	Dolby Pro Logic II Movie, Dolby Pro Logic II Music, Dolby Pro Logic II Game, Dolby Pro Logic, DTS Neo:6 Cinema, DTS Neo:6 Music, Theater, Hall, Stadium, Club, Arena, 5-Ch Stereo
MP3/WMA	Dolby Pro Logic II Movie, Dolby Pro Logic II Music, Dolby Pro Logic II Game, Dolby Pro Logic, DTS Neo:6 Cinema, DTS Neo:6 Music, Theater, Hall, Stadium, Club, Arena, 5-Ch Stereo

When in doubt, check the broadcast or the jacket of your disc for more information on which surround modes are available. Usually, nonessential sections of a disc, such as trailers, extra materials or the disc menu, are available only in Dolby Digital 2.0 (2-channel) or PCM 2-channel mode. Look for an audio setup section in the disc's menu. Also, make sure your disc player's audio output is set to the original bitstream rather than 2-channel PCM. Stop play and check the player's output setting.

Adjusting the Channel Volumes

In addition to using the AVR's built-in test noise to configure the AVR for your speakers as explained in *Configure the AVR for Your Speakers*, you can also adjust the volume of any channel at any time to compensate for individual program sources or your personal taste.

1. Press the remote's Channel Level button. The Message Display will show the left channel volume level.
2. Use the remote's up and down arrow buttons to display the channel you want to adjust.
3. Use the remote's left and right arrow buttons to adjust the channel's volume.

Press the BACK button when you're finished.

Recording

Two-channel analog audio signals, as well as composite video signals, are normally available at the appropriate recording output connectors. To make a recording, connect your audio or video recorder to the appropriate AVR output connectors as described in the *Making Connections* section, insert blank media in the recorder and make sure the recorder is turned on and recording while the source is playing. Refer to the recording device's instructions for complete information about making recordings.

NOTES:

1. The AVR does not convert digital signals to analog. Only devices connected to the analog audio and composite video input connections can be recorded.
2. HDMI video sources are not available for recording.
3. Please make certain that you are aware of any copyright restrictions on any material you record. Unauthorized duplication of copyrighted materials is prohibited by law.

Sleep Timer

The sleep timer sets the AVR to play for up to 90 minutes and then turn off automatically.

Press the Sleep button on the remote, and the time until turn-off will be displayed on the front-panel Message display. The available settings are 30 min., 60 min., 90 min. and OFF.

When the sleep timer has been set, a small crescent-moon icon will appear on the front-panel display.

If you press the Sleep button after the timer has been set, the remaining play time will be displayed. Press the Sleep button again to change the play time.

Processor Reset

If the AVR behaves erratically after a power surge, first turn off the front-panel Main Power switch and unplug the AC power cord for at least 3 minutes. Plug the cord back in and turn the AVR on. If this procedure doesn't help, reset the AVR's processor as described below.

NOTE: Resetting the processor will erase all user configurations, including speaker and level settings, and tuner presets. After a reset, reenter all of these settings from your notes in the Appendix worksheets.

To reset the AVR's processor:

1. Press the front-panel Standby/On switch to place the unit in the Standby mode (the Standby Indicator LED will turn amber).
2. Press and hold the front-panel Standby and Memory/Folder buttons until the RESET message appears on the front-panel Message display.
3. Press the Memory/Folder button again to reset the AVR's processor.

If the AVR does not function correctly after a processor reset, contact an authorized Harman Kardon service center for assistance. To locate an authorized service center, visit our Web site at www.harmankardon.com.

Memory

If the AVR is unplugged or experiences a power outage, it will retain your user settings for up to two weeks.

Troubleshooting

Symptom	Cause	Solution
Unit does not function when Main Power switch is turned on	<ul style="list-style-type: none"> No AC power 	<ul style="list-style-type: none"> Ensure that the power cord is plugged into a live AC power outlet Check if the AC outlet is switch-controlled
Front-panel Message display lights, but there's no sound or picture	<ul style="list-style-type: none"> Intermittent input connection Mute is on Volume control is turned down 	<ul style="list-style-type: none"> Secure all input and speaker connections Press Mute button Turn up Volume control
No sound from any speaker	<ul style="list-style-type: none"> Speakers set to "Off" in System Setup menu 	<ul style="list-style-type: none"> Set speakers to "On" in System Setup menu. See <i>Additional Setup Menu Items: Speaker On/Off</i>, on page 15, for more information.
No sound from any speaker; PROTECT message appears on Message display	<ul style="list-style-type: none"> Amplifier is in protection mode due to possible short circuit Amplifier is in protection mode due to internal problems 	<ul style="list-style-type: none"> Check all speaker wires at speaker and AVR connections for crossed wires Contact your local Harman Kardon service center
No sound from center or surround speakers	<ul style="list-style-type: none"> Incorrect surround mode Program material is monophonic Incorrect speaker configuration Program material is stereo 	<ul style="list-style-type: none"> Select a surround mode other than stereo Mono programs contain no surround information Check the speaker configuration in the setup menu The surround decoder may not create center- or surround-channel information from nonencoded stereo programs
Unit does not respond to remote control commands	<ul style="list-style-type: none"> Weak batteries in remote AVR not selected Remote sensor is obscured 	<ul style="list-style-type: none"> Change batteries in remote Press the Setup/AVR button Ensure that the AVR's front-panel remote sensor is in the line of sight of the remote
Intermittent buzzing in tuner	<ul style="list-style-type: none"> Local interference 	<ul style="list-style-type: none"> Move the AVR or antenna away from computers, fluorescent lights, motors or other electrical appliances

Additional information on troubleshooting possible problems with your AVR and installation-related issues may be found in the list of "Frequently Asked Questions," which is located in the Product Support section of our Web site: www.harmankardon.com

Specifications

Audio Section

Multichannel power:	75W per channel, two channels driven @ 6 ohms, 20Hz – 20kHz, <0.1% THD; 100W per channel, two channels driven @ 6 ohms, 1kHz, <1% THD
Input sensitivity/impedance:	200mV/47k ohms
Signal-to-noise ratio (IHF-A):	95dB
Surround system adjacent-channel separation:	Dolby Pro Logic/PLII: 40dB Dolby Digital: 55dB DTS: 55dB
Frequency response:	10Hz – 100kHz
High instantaneous-current capability (HCC):	±25 amps

FM Tuner Section

Frequency range:	87.5 – 108.0MHz
Usable sensitivity IHF:	1.3µV/13.2dBf
Signal-to-noise ratio (mono/stereo):	65dB/62dB
Distortion (mono/stereo):	0.2%/0.3%
Stereo separation:	35dB @ 1kHz
Image rejection:	80dB
IF rejection:	80dB

AM Tuner Section

Frequency range:	520 – 1720kHz
Signal-to-noise ratio:	45dB
Usable sensitivity (loop):	500µV
Selectivity (±10kHz):	30dB

Video Section

Television format:	NTSC (AVR 700); PAL (AVR 70/AVR 70C)
Input level/impedance:	1Vp-p/75 ohms
Output level/impedance:	1Vp-p/75 ohms
Video frequency response (composite video):	10Hz – 8MHz (–3dB)
HDMI:	With 3D and Deep Color

General Specifications

Power requirement:	120V AC/60Hz (AVR 700) 220V AC/50Hz (AVR 70) 230V AC/50Hz (AVR 70C)
Power consumption:	<0.5W (standby); 280W maximum
Dimensions (W x H x D):	17-5/16" x 4-5/16" x 13" (440mm x 125mm x 330mm)
Weight	20 lb (9.1kg)

Appendix – Default settings, worksheets, remote product codes

Table A1 – Recommended Source Component Connections

Device Type	AVR Source	Audio Connections	Video Connections
VCR, DVR, PVR, or other audio/video recorder	Video 1	<ul style="list-style-type: none"> • Video 1 Analog (inputs and outputs) 	<ul style="list-style-type: none"> • Composite Video 1 Input • For recording, use Composite Video 1 Output
Cable TV, Satellite, HDTV or other device that delivers television programs	Video 2	<ul style="list-style-type: none"> • Video 2 Analog inputs • Optical 1 Input (if not in use) 	Composite Video 2 Input
Blu-ray Disc player	HDMI 1	<ul style="list-style-type: none"> • HDMI 1 Input 	<ul style="list-style-type: none"> • HDMI 1 Input
HDMI-capable disc player, game console or other audio/video device	HDMI 2	<ul style="list-style-type: none"> • HDMI 2 Input 	<ul style="list-style-type: none"> • HDMI 2 Input
HDMI-capable disc player, game console or other audio/video device	HDMI 3	<ul style="list-style-type: none"> • HDMI 3 Input 	<ul style="list-style-type: none"> • HDMI 3 Input
Portable audio device, camcorder, game console	Video 3	<ul style="list-style-type: none"> • Video 3 Analog Audio Input on front panel 	<ul style="list-style-type: none"> • Video 3 Coaxial Video Input on front panel
CD player	Aux	<ul style="list-style-type: none"> • Aux Analog Inputs • Any one available coaxial or optical digital audio input 	<ul style="list-style-type: none"> • Not required
CD-R, MiniDisc, cassette	Tape	<ul style="list-style-type: none"> • Tape Analog (inputs and outputs) 	<ul style="list-style-type: none"> • Not required

Note: Table A1 is a guideline; you may need to make adjustments to fit your system.

Table A2 – Speaker/Channel Settings

Source	Speaker Setting
Left/Right Speaker	
Center Speaker	
Surround Speakers	
Subwoofer	
Crossover	

Table A3 – Speaker Volume and Distance Settings

Speaker Positions	Channel Volume Setting	Your Distance From Speaker to Listening Position
Front Left		
Center		
Front Right		
Surround Right		
Surround Left		
Subwoofer		

Table A4 – Surround Modes

Surround Mode	Description	Incoming Bitstream or Signal
Dolby Digital	Provides up to five separate main audio channels and a dedicated low-frequency effects (LFE) channel.	<ul style="list-style-type: none"> • Dolby Digital 1/0/.0 or .1, 2/0/.0 or .1, 3/0/.0 or .1, 2/1/.0 or .1, 2/2/.0 or .1, 3/2/.0 or .1 • Dolby Digital EX (played as 5.1) • Dolby Digital Plus decoded and delivered via coaxial or optical connection
Dolby Digital Plus	An enhanced version of Dolby Digital encoded more efficiently, Dolby Digital Plus has the capacity for additional discrete channels and for streaming audio from the Internet, all with enhanced audio quality. Source material may be delivered via an HDMI connection or decoded to Dolby Digital or PCM and transmitted via coaxial or optical digital audio.	<ul style="list-style-type: none"> • Dolby Digital Plus via HDMI connection (source device decodes to Dolby Digital when a coaxial or optical connection is used)
Dolby TrueHD	Dolby TrueHD is an expansion of MLP Lossless™ audio, the same format used on DVD-Audio discs. Dolby TrueHD adds the features found in Dolby Digital, such as night mode settings, while delivering fully lossless audio that is a true reproduction of studio master recordings.	<ul style="list-style-type: none"> • Blu-ray Disc or HD-DVD encoded with Dolby TrueHD, delivered via HDMI
Dolby Digital Stereo	Delivers a 2-channel downmix of Dolby Digital materials.	<ul style="list-style-type: none"> • Dolby Digital 1/0/.0 or .1, 2/0/.0 or .1, 3/0/.0 or .1, 2/1/.0 or .1, 2/2/.0 or .1, 3/2/.0 or .1 • Dolby Digital EX
Dolby Pro Logic II Mode Group	Analog decoder that derives five full-range, discrete main audio channels from matrix surround-encoded or 2-channel analog sources. Four variants are available.	See below
Dolby Pro Logic II Movie	Variant of Dolby Pro Logic II that is optimized for movie and television programs.	<ul style="list-style-type: none"> • Dolby Digital 2.0 or 2.1 • Analog (two-channel) • Tuner • PCM (32kHz, 44.1kHz, 48kHz, 96kHz) • MP3/WMA
Dolby Pro Logic II Music	Variant of Dolby Pro Logic II that is optimized for music selections. Allows adjustment of sound-field presentation in three dimensions: <ul style="list-style-type: none"> • Center Width (adjusts width of vocal soundstage) • Dimension (adjusts depth of soundstage) • Panorama (adjusts wraparound surround effect) 	<ul style="list-style-type: none"> • Dolby Digital 2.0 or 2.1 • Analog (two-channel) • Tuner • PCM (32kHz, 44.1kHz, 48kHz, 96kHz) • MP3/WMA
Dolby Pro Logic II Game	Variant of Dolby Pro Logic II that emphasizes use of the surround channels and subwoofer for total immersion in the video gaming experience.	<ul style="list-style-type: none"> • Dolby Digital 2.0 or 2.1 • Analog (two-channel) • Tuner • PCM (32kHz, 44.1kHz, 48kHz, 96kHz) • MP3/WMA
Dolby Pro Logic	Original version of Dolby Pro Logic that steered a mono signal containing information below 7kHz to the surround channels.	<ul style="list-style-type: none"> • Dolby Digital 2.0 or 2.1 • Analog (two-channel) • Tuner • PCM (32kHz, 44.1kHz, 48kHz, 96kHz) • MP3/WMA
DTS Digital	Using a different encoding/decoding method from Dolby Digital, DTS Digital also provides up to five discrete main channels, plus an LFE channel.	<ul style="list-style-type: none"> • DTS 1/0/.0 or .1, 2/0/.0 or .1, 3/0/.0 or .1, 3/1/.0 or .1, 2/2/.0 or .1, 3/2/.0 or .1 • DTS-ES Matrix (played as 5.1) • DTS-ES Discrete (played as 5.1)
DTS-HD	DTS-HD is a high-definition audio format that complements the high-definition video found on Blu-ray Disc and HD-DVD discs. It is transmitted using a DTS core with high-resolution extensions. Even when only DTS 5.1 surround sound is desired (or available, if the multizone system is in use), the higher capacity of high-resolution discs serves up DTS at twice the bit rate used on DVD-Video discs.	<ul style="list-style-type: none"> • Blu-ray Disc or HD-DVD discs encoded with DTS-HD modes, delivered via HDMI connection
DTS-HD Master Audio	DTS-HD Master Audio technology delivers bit-for-bit reproductions of studio master recordings for an incredibly accurate performance.	<ul style="list-style-type: none"> • Blu-ray Disc or HD-DVD discs encoded with DTS-HD Master Audio technology, delivered via HDMI connection

Table A4 – Surround Modes (cont.)

Surround Mode	Description	Incoming Bitstream or Signal
DTS Stereo	Delivers a 2-channel downmix of DTS Digital materials or presents a matrix-encoded surround presentation.	<ul style="list-style-type: none"> • DTS 1/0/0 or .1, 2/0/0 or .1, 3/0/0 or .1, 3/1/0 or .1, 2/2/0 or .1, 3/2/0 or .1 • DTS 96/24 • DTS-ES Matrix
DTS Neo:6 Cinema	Delivers an enhanced 5.1-channel surround-sound experience for movies	<ul style="list-style-type: none"> • Analog (two-channel) • AM/FM radio • PCM (32kHz, 44.1kHz, 48kHz, 96kHz) • MP3/WMA
DTS Neo:6 Music	Delivers an enhanced 5.1-channel surround-sound experience for music	<ul style="list-style-type: none"> • Analog (two-channel) • AM/FM radio • PCM (32kHz, 44.1kHz, 48kHz, 96kHz) • MP3/WMA
Theater	Creates the effect of being in a large movie theater. Works well with movies.	<ul style="list-style-type: none"> • Analog (two-channel) • AM/FM radio • PCM (32kHz, 44.1kHz, 48kHz, 96kHz) • MP3/WMA
Hall	Creates the ambience of a concert hall. Good when listening to classical music sources such as orchestral music, chamber music or instrumental soloists.	<ul style="list-style-type: none"> • Analog (two-channel) • AM/FM radio • PCM (32kHz, 44.1kHz, 48kHz, 96kHz) • MP3/WMA
Stadium	Creates an expansive soundfield as heard in stadiums. Good for watching sporting events like baseball or soccer.	<ul style="list-style-type: none"> • Analog (two-channel) • AM/FM radio • PCM (32kHz, 44.1kHz, 48kHz, 96kHz) • MP3/WMA
Club	Creates the ambience of a club with a low ceiling and hard wall surfaces. Good for listening to jazz or other intimate musical ensembles.	<ul style="list-style-type: none"> • Analog (two-channel) • AM/FM radio • PCM (32kHz, 44.1kHz, 48kHz, 96kHz) • MP3/WMA
Arena	Creates a dynamic and broad soundspace that heightens the impact of film soundtracks and musical performances.	<ul style="list-style-type: none"> • Analog (two-channel) • AM/FM radio • PCM (32kHz, 44.1kHz, 48kHz, 96kHz) • MP3/WMA
5-Channel Stereo	Useful for parties, the left- and right-channel information is played through both the front and surround speakers on each side, while the center speaker plays a summed mono mix.	<ul style="list-style-type: none"> • Analog (two-channel) • Tuner • PCM (32kHz, 44.1kHz, 48kHz, 96kHz) • MP3/WMA
2-Channel Stereo	Turns off all surround processing and plays a pure 2-channel signal or a downmix of a multichannel signal. The signal is digitized and bass management settings are applied, making it appropriate when a subwoofer is used.	<ul style="list-style-type: none"> • Analog (two-channel; DSP downmix available for multichannel) • Tuner • PCM (32kHz, 44.1kHz, 48kHz, 96kHz) • MP3/WMA

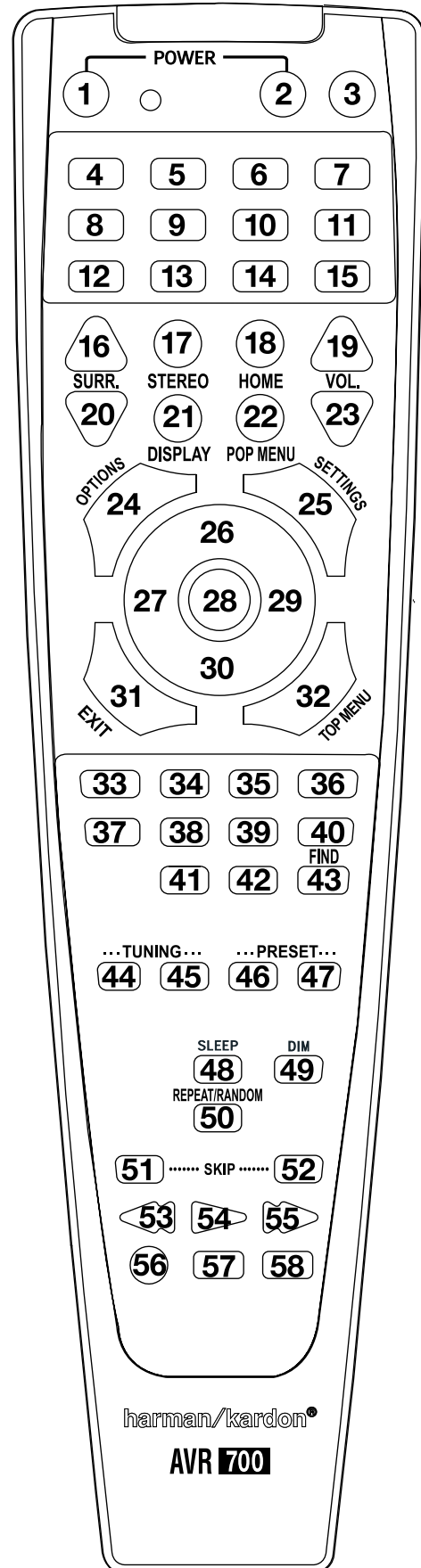

Refer to the numbered buttons when using the Remote Control Function List

Table A5 – Remote Control Function List

No.	Button Name	AVR Function	Blu-ray/DVD
01	Power On	Power On	Power On
02	Power Off	Power Off	Power Off
03	Mute	Mute	Mute
04	AVR	AVR Select	AVR Select
05	HDMI 1	HDMI 1 Select	HDMI 1 Select
06	HDMI 2	HDMI 2 Select	HDMI 2 Select
07	HDMI 3	HDMI 3 Select	HDMI 3 Select
08	USB	USB Select	USB Select
09	VID 1	Video 1 Select	Video 2 Select
10	VID 2	Video 2 Select	Video 2 Select
11	VID 3	Video 3 Select	Video 3 Select
12	AM/FM	Radio Select	Radio Select
13	TV	HDMI ARC Select	HDMI ARC Select
14	AUX	Aux	Stereo Mode Select
15	Tape	Tape Select	Tape Select
16	SURR+	Surr Mode Select +	Surr Mode Select +
17	STEREO	Stereo Mode Select	Stereo Mode Select
18	TONE	Tone Controls	Home (BD)
19	VOL +	Volume Up	Volume Up
20	SURR-	Surr Mode Select -	Surr Mode Select -
21	DISPLAY	Display Mode Select	Display Mode Select
22	TEST	Test Tone On/Off	Pop-Up Menu
23	VOL-	Volume Down	Volume Down
24	DIGITAL	Input Type Select	Options Menu
25	SETUP	Setup Menu On/Off	Settings (BD) Setup (DVD)
26	Up	Move/Adust Up	Up
27	Left	Move/Adjust Left	Left
28	OK	OK	Enter
29	Right	Move/Adjust Right	Right
30	Down	Move/Adjust Down	Down
31	BACK	Previous Menu	Exit (BD)
32	CHANNEL	Channel Level Adjust	Top Menu Display (BD)

No.	Button Name	AVR Function	Blu-ray/DVD
33	1	1	1
34	2	2	2
35	3	3	3
36	4	4	4
37	5	5	5
38	6	6	6
39	7	7	7
40	8	8	8
41	9	9	9
42	0	0	0
43	MEMORY	Preset Memory	Find
44	Tuning Down	Tuning Down	Program/Red (BD)
45	Tuning Up	Tuning Up	Bookmark/Green (BD)
46	Preset Down	Preset Tune Down	Thumbnail/Yellow (BD)
47	Preset Up	Preset Tune Down	Zoom/Blue (BD)
48	SLEEP/CLEAR	Sleep Timer	Clear
49	Dim	Display Dimmer	Display Dimmer
50	Repeat/Random	USB Repeat/Ramdon	Repeat
51	Skip Down	----	Previous
52	Skip Up	----	Next
53	Reverse ◀◀	----	Reverse Search
54	Play ▶▶	----	Play/Reverse
55	Forward ▶▶	----	Forward Search
56	Open/Close	----	Open/Close
57	Stop	----	Stop
58	Pause	----	Pause



HARMAN

HARMAN International Industries, Incorporated
8500 Balboa Boulevard, Northridge, CA 91329 USA

© 2012 HARMAN International Industries, Incorporated. All rights reserved.

Harman Kardon is a trademark of HARMAN International Industries, Incorporated, registered in the United States and/or other countries.

Blu-ray Disc is a trademark of the Blu-ray Disc Association.

CEA is a registered trademark of the Consumer Electronics Association.

Manufactured under license from Dolby Laboratories. Dolby, the double-D symbol and Pro Logic are registered trademarks of Dolby Laboratories. MLP Lossless is a trademark of Dolby Laboratories.

Manufactured under license under U.S. Patent Nos: 5,956,674; 5,974,380; 6,226,616; 6,487,535; 7,212,872; 7,333,929; 7,392,195; 7,272,567 & other U.S. and worldwide patents issued & pending. DTS-HD, the Symbol, & DTS-HD and the Symbol together are registered trademarks of DTS, Inc. © DTS, Inc. All Rights Reserved.

HDMI, the HDMI logo and High-Definition Multimedia Interface are registered trademarks of HDMI Licensing LLC in the United States and other countries.

Features, specifications and appearance are subject to change without notice.

HKP4078 Rev. 1

harman/kardon
by HARMAN

www.harmankardon.com