

ONKYO®

AV Receiver

TX-NR3007

TX-NR5007

Instruction Manual

Thank you for purchasing an Onkyo AV Receiver. Please read this manual thoroughly before making connections and plugging in the unit. Following the instructions in this manual will enable you to obtain optimum performance and listening enjoyment from your new AV Receiver. Please retain this manual for future reference.

Contents

Introduction 2

Connection 18

Turning On & First Time Setup 48

Basic Operations..... 67

Using the Listening Modes 81

Advanced Setup 92

NET/USB..... 120

Multi Zone 130

Controlling Other Components.... 139

Others..... 154

WARNING:

TO REDUCE THE RISK OF FIRE OR ELECTRIC SHOCK, DO NOT EXPOSE THIS APPARATUS TO RAIN OR MOISTURE.

CAUTION:

TO REDUCE THE RISK OF ELECTRIC SHOCK, DO NOT REMOVE COVER (OR BACK). NO USER-SERVICEABLE PARTS INSIDE. REFER SERVICING TO QUALIFIED SERVICE PERSONNEL.



WARNING
RISK OF ELECTRIC SHOCK
DO NOT OPEN

AVIS
RISQUE DE CHOC ELECTRIQUE
NE PAS OUVRIR



The lightning flash with arrowhead symbol, within an equilateral triangle, is intended to alert the user to the presence of uninsulated “dangerous voltage” within the product’s enclosure that may be of sufficient magnitude to constitute a risk of electric shock to persons.



The exclamation point within an equilateral triangle is intended to alert the user to the presence of important operating and maintenance (servicing) instructions in the literature accompanying the appliance.

Important Safety Instructions

1. Read these instructions.
2. Keep these instructions.
3. Heed all warnings.
4. Follow all instructions.
5. Do not use this apparatus near water.
6. Clean only with dry cloth.
7. Do not block any ventilation openings. Install in accordance with the manufacturer’s instructions.
8. Do not install near any heat sources such as radiators, heat registers, stoves, or other apparatus (including amplifiers) that produce heat.
9. Do not defeat the safety purpose of the polarized or grounding-type plug. A polarized plug has two blades with one wider than the other. A grounding type plug has two blades and a third grounding prong. The wide blade or the third prong are provided for your safety. If the provided plug does not fit into your outlet, consult an electrician for replacement of the obsolete outlet.
10. Protect the power cord from being walked on or pinched particularly at plugs, convenience receptacles, and the point where they exit from the apparatus.
11. Only use attachments/accessories specified by the manufacturer.
12. Use only with the cart, stand, tripod, bracket, or table specified by the manufacturer, or sold with the apparatus. When a cart is used, use caution when moving the cart/apparatus combination to avoid injury from tip-over.

PORTABLE CART WARNING
S3125A
13. Unplug this apparatus during lightning storms or when unused for long periods of time.
14. Refer all servicing to qualified service personnel. Servicing is required when the apparatus has been damaged in any way, such as power-supply cord or plug is damaged, liquid has been spilled or objects have fallen into the apparatus, the apparatus has been exposed to rain or moisture, does not operate normally, or has been dropped.
15. Damage Requiring Service
Unplug the apparatus from the wall outlet and refer servicing to qualified service personnel under the following conditions:
 - A. When the power-supply cord or plug is damaged,
 - B. If liquid has been spilled, or objects have fallen into the apparatus,
 - C. If the apparatus has been exposed to rain or water,
 - D. If the apparatus does not operate normally by following the operating instructions. Adjust only those controls that are covered by the operating instructions as an improper adjustment of other controls may result in damage and will often require extensive work by a qualified technician to restore the apparatus to its normal operation,
 - E. If the apparatus has been dropped or damaged in any way, and
 - F. When the apparatus exhibits a distinct change in performance this indicates a need for service.
16. Object and Liquid Entry
Never push objects of any kind into the apparatus through openings as they may touch dangerous voltage points or short-out parts that could result in a fire or electric shock.
The apparatus shall not be exposed to dripping or splashing and no objects filled with liquids, such as vases shall be placed on the apparatus.
Don’t put candles or other burning objects on top of this unit.
17. Batteries
Always consider the environmental issues and follow local regulations when disposing of batteries.
18. If you install the apparatus in a built-in installation, such as a bookcase or rack, ensure that there is adequate ventilation.
Leave 20 cm (8") of free space at the top and sides and 10 cm (4") at the rear. The rear edge of the shelf or board above the apparatus shall be set 10 cm (4") away from the rear panel or wall, creating a flue-like gap for warm air to escape.

Precautions

- 1. Recording Copyright**—Unless it's for personal use only, recording copyrighted material is illegal without the permission of the copyright holder.
- 2. AC Fuse**—The AC fuse inside the unit is not user-serviceable. If you cannot turn on the unit, contact your Onkyo dealer.
- 3. Care**—Occasionally you should dust the unit all over with a soft cloth. For stubborn stains, use a soft cloth dampened with a weak solution of mild detergent and water. Dry the unit immediately afterwards with a clean cloth. Don't use abrasive cloths, thinners, alcohol, or other chemical solvents, because they may damage the finish or remove the panel lettering.
- 4. Power**
WARNING
BEFORE PLUGGING IN THE UNIT FOR THE FIRST TIME, READ THE FOLLOWING SECTION CAREFULLY.
AC outlet voltages vary from country to country. Make sure that the voltage in your area meets the voltage requirements printed on the unit's rear panel (e.g., AC 230 V, 50 Hz or AC 120 V, 60 Hz).
The power cord plug is used to disconnect this unit from the AC power source. Make sure that the plug is readily operable (easily accessible) at all times.
Pressing the [ON/STANDBY] button to select Standby mode does not fully shutdown the unit. If you do not intend to use the unit for an extended period, remove the power cord from the AC outlet.
- 5. Preventing Hearing Loss**
Caution
Excessive sound pressure from earphones and headphones can cause hearing loss.
- 6. Batteries and Heat Exposure**
Warning
Batteries (battery pack or batteries installed) shall not be exposed to excessive heat as sunshine, fire or the like.
- 7. Never Touch this Unit with Wet Hands**—Never handle this unit or its power cord while your hands are wet or damp. If water or any other liquid gets inside this unit, have it checked by your Onkyo dealer.
- 8. Handling Notes**
 - If you need to transport this unit, use the original packaging to pack it how it was when you originally bought it.
 - Do not leave rubber or plastic items on this unit for a long time, because they may leave marks on the case.
 - This unit's top and rear panels may get warm after prolonged use. This is normal.
 - If you do not use this unit for a long time, it may not work properly the next time you turn it on, so be sure to use it occasionally.

For U.S. models

FCC Information for User

CAUTION:

The user changes or modifications not expressly approved by the party responsible for compliance could void the user's authority to operate the equipment.

NOTE:

This equipment has been tested and found to comply with the limits for a Class B digital device, pursuant to Part 15 of the FCC Rules. These limits are designed to provide reasonable protection against harmful interference in a residential installation.

This equipment generates, uses and can radiate radio frequency energy and, if not installed and used in accordance with the instructions, may cause harmful interference to radio communications. However, there is no guarantee that interference will not occur in a particular installation. If this equipment does cause harmful interference to radio or television reception, which can be determined by turning the equipment off and on, the user is encouraged to try to correct the interference by one or more of the following measures:

- Reorient or relocate the receiving antenna.
- Increase the separation between the equipment and receiver.
- Connect the equipment into an outlet on a circuit different from that to which the receiver is connected.
- Consult the dealer or an experienced radio/TV technician for help.

For Canadian Models

NOTE: THIS CLASS B DIGITAL APPARATUS COMPLIES WITH CANADIAN ICES-003.

For models having a power cord with a polarized plug:

CAUTION: TO PREVENT ELECTRIC SHOCK, MATCH WIDE BLADE OF PLUG TO WIDE SLOT, FULLY INSERT.

Modèle pour les Canadiens

REMARQUE: CET APPAREIL NUMÉRIQUE DE LA CLASSE B EST CONFORME À LA NORME NMB-003 DU CANADA.

Sur les modèles dont la fiche est polarisée:

ATTENTION: POUR ÉVITER LES CHOCS ÉLECTRIQUES, INTRODUIRE LA LAME LA PLUS LARGE DE LA FICHE DANS LA BORNE CORRESPONDANTE DE LA PRISE ET POUSSER JUSQU'AU FOND.

Precautions—Continued

For British models

Replacement and mounting of an AC plug on the power supply cord of this unit should be performed only by qualified service personnel.

IMPORTANT

The wires in the mains lead are coloured in accordance with the following code:

Blue: Neutral

Brown: Live

As the colours of the wires in the mains lead of this apparatus may not correspond with the coloured markings identifying the terminals in your plug, proceed as follows:

The wire which is coloured blue must be connected to the terminal which is marked with the letter N or coloured black.

The wire which is coloured brown must be connected to the terminal which is marked with the letter L or coloured red.

IMPORTANT

The plug is fitted with an appropriate fuse. If the fuse needs to be replaced, the replacement fuse must be approved by ASTA or BSI to BS1362 and have the same ampere rating as that indicated on the plug. Check for the ASTA mark or the BSI mark on the body of the fuse.

If the power cord's plug is not suitable for your socket outlets, cut it off and fit a suitable plug. Fit a suitable fuse in the plug.

For European Models

Declaration of Conformity

We, ONKYO EUROPE
ELECTRONICS GmbH
LIEGNITZERSTRASSE 6,
82194 GROEBENZELL,
GERMANY



declare in own responsibility, that the ONKYO product described in this instruction manual is in compliance with the corresponding technical standards such as EN60065, EN55013, EN55020 and EN61000-3-2, -3-3.

GROEBENZELL, GERMANY

K. MIYAGI

ONKYO EUROPE ELECTRONICS GmbH

Supplied Accessories

Make sure you have the following accessories:

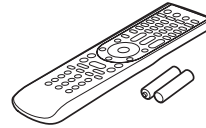

Remote controller & two batteries (AA/R6)

(Note for China: The battery for the remote controller is not supplied for this unit.)

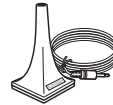

Speaker setup microphone



Indoor FM antenna



AM loop antenna

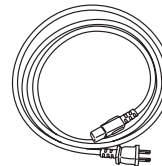

Power cord

(Plug type varies from country to country.)



Speaker cable labels



Power-plug adapter

Only supplied in certain countries. Use this adapter if your AC outlet does not match with the plug on the AV receiver's power cord (adapter varies from country to country).

*How to mount the AC plug:

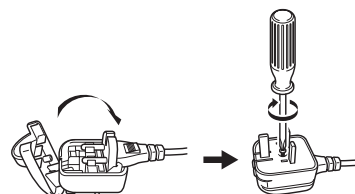

* In catalogs and on packaging, the letter at the end of the product name indicates the color. Specifications and operations are the same regardless of color.

Contents

Introduction

Important Safety Instructions	2
Precautions	3
Supplied Accessories	4
Features	6
Front & Rear Panels	8
Front Panel	8
Display	10
Rear Panel	11
Remote Controller	14
Installing the Batteries	14
Aiming the Remote Controller	14
Controlling the AV Receiver	15
About Home Theater	17
Enjoying Home Theater	17

Connection

Connecting the AV receiver	18
Connecting Your Speakers	18
Bi-amping the Front Speakers A	23
Bridging the Front Speakers A	24
Bi-amping the Front Speakers B	25
Bridging the Front Speakers B	26
Connecting Antenna	27
About AV Connections	29
Connecting Components with HDMI	30
Connecting Both Audio & Video	32
Which Connections Should I Use?	32
Connecting a TV or Projector	35
Connecting a DVD Player	36
Connecting a VCR or DVD Recorder for Playback	38
Connecting a VCR or DVD Recorder for Recording	39
Connecting a Satellite, Cable, Terrestrial Set-top box, or Other Video Source	40
Connecting a Game Console	41
Connecting a Camcorder or Other Device	42
Connecting a CD Player or Turntable	43
Connecting a Cassette, CDR, MiniDisc, or DAT Recorder	44
Connecting a Power Amplifier	45
Connecting an RI Dock	46
Connecting a Universal Port Option Series	46
Connecting Onkyo RI Components	47
Connecting the Power Cord	47

Turning On & First Time Setup

Turning On the AV receiver	48
Turning On and Standby	48
First Time Setup	49
Monitor Setup	49
Selecting the Language used for the onscreen setup menus	50
Using the Onscreen Setup Menus	51
Using the Display to change the settings	51
Monitor Out Setup	52
Video Input Setup	54
Digital Audio Input Setup	56
Analog Audio Input Setup	57
Speaker Settings	57
TV Format Setup (European and Asian models)	59
FM/AM Frequency Step Setup	59
Changing the Input Display	60
Audyssey MultEQ [®] XT Room Correction and Speaker Setup	61

Basic Operations

Basic Operations	67
Selecting the Input Source	67
Adjusting the Bass & Treble	68
Displaying Source Information	68
Setting the Display Brightness	69
Muting the AV Receiver	69
Using the Sleep Timer	69
Selecting Speaker Layout	70
Using Headphones	70
Using Easy Macros	71
Listening to the Radio	73
Using the Tuner	73
Presetting AM/FM Stations	74
Using RDS (European models)	75

Universal Port Option UP-A1 Dock for iPod	77
About the UP-A1 Dock	77
Compatible iPod models	77
Function Overview	77
Controlling iPod	78
Recording	80

Using the Listening Modes

Using the Listening Modes	81
Selecting Listening Modes	81
Listening Modes Available for Each Source Format	82
About the Listening Modes	89

Advanced Setup

Advanced Setup	92
Onscreen Setup Menus	92
Input/Output Assign	93
Speaker Setup	95
Audio Adjust	100
Source Setup	104
Assigning Listening Modes to Input Sources	109
Miscellaneous (Volume/OSD) Setup	110
Hardware Setup	111
Lock Setup	116
Digital Input Signal Formats	116
Using the Audio Settings	117

NET/USB

NET/USB	120
About NET	120
Connecting the AV Receiver	120
Listening to Internet Radio	121
Playing Music Files on a Server	122
Network Settings	126
About USB	127
Playing Music Files on a USB Device	128

Multi Zone

Multi Zone	130
Multiroom Capability	130
Connecting Zone 2	131
Connecting Zone 3	133
Setting the Powered Zone 2/3	134
Setting the Multi Zone	135
Using Zone 2/3	136
Using the Remote Controller in Zone 2/3 and Multiroom Control Kits	138

Controlling Other Components

Controlling Other Components	139
Preprogrammed Remote Control Codes	139
Looking up for Remote Control Code	139
Entering Remote Control Codes	141
Remote Control Codes for Onkyo Components	142
Connected via RI	142
Resetting REMOTE MODE Buttons	142
Resetting the Remote Controller	142
Controlling a TV	143
Controlling a DVD Player or DVD Recorder	144
Controlling a VCR or PVR	145
Controlling a Satellite Receiver or Cable Receiver ...	146
Controlling a CD Player, CD Recorder or MD Recorder	147
Controlling an RI Dock	148
Controlling a Cassette Recorder	149
Activities Setup	150
Learning Commands	152
Using Normal Macros	153

Others

Troubleshooting	154
Specifications (TX-NR3007)	160
Specifications (TX-NR5007)	161
Video Resolution Chart	162

* To reset the AV receiver to its factory defaults, turn it on and, while holding down the [VCR/DVR] button, press the [ON/STANDBY] button (see page 154).

Features

Amplifier

(TX-NR3007)

- 140 Watts/Channel @ 8 ohms (FTC)
- 200 Watts/Channel @ 6 ohms (IEC)
- 250 Watts/Channel @ 6 ohms (JEITA)

(TX-NR5007)

- 145 Watts/Channel @ 8 ohms (FTC)
- 220 Watts/Channel @ 6 ohms (IEC)
- 280 Watts/Channel @ 6 ohms (JEITA)
- WRAT—Wide Range Amplifier Technology (5 Hz–100 kHz bandwidth)
- Linear Optimum Gain Volume Circuitry
- 3-Step Inverted Darlington Circuitry
- H.C.P.S. (High Current Power Supply) Massive High Power Transformer
- Toroidal transformer (TX-NR5007)

Processing

- THX Ultra2 Plus^{*1} Certified
- HQV-Reon-VX Video Processing with 1080p Video Upscaling of All Video Sources via HDMI
- HDMI ver. 1.3a with (Deep Color, x.v.Color, Lip Sync, DTS^{*2}-HD Master Audio, Dolby TrueHD^{*3}, DSD and Multi-CH PCM)
- Dolby Pro Logic IIz^{*3} – New Surround Format (front-high)
- Audyssey Dynamic Surround Expansion^{TM*9} for New Surround Channels (front-wide/front-high)
- DTS Surround Sensation Speaker/Headphone Technology^{*2}
- 4 DSP Modes for Gaming; Rock/Sports/Action/RPG
- Non-Scaling Configuration
- Direct Mode and Pure Audio Mode
- Music Optimizer^{*4} for Digital Music Files
- A-Form Listening Mode Memory
- Latest Burr-Brown 192 kHz/32-Bit DACs Improve Jitter Performance for Cleaner Sound (TX-NR5007)
- Burr-Brown 192 kHz/24-Bit DACs Improve Jitter Performance for Cleaner Sound (TX-NR3007)
- Three TI (Aureus) 32-bit Processing DSP
- Neural Surround Decoding^{*10}
- DSD Direct

Connections

- 7 HDMI^{*5} Inputs and 2 Outputs (TX-NR3007)
- 8 HDMI^{*5} Inputs and 2 Outputs (TX-NR5007)
- Onkyo **RIHD** for System Control
- 6 Digital Inputs (3 Optical/3 Coaxial) (TX-NR3007)
- 7 Digital Inputs (4 Optical/3 Coaxial) (TX-NR5007)
- Universal Port for UP-A1 (Dock for the iPod)/HD Radio^{TM*6} tuner module (North American models)/DAB+ tuner module (European models)
- 2 Independent Subwoofer Pre Outs

- SIRIUS^{*8} Satellite Radio Connectivity (North American models)
- Banana Plug-Compatible Speaker Posts^{*7}
- Powered Zone 2/3
- Internet Radio* Connectivity (SIRIUS Internet Radio^{*8}/vTuner/Last.fm/Pandora/Rhapsody)
* Services available may vary depending on the region.
- Network Capability for Streaming Audio Files
- Bi-Amping and BTL Capability
- USB Port for a USB Mass Storage Device (Audio Only)

Miscellaneous

- 40 SIRIUS^{*8}/AM/FM Presets (North American models)
- 40 AM/FM Presets (European and Asian models)
- Dolby Volume^{*3}
- Audyssey MultEQ[®] XT^{*9} to Correct Room Acoustic Problems
- Audyssey Dynamic EQ^{TM*9} for Loudness Correction
- Audyssey Dynamic Volume^{TM*9}
- Crossover Adjustment (40/50/60/70/80/90/100/120/150/200 Hz)
- A/V Sync Control Function (up to 250 ms)
- Bi-Directional Preprogrammed (with onscreen display setup) RI-Compatible Learning Remote with 4 Activities and Mode-Key LEDs
- ISF (Imaging Science Foundation) Video Calibration

*1.  THX and Ultra2 Plus are trademarks of THX Ltd. THX may be registered in some jurisdictions. All rights reserved. Surround EX is a trademark of Dolby Laboratories. Used with permission.

*2.  Manufactured under license under U.S. Patent #'s: 5,451,942; 5,956,674; 5,974,380; 5,978,762; 6,226,616; 6,487,535; 7,212,872; 7,333,929; 7,392,195; 7,272,567 & other U.S. and worldwide patents issued & pending. DTS is a registered trademark & the DTS logos, Symbol, DTS-HD Master Audio and DTS Surround Sensation are trademarks of DTS, Inc. ©1996-2008 DTS, Inc. All Rights Reserved.

*3.  Manufactured under license from Dolby Laboratories. "Dolby", "Pro Logic", "Surround EX" and the double-D symbol are trademarks of Dolby Laboratories.

*4. Music OptimizerTM is a trademark of Onkyo Corporation.

*5.  HDMI, the HDMI logo and High Definition Multimedia Interface are trademarks or registered trademarks of HDMI Licensing, LLC.

*6.  **HD Radio[®]**
R E A D Y

HD Radio™ and the HD Radio Ready logo are proprietary trademarks of iBiquity Digital Corporation.

To receive HD Radio broadcasts, you must install an Onkyo UP-HT1 HD Radio tuner module (sold separately).

- *7. In Europe, using banana plugs to connect speakers to an audio amplifier is prohibited.

*8.  **SIRIUS[®]**
R E A D Y INTERNET RADIO

SIRIUS, XM and all related marks and logos are trademarks of Sirius XM Radio Inc. and its subsidiaries. All other marks and logos are the property of their respective owners. All rights reserved. SIRIUS and XM subscriptions sold separately. Taxes and a one-time activation fee may apply. XM tuners and home docks or SIRIUS tuners (each sold separately) are required to receive the SIRIUS or XM satellite radio service. All programming and fees subject to change. It is prohibited to copy, decompile, disassemble, reverse engineer, hack, manipulate or otherwise make available any technology or software incorporated in receivers compatible with the SIRIUS or XM Satellite Radio Systems. Service not available in Alaska and Hawaii.

*9.  **AUDYSSEY**
MULTEQ XT
DYNAMIC EQ
DYNAMIC VOLUME



Manufactured under license from Audyssey Laboratories. U.S. and foreign patents pending. Audyssey MultEQ® XT, Audyssey Dynamic Surround Expansion™, Audyssey Dynamic Volume™ and Audyssey Dynamic EQ™ are trademarks of Audyssey Laboratories.

*10.  **neural**
SURROUND
THX TECHNOLOGIES

Neural Surround is a trademark owned by Neural Audio Corporation. THX is a trademark of THX Ltd., which may be registered in some jurisdictions. All rights reserved.

THX Ultra2 Plus

Before any home theater component can be THX Ultra2 Plus certified, it must pass a rigorous series of quality and performance tests. Only then can a product feature the THX Ultra2 Plus logo, which is your guarantee that the Home Theater products you purchase will give you superb performance for many years to come. THX Ultra2 Plus requirements define hundreds of parameters, including power amplifier performance, and pre-amplifier performance and operation for both digital and analog domains. THX Ultra2 Plus receivers also feature proprietary THX technologies (e.g., THX Mode) which accurately translate movie soundtracks for home theater playback.

- * “Xantech” is a registered trademark of Xantech Corporation.
- * “Niles” is a registered trademark of Niles Audio Corporation.
- * Apple and iPod are trademarks of Apple Inc., registered in the U.S. and other countries.
- * “x.v.Color” is a trademark of Sony Corporation.
- * Rhapsody and the Rhapsody logo are registered trademarks of RealNetworks, Inc.
- * “DLNA[®],” the DLNA Logo and DLNA CERTIFIED™ are trademarks, service marks, or certification marks of the Digital Living Network Alliance.”
- * Re-Equalization and the “Re-EQ” logo are trademarks of THX Ltd.

This product incorporates copyright protection technology that is protected by U.S. patents and other intellectual property rights. Use of this copyright protection technology must be authorized by Macrovision Corporation, and is intended for home and other limited consumer uses only unless otherwise authorized by Macrovision. Reverse engineering or disassembly is prohibited.

Front & Rear Panels

Front Panel

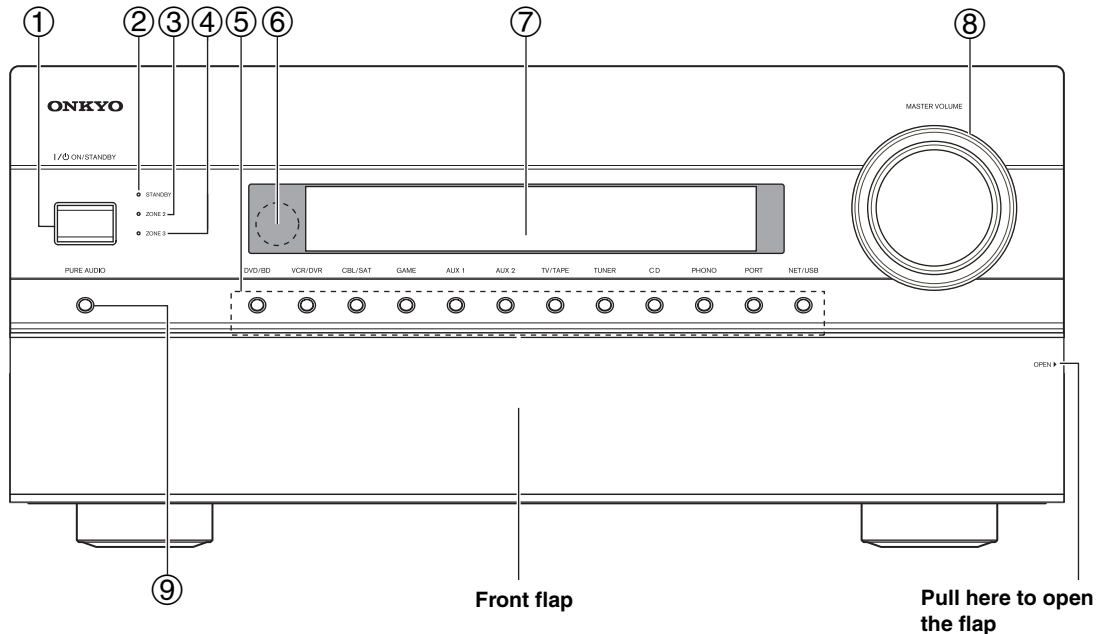

The actual front panel has various logos printed on it. They are not shown here for clarity. The page numbers in parentheses show where you can find the main explanation for each item.

- ① **ON/STANDBY button (48)**
This button is used to set the AV receiver to On or Standby.
- ② **STANDBY indicator (48)**
Lights when the AV receiver is in Standby mode, and it flashes while a signal is being received from the remote controller.
- ③ **ZONE 2 indicator (136)**
Lights when Zone 2 is selected.
- ④ **ZONE 3 indicator (136)**
Lights when Zone 3 is selected.
- ⑤ **Input selector buttons (67)**
These buttons are used to select from the following input sources: DVD/BD, VCR/DVR, CBL/SAT, GAME, AUX 1, AUX 2, TV/TAPE, TUNER, CD, PHONO, PORT, NET/USB.
- ⑥ **Remote control sensor/transmitter (14)**
The sensor receives control signals from the remote controller. The transmitter transmits setting data to the remote controller.
- ⑦ **Display**
See “Display” on page 10.
- ⑧ **MASTER VOLUME control (67) and indicator**
This control is used to adjust the volume of the AV receiver to $-\infty$ dB, -81.5 dB through $+18.0$ dB (relative display).
The volume level can also be displayed as an absolute value. See “Volume Setup” on page 110.
- ⑨ **PURE AUDIO button (81)**
Selects the Pure Audio listening mode. Pressing this button again selects the previous listening mode.

Front & Rear Panels—Continued

(North American models)

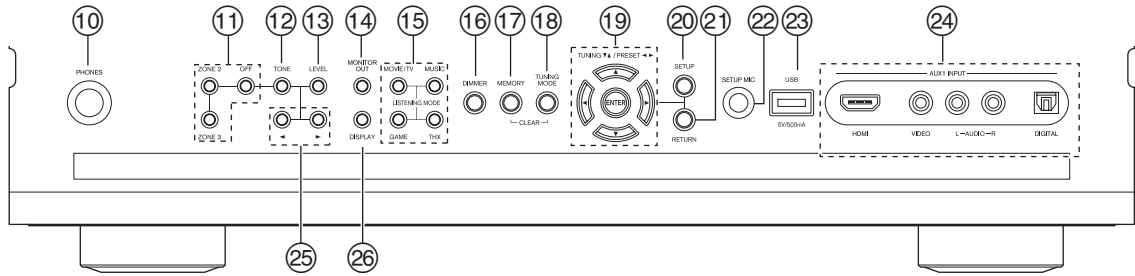

(European and Asian models)

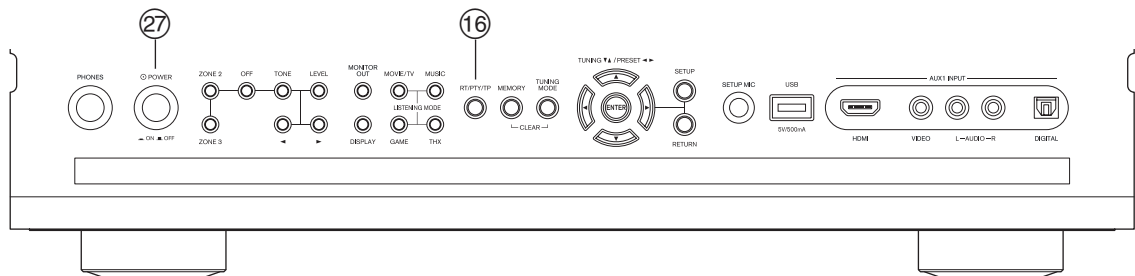

The page numbers in parentheses show where you can find the main explanation for each item.

⑩ PHONES jack (70)

This 1/4-inch phone jack is for connecting a standard pair of stereo headphones for private listening.

⑪ ZONE 2, ZONE 3, and OFF buttons (136)

The [ZONE 2] button is used to select Zone 2. The [ZONE 3] button is used to select Zone 3. The [OFF] button is used to turn off Zone 2 or Zone 3.

⑫ TONE button (68, 137)

Used to select the tone (bass and treble) for the main room, and the tone and balance for Zone 2 or Zone 3.

⑬ LEVEL button (137)

Used to select the volume level of Zone 2 or Zone 3.

⑭ MONITOR OUT button (49)

Used to set the “Monitor Out” setting.

⑮ LISTENING MODE buttons (81)

MOVIE/TV:

Selects the listening modes intended for use with movies and TV.

MUSIC:

Selects the listening modes intended for use with music.

GAME:

Selects the listening modes intended for use with video games.

THX:

Selects the THX listening modes.

⑯ DIMMER button (69)

(North American models)

This button is used to adjust the display brightness.

RT/PTY/TP button (75)

(European and Asian models)

This button is used for RDS (Radio Data System). The [RT/PTY/TP] button does not work in areas where RDS broadcasts are not available. See “Using RDS (European models)” on page 75.

⑰ MEMORY button (74)

This button is used when storing or deleting radio presets.

⑱ TUNING MODE button (73)

This button is used to select the Auto or Manual tuning mode.

⑲ Arrow, TUNING, PRESET and ENTER buttons

When the AM or FM input source is selected, the TUNING [▲]/[▼] buttons are used to tune the tuner, and the PRESET [◀]/[▶] buttons are used to select radio presets (see pages 74 and 76).

When the onscreen setup menus are used, they work as arrow buttons and are used to select and set items. The [ENTER] button is also used with the onscreen setup menus.

⑳ SETUP button

This button is used to access the onscreen setup menus that appear on the connected TV.

㉑ RETURN button

This button is used to return to the previously displayed onscreen setup menu.

22 SETUP MIC jack (62)

Audyssey MultEQ® XT Room Correction and Speaker Setup microphone connects here.

23 USB port (127)

A USB mass storage device, such as a USB flash drive or MP3 player, containing music files can be plugged in here and the music selected can be played through the AV receiver.

24 AUX 1 INPUT (42)

This input can be used to connect a camcorder, game console, and so on. There are jacks for composite video, analog audio, and optical digital audio.

AUX 1 INPUT HDMI (31)

Used to connect an HD camcorder etc.

25 Up [▶] and Down [◀] buttons (68, 137)

Used to adjust the tone (bass and treble) for the main room and the volume, tone and balance for Zone 2 or Zone 3.

26 DISPLAY button (68)

This button is used to display various information about the currently selected input source.

27 POWER switch (48)

(European and Asian models)

This is the main power switch. When set to OFF, the AV receiver is completely shutdown. It must be set to ON to set the AV receiver to On or Standby.

Display

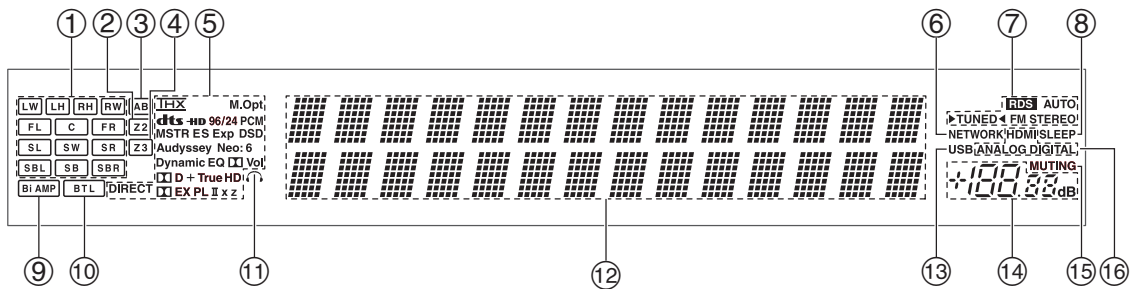

For detailed information, see the pages in parentheses.

1 Speaker/channel indicators

Indicate the speaker channels used by the current listening mode.

The following abbreviations indicate which audio channels are outputted for the current listening mode.

- LW:** Front wide left
- LH:** Front high left
- RH:** Front high right
- RW:** Front wide right
- FL:** Front left
- C:** Center
- FR:** Front right
- SL:** Surround left
- SW:** Subwoofer (Low Frequency Effects)
- SR:** Surround right
- SBL:** Surround back left
- SB:** Surround back
- SBR:** Surround back right

2 Z2 indicator (136)

Lights when Powered Zone 2 is being used.

3 A and B indicators (70)

Indicate which speaker set is selected: A or B.

4 Z3 indicator (136)

Lights when Powered Zone 3 is being used.

5 Listening mode and format indicators (81)

Show the selected listening mode and audio input signal format.

Audyssey (61, 98):

Flashes during Audyssey MultEQ® XT Room Correction and Speaker Setup. Lights when the “Equalizer Settings” is set to “Audyssey” or Audyssey Dynamic Surround Expansion™ listening mode is selected.

Dynamic EQ (102):

Lights when “Dynamic EQ” is enabled.

Vol (102, 118):

Lights when “Dynamic Volume” is enabled.

☐ Vol (101, 118):

Lights when “Dolby Volume” is enabled.

6 NETWORK indicator (121)

Lights when the Net input selector is selected.

Front & Rear Panels—Continued

⑦ Tuning indicators

RDS (European models) (75):

Lights when tuned to a radio station that supports RDS (Radio Data System).

AUTO (73):

Lights when Auto Tuning mode is selected for AM or FM radio. Goes off when Manual Tuning mode is selected.

TUNED (73):

Lights when tuned to a radio station.

FM STEREO (73):

Lights when tuned to a stereo FM station.

⑧ SLEEP indicator (69)

Lights when the Sleep function has been set.

⑨ Bi AMP indicator (23, 25)

Lights when the “Speakers Type(FrontA)” or “Speakers Type(FrontB)” setting is set to “Bi-Amp”.

⑩ BTL indicator (24, 26)

Lights when the “Speakers Type(FrontA)” or “Speakers Type(FrontB)” setting is set to “BTL” for bridged front speaker operation.

⑪ Headphone indicator (70)

Lights when a pair of headphones are plugged into the PHONES jack.

⑫ Message area

Displays various information.

⑬ USB indicator (128)

Lights up when a USB mass storage device is detected.

⑭ Volume level (67)

Displays the volume level.

⑮ MUTING indicator (69)

Flashes while the AV receiver is muted.

⑯ Audio input indicators

Indicate the type of audio input that’s selected as the audio source: HDMI, ANALOG, or DIGITAL.

Rear Panel

(TX-NR5007)

* North American models

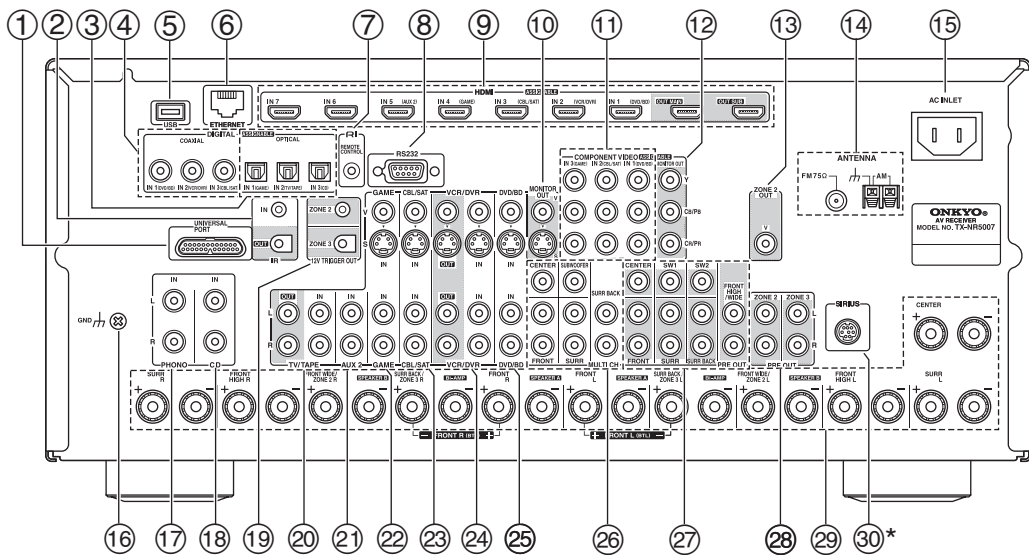

① UNIVERSAL PORT

This port is for connecting the component with the Universal Port option such as UP-A1 Dock.

② IR IN/OUT

A commercially available IR receiver can be connected to the IR IN jack, allowing you to control the AV receiver while you’re in Zone 2/3, or control it when it’s out of sight, for example, installed in a cabinet.

A commercially available IR emitter can be connected to the IR OUT jack to pass IR (infrared) remote control signals through to other components.

③ DIGITAL OPTICAL IN 1 and 2 (TX-NR3007) DIGITAL OPTICAL IN 1, 2, and 3 (TX-NR5007)

These optical digital audio inputs are for connecting components with optical digital audio outputs, such as CD and DVD/BD players. They’re assignable, which means you can assign each one to an input selector to suit your setup. See “Digital Audio Input Setup” on page 56.

④ DIGITAL COAXIAL IN 1, 2, and 3

These coaxial digital audio inputs are for connecting components with coaxial digital audio outputs, such as CD and DVD/BD players. They're assignable, which means you can assign each one to an input selector to suit your setup. See "Digital Audio Input Setup" on page 56.

⑤ USB port (TX-NR5007)

A USB mass storage device, such as a USB flash drive or MP3 player, containing music files can be plugged in here and the music selected can be played through the AV receiver.

⑥ ETHERNET

This port is for connecting the AV receiver to your Ethernet network (e.g., router or switch) for playing music files on a networked computer or media server, or for listening to Internet radio.

⑦ RI REMOTE CONTROL

This **RI** (Remote Interactive) jack can be connected to an **RI** jack on another Onkyo AV component. The AV receiver's remote controller can then be used to control that component. To use **RI**, you must make an analog audio connection (RCA) between the AV receiver and the other AV component, even if they are connected digitally.

⑧ RS232

Terminal for control.

⑨ HDMI IN 1–6, OUT MAIN, and OUT SUB (TX-NR3007)

HDMI IN 1–7, OUT MAIN, and OUT SUB (TX-NR5007)

HDMI (High Definition Multimedia Interface) connections carry digital audio and digital video.

The HDMI inputs are for connecting components with an HDMI output, such as a DVD player, Blu-ray Disc Player, DVD recorder, or DVR (digital video recorder). They're assignable, which means you can assign each one to an input selector to suit your setup. See "HDMI Input Setup" on page 54. The HDMI outputs are for connecting a TV or projector with an HDMI input.

⑩ MONITOR OUT

These S-Video and composite video jacks should be connected to a video input on your TV or projector.

⑪ COMPONENT VIDEO IN 1, 2 and 3

These RCA component video inputs are for connecting components with a component video output, such as a DVD player, DVD recorder, or DVR (digital video recorder). They're assignable, which means you can assign each one to an input selector to suit your setup. See "Component Video Input Setup" on page 55.

⑫ COMPONENT VIDEO MONITOR OUT

These RCA component video outputs are for connecting a TV or projector with a component video input.

⑬ ZONE 2 OUT

This composite video output can be connected to a video input on a TV in Zone 2.

⑭ FM ANTENNA

This jack is for connecting an FM antenna.

AM ANTENNA

These push terminals are for connecting an AM antenna.

⑮ AC INLET

The supplied power cord is connected here. The other end of the power cord should be connected to a suitable wall outlet.

⑯ GND screw

This screw is for connecting a turntable's ground wire.

⑰ PHONO IN

These analog audio inputs are for connecting a turntable.

⑱ CD IN

These analog audio inputs are for connecting a CD player's analog audio output.

⑲ 12V TRIGGER OUT ZONE 2

This output can be connected to the 12-volt trigger input on a component in Zone 2. When Zone 2 is turned on, a 12-volt trigger signal is output.

12V TRIGGER OUT ZONE 3

This output can be connected to the 12-volt trigger input on a component in Zone 3. When Zone 3 is turned on, a 12-volt trigger signal is output.

⑳ TV/TAPE IN/OUT

These analog audio inputs and outputs are for connecting a TV or recorder with an analog audio input and output (cassette, Mini Disc, etc.).

㉑ AUX 2 IN

This analog audio input is for connecting an analog audio output, such as an audio device, etc.

㉒ GAME IN

Here you can connect a game console, etc. Input jacks include S-Video, composite video, and analog audio.

㉓ CBL/SAT IN

Here you can connect a cable/satellite receiver, set-top box, etc. Input jacks include S-Video, composite video, and analog audio.

㉔ VCR/DVR IN/OUT

Here you can connect a VCR or DVR (digital video recorder). Input and output jacks include S-Video, composite video, and analog audio.

25 DVD/BD IN

Here you can connect a DVD/BD player. Input jacks include S-Video, composite video, and analog audio. You can connect a DVD/BD player's 2-channel analog audio output.

26 MULTI CH input: FRONT L/R, CENTER, SUBWOOFER, SURR L/R, and SURR BACK L/R

This analog multichannel input is for connecting a component with a 5.1/7.1-channel analog audio output, such as a DVD player, DVD-Audio or Super Audio CD-capable player, or an MPEG decoder.

27 PRE OUT: FRONT L/R, CENTER, SURR L/R, SURR BACK L/R, and FRONT HIGH/WIDE L/R

These multichannel analog audio outputs can be connected to the analog audio input on a multichannel power amplifier for when you want to use the AV receiver solely as a preamplifier.

PRE OUT: SW1, SW2

These analog audio outputs can be connected to a powered subwoofer. You can connect the powered subwoofer with each jacks respectively. Level and distance can be set individually for each output.

28 PRE OUT: ZONE 2, ZONE 3 L/R

These analog audio outputs can be connected to the line inputs on amplifiers in Zone 2 and Zone 3.

29 FRONT L/R, CENTER, SURR L/R, SURR BACK/ZONE 3 L/R, FRONT HIGH L/R, and FRONT WIDE/ZONE 2 L/R

These terminal posts are for connecting the front L/R, center, surround L/R, surround back/zone 3 L/R, front high L/R, and front wide/zone 2 L/R speakers.

The FRONT L/R and SURR BACK/ZONE 3 L/R terminal posts can be used with front speakers A and surround back speakers respectively, or used to bi-amp or bridge the front speakers A. See “Bi-amping the Front Speakers A” on page 23 and “Bridging the Front Speakers A” on page 24.

The FRONT WIDE/ZONE 2 L/R and SURR BACK/ZONE 3 L/R terminal posts can be used with front speakers B and surround back speakers respectively, or used to biamp or bridge the front speakers B. See “Bi-amping the Front Speakers B” on page 25 and “Bridging the Front Speakers B” on page 26.

The FRONT WIDE/ZONE 2 L/R terminals can be used with front wide speakers respectively, or used to connect the speakers in Zone 2.

See “Connecting Zone 2” on page 131.

The SURR BACK/ZONE 3 L/R terminals can be used with surround speakers respectively, or used to connect the speakers in Zone 3.

See “Connecting Zone 3” on page 133.

30 SIRIUS antenna (North American models)

This jack is for connecting a SIRIUS Satellite Radio antenna, sold separately (see the separate SIRIUS instructions).

See pages 18 to 47 for connection information.

Remote Controller

Installing the Batteries

- 1 To open the battery compartment, press the small lever and remove the cover.

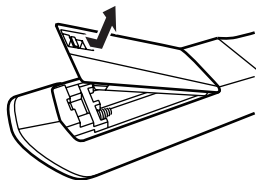

- 2 Insert the two supplied batteries (AA/R6) in accordance with the polarity diagram inside the battery compartment.

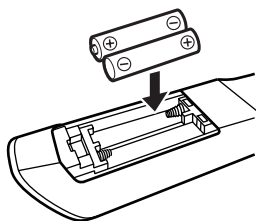

- 3 Replace the cover and push it shut.

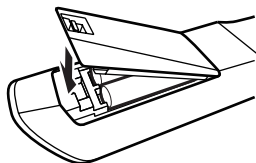

Notes:

- If the remote controller doesn't work reliably, try replacing the batteries.
- Don't mix new and old batteries or different types of batteries.
- If you intend not to use the remote controller for a long time, remove the batteries to prevent damage from leakage or corrosion.
- Expired batteries should be removed as soon as possible to prevent damage from leakage or corrosion.

Aiming the Remote Controller

To use the remote controller, point it at the AV receiver's remote control sensor, as shown below.

Transmission

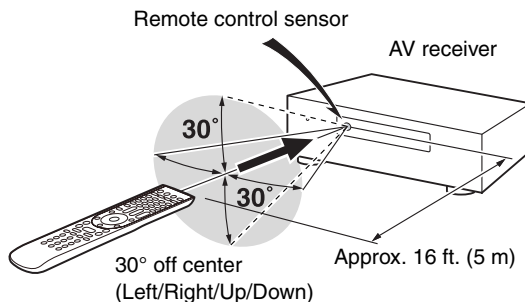

Received

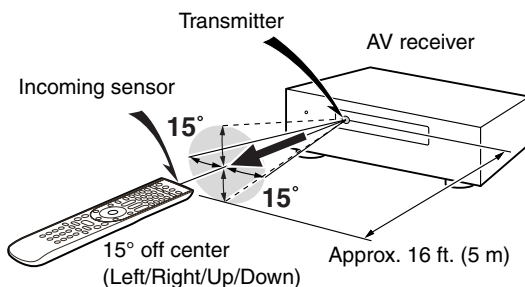

Notes:

- The remote controller may not work reliably if the AV receiver is subjected to bright light, such as direct sunlight or inverter-type fluorescent lights. Keep this in mind when installing.
- If another remote controller of the same type is used in the same room, or the AV receiver is installed close to equipment that uses infrared rays, the remote controller may not work reliably.
- Don't put anything, such as a book, on the remote controller, because the buttons may be pressed inadvertently, thereby draining the batteries.
- The remote controller may not work reliably if the AV receiver is installed in a rack behind colored glass doors. Keep this in mind when installing.
- The remote controller will not work if there's an obstacle between it and the AV receiver's remote control sensor.
- When the remote control codes have been registered and you want to operate another component (page 141), or when you want to operate an Onkyo component without **RI** connection, point the remote controller at the other component to use it.
- When you want to operate an Onkyo component with **RI** connection or an **RIHD**-compatible component connected via HDMI (pages 143 and 144), point the remote controller at the AV receiver's remote control sensor.

Controlling the AV Receiver

To control the AV receiver, press the **[RECEIVER]** button to select Receiver mode.

You can also use the remote controller to control your DVD/BD player, CD player, and other components. See page 141 for more details.

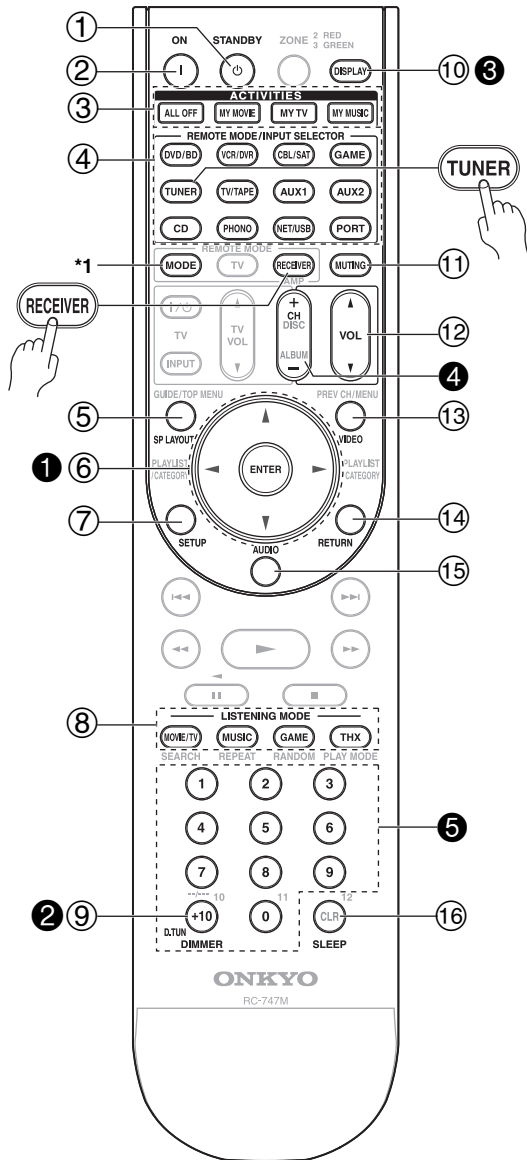

For detailed information, see the pages in parentheses.

- ① **STANDBY button (48)**
Sets the AV receiver to Standby.
- ② **ON button (48)**
Turns on the AV receiver.
- ③ **ACTIVITIES buttons (71, 153)**
Used with the MACRO function.
- ④ **REMOTE MODE/INPUT SELECTOR buttons (67, 143 to 149)**
Selects the remote controller modes and the input sources.
- ⑤ **SP LAYOUT button (70)**
This button is used to change the speaker selection: Front High speakers or Front Wide speakers^{*2}. Speakers A or Speakers B.
- ^{*2} If you use surround back speakers, you can select the combination of surround back and front high, or surround back and front wide speakers.
- ⑥ **Arrow [▲]/[▼]/[◀]/[▶] and ENTER buttons**
Used to select and adjust settings.
- ⑦ **SETUP button**
Used to change settings.
- ⑧ **LISTENING MODE buttons (81)**
Used to select the listening modes.
- ⑨ **DIMMER button (69)**
Adjusts the display brightness.
- ⑩ **DISPLAY button (68)**
Displays information about the current input source.
- ⑪ **MUTING button (69)**
Mutes or unmutes the AV receiver.
- ⑫ **VOL [▲]/[▼] button (67)**
Adjusts the volume of the AV receiver regardless of the currently selected remote controller mode.
- ⑬ **VIDEO button (49, 53, 105)**
Used to change video settings.
- ⑭ **RETURN button**
Returns to the previous display when changing settings.
- ⑮ **AUDIO button (117)**
Used to change audio settings.
When the “Audio TV Out” setting is set to “On” (page 113), this button is disabled.
- ⑯ **SLEEP button (69)**
Used with the Sleep function.

^{*1} When you want to change the remote controller mode without changing the current input source, press the [MODE] button and within about eight seconds, press the REMOTE MODE button. Then, with the AV receiver’s remote controller, you can control the component corresponding to the button you pressed.

■ Controlling the tuner

To control the AV receiver's tuner, press the [TUNER] (or [RECEIVER]) button.

You can select AM or FM by pressing the [TUNER] button repeatedly.

① Arrow [▲]/[▼] buttons

Used to tune into radio stations.

② D.TUN button (73)

(TUNER remote mode only)

Selects the Direct tuning mode.

③ DISPLAY button

Displays information about the band, frequency, preset number, and so on.

④ CH +/- button (74)

Used to select radio presets.

⑤ Number buttons (73, 74)

Used to select radio stations directly in the Direct tuning mode. Also you can select a preset directly.

Note:

An Onkyo cassette recorder connected via **RI** can also be controlled in Receiver mode (see page 149).

About Home Theater

Enjoying Home Theater

Thanks to the AV receiver's superb capabilities, you can enjoy surround sound with a real sense of movement in your own home—just like being in a movie theater or concert hall. With DVDs you can enjoy DTS and Dolby Digital. With analog or digital TV, you can enjoy Dolby Pro Logic IIx, DTS Neo:6, or Onkyo's original DSP listening modes. You can also enjoy THX Surround EX (THX-certified THX speaker system recommended).

Front left and right speakers

These output the overall sound. Their role in a home theater is to provide a solid anchor for the sound image. They should be positioned facing the listener at about ear level, and equidistant from the TV. Angle them inward so as to create a triangle, with the listener at the apex.

Front high left and right speakers

These speakers are necessary to enjoy Dolby Pro Logic IIz Height, and Audyssey Dynamic Surround Expansion™. They significantly enhance the spatial experience. Position them at least 3.3 feet (100 cm) above the front left and right speakers (preferably as high as possible) and at an angle slightly wider than the front left and right speakers.

Front wide left and right speakers

These speakers are necessary to enjoy Audyssey Dynamic Surround Expansion™ (DSX). They significantly enhance the spatial experience. Position them well outside of the front left and right speakers. See also <http://www.audyssey.com/technology/dsx.html> about optimum speaker placement for Audyssey Dynamic Surround Expansion™.

Center speaker

This speaker enhances the front left and right speakers, making sound movements distinct and providing a full sound image. In movies it's used mainly for dialog. Position it close to your TV facing forward at about ear level, or at the same height as the front left and right speakers.

Subwoofer

The subwoofer handles the bass sounds of the LFE (Low-Frequency Effects) channel. The volume and quality of the bass output from your subwoofer will depend on its position, the shape of your listening room, and your listening position. In general, a good bass sound can be obtained by installing the subwoofer in a front corner, or at one-third the width of the wall, as shown.

Tip: To find the best position for your subwoofer, while playing a movie or some music with good bass, experiment by placing your subwoofer at various positions within the room, and choose the one that provides the most satisfying results.

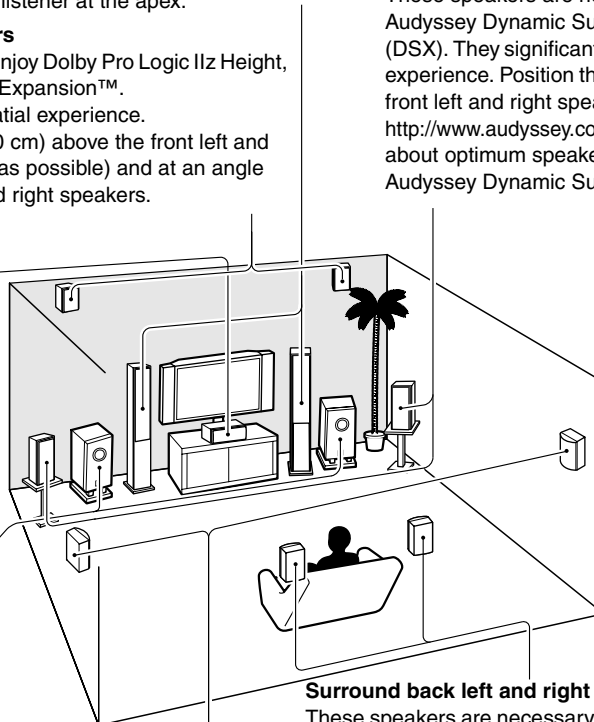

Surround back left and right speakers

These speakers are necessary to enjoy Dolby Digital EX, DTS-ES Matrix, DTS-ES Discrete, THX Surround EX, etc. They enhance the realism of surround sound and improve sound localization behind the listener. Position them behind the listener about 2 to 3 feet (60 to 100 cm) above ear level.

Surround left and right speakers

These speakers are used for precise sound positioning and to add realistic ambience. Position them at the sides of the listener, or slightly behind, about 2 to 3 feet (60 to 100 cm) above ear level. Ideally they should be equidistant from the listener.

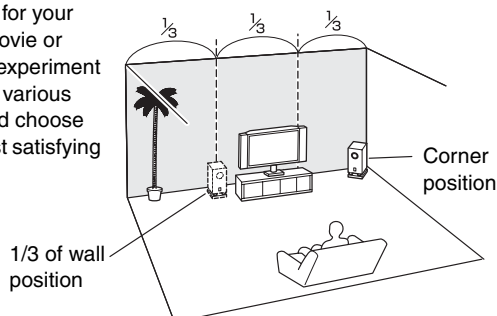

Connecting the AV receiver

Connecting Your Speakers

About Speakers A and Speakers B

Speakers A and Speakers B allows you to have two speaker configurations of up to 7.2 speakers. Each configuration has its own pair of stereo front speakers and can use the same subwoofer, center, surround, and surround back speakers, as required. You could, for example, use Speakers A when watching a DVD movie with 7.2-channels surround sound and use Speakers B for serious music listening with a pair of stereo speakers (2-channels).

The speakers are configured by using the “Speaker Settings” on page 57 and “Speaker Setup” on page 95.

Front Speakers A and front Speakers B can be wired normally, bi-amped, or bridged, but A and B cannot be bi-amped or bridged at the same time. For example, if front Speakers A are bridged, front Speakers B can only be wired normally. Similarly, if front Speakers B are bi-amped, Speakers A can only be wired normally. When bridging or bi-amping is used, the AV receiver can drive up to 5.2 speakers in the main room. See pages 22 to 26 for more information.

The Speakers A and Speakers B configurations are selected by using the [SP LAYOUT] button on the remote controller. Only one configuration can be selected at a time.

The versatility offered by the Speakers A and Speakers B configurations means you can configure the AV receiver to suit your exact requirements and application. Two typical applications are shown below.

■ 7.2-channel Playback with Speakers A and Stereo Playback with Speakers B

In this example, Speakers A provides 7.2-channel surround sound for enjoying DVD movies, while Speakers B is used for serious music listening with a pair of top-quality stereo speakers.

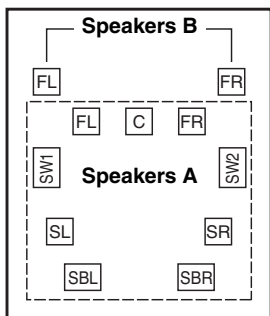

2-1. Speaker Settings	
Speaker Impedance	6ohms
Speakers Type(FrontA)	Normal
Speakers Type(FrontB)	Normal ←→
Powered Zone2	Not Act
Powered Zone3	Not Act

2-2. Speaker Configuration		
Subwoofer	Use	Speaker A
Front	Use	
Center	Use	
Surround	Use	
Surr Back	Use	

2-2. Speaker Configuration		
Subwoofer	Not Use	Speaker B
Front	Use	
Center	Not Use	
Surround	Not Use	
Surr Back	Not Use	

■ 5.2-channel Playback with Bridged Front Speakers

In this example, Speakers A provides 5.2-channel surround sound for enjoying DVD movies, while Speakers B is bridged for use with a pair of high-power stereo speakers, the subwoofer is used with Speakers A and B.

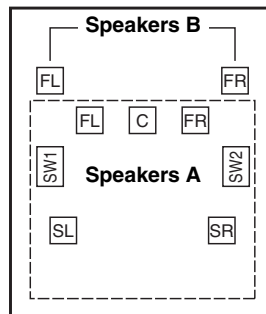

Subwoofer used with A and B

2-1. Speaker Settings	
Speaker Impedance	8ohms
Speakers Type(FrontA)	Normal
Speakers Type(FrontB)	BTL ←→
Powered Zone2	Not Act
Powered Zone3	Not Act

2-2. Speaker Configuration		
Subwoofer	Use	Speaker A
Front	Use	
Center	Use	
Surround	Use	
Surr Back	Not Use	

2-2. Speaker Configuration		
Subwoofer	Use	Speaker B
Front	Use	
Center	Not Use	
Surround	Not Use	
Surr Back	Not Use	

Connecting the AV receiver—Continued

Speaker Configuration

For 9.2-channel surround-sound playback, you need nine speakers and two powered subwoofers.

The following table indicates the channels you should use depending on the number of speakers that you have.

Number of speakers:	2	3	4	5	6	7	7	7	8	8	9	9	9	10	11
Front left	✓	✓	✓	✓	✓	✓	✓	✓	✓	✓	✓	✓	✓	✓	✓
Front right	✓	✓	✓	✓	✓	✓	✓	✓	✓	✓	✓	✓	✓	✓	✓
Center		✓		✓	✓	✓	✓	✓	✓	✓	✓	✓	✓	✓	✓
Surround left			✓	✓	✓	✓	✓	✓	✓	✓	✓	✓	✓	✓	✓
Surround right			✓	✓	✓	✓	✓	✓	✓	✓	✓	✓	✓	✓	✓
Surround back*					✓				✓	✓				✓	
Surround back left						✓					✓	✓			✓
Surround back right						✓					✓	✓			✓
Front high left							✓		✓		✓		✓	✓	✓
Front high right							✓		✓		✓		✓	✓	✓
Front wide left								✓		✓		✓	✓	✓	✓
Front wide right								✓		✓		✓	✓	✓	✓

* If you're using only one surround back speaker, connect it to the SURR BACK/ZONE 3 L terminal.

No matter how many speakers you use, two powered subwoofers are recommended for a really powerful and solid bass.

To get the best from your surround sound system, you need to set the speaker settings. You can do this automatically (see page 61) or manually (see page 95).

Note:

Front high and front wide speakers produce no sound at the same time.

Attaching the Speaker Labels

The AV receiver's positive (+) speaker terminals are all red (the negative (-) speaker terminals are all black).

Speaker	Color
Front left	White
Front right	Red
Center	Green
Surround left	Blue
Surround right	Gray
Surround back left, Zone 3 left	Brown
Surround back right, Zone 3 right	Tan
Front high left	White
Front high right	Red
Front wide left, Zone 2 left	White
Front wide right, Zone 2 right	Red

The supplied speaker cable labels are also color-coded and you should attach them to the positive (+) side of each speaker cable in accordance with the above table. Then all you need to do is to match the color of each label to the corresponding speaker terminal.



(North American models)

- If you are using banana plugs, tighten the speaker terminal before inserting the banana plug.
- Do not insert the speaker code directly into the center hole of the speaker terminal.

Connecting Powered Subwoofers

Using a suitable cable, connect the AV receiver's PRE OUT: SW1, SW2 to an input on your powered subwoofer, as shown. If your subwoofer is unpowered and you're using an external amplifier, connect the PRE OUT: SW1, SW2 to an input on the amp.

You can connect the powered subwoofer with each jacks respectively. Level and distance can be set individually for each output. If you use one subwoofer, connect it to PRE OUT: SW1.

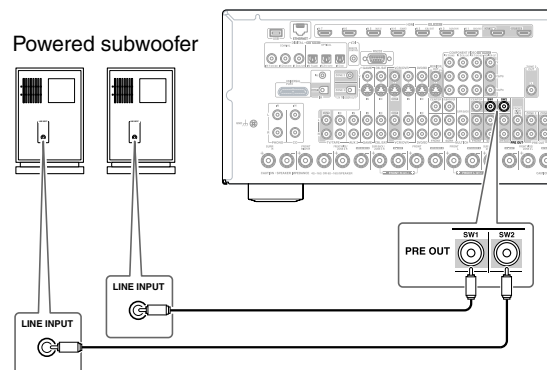

Using Dipole Speakers

You can use dipole speakers for the surround left and right, surround back left and right speakers. Dipole speakers output the same sound in two directions. Dipole speakers typically have an arrow printed on them to indicate how they should be positioned. The surround left and right dipole speakers should be positioned so that their arrows point toward the TV/screen, while the surround back left and right and front high left and right and front wide left and right dipole speakers should be positioned so that their arrows point toward each other, as shown.

Dipole speakers

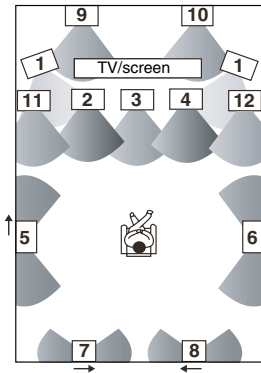

Normal speakers

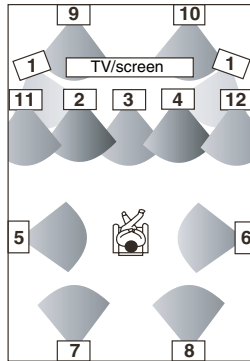

- | | |
|---|---|
| <ol style="list-style-type: none"> 1. Subwoofers 2. Front left speaker 3. Center speaker 4. Front right speaker 5. Surround left speaker 6. Surround right speaker 7. Surround back left speaker | <ol style="list-style-type: none"> 8. Surround back right speaker 9. Front high left speaker 10. Front high right speaker 11. Front wide left speaker 12. Front wide right speaker |
|---|---|

Speaker Connection Precautions

Read the following before connecting your speakers:

- You can connect speakers with an impedance of between 4 and 16 ohms. If the impedance of any of the connected speakers is 4 ohms or more, but less than 6 ohms, be sure to set the minimum speaker impedance to “4ohms” (see page 57). If you use speakers with a lower impedance, and use the amplifier at high volume levels for a long period of time, the built-in protection circuit may be activated.
- Disconnect the power cord from the wall outlet before making any connections.
- Read the instructions supplied with your speakers.
- Pay close attention to speaker wiring polarity. In other words, connect positive (+) terminals only to positive (+) terminals, and negative (–) terminals only to negative (–) terminals. If you get them the wrong way around, the sound will be out of phase and will sound unnatural.
- Unnecessarily long, or very thin speaker cables may affect the sound quality and should be avoided.
- If you use 4 or 5 speakers, connect each of the two surround speakers to the SURR L/R terminals. Do not connect them to the SURR BACK/ZONE 3 L/R, FRONT WIDE/ZONE 2 L/R, or FRONT HIGH L/R terminals.
- Be careful not to short the positive and negative wires. Doing so may damage the AV receiver.
- Make sure the metal core of the wire does not have contact with the AV receiver’s rear panel. Doing so may damage the AV receiver.
- Don’t connect more than one cable to each speaker terminal. Doing so may damage the AV receiver.
- Don’t connect one speaker to several terminals.

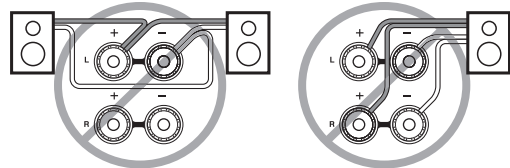
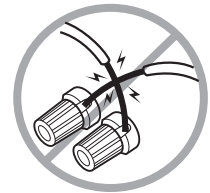

Connecting the AV receiver—Continued

Connecting the Speaker Cables

1 Strip 1/2" to 5/8" (12 to 15 mm) of insulation from the ends of the speaker cables, and twist the bare wires tightly, as shown.

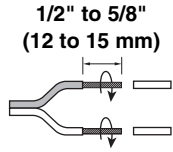

2 Unscrew the terminal.



3 Fully insert the bare wires.



4 Screw the terminal tight.



■ 9.2-channel Playback with Speakers A

The following illustration shows which speaker should be connected to each pair of terminals. If you're using only one surround back speaker, connect it to the SURR BACK/ZONE 3 L terminal.

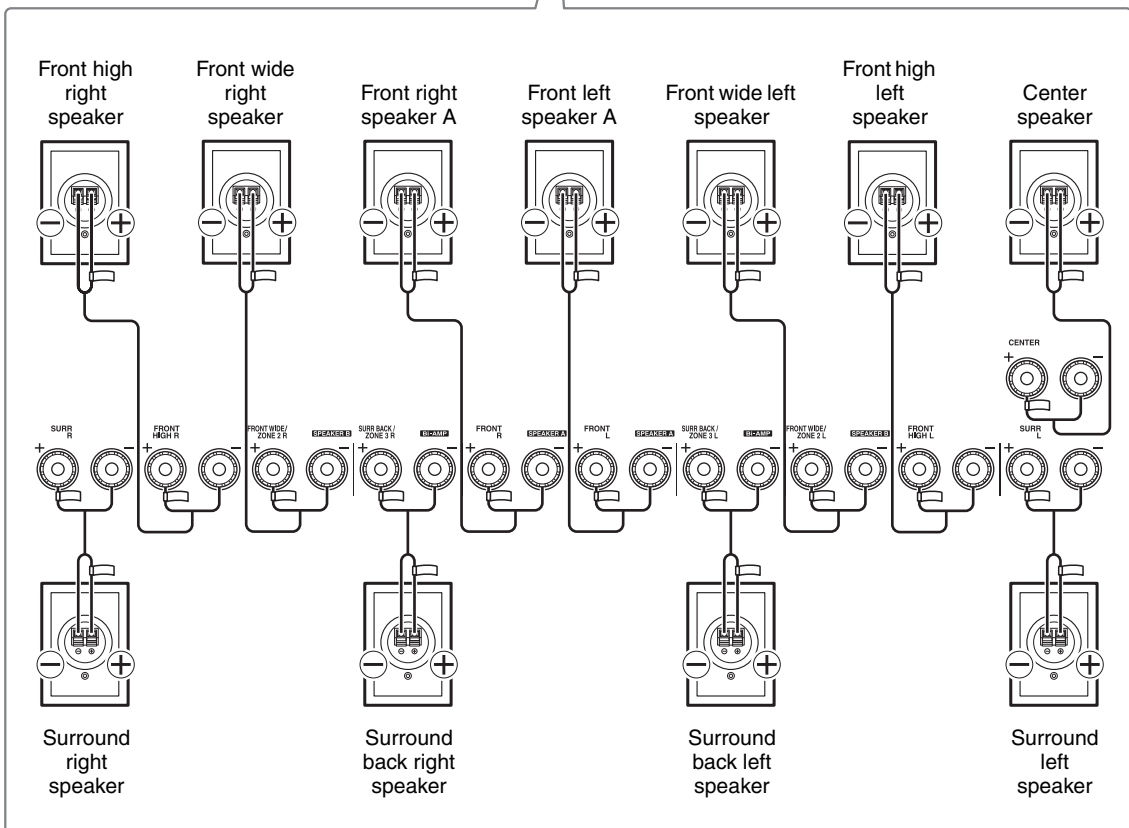
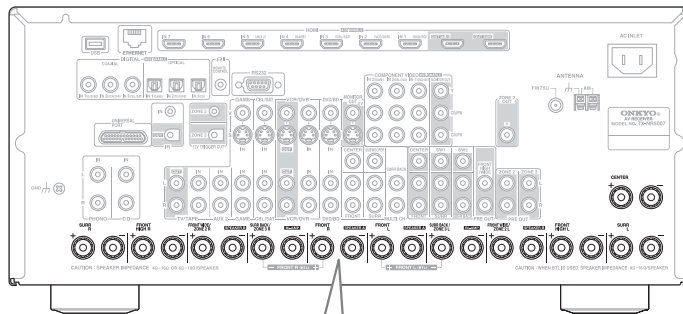

Connecting the AV receiver—Continued

■ 7.2-channel Playback with Speakers A or Speakers B

The following illustration shows which speaker should be connected to each pair of terminals for up to 7.2-channel playback with Speakers A or Speakers B. If you're using only one surround back speaker, connect it to the SURR BACK/ZONE 3 L terminal.

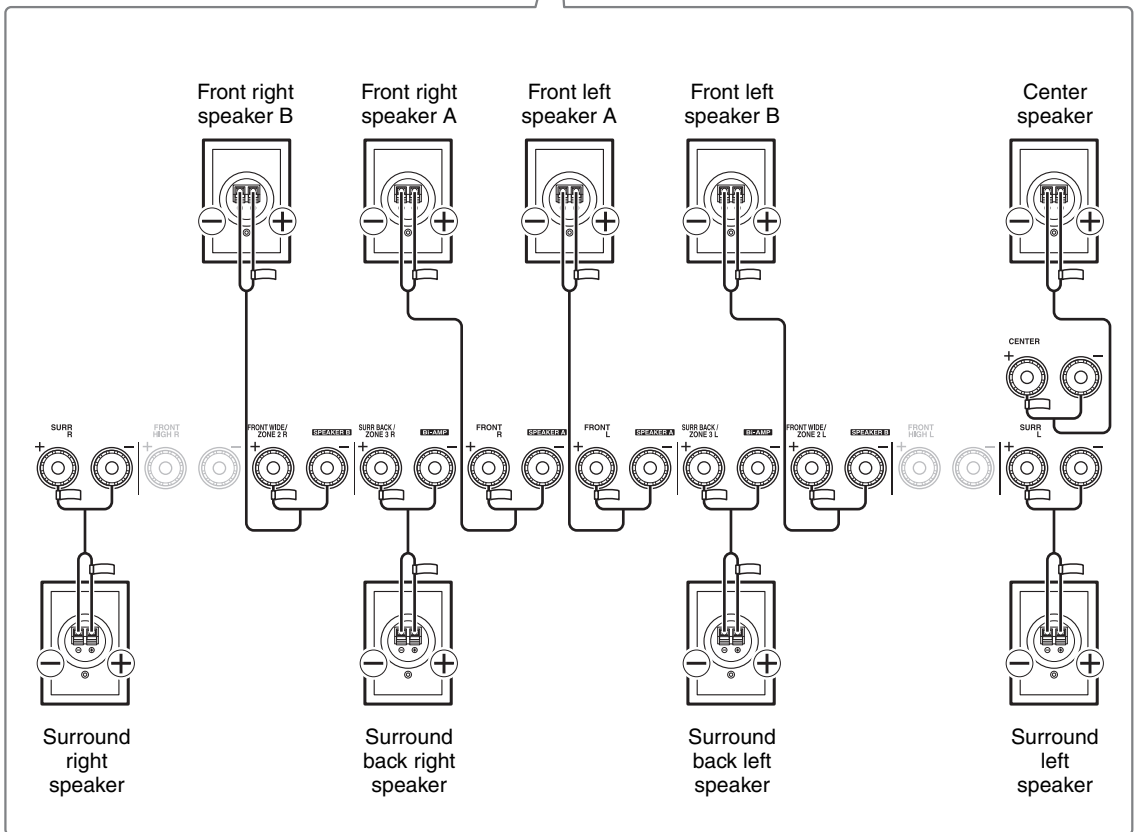
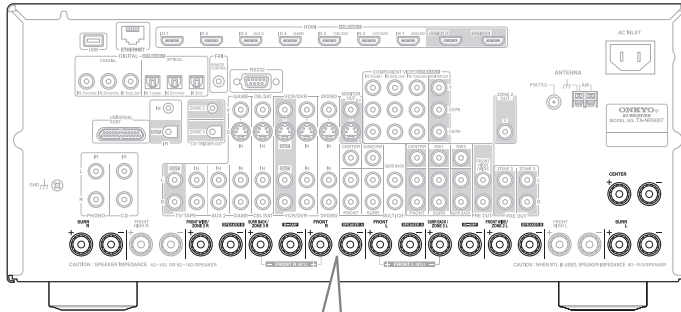

Notes:

- When Speakers A is selected as the main front speakers, connect the front left speaker to FRONT L, front right speaker to FRONT R. When Speakers B is selected as the main front speakers, connect the front left speaker to FRONT WIDE/ZONE 2 L, front right speaker to FRONT WIDE/ZONE 2 R.
- The speakers are configured by using the “Speaker Settings” on page 57 and “Speaker Setup” on page 95.
- You can choose which of the speakers you want to use with the Speakers A or Speakers B configuration (see page 96).
- When you use the Speakers B configuration, front high speakers cannot be used.

Bi-amping the Front Speakers A

The FRONT L/R and SURR BACK/ZONE 3 L/R terminal posts can be used with front speakers and surround back speakers respectively, or bi-amped to provide separate tweeter and woofer feeds for a pair of front speakers A that support bi-amping, providing improved bass and treble performance.

- When bi-amping is used, surround back speakers cannot be used.
- For bi-amping, the FRONT L/R terminal posts connect to the front speakers' woofer terminals. And the SURR BACK/ZONE 3 L/R terminal posts connect to the front speakers' tweeter terminals.
- Once you've completed the bi-amping connections shown below and turned on the AV receiver, you must set the "Speakers Type(FrontA)" setting to "Bi-Amp" to enable biamping (see page 57).
- When front Speakers A are biamped, front Speakers B must be wired normally or not used.

Important:

- **When making the bi-amping connections, be sure to remove the jumper bars that link the Speakers' tweeter (high) and woofer (low) terminals.**
- Bi-amping can only be used with speakers that support bi-amping. Refer to your speaker manual.

Bi-amping Speaker Hookup

- 1 Connect the AV receiver's FRONT R positive (+) terminal to the right speaker's positive (+) Woofer (low) terminal. And connect the AV receiver's FRONT R negative (-) terminal to the right speaker's negative (-) Woofer (low) terminal.
- 2 Connect the AV receiver's SURR BACK/ZONE 3 R positive (+) terminal to the right speaker's positive (+) Tweeter (high) terminal. And connect the AV receiver's SURR BACK/ZONE 3 R negative (-) terminal to the right speaker's negative (-) Tweeter (high) terminal.
- 3 Connect the AV receiver's FRONT L positive (+) terminal to the left speaker's positive (+) Woofer (low) terminal. And connect the AV receiver's FRONT L negative (-) terminal to the left speaker's negative (-) Woofer (low) terminal.
- 4 Connect the AV receiver's SURR BACK/ZONE 3 L positive (+) terminal to the left speaker's positive (+) Tweeter (high) terminal. And connect the AV receiver's SURR BACK/ZONE 3 L negative (-) terminal to the left speaker's negative (-) Tweeter (high) terminal.

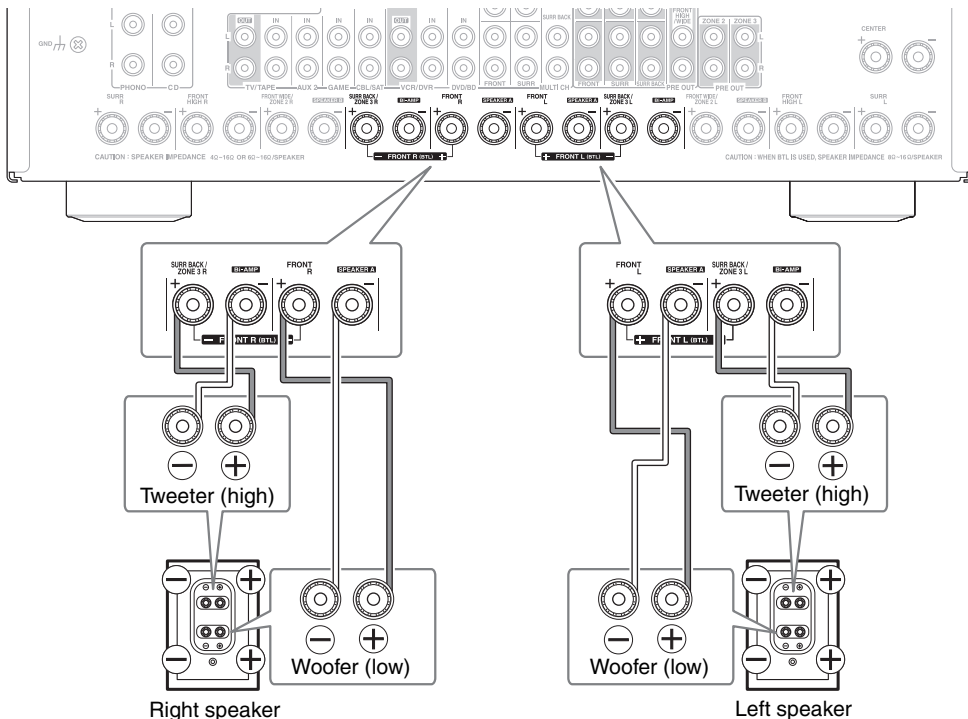

Connecting the AV receiver—Continued

Bridging the Front Speakers A

The FRONT L/R and SURR BACK/ZONE 3 L/R terminal posts can be used with front speakers and surround back speakers respectively, or bridged together to provide almost double the output power for the front speakers A.

- When bridging is used, surround back speakers cannot be used.
- For bridging, the positive (+) FRONT L/R and SURR BACK/ZONE 3 L/R terminal posts are used, but the negative (–) FRONT L/R and SURR BACK/ZONE 3 L/R terminals are not.
- Once you’ve completed the bridging connections shown below and turned on the AV receiver, you must set the “Speakers Type(FrontA)” setting to “BTL” to enable bridging (see page 57).
- When front Speakers A are bridged, front Speakers B must be wired normally or not used.

Notes:

- Use only front speakers with an impedance of 8 ohms or higher for bridging. Failure to do so may seriously damage the AV receiver.
- When using bridging, make sure that your front speakers can handle the additional power.

Bridged Speaker Hookup

- 1 Connect the AV receiver’s FRONT R positive (+) terminal to the right speaker’s positive (+) terminal. And connect the AV receiver’s SURR BACK/ZONE 3 R positive (+) terminal to the right speaker’s negative (–) terminal.
- 2 Connect the AV receiver’s FRONT L positive (+) terminal to the left speaker’s positive (+) terminal. And connect the AV receiver’s SURR BACK/ZONE 3 L positive (+) terminal to the left speaker’s negative (–) terminal.

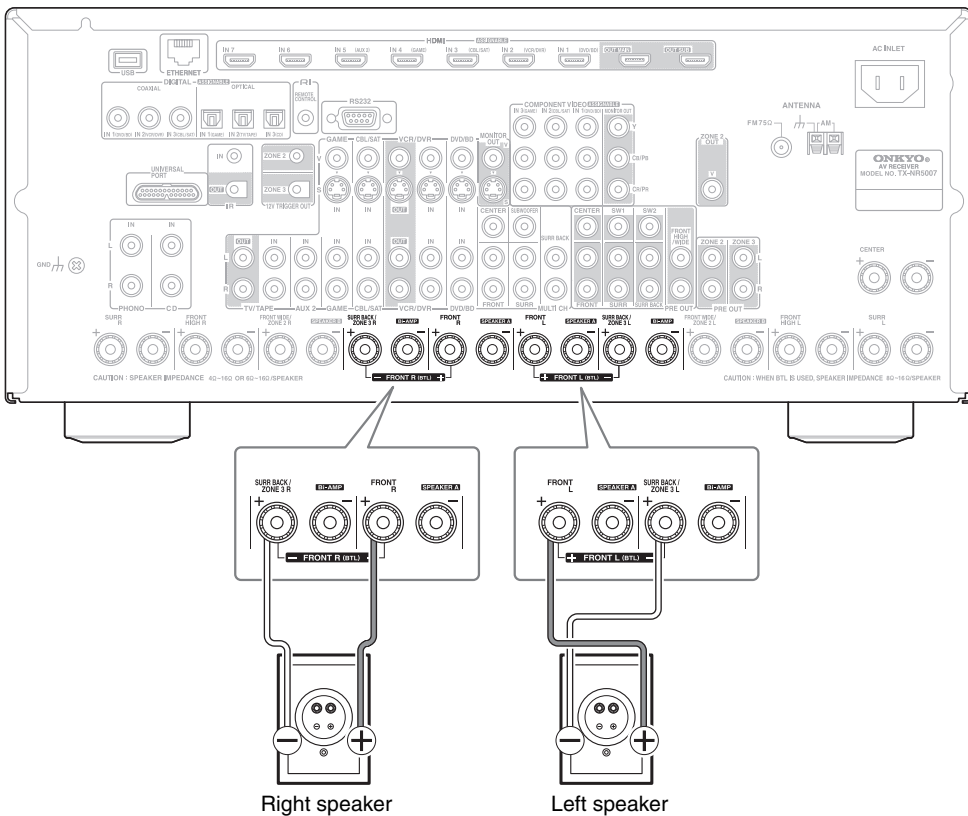

Bi-amping the Front Speakers B

The FRONT WIDE/ZONE 2 L/R and SURR BACK/ZONE 3 L/R terminal posts can be used with front wide speakers and surround back speakers respectively, or bi-amped to provide separate tweeter and woofer feeds for a pair of front speakers B that support bi-amping, providing improved bass and treble performance.

- When bi-amping is used, surround back speakers cannot be used.
- For bi-amping, the FRONT WIDE/ZONE 2 L/R terminal posts connect to the front speakers' woofer terminals. And the SURR BACK/ZONE 3 L/R terminal posts connect to the front speakers' tweeter terminals.
- Once you've completed the bi-amping connections shown below and turned on the AV receiver, you must set the "Speakers Type(FrontB)" setting to "Bi-Amp" to enable biamping (see page 57).
- When front Speakers B are biamped, front Speakers A must be wired normally.

Important:

- **When making the bi-amping connections, be sure to remove the jumper bars that link the Speaker's tweeter (high) and woofer (low) terminals.**
- Bi-amping can only be used with speakers that support bi-amping. Refer to your speaker manual.

Bi-amping Speaker Hookup

- 1 Connect the AV receiver's FRONT WIDE/ZONE 2 R positive (+) terminal to the right speaker's positive (+) Woofer (low) terminal. And connect the AV receiver's FRONT WIDE/ZONE 2 R negative (-) terminal to the right speaker's negative (-) Woofer (low) terminal.
- 2 Connect the AV receiver's SURR BACK/ZONE 3 R positive (+) terminal to the right speaker's positive (+) Tweeter (high) terminal. And connect the AV receiver's SURR BACK/ZONE 3 R negative (-) terminal to the right speaker's negative (-) Tweeter (high) terminal.
- 3 Connect the AV receiver's FRONT WIDE/ZONE 2 L positive (+) terminal to the left speaker's positive (+) Woofer (low) terminal. And connect the AV receiver's FRONT WIDE/ZONE 2 L negative (-) terminal to the left speaker's negative (-) Woofer (low) terminal.
- 4 Connect the AV receiver's SURR BACK/ZONE 3 L positive (+) terminal to the left speaker's positive (+) Tweeter (high) terminal. And connect the AV receiver's SURR BACK/ZONE 3 L negative (-) terminal to the left speaker's negative (-) Tweeter (high) terminal.

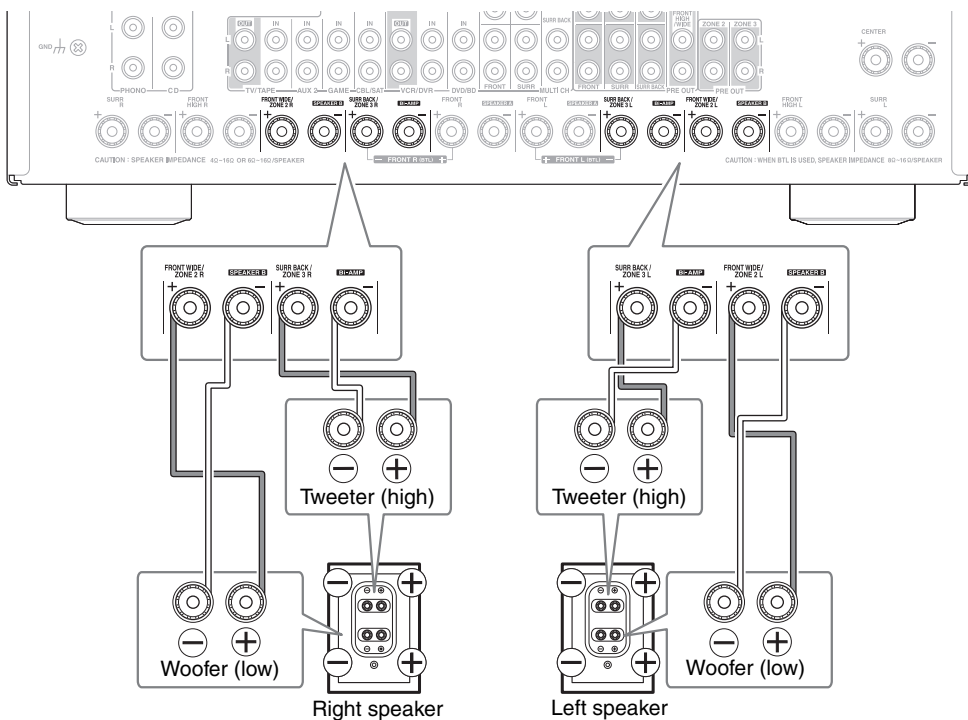

Connecting the AV receiver—Continued

Bridging the Front Speakers B

The FRONT WIDE/ZONE 2 L/R and SURR BACK/ZONE 3 L/R terminal posts can be used with front wide speakers and surround back speakers respectively, or bridged together to provide almost double the output power for the front speakers B.

- When bridging is used, surround back speakers cannot be used.
- For bridging, the positive (+) FRONT WIDE/ZONE 2 L/R and SURR BACK/ZONE 3 L/R terminal posts are used, but the negative (–) FRONT WIDE/ZONE 2 L/R and SURR BACK/ZONE 3 L/R terminals are not.
- Once you’ve completed the bridging connections shown below and turned on the AV receiver, you must set the “Speakers Type(FrontB)” setting to “BTL” to enable bridging (see page 57).
- When front Speakers B are bridged, front Speakers A must be wired normally.

Notes:

- Use only front speakers with an impedance of 8 ohms or higher for bridging. Failure to do so may seriously damage the AV receiver.
- When using bridging, make sure that your front speakers can handle the additional power.

Bridged Speaker Hookup

- 1 Connect the AV receiver’s FRONT WIDE/ZONE 2 R positive (+) terminal to the right speaker’s positive (+) terminal. And connect the AV receiver’s SURR BACK/ZONE 3 R positive (+) terminal to the right speaker’s negative (–) terminal.
- 2 Connect the AV receiver’s FRONT WIDE/ZONE 2 L positive (+) terminal to the left speaker’s positive (+) terminal. And connect the AV receiver’s SURR BACK/ZONE 3 L positive (+) terminal to the left speaker’s negative (–) terminal.

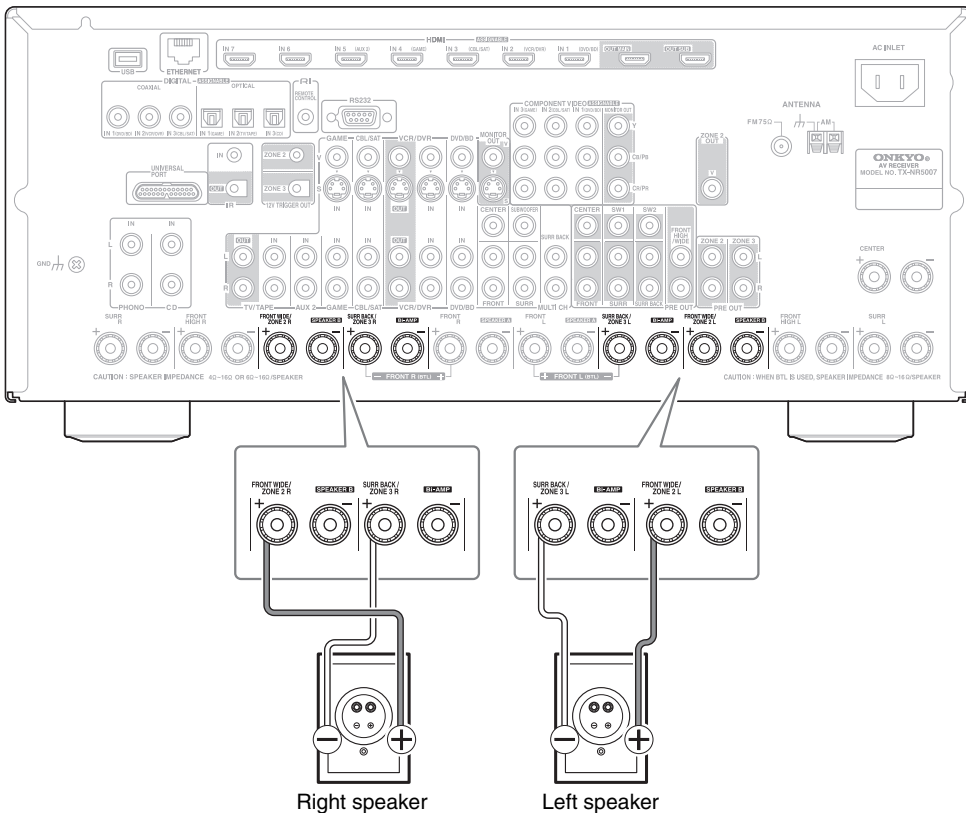

Connecting the AV receiver—Continued

Connecting Antenna

This section explains how to connect the supplied indoor FM antenna and AM loop antenna, and how to connect commercially available outdoor FM and AM antennas. The AV receiver won't pick up any radio signals without any antenna connected, so you must connect the antenna to use the tuner.

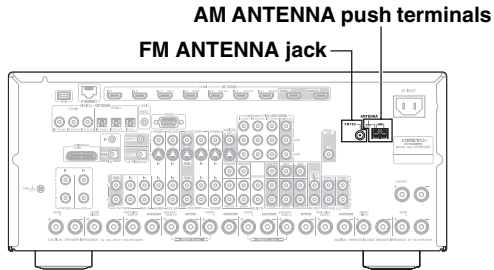

Connecting the Indoor FM Antenna

The supplied indoor FM antenna is for indoor use only.

1 Attach the FM antenna, as shown. (North American models)

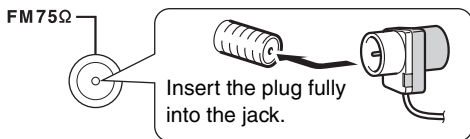

(European and Asian models)

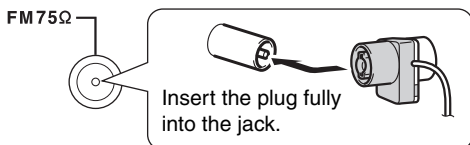

Once your AV receiver is ready for use, you'll need to tune into an FM radio station and adjust the position of the FM antenna to achieve the best possible reception.

2 Use thumbtacks or something similar to fix the FM antenna into position.

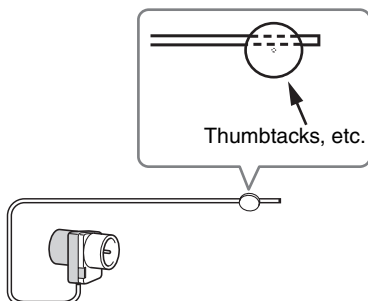

Caution:

Be careful that you don't injure yourself when using thumbtacks.

If you cannot achieve good reception with the supplied indoor FM antenna, try a commercially available outdoor FM antenna instead (see page 28).

Connecting the AM Loop Antenna

The supplied indoor AM loop antenna is for indoor use only.

1 Assemble the AM loop antenna, inserting the tabs into the base, as shown.

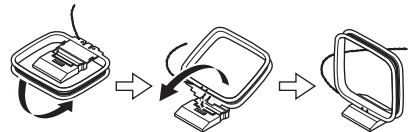

2 Connect both wires of the AM loop antenna to the AM antenna push terminals, as shown.

(The antenna's wires are not polarity sensitive, so they can be connected either way around.)

Make sure that the wires are attached securely and that the push terminals are gripping the bare wires, not the insulation.

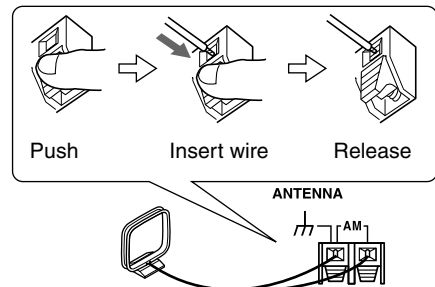

Once your AV receiver is ready for use, you'll need to tune into an AM radio station and adjust the position of the AM antenna to achieve the best possible reception.

Keep the antenna as far away as possible from your AV receiver, TV, speaker cables, and power cords.

If you cannot achieve good reception with the supplied indoor AM loop antenna, try using it with a commercially available outdoor AM antenna (see page 28).

Connecting the AV receiver—Continued

Connecting an Outdoor FM Antenna

If you cannot achieve good reception with the supplied indoor FM antenna, try a commercially available outdoor FM antenna instead.

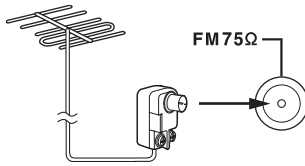

Notes:

- Outdoor FM antennas work best outside, but usable results can sometimes be obtained when installed in an attic or loft.
- For best results, install the outdoor FM antenna well away from tall buildings, preferably with a clear line of sight to your local FM transmitter.
- Outdoor antenna should be located away from possible noise sources, such as neon signs, busy roads, etc.
- For safety reasons, outdoor antenna should be situated well away from power lines and other high-voltage equipment.
- Outdoor antenna must be grounded in accordance with local regulations to prevent electrical shock hazards.

■ Using a TV/FM Antenna Splitter

It's best not to use the same antenna for both FM and TV reception, as this can cause interference problems. If circumstances demand it, use a TV/FM antenna splitter, as shown.

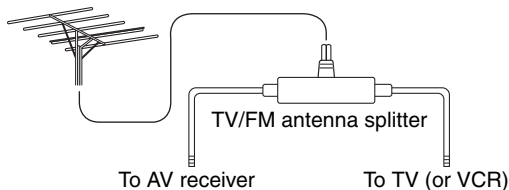

Connecting an Outdoor AM Antenna

If good reception cannot be achieved using the supplied AM loop antenna, an outdoor AM antenna can be used in addition to the loop antenna, as shown.

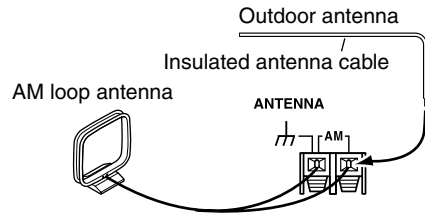

Outdoor AM antennas work best when installed outside horizontally, but good results can sometimes be obtained indoors by mounting horizontally above a window. Note that the outdoor antenna should be right connected. Outdoor antenna must be grounded in accordance with local regulations to prevent electrical shock hazards.

Connecting the AV receiver—Continued

About AV Connections

- Before making any AV connections, read the manuals supplied with your other AV components.
- Don't connect the power cord until you've completed and double-checked all AV connections.

Optical Digital Jacks

The AV receiver's optical digital jacks have shutter-type covers that open when an optical plug is inserted and close when it's removed. Push plugs in all the way.

Caution:

To prevent shutter damage, hold the optical plug straight when inserting and removing.

AV Connection Color Coding

RCA-type AV connections are usually color-coded: red, white, and yellow. Use red plugs to connect right-channel audio inputs and outputs (typically labeled "R"). Use white plugs to connect left-channel audio inputs and outputs (typically labeled "L"). And use yellow plugs to connect composite video inputs and outputs.



- Push plugs in all the way to make good connections (loose connections can cause noise or malfunctions).
- To prevent interference, keep audio and video cables away from power cords and speaker cables.

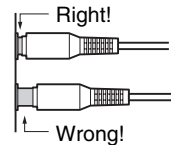

AV Cables & Jacks

Video / Audio

Cable	Jack	Description
		HDMI connections can carry uncompressed standard- or high-definition digital video and audio and offer the best picture and sound quality.

Video

Component video cable			Component video separates the luminance (Y) and color difference signals (PR, PB), providing the best picture quality (some TV manufacturers label their component video sockets slightly differently).
S-Video cable			S-Video separates the luminance and color signals and provides better picture quality than composite video.
Composite video cable			Composite video is commonly used on TVs, VCRs, and other video equipment.

Audio

Optical digital audio cable			Offers the best sound quality and allows you to enjoy surround sound (e.g., Dolby Digital, DTS). The audio quality is the same as for coaxial.
Coaxial digital audio cable			Offers the best sound quality and allows you to enjoy surround sound (e.g., Dolby Digital, DTS). The audio quality is the same as for optical.
Analog audio cable (RCA)			This cable carries analog audio. It's the most common connection format for analog audio, and can be found on virtually all AV components.
Multichannel analog audio cable (RCA)			This cable carries multichannel analog audio and is typically used to connect DVD players with a 7.1-channel analog audio output. Several standard analog audio cables can be used instead of a multichannel cable.

The AV receiver does not support SCART plugs.

Connecting Components with HDMI

About HDMI

Designed to meet the increased demands of digital TV, HDMI (High Definition Multimedia Interface) is a new digital interface standard for connecting TVs, projectors, DVD/BD players, set-top boxes, and other video components. Until now, several separate video and audio cables have been required to connect AV components. With HDMI, a single cable can carry control signals, digital video, and up to eight channels of digital audio (2-channel PCM, multichannel digital audio, and multichannel PCM).

The HDMI video stream (i.e., video signal) is compatible with DVI (Digital Visual Interface)^{*1}, so TVs and displays with a DVI input can be connected by using an HDMI-to-DVI adapter cable. (This may not work with some TVs and displays, resulting in no picture.)

The AV receiver uses HDCP (High-bandwidth Digital Content Protection)^{*2}, so only HDCP-compatible components can display the picture.

The AV receiver's HDMI interface is based on the following standard:

x.v.Color, Deep Color, Lip Sync, DTS-HD Master Audio, DTS-HD High Resolution Audio, Dolby TrueHD, Dolby Digital Plus, DSD, and Multichannel PCM

Supported Audio Formats

- 2-channel linear PCM (32–192 kHz, 16/20/24 bit)
- Multichannel linear PCM (up to 7.1 ch, 32–192 kHz, 16/20/24 bit)
- Bitstream (DSD, Dolby Digital, Dolby Digital Plus, Dolby TrueHD, DTS, DTS Express, DTS-HD High Resolution Audio, DTS-HD Master Audio)

Your DVD/BD players must also support HDMI output of the above audio formats.

■ Onkyo **RIHD** for System Control

RIHD, which stands for Remote Interactive over HDMI, is the name of the system control function found on Onkyo components. The AV receiver can be used with CEC (Consumer Electronics Control), which allows system control over HDMI and is part of the HDMI standard. CEC provides interoperability between various components, however, operation with components other than **RIHD**-compatible components cannot be guaranteed.

- Set “HDMI Control (RIHD)” to “On” (page 114).
- See “Controlling a TV” (page 143) and “Controlling a DVD Player or DVD Recorder” (page 144) for operation.

Notes:

- Do not connect the **RIHD**-compatible component more than the following number to the HDMI input terminal so that the linked operations work properly.
 - a. DVD/BD player is up to three.
 - b. DVD/BD recorder is up to three.
 - c. Cable/Satellite Set-top box is up to four.
- Do not connect the AV receiver to the other AV receiver /AV amplifier via HDMI.
- When the **RIHD**-compatible component more than the above-mentioned is connected, the linked operations are not guaranteed.
- The **RIHD** control does not support HDMI OUT SUB. Use HDMI OUT MAIN instead.

About Copyright Protection

The AV receiver supports HDCP (High-bandwidth Digital Content Protection)^{*2}, a copy-protection system for digital video signals. Other devices connected to the AV receiver via HDMI must also support HDCP.

*1 DVI (Digital Visual Interface): The digital display interface standard set by the DDWG^{*3} in 1999.

*2 HDCP (High-bandwidth Digital Content Protection): The video encryption technology developed by Intel for HDMI/DVI. It's designed to protect video content and requires a HDCP-compatible device to display the encrypted video.

*3 DDWG (Digital Display Working Group): Lead by Intel, Compaq, Fujitsu, Hewlett Packard, IBM, NEC, and Silicon Image, this open industry group's objective is to address the industry's requirements for a digital connectivity specification for high-performance PCs and digital displays.

Connecting the AV receiver—Continued

Making HDMI Connections

Step 1:

Use HDMI cables to connect the AV receiver's HDMI jacks to your HDMI-compatible DVD/BD player, TV, projector, and so on.

Step 2:

Assign each HDMI IN to an input selector in the HDMI Input Setup (see page 54).

■ Video Signals

Digital video signals received by the HDMI IN jacks are normally output by the HDMI MAIN OUT and SUB OUT for display on your TV. Composite video, S-Video, and component video sources can be upconverted for the HDMI output. See "Video Connection Formats" on page 32 for more information.

■ Audio Signals

Digital audio signals received by the HDMI IN jacks are output by the speakers and headphones connected to the AV receiver. Normally, they are not output by the HDMI outputs, unless the "Audio TV Out" setting is set to "On" (see page 113).



To listen to audio received by the HDMI IN jacks through your TV's speakers:

- Set the "TV Control" setting to "On" (see page 114) for an **RHHD**-compatible TV.
- Set the "Audio TV Out" setting to "On" (see page 113) when the TV is not compatible with **RHHD** or the "TV Control" setting to "Off".
- Set your DVD/BD player's HDMI audio output setting to PCM.

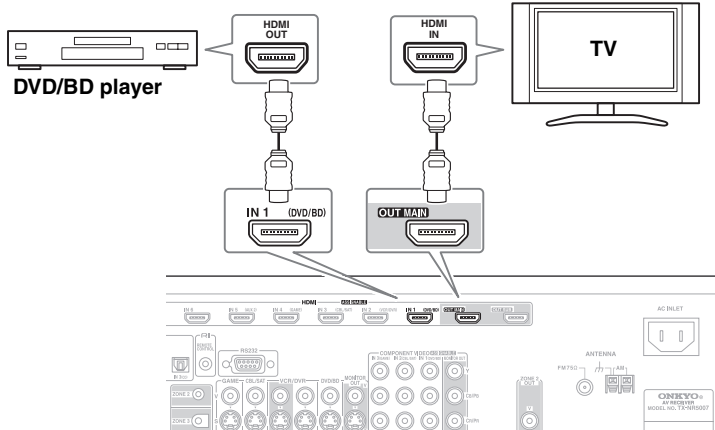
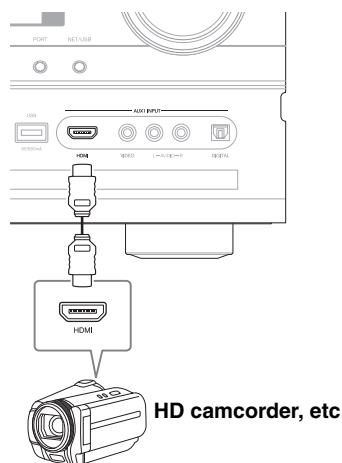

Notes:

- The HDMI video stream is compatible with DVI (Digital Visual Interface), so TVs and displays with a DVI input can be connected by using an HDMI-to-DVI adapter cable. (Note that DVI connections only carry video, so you'll need to make a separate connection for audio.) However, reliable operation with such an adapter is not guaranteed. In addition, video signals from a PC are not guaranteed.
- When listening to an HDMI component through the AV receiver, set the HDMI component so that its video can be seen on the TV screen (on the TV, select the input of the HDMI component connected to the AV receiver). If the TV power is off or the TV is set to another input source, this may result in no sound from the AV receiver or the sound may be cut off.
- When the "Audio TV Out" setting is set to "On" (see page 113) to hear from your TV's speakers, by controlling the AV receiver's volume, the sound will be output from the AV receiver's speakers, too. When the "TV Control" setting is set to "On" to hear from speakers of **RHHD**-compatible TV, by controlling the AV receiver's volume, the AV receiver's speakers will produce sound while the TV's speakers are muted. To stop the AV receiver's speakers producing sound, change the settings, change your TV's settings, or turn down the AV receiver's volume.
- The HDMI audio signal (sampling rate, bit length, etc.) may be restricted by the connected source component. If the picture is poor or there's no sound from a component connected via HDMI, check its setup. Refer to the connected component's instruction manual for details.

Connecting the AV receiver—Continued

Connecting Both Audio & Video

By connecting both the audio and video outputs of your DVD/BD player and other AV components to the AV receiver, you can select both the audio and video simultaneously simply by selecting the appropriate input source on the AV receiver.

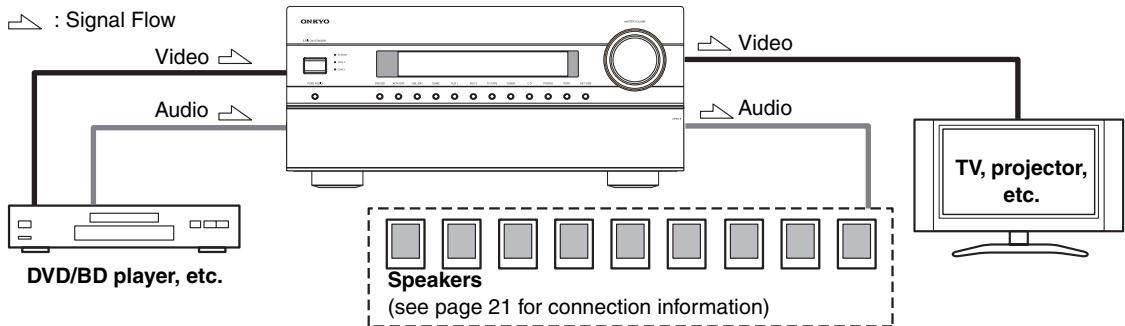

Which Connections Should I Use?

The AV receiver supports several connection formats for compatibility with a wide range of AV equipment. The format you choose will depend on the formats supported by your other components. Use the following sections as a guide.

Video Connection Formats

Video equipment can be connected to the AV receiver by using any one of the following video connection formats: composite video, S-Video, component video, or HDMI, the latter offering the best picture quality.

The AV receiver can upconvert and downconvert between video formats, depending on the “Monitor Out” setting, which generally determines whether video signals are upconverted for the component video output or the HDMI output.

For optimal video performance, THX recommends that video signals pass through the system without upconversion (e.g., component video input through to component video output).

It is also recommended that you press the [VCR/DVR] and [RETURN] buttons on the AV receiver at the same time. Select “Skip” in the “VideoProcessor” setting by pressing the [RETURN] button repeatedly on the display. To reset back to the original setting, press the same button at the same time.

■ “Monitor Out” Setting Set to “HDMI Main” or “HDMI Sub”

With the “Monitor Out” setting set to “HDMI Main” or “HDMI Sub” (see page 52), video input signals flow through the AV receiver as shown, with composite video, S-Video, and component video sources all being upconverted for the HDMI output. **Use the “HDMI Main” or “HDMI Sub” setting if you connect the AV receiver’s HDMI OUT MAIN or HDMI OUT SUB, respectively, to your TV.**

The composite video, S-Video, and component video outputs pass through their respective input signals as they are.

Note:

If not connected to the same output you have selected in the “Monitor Out” setting, the “Monitor Out” setting will be automatically switched to “Analog” (see page 52). In this case, the setting of the output resolution will be that for HDMI output (see page 52). However, it will be switched to “1080i” when “1080p” is selected, and to “Through” when “Auto” is selected.

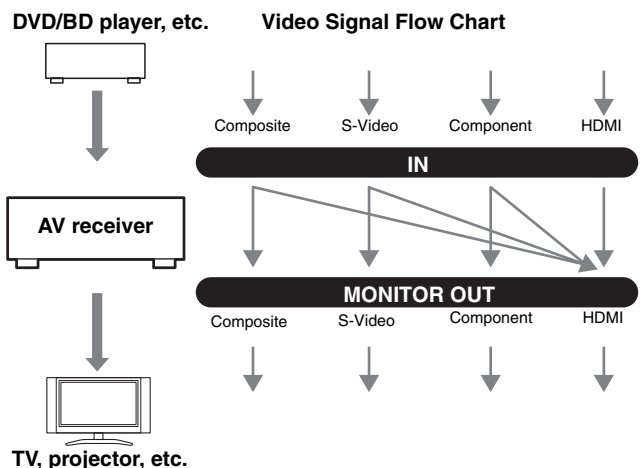

Connecting the AV receiver—Continued

■ “Monitor Out” Setting Set to “Both”, “Both(Main)” or “Both(Sub)”

With the “Monitor Out” setting set to “Both”, “Both(Main)” or “Both(Sub)” (see page 52), video input signals flow through the AV receiver as shown, with composite video, S-Video, and component video sources all being upconverted for both HDMI outputs. Use the “Both”, “Both(Main)” or “Both(Sub)” setting if you connect the AV receiver’s HDMI OUT MAIN and HDMI OUT SUB to your TVs.

The composite video, S-Video, and component video outputs pass through their respective input signals as they are.

Both: Video signals are output from both HDMI outputs at the resolution supported by both TVs. You cannot select “Resolution” setting. The picture adjust setting will be that for “HDMI Main”.

Both (Main): Video signals are output from both HDMI outputs but HDMI OUT MAIN will become a priority; depending on the resolution, video signals may not be output from HDMI OUT SUB.

Both (Sub): Video signals are output from both HDMI outputs but HDMI OUT SUB will become a priority; depending on the resolution, video signals may not be output from HDMI OUT MAIN.

Note:

The “Monitor Out” setting will be automatically switched to “Analog” (see page 52) if not connected to both outputs when “Both” is selected or if not connected to a priority output when “Both(Main)” or “Both(Sub)” is selected.

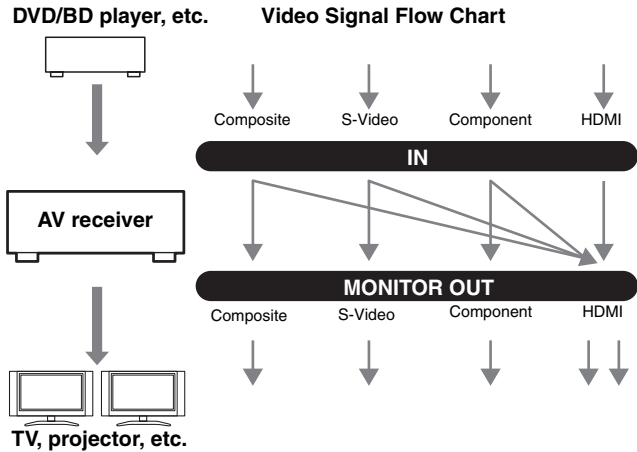

■ “Monitor Out” Setting Set to “Analog”

With the “Monitor Out” setting set to “Analog” (see page 52), video input signals flow through the AV receiver as shown, with composite video and S-Video sources being upconverted for the component video output. Use this setting if you connect the AV receiver’s COMPONENT VIDEO MONITOR OUT to your TV.

Composite video is upconverted to S-Video and S-Video is downconverted to composite video. Note that these conversions only apply to the MONITOR OUT V and S outputs, not the VCR/DVR OUT V and S outputs.

The composite video, S-Video, and component video outputs pass through their respective input signals as they are.

This signal flow also applies when the “Resolution” setting is set to “Through” (see page 52).

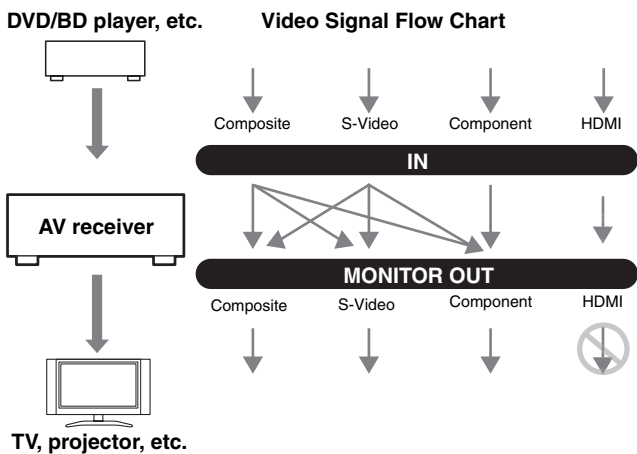

Video Signal Flow and the Resolution Setting

When the “Monitor Out” setting is set to “Analog” (see page 52), if the “Resolution” setting is set to anything other than “Through” (see page 52), the video signal flow will be as shown here, with composite video and S-Video sources being upconverted for the component video output.

The composite video, S-Video, and component video outputs pass through their respective analog input signals as they are. HDMI input signals are not output.

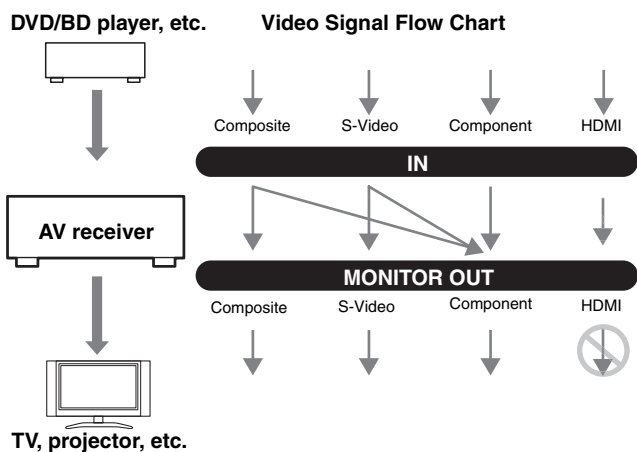

Connecting the AV receiver—Continued

Audio Connection Formats

Audio equipment can be connected to the AV receiver by using any of the following audio connection formats: analog, optical, coaxial, analog multichannel, or HDMI.

When choosing a connection format, bear in mind that the AV receiver does not convert digital input signals for analog line outputs and vice versa. For example, audio signals connected to an optical or coaxial digital input are not output by the analog TV/TAPE OUT.

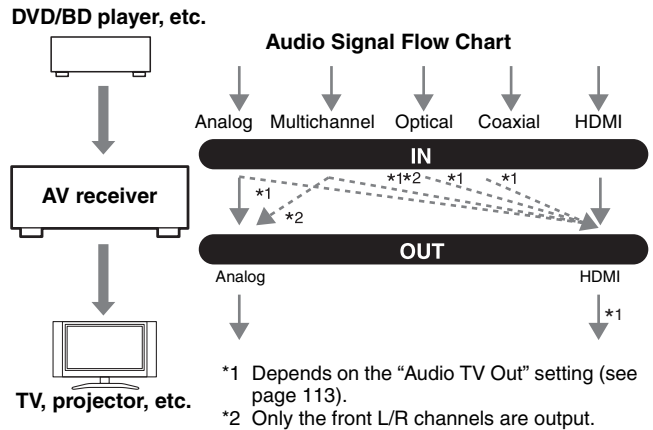

If signals are present at more than one input, the inputs will be selected automatically in the following order of priority: HDMI, digital, analog.

Connecting the AV receiver—Continued

Connecting a TV or Projector

See “Connecting Components with HDMI” on page 30 for HDMI connection information.

Step 1: Video Connection

Choose a video connection that matches your TV (**A**, **B**, or **C**), and then make the connection.

Step 2: Audio Connection

Choose an audio connection that matches your TV (**a**, **b**, or **c**), and then make the connection.

- With connection **a**, you can listen to and record audio from your TV or listen in Zone 2 or Zone 3.
- To enjoy Dolby Digital and DTS, use connection **b** or **c**. (To record or listen in Zone 2 or Zone 3 as well, use **a** and **b**, or **a** and **c**.)

Connection	AV receiver	Signal flow	TV, projector, etc.
A	COMPONENT VIDEO MONITOR OUT	⇒	Component video input
B	MONITOR OUT S	⇒	S-Video input
C	MONITOR OUT V	⇒	Composite video input
a	TV/TAPE IN L/R	⇐	Analog audio L/R output
b	DIGITAL COAXIAL IN 2 (VCR/DVR)	⇐	Digital coaxial output
c	DIGITAL OPTICAL IN 1 (GAME) (TX-NR3007) DIGITAL OPTICAL IN 2 (TV/TAPE) (TX-NR5007)	⇐	Digital optical output

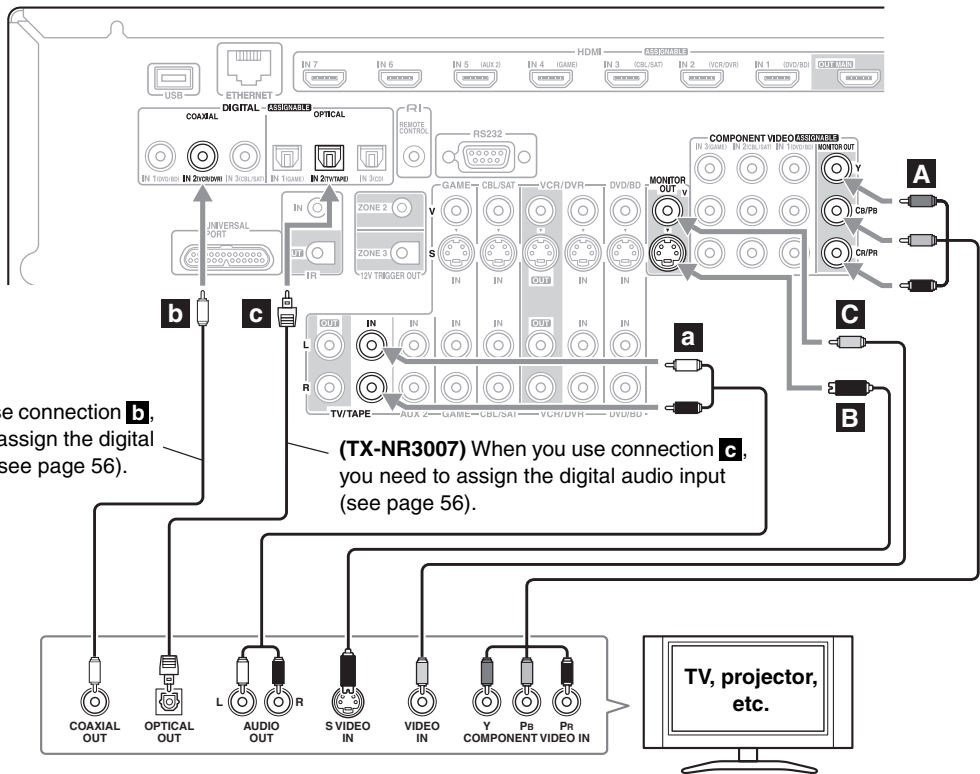

When you use connection **b**, you need to assign the digital audio input (see page 56).

(TX-NR3007) When you use connection **c**, you need to assign the digital audio input (see page 56).



If your TV has no audio outputs, connect an audio output from your VCR or cable or satellite receiver to the AV receiver and use its tuner to listen to TV programs through the AV receiver (see pages 38 and 40).

Connecting the AV receiver—Continued

Connecting a DVD Player

See “Connecting Components with HDMI” on page 30 for HDMI connection information.

Step 1: Video Connection

Choose a video connection that matches your DVD player (**A**, **B**, or **C**), and then make the connection. You must connect the AV receiver to your TV via the same type of connection.

Step 2: Audio Connection

Choose an audio connection that matches your DVD player (**a**, **b**, or **c**), and then make the connection.

- With connection **a**, you can listen to and record audio from your DVD player or listen in Zone 2 or Zone 3.
- To enjoy Dolby Digital and DTS, use connection **b** or **c**. (To record or listen in Zone 2 or Zone 3 as well, use **a** and **b**, or **a** and **c**.)
- If your DVD player has main left and right outputs and multichannel left and right outputs, be sure to use the main left and right outputs for connection **a**.

Connection	AV receiver	Signal flow	DVD player
A	COMPONENT VIDEO IN 1 (DVD/BD)	←	Component video output
B	DVD/BD IN S	←	S-Video output
C	DVD/BD IN V	←	Composite video output
a	DVD/BD IN L/R	←	Analog audio L/R output
b	DIGITAL COAXIAL IN 1 (DVD/BD)	←	Digital coaxial output
c	DIGITAL OPTICAL IN 1 (GAME)	←	Digital optical output

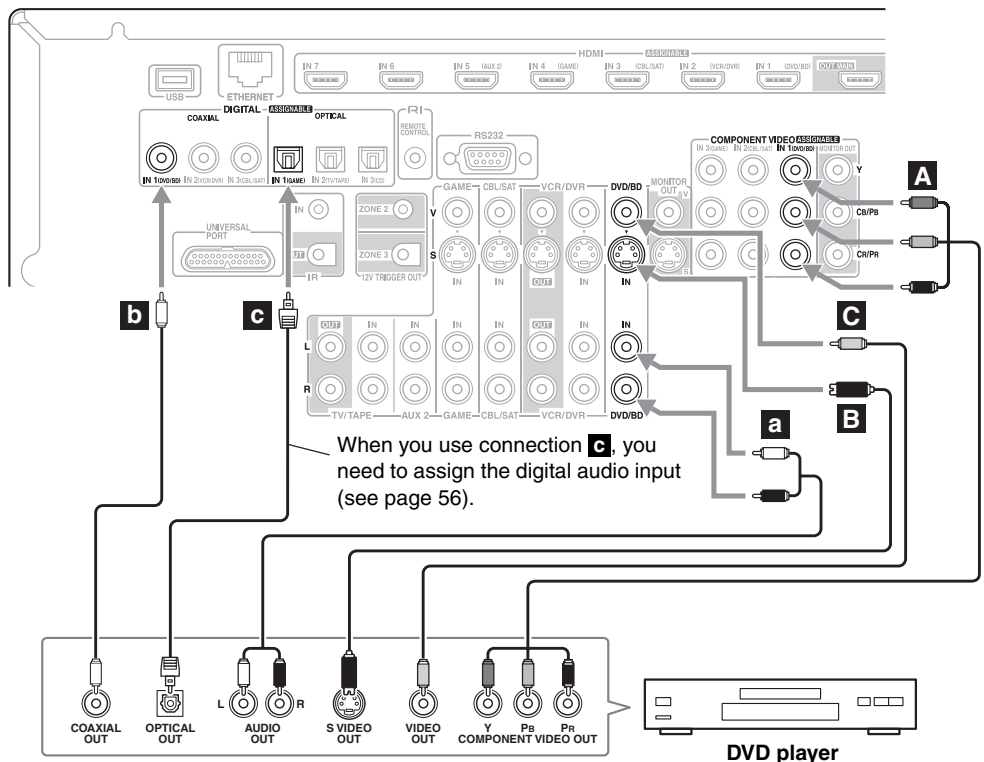

Connecting the AV receiver—Continued

Hooking Up the Multichannel Input

If your DVD player supports multichannel audio formats such as DVD-Audio and Super Audio CD, and it has a multichannel analog audio output, you can connect it to the AV receiver's multichannel input.

Use a multichannel analog audio cable, or several normal audio cables, to connect the AV receiver's MULTI CH: FRONT L/R, CENTER, SURR L/R, SURR BACK L/R, and SUBWOOFER jacks to the 7.1-channel analog audio output on your DVD player. If your DVD player has a 5.1-channel analog audio output, don't connect anything to the AV receiver's SURR BACK L/R jacks.

Before using the multichannel input, you must assign it to an input selector. See "Analog Audio Input Setup" on page 57. To select the multichannel input, see "Audio Selector" on page 119. To adjust the subwoofer sensitivity for the multichannel input, see "Subwoofer Input Sensitivity" on page 94.

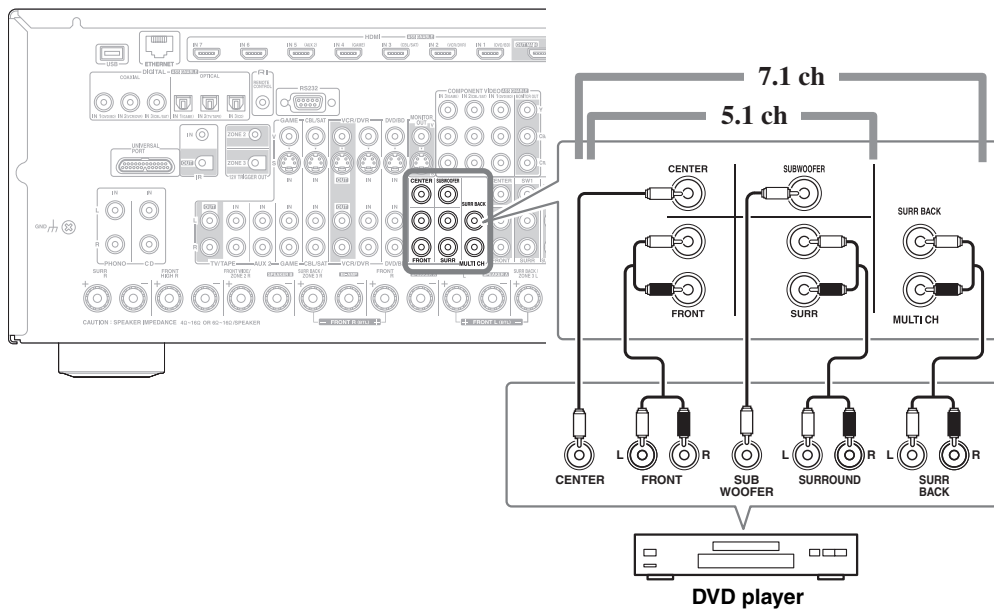

Connecting the AV receiver—Continued

Connecting a VCR or DVD Recorder for Playback



With this hookup, you can use your VCR's tuner to listen to your favorite TV programs via the AV receiver, useful if your TV has no audio outputs.

Step 1: Video Connection

Choose a video connection that matches your VCR or DVD recorder (**A**, **B**, or **C**), and then make the connection. You must connect the AV receiver to your TV via the same type of connection.

Step 2: Audio Connection

Choose an audio connection that matches your VCR or DVD recorder (**a**, **b**, or **c**), and then make the connection.

- With connection **a**, you can listen to the VCR or DVD recorder in Zone 2 or Zone 3.
- To enjoy Dolby Digital and DTS, use connection **b** or **c**. (To listen in Zone 2 or Zone 3 as well, use **a** and **b**, or **a** and **c**.)

Connection	AV receiver	Signal flow	VCR or DVD recorder
A	COMPONENT VIDEO IN 2 (CBL/SAT)	←	Component video output
B	VCR/DVR IN S	←	S-Video output
C	VCR/DVR IN V	←	Composite video output
a	VCR/DVR IN L/R	←	Analog audio L/R output
b	DIGITAL COAXIAL IN 2 (VCR/DVR)	←	Digital coaxial output
c	DIGITAL OPTICAL IN 1 (GAME)	←	Digital optical output

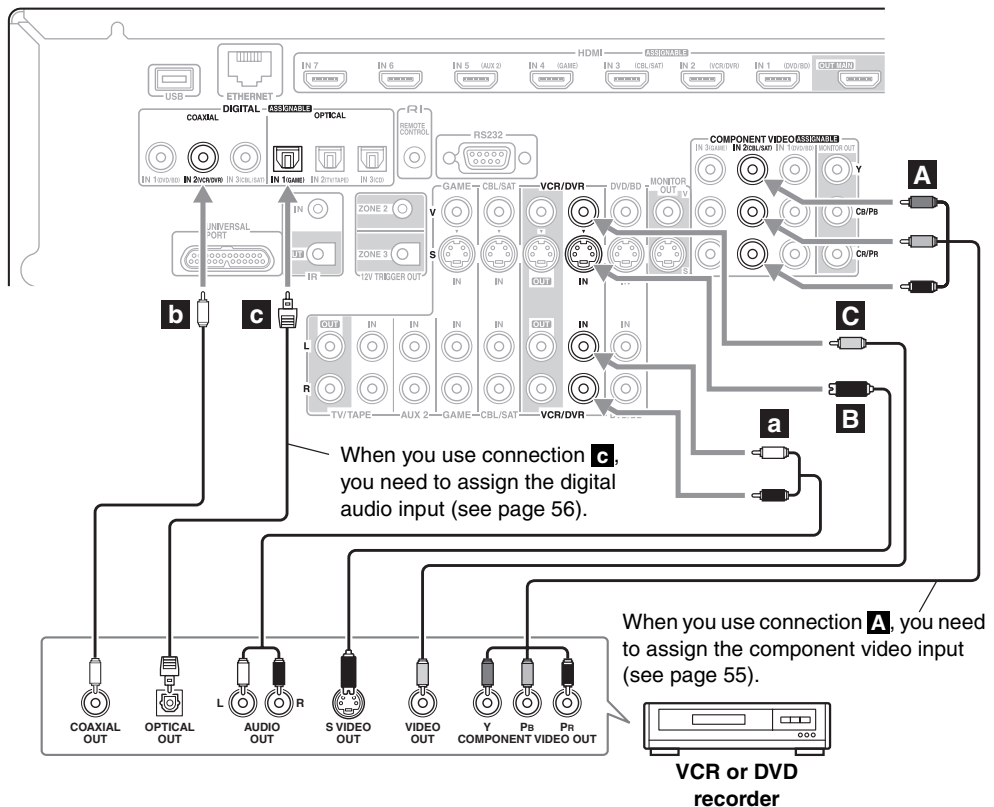

Connecting the AV receiver—Continued

Connecting a VCR or DVD Recorder for Recording

Step 1: Video Connection

Choose a video connection that matches your VCR or DVD recorder (**A** or **B**), and then make the connection. The video source to be recorded must be connected to the AV receiver via the same type of connection.

Step 2: Audio Connection

Make the audio connection **a**.

Connection	AV receiver	Signal flow	VCR or DVD recorder
A	VCR/DVR OUT S	⇒	S-Video input
B	VCR/DVR OUT V	⇒	Composite video input
a	VCR/DVR OUT L/R	⇒	Analog audio L/R input

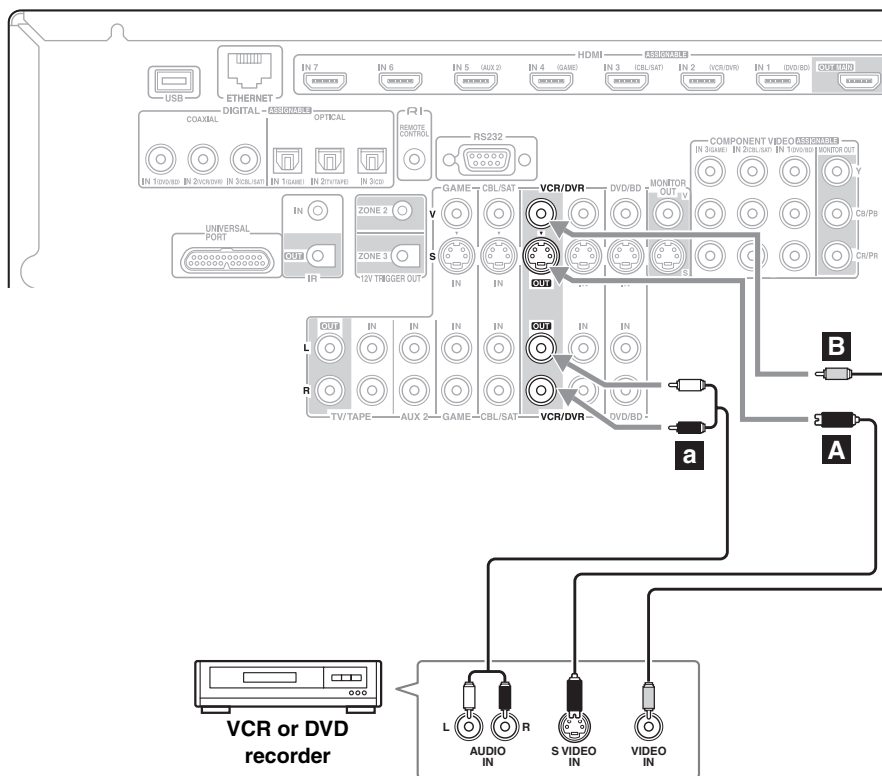

Notes:

- The AV receiver must be turned on for recording. Recording is not possible while it's in Standby mode.
- If you want to record directly from your TV or playback VCR to the recording VCR without going through the AV receiver, connect the TV/VCR's audio and video outputs directly to the recording VCR's audio and video inputs. See the manuals supplied with your TV and VCR for details.
- Video signals connected to composite video inputs can only be recorded via composite video outputs. If your TV/VCR is connected to a composite video input, the recording VCR must be connected to a composite video output. Similarly, video signals connected to S-Video inputs can only be recorded via S-Video outputs. If your TV/VCR is connected to an S-Video input, the recording VCR must be connected to an S-Video output.
- Sources connected to a digital input cannot be recorded. Only analog inputs can be recorded.

Connecting the AV receiver—Continued

Connecting a Satellite, Cable, Terrestrial Set-top box, or Other Video Source



With this hookup, you can use your satellite or cable receiver to listen to your favorite TV programs via the AV receiver, useful if your TV has no audio outputs.

Step 1: Video Connection

Choose a video connection that matches the video source (**A**, **B**, or **C**), and then make the connection. You must connect the AV receiver to your TV via the same type of connection.

Step 2: Audio Connection

Choose an audio connection that matches the video source (**a**, **b**, or **c**), and then make the connection.

- With connection **a**, you can listen to and record audio from the video source or listen in Zone 2 or Zone 3.
- To enjoy Dolby Digital and DTS, use connection **b** or **c**. (To record or listen in Zone 2 or Zone 3 as well, use **a** and **b**, or **a** and **c**.)

Connection	AV receiver	Signal flow	Video source
A	COMPONENT VIDEO IN 2 (CBL/SAT)	←	Component video output
B	CBL/SAT IN S	←	S-Video output
C	CBL/SAT IN V	←	Composite video output
a	CBL/SAT IN L/R	←	Analog audio L/R output
b	DIGITAL COAXIAL IN 3 (CBL/SAT)	←	Digital coaxial output
c	DIGITAL OPTICAL IN 1 (GAME)	←	Digital optical output

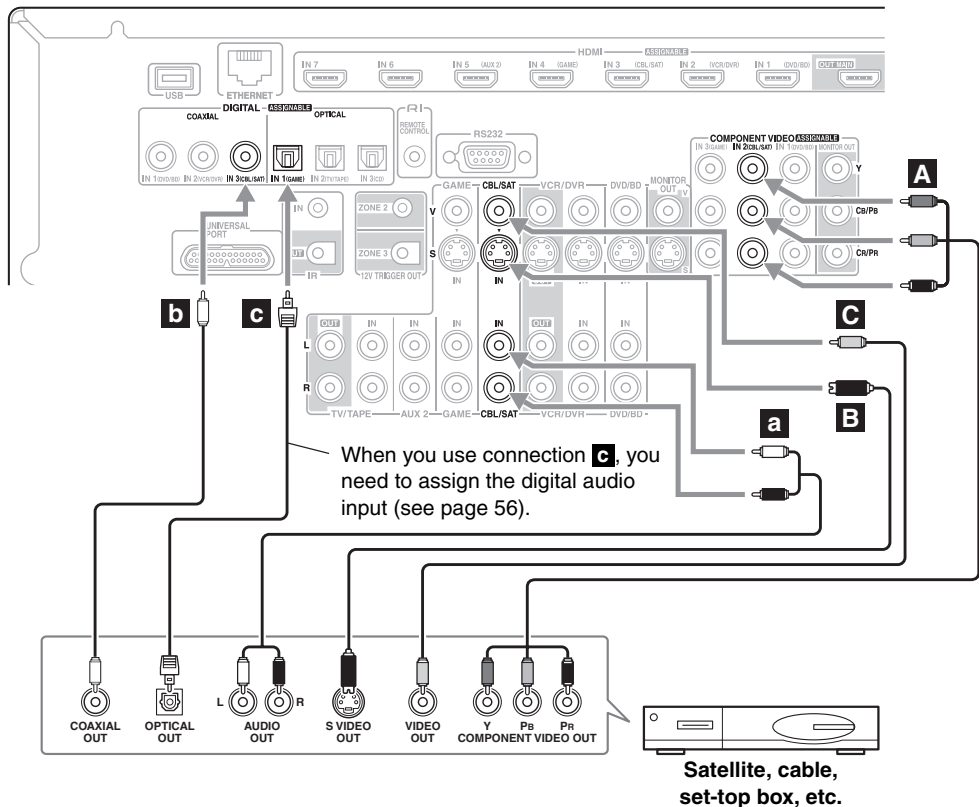

Connecting the AV receiver—Continued

Connecting a Game Console

Step 1: Video Connection

Choose a video connection that matches your game console (**A**, **B**, or **C**), and then make the connection. You must connect the AV receiver to your TV with the same type of connection.

Step 2: Audio Connection

Choose an audio connection that matches your game console (**a** or **b**), and then make the connection.

- With connection **a**, you can listen to and record audio from your game console or listen in Zone 2 or Zone 3.
- To enjoy Dolby Digital and DTS, use connection **b**. (To record or listen in Zone 2 or Zone 3 as well, use **a** and **b**.)

Connection	AV receiver	Signal flow	Game console
A	COMPONENT VIDEO IN 3 (GAME)	←	Component video output
B	GAME IN S	←	S-Video output
C	GAME IN V	←	Composite video output
a	GAME IN L/R	←	Analog audio L/R output
b	DIGITAL OPTICAL IN 1 (GAME)	←	Digital optical output

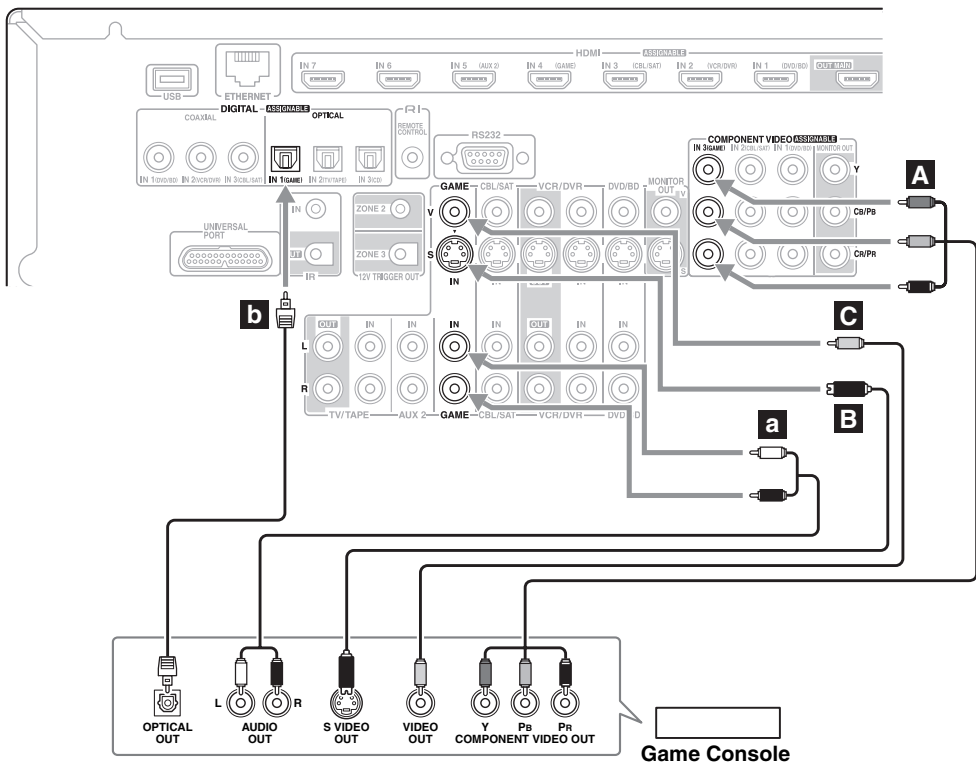

Connecting the AV receiver—Continued

Connecting a Camcorder or Other Device

Step 1: Video Connection

Make the connection **A**.

Step 2: Audio Connection

Choose an audio connection that matches your camcorder (**a** or **b**), and then make the connection.

Connection	AV receiver	Signal flow	Camcorder etc.
A	AUX1 INPUT VIDEO	←	Composite video output
a	AUX1 INPUT L-AUDIO-R	←	Analog audio L/R output
b	AUX1 INPUT DIGITAL	←	Digital optical output

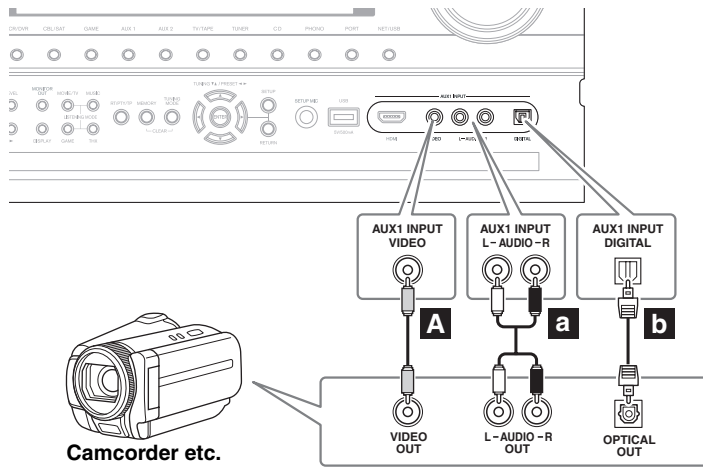

Connecting the AV receiver—Continued

Connecting a CD Player or Turntable

■ CD Player or Turntable (MM) with Built-in Phono Preamp

Step 1:

Choose a connection that matches your CD player (**a**, **b**, or **c**). Use connection **a** for a turntable with a built-in phono preamp.

- With connection **a**, you can listen to and record audio from your CD player or listen in Zone 2 or Zone 3.
- To connect the CD player digitally, use connection **b** or **c**. (To record or listen in Zone 2 or Zone 3 as well, use **a** and **b**, or **a** and **c**.)

Connection	AV receiver	Signal flow	CD or turntable
a	CD IN L/R	←	Analog audio L/R output
b	DIGITAL COAXIAL IN 2 (VCR/DVR)	←	Digital coaxial output
c	DIGITAL OPTICAL IN 2 (CD) (TX-NR3007) DIGITAL OPTICAL IN 3 (CD) (TX-NR5007)	←	Digital optical output

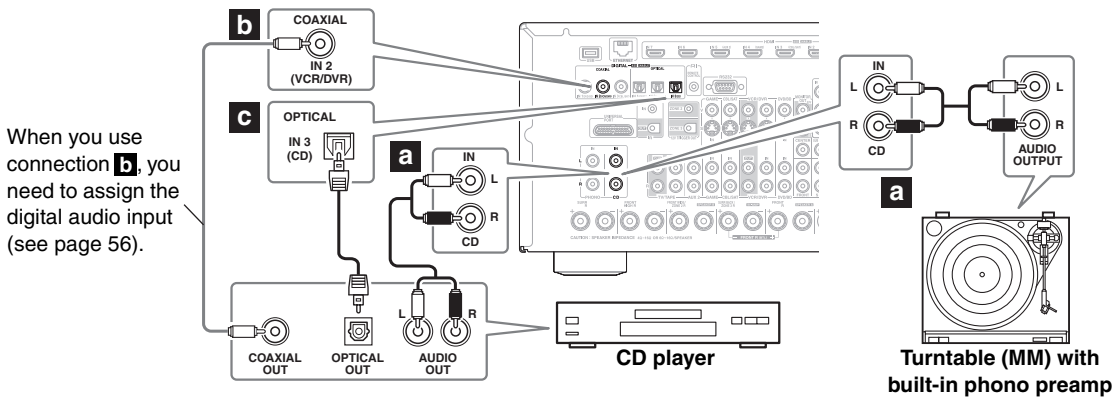

■ Turntable (MM) with no Phono Preamp Built-in

The AV receiver's PHONO IN is designed for use with a moving magnet (MM) type cartridge.

Use an analog audio cable to connect the AV receiver's PHONO IN L/R jacks to the audio output on your turntable.

Notes:

- If your turntable has a ground wire, connect it to the AV receiver's GND screw. With some turntables, connecting the ground wire may produce an audible hum. If this happens, disconnect it.
- If your turntable has a moving coil (MC) type cartridge, you'll need a commercially available MC head amp or MC transformer. Connect your turntable to the head amp or transformer, and connect that to the AV receiver's PHONO IN L/R jacks.
- You can also use a phono equalizer to connect a turntable with an MC-type cartridge. See your phono equalizer's manual for details.

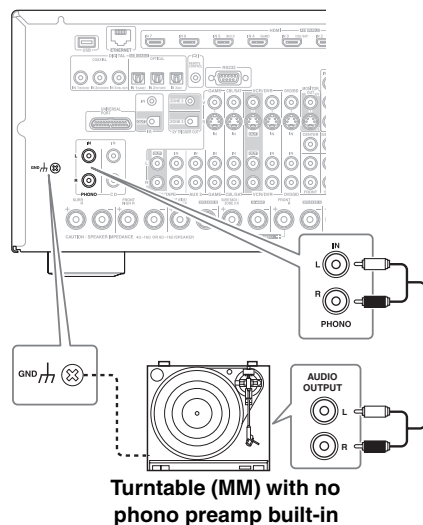

Connecting the AV receiver—Continued

Connecting a Cassette, CDR, MiniDisc, or DAT Recorder

Step 1:

Choose a connection that matches the recorder (**a**, **b** or **c**), and then make the connection.

- With connection **a**, you can play and record or listen in Zone 2 or Zone 3.
- To connect the recorder digitally for playback, use connections **a** and **b**, or **a** and **c**.

Connection	AV receiver	Signal flow	Cassette, CDR, MD, or DAT recorder
a	TV/TAPE IN L/R TV/TAPE OUT L/R	← →	Analog audio L/R output Analog audio L/R input
b	DIGITAL COAXIAL IN 3 (CBL/SAT)	←	Digital coaxial output
c	DIGITAL OPTICAL IN 1 (GAME) (TX-NR3007) DIGITAL OPTICAL IN 2 (TV/TAPE) (TX-NR5007)	←	Digital optical output

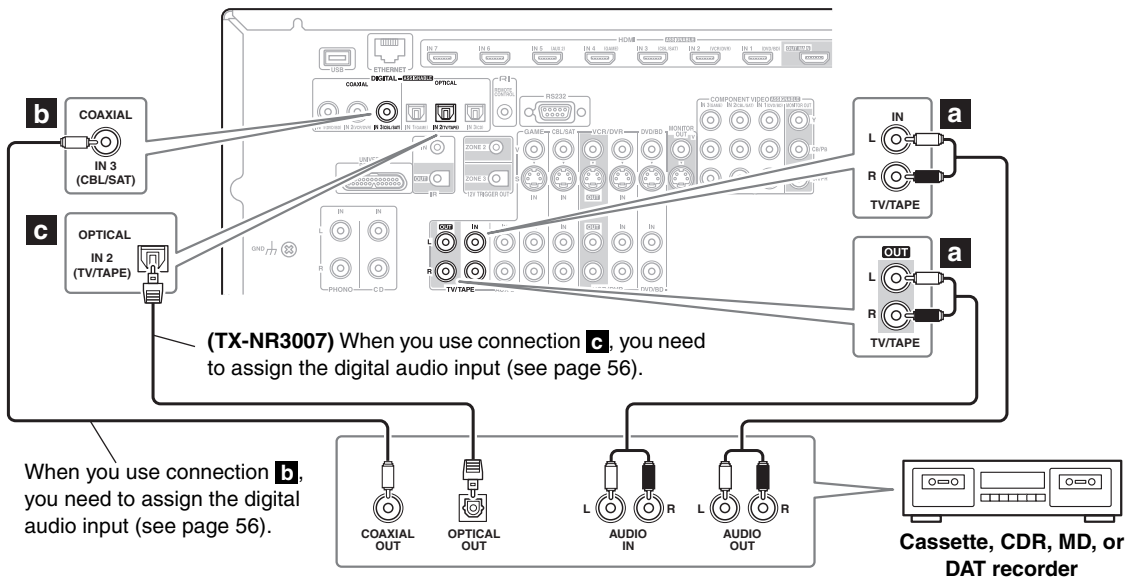

Connecting the AV receiver—Continued

Connecting a Power Amplifier

If you want to use a more powerful power amplifier and use the AV receiver as a preamp, connect it to the PRE OUT jacks, and connect all speakers and the subwoofer to the power amplifier. You can connect the powered subwoofer with each jacks respectively. If you use one subwoofer, connect it to PRE OUT: SW1.

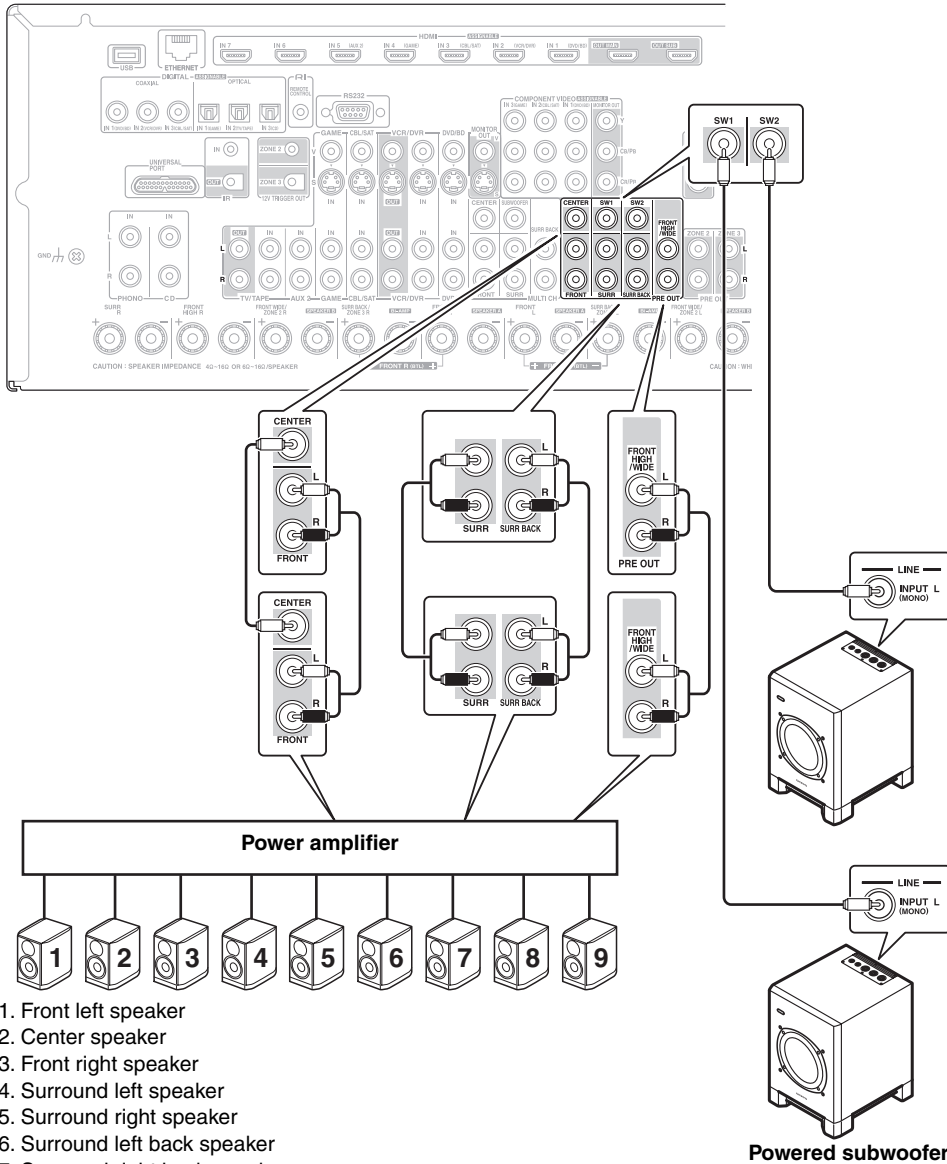

1. Front left speaker
2. Center speaker
3. Front right speaker
4. Surround left speaker
5. Surround right speaker
6. Surround left back speaker
7. Surround right back speaker
8. Front wide/Front high left speaker*
9. Front wide/Front high right speaker*

Note:

* Specify "None" for the channel that you don't want to output in the "Speaker Configuration" (page 95).

See "Connecting Powered Subwoofers" on page 19 for more information.

Connecting the AV receiver—Continued

Connecting an RI Dock

Not all iPod models output video. For information about which iPod models are supported by the RI Dock, see the RI Dock's instruction manual.

■ If Your iPod Supports Video:

Connect your RI Dock's audio output jacks to the AV receiver's GAME IN or VCR/DVR IN L/R jacks, and connect its video output jack to the AV receiver's GAME IN V or VCR/DVR IN V jack. (Onkyo DS-A2 hookup shown below.)

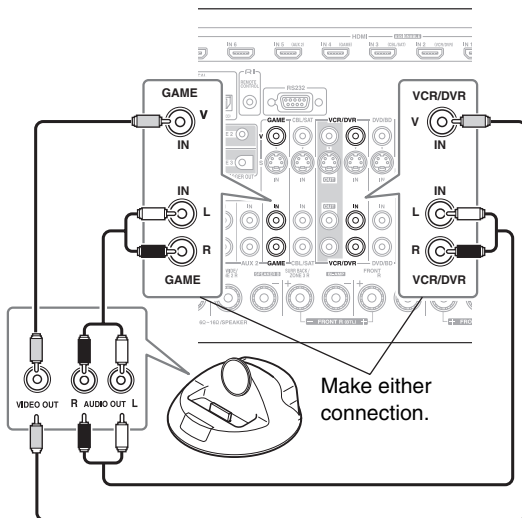

■ If you have an Onkyo DS-A1 RI Dock

Connect its video output jack to the AV receiver's GAME IN S or VCR/DVR IN S jack.

■ If Your iPod Doesn't Support Video:

Connect your RI Dock's audio output jacks to the AV receiver's TV/TAPE IN L/R jacks. (Onkyo DS-A2 hookup shown below.)

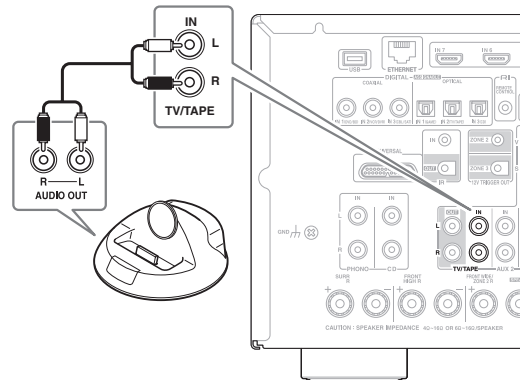

Notes:

- Enter the appropriate remote control code before using the AV receiver's remote controller for the first time (see page 141).
- Connect the RI Dock to the AV receiver with an **RI** cable (see page 47).
- Set the RI Dock's RI MODE switch to "HDD" or "HDD/DOCK".
- Set the AV receiver's Input Display to "DOCK" (see page 60).
- See the RI Dock's instruction manual for more information.

Connecting a Universal Port Option Series

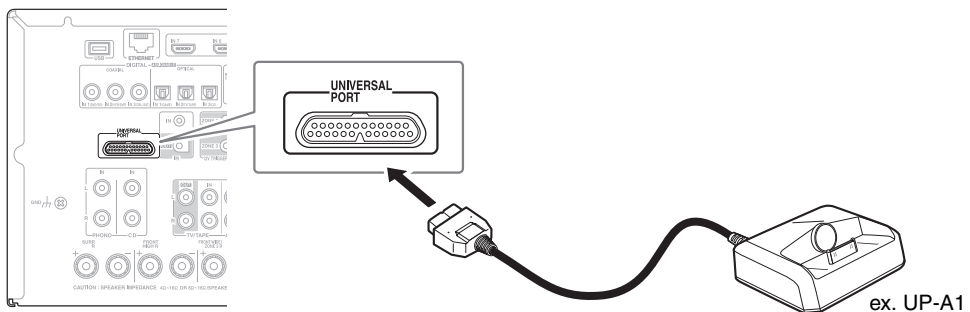

Note:

When UP-A1 Dock that seated iPod is connected, the power consumption on standby mode slightly increases.

Connecting Onkyo RI Components

Step 1:

Make sure that each Onkyo component is connected to the AV receiver with an analog audio cable (connection **a** in the hookup examples) (see pages 35 to 44, 46).

Step 2:

Make the **RI** connection (see illustration right).

Step 3:

If you're using an MD, CDR, or RI Dock, change the Input Display (see page 60).

With **RI** (Remote Interactive), you can use the following special functions:

■ Auto Power On/Standby

When you start playback on a component connected via **RI**, if the AV receiver is on Standby, it will automatically turn on and select that component as the input source. Similarly, when the AV receiver is set to Standby, all components connected via **RI** will also go on Standby.

■ Direct Change

When playback is started on a component connected via **RI**, the AV receiver automatically selects that component as the input source.

■ Remote Control

You can use the AV receiver's remote controller to control your other **RI**-capable Onkyo components, pointing the remote controller at the AV receiver's remote control sensor instead of the component. You must enter the appropriate remote control code first (see page 142).

Notes:

- Use only **RI** cables for **RI** connections. **RI** cables are supplied with Onkyo players (DVD, CD, etc.).
- Some components have two **RI** jacks. You can connect either one to the AV receiver. The other jack is for connecting additional **RI**-capable components.
- Connect only Onkyo components to **RI** jacks. Connecting other manufacturer's components may cause a malfunction.
- Some components may not support all **RI** functions. Refer to the manuals supplied with your other Onkyo components.
- While Zone 2 or Zone 3 is on, the Auto Power On/Standby and Direct Change **RI** functions do not work.

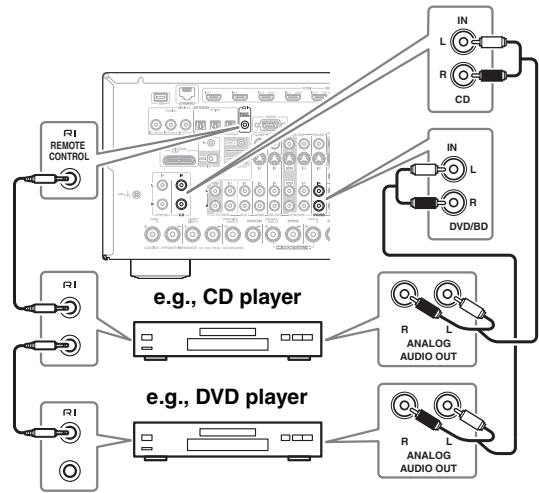

Connecting the Power Cord

Notes:

- **Before connecting the power cord, connect all of your speakers and AV components.**
- Turning on the AV receiver may cause a momentary power surge that might interfere with other electrical equipment on the same circuit. If this is a problem, plug the AV receiver into a different branch circuit.
- Do not use a power cord other than the one supplied with the AV receiver. The supplied power cord is designed exclusively for use with the AV receiver and should not be used with any other equipment.
- Never disconnect the power cord from the AV receiver while the other end is still plugged into a wall outlet. Doing so may cause an electric shock. Always disconnect the power cord from the wall outlet first, and then the AV receiver.

Step 1:

Connect the supplied power cord to the AV receiver's AC INLET.

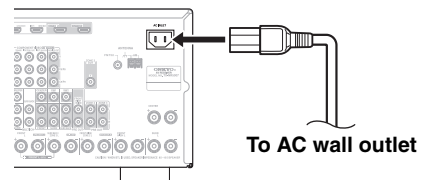

Step 2:

Plug the power cord into an AC wall outlet.

Turning On the AV receiver

(North American models)

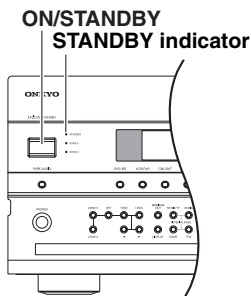

(European and Asian models)

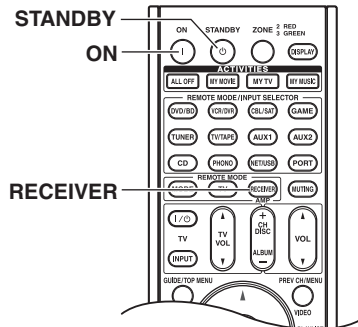
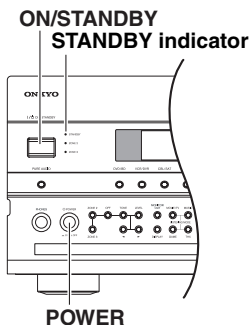

Turning On and Standby

1



(European and Asian models)

Set the [POWER] switch to the ON position (▲).

2

AV receiver



or

Remote controller

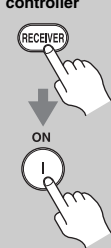

On the AV receiver, press the [ON/STANDBY] button.

On the remote controller, press the [RECEIVER] button, followed by the [ON] button.

The AV receiver comes on, the display lights up, and the STANDBY indicator goes off. Pressing the remote controller's [ON] button again will turn on any components connected via **RI**.

To turn the AV receiver off, press the [ON/STANDBY] button, or press the remote controller's [STANDBY] button. The AV receiver will enter Standby mode. To prevent any loud surprises when you turn on the AV receiver, always turn down the volume before you turn it off.

European and Asian models: To completely shut down the AV receiver, set the [POWER] switch to the OFF position (■).

Smooth Operation in a Few Easy Steps

To ensure smooth operation, here's a few easy steps to help you configure the AV receiver before you use it for the very first time. These settings only need to be made once.

■ **Did you connect your TV to an HDMI output or COMPONENT VIDEO MONITOR OUT?**

If you did, "Monitor Setup" on page 49.



■ **Run MultEQ XT Room Correction and Speaker Setup—this is essential!**

See "Audyssey MultEQ® XT Room Correction and Speaker Setup" on page 61.



■ **Have you connected a component to an HDMI input, component video input, or digital audio input?**

If you have, see "HDMI Input Setup" on page 54, "Component Video Input Setup" on page 55, or "Digital Audio Input Setup" on page 56 respectively.

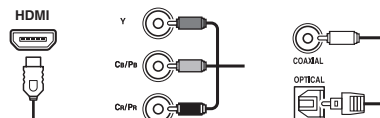

■ **Have you connected an Onkyo MD recorder, CD recorder, or RI Dock?**

If you have, see "Changing the Input Display" on page 60.



First Time Setup

This section explains the settings that you need to make before using the AV receiver for the very first time.

Monitor Setup

If you connect your TV to HDMI OUT MAIN, “Monitor Out” setting is automatically set so that the onscreen setup menus are displayed and composite video, S-Video, and component video sources are upconverted* and output.

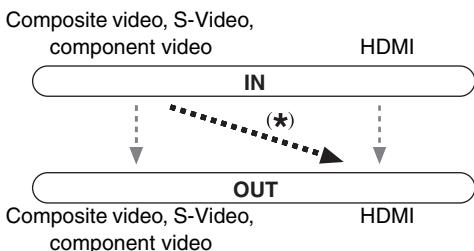

On the “Monitor Out” settings, you can select whether or not to have the video sources’ images output through the HDMI output, as well as whether to have the onscreen setup menu output through the HDMI output or through an analog output.

If you connect your TV to the COMPONENT VIDEO MONITOR OUT (not the HDMI output), “Monitor Out” setting is automatically set so that the onscreen setup menus are displayed and composite video and S-Video sources are upconverted* and output.

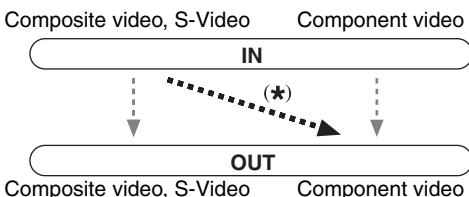

Change “Monitor Out” setting manually

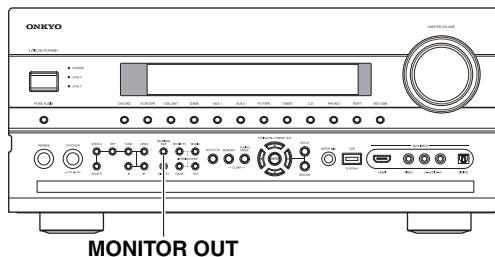

1

MONITOR OUT



Press the [MONITOR OUT] button.

The current setting is displayed.

Monitor Out
: HDMI Main

2

MONITOR OUT



Press the [MONITOR OUT] button repeatedly to select: Analog, HDMI Main, HDMI Sub, Both, Both(Main) or Both(Sub)

For details on each item, see step 4 in the page 52.

Tips:

- The “Monitor Out” setting can also be set using the [VIDEO] button on the remote controller.
- This setting can also be performed by using Onscreen Setup Menu (see page 52).

Notes:

- See page 32 for charts showing how the “Monitor Out” and “Resolution” (see page 52) settings affect the video signal flow through the AV receiver.
- You can specify the output resolution for the HDMI outputs and COMPONENT VIDEO MONITOR OUT and have the AV receiver upconvert the picture resolution as necessary to match the resolution supported by your TV (see page 52).

First Time Setup—Continued

In this Instruction Manual, illustrations from the onscreen menu or explanations referring to the menu will be in the same language as the Instruction Manual. The default Language setting for the onscreen menu is English. If your Instruction Manual is in a language other than English, first follow the instructions below to change the Language.

Selecting the Language used for the onscreen setup menus

This setting determines the language used for the onscreen setup menus. You can select: English, German, French, Spanish, Italian, Dutch, Swedish, or Chinese.

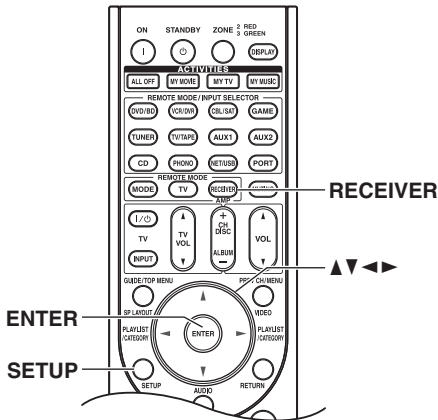

- 1** Press the [RECEIVER] button, followed by the [SETUP] button. The main menu appears onscreen. If the main menu doesn't appear, make sure the appropriate external input is selected on your TV.

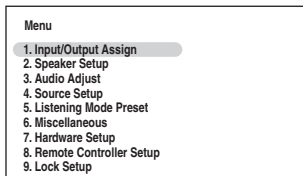

- 2** Use the Up and Down [▲]/[▼] buttons to select "6. Miscellaneous", and then press [ENTER]. The "Miscellaneous" menu appears.

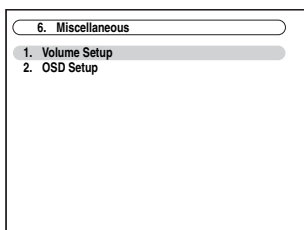

- 3** Use the Up and Down [▲]/[▼] buttons to select "2. OSD Setup", and then press [ENTER]. The "OSD Setup" menu appears.

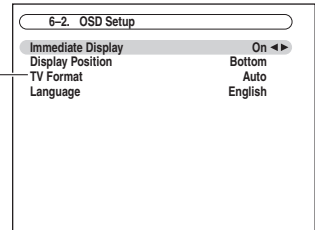

(European and Asian models)

- 4** Use the Up and Down [▲]/[▼] buttons to select "Language", and then use the Left and Right [◀]/[▶] buttons to select: English, Deutsch, Français, Español, Italiano, Nederlands, Svenska, 中文

- 5** Press the [SETUP] button. The setup menu closes.

Note:

This procedure can also be performed on the AV receiver by using its [SETUP] button, arrow buttons, and [ENTER] button.

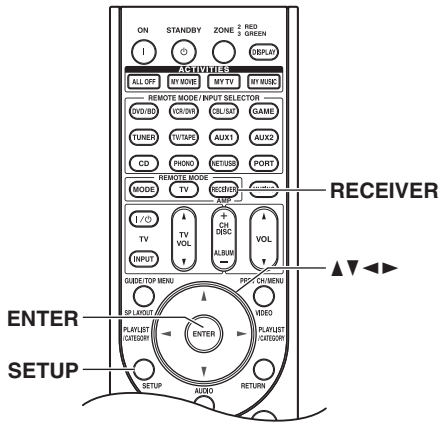

Using the Onscreen Setup Menus

Carry out the settings for the AV receiver by using the Onscreen Setup Menu.

1

Press the [RECEIVER] button followed by the [SETUP] button.

The main menu appears onscreen. If the main menu doesn't appear, make sure the appropriate external input is selected on your TV.

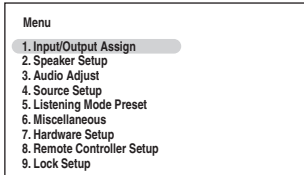
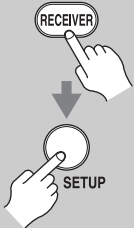

Tip: On several functions, the explanation will be displayed under the screen.

2

Use the Up and Down [▲]/[▼] buttons to select item and then press [ENTER].

The submenu appears. Press the [SETUP] button to close the menu. Press the [RETURN] button to return to the previous menu.

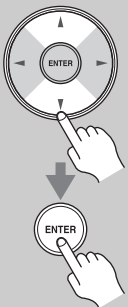

Using the Display to change the settings

The settings of the AV receiver can be changed using the Display.

1

Press the [RECEIVER] button followed by the [SETUP] button.

The main menu item appears on the display.



1. Input/Output Assign

2

Use the Up and Down [▲]/[▼] buttons to select item and then press [ENTER].

The submenu item appears on the display.

Press the [SETUP] button to close the menu.

Press the [RETURN] button to return to the previous menu.



Onscreen Setup Menus and Display

As each item in the Onscreen Setup Menus is selected, the selected items will be displayed one by one.

Onscreen Setup Menus

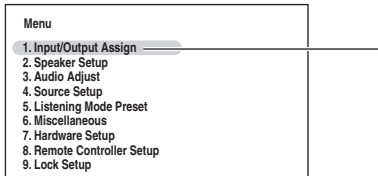

Display

1. Input/Output Assign

Note:

During Audyssey MultEQ® XT Room Correction and Speaker Setup, messages, etc., that are displayed on the TV screen will appear in the Display.

Monitor Out Setup

If you connect your TV to the HDMI output, set the “Monitor Out” setting so that the onscreen setup menus are displayed and composite video, S-Video, and component video sources are upconverted and output. If you connect your TV to the COMPONENT VIDEO MONITOR OUT, set the “Monitor Out” setting so that the onscreen setup menus are displayed and composite video and S-Video sources are upconverted and output. You can specify the output resolution for the HDMI outputs and COMPONENT VIDEO MONITOR OUT and have the AV receiver upconvert the picture resolution as necessary to match the resolution supported by your TV.

1  **Press the [RECEPTOR] button, followed by the [SETUP] button.**
The main menu appears onscreen. If the main menu doesn't appear, make sure the appropriate external input is selected on your TV.

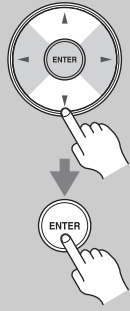
2  **Use the Up and Down [▲]/[▼] buttons to select “1. Input/Output Assign”, and then press [ENTER].**
The “Input/Output Assign” menu appears.

1. Input/Output Assign

- 1. Monitor Out
- 2. HDMI Input
- 3. Component Video Input
- 4. Digital Audio Input
- 5. Analog Audio Input

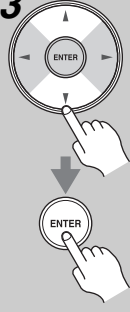
3  **Use the Up and Down [▲]/[▼] buttons to select “1. Monitor Out”, and then press [ENTER].**
The “Monitor Out” menu appears.

1-1. Monitor Out

Monitor Out	HDMI Main ◀▶
Resolution	Through
Brightness	0
Contrast	0
Hue	0
Saturation	0

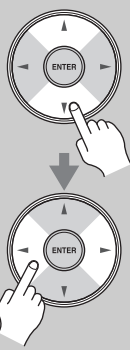
4  **Use the Up and Down [▲]/[▼] buttons to select “Monitor Out”, and use the Left and Right [◀]/[▶] buttons to select:**

Analog:
Select this if your TV is connected to the COMPONENT VIDEO MONITOR OUT, S MONITOR OUT, or V MONITOR OUT.

HDMI Main:
Select this if your TV is connected to the HDMI OUT MAIN.

HDMI Sub:
Select this if your TV is connected to the HDMI OUT SUB.

Both:
Select this if your TVs are connected to the HDMI OUT MAIN and HDMI OUT SUB. Video signals are output from both HDMI outputs at the resolution supported by both TVs.

Both (Main):
Select this if your TVs are connected to the HDMI OUT MAIN and HDMI OUT SUB. Video signals are output from both HDMI outputs but HDMI OUT MAIN will become a priority; depending on the resolution, video signals may not be output from HDMI OUT SUB.

Both (Sub):
Select this if your TVs are connected to the HDMI OUT MAIN and HDMI OUT SUB. Video signals are output from both HDMI outputs but HDMI OUT SUB will become a priority; depending on the resolution, video signals may not be output from HDMI OUT MAIN.

Notes:

- If not connected to the same output you have selected in the “Monitor Out” setting, the “Monitor Out” setting will be automatically switched to “Analog”.
- When you select other than “Analog”, the onscreen setup menus are output by only the HDMI outputs. **If you're not using the HDMI output and select settings by mistake and the menus disappear, press the [MONITOR OUT] button to select “Analog”.**
- For Deep Color output, if the “Monitor Out” setting is set to “Both (Main)” or “Both (Sub)”, the number of bit may be limited due to the capability of your TV connected to a priority output.

5

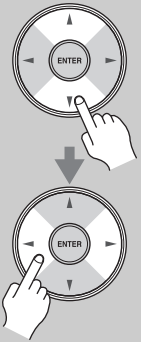

Use the Up and Down [**▲**]/[**▼**] buttons to select “Resolution”, and use the Left and Right [**◀**]/[**▶**] buttons to select:

Through:

Select this to pass video through the AV receiver at the same resolution and with no conversion.

Auto* :

Select this to have the AV receiver automatically convert video at resolutions not supported by your TV.

480p (480p/576p):

Select this for 480p or 576p output and video conversion as necessary.

720p:

Select this for 720p output and video conversion as necessary.

1080i:

Select this for 1080i output and video conversion as necessary.

1080p* :

Select this for 1080p output and video conversion as necessary.

1080p/24* :

Select this for 1080p output at 24 frames per second and video conversion as necessary.

Source:

Output will be according to the resolution level which was set in the “Picture Adjust” setting (see page 105).

Tips:

- The “Resolution” setting can also be set using the [VIDEO] button on the remote controller.
- The “Resolution” setting is set respectively of main, sub, and analog.

Notes:

- Settings marked with an asterisk (*) are not available when the “Monitor Out” setting is set to “Analog”.
- If the “Monitor Out” setting is set to “Both”, this setting is fixed at “Auto”.
- Depending on the incoming video signal, video playback may not be smooth or the vertical resolution may be lowered. In this case select other than “1080p/24”.

6

Press the [SETUP] button.

The setup menu closes.



Notes:

- See page 32 for charts showing how the “Monitor Out” and “Resolution” settings affect the video signal flow through the AV receiver.
- This procedure can also be performed on the AV receiver by using its [SETUP] button, arrow buttons, and [ENTER] button.

Video Input Setup

HDMI Input Setup

If you connect a video component to HDMI IN, you must assign that input to an input selector. For example, if you connect your DVD/BD player to HDMI IN 1, you must assign HDMI IN 1 to the DVD/BD input selector. If you've connected your TV to the AV receiver with an HDMI cable, you can set the AV receiver so that composite video, S-Video, and component video sources are upconverted* and output by the HDMI output. You can set this for each input selector by selecting the "-----" option.

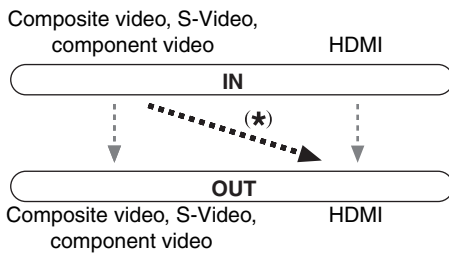

1 Press the [RECEIVER] button followed by the [SETUP] button.

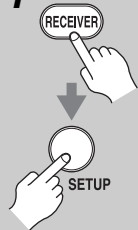

The main menu appears onscreen. If the main menu doesn't appear, make sure the appropriate external input is selected on your TV.

2 Use the Up and Down [▲]/[▼] buttons to select "1. Input/Output Assign", and then press [ENTER].

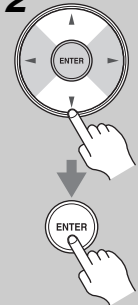

The "Input/Output Assign" menu appears.

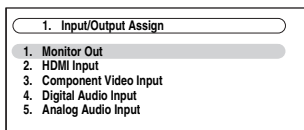

3 Use the Up and Down [▲]/[▼] buttons to select "2. HDMI Input", and then press [ENTER].

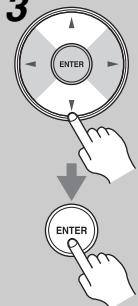

The "HDMI Input" menu appears.

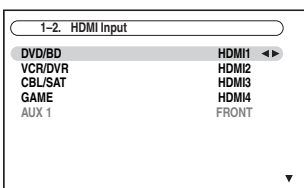

4 Use the Up and Down [▲]/[▼] buttons to select an input selector, and use the Left and Right [◀]/[▶] buttons to select:

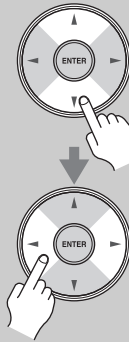

HDMI1, HDMI2, HDMI3, HDMI4, HDMI5, HDMI6, HDMI7 (TX-NR5007):

Select the HDMI IN to which the video component has been connected.

-----: Output composite video, S-Video, and component video sources from the HDMI outputs. The video output signal from the HDMI outputs is the one configured in "Component Video Input Setup" (see page 55).

- Each HDMI IN cannot be assigned to more than one input selector. When HDMI IN have already been assigned, you must set first any unused input selectors to "-----" or you will be unable to assign HDMI IN to input selector.
- "AUX 1" is used only for digital input from the front panel terminals.

5 Press the [SETUP] button.



The setup menu closes.

Notes:

- For composite video, S-Video, and component video upconversion for the HDMI output, the "Monitor Out" setting must be set to other than "Analog" (see page 52), and the "HDMI Input" setting must be set to "-----". See page 32 for more information on video signal flow and upconversion.
- If no video component is connected to HDMI output (even if the HDMI input is assigned), the AV receiver selects the video source based on the setting of Component Video Input.
- When an HDMI IN is assigned to an input selector, the AV receiver will select audio from HDMI IN as a priority. See "Digital Audio Input Setup" on page 56.
- The TUNER input selector cannot be assigned and is fixed at the "-----" option.
- If you connect an input component (such as UP-A1 Dock that seated iPod) to the UNIVERSAL PORT jack, you cannot assign any input to PORT selector.
- Do not assign the component connected with the HDMI input to the TV/TAPE selector when you set "TV Control" setting to "On" (see page 114). Otherwise, appropriate CEC (Consumer Electronics Control) operation is not guaranteed.
- This procedure can also be performed on the AV receiver by using its [SETUP] button, arrow buttons, and [ENTER] button.

Component Video Input Setup

If you connect to a COMPONENT VIDEO IN, you must assign it to an input selector. For example, if you connect your DVD/BD player to COMPONENT VIDEO IN 2, you should assign it to the DVD/BD input selector.

Input selector	Default assignment
DVD/BD	IN1
VCR/DVR	-----
CBL/SAT	IN2
GAME	IN3
AUX 1	-----
AUX 2	-----
TV/TAPE	-----
TUNER	----- (Fixed)
CD	-----
PHONO	-----
PORT	-----

If you've connected your TV to the AV receiver with a component video cable, you can set the AV receiver so that composite video and S-Video sources are upconverted* and output by the COMPONENT VIDEO MONITOR OUT^{*1}. You can set this for each input selector by selecting the "-----" option.

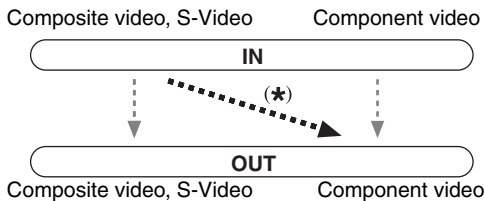

*1 Only when "Monitor Out" setting is set to "Analog".

1 **Press the [RECEIVER] button followed by the [SETUP] button.**
The main menu appears onscreen. If the main menu doesn't appear, make sure the appropriate external input is selected on your TV.

2 **Use the Up and Down [▲]/[▼] buttons to select "1. Input/Output Assign", and then press [ENTER].**
The "Input/Output Assign" menu appears.

1. Input/Output Assign

1. Monitor Out

2. HDMI Input

3. Component Video Input

4. Digital Audio Input

5. Analog Audio Input

3 **Use the Up and Down [▲]/[▼] buttons to select "3. Component Video Input", and then press [ENTER].**
The "Component Video Input" menu appears.

1-3. Component Video Input

DVD/BD IN1

VCR/DVR -----

CBL/SAT IN2

GAME IN3

AUX 1 -----

4 **Use the Up and Down [▲]/[▼] buttons to select an input selector, and then use the Left and Right [◀]/[▶] buttons to select:**

- IN1:** Select if the video component is connected to COMPONENT VIDEO IN 1.
- IN2:** Select if the video component is connected to COMPONENT VIDEO IN 2.
- IN3:** Select if the video component is connected to COMPONENT VIDEO IN 3.
- :** Select if you are using the HDMI outputs, rather than the COMPONENT VIDEO OUT, for the output from composite video, S-Video, and component video sources.

5 **Press the [SETUP] button.**
The setup menu closes.

Notes:

- For composite video and S-Video upconversion for the COMPONENT VIDEO MONITOR OUT, the "Monitor Out" setting must be set to "Analog" (see page 52), and the "Component Video Input" setting must be set to "-----". See page 32 for more information on video signal flow and upconversion.
- If not connected to the same output you have selected in the "Monitor Out" setting, the "Monitor Out" setting will be automatically switched to "Analog" (see page 52).
- If you connect an input component (such as UP-A1 Dock that seated iPod) to the UNIVERSAL PORT jack, you cannot assign any input to PORT selector.
- This procedure can also be performed on the AV receiver by using its [SETUP] button, arrow buttons, and [ENTER] button.

Digital Audio Input Setup

If you connect a component to a digital input jack, you must assign that jack to an input selector. For example, if you connect your CD player to the OPTICAL IN1 jack, you should assign that jack to the CD input selector. By default, the COAXIAL IN1 jack is assigned to the DVD/BD input selector, although this can be changed.

Here are the default assignments.

Input selector	Default assignment	
	(TX-NR3007)	(TX-NR5007)
DVD/BD	COAX1	COAX1
VCR/DVR	COAX2	COAX2
CBL/SAT	COAX3	COAX3
GAME	OPT1	OPT1
AUX 1	FRONT (Fixed)	FRONT (Fixed)
AUX 2	-----	-----
TV/TAPE	-----	OPT2
TUNER	----- (Fixed)	----- (Fixed)
CD	OPT2	OPT3
PHONO	-----	-----
PORT	-----	-----

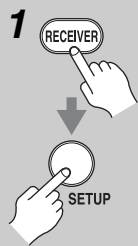

1 Press the [RECEIVER] button followed by the [SETUP] button.

The main menu appears onscreen. If the main menu doesn't appear, make sure the appropriate external input is selected on your TV.



2 Use the Up and Down [▲]/[▼] buttons to select "1. Input/Output Assign", and then press [ENTER].

The "Input/Output Assign" menu appears.

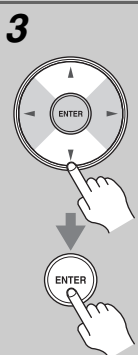
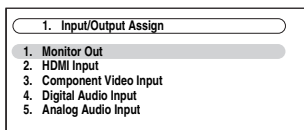

3 Use the Up and Down [▲]/[▼] buttons to select "4. Digital Audio Input", and then press [ENTER].

The "Digital Audio Input" menu appears.

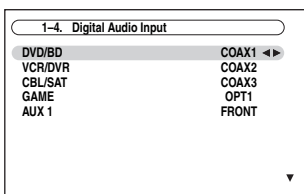

4 Use the Up and Down [▲]/[▼] buttons to select an input selector, and use the Left and Right [◀]/[▶] buttons to select "COAX1", "COAX2", "COAX3", "OPT1", "OPT2", "OPT3" (TX-NR5007), or "----- (analog)".

- When an HDMI IN is assigned to an input selector in "HDMI Input Setup" on page 54, the AV receiver will select audio from HDMI IN as a priority.
- Press the [ENTER] button when you do not use the signal of audio from the HDMI IN. The "*" mark is displayed like "COAX1*".
- "AUX 1" is used only for digital input from the front panel terminals.

Examples:

If you connect your DVD player to the OPTICAL IN 1 jack, set "DVD/BD" to "OPT1".

If you want to listen to audio from the component connected to the OPTICAL IN 2 jack when the VCR/DVR input selector is selected, set "VCR/DVR" to "OPT2".

If you want to listen to audio from the component connected to the COAXIAL IN 1 jack when the CBL/SAT input selector is selected, set "CBL/SAT" to "COAX1".

For input selectors that you don't want to assign a digital input jack, set to "----- (analog)".



5 Press the [SETUP] button.

The setup menu closes.

Notes:

- Available sampling rate for PCM signals from a digital input (optical and coaxial) is 32/44.1/48/88.2/96 kHz/16, 20, 24 bit.
- If you connect an input component (such as UP-A1 Dock that seated iPod) to the UNIVERSAL PORT jack, you cannot assign any input to PORT selector.
- This procedure can also be performed on the AV receiver by using its [SETUP] button, arrow buttons, and [ENTER] button.

Analog Audio Input Setup

If you connect a component to the AV receiver's analog multichannel input, you must assign that input to an input selector. For example, if you connect your DVD/BD player to the MULTI CH input, you must assign it to the DVD/BD input selector.

1  **Press the [RECEIVER] button, followed by the [SETUP] button.**
The main menu appears onscreen. If the main menu doesn't appear, make sure the appropriate external input is selected on your TV.

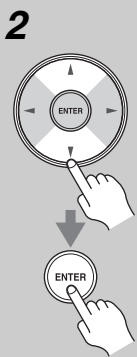
2  **Use the Up and Down [▲]/[▼] buttons to select "1. Input/Output Assign", and then press [ENTER].**
The "Input/Output Assign" menu appears.

1. Input/Output Assign

- 1. Monitor Out
- 2. HDMI Input
- 3. Component Video Input
- 4. Digital Audio Input
- 5. Analog Audio Input

3  **Use the Up and Down [▲]/[▼] buttons to select "5. Analog Audio Input", and then press [ENTER].**
The "Analog Audio Input" menu appears.

1-5. Analog Audio Input

- Multich
- Subwoofer Input Sensitivity

4  **Use the Left and Right [◀]/[▶] buttons to select an input selector.**
You can assign the multichannel input to the following input selectors: "DVD/BD", "VCR/DVR", "CBL/SAT", "GAME", "AUX 1", "AUX 2", "TV/TAPE", "CD", or "PHONO". If you don't want to assign the multichannel input, set to "- - - -".

5  **Press the [SETUP] button.**
The setup menu closes.

Notes:

- To listen to the component connected to the multichannel input, press the [AUDIO] button and select the "Audio selector" (see page 119).
- This procedure can also be performed on the AV receiver by using its [SETUP] button, arrow buttons, and [ENTER] button.

Speaker Settings

If you change these settings, you must run Audyssey MultEQ[®] XT Room Correction and Speaker Setup again (see page 61).

If the impedance of any speaker is 4 ohms or more but less than 6, set the minimum speaker impedance to 4 ohms.

To use bi-amping or bridging, you must change the "Speakers Type(FrontA)" or "Speakers Type(FrontB)" setting. For hookup information, see pages 23 to 26.

Notes:

- When bridging is used, the AV receiver is able to drive up to 7.2 speakers in the main room.
- When bi-amping is used, the AV receiver is able to drive up to 7.2 speakers in the main room.
- Before you change these settings, turn down the volume.

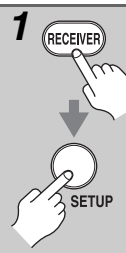
1  **Press the [RECEIVER] button, followed by the [SETUP] button.**
The main menu appears onscreen. If the main menu doesn't appear, make sure the appropriate external input is selected on your TV.

2

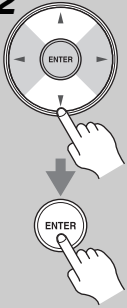

Use the Up and Down [▲]/[▼] buttons to select “2. Speaker Setup”, and then press [ENTER].

The “Speaker Setup” menu appears.

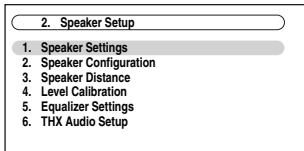

3

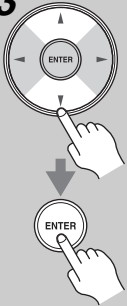

Use the Up and Down [▲]/[▼] buttons to select “1. Speaker Settings”, and then press [ENTER].

The “Speaker Settings” menu appears.

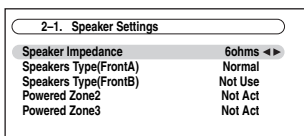

4



Use the Up and Down [▲]/[▼] buttons to select “Speaker Impedance”, and then use the Left and Right [◀]/[▶] buttons to select:

4ohms: Select if the impedance of any speaker is 4 ohms or more but less than 6.

6ohms: Select if the impedances of all speakers are between 6 and 16 ohms.

Note:

When bridging is used, “Speaker Impedance” setting is fixed at “8ohms”.

5

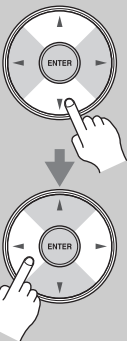

Use the Up and Down [▲]/[▼] buttons to select “Speakers Type(FrontA)”, and then use the Left and Right [◀]/[▶] buttons to select:

Normal: Select this if you’ve connected your front speakers A normally.

Bi-Amp: Select this if you’ve connected your front speakers A for bi-amped operation.

BTL: Select this if you’ve connected your front speakers A for bridged operation. The BTL indicator will appear on the display.

Notes:

- “Bi-Amp” and “BTL” cannot be selected if “Speakers Type(FrontB)” is set to “Bi-Amp” or “BTL”.
- Surround back speakers and Powered Zone 3 cannot be used if you select “Bi-Amp” or “BTL”.

6

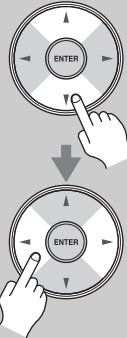

Use the Up and Down [▲]/[▼] buttons to select “Speakers Type(FrontB)”, and use the Left and Right [◀]/[▶] buttons to select:

Not Use: Select this if you’re not using speakers B.

Normal: Select this if you’ve connected your front speakers B normally.

Bi-Amp: Select this if you’ve connected your front speakers B for bi-amped operation.

BTL: Select this if you’ve connected your front speakers B for bridged operation. The BTL indicator will appear on the display.

Notes:

- “Bi-Amp” and “BTL” cannot be selected if “Speakers Type(FrontA)” is set to “Bi-Amp” or “BTL”.
- Front high speakers, front wide speakers and Powered Zone 2 cannot be used if you select other than “Not Use”.
- Surround back, front high, and front wide speakers and Powered Zone 3 cannot be used if you select “Bi-Amp” or “BTL”.

7



Press the [SETUP] button.

The setup menu closes.

Powered Zone 2/3

See “Setting the Powered Zone 2/3” on page 134.

Note:

This procedure can also be performed on the AV receiver by using its [SETUP] button, arrow buttons, and [ENTER] button.

TV Format Setup (European and Asian models)

For the onscreen setup menus to display properly, you must specify the TV system used in your area.

1 Press the [RECEIVER] button followed by the [SETUP] button.

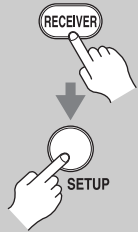

The main menu appears onscreen. If the main menu doesn't appear, make sure the appropriate external input is selected on your TV.

2 Use the Up and Down [▲]/[▼] buttons to select "6. Miscellaneous", and then press [ENTER].



The "Miscellaneous" menu appears.

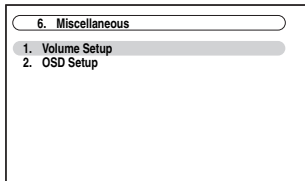

3 Use the Up and Down [▲]/[▼] buttons to select "2. OSD Setup", and then press [ENTER].

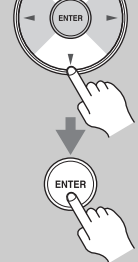

The "OSD Setup" menu appears.

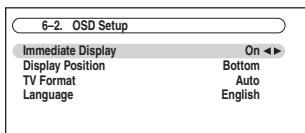

4 Use the Up and Down [▲]/[▼] buttons to select "TV Format", and then use the Left and Right [◀]/[▶] buttons to select:

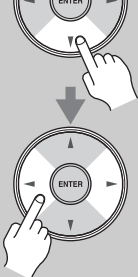

- Auto:** Select this to automatically detect the TV system from the video input signals.
- NTSC:** Select if the TV system in your area is NTSC.
- PAL:** Select if the TV system in your area is PAL.

5



When you've finished, press the [SETUP] button.

The setup menu closes.

Note:

This procedure can also be performed on the AV receiver by using its [SETUP] button, arrow buttons, and [ENTER] button.

FM/AM Frequency Step Setup

For FM/AM tuning to work properly, you must specify the FM/AM frequency step used in your area. Note that when this setting is changed, all radio presets are deleted.

1

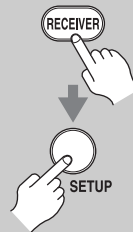

Press the [RECEIVER] button, followed by the [SETUP] button.

The main menu appears onscreen. If the main menu doesn't appear, make sure the appropriate external input is selected on your TV.

2

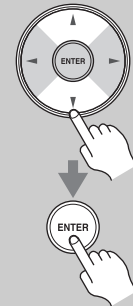

Use the Up and Down [▲]/[▼] buttons to select "7. Hardware Setup", and then press [ENTER].

The "Hardware Setup" menu appears.

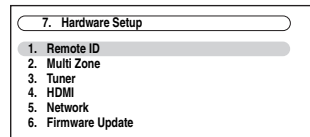

3

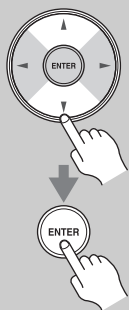

Use the Up and Down [▲]/[▼] buttons to select “3. Tuner”, and then press [ENTER].

The “Tuner” menu appears.
(North American models)

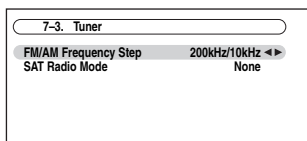

(European and Asian models)

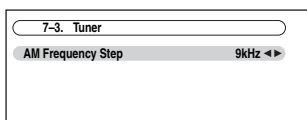

4



Use the Left and Right [◀]/[▶] buttons to select:

(North American models)

200kHz/10kHz:

Select if 200 kHz/10 kHz steps are used in your area.

50kHz/9kHz:

Select if 50 kHz/9 kHz steps are used in your area.

(European and Asian models)

10kHz: Select if 10 kHz steps are used in your area.

9kHz: Select if 9 kHz steps are used in your area.

5



Press the [SETUP] button.

The setup menu closes.

Note:

This procedure can also be performed on the AV receiver by using its [SETUP] button, arrow buttons, and [ENTER] button.

Changing the Input Display

If you connect an **RI**-capable Onkyo MiniDisc recorder, CD recorder, or RI Dock to the TV/TAPE IN/OUT jacks, or connect an RI Dock to the GAME IN or VCR/DVR IN jacks, for **RI** to work properly, you must change this setting.

This setting can only be changed on the AV receiver.

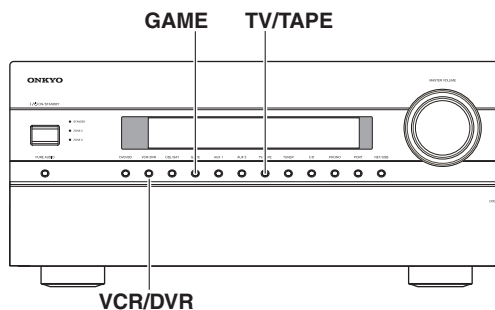

1

TV/TAPE



or

GAME



or

VCR/DVR



Press the [TV/TAPE], [GAME] or [VCR/DVR] input selector button so that “TV/TAPE”, “GAME” or “VCR/DVR” appears on the display.

TV/TAPE

GAME

VCR/DVR

2

TV/TAPE



or

GAME



or

VCR/DVR



(3 seconds)

Press and hold down the [TV/TAPE], [GAME] or [VCR/DVR] input selector button (about 3 seconds) to change the setting.

Repeat this step to select MD, CDR, or DOCK.

For the TV/TAPE input selector, the setting changes in this order:

TV/TAPE → MD → CDR
↑ DOCK ↓

For the GAME input selector, the setting changes in this order:

GAME ↔ DOCK

For the VCR/DVR input selector, the setting changes in this order:

VCR/DVR ↔ DOCK

Notes:

- DOCK can be selected for the TV/TAPE or GAME or VCR/DVR input selector, but not at the same time.
- Enter the appropriate remote control code before using the AV receiver’s remote controller for the first time (see page 141).

Audyssey MultEQ[®] XT Room Correction and Speaker Setup

With the supplied calibrated microphone, Audyssey MultEQ XT automatically determines the number of speakers connected, their size for purposes of bass management, optimum crossover frequencies to the subwoofer (if present), and distances from the primary listening position.

Audyssey MultEQ XT then removes the distortion caused by room acoustics by capturing room acoustical problems over the listening area in both the frequency and time domain. The result is clear, well-balanced sound for everyone. Enabling Audyssey MultEQ XT allows you to also use Audyssey Dynamic EQ[™], which maintains the proper octave-to-octave balance at any volume level (see page 102).

Before using this function, connect and position all of your speakers.

If Audyssey Dynamic EQ is set to “On”, Audyssey Dynamic Volume[™] becomes available.

About Audyssey Dynamic EQ

Audyssey Dynamic EQ solves the problem of deteriorating sound quality as volume is decreased by taking into account human perception and room acoustics. Dynamic EQ selects the correct frequency response and surround levels moment-by-moment at any user-selected volume setting. The result is bass response, tonal balance, and surround impression that remain constant despite changes in volume. Dynamic EQ combines information from incoming source levels with actual output sound levels in the room, a prerequisite for delivering a loudness correction solution. Audyssey Dynamic EQ works in tandem with Audyssey MultEQ XT to provide well-balanced sound for every listener at any volume level.

About Audyssey Dynamic Volume

Audyssey Dynamic Volume solves the problem of large variations in volume level between television programs, commercials, and between the soft and loud passages of movies. Dynamic Volume looks at the preferred volume setting by the user and then monitors how the volume of program material is being perceived by listeners in real time to decide whether an adjustment is needed. Whenever necessary, Dynamic Volume makes the necessary rapid or gradual adjustments to maintain the desired playback volume level while optimizing the dynamic range. Audyssey Dynamic EQ is integrated into Dynamic Volume so that as the playback volume is adjusted automatically, the perceived bass response, tonal balance, surround impression, and dialog clarity remain the same whether watching movies, flipping between television channels, or changing from stereo to surround sound content.

Measurement Positions

To create a listening environment in your home theater that all listeners will enjoy, Audyssey MultEQ XT takes measurements at up to eight positions within the listening area.

■ First measurement point

Also referred to as the Main Listening Position this refers to the most central position where one would normally sit within the listening environment. MultEQ XT uses the measurements from this position to calculate speaker distance, level, polarity, and the optimum crossover value for the subwoofer.

■ Second—eighth measurement positions

These are the other listening positions (i.e., the places where the other listeners will sit). You can measure up to eight positions.

The following examples show some typical home theater seating arrangements. Choose the one that best matches yours, and position the microphone accordingly when prompted.

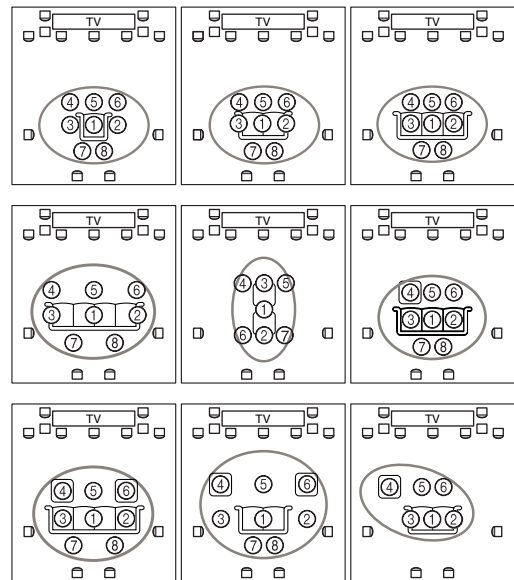

○ : listening area ①—⑧ : listening position

Using Audyssey MultEQ® XT

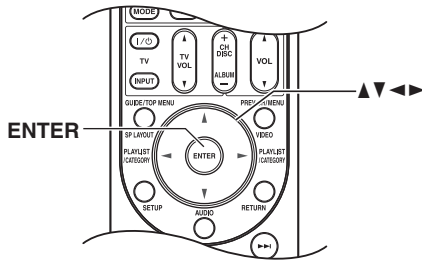
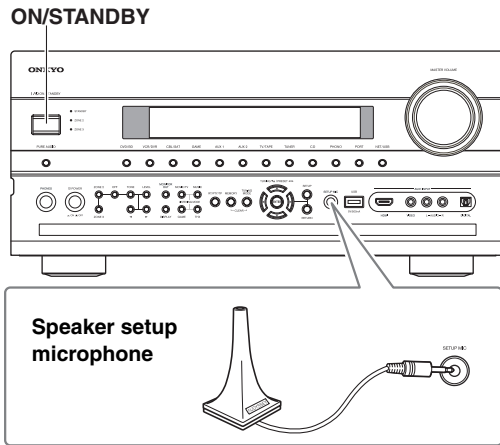

Notes:

- If any of your speakers is 4 ohms, change “Speaker Impedance” setting before running Audyssey MultEQ XT Room Correction and Speaker Setup (see page 57).
- If the AV receiver is muted, it will be unmuted automatically when Audyssey MultEQ XT Room Correction and Speaker Setup starts.
- Room correction and speaker setup can only be used with Speakers A.
- Room correction and speaker setup cannot be performed while a pair of headphones is connected, or Speakers B is selected.
- It takes about 30 minutes to complete the room correction and speaker setup for eight positions. Total measurement time varies depending on the number of speakers.
- Do not disconnect the speaker setup microphone during the room correction and speaker setup, unless you want to cancel the setup.
- Do not connect or disconnect any speakers during the room correction and speaker setup.

1

Turn on the AV receiver and the connected TV.

On the TV, select the input to which the AV receiver is connected.

2

Set the speaker setup microphone at the Main Listening Position ① (page 61), and connect it to the SETUP MIC jack.

The speaker setting menu appears.

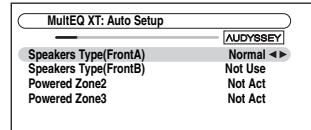

If you change these settings, refer to step 5 on “Speaker Settings” (page 57) or step 4 on “Setting the Powered Zone 2/3” (page 134).

3

When you’ve finished, press the [ENTER] button.

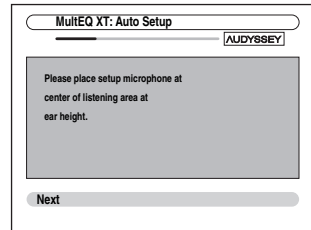

Notes:

- Before starting Audyssey MultEQ XT Room Correction and Speaker Setup, arrange the room and connect the speakers as you would for enjoying movies. Changes to the room after auto setup requires you run the auto setup again, as room EQ characteristics may have changed.
- When starting the room correction and speaker setup, do not stand between the speakers and microphone, and avoid obstacles blocking the path between speakers and microphone. This will produce inaccurate results.
- Position the microphone at ear height of a seated listener with the microphone tip pointed directly at the ceiling using a tripod. Do not hold the microphone in your hand during measurements as this will produce inaccurate results.

- Make the room as quiet as possible. Background noise can disrupt the room measurements. Close windows, silence cell phones, televisions, radios, air conditioners, fluorescent lights, home appliances, light dimmers, or other devices.
- Cell phones should be turned off or placed away from all audio electronics during the measurement process as Radio Frequency Interference (RFI) may cause measurement disruptions (even if the cell phone is not in use).

4

Press [ENTER].

The room correction and speaker setup starts.

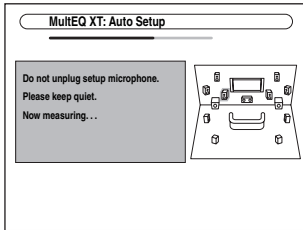

Test tones are played through each speaker as Audyssey MultEQ[®] XT Room Correction and Speaker Setup runs. This process takes a few minutes. Please refrain from talking during measurements and do not stand between speakers and the microphone.

5

The following screen appears.

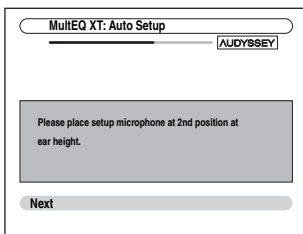

Place the setup microphone at the next position (page 61), and then press [ENTER].

Audyssey MultEQ XT performs more measurements. This takes a few minutes.

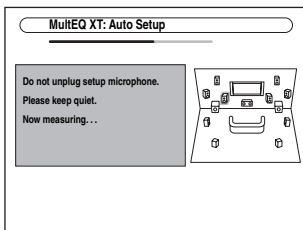

6

When prompted, place the setup microphone at the next position, and repeat step 5.

7

After the 3rd to the 8th measurement, the following screen appears.

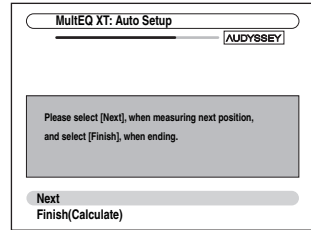

Use the Up and Down [▲]/[▼] buttons to select an option, and then press [ENTER].

Next:

Select “Next” to begin measuring the next measurement position. After the 8th measurement has been taken, the procedure automatically proceeds to step 8.

Finish(Calculate):

Select this if you don’t want to measure any more listening positions and are ready to calculate the results, then go to step 8.

8

When the measurements are complete, the following screen appears.

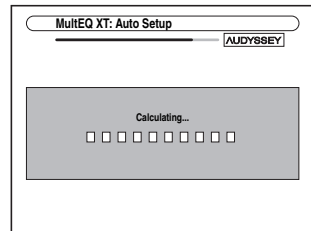

9

When the calculations are complete, the following screen appears.

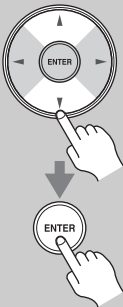
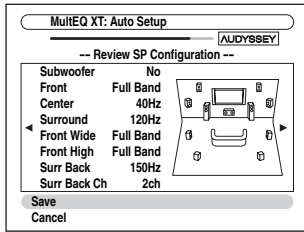

Use the Up and Down [▲]/[▼] buttons to select an option, and then press [ENTER].

The options are:

Save:

Save the calculated settings and exit the room correction and speaker setup.

Cancel:

Cancel the room correction and speaker setup.

Note:

You can view the calculated settings for the speaker configuration, speaker distances, and speaker levels by using the Left and Right [◀]/[▶] buttons.

Notes:

- When the room correction and speaker setup is complete, the “Equalizer Settings” (page 98) will be set to “Audyssey” and “Dynamic EQ” (page 102) will be set to “On”.
- You can cancel the Room Correction and Speaker Setup at any point in this procedure simply by disconnecting the setup microphone.

Error Messages

While the room correction and speaker setup is in progress, one of the following error messages may appear:

- Ambient noise is too high.

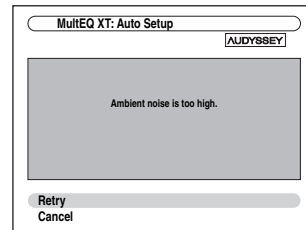

This message appears if the background noise is too loud and the measurements cannot be performed properly.

Remove the source of the noise and try again.

Retry: Return to the measured point immediately before and start set up again.

Cancel: Cancel the room correction and speaker setup.

- Speaker Detect Error

This message appears if a speaker is not detected. “Yes” means that a speaker was detected. “No” means that no speaker was detected.

Tip:

See “Speaker Configuration” (page 19) for appropriate settings.

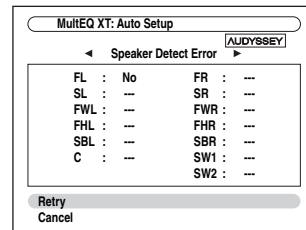

The front speaker has not been detected.

10

If you selected “Save”, the results are saved, and the following screen appears.

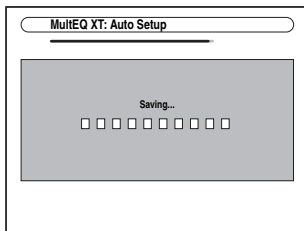

11

Disconnect the speaker setup microphone.

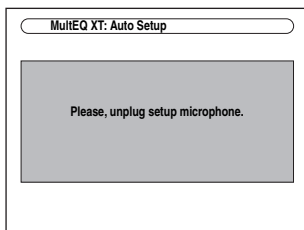

First Time Setup—Continued

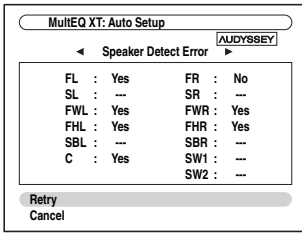

One of the front speakers has not been detected.

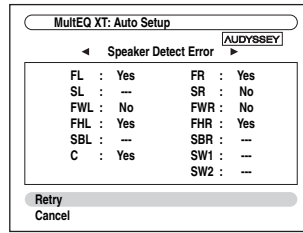

The front high speakers have been detected but the surround speakers haven't.

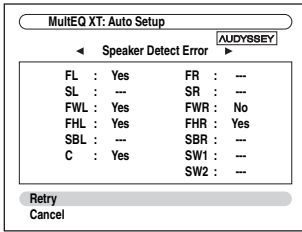

One of the front wide speakers has not been detected.

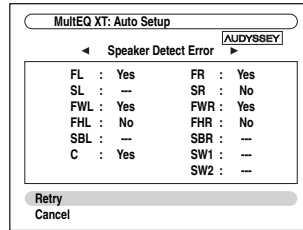

The front wide speakers have been detected but the surround speakers haven't.

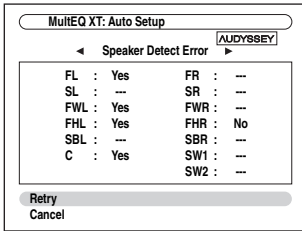

One of the front high speakers has not been detected.

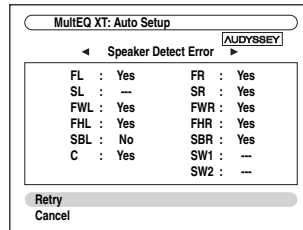

The right surround back speaker has been detected but the left surround back speaker hasn't.

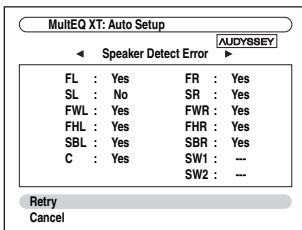

One of the surround speakers has not been detected.

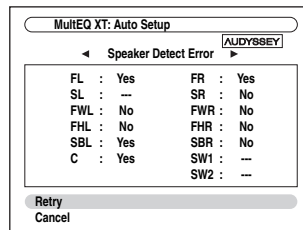

The left surround back speaker has been detected but the surround speaker hasn't.

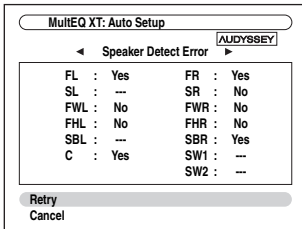

The surround back speakers have been detected but the surround speakers haven't.

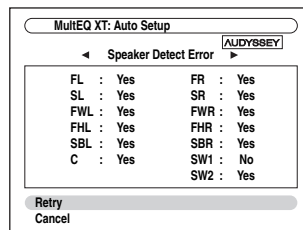

Subwoofer 2 has been detected but Subwoofer 1 has not.

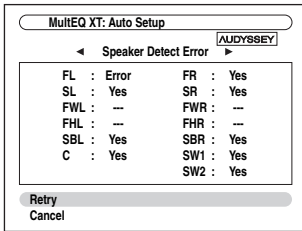

The speaker type detected does not match what was expected. The speaker may be incorrect type or broken. Please check that it is the correct speaker type.

❑ Speaker Matching Error!

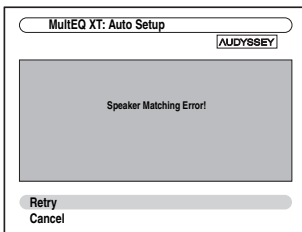

The number of speakers detected on the second measurement and later was different to the number detected on the first measurement.

Make sure speakers that could not be detected are connected properly.

Retry: Return to step 2 and try again.

Cancel: Cancel the room correction and speaker setup.

❑ Writing Error!

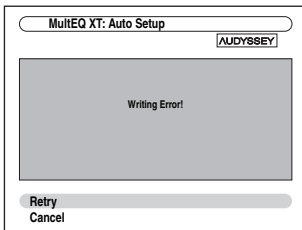

This message appears if saving fails.

Try saving again. If this message appears after 2 or 3 attempts, the AV receiver is probably malfunctioning. Contact your Onkyo dealer.

Retry: Return to step 2 and try again.

Cancel: Cancel the room correction and speaker setup.

Changing the Speaker Settings Manually

If you wish to make changes to the settings found during the room correction and speaker setup, follow the directions on pages 95 to 98.

Notes:

- Please note that THX recommends any THX main speakers be set to “80Hz(THX)”. If you set up your speakers using Audyssey MultiEQ XT Room Correction and Speaker Setup, please make sure manually that any THX speakers are set to 80 Hz (THX) crossover (see page 95).
- Sometimes due to the electrical complexities of subwoofers and the interaction with the room, THX recommends setting the level and the distance of the subwoofer manually.
- Sometimes due to interaction with the room, you may notice irregular results when setting the level and/or distance of the main speakers. If this happens, THX recommends setting them manually.

Using Powered Subwoofers

If you're using powered subwoofers that output very low-frequency sound at a low volume level, it may not be detected by Audyssey MultiEQ[®] XT Room Correction and Speaker Setup.

If the “Subwoofer” appears on the “Review SP Configuration” screen as “No”, increase the subwoofer's volume to the half-way point, set it to its highest crossover frequency, and then try running Audyssey MultiEQ XT Room Correction and Speaker Setup again. Note that if the volume is set too high and the sound distorts, detection issues may occur, so use an appropriate volume level. If the subwoofer has a low-pass filter switch, set it to Off or Direct. Refer to your subwoofer's instruction manual for details.

Basic Operations

Selecting the Input Source

This section explains how to select the input source (i.e., the AV component that you want to listen to or watch).

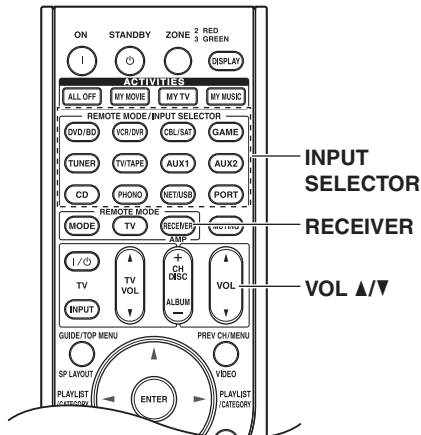
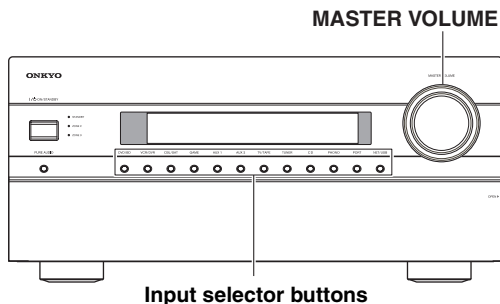

- 1 AV receiver**

Remote controller

Use the AV receiver's input selector buttons to select the input source.

To select the input source with the remote controller, press the [RECEIVER] button, and then press the INPUT SELECTOR buttons.
- 2**

Start playback on the source component.

When you select DVD or another video component, on your TV, you'll need to select the video input that's connected to the AV receiver's HDMI outputs, COMPONENT VIDEO MONITOR OUT or MONITOR OUT.

On some DVD players, you may need to turn on the digital audio output.
- 3 AV receiver**

Remote controller

To adjust the volume, use the MASTER VOLUME control, or the remote controller's VOL [▲]/[▼] button.

The volume can be set to $-\infty$ dB, -81.5 dB through $+18.0$ dB (relative display).

The AV receiver is designed for home theater enjoyment. It has a wide volume range, allowing precise adjustment.

The volume level can also be displayed as an absolute value. See "Volume Setup" on page 110.
- 4**

Select a listening mode and enjoy!

See "Using the Listening Modes" on page 81.

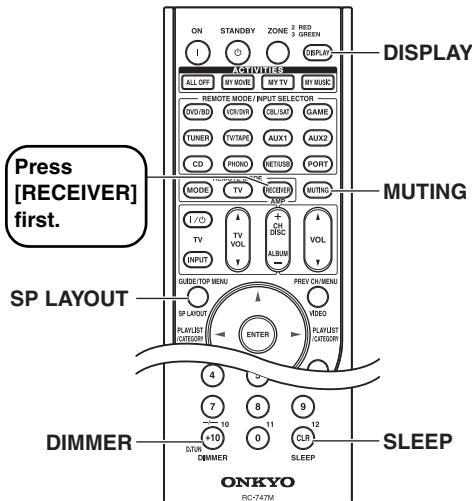
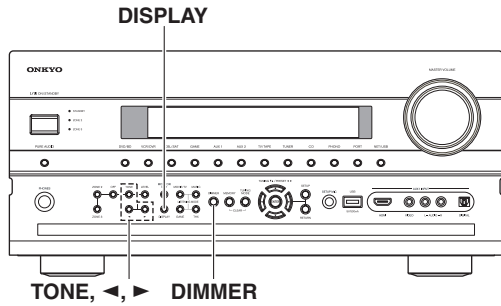

Adjusting the Bass & Treble

You can adjust the bass and treble for the front speakers, except when the Direct, Pure Audio or THX listening mode is selected.

1 AV receiver TONE 	<p>Press the [TONE] button repeatedly to select either “Bass” or “Treble” for each speaker or subwoofer.</p>
2 AV receiver 	<p>Use the Up [▶] and Down [◀] buttons to adjust.</p> <p>Tip: This procedure can also be performed on the remote controller by using [AUDIO] button (see page 117).</p>

■ Bass

You can boost or cut low-frequency sounds output by the front speakers from -10 dB to +10 dB in 2 dB steps.

■ Treble

You can boost or cut high-frequency sounds output by the front speakers from -10 dB to +10 dB in 2 dB steps.

Notes:

- This setting is not available when the multichannel Analog input is selected.
- The tone can be adjusted for Speakers A and Speakers B individually.
- To bypass the bass and treble tone circuits, select the Direct, Pure Audio or THX listening mode.

Displaying Source Information

You can display various information about the current input source as follows.

Remote controller 	<p>Press the [RECEIVER] button, and then press the [DISPLAY] button repeatedly to cycle through the available information.</p>

Note:

This procedure can also be performed on the AV receiver by using its [DISPLAY] button.

The following information can typically be displayed for input sources.

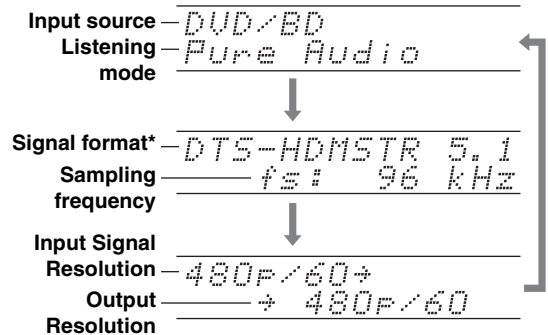

* If the input signal is analog, no format information is displayed. If the input signal is digital but not PCM, the sampling frequency is displayed. If the input signal is digital but not PCM, the signal format and the number of channels is displayed. For some digital input signals, including multichannel PCM, the signal format, number of channels, and sampling frequency is displayed. Information is displayed for about three seconds, then the previously displayed information reappears.

Setting the Display Brightness

You can adjust the brightness of the AV receiver's display.

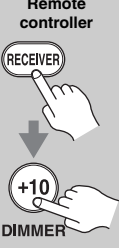

Remote controller

Press the [RECEIVER] button, and then press the [DIMMER] button repeatedly to select:

- Normal + VOLUME light on.
- Normal + VOLUME light off.
- Dim + VOLUME light off.
- Dimmer + VOLUME light off.

Alternatively, you can use the AV receiver's [DIMMER] button (**North American models**).

Muting the AV Receiver

You can temporarily mute the output of the AV receiver.



Remote controller

Press the [RECEIVER] button, and then press the [MUTING] button.

The output is muted and the MUTING indicator flashes on the display, as shown.



To unmute the AV receiver, press the [MUTING] button again, or adjust the volume.

The Mute function is cancelled when the AV receiver is set to Standby.

Tip:

You can specify how much the output is muted with the "Muting Level" setting (page 110).

Using the Sleep Timer

With the sleep timer, you can set the AV receiver to turn off automatically after a specified period.



Remote controller

Press the [RECEIVER] button, and then press the [SLEEP] button repeatedly to select the required sleep time.

The sleep time can be set from 90 to 10 minutes in 10 minute steps.

The SLEEP indicator appears on the display when the sleep timer has been set. The specified sleep time appears on the display for about five seconds, then the previous display reappears.

If you need to cancel the sleep timer, press the [SLEEP] button repeatedly until the SLEEP indicator disappears.

To check the time remaining until the AV receiver sleeps, press the [SLEEP] button. Note that if you press the [SLEEP] button while the sleep time is being displayed, you'll shorten the sleep time by 10 minutes.

Selecting Speaker Layout

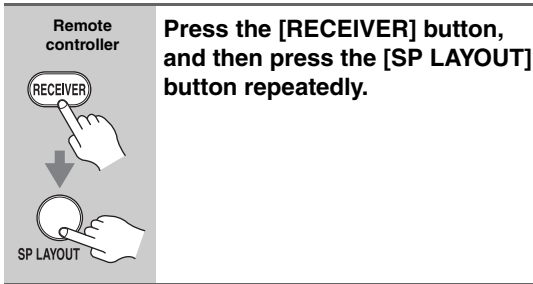

Front High or Front Wide Speakers

When “Speakers Type(FrontB)” setting is set to “Not Use”, you can select the priority of the use of Front High or Front Wide speakers.

Notes:

- Front High or Front Wide speakers cannot be selected in either of the following cases:
 1. “Speakers Type(FrontB)” is set to “Bi-Amp”, “BTL”, or “Normal” (page 57).
 2. Powered Zone 2 is being used (page 134).
- When the listening mode that doesn’t support Front High or Front Wide speakers is used, the setting cannot be selected.
- If you use surround back speakers, the speaker selection will be based on the combination of surround back and front high speakers, or surround back and front wide speakers.

Speakers A or Speakers B Configuration

When “Speakers Type(FrontB)” setting is set to other than “Not Use”, you can choose which of the speakers you want to use with the Speakers A or Speakers B configuration. Speakers A or B can be switched regardless of listening modes.

Notes:

- When you use Speakers B configuration, you cannot use front high and front wide speakers.
- When you use Speakers B configuration, listening modes that require front high or front wide speakers such as Dolby Pro Logic IIz Height or Audyssey Dynamic Surround Expansion™ are unavailable.
- While you are using Speakers B, you cannot use Audyssey MultEQ® XT Room Correction and Speaker Setup (Audyssey Dynamic EQ™ and Audyssey Dynamic Volume™).

Using Headphones

You can connect a pair of stereo headphones (1/4-inch phone plug) to the AV receiver’s PHONES jack for private listening, as shown.

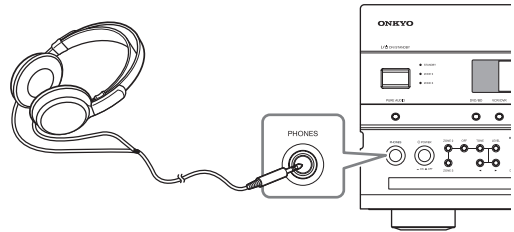

Notes:

- Always turn down the volume before connecting your headphones.
- While the headphones plug is inserted in the PHONES jack, the Headphone indicator, speaker/channel indicator FL and FR light up. (The Powered Zone 2/3 speakers are not turned off.)
- When you connect a pair of headphones, the listening mode is set to Stereo, unless it’s already set to Stereo, Mono, Direct, Pure Audio or DTS Surround Sensation.
- Listening mode automatically changes into DTS surround sensation when you connect a pair of headphones while DTS surround sensation mode is currently selected.
- The following listening modes can be used with headphones (the listening modes available also depend on the currently selected input source): Stereo, Direct, Pure Audio, Mono and DTS Surround Sensation.

Using Easy Macros

Using the Easy macro command in the Easy macro mode, you can sequentially operate Onkyo components with simple commands by simply pressing one button. These commands are user-specifiable (see page 150) and the default actions are described below. Press the ACTIVITIES buttons to start the Easy macro command. Once the AV receiver has entered the normal macro mode, all of the ACTIVITIES buttons will automatically switch to the normal macro mode. In this case, pressing the [ALL OFF] button will set only the AV receiver to Standby mode.

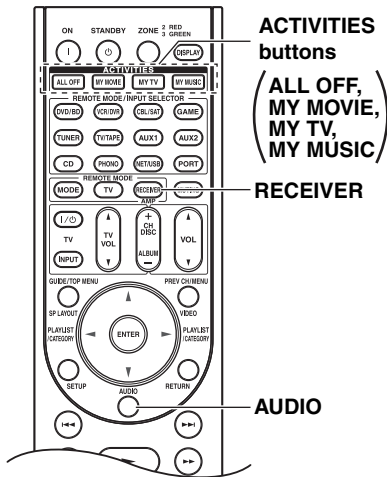

1

Press the [MY MOVIE], [MY TV], or [MY MUSIC] button.

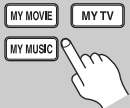

MY MOVIE (default):

1. The TV connected to the AV receiver is turned on.
2. The Onkyo DVD player connected to the AV receiver is turned on.
3. The AV receiver is turned on.
4. The input selector of the AV receiver is set to “DVD/BD”.
5. The player starts playback. *1

MY TV (default):

1. The TV connected to the AV receiver is turned on.
2. The cable set-top box connected to the AV receiver is turned on.
3. The AV receiver is turned on.
4. The input selector of the AV receiver is set to “CBL/SAT”. You can enjoy cable TV.

MY MUSIC (default):

1. The Onkyo CD player connected to the AV receiver is turned on.
2. The AV receiver is turned on.
3. The input selector of the AV receiver is set to “CD”.
4. The player starts playback.

Note:

Once you start the Easy macro command, you cannot use other ACTIVITIES buttons during the execution. If you want to operate other components halfway, press the [ALL OFF] to stop and press desired ACTIVITIES button.

2

Press the [ALL OFF] button.



1. The connected component stops and turns off.
2. The AV receiver turns off.
3. The TV connected to the AV receiver turns off (Standby). *2*3

*1. Depending on the start-up time of the DVD/BD player, the AV receiver may not activate this playback command. In this case, press the Play [▶] button on the remote controller.

*2. When [MY MUSIC] is selected, with the default settings, this will not be performed.

*3. With some televisions, the power may not be turned off (or enter standby).

Changing Source Component

When you want to operate the component that is not assigned as the source component, you can assign it as the source component. For the default assignment, see page 151.



The diagram shows a grid of remote control buttons. The top section is labeled "REMOTE MODE" and contains buttons for DVD/BD, VCR/DVR, CBL/SAT, GAME, TUNER, TV/TAPE, AUX1, AUX2, CD, PHONO, NET/USB, and PORT. A hand icon is shown pointing to the PORT button. Below this is a plus sign and the label "ACTIVITIES". Underneath are buttons for MY MOVIE, MY TV, and MY MUSIC. A hand icon is shown pointing to the MY MUSIC button. The text "(3 seconds)" is written below the MY MUSIC button.

While holding down the REMOTE MODE button, press and hold down the [MY MOVIE], [MY TV], or [MY MUSIC] button (about 3 seconds).

The ACTIVITIES buttons that you pressed flashes twice, indicating that the setting has been established.

Examples:

When you press the [MY MUSIC] button and want to start the Onkyo Cassette recorder, while holding down [TV/TAPE] button, press and hold down the [MY MUSIC] button (about 3 seconds) flashes twice.

Tip:

This procedure can also be performed via onscreen menu (see page 150).

Restoring Default

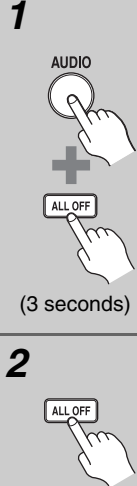

The diagram shows two steps. Step 1: A hand icon presses the AUDIO button, then a plus sign, then the ALL OFF button. The text "(3 seconds)" is written below. Step 2: A hand icon presses the ALL OFF button. The text "(3 seconds)" is written below.

1

While holding down the [AUDIO] button, press and hold down the [ALL OFF] button until the [ALL OFF] button lights up (about 3 seconds).

(3 seconds)

2

Release the [AUDIO] and [ALL OFF] buttons and press the [ALL OFF] button again. The [ALL OFF] button flashes twice.

Listening to the Radio

Using the Tuner

With the built-in tuner you can enjoy AM and FM radio stations. You can store your favorite stations as presets for quick selection.

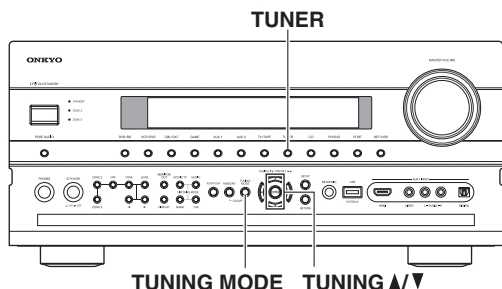

Listening to the Radio

TUNER



Use the **[TUNER]** input selector button to select either AM or FM. In this example, FM has been selected. Each time you press the **[TUNER]** button, the input source changes between AM and FM.

Band	Frequency
FM	87.5 MHz

(Actual display depends on country.)

Tuning into Radio Stations

Auto Tuning Mode

1

TUNING MODE



Press the **[TUNING MODE]** button so that the **AUTO** indicator appears on the display.

2

TUNING TA / PRESET



Press the **TUNING Up** or **Down [▲]/[▼]** buttons. Searching stops when a station is found.

When tuned into a station, the **TUNED** indicator appears. When tuned into a stereo FM station, the **FM STEREO** indicator appears on the display, as shown.

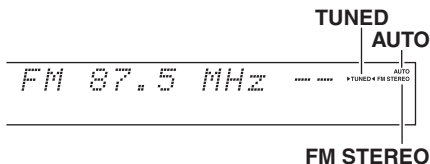

Manual Tuning Mode

1

TUNING MODE



Press the **[TUNING MODE]** button so that the **AUTO** indicator disappears from the display.

2

TUNING TA / PRESET



Press and hold the **TUNING Up** or **Down [▲]/[▼]** buttons. The frequency stops changing when you release the button. Press the buttons repeatedly to change the frequency one step at a time.

This model changes FM/AM frequency in 200k/10k (or 50k/9k) Hz steps.

In Manual Tuning mode, FM stations will be in mono.

Tuning into weak FM stereo stations

If the signal from a stereo FM station is weak, it may be impossible to get good reception. In this case, switch to Manual Tuning mode and listen to the station in mono.

Tuning into Stations by Frequency

You can tune into AM and FM stations directly by entering the appropriate frequency.

1

Remote controller



Press the **[TUNER]** button repeatedly to select AM or FM, followed by the **[D.TUN]** button.

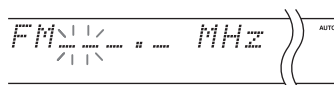

(Actual display depends on country.)

D.TUN



2

Within **8 seconds**, use the **number buttons** to enter the **frequency of the radio station**. For example, to tune to 87.5 (FM), press 8, 7, 5.

Presetting AM/FM Stations

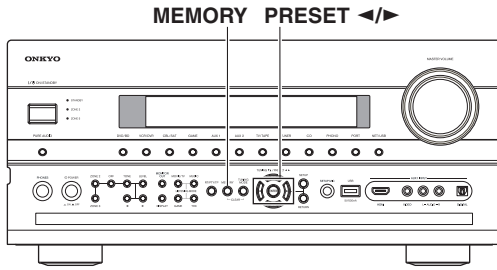

You can store a combination of up to 40 of your favorite AM/FM radio stations as presets.

- | | |
|---|---|
| 1 | Tune into the AM/FM station that you want to store as a preset. |
| 2
MEMORY
 | Press the [MEMORY] button.
The preset number flashes.

AM 530kHz |
| 3
TUNING PA / PRESET </> | While the preset number is flashing (about 8 seconds), use the PRESET [</>] buttons to select a preset from 1 through 40. |
| 4
MEMORY
 | Press the [MEMORY] button again to store the station or channel.
The station or channel is stored and the preset number stops flashing.
Repeat this procedure for all of your favorite AM/FM radio stations. |

Note:
You can name your radio presets for easy identification (see page 105). Its name is displayed instead of the band and frequency.

Selecting Presets

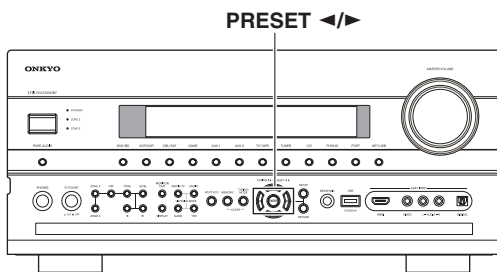

AV receiver
TUNING PA / PRESET </>



OR
Remote controller



OR
Remote controller



To select a preset, use the PRESET [</>] buttons, or the remote controller's CH [+/-] button.

You can also use the remote controller's number buttons to select a preset directly.

Deleting Presets

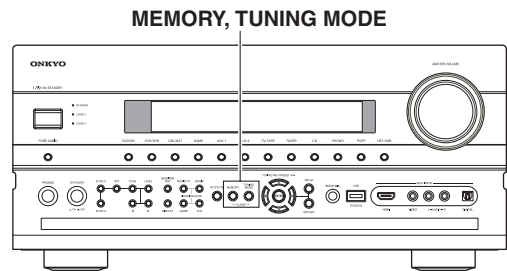

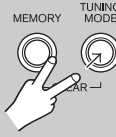
- | | |
|--|---|
| 1 | Select the preset that you want to delete.
See the previous section. |
| 2
MEMORY
TUNING MODE
 | While holding down the [MEMORY] button, press the [TUNING MODE] button.
The preset is deleted and its number disappears from the display. |

Using RDS (European models)

RDS only works in areas where RDS broadcasts are available.

When tuned into an RDS station, the RDS indicator appears.

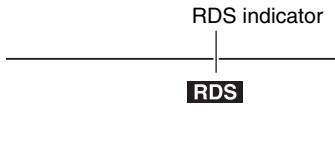

■ What is RDS?

RDS stands for *Radio Data System* and is a method of transmitting data in FM radio signals. It was developed by the European Broadcasting Union (EBU) and is available in most European countries. Many FM stations use it these days. In addition to displaying text information, RDS can also help you find radio stations by type (e.g., news, sport, rock, etc.).

The AV receiver supports four types of RDS information:

PS (Program Service)

When tuned to an RDS station that's broadcasting PS information, the station's name will be displayed. Pressing the [DISPLAY] button will display the frequency for 3 seconds.

RT (Radio Text)

When tuned to an RDS station that's broadcasting text information, the text will be shown on the display (see page 76).

PTY (Program Type)

This allows you to search for RDS radio stations by type (see page 76).

TP (Traffic Program)

This allows you to search for RDS radio stations that broadcast traffic information (see page 76).

Notes:

- In some cases, the text characters displayed on the AV receiver may not be identical to those broadcast by the radio station. Also, unexpected characters may be displayed when unsupported characters are received. This is not a malfunction.
- If the signal from an RDS station is weak, RDS data may be displayed intermittently or not at all.

RDS Program Types (PTY)

Type	Display
None	None
News reports	News
Current affairs	Affairs
Information	Info
Sport	Sport
Education	Educate
Drama	Drama
Culture	Culture
Science and technology	Science
Varied	Varied
Pop music	Pop M
Rock music	Rock M
Middle of the road music	Easy M
Light classics	Light M
Serious classics	Classics
Other music	Other M
Weather	Weather
Finance	Finance
Children's programmes	Children
Social affairs	Social
Religion	Religion
Phone in	Phone In
Travel	Travel
Leisure	Leisure
Jazz music	Jazz
Country music	Country
National music	Nation M
Oldies music	Oldies
Folk music	Folk M
Documentary	Document
Alarm test	TEST
Alarm	Alarm!

Listening to the Radio—Continued

When tuned to an RDS station that's broadcasting text information, the text can be displayed.

Displaying Radio Text (RT)

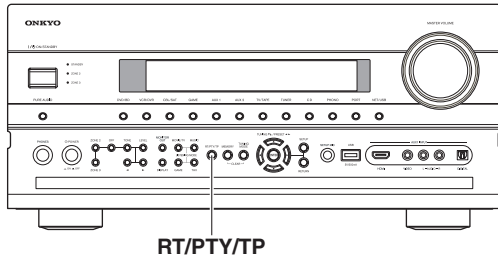

RT/PTY/TP



Press the [RT/PTY/TP] button once.

The RT information scrolls across the display.

Notes:

- The message “Waiting” may appear while the AV receiver waits for the RT information.
- If the message “No Text Data” appears on the display, no RT information is available.

Finding Stations by Type (PTY)

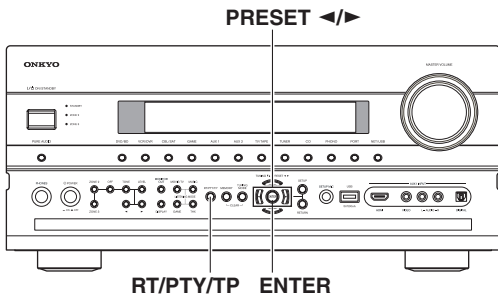

RT/PTY/TP ENTER

You can search for radio stations by type.

1

RT/PTY/TP



Press the [RT/PTY/TP] button twice.

The current program type appears on the display.

2

TUNING ▸ / PRESET ◀



Use the PRESET [◀]/[▶] buttons to select the type of program you want.

See the table on page 75.

3



To start the search, press [ENTER].

The AV receiver searches until it finds a station of the type you specified, at which point it stops briefly before continuing with the search.

4



When a station you want to listen to is found, press [ENTER].

If no stations are found, the message “Not Found” appears.

Listening to Traffic News (TP)

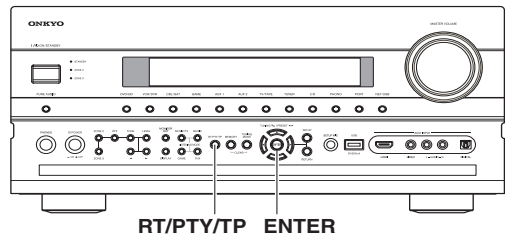

RT/PTY/TP ENTER

You can search for stations that broadcast traffic news.

1

RT/PTY/TP



Press the [RT/PTY/TP] button three times.

If the current radio station is broadcasting TP (Traffic Program), “[TP]” will appear on the display, and traffic news will be heard as and when it's broadcast. If “TP” without square brackets appears, this means that the station is not broadcasting TP.

2



To locate a station that is broadcasting TP, press [ENTER].

The AV receiver searches until it finds a station that's broadcasting TP. If no stations are found, the message “Not Found” appears.

Universal Port Option UP-A1 Dock for iPod

About the UP-A1 Dock

With the UP-A1 Dock (sold separately), you can easily play the music, photo, or movie stored on your Apple iPod through the AV receiver and enjoy great sound. You can use the AV receiver's remote controller to operate your iPod.

For the latest information on the Dock, see the Onkyo Web site at: <http://www.onkyo.com>

iPod adapter

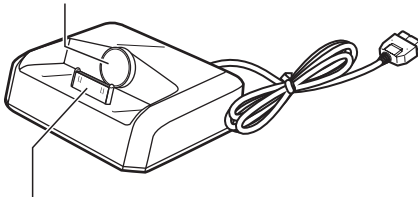

Dock connector

Compatible iPod models

For information about which iPod models are supported by the UP-A1 Dock, see the UP-A1 Dock instruction manual.

Note:

Before using the UP-A1 Dock, update your iPod with the latest software, available from the Apple Web site.

Function Overview

■ Basic Operation

Note:

The AV receiver may take several seconds to startup, so you might not hear the first few seconds of the first song.

• Auto Power On Function

If you start iPod playback while the AV receiver is on Standby, the AV receiver will automatically turn on and select your iPod as the input source.

• Direct Change Function

If you start iPod playback while listening to another input source, the AV receiver will automatically select your iPod as the input source.

• Using the AV receiver's Remote Controller

You can use the AV receiver's remote controller to control basic iPod functions.

Operating Notes:

- Functionality depends on your iPod model and generation.
- Before selecting a different input source, stop iPod playback to prevent the AV receiver from selecting the iPod input source by mistake.
- If any accessories are connected to your iPod, the AV receiver may not be able to select the input source properly.
- While your iPod is in the UP-A1 Dock, its volume control has no effect. If you adjust your iPod models volume control while it's in the UP-A1 Dock, make sure it's not set too high before you reconnect your headphones.
- The Auto Power On function will not work if you set your iPod in the UP-A1 Dock while it is playing.
- When Zone 2 or 3 is turned on, you can't use Auto Power On and Direct Change functions.

■ Using Your iPod models Alarm Clock

You can use your iPod models Alarm Clock function to automatically turn on your iPod and the AV receiver at a specified time. The AV receiver's input source will automatically be set to the [PORT] selector.

Notes:

- To use this function, your iPod must be in the UP-A1 Dock, and the UP-A1 Dock must be connected to the AV receiver.
- When you use this function, be sure to set the AV receiver's volume control to a suitable level.
- The AV receiver may take several seconds to startup, so you might not hear the first few seconds of the first song.
- When Zone 2 or 3 is turned on, you can't use this function.
- You cannot use this function for sound effects on your iPod.

■ Charging Your iPod models Battery

The UP-A1 Dock charges your iPod models battery while your iPod is in the UP-A1 Dock and connected to the UNIVERSAL PORT jacks on the AV receiver. While your iPod is seated in the UP-A1 Dock, its battery will be charged when the AV receiver is set to "On" or "Standby".

Note:

When UP-A1 Dock that seated iPod is connected, the power consumption on standby mode slightly increases.

Controlling iPod

By pressing the REMOTE MODE button that's been programmed with the remote control code for your Dock, you can control your iPod in the Dock with the following buttons.

The [PORT] button is preprogrammed with the remote control code for controlling a Dock with Universal Port connector.

For details on entering a remote control code, see page 141.

When Using a Dock with Universal Port connector:

- Connect the Dock to the UNIVERSAL PORT jack.
- See the Dock's instruction manual for more information.

You can control your iPod when "PORT" is selected as the input source.

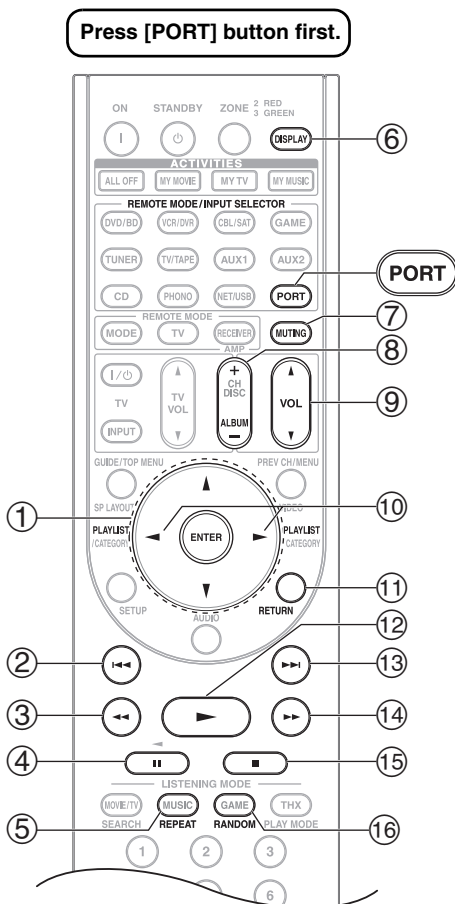

Notes:

- With some iPod models and generations, certain buttons may not work as expected.
- For detailed operation of the iPod, please refer to the instruction manual.

- ① **Arrow [▲]/[▼] and ENTER buttons**
Used to navigate menus and select items.
- ② **Previous [◀◀] button**
Restarts the current song. Press it again to select the previous song.
- ③ **Fast Reverse [◀◀] button**
Press and hold to fast reverse.
- ④ **Pause [⏸] button**
Pauses playback. Press it again to start playback.
- ⑤ **REPEAT button**
Used with the repeat function.
- ⑥ **DISPLAY button**
Select Standard or Extended mode^{*1}.
- ⑦ **MUTING button (69)**
Mutes or unmutes the AV receiver.
- ⑧ **ALBUM +/- button**
Selects the next or previous album.
- ⑨ **VOL [▲]/[▼] button (67)**
Adjusts the volume of the AV receiver.
- ⑩ **PLAYLIST [◀]/[▶] buttons**
Selects the previous or next playlist on the iPod.
- ⑪ **RETURN button**
Exits the menu or returns to the previous menu.
- ⑫ **Play [▶] button**
Starts playback. If the component is off, it will turn on automatically.
- ⑬ **Next [▶▶] button**
Selects the next song.
- ⑭ **Fast Forward [▶▶▶] button**
Press and hold to fast forward.
- ⑮ **Stop [■] button**
Stops playback and displays a menu.
- ⑯ **RANDOM button**
Used with the shuffle function.

*1

Standard mode

Nothing is displayed on your TV and you navigate and select your contents by using your iPod's display. Only this mode can playback the video.

Extended mode

Playlists (artists, albums, songs, and so on) are displayed on your TV, and you can navigate and select your music while looking at your TV.

Notes:

- In Extended mode, the playback will be continued even if the AV receiver is turned off.
- In Extended mode, you cannot operate your iPod directly.
- In Extended mode, it may take some time to acquire the contents.
- In Extended mode, video contents can not display on your TV.

Status messages

□ PORT Reading

The AV receiver is checking the connection with the dock.

□ PORT Not Support

The AV receiver do not support the connected dock.

□ PORT UP-A1

UP-A1 Dock is connected.

Notes:

- The AV receiver displays the message “UP-A1” for several seconds after recognizing the UP-A1.
- When the status message is not displayed on the AV receiver’s display, check the connection to your iPod.

Recording

This section explains how to record the selected input source to a component with recording capability, and how to record audio and video from different sources.

Notes:

- The surround sound and DSP listening modes cannot be recorded.
- Copy-protected DVDs cannot be recorded.
- Sources connected to a digital input cannot be recorded. Only analog inputs can be recorded.
- DTS signals will be recorded as noise, so don't attempt analog recording of DTS CDs or LDs.
- While the listening mode is set to Pure Audio, no image is provided because the power is turned off for the video circuit. If you want to make recordings, select other listening mode.

AV Recording

Audio sources can be recorded to a recorder (e.g., cassette deck, CDR, MD) connected to the TV/TAPE OUT jack. Video sources can be recorded to a video recorder (e.g., VCR, DVD recorder) connected to the VCR/DVR OUT jack. See pages 32 to 47 for hookup information.

1	<p>Use the input selector buttons to select the source that you want to record.</p> <p>You can watch the source while recording. The AV receiver's MASTER VOLUME control has no effect on recording.</p>
2	<p>On your recorder, start recording.</p>
3	<p>On the source component, start playback.</p> <p>If you select another input source during recording, that input source will be recorded.</p>

Recording Separate AV Sources

Here you can record audio and video from completely separate sources, allowing you to overdub audio onto your video recordings. This function takes advantage of the fact that when an audio-only input source (i.e., TV/TAPE, TUNER, CD or PHONO) is selected, the video input source remains unchanged.

In the following example, audio from the CD player connected to the CD IN, and video from the camcorder connected to the AUX 1 INPUT VIDEO jack are recorded by the VCR connected to the VCR/DVR OUT jacks.

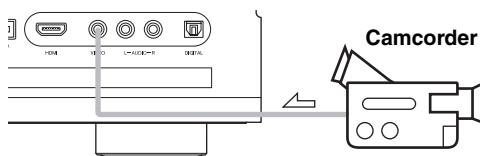

↖ : video signal
↙ : audio signal

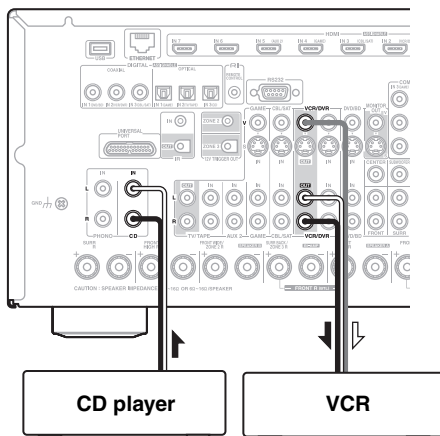

1	<p>Prepare the camcorder and CD player for playback.</p>
2	<p>Prepare the VCR for recording.</p>
3	<p>Press the [AUX 1] input selector button.</p>
4	<p>Press the [CD] input selector button.</p> <p>This selects the CD player as the audio source, but leaves the camcorder as the video source.</p>
5	<p>Start recording on the VCR and start playback on the camcorder and CD player.</p> <p>The video from the camcorder and the audio from the CD player are recorded by the VCR.</p>

Using the Listening Modes

Selecting Listening Modes

See “About the Listening Modes” on page 89 for detailed information about the listening modes.

- The Dolby Digital and DTS listening modes can only be selected if your DVD player is connected to the AV receiver with a digital audio connection (coaxial, optical, or HDMI).
- The listening modes you can select depend on the format of the input signal. To check the format, see “Displaying Source Information” on page 68.
- While a pair of headphones is connected, you can only select the Pure Audio, Mono, Direct, DTS Surround Sensation, or Stereo listening mode.

Selecting on the AV receiver

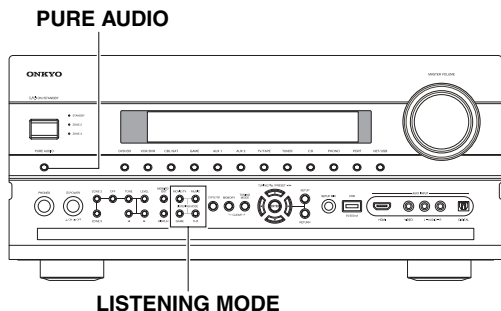

■ [PURE AUDIO] button

This button selects the Pure Audio listening mode. When this mode is selected, the AV receiver’s display is turned off and only video signals input through HDMI IN can be output. Pressing this button again will select the previous listening mode. This listening mode is not available while you are using Zone 2 (“Not Available” will appear on the display). If you turn Zone 2 on during the Pure Audio listening mode, the listening mode will change to Direct.

■ LISTENING MODE buttons

[MOVIE/TV] button

This button selects the listening modes intended for use with movies and TV.

[MUSIC] button

This button selects the listening modes intended for use with music.

[GAME] button

This button selects the listening modes intended for use with video games.

[THX] button

This button selects the THX listening modes.

Selecting with the Remote Controller

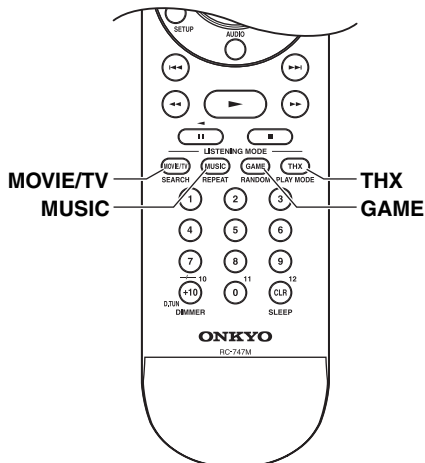

Remote controller



Press the [RECEIVER] button, and then press the LISTENING MODE button repeatedly to select the listening mode.

■ LISTENING MODE buttons

[MOVIE/TV] button

This button selects the listening modes intended for use with movies and TV.

[MUSIC] button

This button selects the listening modes intended for use with music.

[GAME] button

This button selects the listening modes intended for use with video games.

[THX] button

This button selects the THX listening modes.

Listening Modes Available for Each Source Format

The Speaker layout illustration shows which speakers are set to active in the “Speaker Configuration” setting (see page 95).

The LISTENING MODE button illustration shows that listening modes can be selected.

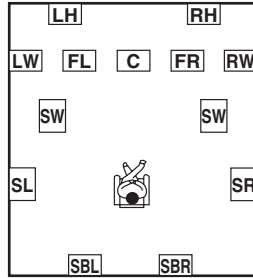

- FL** : Front left speaker
- LW** : Front wide left speaker
- LH** : Front high left speaker
- C** : Center speaker
- RH** : Front high right speaker
- RW** : Front wide right speaker
- FR** : Front right speaker
- SR** : Surround right speaker
- SBR** : Surround back right speaker
- SBL** : Surround back left speaker
- SL** : Surround left speaker
- SW** : Subwoofer

- C** : active in the speaker settings
- C** : non-active in the speaker settings

Mono/Multiplex Sources

✓: Available Listening Modes

Listening Mode	Button	Speaker layout			
Pure Audio*5		✓	✓	✓	✓
Direct		✓	✓	✓	✓
Stereo		✓	✓	✓	✓
Mono		✓	✓	✓	✓
Orchestra				✓	✓*1*2
Unplugged				✓	✓*1*2
Studio-Mix				✓	✓*1*2
TV Logic				✓	✓*1*2
Game-RPG				✓	✓*1*2
Game-Action				✓	✓*1*2
Game-Rock				✓	✓*1*2
Game-Sports				✓	✓*1*2
All Ch Stereo			✓	✓	✓*1*2
Full Mono			✓	✓	✓*1*2
T-D (Theater-Dimensional)		✓	✓	✓	✓
DTS Surround Sensation		✓	✓	✓	✓

Notes:

- *1 For 7ch output, output can be switched between Front high or Front wide speakers by pressing the [SP LAYOUT] button (depending on the “Speaker Configuration” setting (see page 95)).
- *2 For 9ch output, output can be switched between the combination of Surround back and Front high, or Surround back and Front wide speakers by pressing the [SP LAYOUT] button.
- *5 This listening mode is not available while you are using Zone 2 (“Not Available” will appear on the display). If you turn Zone 2 on during the Pure Audio listening mode, the listening mode will change to Direct.
- Available sampling rate for PCM input signal is 32/44.1/48/88.2/96/176.4/192kHz.
- The listening modes cannot be selected with some source formats.

Using the Listening Modes—Continued

Stereo Source (1/2)

✓: Available Listening Modes

Listening Mode	Button	Speaker layout			
Pure Audio ^{*5}		✓	✓	✓	✓
Direct		✓	✓	✓	✓
Stereo		✓	✓	✓	✓
Mono		✓	✓	✓	✓
PLII/PLIIX Movie ^{*3}			✓	✓	✓
PLII/PLIIX Music ^{*3}			✓	✓	✓
PLII/PLIIX Game ^{*3}			✓	✓	✓
PLIIZ Height					✓
Neo:6 Cinema			✓	✓	✓
Neo:6 Music			✓	✓	✓
Neural Surround			✓	✓	✓
Neural Digital Music			✓	✓	✓
PLII/PLIIX Movie ^{*3} THX Cinema				✓	✓
PLII/PLIIX Movie Audyssey DSX ^{*4}					✓ ^{*2}
PLIIZ Height THX Cinema					✓
Neo:6 Cinema THX Cinema				✓	✓
Neo:6 Cinema Audyssey DSX ^{*4}					✓ ^{*2}
Neural THX Cinema				✓	✓
PLII/PLIIX Music ^{*3} THX Music				✓	✓
PLII/PLIIX Music Audyssey DSX ^{*4}					✓ ^{*2}
PLIIZ Height THX Music					✓
Neo:6 Music THX Music				✓	✓
Neo:6 Music Audyssey DSX ^{*4}					✓ ^{*2}
Neural Digital Music THX Music				✓	✓

Using the Listening Modes—Continued

Stereo Source (2/2)

✓: Available Listening Modes

Listening Mode	Button	Speaker layout			
PLII/PLIIX Game^{*3} THX Games				✓	✓
PLII/PLIIX Game Audyssey DSX^{*4}					✓ ^{*2}
PLIIZ Height THX Games					✓
Neural THX Games				✓	✓
PLII Game THX Ultra2 Games					✓
PLIIZ Height THX Ultra2 Games					✓
Orchestra				✓	✓ ^{*1*2}
Unplugged				✓	✓ ^{*1*2}
Studio-Mix				✓	✓ ^{*1*2}
TV Logic				✓	✓ ^{*1*2}
Game-RPG				✓	✓ ^{*1*2}
Game-Action				✓	✓ ^{*1*2}
Game-Rock				✓	✓ ^{*1*2}
Game-Sports				✓	✓ ^{*1*2}
All Ch Stereo			✓	✓	✓ ^{*1*2}
Full Mono			✓	✓	✓ ^{*1*2}
T-D (Theater-Dimensional)		✓	✓	✓	✓
Neo:6 Cinema DTS Surround Sensation		✓	✓	✓	✓
Neo:6 Music DTS Surround Sensation		✓	✓	✓	✓

Notes:

- *1 For 7ch output, output can be switched between Front high or Front wide speakers by pressing the [SP LAYOUT] button (depending on the “Speaker Configuration” setting (see page 95)).
- *2 For 9ch output, output can be switched between the combination of Surround back and Front high, or Surround back and Front wide speakers by pressing the [SP LAYOUT] button.
- *3 If there are no surround back speakers, or Powered Zone 3 is being used, Dolby Pro Logic II is used.
- *4 • This listening mode can be selected only when all the following conditions are satisfied:
 - a. Center speaker is connected to the AV receiver.
 - b. Either of Front High speakers or Front Wide speakers is connected to the AV receiver.
 • Output can be switched between Front high or Front wide speakers by pressing the [SP LAYOUT] button (depending on the “Speaker Configuration” setting (see page 95)).
- *5 This listening mode is not available while you are using Zone 2 (“Not Available” will appear on the display). If you turn Zone 2 on during the Pure Audio listening mode, the listening mode will change to Direct.
 - Available sampling rate for PCM input signal is 32/44.1/48/88.2/96/176.4/192kHz.
 - The listening modes cannot be selected with some source formats.

Using the Listening Modes—Continued

5.1 channel Sources (1/3)

✓: Available Listening Modes

Listening Mode	Button	Speaker layout			
Pure Audio ^{*5}		✓	✓	✓	✓
Direct		✓	✓	✓	✓
Stereo		✓	✓	✓	✓
Mono		✓	✓	✓	✓
DolbyDigital/ DolbyDigital Plus/TrueHD/ Multichannel/ DTS/ DTS 96/24 ^{*6} / DTS Express/ DTS-HD High Resolution Audio/DTS-HD Master Audio/ DSD ^{*3}			✓	✓	✓
PLIIX Movie					✓
PLIIX Music					✓
PLIIZ Height					✓
DolbyEX					✓
DolbyEX Audyssey DSX					✓ ^{*2}
Neo:6					✓
Neo:6 Audyssey DSX					✓ ^{*2}
Neural Surround					✓
Audyssey DSX ^{*4}					✓
THX Cinema				✓	✓
PLIIX Movie THX Cinema					✓
PLIIX Movie Audyssey DSX					✓ ^{*2}
PLIIZ Height THX Cinema					✓
Neo:6 THX Cinema					✓
Neural THX Cinema					✓
THX Music				✓	✓

Using the Listening Modes—Continued

5.1 channel Sources (2/3)

✓: Available Listening Modes

Listening Mode	Button	Speaker layout			
PLIIx Music THX Music					✓
PLIIx Music Audyssey DSX					✓ ^{*2}
PLIIz Height THX Music					✓
Neo:6 THX Music					✓
Neural THX Music					✓
THX Games				✓	✓
PLIIz Height THX Games					✓
Neo:6 THX Games					✓
Neural THX Games					✓
THX Surround EX					✓
THX Ultra2 Cinema					✓
PLIIz THX Ultra2 Cinema					✓
THX Ultra2 Music					✓
PLIIz THX Ultra2 Music					✓
THX Ultra2 Games					✓
PLIIz THX Ultra2 Games					✓
Orchestra				✓	✓ ^{*1*2}
Unplugged				✓	✓ ^{*1*2}
Studio-Mix				✓	✓ ^{*1*2}
TV Logic				✓	✓ ^{*1*2}
Game-RPG				✓	✓ ^{*1*2}
Game-Action				✓	✓ ^{*1*2}
Game-Rock				✓	✓ ^{*1*2}
Game-Sports				✓	✓ ^{*1*2}
All Ch Stereo			✓	✓	✓ ^{*1*2}
Full Mono			✓	✓	✓ ^{*1*2}

Using the Listening Modes—Continued

5.1 channel Sources (3/3)

✓: Available Listening Modes

Listening Mode	Button	Speaker layout			
T-D (Theater-Dimensional)		✓	✓	✓	✓
DTS Surround Sensation		✓	✓	✓	✓

Notes:

- *1 For 7ch output, output can be switched between Front high or Front wide speakers by pressing the [SP LAYOUT] button (depending on the “Speaker Configuration” setting (see page 95)).
- *2 For 9ch output, output can be switched between the combination of Surround back and Front high, or Surround back and Front wide speakers by pressing the [SP LAYOUT] button.
- *3 AV receiver can input the DSD signal from HDMI IN. Setting the output setting on the player side to PCM might obtain a better sound according to the player. In that case, set the output setting on the player side to PCM.
- *4 • This listening mode can be selected only when all the following conditions are satisfied:
 - a. Center speaker is connected to the AV receiver.
 - b. Either of Front High speakers or Front Wide speakers is connected to the AV receiver.
 - Output can be switched between Front high or Front wide speakers by pressing the [SP LAYOUT] button (depending on the “Speaker Configuration” setting (see page 95)).
- *5 This listening mode is not available while you are using Zone 2 (“Not Available” will appear on the display). If you turn Zone 2 on during the Pure Audio listening mode, the listening mode will change to Direct.
- *6 Depending on the input source, DTS is used.
 - Available sampling rate for PCM input signal is 32/44.1/48/88.2/96/176.4/192kHz.
 - The listening modes cannot be selected with some source formats.

Using the Listening Modes—Continued

7.1 channel Sources

✓: Available Listening Modes

Listening Mode	Button	Speaker layout			
Pure Audio*5		✓	✓	✓	✓
Direct		✓	✓	✓	✓
Stereo		✓	✓	✓	✓
Mono		✓	✓	✓	✓
Multichannel/ Dolby Digital Plus/TrueHD/ DTS-HD High Resolution Audio/DTS-HD Master Audio/ DTS-ES Discrete*6/ DTS-ES Matrix*6			✓	✓	✓*3
PLIIz Height					✓
Audyssey DSX*4					✓*2
THX Cinema				✓	✓
PLIIz Height THX Cinema					✓
THX Music				✓	✓
PLIIz Height THX Music					✓
THX Games				✓	✓
PLIIz Height THX Games					✓
Orchestra				✓	✓*1*2
Unplugged				✓	✓*1*2
Studio-Mix				✓	✓*1*2
TV Logic				✓	✓*1*2
Game-RPG				✓	✓*1*2
Game-Action				✓	✓*1*2
Game-Rock				✓	✓*1*2
Game-Sports				✓	✓*1*2
All Ch Stereo			✓	✓	✓*1*2
Full Mono			✓	✓	✓*1*2
T-D (Theater- Dimensional)		✓	✓	✓	✓
DTS Surround Sensation		✓	✓	✓	✓

Notes:

- *1 For 7ch output, output can be switched between Front high or Front wide speakers by pressing the [SP LAYOUT] button (depending on the “Speaker Configuration” setting (see page 95)).
- *2 For 9ch output, output can be switched between the combination of Surround back and Front high, or Surround back and Front wide speakers by pressing the [SP LAYOUT] button.
- *3 Based on the audio channels contained in the source, the corresponding speakers will output the sound.
- *4 • This listening mode can be selected only when all the following conditions are satisfied:
 - a. Center speaker is connected to the AV receiver.
 - b. Either of Front High speakers or Front Wide speakers is connected to the AV receiver.
- Output can be switched between Front high or Front wide speakers by pressing the [SP LAYOUT] button (depending on the “Speaker Configuration” setting (see page 95)).
- *5 This listening mode is not available while you are using Zone 2 (“Not Available” will appear on the display). If you turn Zone 2 on during the Pure Audio listening mode, the listening mode will change to Direct.
- *6 If there are no surround back speakers, DTS is used.
- Available sampling rate for PCM input signal is 32/44.1/48/88.2/96/176.4/192kHz.
- The listening modes cannot be selected with some source formats.

About the Listening Modes

The AV receiver’s listening modes can transform your listening room into a movie theater or concert hall, with high fidelity and stunning surround sound.

Pure Audio

In this mode, the display and video circuitry are turned off, minimizing possible noise sources for the ultimate in high-fidelity reproduction. (As the video circuitry is turned off, only video signals input through HDMI IN can be output.)

Direct

In this mode, audio from the input source is output directly with minimal processing, providing high-fidelity reproduction. All of the source’s audio channels are output as they are.

Stereo

Sound is output by the front left and right speakers and subwoofer.

Mono

Use this mode when watching an old movie with a mono soundtrack, or use it with the foreign language soundtracks recorded in the left and right channels of some movies. It can also be used with DVDs or other sources containing multiplexed audio, such as karaoke DVDs.

Multichannel

This mode is for use with PCM multichannel sources.

Dolby Pro Logic IIx

Dolby Pro Logic II

Dolby Pro Logic IIx expands any 2-channel source for 7.1-channel playback. It provides a very natural and seamless surround-sound experience that fully envelops the listener. As well as music and movies, video games can also benefit from the dramatic spatial effects and vivid imaging. If you’re not using any surround back speakers, **Dolby Pro Logic II** will be used instead of Dolby Pro Logic IIx.

- **Dolby PLIIx Movie**

Use this mode with any stereo or Dolby Surround (Pro Logic) movie (e.g., TV, DVD, VHS).

- **Dolby PLIIx Music**

Use this mode with any stereo or Dolby Surround (Pro Logic) music source (e.g., CD, radio, cassette, TV, VHS, DVD).

- **Dolby PLIIx Game**

Use this mode with video games, especially those that bear the Dolby Pro Logic II logo.

Dolby Pro Logic IIz Height

Dolby Pro Logic IIz Height is designed to more effectively use existing program material when height channel speaker outputs are present. **Dolby Pro Logic IIz Height** can be used to upmix a variety of sources from movies and music, but are particularly well-suited to upmix game content.

Dolby Digital

Use this mode with DVDs that bear the Dolby Digital logo, and Dolby Digital TV broadcasts. This is the most common digital surround-sound format, and it’ll put you right in the middle of the action, just like being in a movie theater or concert hall.

Audyssey Dynamic Surround Expansion™

Audyssey Dynamic Surround Expansion™ is a scalable system that adds new speakers to improve surround impression. Starting with a 5.1 system Dynamic Surround Expansion first adds Wide channels for the biggest impact on envelopment. Research in human hearing has proven that information from the Wide channels is much more critical in the presentation of a realistic soundstage than then Back Surround channels found in traditional 7.1 systems. Dynamic Surround Expansion then creates a pair of Height channels to reproduce the next most important acoustical and perceptual cues. In addition to these new Wide and Height channels, Dynamic Surround Expansion applies Surround Envelopment Processing to enhance the blend between the front and surround channels.

5.1-channel source + Dolby EX

These modes expand 5.1-channel sources for 6.1/7.1-channel playback. They're especially suited to Dolby EX soundtracks that include a matrix-encoded surround back channel. The additional channel adds an extra dimension and provides an enveloping surround sound experience, perfect for rotating and fly-by sound effects.

Dolby Digital Plus

Developed for use with HDTV, including the new video disc formats Blu-ray and HD DVD, this is the latest multichannel audio format from Dolby. It supports up to 7.1 channels with 48 kHz sampling rate.

Dolby TrueHD

Designed to take full advantage of the additional storage space offered by the new Blu-ray and HD DVD disc formats, this new Dolby format offers up to 7.1 discrete channels of digital audio with 48/96 kHz, up to 5.1-channels with 192 kHz sampling rate.

5.1-channel source + Dolby PLIIx Music

These modes use the Dolby Pro Logic IIx Music mode to expand 5.1-channel sources for 6.1/7.1-channel playback.

5.1-channel source + Dolby PLIIx Movie

These modes use the Dolby Pro Logic IIx Movie mode to expand 5.1-channel sources for 7.1-channel playback.

DTS

The DTS digital surround-sound format supports up to 5.1 discrete channels and uses less compression for high-fidelity reproduction. Use it with DVDs and CDs that bear the DTS logo.

DTS 96/24

This mode is for use with DTS 96/24 sources. This is high-resolution DTS with a 96 kHz sampling rate and 24-bit resolution, providing superior fidelity. Use it with DVDs that bear the DTS 96/24 logo.

DTS-ES Discrete

This mode is for use with DTS-ES Discrete soundtracks, which use a discrete surround back channel for true 6.1/7.1-channel playback. The seven totally separate audio channels provide better spatial imaging and 360-degree sound localization, perfect for sounds that pan across the surround channels. Use it with DVDs that bear the DTS-ES logo, especially those with a DTS-ES Discrete soundtrack.

DTS-ES Matrix

This mode is for use with DTS-ES Matrix soundtracks, which use a matrix-encoded back-channel for 6.1/7.1-channel playback. Use it with DVDs that bear the DTS-ES logo, especially those with a DTS-ES Matrix soundtrack.

DTS Neo:6

This mode expands any 2-channel source for up to 7.1-channel playback. It uses seven full-bandwidth channels of matrix decoding for matrix-encoded material, providing a very natural and seamless surround sound experience that fully envelops the listener.

- **Neo:6 Cinema**

Use this mode with any stereo movie (e.g., TV, DVD, VHS).

- **Neo:6 Music**

Use this mode with any stereo music source (e.g., CD, radio, cassette, TV, VHS, DVD).

5.1-channel source + Neo:6

This mode uses Neo:6 to expand 5.1-channel sources for 6.1/7.1-channel playback.

DTS-HD High Resolution Audio

Developed for use with HDTV, including the new video disc formats Blu-ray and HD DVD, this is the latest multichannel audio format from DTS. It supports up to 7.1 channels with 96 kHz sampling rate.

DTS-HD Master Audio

Designed to take full advantage of the additional storage space offered by the new Blu-ray and HD DVD disc formats, this new DTS format offers up to 7.1 discrete channels of digital audio with 48/96 kHz, up to 5.1-channels with 192 kHz sampling rate.

DTS Express

This format supports up to 5.1 channels and a lower sampling rate of 48 kHz. Applications include interactive audio and commentary encoding for HD DVD Sub Audio and Blu-ray Secondary Audio. Also broadcast and media servers.

Neural Digital Music

Neural Digital Music is a new surround mode specifically designed to enhance the playback of compressed digital music content. It provides listeners with an expanded sound stage and clean surround experience, even with compressed audio sources such as MP3s and Internet streams.

DSD

DSD stands for Direct Stream Digital and is the format used to store digital audio on Super Audio CDs (SACD). This mode can be used with Super Audio CDs that feature multichannel audio.

DTS Surround Sensation Speaker

With this mode you can enjoy a virtual 5.1 surround sound even with only two speakers.

- **Neo:6 Cinema + DTS Surround Sensation**

- **Neo:6 Music + DTS Surround Sensation**

These modes use Neo:6 to expand stereo sources for virtual surround playback.

DTS Surround Sensation Headphone

DTS Surround Sensation Headphone delivers simulated virtual multi-channel surround sound through any stereo headphones.

THX

Founded by George Lucas, THX develops stringent standards that ensure movies are reproduced in movie theaters and home theaters just as the director intended.

THX Modes carefully optimize the tonal and spatial characteristics of the soundtrack for reproduction in the home-theater environment. They can be used with 2-channel matrixed and multichannel sources.

Surround back speaker output depends on the source material and the selected listening mode.

- **THX Cinema**

THX Cinema mode corrects theatrical soundtracks for playback in a home theater environment. In this mode, THX Loudness Plus is configured for cinema levels and Re-EQ, Timbre Matching, and Adaptive Decorrelation are active.

- **THX Music**

THX Music mode is tailored for listening to music, which is typically mastered at significantly higher levels than movies. In this mode, THX Loudness Plus is configured for music playback and only Timbre Matching is active.

- **THX Games**

THX Games mode is meant for spatially accurate playback of game audio, which is often mixed similarly to movies but in a smaller environment. THX Loudness Plus is configured for game audio levels, with Timbre Matching active.

- **THX Ultra2 Cinema**

This mode expands 5.1-channel sources for 7.1-channel playback. It does this by analyzing the composition of the surround source, optimizing the ambient and directional sounds to produce the surround back channel output.

- **THX Ultra2 Music**

This mode is designed for use with music. It expands 5.1-channel sources for 7.1-channel playback.

- **THX Ultra2 Games**

This mode is designed for use with video games. It can expand 5.1-channel sources for 6.1/7.1-channel playback.

- **THX Surround EX**

This mode expands 5.1-channel sources for 6.1/7.1-channel playback. It's especially suited to Dolby Digital EX sources. THX Surround EX, also known as Dolby Digital Surround EX, is a joint development between Dolby Laboratories and THX Ltd.

Neural Surround

Neural Surround employs psychoacoustic frequency domain processing, which allows delivery of a more detailed sound stage, with superior channel separation and localization of audio elements. The Neural Surround modes can expand any 2-channel stereo source for 5.1- or 7.1-channel playback, respectively. Use them with CD, radio, cassette, TV, VHS, DVD, and other 2-channel

stereo sources, including video games. Neural Surround can also be used by broadcasters to encode and transmit surround-sound content over a stereo signal, which listeners can enjoy as either surround sound or normal stereo.

Onkyo Original DSP Modes

Orchestra

Suitable for classical or operatic music, this mode emphasizes the surround channels in order to widen the stereo image, and simulates the natural reverberation of a large hall.

Unplugged

Suitable for acoustic instruments, vocals, and jazz, this mode emphasizes the front stereo image, giving the impression of being right in front of the stage.

Studio-Mix

Suitable for rock or pop music, listening to music in this mode creates a lively sound field with a powerful acoustic image, like being at a club or rock concert.

TV Logic

This mode adds realistic acoustics to TV shows produced in a TV studio, surround effects to the entire sound, and clarity to voices.

Game-RPG

Use this mode when playing role playing game discs.

Game-Action

Use this mode when playing action game discs.

Game-Rock

Use this mode when playing rock game discs.

Game-Sports

Use this mode when playing sports game discs.

All Ch Stereo

Ideal for background music, this mode fills the entire listening area with stereo sound from the front, surround, and surround back speakers.

Full Mono

In this mode, all speakers output the same sound in mono, so the sound you hear is the same regardless of where you are within the listening room.

T-D (Theater-Dimensional)

With this mode you can enjoy a virtual surround sound even with only two or three speakers. This works by controlling how sounds reach the listener's left and right ears. Good results may not be possible if there's too much reverb, so we recommend that you use this mode in an environment with little or no natural reverb.

Advanced Setup

Onscreen Setup Menus

The onscreen setup menus appear on the connected TV and provide a convenient way to change the AV receiver's various settings. Settings are organized into nine categories on the **main menu**, most containing a **submenu**.

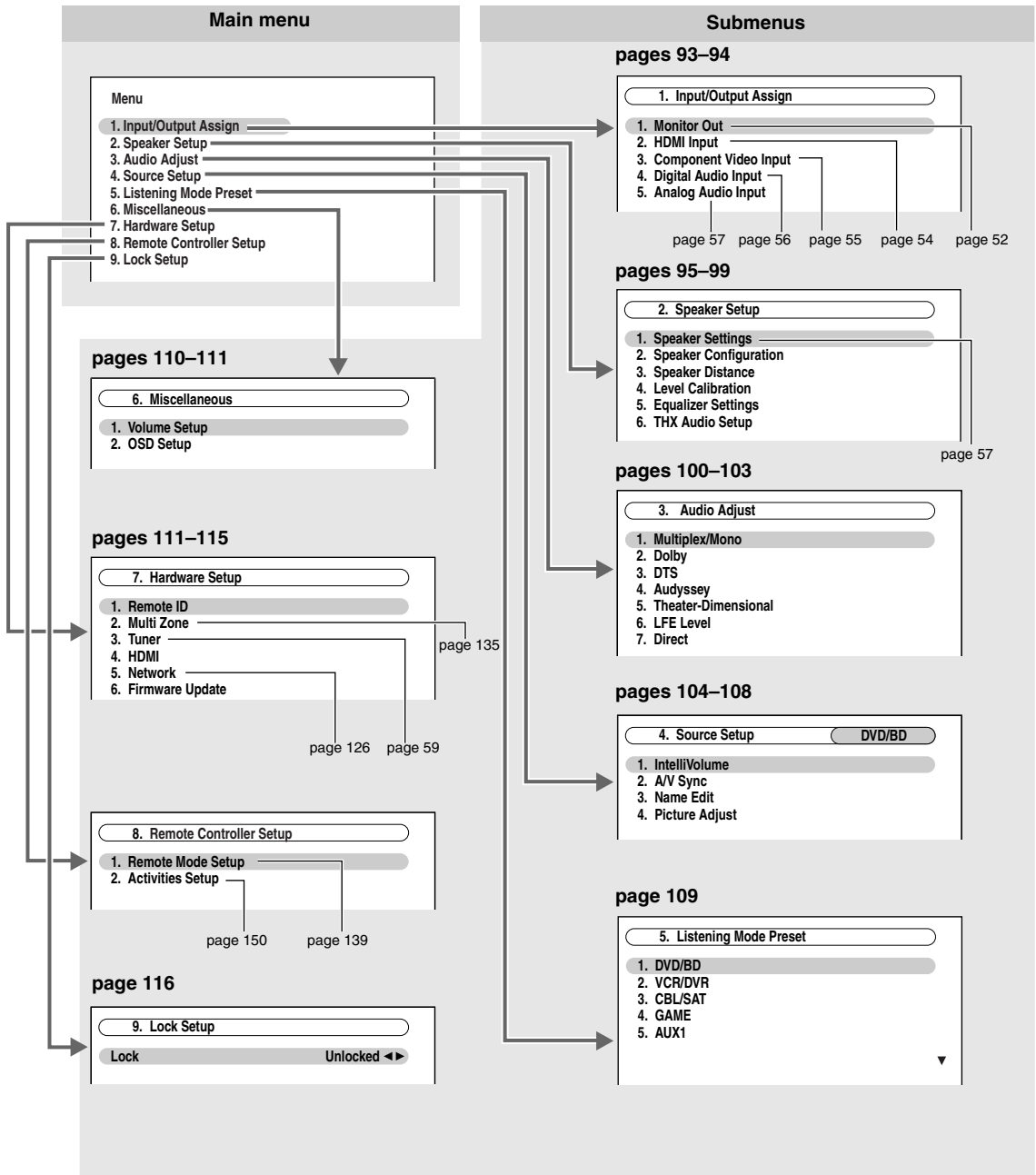

Input/Output Assign

This section explains items on the “Input/Output Assign” menu.

- 1 Press the [RECEIVER] button followed by the [SETUP] button.**
The main menu appears onscreen.
If the main menu doesn't appear, make sure the appropriate external input is selected on your TV.
- 2 Use the Up and Down [▲]/[▼] buttons to select “1. Input/Output Assign”, and then press [ENTER].**
- 3 Use the Up and Down [▲]/[▼] buttons to select the submenu, and then press [ENTER].**

- 4 Use the Up and Down [▲]/[▼] buttons to select setting, and then use the Left and Right [◀]/[▶] buttons to set them.**
- 5 When you've finished, press the [SETUP] button.**
The setup menu closes.

Note:

This procedure can also be performed on the AV receiver by using its [SETUP] button, arrow buttons, and [ENTER] button.

Monitor Out

Monitor Out See “Monitor Out Setup” on page 52.

Resolution

Brightness –50 to +50 (default: 0)

With this setting you can adjust the picture brightness. “–50” is the darkest. “+50” is the brightest.

Contrast –50 to +50 (default: 0)

With this setting you can adjust contrast. “–50” is the least. “+50” is the greatest.

Hue –20 to +20 (default: 0)

With this setting you can adjust the red/green balance. “–20” is the strongest green. “+20” is the strongest red.

Saturation –50 to +50 (default: 0)

With this setting you can adjust saturation. “–50” is the weakest color. “+50” is the strongest color.

Red Brightness –50 to +50 (default: 0)

With this setting you can adjust the picture red brightness. “–50” is the darkest. “+50” is the brightest.

Red Contrast –50 to +50 (default: 0)

With this setting you can adjust red contrast. “–50” is the least. “+50” is the greatest.

Green Brightness –50 to +50 (default: 0)

With this setting you can adjust the picture green brightness. “–50” is the darkest. “+50” is the brightest.

Green Contrast –50 to +50 (default: 0)

With this setting you can adjust green contrast. “–50” is the least. “+50” is the greatest.

Blue Brightness –50 to +50 (default: 0)

With this setting you can adjust the picture blue brightness. “–50” is the darkest. “+50” is the brightest.

Blue Contrast –50 to +50 (default: 0)

With this setting you can adjust blue contrast. “–50” is the least. “+50” is the greatest.

HDMI Input

See “HDMI Input Setup” on page 54.

Component Video Input

See “Component Video Input Setup” on page 55.

Digital Audio Input

See “Digital Audio Input Setup” on page 56.

Analog Audio Input

Multich See “Analog Audio Input Setup” on page 57.

Subwoofer Input Sensitivity

0 dB (default), 5 dB, 10 dB, 15 dB

Some DVD players output the LFE channel from their analog subwoofer output at 15 dB higher than normal. With this setting, you can change the AV receiver’s subwoofer sensitivity to match your DVD player. Note that this setting only affects signals connected to the AV receiver’s MULTI CH: SUBWOOFER jack.

If you find that your subwoofer is too loud, try the 10 dB or 15 dB setting.

Speaker Setup

Some of the settings in this section are set automatically by Audyssey MultEQ® XT Room Correction and Speaker Setup (see page 61). For Speakers B, you need to change the settings manually.

Here you can check the settings made by Audyssey MultEQ® XT Room Correction and Speaker Setup, or set them manually, which is useful if you change one of the connected speakers after using Audyssey MultEQ® XT Room Correction and Speaker Setup.

Note:

The Speaker Setup cannot be carried out while headphones are connected to the AV receiver.

1 Press the [RECEIVER] button, and then use the remote controller's [SP LAYOUT] button to select Speakers A or Speakers B.

Note:

Speakers B cannot be selected if "Speakers Type(FrontB)" is set to "Not Use".

2 Press the [SETUP] button.

The main menu appears onscreen.
If the main menu doesn't appear, make sure the appropriate external input is selected on your TV.

3 Use the Up and Down [▲]/[▼] buttons to select "2. Speaker Setup", and then press [ENTER].

4 Use the Up and Down [▲]/[▼] buttons to select the submenu, and then press [ENTER].

5 Use the Up and Down [▲]/[▼] buttons to select setting, and then use the Left and Right [◀]/[▶] buttons to set them.

6 When you've finished, press the [SETUP] button.

The setup menu closes.

Speaker Settings

See "Speaker Settings" on page 57.

Speaker Configuration

With these settings, you can specify which speakers are connected and a crossover frequency for each speaker. You can set the crossover frequencies, distances, and levels of the front Speakers A and front Speakers B independently. The other speakers (i.e., subwoofer, center, surround, and surround back) use the same crossover frequencies, distances, and levels for Speakers A and Speakers B. The following crossover frequencies can be specified: "Full Band", "40Hz", "50Hz", "60Hz", "70Hz", "80Hz(THX)", "90Hz", "100Hz", "120Hz", "150Hz", or "200Hz". Specify "Full Band" for speakers that can output low frequency bass sounds adequately, for example, speakers with a good sized woofer. For smaller speakers, specify a crossover frequency. Sounds below the crossover frequency will be output by the subwoofer instead of the speaker. Refer to your speaker's manuals to determine the optimum crossover frequencies.

If you set up your speakers using Audyssey MultEQ® XT Room Correction and Speaker Setup, please make sure manually that any THX speakers are set to "80Hz(THX)" crossover.

Subwoofer	1ch: Audio signal is outputted from SW1 jack only. 2ch: Audio signal is outputted from SW1 and SW2 jacks (default). No: Select if no subwoofer is connected.
Front^{*1}	Full Band, 40Hz, 50Hz, 60Hz, 70Hz, 80Hz(THX) (default), 90Hz, 100Hz, 120Hz, 150Hz, 200Hz
Center^{*2}	Full Band, 40Hz, 50Hz, 60Hz, 70Hz, 80Hz(THX), 90Hz, 100Hz, 120Hz, 150Hz, 200Hz
Surround^{*2}	None: Select if no speaker is connected.
Front Wide^{*2*3*5*7}	
Front High^{*2*3*7*10}	
Surr Back^{*3*4*6}	

Surr Back Ch^{*8} **1ch:** Select if only one surround back L speaker is connected.
 2ch: Select if two (left and right) surround back speakers are connected (default).

LPF of LFE (Low-Pass Filter for the LFE Channel)

80Hz(THX) (default), 90Hz, 100Hz, 120Hz

This setting is **not** set automatically by Audyssey MultEQ[®] XT Room Correction and Speaker Setup (see page 61).

With this setting, you can specify the cutoff frequency of the LFE channel's low-pass filter (LPF), which can be used to filter out unwanted hum. The LPF only applies to sources that use the LFE channel.

* If you're using THX-certified speakers, select "80Hz(THX)".

DoubleBass^{*9} **On:** Double Bass function on (default).
 Off(THX): Double Bass function off.

This setting is **not** set automatically by Audyssey MultEQ[®] XT Room Correction and Speaker Setup (see page 61).

With the Double Bass function, you can boost bass output by feeding bass sounds from the front left and right, center channels to the subwoofer.

* If you're using THX-certified speakers, select "Off(THX)".

Notes:

*1 If the "Subwoofer" setting is set to "No", the "Front" setting is fixed at "Full Band".

*2 If the "Front" setting is set to anything other than "Full Band", "Full Band" cannot be selected here.

*3 If the "Surround" setting is set to "None", this setting cannot be selected.

*4 If the "Surround" setting is set to anything other than "Full Band", "Full Band" cannot be selected here.

*5 If the "Powered Zone2" setting is set to "Act" (page 134), this setting cannot be selected.

*6 If the "Powered Zone3" setting is set to "Act" (page 134), or "Speakers Type(FrontA)" setting is set to "Bi-Amp" or "BTL" (page 58), this setting cannot be selected.

*7 If the "Speakers Type(FrontB)" setting is set to "Normal", "Bi-Amp" or "BTL" (page 57), this setting cannot be selected.

*8 If the "Surr Back" setting is set to "None", this setting cannot be selected.

*9 This function can be set only if the "Subwoofer" setting is set to "1ch" or "2ch", and the "Front" setting is set to "Full Band".

*10 If the Powered Zone 2 is being used (page 134), this setting cannot be selected.

Subwoofer, Front, Center, Surround, Surr Back

(Setting Speakers A and Speakers B)

Not Use: Select if you don't want to use each speaker with Speakers A or Speakers B.

Use: Select if you do want to use each speaker with Speakers A or Speakers B.

If you're using Speakers B, you can choose whether or not to use the subwoofer, center, surround, and surround back speakers with the Speakers A and Speakers B configurations independently. You cannot choose whether or not to use the front speakers.

Notes:

• These settings can only be displayed when the "Speakers Type(FrontB)" setting is set to other than "Not Use" (page 57).

• You cannot select speakers that you set to "No" or "None".

Speaker Distance

This setting is set automatically by Audyssey MultEQ® XT Room Correction and Speaker Setup (see page 61). Here you can specify the distance from each speaker to the listening position so that the sound from each speaker arrives at the listener's ears as the sound designer intended.

You can set the distances for front Speakers A and front Speakers B independently. The other speakers (i.e., subwoofer, center, surround, and surround back) use the same distance settings for Speakers A and Speakers B.

Unit	feet: Distances can be set in feet. Range: 0.5 to 30 feet in 0.5-foot steps. (North American models: default)
	meters: Distances can be set in meters. Range: 0.15 to 9 meters in 0.15-meter steps. (European and Asian models: default)

Left, Front Wide Left, Front High Left, Center, Front High Right, Front Wide Right, Right, Surr Right, Surr Back Right, Surr Back Left, Surr Left, Subwoofer 1, Subwoofer 2^{*1}

Specify the distance from the each speaker to your listening position.

Notes:

- You cannot select speakers that you set to “No” or “None” in the “Speaker Configuration” (page 95).
- Speakers B cannot be selected if “Speakers Type(FrontB)” is set to “Not Use”.

*1 If the “Subwoofer” setting is set to “1ch”, this setting cannot be selected.

Level Calibration

Level Calibration can be set automatically by Audyssey MultEQ® XT Room Correction and Speaker Setup (see page 61).

If you prefer, you can adjust the level of each speaker with the built-in test tone so that the volume of each speaker is the same at the listening position. You can adjust the levels of front Speakers A and front Speakers B independently. The other speakers (i.e., subwoofer, center, surround, and surround back) use the same level settings for Speakers A and Speakers B.

Left, Front Wide Left, Front High Left, Center, Front High Right, Front Wide Right, Right, Surr Right, Surr Back Right, Surr Back Left, Surr Left, Subwoofer 1, Subwoofer 2^{*1}

The levels can be adjusted from –12.0 to +12.0 dB in 0.5 dB steps (–15.0 to +12.0 dB for the subwoofer).

Notes:

- The speakers cannot be calibrated while the output of the AV receiver is muted.
- The test tone is output at the standard level for THX, which is 0 dB (absolute volume setting 82). If you normally listen at volume settings below this, be careful because the test tone will be much louder.
- You cannot get the test tone from speakers that you set to “No” or “None” in the “Speaker Configuration” (page 95).
- Speakers B cannot be selected if “Speakers Type(FrontB)” is set to “Not Use”.

*1 If the “Subwoofer” setting is set to “1ch”, this setting cannot be selected.

Tip:

If you're using a handheld sound level meter, adjust the level of each speaker so that it reads 75 dB SPL at the listening position, measured with C-weighting and slow reading.

Equalizer Settings

This setting is set automatically by Audyssey MultEQ® XT Room Correction and Speaker Setup (see page 61). With the Equalizer settings, you can adjust the tone of speakers individually with a 7-band equalizer. The volume of each speaker can be set on this page. The Equalizer settings only apply to Speakers A and cannot be adjusted while Speakers B is selected.

Notes:

- You can select: “63Hz”, “160Hz”, “400Hz”, “1000Hz”, “2500Hz”, “6300Hz”, or “16000Hz”. And for the subwoofer, “25Hz”, “40Hz”, “63Hz”, “100Hz”, or “160Hz”.
- While the Direct or Pure Audio listening mode is selected, the equalizer settings have no effect.

Equalizer **Manual:** You can adjust the equalizer for each speaker manually. If you selected “Manual”, continue with this procedure.

1	Press the Down [▼] button to select “Channel”, and then use the Left and Right [◀]/[▶] buttons to select a speaker.
2	<p>Use the Up and Down [▲]/[▼] buttons to select a frequency, and then use the Left and Right [◀]/[▶] buttons to adjust the level at that frequency.</p> <p>The volume at each frequency can be adjusted from –6 to +6 dB in 1 dB steps.</p> <p>Tip: Low frequencies (e.g., 63Hz) affect bass sounds; high frequencies (e.g., 16000Hz) affect treble sounds.</p>
3	<p>Use the Up [▲] button to select “Channel”, and then use the Left and Right [◀]/[▶] buttons to select another speaker.</p> <p>Repeat steps 1 and 2 for each speaker.</p> <p>You cannot select speakers that you set to “No” or “None” in the “Speaker Configuration” (page 95).</p>

Audyssey: The tone for each speaker is set automatically by Audyssey MultEQ® XT Room Correction and Speaker Setup. Be sure to select this setting after having performed Room Correction and Speaker Setup. “Audyssey” is automatically selected when “Dynamic EQ” and “Dynamic Volume” are set to “On” (see page 102). When “Audyssey” is selected, “Dolby Volume” becomes “Off” automatically (page 118).

Off: Tone off, response flat (default).

THX Audio Setup

This setting is **not** set automatically by Audyssey MultEQ® XT Room Correction and Speaker Setup (see page 61). With the “SurrBack Sp Spacing” setting, you can specify the distance between your surround back speakers. This setting is used by Speakers A and Speakers B.

If you’re using a THX-certified subwoofer, set the “THX Ultra2/Select2 Subwoofer” setting to “Yes”. You can then apply THX’s Boundary Gain Compensation (BGC) to compensate the perceived exaggeration of low frequencies for listeners sitting very close to a room boundary (i.e., wall).

You can also set the THX Loudness Plus. When the “Loudness Plus” is set to “On”, it is possible to enjoy even subtle nuances of audio expression at low volume.

This result is only available when the THX listening mode is selected.

SurrBack Sp Spacing

< 1ft (< 0.3m):

Select this if your surround back speakers are between 0 and 1 foot (0–30 cm) apart.

1 ft – 4 ft (0.3 m – 1.2 m):

Select this if your surround back speakers are between 1 and 4 feet (0.3–1.2 m) apart.

> 4ft (> 1.2m) (default):

Select this if your surround back speakers are more than 4 feet (1.2 m) apart.

Note:

Cannot be set if “Surr Back Ch” is set to “1ch” (page 96) or “Surr Back” is set to “None” (page 95).

THX Ultra2/Select2 Subwoofer

No: Select this if you do not have a THX-certified subwoofer.

Yes: Select this if you have a THX-certified subwoofer.

Note:

If the “Subwoofer” setting is set to “No”, this setting cannot be selected (page 95).

BGC

Off: Select this to turn off BGC.

On: Select this to turn on BGC.

Note:

This setting is only available if “THX Ultra2/Select2 Subwoofer” is set to “Yes”.

Loudness Plus

Off: Select this to turn off Loudness Plus.

On: Select this to turn on Loudness Plus (default).

Preserve THX Settings

Yes: Audyssey Dynamic EQ™ / Audyssey Dynamic Volume™ will not be active in THX listening mode.

No: Audyssey Dynamic EQ / Audyssey Dynamic Volume will be active in THX listening mode depending on the setting.

Note:

This setting is fixed at “Yes” if “Loudness Plus” is set to “On”.

THX Loudness Plus

THX Loudness Plus is a new volume control technology featured in THX Ultra2 Plus™ and THX Select2 Plus™ Certified receivers. With THX Loudness Plus, home theater audiences can now experience the rich details in a surround mix at any volume level. A consequence of turning the volume below Reference Level is that certain sound elements can be lost or perceived differently by the listener. THX Loudness Plus compensates for the tonal and spatial shifts that occur when the volume is reduced by intelligently adjusting ambient surround channel levels and frequency response. This enables users experience the true impact of soundtracks regardless of the volume setting. THX Loudness Plus is automatically applied when listening in any THX listening mode. The new THX Cinema, THX Music, and THX Games modes are tailored to apply the proper THX Loudness Plus settings for each type of content.

Audio Adjust

With the Audio Adjust functions and settings, you can adjust the sound and listening modes as you like.

1 Press the [RECEIVER] button followed by the [SETUP] button.

The main menu appears onscreen.
If the main menu doesn't appear, make sure the appropriate external input is selected on your TV.

2 Use the Up and Down [▲]/[▼] buttons to select "3. Audio Adjust", and then press [ENTER].

3 Use the Up and Down [▲]/[▼] buttons to select the submenu, and then press [ENTER].

4 Use the Up and Down [▲]/[▼] buttons to select setting, and then use the Left and Right [◀]/[▶] buttons to set them.

5 When you've finished, press the [SETUP] button.

The setup menu closes.

Note:

This procedure can also be performed on the AV receiver by using its [SETUP] button, arrow buttons, and [ENTER] button.

Multiplex/Mono

Multiplex

Input Channel **Main:** The main channel is output (default).
 Sub: The sub channel is output.
 Main/Sub: Both the main and sub channels are output.

This setting determines which channel of a stereo multiplex source is output. Use it to select audio channels or languages with multiplex sources, multilingual TV broadcasts, and so on.

Mono

Input Channel **Left + Right:** Both the left and right channels are output (default).
 Left: Only the left channel is output.
 Right: Only the right channel is output.

This setting specifies the channel to be used for playing any 2-channel digital source such as Dolby Digital, or 2-channel analog/PCM source in the Mono listening mode.

Output Speaker **Center:** Mono audio is output by the center speaker (default).
 Left / Right: Mono audio is output by the front left and right speakers.

This setting determines which speakers output mono audio when the Mono listening mode is selected.

Note:

If the "Center" setting is set to "None" (page 95), this setting is fixed at "Left / Right".

Dolby

PLIIx Music (2ch Input)

These settings apply to only 2-channel stereo sources.

If you're not using any surround back speakers, these settings apply to Dolby Pro Logic II, instead of Dolby Pro Logic IIx.

Panorama **On:** Panorama function on.
 Off: Panorama function off (default).

With this setting, you can broaden the width of the front stereo image when using the Dolby Pro Logic IIx Music listening mode.

Dimension **-3 to +3 (default: 0)**

With this setting, you can move the sound field forward or backward when using the Dolby Pro Logic IIx Music listening mode. Higher settings move the sound field backward. Lower settings move it forward.

If the stereo image feels too wide, or there's too much surround sound, move the sound field forward to improve the balance. Conversely, if the stereo image feels like it's in mono, or there's not enough surround sound, move it backward.

Center Width **0 to 7 (default: 3)**

With this setting, you can adjust the width of the sound from the center speaker when using the Dolby Pro Logic IIx Music listening mode. Normally, if you're using a center speaker, the center channel sound is output by only the center speaker. (If you're not using a center speaker, the center channel sound will be distributed to the front left and right speakers to create a phantom center). This setting controls the front left, right, and center mix, allowing you to adjust the weight of the center channel sound.

PLIIz Height Gain

Low: Low PLIIz Height Gain becomes active.

Mid: Medium PLIIz Height Gain becomes active (default).

High: High PLIIz Height Gain becomes active.

The Height Gain Control in Dolby Pro Logic IIz enables the listener to select how much gain is applied to the front high speakers. There are three settings, "Low", "Mid" and "High", and the front high speakers are accentuated in that order. While "Mid" is the default listening setting, the listener may adjust the Height Gain Control to their personal preference.

Dolby EX

Auto: If the source signal contains a Dolby EX flag, the Dolby EX or THX Surround EX listening mode is used.

Manual: You can select any available listening mode (default).

This setting determines how Dolby EX encoded signals are handled. This setting is unavailable if no surround back speaker is connected. This setting is effective with Dolby Digital, Dolby Digital Plus and Dolby TrueHD only.

Note:

If the "Front High" and "Front Wide" settings are set to other than "None" (page 95), this setting is fixed at "Manual".

Dolby Volume

Off: Dolby Volume off (default).

Low: Low Compression Mode becomes active.

Mid: Medium Compression Mode becomes active.

High: High Compression Mode becomes active. This setting affects volume the most, causing all sounds to be of equal loudness.

Dolby Volume is an intelligent volume control system that resolves and improves audio frequency response and volume inconsistencies in playback applications.

Notes:

- When the "Dolby Volume" is set to effective, "Equalizer" setting is set to "Off" or "Manual", and "Dynamic EQ" is set to "Off".
- When the "Dolby Volume" is set to effective, the Late Night function cannot be set.

Half Mode

Off: Half Mode off.

On: Half Mode on (default).

The Half Mode parameter turns Dolby Volume Half Mode processing ON and OFF.

In OFF mode, Dolby Volume applies a bass and treble attenuation to the audio when the system gain exceeds reference level. This enables a more perceptually flat listening experience as human ears are more sensitive to bass and treble at higher levels. Some listeners however, prefer to have more bass and treble performance at higher gain levels.

Notes:

- If the "Dolby Volume" setting is set to "Off", this setting cannot be selected.
- During Half Mode ON playback, Dolby Volume does not apply a bass and treble attenuation when the system volume exceeds reference level thereby boosting perception of high and low frequencies.

DTS

Neo:6 Music

Center Image **0 to 5 (default: 2)**

The DTS Neo:6 Music listening mode creates 6-channel surround sound from 2-channel stereo sources. With this setting, you can specify by how much the front left and right channel output is attenuated in order to create the center channel.

Setting a value "0" in the middle is set to hear a sound. Sound is spread in left and right (the outside) so that the set value is made big. Please adjust by liking.

Audyssey

For “Dynamic EQ”, “Reference Level” and “Dynamic Volume”, you cannot change the settings before completing Audyssey MultEQ® XT Room Correction and Speaker Setup. Audyssey settings cannot be adjusted while Speakers B is selected.

Dynamic EQ

Off: Audyssey Dynamic EQ™ off (default).

On: Audyssey Dynamic EQ™ on.

With Audyssey Dynamic EQ™, you can enjoy great sound even when listening at low volume levels.

Audyssey Dynamic EQ solves the problem of deteriorating sound quality as volume is decreased by taking into account human perception and room acoustics. It does so by selecting the correct frequency response and surround volume levels moment-by-moment so that the content sounds the way it was created at any volume level—not just at reference level.

Reference Level

Movies are mixed in rooms calibrated for film reference. To achieve the same reference level in a home theater system each speaker level must be adjusted so that -30 dBFS band-limited (500 Hz to 2000 Hz) pink noise produces 75 dB sound pressure level at the listening position. A home theater system automatically calibrated by Audyssey MultEQ® will play at reference level when the master volume control is set to the 0 dB position. At that level you can hear the mix as the mixers heard it.

Audyssey Dynamic EQ™ is referenced to the standard film mix level. It makes adjustments to maintain the reference response and surround envelopment when the volume is turned down from 0 dB. However, film reference level is not always used in music or other non-film content. The Dynamic EQ Reference Level Offset provides three offsets from the film level reference (5 dB, 10 dB, and 15 dB) that can be selected when the mix level of the content is not within the standard.

Dynamic EQ Reference Level Offset

0 dB: This is the default setting and should be used when listening to movies.

5 dB: Select this setting for content that has a very wide dynamic range, such as classical music.

10 dB: Select this setting for jazz or other music that has a wider dynamic range. This setting should also be selected for TV content as that is usually mixed at 10 dB below film reference.

15 dB: Select this setting for pop/rock music or other program material that is mixed at very high listening levels and has a compressed dynamic range.

Note:

If “Dynamic EQ” setting is set to “Off”, this setting cannot be selected.

Dynamic Volume (see page 61)

Off: Audyssey Dynamic Volume™ off (default).

Light: Light Compression Mode becomes active.

Medium: Medium Compression Mode becomes active.

Heavy: Heavy Compression Mode becomes active. This setting affects volume the most, causing all sounds to be of equal loudness.

Notes:

- After Audyssey MultEQ® XT Room Correction and Speaker Setup is completed, even if “Equalizer” setting is not set to “Audyssey”, when “Dynamic EQ” setting is set to “On”, “Equalizer” settings is set to “Audyssey”. When “Dynamic Volume” is set to effective, “Equalizer” setting is set to “Audyssey” and “Dynamic EQ” is set to “On”. When “Dynamic EQ” is set to “Off”, “Dynamic Volume” becomes “Off” automatically.
- “Dynamic Volume” setting cannot be set if speakers B are being used.

Soundstage **-3dB, -2dB, -1dB, Reference (default), +1dB, +2dB, +3dB**

Adjusts the soundstage when using Audyssey Dynamic Surround Expansion™.

Note:

If the “Center” setting is set to “None”, or both “Front High” and “Front Wide” settings are set to “None” (page 95), this setting cannot be selected.

Theater-Dimensional

Listening Angle **Wide:** Select if the listening angle is greater than 30 degrees (default).
Narrow: Select if the listening angle is less than 30 degrees.

With this setting, you can optimize the Theater-Dimensional listening mode by specifying the angle of the front left and right speakers relative to the listening position.

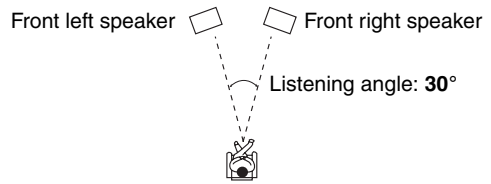

LFE Level

With these settings, you can set the level of the LFE (Low Frequency Effects) channel individually for Dolby Digital, DTS, multichannel PCM, Dolby TrueHD, DTS-HD Master Audio, and DSD sources.

If you find that low-frequency effects are too loud when using one of these sources, change the setting to $-\infty$ dB or $-\infty$ dB.

Dolby Digital^{*1}, DTS^{*2}, Multichannel PCM^{*3}, Dolby TrueHD^{*4}, DTS-HD Master Audio^{*5}, DSD^{*6}

The level can be set to $-\infty$ dB, -20 dB, -10 dB, or 0 dB (default).

Notes:

- *1 Sets the level of the LFE channel for Dolby Digital and Dolby Digital Plus sources.
- *2 Sets the level of the LFE channel for DTS and DTS-HD High Resolution sources.
- *3 Sets the level of the LFE channel for multichannel PCM sources. (Multichannel PCM is input via HDMI.)
- *4 Sets the level of the LFE channel for Dolby TrueHD sources.
- *5 Sets the level of the LFE channel for DTS-HD Master Audio sources.
- *6 Sets the level of the LFE channel for DSD (Super Audio CD) sources.

Direct

Analog

Subwoofer

This setting determines whether or not analog audio signals (bass signals) are output from front speakers when the Pure Audio or Direct listening mode is selected.

- Off:** Analog audio signals (bass signals) are not output (default).
- On:** Analog audio signals (bass signals) are output.

DSD

DAC Direct

This setting determines whether or not DSD (Super Audio CD) audio signals are passed through the DSP for A/V Sync, delay, etc., processing when the Pure Audio or Direct listening mode is selected.

- Off:** DSD signals are processed by the DSP (default).
- On:** DSD signals are not processed by the DSP.

Note:

Once you have selected “Yes”, only DAC Direct will be available for selection. “DSD Direct” will appear on the display.

Source Setup

This section explains items on the “Source Setup” menu. Items can be set individually for each input selector.

1 Press the input selector buttons to select an input source.

2 Press the [RECEIVER] button followed by the [SETUP] button.

The main menu appears onscreen.
If the main menu doesn’t appear, make sure the appropriate external input is selected on your TV.

3 Use the Up and Down [▲]/[▼] buttons to select “4. Source Setup”, and then press [ENTER].

The “Source Setup” menu appears. The name of the currently selected input selector is displayed.

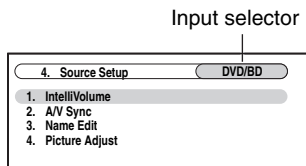

For NET/USB input source only “IntelliVolume” will be available.

4 Use the Up and Down [▲]/[▼] buttons to select an item, and then press [ENTER].

5 Use the Left and Right [◀]/[▶] buttons to change it.

The “Source Setup” menu items are explained below.

6 When you’ve finished, press the [SETUP] button.

The setup menu closes.

Note:

This procedure can also be performed on the AV receiver by using its input selector buttons, [SETUP] button, arrow buttons, and [ENTER] button.

IntelliVolume

With IntelliVolume, you can set the input level for each input selector individually. This is useful if one of your source components is louder or quieter than the others.

If a component is noticeably louder than the others, use the Left [◀] button to reduce its input level. If it’s noticeably quieter, use the Right [▶] button to increase its input level.

IntelliVolume **–12 dB to +12 dB (default: 0 dB)**

A/V Sync

When using your DVD player’s progressive scanning function, you may find that the picture and sound are out of sync. With the A/V Sync setting, you can correct this by applying a delay to the audio signal.

To view the TV picture while setting the delay, press [ENTER]. To return to the previous screen, press the [RETURN] button.

A/V Sync **0 ms to 250 ms in 5 ms steps (default: 0 ms)**

If HDMI Lip Sync is enabled (see page 113), and your TV or display supports HDMI Lip Sync, the displayed delay time will be the summation of the A/V Sync delay time and the HDMI Lip Sync delay time. The HDMI Lip Sync delay time is displayed underneath in parentheses.

Note:

A/V Sync is disabled when the Pure Audio listening mode is selected, or when the Direct listening mode is used with an analog input source.

Name Edit

You can enter a custom name for each individual input selector (excluding TUNER) and radio preset for easy identification. When entered, the custom name will appear on the display.

Notes:

- To name a radio preset, use the [TUNER] button to select AM or FM, and then select the preset (see page 74).
- **(North American models)** You cannot enter a custom name for SIRIUS radio presets.
- To restore a custom name to the default, erase the custom name by entering an empty white space for each letter.

1 Use the arrow [▲]/[▼]/[◀]/[▶] buttons to select a character, and then press [ENTER].

Repeat this step to enter up to 10 characters.

2 When you've finished, to store a name, be sure to use the arrow [▲]/[▼]/[◀]/[▶] buttons to select "OK", and then press [ENTER].

Otherwise it will not be saved.

Name input area

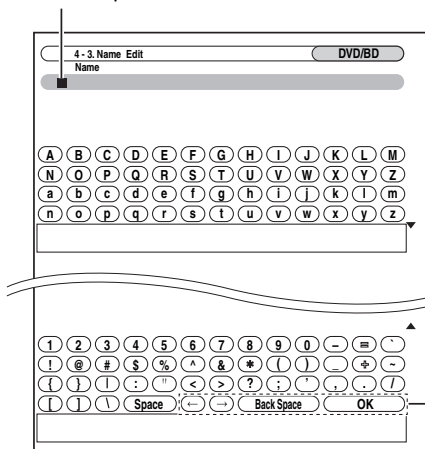

← (Left) / → (Right):

Selected when the cursor is moved within the Name input area.

Back Space:

"Back Space" deletes one character to the left of the cursor.

OK:

Selects when the entry is complete.

To correct a character:

1. Use the arrow [▲]/[▼]/[◀]/[▶] buttons to select "←"(Left) or "→"(Right) and then press [ENTER].
2. Press [ENTER] several times to select the incorrect character (The cursor moves one letter each time [ENTER] is pressed).
3. Use the arrow [▲]/[▼]/[◀]/[▶] buttons to select the correct character, and then press [ENTER].

Picture Adjust

Using Picture Adjust, you can adjust the picture quality and reduce any noise appearing on the screen.

To view the TV picture while setting, press [ENTER]. To return to the previous screen, press the [RETURN] button. "Picture Adjust" is not operable when the input selector is set to "NET/USB".

Tip:

The "Picture Adjust" menus (excluding "Red Brightness" to "Blue Contrast") can also be set using the [VIDEO] button on the remote controller.

1. Press the [RECEIVER] button, followed by the [VIDEO] button.
2. Use the Up and Down [▲]/[▼] buttons to select item, and then use the Left and Right [◀]/[▶] buttons to change the setting.

Game Mode

Off: Game Mode off (default).

On: Game Mode on.

If video signal delay occurs during playback on a video component (i.e. game console), select the corresponding input source and set the "Game Mode" setting to "On". The delay will decrease but in return the picture quality will become poor.

Zoom Mode

This setting determines the aspect ratio.

Normal:

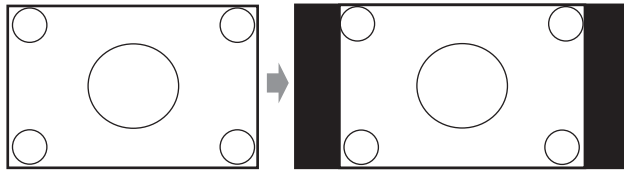

Full: (default)

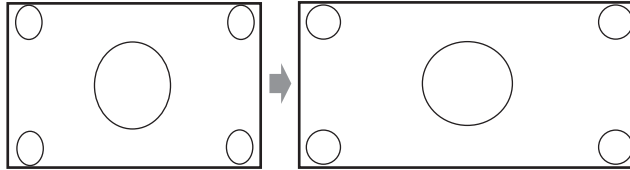

Zoom:

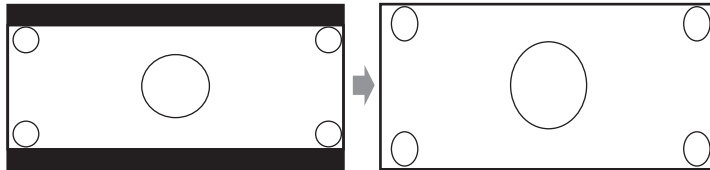

Wide Zoom:

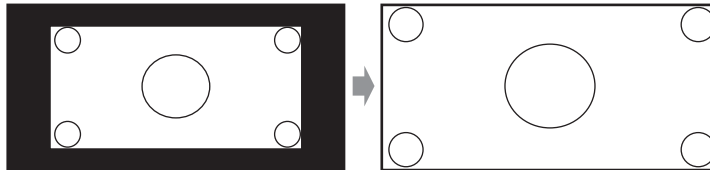

ISF Mode **Custom:** User setting (All items can be freely set.)
 Day: Setting when a room is bright.
 Night: Setting when a room is dark.

The receiver has been designed to incorporate setup and calibration standards established by the Imaging Science Foundation (ISF). The ISF has developed carefully crafted, industry-recognized standards for optimal video performance and has implemented a training program for technicians and installers to use these standards to obtain optimal picture quality from the receiver. Accordingly, Onkyo recommends that setup and calibration be performed by an ISF Certified installation technician.

Picture Mode^{*1*2} **Auto:** The type of content is detected automatically and processed accordingly (default).
 Video: Select when playing a DVD-Video disc whose content originates from video.
 Film: Select when playing a DVD-Video disc whose content originates from film.

DVD-Video disc content originates from either film (recorded at 24 frames per second) or video intended for TV (recorded at 30 frames per second). With the default Picture Mode setting of Auto, the AV receiver automatically detects the type of content and processes it accordingly to achieve the best picture quality. If the AV receiver detects the type of content incorrectly due to characteristics of the disc, you can select Video or Film manually.

Edge Enhancement^{*2} **Off:** Edge enhancement off (default).
 Low: Low edge enhancement.
 Mid: Medium edge enhancement.
 High: High edge enhancement.

With Edge Enhancement, you can make the picture appear sharper.

Mosquito NR^{*1*2} **Off:** Mosquito noise reduction off (default).
 Low: Low mosquito noise reduction.
 Mid: Medium mosquito noise reduction.
 High: High mosquito noise reduction.

With Mosquito Noise Reduction, you can remove the shimmering or haziness that sometimes appears around objects in the picture. Mosquito noise can be an issue with overly compressed MPEG content.

Random NR^{*1*2} **Off:** Random noise reduction off (default).
 Low: Low random noise reduction.
 Mid: Medium random noise reduction.
 High: High random noise reduction.

With Random Noise Reduction, you can remove indiscriminate picture noise, such as film grain.

Block NR^{*1*2} **Off:** Block noise reduction off (default).
 On: Block noise reduction on.

With Block Noise Reduction, you can remove the block distortion that sometimes appears in the picture. Block noise can be an issue with overly compressed MPEG content.

Notes:

*1 When the "Game Mode" setting is set to "On", this setting cannot be selected.

*2 When the "ISF Mode" setting is set to "Day" or "Night", this setting cannot be selected.

Resolution ^{*2}	<p>Through: Select this to pass video through the AV receiver at the same resolution and with no conversion (default).</p> <p>Auto: Select this to have the AV receiver automatically convert video at resolutions not supported by your TV. When the “Monitor Out” is set to “Analog”, this setting will be changed to “Through”.</p> <p>480p (480/576p): Select this for 480p or 576p output and video conversion as necessary.</p> <p>720p: Select this for 720p output and video conversion as necessary.</p> <p>1080i: Select this for 1080i output and video conversion as necessary.</p> <p>1080p: Select this for 1080p output and video conversion as necessary. When the “Monitor Out” is set to “Analog”, this setting will be changed to “1080i”.</p> <p>1080p/24: Select this for 1080p output at 24 frames per second and video conversion as necessary. When the “Monitor Out” is set to “Analog”, this setting will be changed to “1080i”.</p>
---------------------------------	---

You can specify the output resolution for the HDMI outputs and have the AV receiver upconvert the picture resolution as necessary to match the resolution supported by your TV.
Available only when “Source” has been selected in the “Resolution” of the “Monitor Out” setting (page 53).

Brightness ^{*2}	–50 to +50 (default: 0)
---------------------------------	--------------------------------

With this setting you can adjust the picture brightness. “–50” is the darkest. “+50” is the brightest.

Contrast ^{*2}	–50 to +50 (default: 0)
-------------------------------	--------------------------------

With this setting you can adjust contrast. “–50” is the least. “+50” is the greatest.

Hue ^{*2}	–20 to +20 (default: 0)
--------------------------	--------------------------------

With this setting you can adjust the red/green balance. “–20” is the strongest green. “+20” is the strongest red.

Saturation ^{*2}	–50 to +50 (default: 0)
---------------------------------	--------------------------------

With this setting you can adjust saturation. “–50” is the weakest color. “+50” is the strongest color.

Gamma ^{*2}	–3 to +3 (default: 0)
----------------------------	------------------------------

Adjust the balance of incoming picture R (red), G (green), and B (blue) color data signal to the output color data signal.

Red Brightness ^{*2}	–50 to +50 (default: 0)
-------------------------------------	--------------------------------

With this setting you can adjust the picture red brightness. “–50” is the darkest. “+50” is the brightest.

Red Contrast ^{*2}	–50 to +50 (default: 0)
-----------------------------------	--------------------------------

With this setting you can adjust red contrast. “–50” is the least. “+50” is the greatest.

Green Brightness ^{*2}	–50 to +50 (default: 0)
---------------------------------------	--------------------------------

With this setting you can adjust the picture green brightness. “–50” is the darkest. “+50” is the brightest.

Green Contrast ^{*2}	–50 to +50 (default: 0)
-------------------------------------	--------------------------------

With this setting you can adjust green contrast. “–50” is the least. “+50” is the greatest.

Blue Brightness ^{*2}	–50 to +50 (default: 0)
--------------------------------------	--------------------------------

With this setting you can adjust the picture blue brightness. “–50” is the darkest. “+50” is the brightest.

Blue Contrast ^{*2}	–50 to +50 (default: 0)
------------------------------------	--------------------------------

With this setting you can adjust blue contrast. “–50” is the least. “+50” is the greatest.

Notes:

^{*2} When the “ISF Mode” setting is set to “Day” or “Night”, this setting cannot be selected.

Assigning Listening Modes to Input Sources

You can assign a default listening mode to each input source that will be selected automatically when you select each input source. For example, you can set the default listening mode to be used with Dolby Digital input signals. You can select other listening modes during playback, but the mode specified here will be resumed once the AV receiver has been set to Standby.

1 Press the [RECEIVER] button followed by the [SETUP] button.

The main menu appears onscreen.
If the main menu doesn't appear, make sure the appropriate external input is selected on your TV.

2 Use the Up and Down [▲]/[▼] buttons to select "5. Listening Mode Preset", and then press [ENTER].

The "Listening Mode Preset" menu appears.

3 Use the Up and Down [▲]/[▼] buttons to select the input source that you want to set, and then press [ENTER].

The signal format selection menu appears.

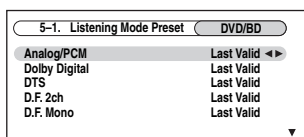

For TUNER input source only "Analog" will be available. For NET/USB input source only "Digital" will be available.

4 Use the Up and Down [▲]/[▼] buttons to select the signal format that you want to set, and then use the Left and Right [◀]/[▶] buttons to select a listening mode.

5 When you've finished, press the [SETUP] button.

The setup menu closes.

Notes:

- If you connect an input component (such as UP-A1 Dock that seated iPod) to the UNIVERSAL PORT jack, you can assign only "Analog" to PORT input source.
- This procedure can also be performed on the AV receiver by using its [SETUP] button, arrow buttons, and [ENTER] button.

Listening Mode Preset

Analog/PCM: With this setting, you can specify the listening mode to be used when an analog (CD, TV, LD, VHS, MD, turntable, radio, cassette, cable, satellite, etc.) or PCM digital (CD, DVD, etc.) audio signal is played.

Dolby Digital: With this setting, you can specify the listening mode to be used when a Dolby Digital or Dolby Digital Plus format digital audio signal is played (DVD, etc.).

DTS: With this setting, you can specify the listening mode to be used when a DTS or DTS-HD High Resolution format digital audio signal is played (DVD, LD, CD, etc.).

D.F. 2ch: Specifies the default listening mode for 2-channel (2/0) stereo sources in a digital format, such as Dolby Digital or DTS.

D.F. Mono: With this setting, you can specify the listening mode to be used when a mono digital audio signal is played (DVD, etc.).

Multichannel PCM: Specifies the default listening mode for multichannel PCM sources input via a HDMI IN, such as DVD-Audio.

Dolby TrueHD: Specifies the default listening mode for Dolby TrueHD sources, such as Blu-ray or HD DVD (input via HDMI).

DTS-HD Master Audio: Specifies the default listening mode for DTS-HD Master Audio sources, such as Blu-ray or HD DVD (input via HDMI).

DSD: Specifies the default listening mode for DSD multichannel sources, such as Super Audio CD.

Only listening modes that can be used with each input signal format can be selected (see pages 82 to 88).

The Last Valid option means that the listening mode selected last will be used.

Miscellaneous (Volume/OSD) Setup

This section explains the items on the “Miscellaneous” menu.

1 Press the [RECEIVER] button followed by the [SETUP] button.

The main menu appears onscreen.
If the main menu doesn't appear, make sure the appropriate external input is selected on your TV.

2 Use the Up and Down [▲]/[▼] buttons to select “6. Miscellaneous”, and then press [ENTER].

The “Miscellaneous” menu appears.

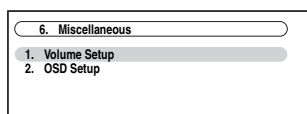

3 Use the Up and Down [▲]/[▼] buttons to select an item, and then press [ENTER].

The screen for that item appears.

4 Use the Up and Down [▲]/[▼] buttons to select an item, and use the Left and Right [◀]/[▶] buttons to change it.

The items are explained below.

5 When you've finished, press the [SETUP] button.

The setup menu closes.

Note:

This procedure can also be performed on the AV receiver by using its [SETUP] button, arrow buttons, and [ENTER] button.

Volume Setup

Volume Display **Absolute:** Display range is “Min”, 0.5 through 99.5, “Max”.
 Relative: Display range is $-\infty$ dB, -81.5 dB through $+18.0$ dB.

With this setting, you can choose how the volume level is displayed.
The absolute value 82 is equivalent to the relative value 0 dB.

Muting Level $-\infty$ dB (fully muted), -50 dB to -10 dB in 10 dB steps.

This setting determines how much the output is muted when the muting function is used (page 69).

Maximum Volume **Off, 50 to 99** (Absolute display)
 Off, -32 dB to $+17$ dB (Relative display)

With this setting, you can limit the maximum volume.
To disable this setting, select “Off”.

Power On Volume **Last, Min, 1 to 99 or Max** (Absolute display)
 Last, $-\infty$ dB, -81 dB to $+18$ dB (Relative display)

With this preference, you can specify the volume setting to be used each time the AV receiver is turned on.
To use the same volume level that was used when the AV receiver was turned off, select “Last”.
The “Power On Volume” cannot be set higher than the “Maximum Volume” setting.

Headphone Level -12 dB to $+12$ dB

With this preference, you can specify the headphone volume relative to the main volume. This is useful if there's a volume difference between your speakers and your headphones.

OSD Setup

Immediate Display **On:** Displayed (default).
Off: Not displayed.

This preference determines whether operation details are displayed onscreen when an AV receiver function is adjusted.

Even when “On” is selected, operation details may not be output if the input source is connected to an HDMI IN.

Display Position **Bottom:** Bottom of the screen (default).
Top: Top of the screen.

This preference determines where on the screen operation details are displayed.

TV Format (European and Asian models)

See “TV Format Setup (European and Asian models)” on page 59.

Language

See “Selecting the Language used for the onscreen setup menus” on page 50.

Hardware Setup

This section explains items on the “Hardware Setup” menu.

1 Press the [RECEIVER] button followed by the [SETUP] button.

The main menu appears onscreen.

If the main menu doesn’t appear, make sure the appropriate external input is selected on your TV.

2 Use the Up and Down [▲]/[▼] buttons to select “7. Hardware Setup”, and then press [ENTER].

The “Hardware Setup” menu appears.

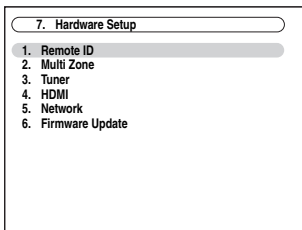

3 Use the Up and Down [▲]/[▼] buttons to select an item, and then press [ENTER].

The screen for that item appears.

4 Use the Up and Down [▲]/[▼] buttons to select an item, and use the Left and Right [◀]/[▶] buttons to change it.

The items are explained below.

5 When you’ve finished, press the [SETUP] button.

The setup menu closes.

Note:

This procedure can also be performed on the AV receiver by using its [SETUP] button, arrow buttons, and [ENTER] button.

Remote ID

Remote ID 1, 2, 3

When several Onkyo components are used in the same room, their remote ID codes may overlap. To differentiate the AV receiver from the other components, you can change its remote ID from 1, the default, to 2 or 3.

Changing the Remote Controller's ID

- 1** While holding down the [RECEIVER] button, press and hold down the [SETUP] button until the [RECEIVER] button lights up (about 3 seconds).
 - 2** Use the number buttons to enter ID 1, 2, or 3.
The [RECEIVER] button flashes twice.
-

Note:

If you do change the AV receiver's remote ID, be sure to change the remote controller to the same ID, otherwise, you won't be able to control it with the remote controller.

Multi Zone

See "Setting the Multi Zone" on page 135.

Tuner

FM/AM Frequency Step (North American models)

AM Frequency Step (European and Asian models)

See "FM/AM Frequency Step Setup" on page 59.

SAT Radio Mode (North American models)

If you connect a SIRIUS Satellite Radio antenna to the AV receiver (sold separately), set this setting to "SIRIUS". See the separate Satellite Radio Guide for more information.

Antenna Aiming (North American models)

The ID of the Sirius Connect Home Tuner is displayed here. You must sign up to obtain a SIRIUS ID. See the separate Satellite Radio Guide for more information.

SIRIUS Parental Lock (North American models)

This item is for use with SIRIUS Satellite Radio. It's not available if "SAT Radio Mode" is set to "None". See the separate Satellite Radio Guide for more information.

HDMI

Audio TV Out **Off:** HDMI audio is not output to TV (default).
On: HDMI audio is output to TV and the sound will be heard from the TV speakers.

This preference determines whether audio received at the HDMI input is output from the HDMI outputs. You may want to turn this preference on if your TV is connected to the HDMI output and you want to listen to the audio from a component that's connected to an HDMI input, through your TV's speakers. Normally, this should be set to "Off".

Notes:

- If "On" is selected and the signal can be output by the TV, the AV receiver will output no sound through its speakers.
- If "On" is selected, "TV Speaker On" appears on the Display by pressing the [DISPLAY] button.
- When "TV Control" is set to "On", this setting is fixed at "Auto".
- With some TVs and input signals, no sound may be output even when this setting is set to "On". When you try to get audio from your TV, signals from the source component may be converted to the format supported by your TV.
- When the "Audio TV Out" setting is set to "On" or "TV Control" is set to "On" to hear from speakers of **RHD**-compatible TV (see page 31), by controlling the AV receiver's volume, the AV receiver's speakers will produce sound while the TV's speakers are muted. If your TV is not compatible with **RHD**, the volume level will not change. To stop the AV receiver's speakers producing sound, change the settings, change your TV's settings, or turn down the AV receiver's volume.
- When the "Audio TV Out" setting is set to "On", the remote controller's [AUDIO] button is disabled.
- If the "Monitor Out" setting is set to "Both (Main)" or "Both (Sub)" (page 52) and if your TV connected to a priority output cannot output the audio, the sound will be heard from AV receiver's speakers.

Lip Sync **Disable:** HDMI Lip Sync disabled (default).
Enable: HDMI Lip Sync enabled.

The AV receiver can be set to automatically correct any delay between the video and the audio, based on the data from the connected monitor.

Notes:

- This function works only if your HDMI-compatible TV supports HDMI Lip Sync.
- You can check the amount of delay being applied by the HDMI Lip Sync function on the A/V Sync screen (see page 104).
- If the "Monitor Out" setting is set to "HDMI Main", "Both (Main)" or "Both" (page 52), the delay will be corrected in accordance with the monitor connected to HDMI OUT MAIN. On the other hand, if "HDMI Sub" or "Both (Sub)" is selected, the delay will be corrected in accordance with the monitor connected to HDMI OUT SUB.

x.v.Color **Disable:** "x.v.Color" disabled (default).
Enable: "x.v.Color" enabled.

If your HDMI source and HDMI-compatible TV both support the "x.v.Color", you can enable "x.v.Color" on the AV receiver with this setting.

Notes:

- If the color is unnatural when "x.v.Color" is set to "Enable", change the setting to "Disable".
- Refer to the connected component's instruction manual for details.
- If the "Monitor Out" setting is set to "Both (Main)" or "Both (Sub)" (page 52) and if your TV connected to a priority output does not support x.v.Color, output will be without x.v.Color control.

HDMI Control (RIHD) **On:** **RIHD** enabled.
 Off: **RIHD** disabled (default).

This function allows **RIHD**-compatible components connected via HDMI to be controlled with the AV receiver.

Notes:

- **RIHD**, which stands for Remote Interactive over HDMI, is the name of the system control function found on Onkyo components. The AV receiver can be used with CEC (Consumer Electronics Control), which allows system control over HDMI and is part of the HDMI standard. CEC provides interoperability between various components, however, operation with components other than **RIHD**-compatible components cannot be guaranteed.

When set to “On” and close the menu, the name of connected **RIHD**-compatible components and “RIHD On” are displayed on the AV receiver.

“Search...” → “(name)” → “RIHD On”

When the AV receiver cannot receive the name of the component, it is displayed as “Player*” or “Recorder*”, etc (“*” means the number of two or more component).

When set to “Off” and close the menu, “RIHD Off” are displayed on the AV receiver.

“Disconnect” → “RIHD Off”

- Set it to “Off” when a connected piece of equipment is not compatible or it is unclear whether the equipment is compatible or not.
- Set it to “Off” if the operation is not successful.
- Refer to the connected component’s instruction manual for details.
- The **RIHD** control does not support HDMI OUT SUB. Use HDMI OUT MAIN instead.

Power Control **On:** Power Control enabled.
 Off: Power Control disabled.

To link the power functions of **RIHD**-compatible components connected via HDMI, select “On”.

This setting is set to “On” automatically when the above “HDMI Control (RIHD)” is set to “On” for the first time.

Notes:

- The “Power Control” setting can be set only when the above “HDMI Control (RIHD)” setting is set to “On”.
- HDMI power control only works with **RIHD**-compatible components that support it and may not work properly with some components due to their settings or compatibility.
- When set to “On”, the power consumption on standby mode increases.
- When set to “On”, regardless of whether the AV receiver is On or on Standby, both audio and video received by an HDMI input will be output from the HDMI output for playback on the TV or other component that’s connected to the HDMI output.
- Refer to the connected component’s instruction manual for details.

TV Control **On:** TV Control enabled.
 Off: TV Control disabled.

Set to “On” when you want to control the AV receiver from an **RIHD**-compatible TV that is connected to HDMI.

Notes:

- Do not assign the component connected with the HDMI input to the TV/TAPE selector when you set “TV Control” setting to “On”. Otherwise, appropriate CEC (Consumer Electronics Control) operation is not guaranteed.
- Set to “Off” when the TV is not compatible or when it is unclear whether the TV is compatible or not.
- The “TV Control” setting can be set only when the above “HDMI Control (RIHD)” and “Power Control” settings are both set to “On”.
- Refer to the connected component’s instruction manual for details.

Note:

After changing the settings of the “HDMI Control (RIHD)”, “Power Control”, or “TV Control”, set all connected pieces of equipment to Standby and then turn them on again. Refer to the User’s Manuals for all connected pieces of equipment.

Network

See “Network Settings” on page 126.

Firmware Update

Notes:

- Perform the firmware update only when an announcement is posted on the Onkyo Web site.
- It takes about 60 minutes to complete the firmware update.
- **(TX-NR5007)** When updating a firmware from a USB mass storage device, the AV receiver searches the device which is connected earlier during power on. If two devices have been connected at the time of power on, the AV receiver will search the device on the front panel.

Version

The current version of the firmware is displayed. The version is made up of the versions of the AV receiver and Onkyo dock (if connected).

Receiver

via NET: You can update the firmware via Internet. Check the network connection before update.

via USB: You can update the firmware from a USB mass storage device.

You can update the AV receiver’s firmware. Do not shutdown the power of the AV receiver while update.

Universal Port

via NET: You can update the firmware via Internet. Check the network connection before update.

via USB: You can update the firmware from a USB mass storage device.

You can update the Onkyo dock’s firmware. Do not shutdown the power of the AV receiver while update.

Note:

This update shall not be performed when no dock is connected to UNIVERSAL PORT jack.

Lock Setup

With this preference, you can protect your settings by locking the setup menus.

1 Press the [RECEIVER] button followed by the [SETUP] button.

The main menu appears onscreen.

If the main menu doesn't appear, make sure the appropriate external input is selected on your TV.

2 Use the Up and Down [▲]/[▼] buttons to select "9. Lock Setup", and then press [ENTER].

The "Lock Setup" menu appears.

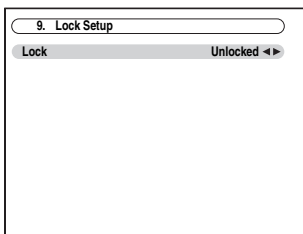

3 Use the Left and Right [◀]/[▶] buttons to select:

When the setup menus are locked, you cannot change any setting.

Locked:

Setup menus locked.

Unlocked:

Setup menus not locked.

4 Press the [SETUP] button.

The setup menu closes.

Note:

This procedure can also be performed on the AV receiver by using its [SETUP] button, arrow buttons, and [ENTER] button.

Digital Input Signal Formats

The digital input signal formats are available only for the input sources that you have assigned a digital input jack (see page 56).

Normally, the AV receiver detects the signal format automatically. However, if you experience either of the following issues when playing PCM or DTS material, you can manually set the signal format to PCM or DTS:

- If the beginnings of tracks from a PCM source are cut off, try setting the format to PCM.
- If noise is produced when fast forwarding or reversing a DTS CD, try setting the format to DTS.
- The setting is stored individually for each input selector.

1 Press the [RECEIVER] button, and then press and hold [AUDIO] button for about 8 seconds.

2 While "Auto" is displayed (about 3 seconds), press the Left and Right [◀]/[▶] buttons to select: PCM, DTS or Auto.

PCM:

Only 2-channel PCM format input signals will be heard. If the input signal is not PCM, the PCM indicator will flash and noise may also be produced.

DTS:

Only DTS (but not DTS-HD) format input signals will be heard. If the input signal is not DTS, the DTS indicator will flash and there will be no sound.

Auto (default):

The format is detected automatically. If no digital input signal is present, the corresponding analog input is used instead.

Using the Audio Settings

You can change various audio settings by pressing the [AUDIO] button.

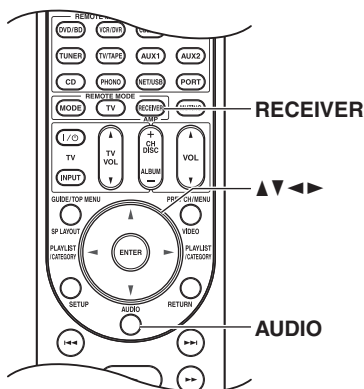

1 Press the [RECEIVER] button followed by the [AUDIO] button.

The audio setting items appear on the display.

2 Use the Up and Down [▲]/[▼] buttons to select an item.

3 Use the Left and Right [◀]/[▶] buttons to change the setting.

Repeat steps 2 and 3 for the other settings.

Note:

When the “Audio TV Out” setting is set to “On” (page 113), the [AUDIO] button is disabled.

Tone Control Settings

You can adjust the bass for the front, front wide, front high, center, surround, surround back and subwoofer speakers and treble for the front, front wide, front high, center, surround and surround back speakers, except when the Direct, Pure Audio or THX listening mode is selected.

Bass **-10 dB to +10 dB in 2 dB steps (default: 0 dB)**

You can boost or cut low-frequency sounds output by the speakers.

Treble **-10 dB to +10 dB in 2 dB steps (default: 0 dB)**

You can boost or cut high-frequency sounds output by the speakers.

Notes:

- To bypass the bass and treble tone circuits, select the Direct, Pure Audio or THX listening mode.
- This procedure can also be performed on the AV receiver by using its [TONE], Down[◀] and Up[▶] buttons (see page 68).

Late Night Function

With the Late Night function, you can reduce the dynamic range of Dolby Digital material so that you can still hear quiet parts even when listening at low volume levels—ideal for watching movies late at night when you don’t want to disturb anyone.

Late Night For **Dolby Digital and Dolby Digital Plus** sources, the options are:

Off: Late Night function off (default).

Low: Small reduction in dynamic range.

High: Large reduction in dynamic range.

For **Dolby TrueHD** sources, the options are:

Auto: The Late Night function is set to “On” or “Off” automatically (default).

Off: Late Night function off.

On: Late Night function on.

Notes:

- The effect of the Late Night function depends on the material that you are playing and the intention of the original sound designer, and with some material there will be little or no effect when you select the different options.
- The Late Night function can be used only when the input source is Dolby Digital, Dolby Digital Plus, or Dolby TrueHD.
- The Late Night function is set to “Off” when the AV receiver is set to Standby. For Dolby TrueHD sources, it will be set to “Auto”.

Re-EQ Function

With the Re-EQ function, you can compensate a soundtrack whose high-frequency content is too harsh, making it more suitable for home theater viewing.

Re-EQ **Off:** Re-EQ Function off (default).
 On: Re-EQ Function on.

This function can be used with the following listening modes: Dolby Digital, Dolby Digital Plus, Dolby TrueHD, Multichannel, DTS, DTS-HD High Resolution Audio, DTS-HD Master Audio, DTS Express, DSD, Dolby EX, Dolby Pro Logic IIz Height, Dolby PLIIx Movie, Neo:6 Cinema, 5.1-channel source + Neo:6, and Neural Surround.

Re-EQ(THX) **Off:** Re-EQ (THX) Function off.
 On: Re-EQ (THX) Function on (default).

This function can be used with the following listening modes: THX Cinema, THX Surround EX, and THX Ultra2 Cinema.

Note:

Settings for the Re-EQ function are kept in each listening mode. However, in THX listening mode, when the AV receiver is turned off, it will return to “On”.

Audyssey Dynamic Volume™

Dynamic Volume See “Dynamic Volume” of “Audio Adjust” on page 102.

Note:

If you would like to use Audyssey Dynamic Volume™ in THX listening modes, set “Loudness Plus” setting to “Off” and set “Preserve THX Settings ” setting to “No”.

Dolby Volume

Dolby Volume **Off:** Dolby Volume off (default).
 Low: Low Compression Mode becomes active.
 Mid: Medium Compression Mode becomes active.
 High: High Compression Mode becomes active. This setting affects volume the most, causing all sounds to be of equal loudness.

Notes:

- When the “Dolby Volume” setting is set to effective, Audyssey Dynamic EQ™ and Audyssey Dynamic Volume™ will be set to “Off” from “Audyssey” and “Equalizer” setting will be set to “Off” or remain set to “Manual”.
- If you would like to use Dolby Volume in THX listening modes, set “Loudness Plus” setting to “Off” and set “Preserve THX Settings ” setting to “No”.

Music Optimizer

The Music Optimizer function enhances the sound quality of compressed music files. Use it with music files that use “lossy” compression, such as MP3. The setting is stored individually for each input selector.

Music Optimizer **Off:** Music Optimizer off (default).
 On: Music Optimizer on.

Note:

The Music Optimizer function only works with PCM digital audio input signals with a sampling rate below 48 kHz and analog audio input signals. The Music Optimizer is disabled when the Direct or Pure Audio listening mode is selected.

Speaker Levels

You can adjust the volume of each speaker while listening to an input source.

These temporary adjustments are cancelled when the AV receiver is set to Standby. To save the setting you made here, go to “Level Calibration” on page 97 before setting the AV receiver to Standby.

Subwoofer 1	–15.0 dB to +12.0 dB (default: 0.0 dB)
Subwoofer 2	–15.0 dB to +12.0 dB (default: 0.0 dB)
Center	–12.0 dB to +12.0 dB (default: 0.0 dB)

Notes:

- You cannot use this function while the AV receiver is muted.
- Speakers that are set to “No” or “None” in the “Speaker Configuration” cannot be adjusted (see page 95).
- This function will not work when the Pure Audio or Direct listening mode is selected to play analog audio.

Audio Selector

You can set priorities of audio output when there are both digital and analog inputs.

Audio Selector	Auto: The AV receiver gives priority to analog signals when there is no digital input (default).
	Multich: The AV receiver always outputs analog signals from multichannel analog input.
	Analog: The AV receiver always outputs analog signals.

Note:

This setting can be made only for the input source that is assigned as HDMI IN, COAXIAL IN, or OPTICAL IN. If both HDMI (HDMI IN) and digital audio inputs (COAXIAL IN or OPTICAL IN) are assigned, HDMI input will be selected as a priority by setting to “Auto”. To select the digital audio input, see “Digital Audio Input Setup” on page 56.

A/V Sync

See “A/V Sync” of “Source Setup” on page 104.

NET/USB

About NET

The AV receiver is *network-ready*, which means you can hook it up to your home network with a standard Ethernet cable and enjoy the music files stored on your computer or media server. If your network is connected to the Internet, you can also enjoy Internet radio.

Network Requirements

■ Ethernet Network

The AV receiver's Ethernet port supports 10Base-T. For best results, a 100Base-TX switched Ethernet network is recommended. Although it's possible to play music on a computer that's connected to the network wirelessly, playback may be unreliable, so wired connections are recommended.

■ Ethernet Router

A router manages the network, routing data and supplying IP addresses. Your router must support the following:

- NAT (Network Address Translation). NAT allows several networked computers to access the Internet simultaneously via a single Internet connection. The AV receiver needs Internet access for Internet radio.
- DHCP (Dynamic Host Configuration Protocol). DHCP supplies IP addresses to network devices, allowing them to configure themselves automatically.
- A router with a 100Base-TX switch built-in is recommended.

Some routers have a modem built-in, and some ISPs require you to use specific routers. Please consult your ISP or computer dealer if you're unsure.

■ CAT5 Ethernet cable

Use a shielded CAT5 Ethernet cable (straight-type) to connect the AV receiver to your home network.

■ Internet Access (for Internet radio)

To receive Internet radio, your Ethernet network must have Internet access. A narrowband Internet connection (e.g., 56K modem, ISDN) will not provide satisfactory results, so a broadband connection is strongly recommended (e.g., cable modem, xDSL modem, etc). Please consult your ISP or computer dealer if you're unsure.

Notes:

- To receive Internet radio with the AV receiver, your broadband Internet connection must be working and able to access the Web. Consult your ISP if you have any problems with your Internet connection.
- The AV receiver uses DHCP to configure its network settings automatically. If you want to configure these settings manually, see page 126.
- The AV receiver does not support PPPoE settings, so if you have a PPPoE-type Internet connection, you must use a PPPoE-compatible router.

- Depending on your ISP, you may need to specify a proxy server to use Internet radio. If your computer is configured to use a proxy server, use the same settings for the AV receiver (see page 126).

Connecting the AV Receiver

To connect the AV receiver to your home network, plug one end of a shielded CAT5 Ethernet cable into the AV receiver's ETHERNET port, and plug the other end into a LAN port on your router or switch.

The following diagram shows how you can connect the AV receiver to your home network. In this example, it's connected to a LAN port on a router, which has a 4-port 100Base-TX switch built-in.

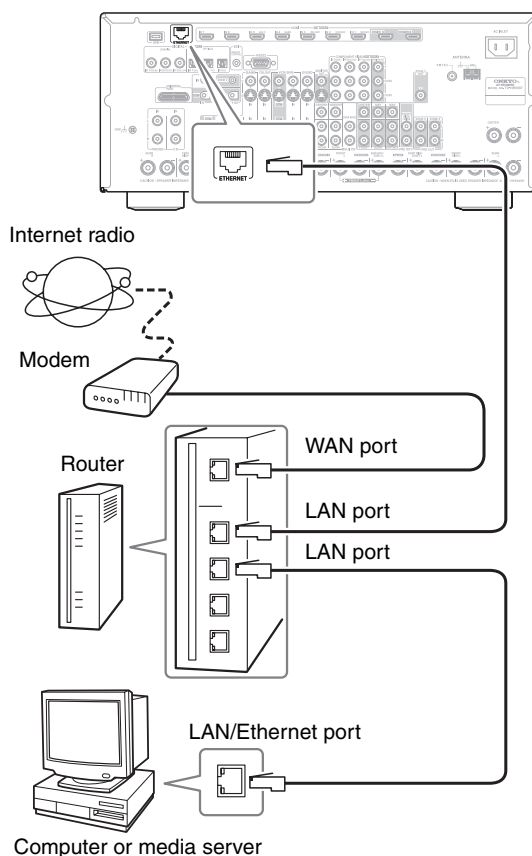

Listening to Internet Radio

To receive Internet radio, you must connect the AV receiver to a network with Internet access (page 120).

You can select Internet radio stations by connecting to the AV receiver from your computer and selecting stations in your Web browser. Preset up to 40 Internet radio stations.

Internet radio URLs in the following formats are supported: PLS, M3U, and podcast (RSS). However, depending on the type of data or audio format used by the Internet radio station, you may not be able to listen to some stations.

vTuner Internet Radio

- This unit includes the full vTuner Internet Radio Service at no additional charge. Once you have connected your unit to the Internet you can select vTuner Internet Radio to search for and play Internet radio stations and podcasts at any time. To enhance your Internet radio experience, the <http://onkyo.vtuner.com/> portal is available to you as an easy way to browse to find stations, set up/organize your favorites, add your own stations, get help, etc. After the first time you try Internet radio/vTuner on your unit you can use the MAC Address of your unit to create a member login account (email address and password) on the <http://onkyo.vtuner.com/> portal. To verify your MAC Address, please see Network Settings (page 126).

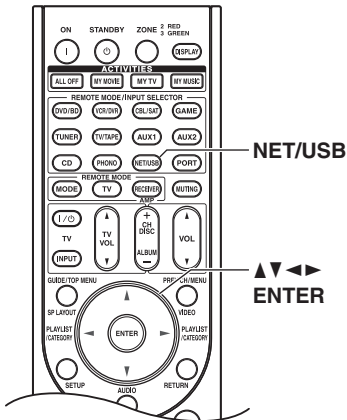

1

Press the [NET/USB] button repeatedly to select the Internet Radio screen.

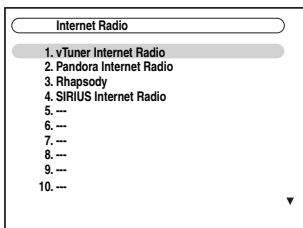

The NETWORK indicator lights up. When the program setting is finished, go to step 3.

Notes:

- When it flashes, confirm the network connection.
- Services available may vary depending on the region. See the separate instructions for more information.

2

On your computer, start your Web browser and enter the AV receiver's IP address in the browser's Internet address (URL) field.

The browser connects to the AV receiver and displays the same screen as the AV receiver.

Select the Internet radio station with your browser.

Notes:

- The AV receiver's IP address is shown on the "Network" screen (see page 126).
- If you're using DHCP, your router may not always allocate the same IP address to the AV receiver, so if you find that you can't connect to the AV receiver, check the AV receiver's IP address on "Network" screen.

3

Use the Up and Down [▲]/[▼] buttons to select a program, and then press [ENTER].



Playback starts and the following screen appears.

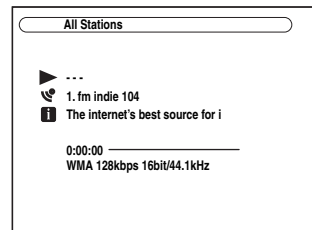

Once you've added a station to the list, simply select it on the Internet Radio screen, and then press [ENTER] to start playback.

Note:

If you're using a narrowband Internet connection (e.g., 56K modem or ISDN), depending on the station, Internet radio may not work satisfactorily. For best results, use a broadband connection (e.g., cable modem, xDSL modem, etc).

Playing Music Files on a Server

This section explains how to play music files on a computer or media server through the AV receiver. See pages 124 to 125 for details on supported music servers and music file formats.

For Windows Media Player 11, see “Windows Media Player 11 Setup” on page 123.

1 Start your computer or media server.

2 Press the [NET/USB] button to select the Server screen.

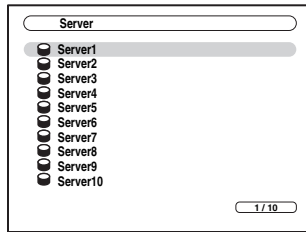

The NETWORK indicator lights up.

Notes:

- When it flashes, confirm the network connection.
- To update the screen, press the [RETURN] button.

3 Use the Up and Down [▲]/[▼] buttons to select a server, and then press [ENTER].



A list of items on the server appears.

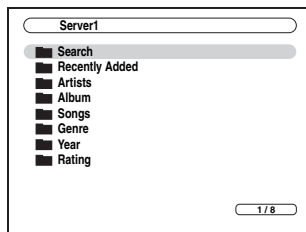

Search

You can search for music by Artist, Album, or Track.

Notes:

- The search function does not work with media servers which do not support this function.
- Depending on the sharing settings in the media server, the AV receiver may not be able to access the content. Refer to the instruction manual of the media server.

4 Use the Up and Down [▲]/[▼] buttons to select an item, and then press [ENTER].

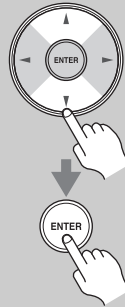

A list of music files appears.

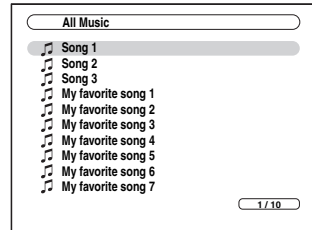

5 Use the Up and Down [▲]/[▼] buttons to select a music file, and press the [ENTER] or Play [▶] button to start playback.



Playback starts and the following screen appears.

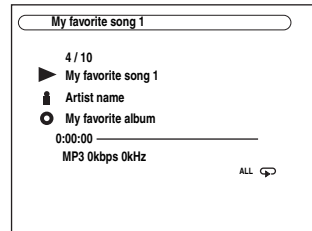

To return to the previous menu during playback, press the [RETURN] button. To stop playback, press the Stop [■] button.

To select the next song, press the Next [▶▶] button. To select the beginning of the current song, press the Previous [◀◀] button. To select the previous song, press the Previous [◀◀] button twice.

To pause playback, press the [⏸] button. To fast forward the current song, press the [▶▶▶] button. To fast reverse the current song, press the [◀◀◀] button.

Note:

For some sort of media server, Fast Forward/Fast Reverse/Pause operations do not work.

Random Playback

The Random function can only be set while the PLAY screen is displayed.

To play songs in random order, during playback (or while playback is paused or stopped), press the [RANDOM] button. All of the songs in the current folder will be played in random order. When all of the songs in the folder have been played once, they'll all be played again in a different random order. To cancel random playback, press the [RANDOM] button again.

Random playback supports up to 20000 songs per folder. If a folder contains more than this, songs over 20000 are not included in random playback.

Repeat Playback

The Repeat function can only be set while the PLAY screen is displayed.

To play songs repeatedly, during playback (or while playback is paused or stopped), press the [REPEAT] button repeatedly to select: Repeat1, Repeat Folder, Repeat All, or Off.

In Repeat1 mode, the current song is played repeatedly.

In Repeat Folder mode, all of the songs in the current folder are played repeatedly.

In Repeat All mode, all of the songs on the current server are played repeatedly.

To cancel repeat playback, press the [REPEAT] button repeatedly to select Off.

Note:

If the message "No Item." appears, this means that no information can be retrieved from the server. In this case, check your server, network, and AV receiver connections.

Windows Media Player 11 Setup

This section explains how to configure Windows Media Player 11 so that the AV receiver can play the music files stored on your computer.

1	Start Windows Media Player 11.
2	On the Library menu, select Media Sharing. The Media Sharing dialog box appears.
3	Select the Share my media check box, and then click OK.
4	Select the AV receiver in the list, and then click Allow.
5	Click OK to close the dialog box. This completes the Windows Media Player 11 configuration. You can now play the music files in your Windows Media Player 11 library through the AV receiver (see page 122).

Note:

Windows Media Player 11 can be downloaded for free from the Microsoft Web site.

Supported Audio File Formats

For server playback, the AV receiver supports the following music file formats: MP3, WMA, WAV, FLAC, Ogg Vorbis, AAC and LPCM.

■ MP3

- MP3 files must be MPEG-1/MPEG-2 Audio Layer 3 format with a sampling rate of 8 kHz, 11.025 kHz, 12 kHz, 16 kHz, 22.05 kHz, 24 kHz, 32 kHz, 44.1 kHz, 48 kHz and a bit-rate of between 8 kbps and 320 kbps. Incompatible files cannot be played.
- Number of channels: 2
- Variable bit-rate (VBR) MP3 files are supported. (Playing times may not display correctly.)
- MP3 files must have a “.mp3” or “.MP3” filename extension.

■ WMA

WMA stands for Windows Media Audio and is an audio compression technology developed by Microsoft Corporation. Audio can be encoded in WMA format by using Windows Media[®] Player.

- WMA files must have the copyright option turned off.
- Sampling rates of 8 kHz, 11.025 kHz, 12 kHz, 16 kHz, 22.05 kHz, 24 kHz, 32 kHz, 44.1 kHz, 48 kHz and bitrates of between 5 kbps and 320 kbps, and WMA DRM are supported. Incompatible files cannot be played.
- Number of channels: 2
- Variable bit-rates (VBR) are supported. (Playing times may display incorrectly with VBR.)
- WMA Pro/Voice formats are not supported.
- WMA files must have a “.wma” or “.WMA” filename extension.

■ WMA Lossless

- Sampling rates of 44.1 kHz, 48 kHz, 88.2 kHz, 96 kHz and bitrates of between 5 kbps and 320 kbps are supported. Incompatible files cannot be played.
- Quantization bit: 16 bit, 24 bit
- Number of channels: 2
- Variable bit-rates (VBR) are supported. (Playing times may display incorrectly with VBR.)
- WMA files must have a “.wma” or “.WMA” filename extension.

■ WAV

WAV files contain uncompressed PCM digital audio.

- Sampling rates of 8 kHz, 11.025 kHz, 12 kHz, 16 kHz, 22.05 kHz, 24 kHz, 32 kHz, 44.1 kHz, 48 kHz, 64 kHz, 88.2 kHz, and 96 kHz are supported. Incompatible files cannot be played.
- Quantization bit: 8 bit, 16 bit, 24 bit
- Number of channels: 2
- WAV files must have a “.wav” or “.WAV” filename extension.

■ AAC

AAC stands for MPEG-2/MPEG-4 Audio.

- Sampling rates of 8 kHz, 11.025 kHz, 12 kHz, 16 kHz, 22.05 kHz, 24 kHz, 32 kHz, 44.1 kHz, 48 kHz, 64 kHz, 88.2 kHz, 96 kHz and bitrates of between 8 and 320 kbps, are supported. Incompatible files cannot be played.
- Number of channels: 2
- Variable bit-rate (VBR) files are supported. (Playing times may not display correctly.)

AAC files must have a “.aac”, “.m4a”, “.mp4”, “.3gp”, “.3g2”, “.AAC”, “.M4A”, “.MP4”, “.3GP” or “.3G2” filename extension.

■ FLAC

FLAC is a file format for lossless audio data compression.

- Sampling rates of 8 kHz, 11.025 kHz, 12 kHz, 16 kHz, 22.05 kHz, 24 kHz, 32 kHz, 44.1 kHz, 48 kHz, 64 kHz, 88.2 kHz, and 96 kHz are supported. Incompatible files cannot be played.
- Quantization bit: 8 bit, 16 bit, 24 bit
- Number of channels: 2
- Variable bit-rates (VBR) are supported. (Playing times may display incorrectly with VBR.)
- FLAC files must have a “.flac” or “.FLAC” filename extension.

■ Ogg Vorbis

- Sampling rates of 8 kHz, 11.025 kHz, 12 kHz, 16 kHz, 22.05 kHz, 24 kHz, 32 kHz, 44.1 kHz, 48 kHz and bitrates of between 48 kbps and 500 kbps are supported. Incompatible files cannot be played.
- Number of channels: 2
- Variable bit-rates (VBR) are supported. (Playing times may display incorrectly with VBR.)
- Ogg Vorbis files must have a “.ogg” or “.OGG” filename extension.

■ LPCM (Linear PCM)

- Sampling rates of 8 kHz, 11.025 kHz, 12 kHz, 16 kHz, 22.05 kHz, 24 kHz, 32 kHz, 44.1 kHz, 48 kHz, 64 kHz, 88.2 kHz, and 96 kHz are supported.
- Quantization bit: 8 bit, 16 bit, 24 bit
- Number of channels: 2

Server Requirements

The AV receiver can play digital music files stored on a computer or media server and supports the following technologies:

- Windows Media Player 11
- Windows Media Connect 2.0
- DLNA-certified media server

If the operating system of your computer is Windows Vista, Windows Media Player 11 is already installed.

Windows Media Player 11 for Windows XP can be downloaded for free from the Microsoft Web site.

- The computer or media server must be on the same network as the AV receiver.
- Each folder may contain up to 20000 music files, and folders may be nested up to 16 levels deep.

Note:

For some sort of media server, the AV receiver may not be able to recognize it, or may not be able to play stored music files.

Minimum system requirements for Windows Media Player 11 for Windows XP

Operating system

Windows XP Home Edition (SP2), Windows XP Professional (SP2), Windows XP Tablet PC Edition (SP2), Update Rollup 2 for Windows XP Media Center Edition 2005 (KB900325), October 2006 Update Rollup for Windows XP Media Center Edition (KB925766)

Processor: 233 MHz Intel Pentium II, Advanced Micro Devices (AMD), etc.

Memory: 64 MB

Hard disk: 200 MB of free space

Drive: CD or DVD drive

Modem: 28.8 kbps

Sound card: 16-bit sound card

Monitor: Super VGA (800 x 600)

Video card: 64 MB VRAM, DirectX 9.0b

Software: Microsoft ActiveSync (only when using a Windows Mobile-based Pocket PC or smartphone)

Web browser: Microsoft Internet Explorer 6 or Netscape 7.1

About DLNA

The Digital Living Network Alliance is an international, cross-industry collaboration. Members of DLNA develop a concept of wired and wireless interoperable networks where digital content such as photos, music, and videos can be shared through consumer electronics, personal computers, and mobile devices in and beyond the home. The AV receiver certifies the DLNA Interoperability Guidelines version 1.5.

Network Settings

Note:

When modifying network settings, after modifying it is necessary to execute “Save”.

This section explains how to configure the AV receiver’s network settings manually.

If your router’s DHCP server is enabled, you don’t need to change any of these settings, as the AV receiver is set use DHCP to configure itself automatically by default (i.e., DHCP is set to Enable). If, however, your router’s DHCP server is disabled, for example, you’re using static IP addresses, you’ll need to configure these settings yourself, in which case, a knowledge of Ethernet networking is essential.

What’s DHCP?

DHCP (Dynamic Host Configuration Protocol) is used by routers, computers, the AV receiver, and other devices to automatically configure themselves on a network.

What’s DNS?

The DNS (Domain Name System) translates domain names into IP addresses. For example, when you enter a domain name such as *www.onkyouusa.com* in your Web browser, before accessing the site, your browser uses DNS to translate this into an IP address, in this case 63.148.251.142.

1



Press the [RECEIVER] button, followed by the [SETUP] button.

The main menu appears onscreen. If the main menu doesn’t appear, make sure the appropriate external input is selected on your TV.

2



Use the Up and Down [▲]/[▼] buttons to select “7. Hardware Setup”, and then press [ENTER].

The “Hardware Setup” menu appears.

7. Hardware Setup

- 1. Remote ID
- 2. Multi Zone
- 3. Tuner
- 4. HDMI
- 5. Network
- 6. Firmware Update

3

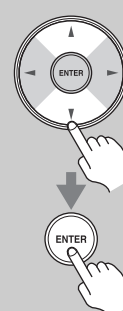

Use the Up and Down [▲]/[▼] buttons to select “5. Network”, and then press [ENTER].

The “Network” screen appears.

7-5. Network

MAC Address xx : xx : xx - yy : yy : yy

DHCP Enable

IP Address aaa.bbb.ccc.ddd

Subnet Mask aaa.bbb.ccc.ddd

Gateway aaa.bbb.ccc.ddd

DNS Server aaa.bbb.ccc.ddd

Proxy URL http://www.proxy.xxx.com

Proxy Port 8080

4



Use the Up and Down [▲]/[▼] buttons to select the setting, and use the Left and Right [◀]/[▶] buttons to set them.

To enter an IP address, select the setting, and then press [ENTER]. The arrow [▲]/[▼]/[◀]/[▶] buttons can then be used to enter numbers. Press [ENTER] again to set the number. The settings are explained below.

5



When you’ve finished, press the [RETURN] button.

The save confirmation screen appears.

7-5. Network

Save

Cancel

6



Use the Up and Down [▲]/[▼] buttons to select “Save”, and then press [ENTER].

When modifying network settings, after modifying it is necessary to execute “Save”.

7



When you’ve finished, press the [SETUP] button.

The setup menu closes.

Note:

This procedure can also be performed on the AV receiver by using its [SETUP] button, arrow buttons, and [ENTER] button.

Mac Address

This is the AV receiver's MAC (Media Access Control) address. This address cannot be changed.

DHCP

This setting determines whether or not the AV receiver uses DHCP to automatically configure its IP Address, Subnet Mask, Gateway, and DNS Server settings.

Enable: DHCP enabled.

Disable: DHCP disabled.

If you select "Disable", you must configure the "IP Address", "Subnet Mask", "Gateway", and "DNS Server" settings yourself.

IP Address

If you set the "DHCP" setting to "Disable", you must specify an IP address. Enter a static IP address provided by your ISP.

The IP address must be within the following ranges.

Class A: 10.0.0.0 to 10.255.255.255

Class B: 172.16.0.0 to 172.31.255.255

Class C: 192.168.0.0 to 192.168.255.255

Most routers use Class C IP addresses.

Subnet Mask

If you set the "DHCP" setting to "Disable", you must specify a subnet mask address.

Enter the subnet mask address provided by your ISP (typically: 255.255.255.0).

Gateway

If you set the "DHCP" setting to "Disable", you must specify a gateway address.

Enter the gateway address provided by your ISP.

DNS Server

If you set the "DHCP" setting to "Disable", you must specify a DNS server.

Enter the DNS server addresses provided by your ISP.

Proxy URL

To use a Web proxy, enter its URL here.

Proxy Port

If you're using a Web proxy, enter a proxy port number here.

Control

This setting enables or disables control over the network.

Enable: Control over the network enabled.

Disable: Control over the network disabled.

Note:

When set to "Enable", power consumption on standby mode slightly increases.

■ Port Number

This is the network port used for control over the network.

Note:

Set the port number between from "49152" to "65535".

About USB

USB can be used to play music files stored on USB mass storage devices (e.g., USB flash drives and MP3 players), which can be plugged into the AV receiver's USB port.

Supported Audio File Formats

For USB mass storage device playback, the AV receiver supports music file formats.

See "Supported Audio File Formats" on page 124.

USB Mass Storage Device Requirements

- The AV receiver supports USB devices that support the USB mass storage device class.
- Playback may not be possible with some USB devices even if they conform to the USB mass storage device class.
- USB devices formatted with the FAT16 or FAT32 file system are supported.
- If the storage device has been partitioned, each section will be treated as an independent device.
- Each folder may contain up to 20000 music files and folders, and folders may be nested up to 16 levels deep.
- USB hubs and USB devices with hub functions are not supported.

Playing Music Files on a USB Device

This section explains how to play music files on a USB mass storage device.

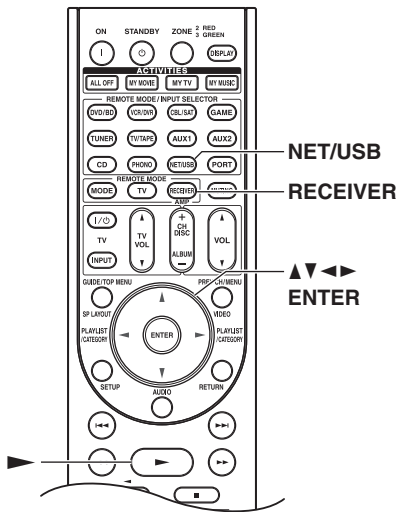

1 Plug your USB mass storage device into the AV receiver's USB port.

2 (TX-NR3007) Press the [NET/USB] button repeatedly to select the USB screen.
 (TX-NR5007) Press the [NET/USB] button repeatedly to select the USB(Front) or USB(Rear) screen.

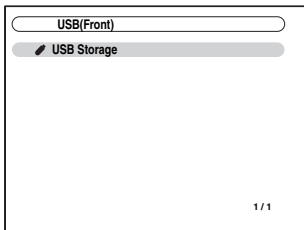

The USB indicator lights up if the AV receiver is able to read the USB mass storage device. The USB indicator flashes if the AV receiver cannot read the USB mass storage device.

3 Use the Up and Down [▲]/[▼] buttons to select a USB mass storage device, and then press [ENTER].

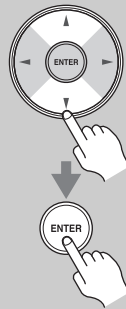

A list of the device's contents appears.

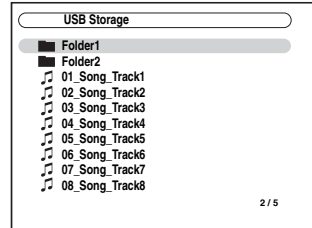

To open a folder, use the Up and Down [▲]/[▼] buttons to select it, and then press [ENTER].

4 Use the Up and Down [▲]/[▼] buttons to select a music file, and press the [ENTER] or Play [▶] button to start playback.



Playback starts and the following screen appears.

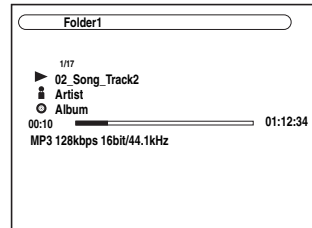

To return to the previous menu during playback, press the [RETURN] button. To stop or pause playback, press the Stop [■] or Pause [⏸] button, respectively.

To select the next song, press the Next [▶▶] button. To select the beginning of the current song, press the Previous [◀◀] button. To select the previous song, press the Previous [◀◀] button twice.

To fast forward the current song, press the [▶▶▶] button. To fast reverse the current song, press the [◀◀◀] button.

Random Playback

The Random function can only be set while the PLAY screen is displayed.

To play songs in random order, while the list of songs is displayed, press the [RANDOM] button. All of the songs in the current folder will be played in random order. When all of the songs in the folder have been played once, they'll all be played again in a different random order. To cancel random playback, press the [RANDOM] button again.

Random playback supports up to 20,000 songs per folder. If a folder contains more than this, songs over 20,000 are not included in random playback.

Repeat Playback

The Repeat function can only be set while the PLAY screen is displayed.

To play songs repeatedly, during playback (or while playback is paused or stopped), press the [REPEAT] button repeatedly to select: Repeat 1, Repeat Folder, Repeat All, or Off.

In Repeat 1 mode, the current song is played repeatedly.

In Repeat Folder mode, all of the songs in the current folder are played repeatedly.

In Repeat All mode, all of the songs on the USB mass storage device (in the same partition) are played repeatedly.

To cancel repeat playback, press the [REPEAT] button repeatedly to select Off.

Notes:

- If you connect a USB hard disk drive to the AV receiver's USB port, we recommend that you use its AC adapter to power it.
- Do not connect the AV receiver's USB port to a USB port on your computer. Music on your computer cannot be played through the AV receiver in this way.
- The AV receiver supports USB MP3 players that support the USB Mass Storage Class standard, which allows USB storage devices to be connected to computers without the need for special drivers or software. Note that not all USB MP3 players support the USB Mass Storage Class standard. Refer your USB MP3 player's instruction manual for details.
- Protected WMA music files on an MP3 player cannot be played.
- Onkyo accepts no responsibility whatsoever for the loss or damage to data stored on a USB mass storage device when that device is used with the AV receiver. We recommend that you back up your important music files beforehand.
- MP3 players containing music files that are managed with special music software, and the iPod containing music files managed with iTunes are not supported.
- Operation with all USB mass storage devices including the ability to power them is not guaranteed.
- Do not connect your USB mass storage device via a USB hub. The USB mass storage device must be connected directly to the AV receiver's USB port.

- If the USB mass storage device contains a lot of data, the AV receiver may take a while to read it.
- USB memory devices with security functions cannot be played.

Multi Zone

Multiroom Capability

You can use three speaker systems with this AV receiver—*Main room*: a surround-sound speaker system (up to 9.2 channels) for enjoying DVD movies in your main room, *Speakers B*: a pair of stereo speakers for serious music listening in your main room, *Zone 2*: a stereo speaker system in a second room, *Zone 3*: a stereo speaker system in a third room. And, you can select a different audio source for each room.

Main room: Enjoy up to 9.2-channel surround-sound playback (see pages 18 and 21).

You can enjoy the various listening modes, such as Dolby, DTS, and THX (see pages 81 to 91).

* While Powered Zone 2/3 is being used, playback is reduced to 7.2-channels (see pages 131 and 133).

Zone 2: In your Zone 2 room, you can enjoy 2-channel stereo playback and video playback (see page 131).

* The listening modes cannot be used with Zone 2.

Zone 3: In your Zone 3 room, you can enjoy 2-channel stereo playback (see page 133).

* The listening modes cannot be used with Zone 3.

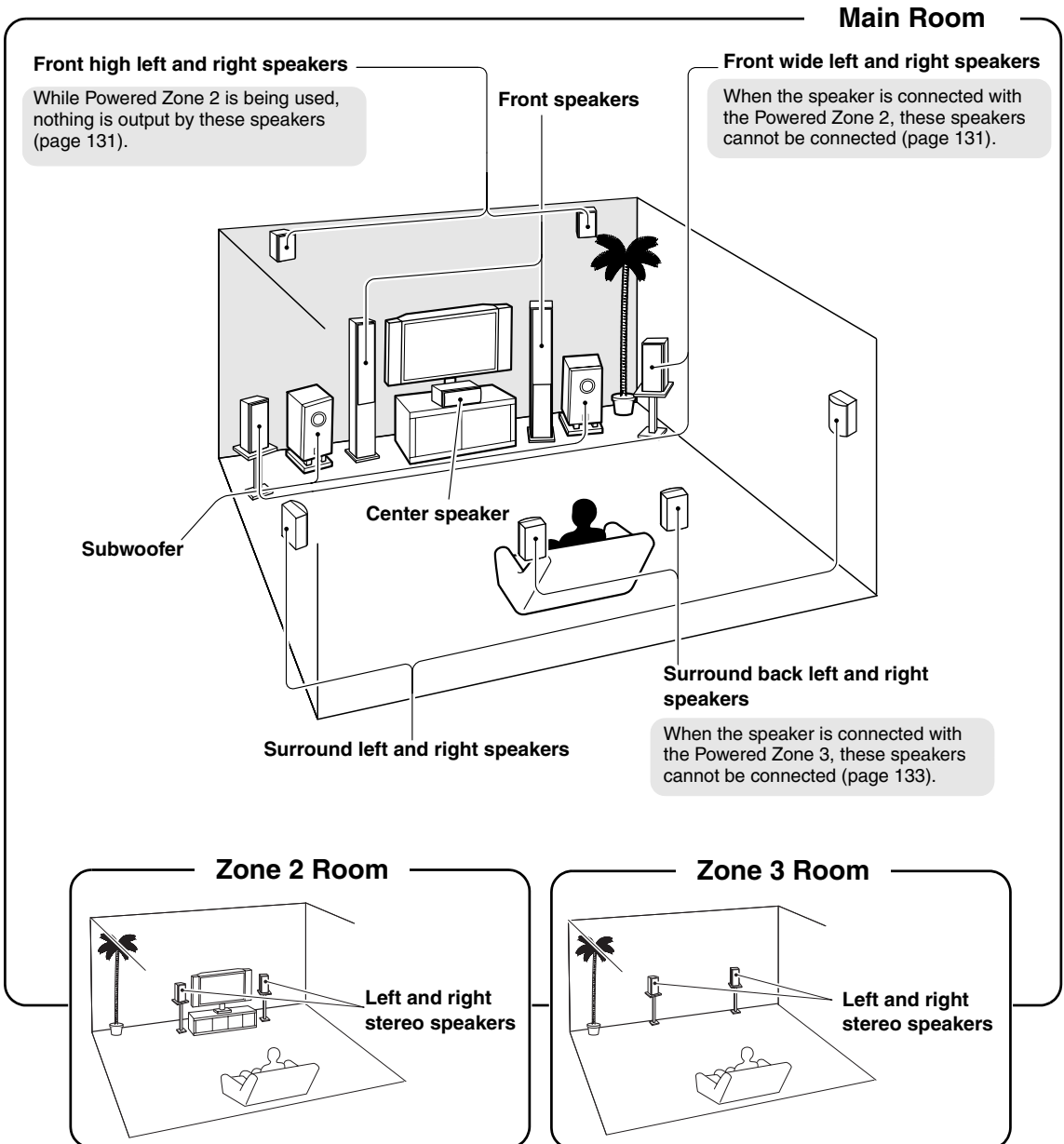

Multi Zone—Continued

In addition to your main listening room, you can also enjoy playback in the other room, or as we call Multi Zone. And, you can select a different source for each room.

Connecting Zone 2

There are two ways you can connect Zone 2 speakers:

1. Connect them directly to the AV receiver.
2. Connect them to an amp in Zone 2.

Connecting Your Zone 2 Speakers Directly to the AV receiver

This setup allows 7.2-channel playback in your main room and 2-channel stereo playback in Zone 2, with a different source in each room. This is called Powered Zone 2, as the Zone 2 speakers are powered by the AV receiver. Note that when Powered Zone 2 is turned off, you can enjoy 9.2-channel playback in your main room.

To use this setup, you must set the “Powered Zone2” setting to “Act” (see page 134).

Hookup

- Connect your Zone 2 speakers to the AV receiver’s FRONT WIDE/ZONE 2 L/R speaker terminals.

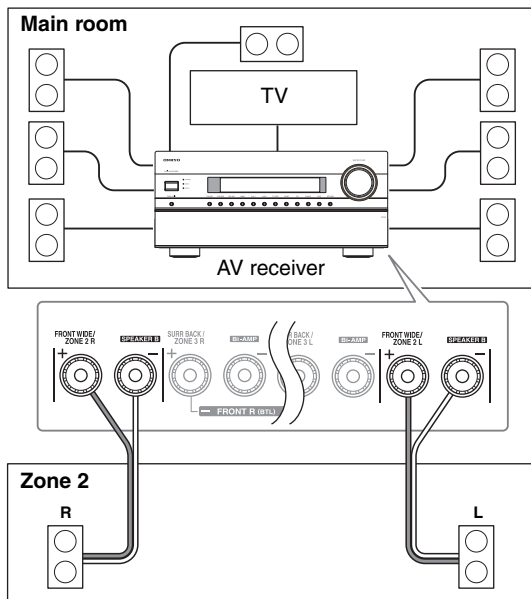

Notes:

- With this setup, the Zone 2 volume is controlled by the AV receiver.
- Powered Zone2 cannot be used if “Speakers Type(FrontB)” is set to “Normal”, “Bi-Amp” or “BTL” (see page 57).

Connecting Your Zone 2 Speakers to an Amp in Zone 2

This setup allows 9.2-channel playback in your main listening room and 2-channel stereo playback in Zone 2, with a different source in each room.

Hookup

- Use an RCA audio cable to connect the AV receiver’s ZONE 2 PRE OUT L/R jacks to an analog audio input on your Zone 2 amp.
- Connect your Zone 2 speakers to the speaker terminals on your Zone 2 amp.

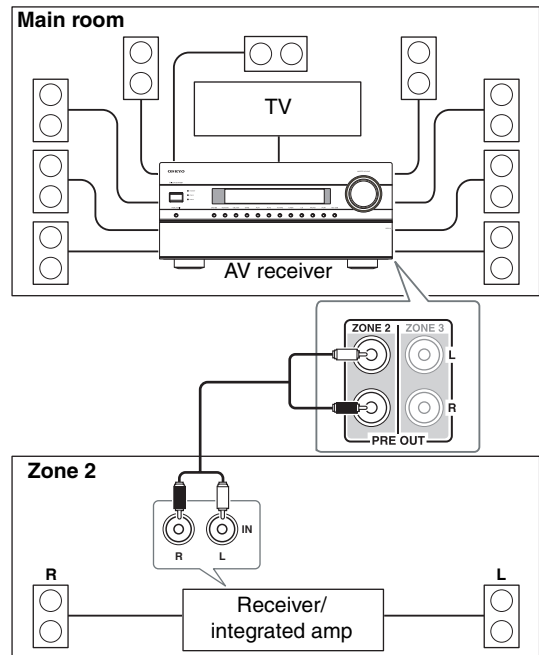

Note:

With the default settings, the Zone 2 volume must be set on the Zone 2 amp. If your Zone 2 amp has no volume control, set the “Zone2 Out” setting to “Variable” so that you can set the Zone 2 volume on the AV receiver (see page 135).

Zone 2 Video Output

The AV receiver features a composite video output for connection to a TV in Zone 2, so you can enjoy both audio and video in that zone.

Hookup

- Use a composite video cable to connect the AV receiver's ZONE 2 OUT V jack to a composite video input on your Zone 2 TV.

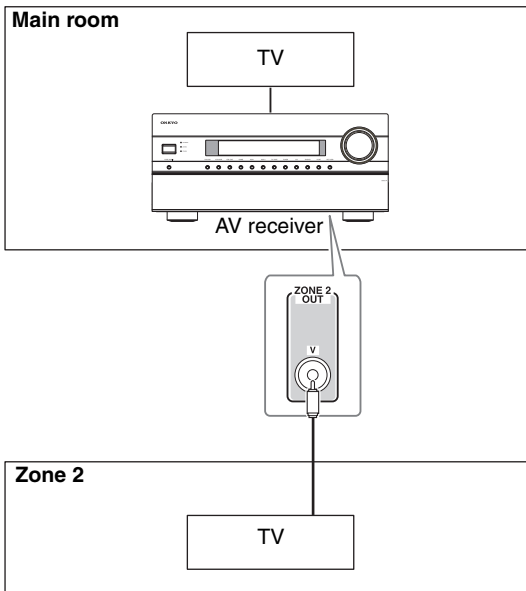

Note:

The ZONE 2 OUT V jack outputs video from components connected to composite video only.

Zone 2 12V Trigger

When Zone 2 is turned on, the output from the 12V TRIGGER OUT ZONE 2 goes high (+12 volts, 150 milliamperes max). Connecting this jack to a 12-volt trigger input on a component in Zone 2 will make that component turn on or off as and when Zone 2 is turned on or off on the AV receiver.

Connecting Zone 3

- There are two ways you can connect Zone 3 speakers:
1. Connect them directly to the AV receiver.
 2. Connect them to an amp in Zone 3.

Connecting Your Zone 3 Speakers Directly to the AV receiver

This setup allows 7.2-channel playback in your main room and 2-channel stereo playback in Zone 3, with a different source in each room. This is called Powered Zone 3, as the Zone 3 speakers are powered by the AV receiver. Note that when Powered Zone 3 is turned off, you can enjoy 9.2-channel playback in your main room.

To use this setup, you must set the “Powered Zone3” setting to “Act” (see page 134).

Hookup

- Connect your Zone 3 speakers to the AV receiver’s SURR BACK/ZONE 3 L/R speaker terminals.

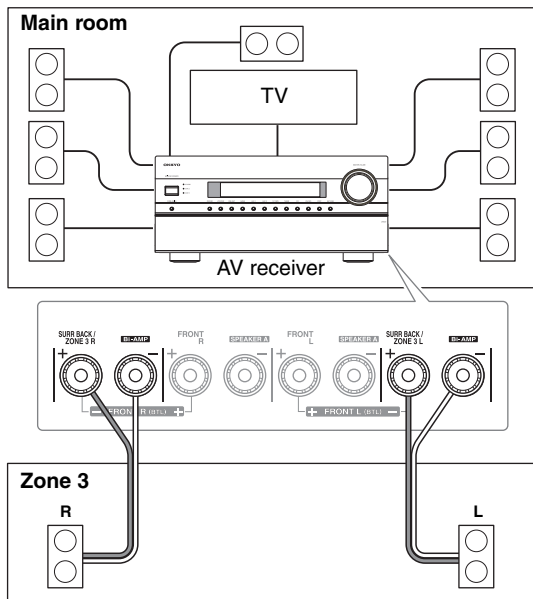

Notes:

- With this setup, the Zone 3 volume is controlled by the AV receiver.
- PoweredZone3 cannot be used if “Speakers Type(FrontA)” or “Speakers Type(FrontB)” is set to “Bi-Amp” or “BTL” (see page 57).

Connecting Your Zone 3 Speakers to an Amp in Zone 3

This setup allows 9.2-channel playback in your main listening room and 2-channel stereo playback in Zone 3, with a different source in each room.

Hookup

- Use an RCA audio cable to connect the AV receiver’s ZONE 3 PRE OUT L/R jacks to an analog audio input on your Zone 3 amp.
- Connect your Zone 3 speakers to the speaker terminals on your Zone 3 amp.

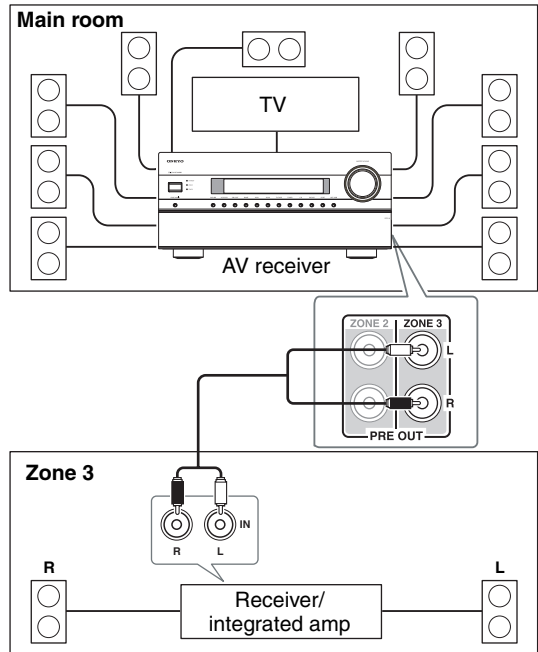

Note:

With the default settings, the Zone 3 volume must be set on the Zone 3 amp. If your Zone 3 amp has no volume control, set the “Zone3 Out” setting to “Variable” so that you can set the Zone 3 volume on the AV receiver (see page 135).

Zone 3 12V Trigger

When Zone 3 is turned on, the output from the 12V TRIGGER OUT ZONE 3 goes high (+12 volts, 25 milliamperes max). Connecting this jack to a 12-volt trigger input on a component in Zone 3 will make that component turn on or off as and when Zone 3 is turned on or off on the AV receiver.

Setting the Powered Zone 2/3

If you've connected your Zone 2/3 speakers to the AV receiver, as explained in "Connecting Your Zone 2 Speakers Directly to the AV receiver" on page 131 or "Connecting Your Zone 3 Speakers Directly to the AV receiver" on page 133, you must set the "Powered Zone2" or "Powered Zone3" setting to "Act" (Activated).

1 Press the [RECEIVER] button followed by the [SETUP] button. The main menu appears onscreen. If the main menu doesn't appear, make sure the appropriate external input is selected on your TV.



2 Use the Up and Down [▲]/[▼] buttons to select "2. Speaker Setup", and then press [ENTER]. The "Speaker Setup" menu appears.

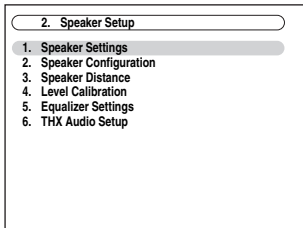
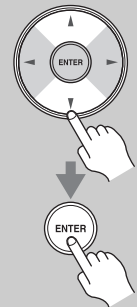

3 Use the Up and Down [▲]/[▼] buttons to select "1. Speaker Settings", and then press [ENTER]. The "Speaker Settings" menu appears.

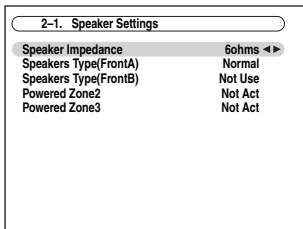
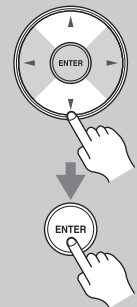

4 Use the Up and Down [▲]/[▼] buttons to select "Powered Zone2" or "Powered Zone3", and use the Left and Right [◀]/[▶] buttons to select:

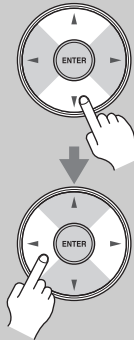

Not Act:
ZONE 2/3 L/R speaker terminals not activated (Powered Zone 2/3 disabled).

Act:
ZONE 2/3 L/R speaker terminals activated (Powered Zone 2/3 enabled).

5 Press the [SETUP] button. The setup menu closes.



Notes:

- Powered Zone2 cannot be used if "Speakers Type(FrontB)" setting set to "Normal", "Bi-Amp" or "BTL" (see page 58).
- Powered Zone3 cannot be used if "Speakers Type(FrontA)" or "Speakers Type(FrontB)" setting set to "Bi-Amp" or "BTL" (see page 58).
- This procedure can also be performed on the AV receiver by using its [SETUP] button, arrow buttons, and [ENTER] button.

Setting the Multi Zone

1 Press the [RECEIVER] button followed by the [SETUP] button.
The main menu appears onscreen.
If the main menu doesn't appear, make sure the appropriate external input is selected on your TV.

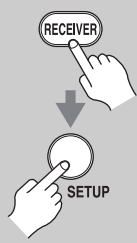

2 Use the Up and Down [▲]/[▼] buttons to select "7. Hardware Setup", and then press [ENTER].
The "Hardware Setup" menu appears.

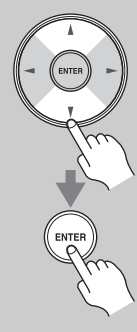

7. Hardware Setup	
1. Remote ID	
2. Multi Zone	
3. Tuner	
4. HDMI	
5. Network	
6. Firmware Update	

3 Use the Up and Down [▲]/[▼] buttons to select "2. Multi Zone", and then press [ENTER].
The "Multi Zone" menu appears.

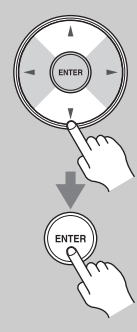

7-2. Multi Zone	
Zone2 Out	Fixed ◀▶
Zone2 Maximum Volume	Off
Zone2 Power On Volume	Last
Zone3 Out	Fixed
Zone3 Maximum Volume	Off
Zone3 Power On Volume	Last

4 Use the Up and Down [▲]/[▼] buttons to select an item, and use the Left and Right [◀]/[▶] buttons to change it.
The items are explained below.

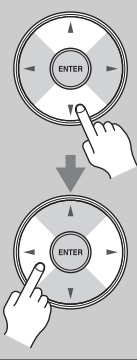

5 When you've finished, press the [SETUP] button.
The setup menu closes.



Note:
This procedure can also be performed on the AV receiver by using its [SETUP] button, arrow buttons, and [ENTER] button.

■ Zone2/3 Out
If you've connected your Zone 2/3 speakers to an amp with no volume control, set the "Zone2 Out" and "Zone3 Out" setting, respectively, to "Variable" so that you can set the volume, balance, and tone of zone 2/3 on the AV receiver.

Fixed: The Zone 2/3 volume must be set on the amp in that zone (default).

Variable: The Zone 2/3 volume can be set on the AV receiver.

■ Zone2/3 Maximum Volume
With this setting, you can limit the maximum volume for Zone 2/3. When the "Volume Display" setting is set to "Absolute", the "Maximum Volume" range is 50 to 99. When it's set to "Relative", the range is -32 dB to +17 dB. To disable this setting, select "Off".

■ Zone2/3 Power On Volume
This setting determines what the volume will be for Zone 2/3 each time the AV receiver is turned on. When the "Volume Display" preference is set to "Absolute", the range is "Last", "Min", 1 to 99, or "Max". When it's set to "Relative", the range is "Last", $-\infty$ dB, -81 dB to +18 dB.

To use the same volume level as when the AV receiver was last turned off, select "Last".

The "Zone2/3 Power On Volume" cannot be set higher than the "Zone2/3 Maximum Volume" setting.

Using Zone 2/3

This section explains how to turn Zone 2/3 on and off, how to select an input source for Zone 2/3, and how to adjust the volume for Zone 2/3.

Controlling Zone 2/3 from the AV receiver

ZONE 3 indicator

ZONE 2 indicator

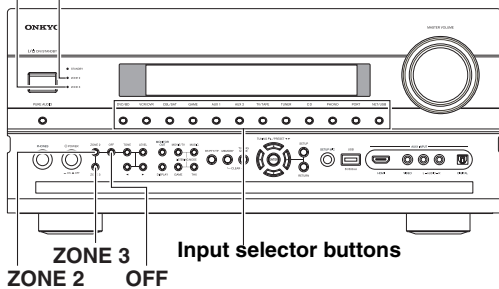

1 To turn on Zone 2/3 and select an input source, press the [ZONE 2] or [ZONE 3] button followed by an input selector button within 8 seconds.



Zone 2/3 turns on, the ZONE 2/3 indicator lights up.

Tip: The 12V TRIGGER OUT ZONE 2/3 goes high (+12 V).

To select AM or FM press the [TUNER] input selector and the [ZONE 2] or [ZONE 3] button repeatedly. You can also select SIRIUS (North American models).

To select the same source as that of the main room, press the [ZONE 2] or [ZONE 3] button twice. “Zone 2 Selector: Source” or “Zone 3 Selector: Source” appears on the display.

2 To turn off Zone 2/3, press the [ZONE 2] or [ZONE 3] button.



The ZONE 2 or ZONE 3 indicator flashes.

Press the [OFF] button.

The zone is turned off, and the ZONE 2 or ZONE 3 indicator goes off.



Note:

When Zone 2/3 is turned off, the output from the 12V TRIGGER OUT ZONE 2/3 goes low (0 volts).

Controlling Zone 2/3 with the Remote Controller

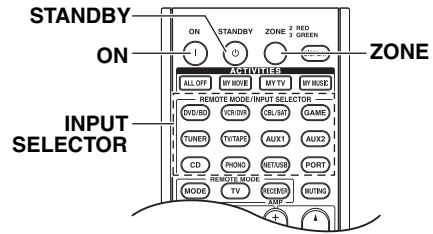

Note:

To control Zone 2/3, you must press the remote controller’s [ZONE] button first.

The ZONE button turns red while Zone 2 is on, and green while Zone 3 is on.

1 **ZONE** Press the [ZONE] button repeatedly, then point the remote controller at the AV receiver and press the [ON] button.



Tip: The 12V TRIGGER OUT ZONE 2/3 goes high (+12 V).

2 **ZONE** To select an input source for Zone 2/3, press the [ZONE] button repeatedly, followed by an INPUT SELECTOR button.



To select AM or FM press the [TUNER] INPUT SELECTOR and the [ZONE] button repeatedly. You can also select SIRIUS (North American models).



3 **ZONE** To turn off Zone 2/3, press the [ZONE] button repeatedly, followed by the [STANDBY] button.



Notes:

- Only analog input sources are output by the ZONE 2/3 PRE OUT and ZONE 2/3 L/R speaker terminals. Digital input sources are not output. If no sound is heard when an input source is selected, check if it's connected to an analog input.
- You cannot select different AM or FM radio stations for your main room and Zone 2/3. The same AM/FM radio station will be heard in each room. For example, if you have an FM station for the main room, that station will also be used in Zone 2.
- When you connect Zone 2 speakers directly to the AV receiver, listening modes that require front high or front wide speakers such as Dolby Pro Logic IIz Height or Audyssey Dynamic Surround Expansion™ are unavailable.
- When you connect Zone 3 speakers directly to the AV receiver, listening modes that require surround back speakers such as Dolby EX, DTS-ES or THX Ultra2 Cinema are unavailable.
- When the input selector of Zone 2/3 is selected, power consumption on standby mode slightly increases.
- While Zone 2/3 is on, **R**I functions will not work.



Adjusting the Volume for Zones

 <p>Remote controller ZONE</p> <p>VOL</p>	<p>On the remote controller, press the [ZONE] button repeatedly, and then use the VOL [▲]/[▼] button.</p>
 <p>AV receiver</p> <p>ZONE 2</p> <p>ZONE 3</p> <p>LEVEL</p>	<p>On the AV receiver, press the [ZONE 2] or [ZONE 3] button (the ZONE 2/3 indicator and Zone 2/3 selector on the display flashes) and press [LEVEL] button followed by the [◀]/[▶] buttons within 8 seconds.</p>

Muting Zones

 <p>Remote controller</p> <p>ZONE</p> <p>MUTING</p>	<p>On the remote controller, press the [ZONE] button repeatedly, and then press the [MUTING] button.</p> <p>To unmute a zone, on the remote controller, press the [ZONE] button, and then press the [MUTING] button again.</p>
--	--

Adjusting the Tone and Balance of Zones

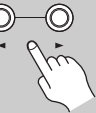
 <p>1</p> <p>AV receiver</p> <p>ZONE 2</p> <p>ZONE 3</p>	<p>On the AV receiver, press the [ZONE 2] or [ZONE 3] button.</p>
 <p>2</p> <p>TONE</p>	<p>Press the AV receiver's [TONE] button repeatedly to select "Bass", "Treble" or "Balance".</p>
 <p>3</p>	<p>Use the Up [▶] and Down [◀] buttons to adjust the bass, treble or balance.</p> <ul style="list-style-type: none"> • You can boost or cut the bass or treble from -10 dB to +10 dB in 2 dB steps. • You can adjust the balance from 0 in the center to +10 dB to the right or +10 dB to the left in 2 dB steps.

Notes:

- Zones can also be unmuted by adjusting the volume.
- The volume, tone and balance functions cannot be set when the "Zone2 Out" or "Zone3 Out" setting is set to "Fixed" (page 135) and "Powered Zone2" or "Powered Zone3" setting is set to "Not Act" (page 134).
- Even if you repeatedly press the remote controller's [ZONE] button to select zones, the last zone selection will be retained once you have switched to other components by pressing other REMOTE MODE buttons after pressing the [ZONE] button.

Using the Remote Controller in Zone 2/3 and Multiroom Control Kits

To control the AV receiver with the remote controller while you're in Zone 2 or Zone 3, you'll need a commercially available multiroom remote control kit for each zone.

- Multiroom kits are made by Niles and Xantech. These kits can also be used when there isn't a clear line of sight to the AV receiver's remote sensor, such as when it's installed inside a cabinet.

Using a Multiroom Kit with Zone 2/3

In this setup, the IR receiver in Zone 2/3 picks up the infrared signals from the remote controller and feeds them through to the AV receiver in the main room via the connecting block.

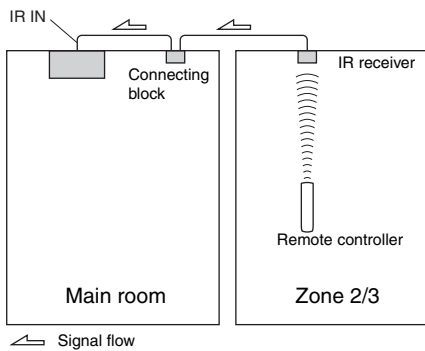

The miniplug cable from the connecting block should be connected to the AV receiver's IR IN jack, as shown below.

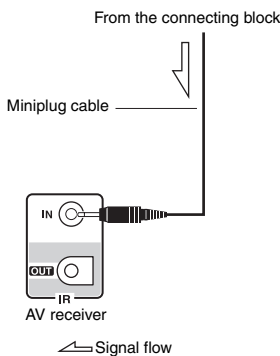

Using a Multiroom Kit with a Cabinet

In this setup, the IR receiver picks up the infrared signals from the remote controller and feeds them to the AV receiver located in the cabinet via the connecting block.

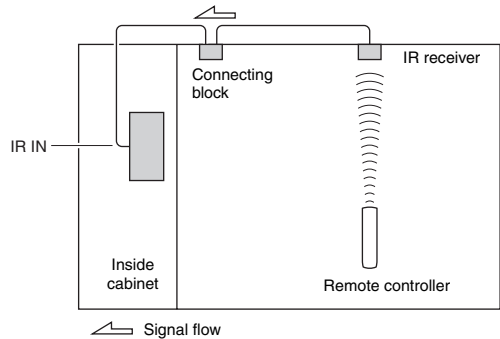

Using a Multiroom Kit with Other Components

In this setup, an IR emitter is connected to the AV receiver's IR OUT jack and placed in front of the other component's remote control sensor. Infrared signals received at the AV receiver's IR IN jack are fed through to the other component via the IR emitter. Signals picked up by the AV receiver's remote control sensor are not output.

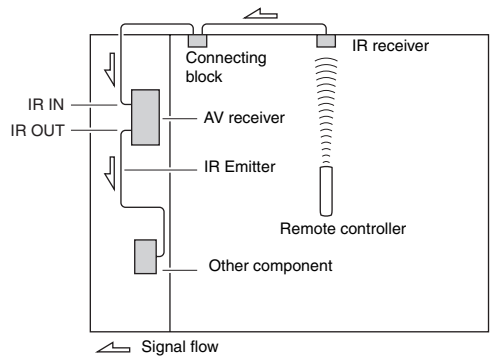

The IR emitter should be connected to the AV receiver's IR OUT jack, as shown below.

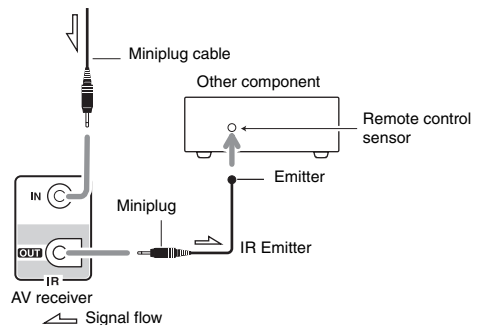

Controlling Other Components

You can use the AV receiver's remote controller (RC-747M) to control your other AV components, including those made by other manufacturers. This section explains how to enter the remote control code for a component that you want to control: DVD, TV, VCR, etc.

- Learn commands directly from another component's remote controller (see page 152).
- Program the ACTIVITIES buttons to perform a sequence of up to 32 remote control actions (see page 153).

Preprogrammed Remote Control Codes

The following REMOTE MODE buttons are preprogrammed with remote control codes for controlling the components listed. You do not need to enter a remote control code to control these components.

For details on controlling these components, see the pages indicated.

- DVD/BD** Onkyo DVD player (page 144)
- CD** Onkyo CD player (page 147)
- TV/TAPE** Onkyo cassette recorder with **RI** (page 149)

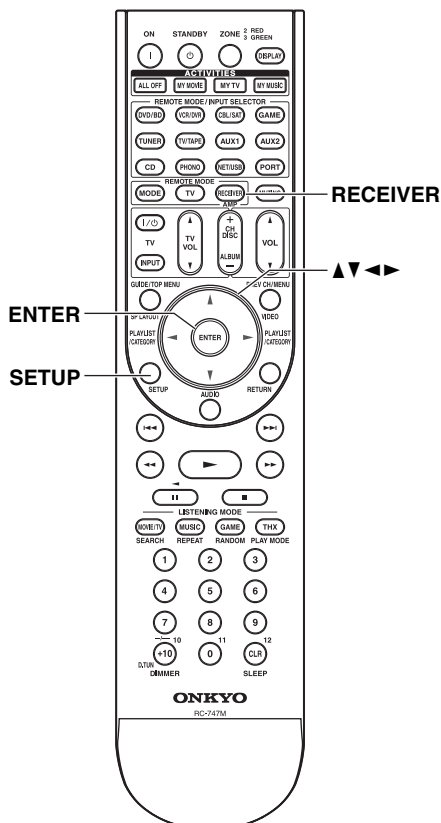

Looking up for Remote Control Code

You can look up for appropriate remote control code from onscreen setup menu.

Note:

This setting can be carried out by using Onscreen Setup Menu only.

- 1** Press the **[RECEIVER]** button followed by the **[SETUP]** button. The main menu appears onscreen. If the main menu doesn't appear, make sure the appropriate external input is selected on your TV.
- 2** Use the Up and Down **[▲]/[▼]** buttons to select "8. Remote Controller Setup", and then press **[ENTER]**.

8. Remote Controller Setup

 - 1. Remote Mode Setup
 - 2. Activities Setup
- 3** Use the Up and Down **[▲]/[▼]** buttons to select "1. Remote Mode Setup", and then press **[ENTER]**.

8-1. Remote Mode Setup

 - TV
 - DVD/BD
 - VCR/DVR
 - CBL/SAT
 - GAME
 - AUX 1

AUX 2

 - TV/TAPE
 - CD
 - PHONO
- 4** Use the Up and Down **[▲]/[▼]** buttons to select remote mode, and then press **[ENTER]**. The category selection menu appears.

8-1. Remote Mode Setup **TV**

 - TV
 - TV/DVD
 - TV/VCR

5

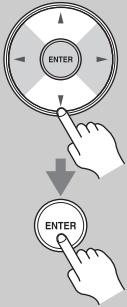

Use the Up and Down [▲]/[▼] buttons to select category, and then press [ENTER].

The brand name input panel appears.

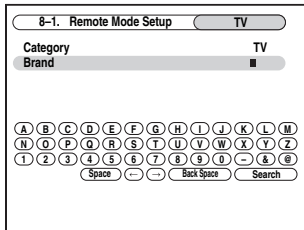

6

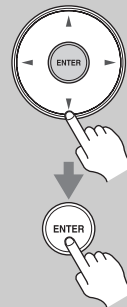

Use the arrow [▲]/[▼]/[◀]/[▶] buttons to select a character, and then press [ENTER].

Repeat this step from the 1st character to the 3rd character of the brand name. When you have entered the 3rd character, select “Search” and press [ENTER].

After searching, a list of the brand name appears.

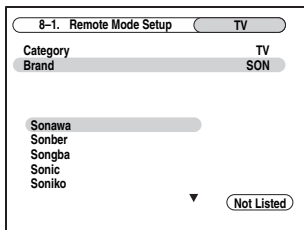

If the brand name is not found:

Use the Right [▶] button to select “Not Listed”, and then press [ENTER].

The brand name input panel appears.

7

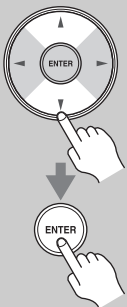

Use the Up and Down [▲]/[▼] buttons to select brand, and then press [ENTER].

After searching is completed, a message for remote control code transfer will appear.

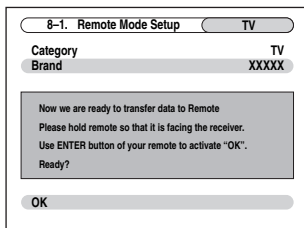

8

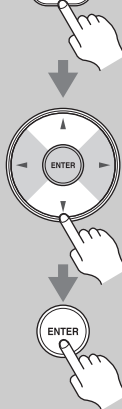

If you can control component, press the [RECEIVER] button, use the Up and Down [▲]/[▼] buttons to select “Works”, and then press [ENTER].

The “Remote Mode Setup” menu appears.

If you cannot control component, use the Up and Down [▲]/[▼] buttons to select “Doesn't work (try next Code)” and press [ENTER].

The next code is appear.

9



When you've finished, press the [SETUP] button.

The setup menu closes.

To use the remote controller, point it at the AV receiver's remote control sensor, as shown below.

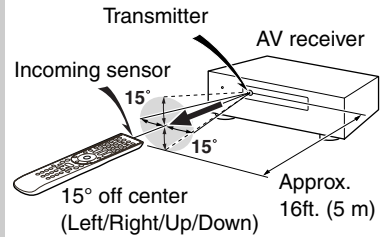

On the remote controller press the [ENTER] button.

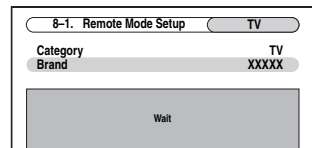

When the transfer is successful, the following screen appears. Try it.

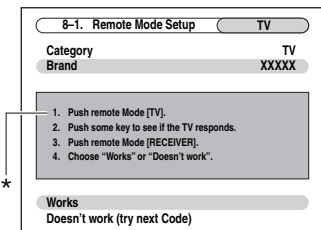

* When category other than TV have been selected, the content is different.

Entering Remote Control Codes

You'll need to enter a code for each component that you want to control.

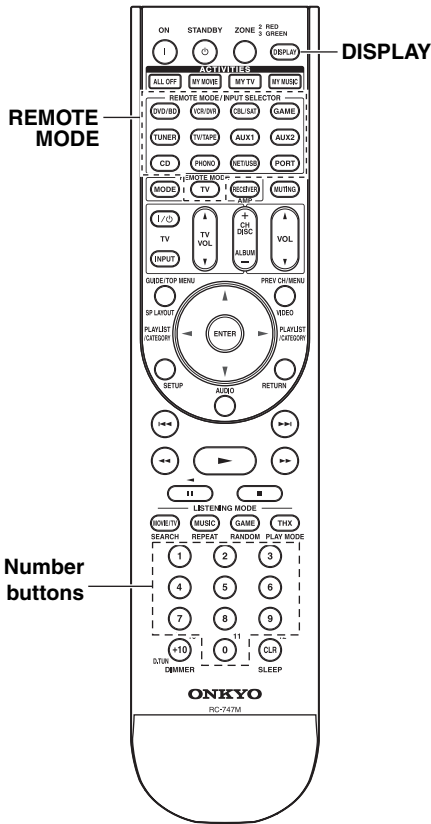

1

Look up the appropriate remote control code in the separate **Remote Control Codes list**.

The codes are organized by category (e.g., DVD player, TV, etc.).

2

While holding down the **REMOTE MODE** button to which you want to enter a code, press and hold down the **[DISPLAY]** button (about 3 seconds).

The **REMOTE MODE** button lights up.

Notes:

- Remote control codes cannot be entered for the [RECEIVER] and [ZONE] buttons.
- Only TV remote control codes can be entered for the [TV] button.
- Except for the [RECEIVER], [TV], and [ZONE] buttons, remote control codes from any category can be entered for the **REMOTE MODE** buttons. However, these buttons also work as input selector buttons (page 67), so choose a **REMOTE MODE** button that corresponds with the input to which you connect your component. For example, if you connect your CD player to the CD input, choose the [CD] button when entering its remote control code.

3

Within 30 seconds, use the **number buttons** to enter the **5-digit remote control code**.



The **REMOTE MODE** button flashes twice.

If the remote control code is not entered successfully, the **REMOTE MODE** button will flash once slowly.

Note:

The remote control codes provided are correct at the time of printing, but are subject to change.

Remote Control Codes for Onkyo Components Connected via RI

Onkyo components that are connected via **RI** are controlled by pointing the remote controller at the AV receiver, not the component. This allows you to control components that are out of view, in a rack, for example.

- 1** Make sure the Onkyo component is connected with an **RI** cable and an analog audio cable (**RCA**).
See page 47 for details.
- 2** Enter the appropriate remote control code for the **REMOTE MODE** button.
 - [DVD/BD] button
31612: Onkyo DVD player with **RI**
 - [CD] button
71327: Onkyo CD player with **RI**
 - [TV/TAPE] button
42157: Onkyo cassette recorder with **RI** (default)
 - [PORT] button
82351: Onkyo Dock (default)

See the previous page for how to enter remote control codes.
- 3** Press the **REMOTE MODE** button, point the remote controller at the AV receiver, and operate the component.

If you want to control an Onkyo component by pointing the remote controller directly at it, or you want to control an Onkyo component that's not connected via **RI**, use the following remote control codes:

- [DVD/BD] button
30627: Onkyo DVD player without **RI** (default)
- [CD] button
71817: Onkyo CD player without **RI** (default)
- [TV] button
11807: TV with **RIHD** (default)

If you want to control an Onkyo component by pointing the remote controller directly at it, use the following remote control codes:

- 32900**: Onkyo BD player
- 32901**: Onkyo HD DVD player
- 70868**: Onkyo MD recorder
- 71323**: Onkyo CD recorder
- 81993**: Onkyo RI Dock with **RI**

Note:

If you connect an **RI**-capable Onkyo RI Dock to the TV/TAPE, VCR/DVR, or GAME jacks, for **RI** to work properly, you must set the Input Display accordingly (see page 60).

Resetting REMOTE MODE Buttons

You can reset a **REMOTE MODE** button to its default remote control code.



1 While holding down the **REMOTE MODE** button that you want to reset, press and hold down the [AUDIO] button until the **REMOTE MODE** button lights up (about 3 seconds).



2 Within 30 seconds, press the **REMOTE MODE** button again. The **REMOTE MODE** button flashes twice, indicating that the button has been reset. Each of the **REMOTE MODE** buttons is preprogrammed with a remote control code. When a button is reset, its preprogrammed code is restored.
Note:
The learning command is also reset.

Resetting the Remote Controller

You can reset the remote controller to its default settings.



1 While holding down the [RECEIVER] button, press and hold down the [AUDIO] button until the [RECEIVER] button lights up (about 3 seconds).



2 Within 30 seconds, press the [RECEIVER] button again. The [RECEIVER] button flashes twice, indicating that the remote controller has been reset.

Controlling a TV

By pressing the [TV] button that's been programmed with the remote control code for TV, you can control your TV with the following buttons.

For details on entering a remote control code for a different component, see page 141.

The [TV] button is preprogrammed with the remote control code for controlling a TV that supports the **RIHD***¹ (limited to some models). The TV must be able to receive remote control commands via **RIHD** and be connected to the AV receiver via HDMI. If controlling your TV via **RIHD** doesn't work very well, program your TV's remote control code into the [TV] button and use the TV remote mode to control your TV.

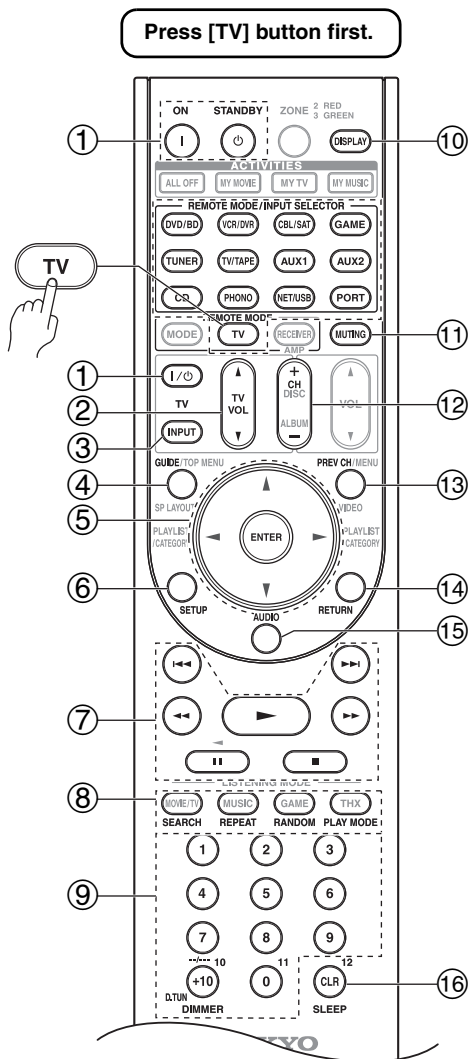

- ① **ON, STANDBY, TV [I/⏻] buttons**
Set the TV to On or Standby.
- ② **TV VOL [▲]/[▼] button**
Adjust the TV's volume.
- ③ **TV [INPUT] button**
Selects the TV's external inputs.
- ④ **GUIDE button**
Displays the program guide.
- ⑤ **Arrow [▲]/[▼]/[◀]/[▶] and ENTER buttons**
Used to navigate menus and select items.
- ⑥ **SETUP button**
Displays a menu.
- ⑦ **[◀◀], [||], [■], [◀◀], [▶▶], [◀◀], [▶▶] buttons***
Play, Pause, Stop, Fast reverse, Fast forward, Previous, and Next.
These buttons works for combination devices.
- ⑧ **SEARCH, REPEAT, RANDOM, and PLAY MODE buttons**
Function as colored buttons or A, B, C, D buttons.
- ⑨ **Number buttons**
Enter numbers. 0 button enters 11 on some components. +10 button* works as "--/--" button or +10.
- ⑩ **DISPLAY button**
Displays information.
- ⑪ **MUTING button**
Mutes the TV.
- ⑫ **CH +/- button**
Select channels on the TV.
- ⑬ **PREV CH button**
Selects the previous or last channel.
- ⑭ **RETURN button**
Exits the TV's setup menu.
- ⑮ **AUDIO button***
Selects foreign language soundtracks and audio formats (e.g., Dolby Digital or DTS).
- ⑯ **CLR button**
Cancels functions and clears entered numbers, or enters 12.

Notes:

- With some components, certain buttons may not work as expected, and some may not work at all.
- Buttons marked with an asterisk (*) are not supported by the **RIHD** function.

*1 The **RIHD** supported by the AV receiver is the CEC system control function of the HDMI standard.

Controlling a DVD Player or DVD Recorder

By pressing the REMOTE MODE button that's been programmed with the remote control code for your DVD player (HD DVD, Blu-ray, or TV/DVD combination), you can control your player with the following buttons.

The [DVD/BD] button is preprogrammed with the remote control code for controlling an Onkyo DVD player.

For details on entering a remote control code for a different component, see page 141.

The [DVD/BD] button is preprogrammed with the remote control code for controlling a component that supports the **RIHD***1. The component must be able to receive remote control commands via **RIHD** and be connected to the AV receiver via HDMI. If controlling your component via **RIHD** doesn't work very well, program your component's remote control code into the [DVD/BD] button and use the DVD/BD remote mode to control your component.

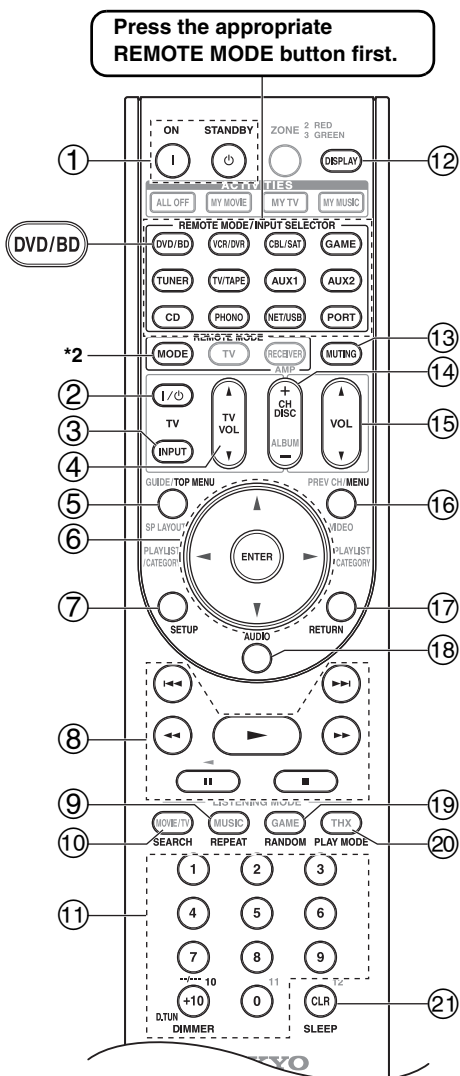

*2 When you want to change the remote controller mode without changing the current input source, press the [MODE] button and within about eight seconds, press the REMOTE MODE button. Then, with the AV receiver's remote controller, you can control the component corresponding to the button you pressed.

- ① **ON, STANDBY buttons**
Sets the DVD player to On or Standby.
- ② **TV [I/O] button**
Set the TV to On or Standby.
- ③ **TV [INPUT] button**
Selects the TV's external inputs.
- ④ **TV VOL [▲]/[▼] button**
Adjust the TV's volume.
- ⑤ **TOP MENU button**
Displays a DVD's top menu or a DVD's title.
- ⑥ **Arrow [▲]/[▼]/[◀]/[▶] and ENTER buttons**
Used to navigate menus and select items.
- ⑦ **SETUP button**
Used to access the DVD player's settings.
- ⑧ **[▶], [II], [■], [◀◀], [▶▶], [◀◀], [▶▶] buttons**
Play, Pause, Stop, Fast reverse, Fast forward, Previous, and Next.
- ⑨ **REPEAT button**
Used with the repeat playback functions.
- ⑩ **SEARCH button***
Used to search title, chapter, and track numbers, and to search times for locating specific points.
- ⑪ **Number buttons**
Used to enter title, chapter, and track numbers, and to enter times for locating specific points. The [+10] button* works as a +10 button or "--/--" button.
- ⑫ **DISPLAY button**
Displays information about the current disc, title, chapter, or track, including elapsed time, remaining time, total time, and so on.
- ⑬ **MUTING button (69)**
Mutes or unmutes the AV receiver.
- ⑭ **CH +/-, DISC +/- button**
Selects discs on a DVD changer. Selects TV channels on a component with a built-in tuner.
- ⑮ **VOL [▲]/[▼] button (67)**
Adjusts the volume of the AV receiver.
- ⑯ **MENU button**
Displays a DVD's menu.
- ⑰ **RETURN button**
Exits the DVD player's setup menu or returns to the previous menu.
- ⑱ **AUDIO button***
Selects foreign language soundtracks and audio formats (e.g., Dolby Digital or DTS).
- ⑲ **RANDOM button***
Used with the random playback function.

*1 The **RIHD** supported by the AV receiver is the CEC system control function of the HDMI standard.

Controlling Other Components—Continued

- 20 **PLAY MODE button***
Selects play modes on components with selectable play modes.

- 21 **CLR button**
Cancels functions and clears entered numbers.

Notes:

- With some components, certain buttons may not work as expected, and some may not work at all.

Controlling a VCR or PVR

By pressing the REMOTE MODE button that's been programmed with the remote control code for your VCR (TV/VCR, PVR, DBS/PVR combination or cable/PVR combination), you can control your video recorder with the following buttons.

For details on entering a remote control code for a different component, see page 141.

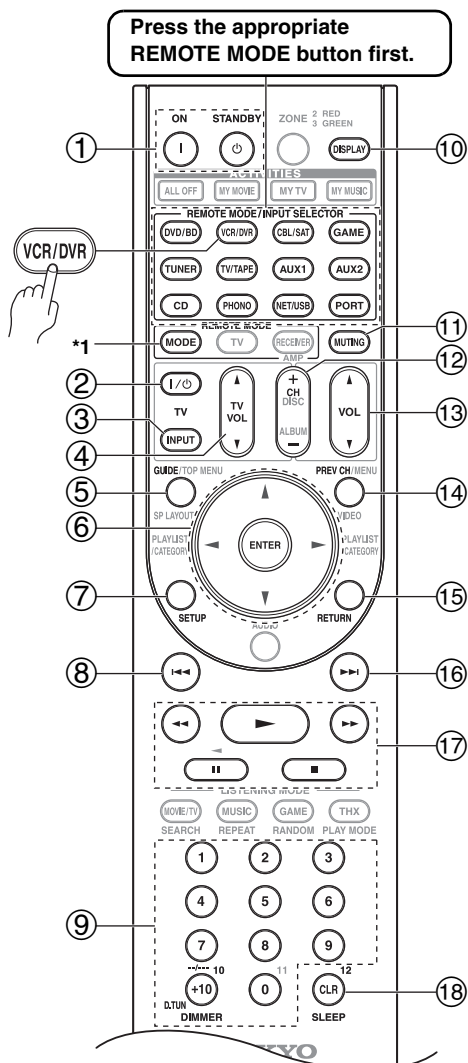

*1 When you want to change the remote controller mode without changing the current input source, press the [MODE] button and within about eight seconds, press the REMOTE MODE button. Then, with the AV receiver's remote controller, you can control the component corresponding to the button you pressed.

- If you enter the remote control code for a HD DVD or Blu-ray player that has A, B, C, and D or colored buttons, the [SEARCH], [REPEAT], [RANDOM], and [PLAY MODE] buttons will work as colored or A, B, C, D buttons. In this case, these buttons cannot be used to set repeat playback, random playback, or select play modes.
- Buttons marked with an asterisk (*) are not supported by the **RHHD** function.

- 1 **ON, STANDBY buttons**
Set the video recorder to On or Standby.
- 2 **TV [1/φ] button**
Set the TV to On or Standby.
- 3 **TV [INPUT] button**
Selects the TV's external inputs.
- 4 **TV VOL [▲]/[▼] button**
Adjust the TV's volume.
- 5 **GUIDE button**
Displays the program guide or navigation list.
- 6 **Arrow [▲]/[▼]/[◀]/[▶] and ENTER buttons**
Used to navigate menus and select items.
- 7 **SETUP button**
Displays the video recorders setup menu.
- 8 **Previous [◀◀] button**
Previous or instant replay function.
- 9 **Number buttons**
Enter numbers. The [0] button enters 11 on some components. The [+10] button works as a +10 button or "--/---" button.
- 10 **DISPLAY button**
Displays information.
- 11 **MUTING button (69)**
Mutes or unmutes the AV receiver.
- 12 **CH +/- button**
Selects TV channels on the video recorder.
- 13 **VOL [▲]/[▼] button (67)**
Adjusts the volume of the AV receiver.
- 14 **PREV CH button**
Selects the previous channel.
- 15 **RETURN button**
Exits the menu or returns to the previous menu.
- 16 **Next [▶▶] button**
Next or advance function.
- 17 **[▶], [⏸], [■], [◀◀], [▶▶] buttons**
Play, Pause, Stop, Fast reverse, and Fast forward.
- 18 **CLR button**
Cancels functions or enters the number 12.

Note:

With some components, certain buttons may not work as expected, and some may not work at all.

Controlling a Satellite Receiver or Cable Receiver

By pressing the REMOTE MODE button that's been programmed with the remote control code for your satellite receiver, cable receiver, or DVD recorder (DBS/PVR combination or cable/PVR combination), you can control your player with the following buttons. For details on entering a remote control code for a different component, see page 141.

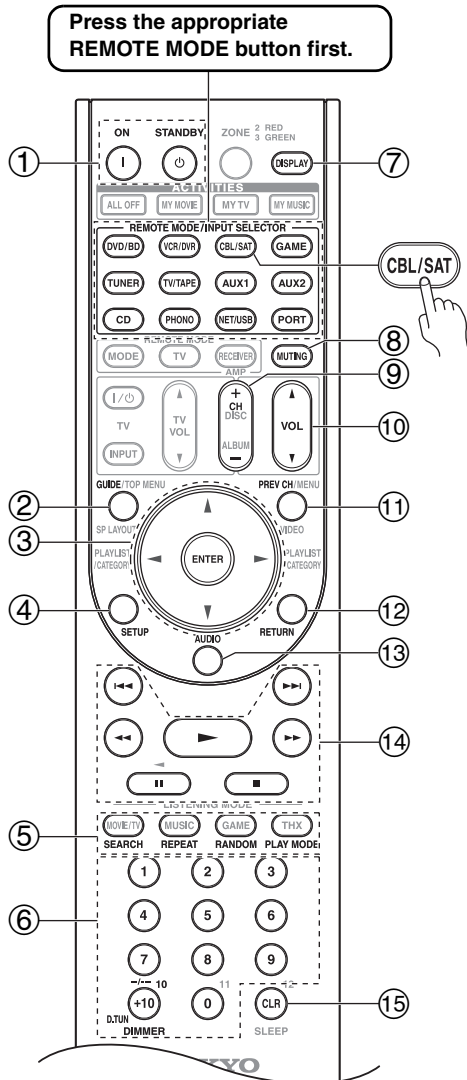

- ① **ON, STANDBY buttons**
Set the component to On or Standby.
- ② **GUIDE button**
Displays the onscreen program guide.
- ③ **Arrow [▲]/[▼]/[◀]/[▶] and ENTER buttons**
Used to navigate menus and select items.
- ④ **SETUP button**
Displays the setup menu.
- ⑤ **SEARCH, REPEAT, RANDOM, and PLAY MODE buttons**
Function as colored buttons or A, B, C, D buttons.
- ⑥ **Number buttons**
Enter numbers. The [+10] button works as a +10 button or “--/--” button.
- ⑦ **DISPLAY button**
Displays information.
- ⑧ **MUTING button (69)**
Mutes or unmutes the AV receiver.
- ⑨ **CH +/- button**
Selects satellite/cable channels.
- ⑩ **VOL [▲]/[▼] button (67)**
Adjusts the volume of the AV receiver.
- ⑪ **PREV CH button**
Selects the previous channel.
- ⑫ **RETURN button**
Exits the menu.
- ⑬ **AUDIO button**
Selects foreign language soundtracks and audio formats (e.g., Dolby Digital or DTS).
- ⑭ **[▶], [⏸], [■], [◀◀], [▶▶], [◀◀], [▶▶] buttons**
Play, Pause, Stop, Fast reverse, Fast forward, Previous, and Next.
- ⑮ **CLR button**
Cancels functions and clears entered numbers.

Note:

With some components, certain buttons may not work as expected, and some may not work at all.

Controlling a CD Player, CD Recorder or MD Recorder

By pressing the REMOTE MODE button that's been programmed with the remote control code for your CD player, CD recorder, or MD recorder, you can control your player with the following buttons.

The [CD] button is preprogrammed with the remote control code for controlling an Onkyo CD player.

For details on entering a remote control code for a different component, see page 141.

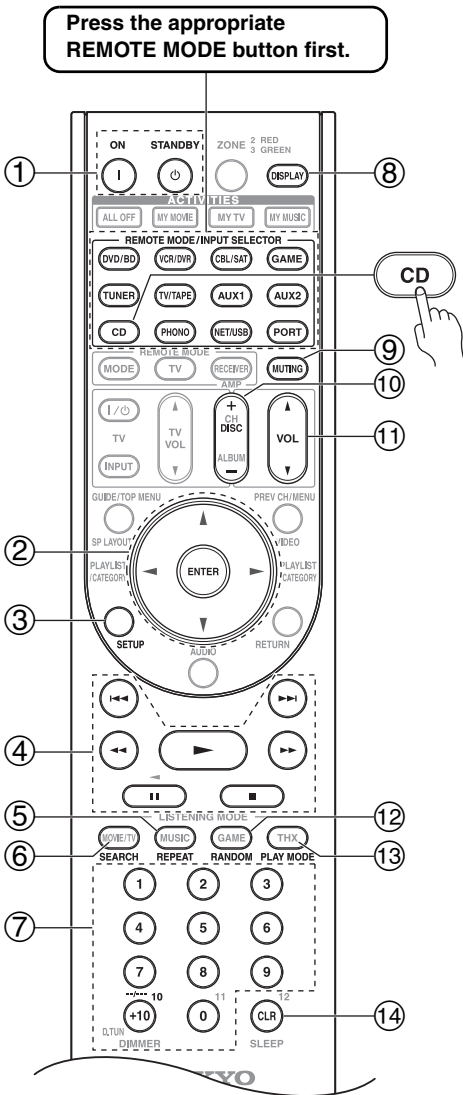

- ① **ON, STANDBY buttons**
Set the component to On or Standby.
- ② **Arrow [▲]/[▼]/[◀]/[▶] and ENTER buttons**
Used to navigate menus and select items.
- ③ **SETUP button**
Used to access the Onkyo CD player's settings.
- ④ **[▶▶], [||], [■], [◀◀], [▶▶], [◀◀], [▶▶] buttons**
Play, Pause, Stop, Fast reverse, Fast forward, Previous, and Next.
- ⑤ **REPEAT button**
Used with the repeat playback function.
- ⑥ **SEARCH button**
Used to locate specific points.
- ⑦ **Number buttons**
Used to enter track numbers and times for locating specific points. The [+10] button works as a +10 button or "--/---" button.
- ⑧ **DISPLAY button**
Displays information about the current disc or track, including elapsed time, remaining time, total time, and so on.
- ⑨ **MUTING button (69)**
Mutes or unmutes the AV receiver.
- ⑩ **DISC +/- button**
Selects discs on a CD changer.
- ⑪ **VOL [▲]/[▼] button (67)**
Adjusts the volume of the AV receiver.
- ⑫ **RANDOM button**
Used with the random playback function.
- ⑬ **PLAY MODE button**
Selects play modes on components with selectable play modes.
- ⑭ **CLR button**
Cancels functions and clears entered numbers.

Note:

With some components, certain buttons may not work as expected, and some may not work at all.

Controlling an RI Dock

By pressing the REMOTE MODE button that's been programmed with the remote control code for your Dock, you can control your iPod in the Dock with the following buttons.

For some RI docks, the [ON], [STANDBY] button may not work with a remote control code **82990** (without **RI**).

In this case, make an **RI** connection and enter a remote control code **81993** (with **RI**).

For details on entering a remote control code, see page 141.

When Using an RI Dock:

- When using the Onkyo DS-A3 RI Dock, make an **RI** connection and enter a remote control code **81993** (with **RI**).
- Connect the RI Dock to the TV/TAPE IN, VCR/DVR IN, or GAME IN L/R jacks.
- Set the RI Dock's RI MODE switch to HDD or HDD/DOCK.
- Set the AV receiver's Input Display to DOCK (see page 60).
- See to the Dock's instruction manual for more information.

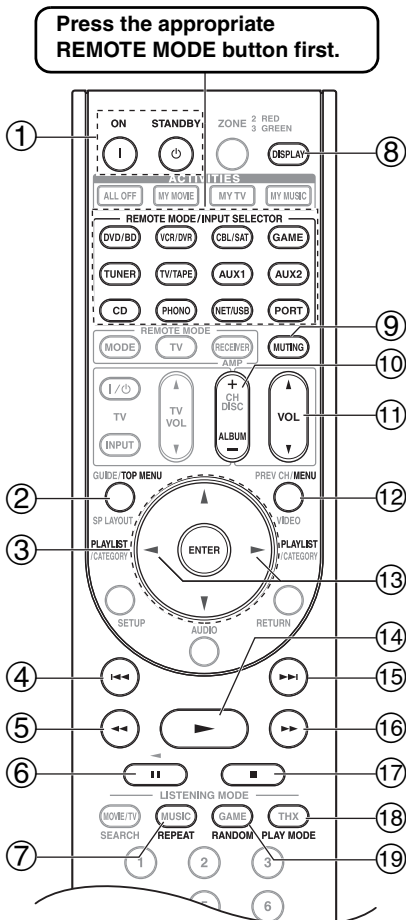

① ON, STANDBY buttons

Turns the iPod on or off.

Notes:

- This button does not turn the Onkyo DS-A2 or DS-A2X RI Dock on or off.
- Your iPod may not respond the first time you press this button, in which case you should press it again. This is because the remote controller transmits the On and Standby commands alternately, so if your iPod is already on, it will remain on when the remote controller transmits an On command. Similarly, if your iPod is already off, it will remain off when the remote controller transmits an Off command.

② TOP MENU button

Works as a Mode button when used with a DS-A2 RI Dock.

③ Arrow [▲]/[▼] and ENTER buttons

Used to navigate menus and select items.

④ Previous [◀◀] button

Restarts the current song. Press it twice to select the previous song.

⑤ Fast Reverse [◀◀] button

Press and hold to fast reverse.

⑥ Pause [⏸] button

Pauses playback.

⑦ REPEAT button

Used with the repeat function.

⑧ DISPLAY button

Turns on the backlight for 30 seconds.

⑨ MUTING button (69)

Mutes or unmutes the AV receiver.

⑩ ALBUM +/- button

Selects the next or previous album.

⑪ VOL [▲]/[▼] button (67)

Adjusts the volume of the AV receiver.

⑫ MENU button

Exits the menu.

⑬ PLAYLIST [◀]/[▶] button

Selects the previous or next playlist on the iPod.

⑭ Play [▶] button

Starts playback. If the component is off, it will turn on automatically.

⑮ Next [▶▶] button

Selects the next song.

⑯ Fast Forward [▶▶▶] button

Press and hold to fast forward.

⑰ Stop [■] button

Stops playback and displays a menu.

Controlling Other Components—Continued

18 PLAY MODE button

Selects play modes on components with selectable play modes.

Works as a Resume button when used with a DS-A2 RI Dock.

19 RANDOM button

Used with the shuffle function.

Note:

With some components, certain buttons may not work as expected, and some may not work at all.

Controlling a Cassette Recorder

By pressing the REMOTE MODE button that's been programmed with the remote control code for your cassette recorder, you can control your cassette recorder with the following buttons.

The [TV/TAPE] button is preprogrammed with the remote control code for controlling an Onkyo cassette recorder when used with an **RI** connection.

For details on entering a remote control code for a different component, see page 141.

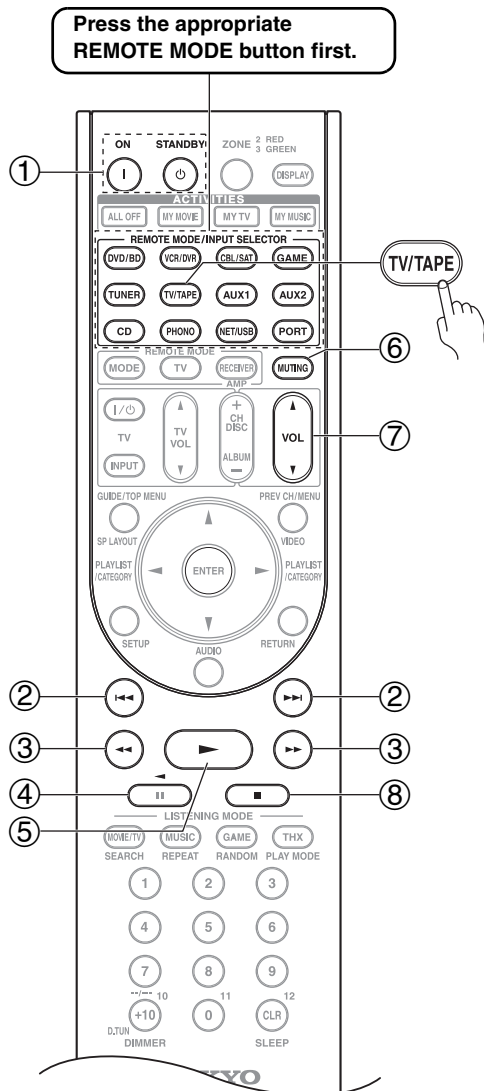

On twin cassette decks, only Deck B can be controlled.

1 ON, STANDBY buttons

Turns the cassette recorder on or off.

2 Previous and Next [◀◀]/[▶▶] buttons

The Previous [◀◀] button selects the previous track. During playback it selects the beginning of the current track. The Next [▶▶] button selects the next track.

Depending on how they were recorded, the Previous and Next [◀◀]/[▶▶] buttons may not work properly with some cassette tapes.

3 Fast Reverse and Fast Forward [◀◀]/[▶▶] buttons

The Fast Reverse [◀◀] button starts fast reverse.

The Fast Forward [▶▶] button starts fast forward.

4 Reverse Play [◀] button

Starts reverse playback.

5 Play [▶] button

Starts playback.

6 MUTING button (69)

Mutes or unmutes the AV receiver.

7 VOL [▲]/[▼] button (67)

Adjusts the volume of the AV receiver.

8 Stop [■] button

Stops playback.

Notes:

- An Onkyo cassette recorder connected via **RI** can also be controlled in Receiver mode.
- With some components, certain buttons may not work as expected, and some may not work at all.

Activities Setup

Via onscreen menu, you can specify what actions will be taken by the Easy macro command in the Easy macro mode.

1 Press the [RECEIVER] button followed by the [SETUP] button. The main menu appears onscreen. If the main menu doesn't appear, make sure the appropriate external input is selected on your TV.

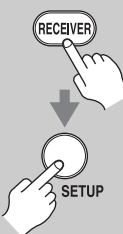

2 Use the Up and Down [▲]/[▼] buttons to select "8. Remote Controller Setup", and then press [ENTER]. The "Remote Controller Setup" menu appears.



8. Remote Controller Setup	
1. Remote Mode Setup	
2. Activities Setup	

3 Use the Up and Down [▲]/[▼] buttons to select "2. Activities Setup", and then press [ENTER]. The "Activities Setup" menu appears.



8-2. Activities Setup	
My Movie	
My TV	
My Music	

4 Use the Up and Down [▲]/[▼] buttons to select "My Movie", "My TV", or "My Music", and then press [ENTER].

My Movie: Actions for the [MY MOVIE] button is changed.

My TV: Actions for the [MY TV] button is changed.

My Music: Actions for the [MY MUSIC] button is changed.



5 Use the Up and Down [▲]/[▼] buttons to select an item, and use the Left and Right [◀]/[▶] buttons to change the settings. The items are explained below.

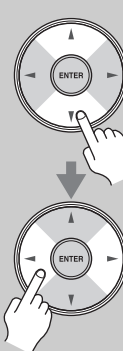

8-2. Activities Setup		MY Movie
Source	DVD/BD	▶
TV Power ON	Enable	
Source Power ON	Enable	
Receiver Power ON	Enable	
Receiver Source Change	Enable	
Source Play	Enable	

Source
DVD/BD, VCR/DVR, CBL/SAT, GAME, AUX 1, AUX 2, TV/TAPE, TUNER, CD, PHONO, PORT, NET/USB
 With this setting, you can choose the input source.

TV Power On
Enable: TV to turn on "Enable".
Disable: TV to turn on "Disable".
 This option enables the TV to turn on when the ACTIVITIES button is pressed.

Source Power On
Enable: Source to turn on "Enable".
Disable: Source to turn on "Disable".
 This option enables the Source to turn on when the ACTIVITIES button is pressed.

Receiver Power On
Enable: AV receiver to turn on "Enable".
Disable: AV receiver to turn on "Disable".
 This option enables the AV receiver to turn on when the ACTIVITIES button is pressed.

Receiver Source Change
Enable: AV receiver input selector is change.
Disable: AV receiver input selector is not change.
 This option enables the AV receiver input selector to change when the ACTIVITIES button is pressed.

Source Play

Enable: Start playback the source of “Enable”.

Disable: Start playback the source of “Disable”.

This option enables the Source to start playback when the ACTIVITIES button is pressed.

Here are the default settings.

Items	Default Settings		
	My Movie	My TV	My Music
Source	DVD	CBL	CD
TV Power On	Enable	Enable	Disable
Source Power On	Enable	Enable	Enable
Receiver Power On	Enable	Enable	Enable
Receiver Source Change	Enable	Enable	Enable
Source Play	Enable	Disable	Enable

6



Press [ENTER].

A message for transfer will appear.

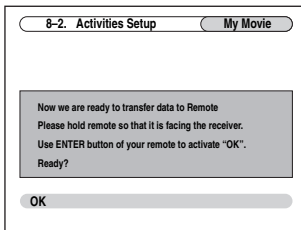

To use the remote controller, point it at the AV receiver's remote control sensor, as shown below.

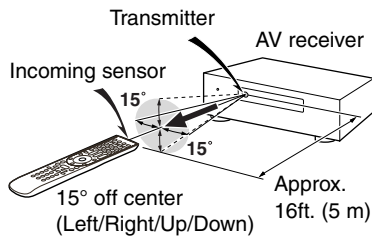

7



On the remote controller press the [ENTER] button.

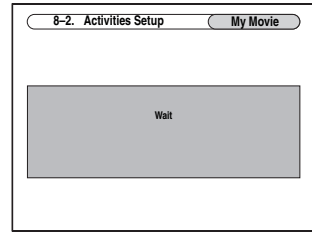

When the transfer is successful, the following screen appears.

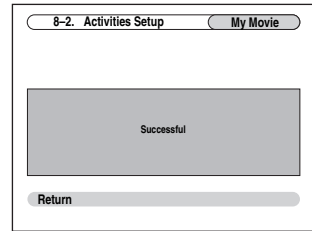

8



When you've finished, press the [ENTER] button.

The “8-2. Activities Setup” menu appears onscreen.

9



When you've finished, press the [SETUP] button.

The setup menu closes.

Learning Commands

The AV receiver's remote controller can learn the commands of other remote controllers. By transmitting, for example, the Play command from your CD player's remote controller, the remote controller can learn it, and then transmit the exact same command when its Play [▶] button is pressed in the CD remote mode.

This is useful when you've entered the appropriate remote control code (page 141) but some buttons don't work as expected.

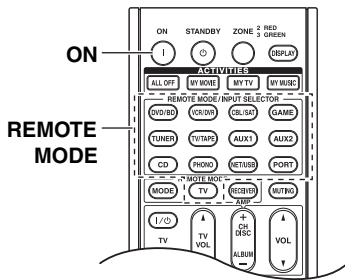

1



While holding down the REMOTE MODE button for the mode in which you want to use the command, press and hold down the [ON] button until the REMOTE MODE button lights up (about 3 seconds).

2

On the supplied remote controller, press the button you want to learn the new command.

3

Point the remote controllers at each other, about 2 to 6 inches (5 to 15 cm) apart, and then press and hold the button whose command you want to learn until the REMOTE MODE button flashes.

If the command is learned successfully, the REMOTE MODE button flashes twice.

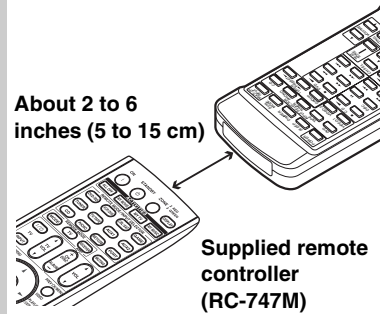

4

To learn more commands, repeat steps 2 and 3.

Press any REMOTE MODE button when you've finished. The REMOTE MODE button flashes twice.

Notes:

- The following buttons cannot learn new commands: REMOTE MODE, ACTIVITIES [ALL OFF], [MY MOVIE], [MY TV], [MY MUSIC].
- The remote controller can learn approximately 70 to 90 commands, although this will be less if commands that use a lot of memory are learned.
- Remote controller buttons such as Play, Stop, Pause, and so on are preprogrammed with commands for controlling Onkyo CD players, cassette decks, and DVD players. However, they can learn new commands, and you can restore the preprogrammed commands at any time by resetting the remote controller (see page 142).
- To overwrite a previously learned command, repeat this procedure.
- Depending on the remote controller that you are using, there may be some buttons that won't work as expected, or even some remotes that cannot be learned at all.
- Only commands from infrared remote controllers can be learned.
- When the remote controller's batteries expire, all learned commands will be lost and will have to be learned all over again, so don't discard your other remote controllers.

■ Deleting Learning Commands

1. While holding down the REMOTE MODE button for the mode in which you want to delete the command, press and hold down the TV [I/⏻] button until the REMOTE MODE button lights up (about 3 seconds).
2. Press the REMOTE MODE button or the button from which you want to delete the commands. The REMOTE MODE button flashes twice. When you press the REMOTE MODE button, all commands learned in that remote mode will be deleted.

Using Normal Macros

You can program the remote controller's ACTIVITIES buttons to perform a sequence of remote control actions.

Example:

To play a CD you typically need to perform the following actions:

1. Press the [RECEIVER] button to select the Receiver remote controller mode.
2. Press the [ON] button to turn on the AV receiver.
3. Press the [CD] button to select the CD input source.
4. Press the Play [▶] button to start playback on the CD player.

You can program ACTIVITIES buttons so that all four actions are performed with just one button press.

Making Macros

Each ACTIVITIES button can store one macro, and each macro can contain up to 32 commands.

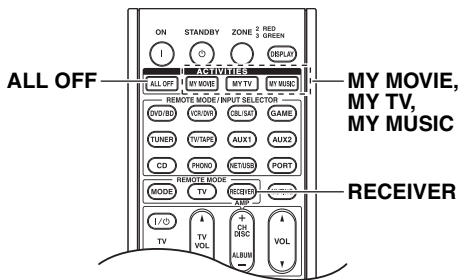

1



(3 seconds)

While holding down the [RECEIVER] button, press and hold down the [MY MOVIE], [MY TV], or [MY MUSIC] button until the [MY MOVIE], [MY TV], or [MY MUSIC] button lights up (about 3 seconds).

2

Press the buttons whose actions you want to program into the macro in the order you want them performed.

For the CD example above, you'd press the following buttons: [ON], [CD], Play [▶].

Note:

The [MODE] button is invalid at macro making operation.

3



When you've finished, press the ACTIVITIES button again.

The ACTIVITIES button flashes twice. If you enter 32 commands, the process will finish automatically.

Note:

Once you have taught new macro commands, the original macro will no longer work. If you want to retrieve them, you will have to teach again.

Running Macros

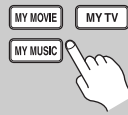

Press the [MY MOVIE], [MY TV], or [MY MUSIC] button.

The commands in the macro are transmitted in the order in which they were programmed. Keep the remote controller pointed at the AV receiver until all of the commands have been transmitted.

Macros can be run at any time, regardless of the current remote controller mode.

Deleting Macros

1



(3 seconds)

While holding down the [AUDIO] button, press and hold down the [ALL OFF] button until the [ALL OFF] button lights up (about 3 seconds).

2



Press the [ALL OFF] button again.

The [ALL OFF] button flashes twice.

Notes:

- All of the ACTIVITIES buttons will automatically switch to the Easy macro mode when the macro is deleted (page 72).
- When you using Normal macro mode, you cannot use the easy macro command including the change of the source component.

Troubleshooting

If you have any trouble using the AV receiver, look for a solution in this section. If you can't resolve the issue yourself, contact your Onkyo dealer.

If you can't resolve the issue yourself, try resetting the AV receiver before contacting your Onkyo dealer.

To reset the AV receiver to its factory defaults, turn it on and, while holding down the [VCR/DVR] button, press the [ON/STANDBY] button. "Clear" will appear on the display and the AV receiver will enter Standby mode.



Note that resetting the AV receiver will delete your radio presets and custom settings.

Power

Can't turn on the AV receiver

- Make sure that the power cord is properly plugged into the wall outlet.
- Unplug the power cord from the wall outlet, wait five seconds or more, then plug it in again.

The AV receiver turns off as soon as it's turned on

- The amp protection circuit has been activated. Remove the power cord from the wall outlet immediately. Disconnect all speaker cables and input sources, and leave the AV receiver with its power cord disconnected for 1 hour. After that, reconnect the power cord and set the volume to maximum. If the AV receiver stays on, set the volume to minimum, disconnect the power cord, and reconnect your speakers and input sources. If the AV receiver turns off when you set the volume to maximum, disconnect the power cord, and contact your Onkyo dealer.

Audio

There's no sound, or it's very quiet

- Make sure that the digital input source is selected properly (page 56).
- Make sure that all audio connecting plugs are pushed in all the way (page 29).
- Make sure that the inputs and outputs of all components are connected properly (pages 31 to 46).
- Make sure that the polarity of the speaker cables is correct, and that the bare wires are in contact with the metal part of each speaker terminal (page 20).
- Make sure that the input source is properly selected (page 67).
- Make sure that the speaker cables are not shorting.
- Check the volume. It can be set to $-\infty$ dB, -81.5 dB through $+18.0$ dB (page 67). The AV receiver is

designed for home theater enjoyment. It has a wide volume range, allowing precise adjustment.

- If the MUTING indicator is flashing on the display, press the remote controller's [MUTING] button to unmute the AV receiver (page 69).
- While a pair of headphones is connected to the PHONES jack, no sound is output by the speakers (page 70).
- If there's no sound from a DVD player connected to an HDMI IN, check the DVD player's output settings, and be sure to select a supported audio format.
- Check the digital audio output setting on the connected device. On some game consoles, such as those that support DVD, the default setting is off.
- With some DVD-Video discs, you need to select an audio output format from a menu.
- If your turntable uses an MC cartridge, you must connect an MC head amp, or an MC transformer.
- Make sure that none of the connecting cables are bent, twisted, or damaged.
- Not all listening modes use all speakers (page 89).
- Specify the speaker distances (page 97) and adjust the individual speaker levels (page 97).
- Make sure that the speaker setup microphone is not still connected.
- The input signal format is set to PCM or DTS. Set it to Auto (page 116).

Only the front speakers produce sound

- When the DTS Surround Sensation, Stereo or Mono listening mode is selected, only the front speakers and subwoofer produce sound.
- In the Mono listening mode, only the front speakers output sound if the "Output Speaker" setting is set to "Left / Right" (page 100).
- Check the Speaker Configuration (page 95).

Only the center speaker produces sound

- If you use the Dolby Pro Logic IIx Movie, Dolby Pro Logic IIx Music, or Dolby Pro Logic IIx Game listening mode with a mono source, such as an AM radio station or mono TV program, the sound is concentrated in the center speaker.
- In the Mono listening mode, only the front speakers output sound if the "Output Speaker" setting is set to "Center" (page 100).
- Make sure the speakers are configured correctly (page 95).

The surround speakers produce no sound

- When the DTS Surround Sensation, T-D (Theater-Dimensional), Stereo or Mono listening mode is selected, the surround speakers produce no sound.
- Depending on the source and current listening mode, not much sound may be produced by the surround speakers. Try selecting another listening mode.
- Make sure the speakers are configured correctly (page 95).

The center speaker produces no sound

- When the DTS Surround Sensation or Stereo listening mode is selected, the center speaker produces no sound.
- In the Mono listening mode, only the front speakers output sound if the “Output Speaker” setting is set to “Left / Right” (page 100).
- Make sure the speakers are configured correctly (page 95).

The front high, front wide and surround back speakers produce no sound

- Depending on the current listening mode, no sound may be produced by the front high, front wide, and surround back speakers. Select another listening mode (page 89).
- Not much sound may be produced by the front high, front wide, and surround back speakers with some sources.
- Make sure the speakers are configured correctly (page 95).
- While Powered Zone 2 is being used, playback in the main room is reduced to 7.2-channels and the front high and front wide speakers produce no sound (page 130).
- While Powered Zone 3 is being used, playback in the main room is reduced to 7.2-channels and the surround back speakers produce no sound (page 130).

The subwoofer produces no sound

- When you play source material that contains no information in the LFE channel, the subwoofer may produce no sound.
- Make sure the speakers are configured correctly (page 95).

The Zone 2/3 speakers produce no sound

- The Zone 2/3 speakers only output sources that are connected to an analog input. Check to see if the source component is connected to an analog input.
- Powered Zone 2 cannot be used if “Speakers Type(FrontB)” is set to “Normal”, “Bi-Amp”, or “BTL” (pages 57 and 131).
- Powered Zone3 cannot be used if “Speakers Type(FrontA)” or “Speakers Type(FrontB)” is set to “Bi-Amp” or “BTL” (pages 57 and 133).

There’s no sound with a certain signal format

- Check the digital audio output setting on the connected device. On some game consoles, such as those that support DVD, the default setting is off.
- With some DVD-Video discs, you need to select an audio output format from a menu.
- Depending on the input signal, some listening modes cannot be selected (pages 82 to 88).

Can’t get 6.2/7.2 playback

- If no front high, front wide and surround back speakers are connected, or the Zone 2/3 speakers are being used, 6.2/7.2 playback is not possible.
- You can not always select all of the listening modes, depending on the number of the speakers connected (pages 82 to 88).

The speaker volume cannot be set as required (The volume cannot be set to +18.0 dB)

- Check to see if a maximum volume has been set (page 110).
- If the volume level of each individual speaker has been adjusted to high positive values (page 97), then the maximum master volume possible may be reduced. Note that the individual speaker volume levels are set automatically after Audyssey MultEQ[®] XT Room Correction and Speaker Setup has been completed (page 62).

Noise can be heard

- Using cable ties to bundle audio cables with power cords, speaker cables, and so on may degrade the audio performance, so don’t do it.
- An audio cable may be picking up interference. Try repositioning your cables.

The Late Night function doesn’t work

- Make sure the source material is Dolby Digital, Dolby Digital Plus, and Dolby TrueHD (page 117).

The analog multichannel input doesn’t work

- Check the multichannel input connections (page 37).
- Make sure that the multichannel input is assigned to the input selector (page 57).
- Make sure that the multichannel input is selected (page 80).
- Check the audio output settings on your source component.

About DTS signals

- When DTS program material ends and the DTS bit-stream stops, the AV receiver remains in DTS listening mode and the DTS indicator remains on. This is to prevent noise when you use the pause, fast forward, or fast reverse function on your player. If you switch your player from DTS to PCM, because the AV receiver does not switch formats immediately, you may not hear any sound, in which case you should stop your player for about three seconds, and then resume playback.

- With some CD and LD players, you won't be able to playback DTS material properly even though your player is connected to a digital input on the AV receiver. This is usually because the DTS bitstream has been processed (e.g., output level, sampling rate, or frequency response changed) and the AV receiver doesn't recognize it as a genuine DTS signal. In such cases, you may hear noise.
- When playing DTS program material, using the pause, fast forward, or fast reverse function on your player may produce a short audible noise. This is not a malfunction.

The beginning of audio received by an HDMI IN can't be heard

- Since it takes longer to identify the format of an HDMI signal than it does for other digital audio signals, audio output may not start immediately.

Video

There's no picture

- Make sure that all video connecting plugs are pushed in all the way (page 29).
- Make sure that each video component is properly connected (pages 31 to 46).
- If your TV is connected to the HDMI output, set the "Monitor Out" setting other than "Analog" (page 52), and select "- - - -" in the "HDMI Input Setup" on page 54 to watch composite video, S-Video, and component video sources.
- If your TV is connected to the COMPONENT VIDEO MONITOR OUT, S MONITOR OUT, or V MONITOR OUT, set the "Monitor Out" setting to "Analog" (page 52), and select "- - - -" in the "Component Video Input Setup" on page 55 to watch composite video and S-Video sources.
- If the video source is connected to a component video input, you must assign that input to an input selector (page 55), and your TV must be connected to either the HDMI OUT or COMPONENT VIDEO MONITOR OUT (pages 31 and 35).
- If the video source is connected to an HDMI input, you must assign that input to an input selector (page 54), and your TV must be connected to the HDMI outputs (page 31).
- While the Pure Audio listening mode is selected, the video circuitry is turned off and only video signals input through HDMI IN can be output.
- On your TV, make sure that the video input to which the AV receiver is connected is selected.
- If you selected "Both (Main)" or "Both (Sub)" in the "Monitor Out" setting, no picture may appear on your TV that is connected to a secondary HDMI output (not a priority HDMI output). In this case, change the setting to "Both" (page 52).

There's no picture from a source connected to an HDMI IN

- Reliable operation with an HDMI-to-DVI adapter is not guaranteed. In addition, video signals from a PC are not guaranteed (page 31).
- When the "Monitor Out" setting is set to "Analog", and the "Resolution" setting is set to anything other than "Through" (page 53), no video is output by the HDMI outputs.
- When the "Resolution" (page 53) is set to any resolution not supported by the TV, no video is output by the HDMI outputs.
- If the message "Resolution Error" appears on the AV receiver's display, this indicates that your TV does not support the current video resolution and you need to select another resolution on your DVD player.

The onscreen menus don't appear

- If your TV is connected to the analog outputs, set the "Monitor Out" setting to "Analog" (page 52).
- **(European and Asian models)** Specify the TV system used in your area in the "TV Format Setup" on page 59.
- On your TV, make sure that the video input to which the AV receiver is connected is selected.

The picture is distorted

- **(European and Asian models)** Specify the TV system used in your area in the "TV Format Setup" on page 59.

The immediate display does not appear

- If you select other than "Analog" in the "Monitor Out" setting (page 52), the immediate display will not appear when the input signal from the COMPONENT VIDEO IN is output to a device connected to the COMPONENT VIDEO MONITOR OUT.
- Depending on the input signal, the immediate display may not appear when the input signal from the HDMI input is output to a device connected to the HDMI output.

Tuner

Reception is noisy, FM stereo reception is noisy, or the FM STEREO indicator doesn't appear

- Relocate your antenna.
- Move the AV receiver away from your TV or computer.
- Listen to the station in mono (page 73).
- When listening to an AM station, operating the remote controller may cause noise.
- Passing cars and airplanes can cause interference.
- Concrete walls weaken radio signals.
- If nothing improves the reception, install an outdoor antenna.

Remote Controller

The remote controller doesn't work

- Make sure that the batteries are installed with the correct polarity (page 14).
- Install new batteries. Don't mix different types of batteries, or old and new batteries (page 14).
- Make sure that the remote controller is not too far away from the AV receiver, and that there's no obstruction between the remote controller and the AV receiver's remote control sensor (page 14).
- Make sure that the AV receiver is not subjected to direct sunshine or inverter-type fluorescent lights. Relocate if necessary.
- If the AV receiver is installed in a rack or cabinet with colored-glass doors, the remote controller may not work reliably when the doors are closed.
- Make sure you've selected the correct remote controller mode (pages 15 and 143 to 149).
- When using the remote controller to control other manufacturers' AV components, some buttons may not work as expected.
- Make sure you've entered the correct remote control code (page 141).
- Make sure to set the same ID on both the AV receiver and remote controller (page 112).

Can't control other components

- If it's an Onkyo component, make sure that the **RI** cable and analog audio cable are connected properly. Connecting only an **RI** cable won't work (page 47).
- Make sure you've selected the correct remote controller mode (pages 15 and 143 to 149).
- If you've connected an **RI**-capable Onkyo MD recorder, CD recorder, RI Dock to the TV/TAPE IN/OUT jacks, or an RI Dock to the GAME IN or VCR/DVR IN jacks, for the remote controller to work properly, you must set the display to MD, CDR, or DOCK (page 60).

If you cannot operate it, you will need to enter the appropriate remote control code (page 141).

- To control another manufacturer's component, point the remote controller at that component.
- If none of the codes work, use the Learning function to learn the commands of the other component's remote controller (page 152).
- With some AV components, certain buttons may not work as expected, and some may not work at all.
- To control an Onkyo component that's connected via **RI**, point the remote controller at the AV receiver. Be sure to enter the appropriate remote control code first (page 142).
- To control an Onkyo component that's not connected via **RI**, or another manufacturer's component, point the remote controller at the component. Be sure to enter the appropriate remote control code first (page 141).

- The entered remote control code may not be correct. If more than one code is listed, try each one.

Can't learn commands from another remote controller

- When learning commands, make sure that the transmitting ends of both remote controllers are pointing at each other.
- Are you trying to learn from a remote controller that cannot be used for learning? Some commands cannot be learned, especially those that contain several instructions.

Dock for iPod

There's no sound

- Make sure your iPod is actually playing.
- Make sure your iPod is inserted properly in the Dock.
- Make sure the UP-A1 Dock is connected to the UNIVERSAL PORT jack on the AV receiver.
- Make sure the AV receiver is turned on, the correct input source is selected, and the volume is turned up.
- Make sure the plugs are pushed in all the way.
- Try resetting your iPod.

There's no video

- Make sure that your iPod's TV OUT setting is set to On.
- Make sure the correct input is selected on your TV or the AV receiver.
- Some versions of the iPod do not output video.

The AV receiver's remote controller doesn't control your iPod

- Make sure your iPod is properly inserted in the Dock. If your iPod is in a case, it may not connect properly to the Dock. Always remove your iPod from the case before inserting it into the Dock.
- The iPod cannot be operated while it's displaying the Apple logo.
- Make sure you've selected the right remote mode.
- When you use the AV receiver's remote controller, point it toward your amp.
- If you still can't control your iPod, start playback by pressing your iPod's Play button. Remote operation should then be possible.
- Try resetting your iPod.
- Depending on your iPod, some buttons may not work as expected.
- You can't control your iPod if the battery is extremely low. Use the iPod after recharging for a while.

The AV receiver unexpectedly selects your iPod as the input source

- Always pause iPod playback before selecting a different input source. If playback is not paused, the Direct Change function may select your iPod as the input source by mistake during the transition between tracks.

Recording

Can't record

- On your recorder, make sure the correct input is selected.
- To prevent signal loops and damage to the AV receiver, input signals are not fed through to outputs with the same name (e.g., TAPE IN to TAPE OUT or VCR/DVR IN to VCR/DVR OUT).
- When the Pure Audio listening mode is selected, recording is not possible because no video signals are output. Select another listening mode.

Zone 2/3

There's no sound

- Only components connected to analog inputs can be played in Zone 2/3.

Music Server and Internet Radio

Can't access the server or Internet radio

- Check the network connection between the AV receiver and your router or switch.
- Make sure that your modem and router are properly connected, and make sure they are both turned on.
- Make sure the server is up and running and compatible with the AV receiver (page 125).
- Check the “Network Settings”(page 126).

Playback stops while listening to music files on the server

- Make sure your server is compatible with the AV receiver (page 125).
- If you download or copy large files on your computer, playback may be interrupted. Try closing any unused programs, use a more powerful computer, or use a dedicated server.
- If the server is serving large music files to several networked devices simultaneously, the network may become overloaded and playback may be interrupted. Reduce the number of playback devices on the network, upgrade your network, or use a switch instead of a hub.

Can't connect to the AV receiver from a Web browser

- If you're using DHCP, your router may not always allocate the same IP address to the AV receiver, so if you find that you can't connect to a server or Internet radio station, recheck the AV receiver's IP address on Network screen.
- Check the Network settings (page 126).

USB Mass Storage Device Playback

Can't access the music files on a USB device

- Make sure the USB device is plugged in properly.
- The AV receiver supports USB devices that support the USB mass storage device class. However, playback may not be possible with some USB devices even if they conform to the USB mass storage device class.
- USB memory devices with security functions cannot be played.

Others

The sound changes when I connect my headphones

- When a pair of headphones is connected, the listening mode is set to Stereo, unless it's already set to Stereo, Mono, Direct, Pure Audio or DTS Surround Sensation.

The speaker distance cannot be set as required

- In some cases, corrected values suitable for home theater use may be set automatically.

The display doesn't work

- The display is turned off when the Pure Audio listening mode is selected.

How do I change the language of a multiplex source

- Use the “Multiplex” setting on the “Audio Adjust” menu to select “Main” or “Sub” (page 100).

The RI functions don't work

- To use **RI**, you must make an **RI** connection and an analog audio connection (RCA) between the component and AV receiver, even if they are connected digitally (page 47).
- While Zone 2 or Zone 3 is selected, the **RI** functions don't work.

The functions Auto Power On/Standby and Direct Change don't work for components connected via RI

- These functions don't work when Zone 2/3 is turned on.

When performing “Audyssey MultEQ® XT Room Correction and Speaker Setup”, the measurement fails showing the message “Ambient noise is too high.”.

- This can be caused by any malfunction in your speaker unit. Check if the unit produces normal sounds.

The following settings can be made for the S-Video, composite video and COMPONENT VIDEO inputs

You must use the buttons on the AV receiver to make these settings.

1. While holding down the input selector button for the input source that you want to set, press the [SETUP] button.
2. Use the Left and Right [◀]/[▶] buttons to change the setting.
3. Press the input selector button for the input source that you want to set when you've finished.

• Video Attenuation

This setting can be made for the DVD/BD, VCR/DVR, CBL/SAT, GAME, AUX1, or COMPONENT VIDEO input. (You need to assign the input source for COMPONENT VIDEO input.)

If you have a games console connected to the S-Video, composite and component video input, and the picture isn't very clear, you can attenuate the gain.

Video ATT:OFF: (default).

Video ATT:ON: Gain is reduced by 2 dB.

The AV receiver contains a microcomputer for signal processing and control functions. In very rare situations, severe interference, noise from an external source, or static electricity may cause it to lockup. In the unlikely event that this happens, unplug the power cord from the wall outlet, wait at least five seconds, and then plug it back in again.

Onkyo is not responsible for damages (such as CD rental fees) due to unsuccessful recordings caused by the unit's malfunction. Before you record important data, make sure that the material will be recorded correctly.

Before disconnecting the power cord from the wall outlet, set the AV receiver to Standby.

Important Note Regarding Video Playback

The AV receiver can upconvert component video, S-Video, and composite video sources for display on a TV connected to the HDMI outputs. However, if the picture quality of the source is poor, upconversion may make the picture worse or disappear altogether.

In this case, try the following:

1 If the video source is connected to a component video input, connect your TV to the COMPONENT VIDEO MONITOR OUT.

If the video source is connected to an S-Video input, connect your TV to a MONITOR OUT S.

If the video source is connected to a composite video input, connect your TV to the MONITOR OUT V.

2 On the main menu, select "1. Input/Output Assign", and then select "2. HDMI Input". Select the relevant input selector, and assign it to "- - - -" (page 54).

3 On the main menu, select "1. Input/Output Assign", and then select "3. Component Video Input" (page 55):

If the video source is connected to COMPONENT VIDEO IN1, select the relevant input selector, and assign it to "IN1".

If the video source is connected to COMPONENT VIDEO IN2, select the relevant input selector, and assign it to "IN2".

If the video source is connected to COMPONENT VIDEO IN3, select the relevant input selector, and assign it to "IN3".

If the video source is connected to an S-Video input or composite video input, select the relevant input selector, and assign it to "- - - -".

If "Monitor Out" setting is set to "Analog", press [VCR/DVR] and [RETURN] buttons on the AV receiver at the same time. Select "Skip" in the "VideoProcessor" setting by pressing the [RETURN] button repeatedly on the display. To reset back to the original setting, press the same button at the same time. If you select "Use", the AV receiver will output video signals from the video processor.

Specifications (TX-NR3007)

Amplifier Section

Rated Output Power	
All channels:	North American: 140 watts minimum continuous power per channel, 8 ohm loads, 2 channels driven from 20 Hz to 20 kHz, with a maximum total harmonic distortion of 0.05% (FTC) 160 watts minimum continuous power per channel, 8 ohm loads, 2 channels driven at 1 kHz, with a maximum total harmonic distortion of 0.7% (FTC) 170 watts minimum continuous power per channel, 6 ohm loads, 2 channels driven at 1 kHz, with a maximum total harmonic distortion of 0.1% (FTC) Others: 9 ch × 200 W at 6 ohms, 1 kHz, 1 ch driven (IEC)
Maximum Output Power	Asian: 9 ch × 250 W at 6 ohms, 1 kHz, 1 ch driven (JEITA)
Dynamic Power	320 W (3 Ω, Front) 270 W (4 Ω, Front) 160 W (8 Ω, Front)
THD (Total Harmonic Distortion)	0.05%
Damping Factor	60 (Front, 1 kHz, 8 Ω)
Input Sensitivity and Impedance	200 mV/47 kΩ (LINE) 2.5 mV/47 kΩ, (PHONO MM)
Output Level and Impedance	200 mV/470 Ω (REC OUT)
Phono Overload	70 mV (MM 1 kHz 0.5%)
Frequency Response	5 Hz - 100 kHz/+1 dB - 3 dB (LINE)
Tone Control	±10 dB, 50 Hz (BASS) ±10 dB, 20 kHz (TREBLE)
Signal to Noise Ratio	110 dB (LINE, IHF-A) 80 dB (PHONO, IHF-A)
Speaker Impedance	4 Ω - 16 Ω

Video Section

Input Sensitivity/Output Level and Impedance	1 V _{p-p} /75 Ω (Component and S-Video Y) 0.7 V _{p-p} /75 Ω (Component P _B /C _B , P _R /C _R) 0.28 V _{p-p} /75 Ω (S-Video C) 1 V _{p-p} /75 Ω (Composite)
Component Video Frequency Response	5 Hz - 100 MHz - 3 dB

Tuner Section

FM Tuning Frequency Range	North American: 87.5 MHz - 107.9 MHz Others: 87.5 MHz - 108.0 MHz, RDS
AM Tuning Frequency Range	North American: 530 kHz - 1710 kHz Others: 522 kHz - 1611 kHz
Preset Channel	40
Digital Tuner (North American models only):	SIRIUS

General

Power Supply	North American: AC 120 V, 60 Hz Others: AC 220 - 240 V, 50/60 Hz
Power Consumption	North American: 11.6 A Others: 1060 W
Dimensions (W × H × D)	435 × 198.5 × 463.5 mm 17-1/8" × 7-13/16" × 18-1/4"
Weight	25.0 kg (55.1 lbs.)

Video Inputs

HDMI	IN1 (DVD/BD), IN2 (VCR/DVR), IN3 (CBL/SAT), IN4 (GAME), IN5 (AUX2), IN6, AUX1 (Front)
Component	IN1 (DVD/BD), IN2 (CBL/SAT), IN3 (GAME)
S-Video	DVD/BD, VCR/DVR, CBL/SAT, GAME
Composite	DVD/BD, VCR/DVR, CBL/SAT, GAME, AUX1 (Front)

Video Outputs

HDMI	OUT MAIN, OUT SUB
Component	MONITOR OUT
S-Video	MONITOR OUT, VCR/DVR (REC OUT)
Composite	MONITOR OUT, VCR/DVR (REC OUT), ZONE 2 OUT

Audio Inputs

Digital Inputs	Optical: 2 (Rear), 1 (Front) Coaxial: 3 (Rear)
Analog Inputs	MULTI CH, DVD/BD, VCR/DVR, CBL/SAT, GAME, AUX2, TV/TAPE, CD, PHONO, AUX1 (Front)
Multichannel Inputs	7.1

Audio Outputs

Analog Outputs	VCR/DVR, TV/TAPE, ZONE2 PRE OUT, ZONE3 PRE OUT
Multichannel Pre Outputs	9
Subwoofer Pre Outputs	2
Speaker Outputs	FL, FR, C, SL, SR, SBL/Z3L, SBR/Z3R, LH, RH, LW/Z2L, RW/Z2R
Phones	1

Control Terminal

MIC	Yes
RS232	1
Ethernet	1
IR Input	1
IR Output	1
12 V Trigger Out	ZONE2 / ZONE3
USB	Yes (Front)

Specifications and features are subject to change without notice.

Specifications (TX-NR5007)

Amplifier Section

Rated Output Power	
All channels:	North American: 145 watts minimum continuous power per channel, 8 ohm loads, 2 channels driven from 20 Hz to 20 kHz, with a maximum total harmonic distortion of 0.05% (FTC) 175 watts minimum continuous power per channel, 8 ohm loads, 2 channels driven at 1 kHz, with a maximum total harmonic distortion of 0.7% (FTC) 185 watts minimum continuous power per channel, 6 ohm loads, 2 channels driven at 1 kHz, with a maximum total harmonic distortion of 0.1% (FTC) Others: 9 ch × 220 W at 6 ohms, 1 kHz, 1 ch driven (IEC)
Maximum Output Power	Asian: 9 ch × 280 W at 6 ohms, 1 kHz, 1 ch driven (JEITA)
Dynamic Power	400 W (3 Ω, Front) 300 W (4 Ω, Front) 180 W (8 Ω, Front)
THD (Total Harmonic Distortion)	0.05 %
Damping Factor	60 (Front, 1 kHz, 8 Ω)
Input Sensitivity and Impedance	200 mV/47 kΩ (LINE) 2.5 mV/47 kΩ, (PHONO MM)
Output Level and Impedance	200 mV/470 Ω (REC OUT)
Phono Overload	70 mV (MM 1 kHz 0.5 %)
Frequency Response	5 Hz - 100 kHz/+1 dB - 3 dB (Direct mode)
Tone Control	±10 dB, 50 Hz (BASS) ±10 dB, 20 kHz (TREBLE)
Signal to Noise Ratio	110 dB (LINE, IHF-A) 80 dB (PHONO, IHF-A)
Speaker Impedance	4 Ω - 16 Ω

Video Section

Input Sensitivity/Output Level and Impedance	1 Vp-p/75 Ω (Component and S-Video Y) 0.7 Vp-p/75 Ω (Component Pb/Cb, Pr/Cr) 0.28 Vp-p/75 Ω (S-Video C) 1 Vp-p/75 Ω (Composite)
Component Video Frequency Response	5 Hz - 100 MHz - 3 dB

Tuner Section

FM Tuning Frequency Range	North American: 87.5 MHz - 107.9 MHz Others: 87.5 MHz - 108.0 MHz, RDS
AM Tuning Frequency Range	North American: 530 kHz - 1710 kHz Others: 522 kHz - 1611 kHz
Preset Channel	40
Digital Tuner (North American models only):	SIRIUS

General

Power Supply	North American: AC 120 V, 60 Hz Others: AC 220 - 240 V, 50/60 Hz
Power Consumption	North American: 12.8 A Others: 1160 W
Dimensions (W × H × D)	435 × 198.5 × 463.5 mm 17-1/8" × 7-13/16" × 18-1/4"
Weight	25.0 kg (55.1 lbs.)

Video Inputs

HDMI	IN1 (DVD/BD), IN2 (VCR/DVR), IN3 (CBL/SAT), IN4 (GAME), IN5 (AUX2), IN6, IN7, AUX1 (Front)
Component	IN1 (DVD/BD), IN2 (CBL/SAT), IN3 (GAME)
S-Video	DVD/BD, VCR/DVR, CBL/SAT, GAME
Composite	DVD/BD, VCR/DVR, CBL/SAT, GAME, AUX1 (Front)

Video Outputs

HDMI	OUT MAIN, OUT SUB
Component	MONITOR OUT
S-Video	MONITOR OUT, VCR/DVR (REC OUT)
Composite	MONITOR OUT, VCR/DVR (REC OUT), ZONE 2 OUT

Audio Inputs

Digital Inputs	Optical: 3 (Rear), 1 (Front) Coaxial: 3 (Rear)
Analog Inputs	MULTI CH, DVD/BD, VCR/DVR, CBL/SAT, GAME, AUX2, TV/TAPE, CD, PHONO, AUX1 (Front)
Multichannel Inputs	7.1

Audio Outputs

Analog Outputs	TV/TAPE, VCR/DVR, ZONE2 PRE OUT, ZONE3 PRE OUT
Multichannel Pre Outputs	9
Subwoofer Pre Outputs	2
Speaker Outputs	FL, FR, C, SL, SR, SBL/Z3L, SBR/Z3R, LH, RH, LW/Z2L, RW/Z2R
Phones	1

Control Terminal

MIC	Yes
RS232	1
Ethernet	1
IR Input	1
IR Output	1
12 V Trigger Out	ZONE2 / ZONE3
USB	Yes (Front and Rear)

Specifications and features are subject to change without notice.

Video Resolution Chart

The following tables show how video signals at different resolutions are output by the AV receiver.

✓: Output

NTSC

Output Input		HDMI					COMPONENT					S-VIDEO	COMPOSITE
		1080p	1080i	720p	480p	480i	1080p	1080i	720p	480p	480i	480i	480i
HDMI	1080p	✓	✓	✓	✓								
	1080i	✓	✓	✓	✓								
	720p	✓	✓	✓	✓								
	480p	✓	✓	✓	✓								
	480i	✓	✓	✓	✓	✓							
COMPONENT	1080p	✓	✓	✓	✓		✓	✓	✓	✓			
	1080i	✓	✓	✓	✓			✓	✓	✓			
	720p	✓	✓	✓	✓			✓	✓	✓			
	480p	✓	✓	✓	✓			✓ ^{*1}	✓ ^{*1}	✓			
	480i	✓	✓	✓	✓	✓		✓ ^{*1}	✓ ^{*1}	✓	✓		
S-VIDEO	480i	✓	✓	✓	✓	✓		✓ ^{*1}	✓ ^{*1}	✓	✓	✓	✓
COMPOSITE	480i	✓	✓	✓	✓	✓		✓ ^{*1}	✓ ^{*1}	✓	✓	✓	✓

*1: The output is limited to 480p for an effective signal in the effect of Macrovision.

PAL

Output Input		HDMI					COMPONENT					S-VIDEO	COMPOSITE
		1080p	1080i	720p	576p	576i	1080p	1080i	720p	576p	576i	576i	576i
HDMI	1080p	✓	✓	✓	✓								
	1080i	✓	✓	✓	✓								
	720p	✓	✓	✓	✓								
	576p	✓	✓	✓	✓								
	576i	✓	✓	✓	✓	✓							
COMPONENT	1080p	✓	✓	✓	✓		✓	✓	✓	✓			
	1080i	✓	✓	✓	✓			✓	✓	✓			
	720p	✓	✓	✓	✓			✓	✓	✓			
	576p	✓	✓	✓	✓			✓ ^{*2}	✓ ^{*2}	✓			
	576i	✓	✓	✓	✓	✓		✓ ^{*2}	✓ ^{*2}	✓	✓		
S-VIDEO	576i	✓	✓	✓	✓	✓		✓ ^{*2}	✓ ^{*2}	✓	✓	✓	✓
COMPOSITE	576i	✓	✓	✓	✓	✓		✓ ^{*2}	✓ ^{*2}	✓	✓	✓	✓

*2: The output is limited to 576p for an effective signal in the effect of Macrovision.

Memo

ONKYO CORPORATION

Sales & Product Planning Div. : 2-1, Nisshin-cho, Neyagawa-shi, OSAKA 572-8540, JAPAN
Tel: 072-831-8023 Fax: 072-831-8163

ONKYO U.S.A. CORPORATION

18 Park Way, Upper Saddle River, N.J. 07458, U.S.A.
Tel: +1-201-785-2600 Fax: +1-201-785-2650 <http://www.us.onkyo.com/>

ONKYO EUROPE ELECTRONICS GmbH

Liegnitzerstrasse 6, 82194 Groebenzell, GERMANY
Tel: +49-8142-4401-0 Fax: +49-8142-4401-555 <http://www.eu.onkyo.com/>

ONKYO EUROPE ELECTRONICS GmbH (UK BRANCH)

The Coach House 81A High Street, Marlow, Buckinghamshire, SL7 1AB, UK
Tel: +44-(0)1628-473-350 Fax: +44(0)-1628-401-700

ONKYO CHINA LIMITED

Unit 1 & 12, 9/F, Tower 1, Ever Gain Plaza, 88, Container Port Road, Kwai Chung,
N.T., Hong Kong. Tel: +86-852-2429-3118 Fax: +86-852-2428-9039
<http://www.ch.onkyo.com/>



Y0907-1

SN 29400059

(C) Copyright 2009 ONKYO CORPORATION Japan. All rights reserved.



* 2 9 4 0 0 0 5 9 *