

JBL® FLIP

OWNER'S MANUAL

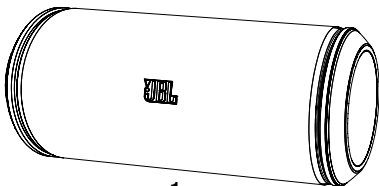

1x



1x

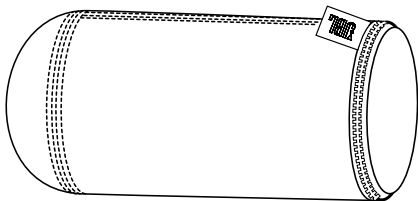

1x

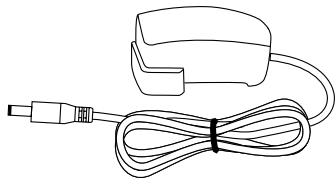

1x

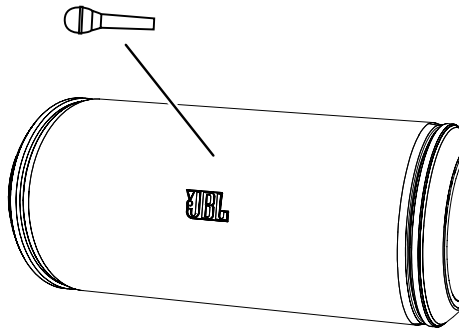
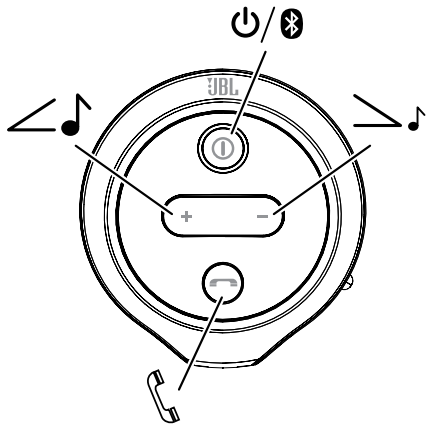

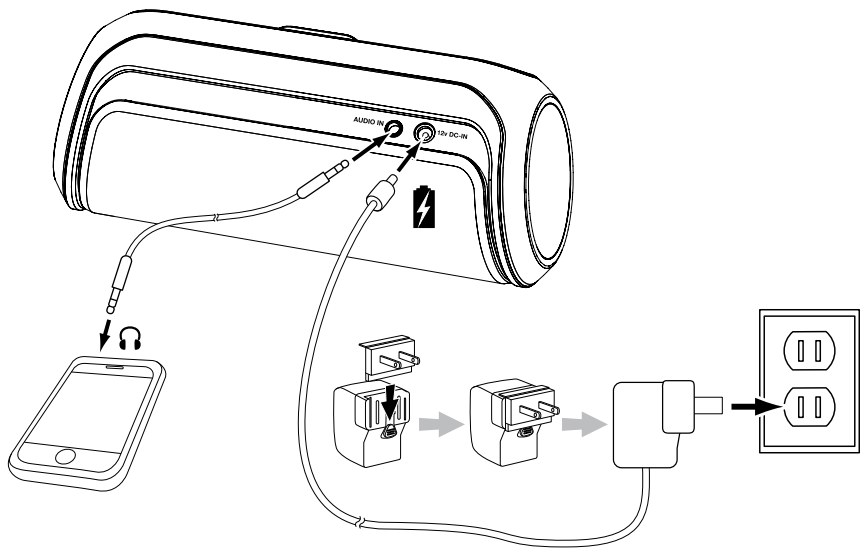



1.

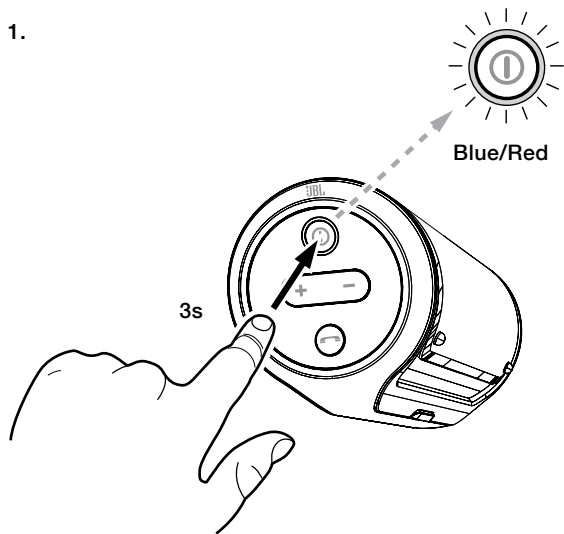

2.

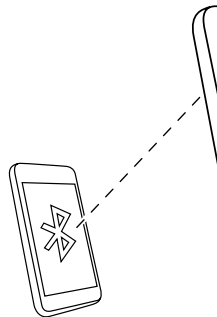

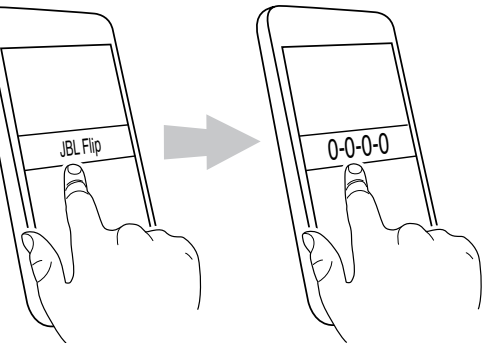



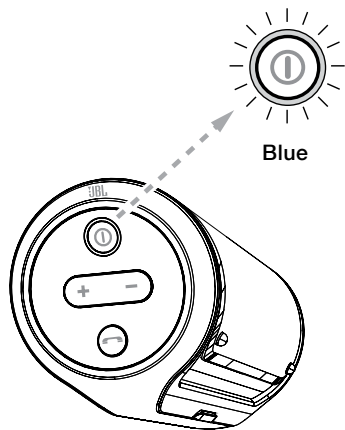

3.





PHONE BUTTON OPERATION

		
CONDITION	SHORT PRESS	LONG PRESS
No Call	N/A	Enter Voice Recognition Mode
Dialing Outgoing Calls	Hang Up	Hang Up
Incoming Call #1	Answer Call	Reject Call
During Call	Hang Up	Switch Call from Flip to Phone
Incoming Call #2	Put Call #1 on Hold; Answer Call #2	Reject Call #2
Calls #1 and #2 Both Active	Hang Up Current Call; Switch to Other Call	Switch Between Call #1 and Call #2



PHONE BUTTON OPERATION

		
CONDITION	SHORT PRESS	LONG PRESS
No Call	N/A	Enter Voice Recognition Mode
Dialing Outgoing Calls	Hang Up	Hang Up
Incoming Call #1	Answer Call	Reject Call
During Call	Hang Up	Switch Call from Flip to Phone
Incoming Call #2	Put Call #1 on Hold; Answer Call #2	Reject Call #2
Calls #1 and #2 Both Active	Hang Up Current Call; Switch to Other Call	Switch Between Call #1 and Call #2



PHONE BUTTON OPERATION

		
CONDITION	SHORT PRESS	LONG PRESS
No Call	N/A	Enter Voice Recognition Mode
Dialing Outgoing Calls	Hang Up	Hang Up
Incoming Call #1	Answer Call	Reject Call
During Call	Hang Up	Switch Call from Flip to Phone
Incoming Call #2	Put Call #1 on Hold; Answer Call #2	Reject Call #2
Calls #1 and #2 Both Active	Hang Up Current Call; Switch to Other Call	Switch Between Call #1 and Call #2



PHONE BUTTON OPERATION

		
CONDITION	SHORT PRESS	LONG PRESS
No Call	N/A	Enter Voice Recognition Mode
Dialing Outgoing Calls	Hang Up	Hang Up
Incoming Call #1	Answer Call	Reject Call
During Call	Hang Up	Switch Call from Flip to Phone
Incoming Call #2	Put Call #1 on Hold; Answer Call #2	Reject Call #2
Calls #1 and #2 Both Active	Hang Up Current Call; Switch to Other Call	Switch Between Call #1 and Call #2



PHONE BUTTON OPERATION

		
CONDITION	SHORT PRESS	LONG PRESS
No Call	N/A	Enter Voice Recognition Mode
Dialing Outgoing Calls	Hang Up	Hang Up
Incoming Call #1	Answer Call	Reject Call
During Call	Hang Up	Switch Call from Flip to Phone
Incoming Call #2	Put Call #1 on Hold; Answer Call #2	Reject Call #2
Calls #1 and #2 Both Active	Hang Up Current Call; Switch to Other Call	Switch Between Call #1 and Call #2



PHONE BUTTON OPERATION

		
CONDITION	SHORT PRESS	LONG PRESS
No Call	N/A	Enter Voice Recognition Mode
Dialing Outgoing Calls	Hang Up	Hang Up
Incoming Call #1	Answer Call	Reject Call
During Call	Hang Up	Switch Call from Flip to Phone
Incoming Call #2	Put Call #1 on Hold; Answer Call #2	Reject Call #2
Calls #1 and #2 Both Active	Hang Up Current Call; Switch to Other Call	Switch Between Call #1 and Call #2



PHONE BUTTON OPERATION

		
CONDITION	SHORT PRESS	LONG PRESS
No Call	N/A	Enter Voice Recognition Mode
Dialing Outgoing Calls	Hang Up	Hang Up
Incoming Call #1	Answer Call	Reject Call
During Call	Hang Up	Switch Call from Flip to Phone
Incoming Call #2	Put Call #1 on Hold; Answer Call #2	Reject Call #2
Calls #1 and #2 Both Active	Hang Up Current Call; Switch to Other Call	Switch Between Call #1 and Call #2



PHONE BUTTON OPERATION

		
CONDITION	SHORT PRESS	LONG PRESS
No Call	N/A	Enter Voice Recognition Mode
Dialing Outgoing Calls	Hang Up	Hang Up
Incoming Call #1	Answer Call	Reject Call
During Call	Hang Up	Switch Call from Flip to Phone
Incoming Call #2	Put Call #1 on Hold; Answer Call #2	Reject Call #2
Calls #1 and #2 Both Active	Hang Up Current Call; Switch to Other Call	Switch Between Call #1 and Call #2



PHONE BUTTON OPERATION

		
CONDITION	SHORT PRESS	LONG PRESS
No Call	N/A	Enter Voice Recognition Mode
Dialing Outgoing Calls	Hang Up	Hang Up
Incoming Call #1	Answer Call	Reject Call
During Call	Hang Up	Switch Call from Flip to Phone
Incoming Call #2	Put Call #1 on Hold; Answer Call #2	Reject Call #2
Calls #1 and #2 Both Active	Hang Up Current Call; Switch to Other Call	Switch Between Call #1 and Call #2



PHONE BUTTON OPERATION

		
CONDITION	SHORT PRESS	LONG PRESS
No Call	N/A	Enter Voice Recognition Mode
Dialing Outgoing Calls	Hang Up	Hang Up
Incoming Call #1	Answer Call	Reject Call
During Call	Hang Up	Switch Call from Flip to Phone
Incoming Call #2	Put Call #1 on Hold; Answer Call #2	Reject Call #2
Calls #1 and #2 Both Active	Hang Up Current Call; Switch to Other Call	Switch Between Call #1 and Call #2



PHONE BUTTON OPERATION

		
CONDITION	SHORT PRESS	LONG PRESS
No Call	N/A	Enter Voice Recognition Mode
Dialing Outgoing Calls	Hang Up	Hang Up
Incoming Call #1	Answer Call	Reject Call
During Call	Hang Up	Switch Call from Flip to Phone
Incoming Call #2	Put Call #1 on Hold; Answer Call #2	Reject Call #2
Calls #1 and #2 Both Active	Hang Up Current Call; Switch to Other Call	Switch Between Call #1 and Call #2



PHONE BUTTON OPERATION

		
CONDITION	SHORT PRESS	LONG PRESS
No Call	N/A	Enter Voice Recognition Mode
Dialing Outgoing Calls	Hang Up	Hang Up
Incoming Call #1	Answer Call	Reject Call
During Call	Hang Up	Switch Call from Flip to Phone
Incoming Call #2	Put Call #1 on Hold; Answer Call #2	Reject Call #2
Calls #1 and #2 Both Active	Hang Up Current Call; Switch to Other Call	Switch Between Call #1 and Call #2



PHONE BUTTON OPERATION

		
CONDITION	SHORT PRESS	LONG PRESS
No Call	N/A	Enter Voice Recognition Mode
Dialing Outgoing Calls	Hang Up	Hang Up
Incoming Call #1	Answer Call	Reject Call
During Call	Hang Up	Switch Call from Flip to Phone
Incoming Call #2	Put Call #1 on Hold; Answer Call #2	Reject Call #2
Calls #1 and #2 Both Active	Hang Up Current Call; Switch to Other Call	Switch Between Call #1 and Call #2



PHONE BUTTON OPERATION

		
CONDITION	SHORT PRESS	LONG PRESS
No Call	N/A	Enter Voice Recognition Mode
Dialing Outgoing Calls	Hang Up	Hang Up
Incoming Call #1	Answer Call	Reject Call
During Call	Hang Up	Switch Call from Flip to Phone
Incoming Call #2	Put Call #1 on Hold; Answer Call #2	Reject Call #2
Calls #1 and #2 Both Active	Hang Up Current Call; Switch to Other Call	Switch Between Call #1 and Call #2

PHONE BUTTON OPERATION

		
CONDITION	SHORT PRESS	LONG PRESS
No Call	N/A	Enter Voice Recognition Mode
Dialing Outgoing Calls	Hang Up	Hang Up
Incoming Call #1	Answer Call	Reject Call
During Call	Hang Up	Switch Call from Flip to Phone
Incoming Call #2	Put Call #1 on Hold; Answer Call #2	Reject Call #2
Calls #1 and #2 Both Active	Hang Up Current Call; Switch to Other Call	Switch Between Call #1 and Call #2

PHONE BUTTON OPERATION

		
CONDITION	SHORT PRESS	LONG PRESS
No Call	N/A	Enter Voice Recognition Mode
Dialing Outgoing Calls	Hang Up	Hang Up
Incoming Call #1	Answer Call	Reject Call
During Call	Hang Up	Switch Call from Flip to Phone
Incoming Call #2	Put Call #1 on Hold; Answer Call #2	Reject Call #2
Calls #1 and #2 Both Active	Hang Up Current Call; Switch to Other Call	Switch Between Call #1 and Call #2

SPECIFICATIONS

Transducers: 2 x 1-1/2" (38mm)

Amplifier power: 2 x 5W

Frequency response: 150Hz – 20kHz

Signal-to-noise ratio: >80dB

Battery type: Li-ion rechargeable

Bluetooth transmitter frequency range: 2.402 – 2.480GHz

Bluetooth transmitter power: 0 ~ 4dBm

Bluetooth transmitter modulation: GFSK

Listening time on battery power: >5 hours

Battery charge time: 3 hours

Dimensions (Dia x H): 63mm x 160mm
(2-7/16" x 6-5/16")

SPECIFICATIONS

Transducteurs : 2 x 1-1/2 po (38mm)

Puissance d'amplificateur : 2 x 5W

Courbe de résonance : 150Hz – 20kHz

Rapport signal sur bruit : >80dB

Type de batterie : Li-ion rechargeable

Plage de fréquence de l'émetteur *Bluetooth* : 2.402 – 2.480GHz

Puissance de l'émetteur *Bluetooth* : 0 ~ 4dBm

Modulation de l'émetteur *Bluetooth* : GFSK

Autonomie d'écoute : > 5 heures

Durée de charge : 3 heure

Dimensions (Dia x H) : 63mm x 160mm
(2-7/16 po x 6-5/16 po)

ESPECIFICACIONES

Transductores: 2 x 1-1/2" (38mm)

Potencia de amplificador: 2 x 5W

Respuesta en frecuencia: 150Hz – 20kHz

Relación señal/ruido: >80dB

Tipo de pila: Litio-ion recargable

Rango de frecuencia del transmisor *Bluetooth*: 2.402 – 2.480GHz

Potencia del transmisor *Bluetooth*: 0 ~ 4dBm

Modulación del transmisor *Bluetooth*: GFSK

Tiempo de escucha a pilas: >5 horas

Tiempo de carga de la pila: 3 horas

Dimensiones (Diámetro x Altura): 63mm x 160mm (2-7/16" x 6-5/16")

ESPECIFICAÇÕES

Transdutores: 2 x 1-1/2" (38mm)

Potência do amplificador: 2 x 5W

Resposta de frequência: 150Hz – 20kHz

Relação sinal/ruído: >80dB

Tipo da bateria: Íon-lítio recarregável

Intervalo de frequência do transmisor *Bluetooth*: 2.402 – 2.480GHz

Potencia do transmissor *Bluetooth*: 0 ~ 4dBm

Modulação do transmissor *Bluetooth*: GFSK

Tempo de reprodução com energia da bateria: >5 horas

Tempo de carga da bateria: 32 horas

Dimensões (Diâm. x A): 63mm x 160mm (2-7/16" x 6-5/16")

SPEZIFIKATIONEN

Wandler: 2 x 38mm

Verstärkerleistung: 2 x 5W

Frequenzgang: 150Hz – 20kHz

Signal-Rausch-Verhältnis: >80dB

Batterietyp: Li-ion wiederaufladbare

Bluetooth-
Sendefrequenzbereich: 2.402 – 2.480GHz

Bluetooth-Sendeleistung: 0 ~ 4dBm

Bluetooth-
Sendemodulation: GFSK

Hörstunden bei
Batteriebetrieb: >5 Stunden

Batterieladezeit: 3 Stunden

Abmessungen
(Durchm. x H): 63mm x 160mm

SPECIFICHE

Trasduttori: 2 x 1-1/2" (38mm)

Potenza amplificatore: 2 x 5W

Risposta in frequenza: 150Hz – 20kHz

Rapporto segnale-rumore: >80dB

Tipo batteria: Ioni di litio ricaricabile

Intervallo di frequenza
trasmettitore *Bluetooth*: 2.402 – 2.480GHz

Alimentazione trasmettitore
Bluetooth: 0 ~ 4dBm

Modulazione trasmettitore
Bluetooth: GFSK

Tempo di ascolto con
batteria: >5 ore

Tempo di ricarica della
batteria: 3 ore

Dimensioni (diam x A): 63mm x 160mm
(2-7/16 po x 6-5/16 po)

仕様	
トランスデューサー:	38mm 2個
アンプ出力:	2 x 5W
周波数応答:	150Hz - 20kHz
信号対雑音比 (SN比):	80dB未満
電池タイプ:	リチウムイオン再充電可能な
<i>Bluetooth</i> トランスミッターの 周波数帯域:	2.402 - 2.480GHz
<i>Bluetooth</i> トランスミッター の電源:	0 - 4dBm
<i>Bluetooth</i> トランスミッターの 変調方式:	GFSK
電池使用時の可聴時間:	5時間超
電池充電時間:	3時間
寸法 (直径×高さ):	63mm x 160mm (6-5/16インチ× 6-5/16インチ)

사양	
트랜스듀서:	38mm 2개
앰프 출력:	2 x 5W
주파수 응답 대역:	150Hz ~ 20kHz
신호대 잡음 비율:	80dB 이상
배터리 타입:	리튬-이온 충전식
블루투스 송수신기 주파수 대역:	2.402 - 2.480GHz
블루투스 송수신기 전원:	0 ~ 4dBm
블루투스 송수신기 변조:	GFSK
배터리 사용시간:	보다 큰 5시간
배터리 충전시간:	3 시간
규격(직경 x 높이):	63mm x 160mm (2-7/16" x 6-5/16")

规格

变频器: 2 x 1-1/2" (38mm)

放大器功率: 2 x 5W

频率响应: 150Hz – 20kHz

信噪比: >80dB

电池类型: 锂离子充电

Bluetooth 蓝牙发射机频率范围: 2.402 - 2.480GHz

Bluetooth 蓝牙发射机功率: 0 ~ 4dBm

Bluetooth 蓝牙传输器调制: GFSK

电池电量收听时间: >5 小时

电池充电时间: 3 小时

尺寸 (直径 x 高): 63mm x 160mm
(2-7/16" x 6-5/16")

SPECIFICATIONS

Transducers: 2 x 1-1/2" (38mm)

Amplifier power: 2 x 5W

Frequency response: 150Hz – 20kHz

Signal-to-noise ratio: >80dB

Battery type: Li-ion rechargeable

Bluetooth transmitter frequency range: 2.402 – 2.480GHz

Bluetooth transmitter power: 0 ~ 4dBm

Bluetooth transmitter modulation: GFSK

Listening time on battery power: >5 hours

Battery charge time: 3 hours

Dimensions (Dia x H): 63mm x 160mm
(2-7/16" x 6-5/16")

SPECIFICATIES

Omvormers:	2 x 38mm
Versterkervermogen:	2 x 5W
Frequentieweergave:	150Hz – 20kHz
Signaal-ruisverhouding:	>80dB
Type batterij:	Li-ion oplaadbare
<i>Bluetooth</i> zender frequentiebereik:	2.402 – 2.480GHz
Vermogen van de <i>Bluetooth</i> zender:	0 ~ 4dBm
<i>Bluetooth</i> zendermodulatie:	GFSK
Luistertijd voor batterij:	>5 uur
Oplaaftijd voor batterij:	3 uur
Afmetingen (Diameter x Hoogte):	63mm x 160mm

SPESIFIKASJONER

Omformere:	2 x 1-1/2" (38mm)
Forsterkereffekt:	2 x 5W
Frekvensrespons:	150Hz – 20kHz
Signal-til-støy-forhold:	>80dB
Batteritype:	Li-ion genopladelige
<i>Bluetooth</i> -senders frekvensområde:	2.402 – 2.480GHz
<i>Bluetooth</i> -senders effekt:	0 ~ 4dBm
<i>Bluetooth</i> -senders effekt:	GFSK
Lyttetid på batteristrøm:	>5 timer
Batteriladetid:	3 time
Dimensjoner (D x H):	63mm x 160mm (2-7/16" x 6-5/16")

TEKNISET TIEDOT

Anturit: 2 x 1-1/2" (38mm)

Vahvistinteho: 2 x 5W

Taajuusvaste: 150Hz – 20kHz

Äänentoisto: >80dB

Paristo: Li-ion

Bluetooth-lahettimen taajuusalue: 2.402 – 2.480GHz

Bluetooth-lahettimen teho: 0 ~ 4dBm

Bluetooth-lahettimen modulaatio: GFSK

Kuuntelu-aika paristokäytöllä: > 5 tuntia

Pariston latausaika: 3 tuntia

Mitat (Halk. x K): 63mm x 160mm
(2-7/16 tuumaa x 6-5/16 tuumaa)

ТЕХНИЧЕСКИЕ ХАРАКТЕРИСТИКИ

Динамики: 2 x 1-1/2" (38mm)

Мощность усилителя: 2 x 5Вт

Частотная характеристика: 150Гц – 20кГц

Отношение сигнал/шум: >80дБ

Тип аккумулятора: Литий-ионный перезаряжаемый

Диапазон частот передатчика *Bluetooth*: 2.402 – 2.480GHz

Мощность передатчика *Bluetooth*: 0 – 4dBm

Модуляция передатчика *Bluetooth*: GFSK

Время звучания от аккумулятора: >5 часов

Время зарядки аккумулятора: 3 часа

Размеры (Диаметр x В): 63mm x 160mm
(2-7/16" x 6-5/16")

SPECIFIKATIONER

Omvandlare: 2 x 38mm

Förstärkareffekt: 2 x 5W

Frekvensåtergivning: 150Hz – 20kHz

Signalbrusförhållande: >80dB

Batterityp: Litiumjon

Bluetooth-sandarens
frekvensområde: 2.402 – 2.480GHz

Bluetooth-sandareffekt: 0 ~ 4dBm

Bluetooth-
sandarmodulering: GFSK

Lyssningstid med batteri: > 5 timmar

Batteriladdningstid: 3 timmar

Mått (diameter x höjd): 63mm x 160mm

SPECIFIKATIONER

Transducere: 2 x 1-1/2" (38mm)

Forstærkerstrøm: 2 x 5W

Frekvenssvar: 150Hz – 20kHz

Signal-til-støj-forhold: >80dB

Batteri-type: Li-ion opladbart

Bluetooth-sender: 2.402 – 2.480GHz

Bluetooth-sendereffekt: 0 ~ 4dBm

Bluetooth-
sendermodulation: GFSK

Lyttetid på batteristrøm: > 5 timer

Batteri-opladetid: 3 time

Dimensioner (Dia. x H):
63mm x 160mm
(2-7/16 tommer x
6-5/16 tommer)



HARMAN

HARMAN International Industries, Incorporated
8500 Balboa Boulevard, Northridge,
CA 91329 USA
www.jbl.com

© 2012 HARMAN International Industries, Incorporated. All rights reserved.
JBL is a trademark of HARMAN International Industries, Incorporated,
registered in the United States and/or other countries. The *Bluetooth* word
mark and logos are owned by the *Bluetooth* SIG, Inc. and any use of such
marks by HARMAN International Industries, Incorporated is under license.

Features, specifications and appearance are subject to change without notice.

Part #: 950-0474-001 Rev. A