

Operation Manual

NAVIGATION AV SYSTEM

AVIC-F30BT AVIC-F930BT AVIC-F9310BT

Be sure to read **Important Information for the User** first!

Important Information for the User includes the important information that you must understand before using this navigation system.

Thank you for buying this Pioneer product.

Please read through these operating instructions so you will know how to operate your model properly. *After you have finished reading the instructions, keep this manual in a safe place for future reference.*



Important

The screens shown in the examples may differ from actual screens.
Actual screens may be changed without notice for performance and function improvements.

01 Introduction

- Manual overview **9**
 - How to use this manual **9**
 - Conventions used in this manual **9**
 - Terms used in this manual **9**
- Notice regarding video viewing **10**
- Notice regarding DVD-Video viewing **10**
- Notice regarding MP3 file usage **10**
- iPod compatibility **10**
- Map coverage **11**
- Protecting the LCD panel and screen **11**
- Notes on internal memory **11**
 - Before removing the vehicle battery **11**
 - Data subject to erasure **11**

02 Basic operation

- Checking part names and functions **12**
 - Protecting your product from theft **14**
- Adjusting the LCD panel angle **15**
- Inserting and ejecting a disc **15**
 - Inserting a disc (for AVIC-F30BT) **15**
 - Ejecting a disc (for AVIC-F30BT) **16**
 - Inserting a disc (for AVIC-F930BT and AVIC-F9310BT) **16**
 - Ejecting a disc (for AVIC-F930BT and AVIC-F9310BT) **16**
- Inserting and ejecting an SD memory card **17**
 - Inserting an SD memory card (for AVIC-F30BT) **17**

- Ejecting an SD memory card (for AVIC-F30BT) **17**
- Inserting an SD memory card (for AVIC-F930BT and AVIC-F9310BT) **18**
- Ejecting an SD memory card (for AVIC-F930BT and AVIC-F9310BT) **19**

Plugging and unplugging a USB storage device **19**

- Plugging in a USB storage device **20**
 - Unplugging a USB storage device **20**
- Connecting and disconnecting an iPod **20**
- Connecting your iPod **20**
 - Disconnecting your iPod **20**

Startup and termination **21**

On first-time startup **21**

Regular startup **21**

03 How to use the navigation menu screens

- Screen switching overview **22**
- What you can do on each menu **23**
- Shortcut Menu **23**
 - Selecting the shortcut **23**
 - Removing a shortcut **24**
- Operating list screens (e.g. POI list) **24**
- Operating the on-screen keyboard **24**

04 How to use the map

- How to read the map screen **25**
 - Enlarged map of the intersection **26**
 - Display during motorway driving **27**
- Types of the road stored in the map database **27**
- Operating the map screen **27**
 - Changing the scale of the map **27**
 - Switching the map orientation **28**
 - Scrolling the map to the position you want to see **28**
 - Viewing information about a specified location **28**
 - Using shortcut menus on the map **29**

- Switching the view mode **30**
- 05 Eco-friendly driving functions**
 - Checking the eco-friendly driving status **32**
 - Displaying Eco Drive Level guidance **33**
 - Sudden start alert **33**
- 06 Searching for and selecting a location**
 - The basic flow of creating your route **34**
 - Searching for a location by address **35**
 - Searching for a street name first **35**
 - Searching for a city name first **36**
 - Finding your destination by specifying the postcode **37**
 - Setting up a route to your home **38**
 - Searching for Points of Interest (POI) **38**
 - Searching for POIs by preset categories **38**
 - Searching for a POI directly from the name of the facilities **38**
 - Searching for a nearby POI **39**
 - Searching for POIs around the destination **39**
 - Searching for POIs around the city **39**
 - Selecting destination from “Favourites” **40**
 - Searching for POIs by using the data on the SD memory card **40**
 - Selecting a location you searched for recently **41**
 - Searching for a location by coordinates **41**
- 07 After the location is decided**
 - Setting a route to your destination **42**
 - Displaying multiple routes **42**
- 08 Checking and modifying the current route**
 - Displaying the route overview **43**
 - Modifying the route calculation conditions **43**
 - Items that users can operate **43**
- Checking the current itinerary **44**
- Editing waypoints **45**
 - Adding a waypoint **45**
 - Deleting a waypoint **45**
 - Sorting waypoints **46**
- Canceling the route guidance **46**
- 09 Registering and editing locations**
 - Storing favourite locations **47**
 - Registering a location by “Favourites” **47**
 - Registering a location by scroll mode **47**
 - Editing registered locations **47**
 - Editing the favourite location in the list **47**
 - Editing your home **48**
 - Sorting the favourite locations in the list **48**
 - Deleting a favourite location from the list **49**
 - Exporting and importing favourite locations **49**
 - Exporting favourite locations **49**
 - Importing favourite locations **49**
 - Deleting the destination history from the list **50**
- 10 Using traffic information**
 - Checking all traffic information **51**
 - Checking traffic information on the route **52**
 - How to read traffic information on the map **52**
 - Setting an alternative route to avoid traffic jams **52**
 - Checking for traffic jams automatically **53**

- Checking traffic information manually **53**

Selecting traffic information to display **54**

Selecting preferred RDS-TMC service provider manually **54**

11 Registering and connecting a Bluetooth device

Preparing communication devices **55**

Registering your Bluetooth devices **55**

- Searching for nearby Bluetooth devices **55**
- Pairing from your Bluetooth devices **56**
- Searching for a specified Bluetooth device **57**
- Deleting a registered device **58**

Connecting a registered Bluetooth device manually **58**

- Setting for priority connecting **59**

12 Using hands-free phoning

Displaying the phone menu **60**

Making a phone call **60**

- Direct dialling **60**
- Making a call home easily **61**
- Calling a number in the phone book **61**
- Dialling from the history **62**
- Dialling a favourite location **62**
- Dialling a facility's phone number **62**
- Dialling from the map **63**

Receiving a phone call **63**

- Answering an incoming call **63**

Transferring the phone book **64**

- Deleting registered contacts **65**

Changing the phone settings **65**

- Editing the device name **65**
- Editing the password **65**

- Stopping Bluetooth wave transmission **66**

– Echo cancelling and noise reduction **66**

– Answering a call automatically **66**

– Setting the automatic rejection function **67**

– Clearing memory **67**

– Updating the Bluetooth wireless technology software **67**

Notes for hands-free phoning **68**

13 Basic operations of the AV source

Displaying the AV operation screen **70**

- Selecting a source **70**

Operating list screens (e.g. iPod list screen) **70**

– Switching between the AV operation screen and the list screen **70**

– Selecting an item **71**

– Returning to the previous display **71**

14 Using the radio (FM)

Starting procedure **72**

Reading the screen **72**

Using the touch panel keys **73**

– Storing and recalling broadcast frequencies **74**

– Using radio text **74**

Operating by hardware buttons **75**

Using advanced functions **75**

– Storing the strongest broadcast frequencies **75**

– Tuning in strong signals **75**

– Limiting stations to regional programming **76**

– Searching for an RDS station by PTY information **76**

– Receiving traffic announcements **76**

– Tuning into alternative frequencies **77**

- Using news programme interruption **77**
- Interruption icon status **77**
- PTY list **79**

15 Using the radio (AM)

- Starting procedure **80**
- Reading the screen **80**
- Using the touch panel keys **81**
 - Storing and recalling broadcast frequencies **81**
- Operating by hardware buttons **82**
- Using advanced functions **82**
 - Storing the strongest broadcast frequencies **82**
 - Tuning in strong signals **82**

16 Playing audio CDs

- Starting procedure **84**
- Reading the screen **84**
- Using the touch panel keys **85**
- Operating by hardware buttons **86**
- Using advanced functions **86**

17 Playing music files on ROM

- Starting procedure **87**
- Reading the screen **87**
- Using the touch panel keys **89**
- Operating by hardware buttons **90**
- Using advanced functions **90**

18 Playing a DVD-Video

- Starting procedure **92**
- Reading the screen **92**
- Using the touch panel keys **93**
 - Resuming playback (Bookmark) **94**
 - Searching for a specific scene and starting playback from a specified time **95**
 - Direct number search **95**

- Operating the DVD menu **95**
- Using DVD menu by touch panel keys **95**
- Frame-by-frame playback **96**
- Slow motion playback **96**
- Operating by hardware buttons **96**
- Using advanced functions **96**

19 Playing a DivX video

- Starting procedure **98**
- Reading the screen **98**
- Using the touch panel keys **99**
 - Frame-by-frame playback **100**
 - Slow motion playback **100**
 - Starting playback from a specified time **101**
- Operating by hardware buttons **101**
- Using advanced functions **101**

20 DVD-Video or DivX setup

- Displaying DVD/DivX® Setup menu **102**
- Setting the top-priority languages **102**
- Setting the angle icon display **102**
- Setting the aspect ratio **103**
- Setting the parental lock **103**
 - Setting the code number and level **103**
- Setting the auto play **104**
- Setting the subtitle file for DivX **104**
- Language code chart for DVDs **105**

21 Playing music files (from USB or SD)

- Starting procedure **106**
- Reading the screen **106**
- Using the touch panel keys (Music) **108**
- Operating by hardware buttons **109**
- Using advanced functions **109**

22 Playing video files (from USB or SD)

- Starting procedure **110**

- Reading the screen **110**
- Using the touch panel keys (Video) **111**
 - Searching for a specific scene and starting playback from a specified time **112**
- Operating by hardware buttons **112**
- Using advanced functions **112**
- 23 Using an iPod (iPod)**
 - Starting procedure **113**
 - Reading the screen **113**
 - Using the touch panel keys **115**
 - Operating by hardware buttons **117**
 - Starting the video playback **117**
 - Narrowing down a song or video with the list **117**
 - Operating the functions from your iPod **118**
 - Playing MusicSphere **119**
 - Starting procedure **119**
 - Reading the screen **119**
 - Using the touch panel keys **119**
 - Using advanced functions **119**
- 24 Using the Bluetooth audio player**
 - Starting procedure **121**
 - Reading the screen **121**
 - Using the touch panel keys **123**
 - Operating by hardware buttons **123**
 - Using advanced functions **124**
- 25 Using AV input**
 - Reading the screen **125**
 - Using AV1 **125**
 - Using AV2 **125**
 - Using the touch panel keys **125**
- 26 Customising preferences**
 - Displaying the screen for navigation settings **126**
 - Checking the connections of leads **126**
 - Checking sensor learning status and driving status **127**
 - Clearing status **127**
 - Using the fuel consumption function **128**
 - Inputting the fuel consumption information for calculating the fuel cost **128**
 - Calculating the fuel consumption **128**
 - Exporting the data of fuel cost information **129**
 - Recording your travel history **130**
 - Using the demonstration guidance **130**
 - Registering your home **130**
 - Correcting the current location **131**
 - Changing the eco-function setting **131**
 - Displaying the screen for map settings **132**
 - Setting the auto-zoom display **132**
 - Setting the detailed city map **132**
 - Setting the barrier graphic for city map **133**
 - Setting the speed limit display **133**
 - Displaying the traffic notification icon **134**
 - Displaying the Bluetooth connection icon **134**
 - Setting the current street name display **134**
 - Setting the display of icons of favourite locations **134**
 - Displaying the 3D landmarks **135**
 - Displaying manoeuvres **135**
 - Displaying the fuel consumption information **135**
 - Displaying POI on the map **136**
 - Displaying preinstalled POIs on the map **136**
 - Displaying the customised POIs **137**
 - Changing the view mode **137**
 - Setting the map colour change between day and night **137**
 - Changing the road colour **138**

- Changing the setting of navigation interruption screen **138**
 - Selecting the "Quick Access" menu **138**
 - Displaying the screen for system settings **139**
 - Customising the regional settings **139**
 - Setting the Volume for Guidance and Phone **142**
 - Changing the preinstalled splash screen **142**
 - Changing to the splash screen stored in the SD memory card **143**
 - Setting for rear view camera **143**
 - Adjusting the response positions of the touch panel (touch panel calibration) **144**
 - Setting the illumination colour **144**
 - Checking the version information **145**
 - Reversing the climate control status display **145**
 - Selecting the video for rear display **146**
 - Adjusting the picture **146**
 - Displaying the screen for AV system settings **147**
 - Setting video input 1 (AV1) **148**
 - Setting video input 2 (AV2) **148**
 - Changing the wide screen mode **148**
 - Setting the rear output **149**
 - Switching the muting/attenuation timing **149**
 - Switching the muting/attenuation level **150**
 - Switching Auto PI seek **150**
 - Setting the FM tuning step **150**
 - Displaying your DivX VOD registration code **151**
 - Displaying your DivX VOD deregistration code **151**
 - Displaying the screen for AV sound settings **151**
 - Using balance adjustment **152**
 - Using the equaliser **152**
 - Adjusting the equaliser curve automatically (Auto EQ) **154**
 - Using sonic centre control **156**
 - Adjusting loudness **157**
 - Using subwoofer output **157**
 - Using the high pass filter **157**
 - Adjusting source levels **158**
 - Enhancing bass (Bass Booster) **158**
 - Replicating the settings **158**
 - Setting the safe mode **158**
 - Turning off the screen **159**
- 27 Displaying the operation status of vehicle equipment**
- Displaying obstacle detection information **160**
 - Displaying the operating status of the climate control panel **160**
- 28 Operating your navigation system with voice**
- To ensure safe driving **162**
 - Basics of the voice operation **162**
 - Flow of the voice operation **162**
 - Starting the voice operation **162**
 - How to use the voice operation **163**
 - Available basic voice commands **165**
 - Basic commands **165**
 - Voice operation for AV source **165**
 - Voice commands related to hands-free phoning **166**
 - Tips for the voice operation **166**
- 29 Other functions**
- Setting the anti-theft function **167**
 - Setting the password **167**

- Entering the password **167**
- Deleting the password **167**
- Forgotten password **167**

- Returning the navigation system to the default or factory settings **168**
- Restoring the default setting **168**
 - Returning the navigation system to the initial state **168**
 - Setting items to be deleted **169**

● Appendix

- Troubleshooting **171**
- Messages and how to react to them **176**
- Messages for audio functions **178**
- Positioning technology **180**
- Positioning by GPS **180**
 - Positioning by dead reckoning **180**
 - How do GPS and dead reckoning work together? **180**
- Handling large errors **181**
- When positioning by GPS is impossible **181**
 - Conditions likely to cause noticeable positioning errors **182**
- Route setting information **184**
- Route search specifications **184**
- Handling and care of discs **184**
- Built-in drive and care **185**
 - Ambient conditions for playing a disc **185**
- Playable discs **185**
- DVD-Video and CD **185**
 - AVCHD recorded discs **186**
 - Playing DualDisc **186**
 - Dolby Digital **186**
- Detailed information for playable media **186**
- Compatibility **186**
 - Media compatibility chart **189**
- Bluetooth **193**
- SD and SDHC logo **193**

WMA/WMV **194**

DivX **194**

AAC **194**

Detailed information regarding connected iPod devices **194**

- iPod and iPhone **195**
- iTunes **195**

Using the LCD screen correctly **195**

- Handling the LCD screen **195**
- Liquid crystal display (LCD) screen **195**
- Maintaining the LCD screen **195**
- LED (light-emitting diode) backlight **196**

Display information **197**

- Destination Menu **197**
- Phone Menu **197**
- Settings Menu **198**
- Navi Settings menu **198**
- System Settings menu **199**
- Map Settings menu **199**
- Bluetooth Settings menu **200**
- AV System Settings menu **200**
- AV Sound Settings menu **201**

Glossary **202**

Specifications **205**

Manual overview

Before using this product, be sure to read **Important Information for the User** (a separate manual) which contains warnings, cautions, and other important information that you should note.

The screen examples shown in this manual are the ones for AVIC-F30BT. If you use a different model, the screens that appear may differ from the examples in the manual.

How to use this manual

Finding the operation procedure for what you want to do

When you have decided what you want to do, you can find the page you need from the *Contents*.

Finding the operation procedure from a menu name

If you want to check the meaning of an item displayed on the screen, you will find the necessary page from the *Display information* at the end of the manual.

Glossary

Use the glossary to find the meanings of terms.

Conventions used in this manual

Before moving on, take a few minutes to read the following information about the conventions used in this manual. Familiarity with these conventions will help you greatly as you learn how to use your new equipment.

- Buttons on your navigation system are described in **ALL CAPITAL, BOLD** lettering; e.g.) **HOME** button, **MODE** button.
- Menu items, screen titles, and functional components are described in **bold** with double quotation marks “ ”:

e.g.)

“**Destination Menu**” screen or “**AV Source**” screen

- Touch panel keys that are available on the screen are described in **bold** in brackets []: e.g.) **[Destination]**, **[Settings]**.
- Extra information, alternatives and other notes are presented in the following format: e.g.)
 - If the home location has not been stored yet, set the location first.
- Functions of other keys on the same screen are indicated with **■** at the beginning of the description: e.g.)
 - If you touch **[OK]**, the entry is deleted.
- References are indicated like this: e.g.)
 - ➔ For details of the operations, refer to *Screen switching overview* on page 22.

Terms used in this manual

“Front display” and “Rear display”

In this manual, the screen that is attached to the body of this navigation unit will be referred to as the “Front display”. Any additional screen that is commercially available and can be connected to this navigation unit will be referred to as the “Rear display”.

“Video image”

“Video image” in this manual indicates moving images of DVD-Video, DivX®, iPod, and any equipment that is connected to this system with an RCA cable, such as general-purpose AV equipment.

“External storage device (USB, SD)”

The SD memory card, SDHC memory card, microSD card, microSDHC card and USB memory device are collectively referred to as the “external storage device (USB, SD)”. If it indicates the USB memory only, it is referred to as the “USB storage device”.

“SD memory card”

The SD memory card, SDHC memory card, microSD card and microSDHC card are collectively referred to as the “SD memory card”. □

Notice regarding video viewing

Remember that use of this system for commercial or public viewing purposes may constitute an infringement on the author’s rights as protected by the Copyright Law. □

Notice regarding DVD-Video viewing

This item incorporates copy protection technology that is protected by U.S. patents and other intellectual property rights of Rovi Corporation. Reverse engineering and disassembly are prohibited. □

Notice regarding MP3 file usage

Supply of this navigation system conveys only a licence for private, non-commercial use and does not convey a licence nor imply any right to use this product in any commercial (i.e. revenue-generating), real time broadcasting (terrestrial, satellite, cable and/or any other media), broadcasting/streaming via internet, intranets and/or other networks or in other electronic content distribution systems, such

as pay-audio or audio-on-demand applications. An independent licence for such use is required. For details, please visit <http://www.mp3licensing.com>. □

iPod compatibility

This product supports only the following iPod models and iPod software versions. Others may not work correctly.





- iPod touch fourth generation: Ver. 4.1
 - iPod touch third generation: Ver. 4.1
 - iPod touch second generation: Ver. 4.1
 - iPod touch first generation: Ver. 3.1.3
 - iPod classic 120GB: Ver. 2.0.1
 - iPod classic 160GB (2009): Ver. 2.0.4
 - iPod classic 80GB: Ver. 1.1.2
 - iPod classic 160GB (2007): Ver. 1.1.2
 - iPod with video: Ver. 1.3
 - iPod nano sixth generation: Ver. 1.0
 - iPod nano fifth generation: Ver. 1.0.2
 - iPod nano fourth generation: Ver. 1.0.4
 - iPod nano third generation: Ver. 1.1.3
 - iPod nano second generation: Ver. 1.1.3
 - iPod nano first generation: Ver. 1.3.1
 - iPhone 4: Ver. 4.1
 - iPhone 3GS: Ver. 4.1
 - iPhone 3G: Ver. 4.1
 - iPhone: Ver. 3.1.3
- In this manual, iPod and iPhone will be referred to as iPod.
- When you use this navigation system with a Pioneer USB interface cable for iPod (CD-LU51V) (sold separately), you can control an iPod compatible with this navigation system.
- Operation methods may vary depending on the iPod models and the software version of iPod.
- Depending on the software version of the iPod, it may not be compatible with this equipment.
- For details about iPod compatibility with this navigation system, refer to the information on our website. □

Introduction

Map coverage

For details about the map coverage of this navigation system, refer to the information on our website. 



Protecting the LCD panel and screen

-  Do not allow direct sunlight to fall on the LCD screen when this product is not being used. Extended exposure to direct sunlight can result in LCD screen malfunction due to the resulting high temperatures.
-  When using a mobile phone, keep the aerial of the mobile phone away from the LCD screen to prevent disruption of the video in the form of spots, coloured stripes, etc.
-  To protect the LCD screen from damage, be sure to touch the touch panel keys with your finger only and gently touch the screen. 

Notes on internal memory



Before removing the vehicle battery

If the battery is disconnected or discharged, the memory will be erased and must be reprogrammed.

-  Some data remains. Be sure to read *Setting items to be deleted* first.
 -  For details, refer to *Setting items to be deleted* on page 169.

Data subject to erasure

The information is erased by disconnecting the yellow lead from the battery (or removing the battery itself).

-  Some data remains. Be sure to read *Setting items to be deleted* first.
 -  For details, refer to *Setting items to be deleted* on page 169. 

Checking part names and functions

This chapter gives information about the names of the parts and the main features using the buttons.

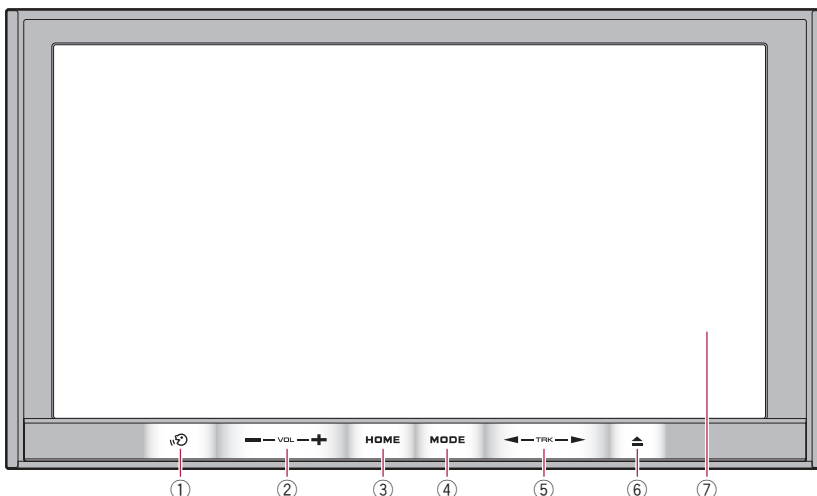

AVIC-F30BT (with the LCD panel closed)

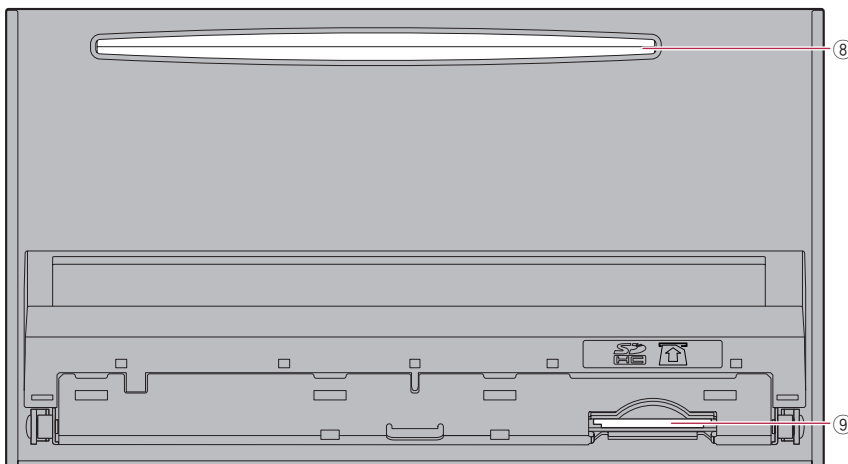

AVIC-F30BT (with the LCD panel open)

Basic operation

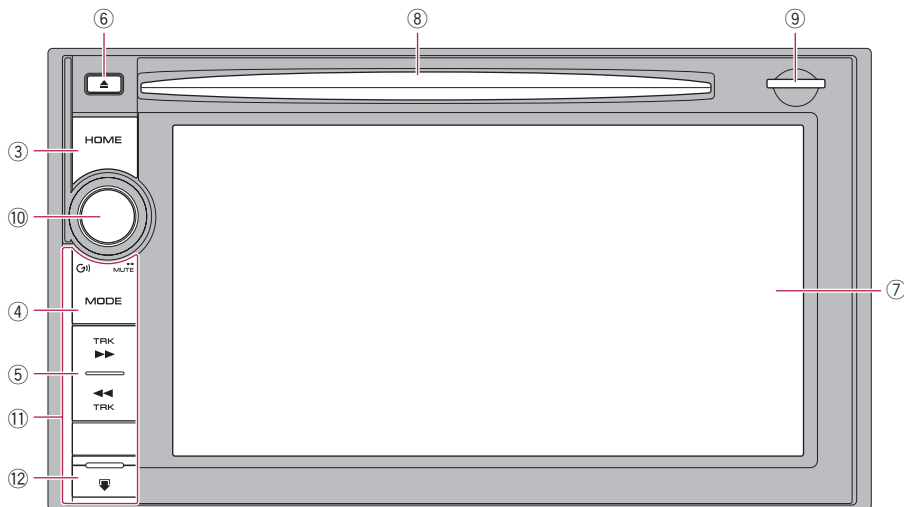

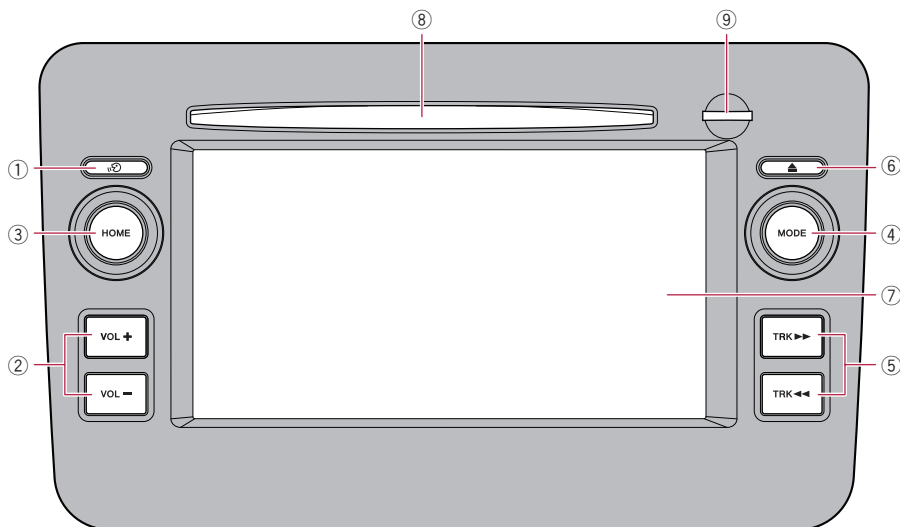

AVIC-F930BT





AVIC-F9310BT

①  button
AVIC-F30BT

- Press the  button to activate voice operations.
➔ For details, refer to Chapter 28.

- Press and hold the  button to switch the AV source to mute.
To cancel the muting, press and hold it again.

AVIC-F9310BT

- Press the  button to hear the route guidance.
- Press and hold the  button to switch the AV source to mute. To cancel the muting, press and hold it again.

② VOL (+/-) button

Press to adjust the AV (Audio and Video) source volume.

③ HOME button

- Press the **HOME** button to display the “**Top Menu**” screen.
- Press to switch between the Classic Menu and the Shortcut Menu while the “**Top Menu**” is displayed.
 - ➔ For details, refer to *What you can do on each menu* on page 23.
- Press and hold to turn off the screen display.

④ MODE button

- Press to switch between the map screen and the AV operation screen.
- Press to display the map screen while the navigation function screen is displayed.
- Press and hold to display the “**Picture Adjustment**” screen.
 - ➔ For details, refer to *Adjusting the picture* on page 146.

⑤ TRK button

Press to perform manual seek tuning, fast forward, reverse and track search controls.

- ➔ For details, refer to the descriptions from Chapter 14 to Chapter 25.

⑥ ▲ button**⑦ LCD screen****⑧ Disc-loading slot**

Insert a disc to play.

- ➔ For details, refer to *Inserting and ejecting a disc* on the next page.

⑨ SD card slot

- ➔ For details, refer to *Inserting and ejecting an SD memory card* on page 17.

⑩ Multi-control (Volume knob/G₁)/MUTE

- Rotate to adjust the AV (Audio and Video) source volume.
- Press the centre of Multi-control to hear the route guidance.
- Press and hold the centre of Multi-control to mute the AV (Audio and Video) source. To cancel the muting, press and hold it again.

⑪ Front panel**⑫ Detach button**

Press to remove the front panel from the navigation system.

- ➔ For details, refer to *Removing the front panel* on the next page.

Protecting your product from theft

- ❑ This function is available for AVIC-F930BT only.

The front panel can be detached from the navigation system to discourage theft, as described below.

 CAUTION

- Do not expose the front panel to excessive shock or disassemble it.
- Never grip the buttons tightly or use force when removing or attaching.
- Keep the front panel out of reach of small children to prevent them from putting it in their mouths.
- After removing the front panel, keep it in a safe place so it is not scratched or damaged.
- Keep the front panel out of direct sunlight and high temperatures.
- When removing or attaching the front panel, do so after turning the ignition switch off (ACC OFF).

Basic operation

Removing the front panel

- ❑ The navigation system cannot be operated while the front panel is removed from the navigation system.

1 Press and hold the Detach button, and slide it down.

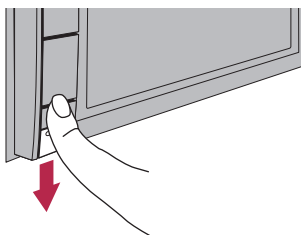

When you release your finger, the bottom of the front panel separates slightly from the navigation system.

2 Gently grip the bottom of the front panel and slowly pull it outward.

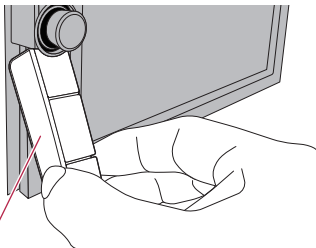

Front panel

Attaching the front panel

1 Slide the front panel all the way into the navigation system.

Make sure the front panel is securely connected to the mounting hooks of the navigation system.

2 Push the lower part of the front panel until you hear a click.

If you fail to successfully attach the front panel to the navigation system, try again but be careful not to force it as the panel could be damaged. ■

Adjusting the LCD panel angle

- ❑ This function is available for AVIC-F30BT only.

! WARNING

When opening, closing and adjusting the angle of the LCD panel, be careful not to get your fingers caught.

! CAUTION

Do not open or close the LCD panel by force. This may cause malfunction.

1 Press the button.

The "Monitor Setup" screen appears.

2 Touch or to adjust the angle.

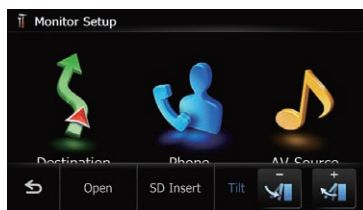

3 Touch .

- ❑ The adjusted angle of the LCD panel will be memorised and the LCD panel will automatically return to that angle the next time the LCD panel is opened or closed. ■

Inserting and ejecting a disc

Inserting a disc (for AVIC-F30BT)

! WARNING

- When opening, closing and adjusting the angle of the LCD panel, be careful not to get your fingers caught.
- Do not use with the LCD panel left open. If LCD panel is left open, it may result in injury in the event of an accident.

⚠ CAUTION

- Do not open or close the LCD panel by force. This may cause malfunction.
- Do not operate this navigation system until the LCD panel completely opens or closes. If this navigation system is operated while the LCD panel is opening or closing, the LCD panel may stop at that angle for safety.
- Do not place a glass or a can on the open LCD panel. Doing so may break this navigation system.
- Do not insert anything other than a disc into the disc-loading slot.

1 Press the **▲** button.

The "Monitor Setup" screen appears.

2 Touch [Open].



The LCD panel opens, and the disc-loading slot appears.

3 Insert a disc into the disc-loading slot.

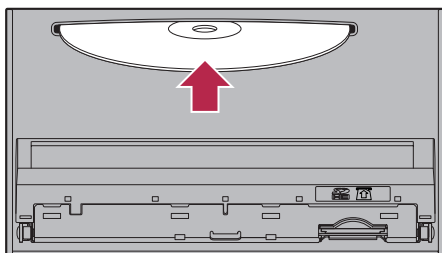

The disc is loaded, and the LCD panel closes.

Ejecting a disc (for AVIC-F30BT)

1 Press the **▲** button.

The "Monitor Setup" screen appears.

2 Touch [Disc Eject].



The LCD panel opens, and the disc is ejected.

3 Remove the disc, and press the **▲** button.

The LCD panel closes.

Inserting a disc (for AVIC-F930BT and AVIC-F9310BT)

● Insert a disc into the disc-loading slot.

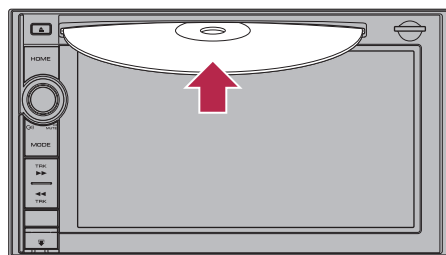

- ❑ Do not insert anything other than a disc into the disc-loading slot.

Ejecting a disc (for AVIC-F930BT and AVIC-F9310BT)

1 Press the **▲** button.

The touch panel keys for ejecting the media appear.

Basic operation

2 Touch [Disc Eject].

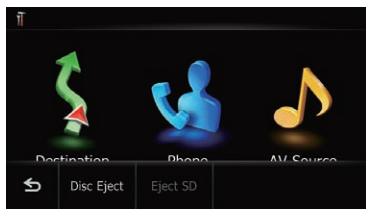

The disc is ejected.

Inserting and ejecting an SD memory card

⚠ CAUTION

- Ejecting an SD memory card during data transfer can damage the SD memory card. Be sure to eject the SD memory card by the procedure described in this manual.
- If data loss or corruption occurs on the storage device for any reason, it is usually not possible to recover the data. Pioneer accepts no liability for damages, costs or expenses arising from data loss or corruption.
- Do not insert anything other than SD memory cards.

- This system is not compatible with Multi Media Card (MMC).
- Compatibility with all SD memory cards is not guaranteed.
- This unit may not achieve optimum performance with some SD memory cards.

Inserting an SD memory card (for AVIC-F30BT)

⚠ CAUTION

- Do not press the **▲** button when an SD memory card is not fully inserted. Doing so may damage the card.
- Do not press the **▲** button before an SD memory card has been completely removed. Doing so may damage the card.

1 Press the **▲** button.

The "Monitor Setup" screen appears.

2 Touch [SD Insert].



The LCD panel opens, and the SD card slot appears.

3 Insert an SD memory card into the SD card slot.

Insert it with the label surface facing to the upside and press the card until it clicks and completely locks.

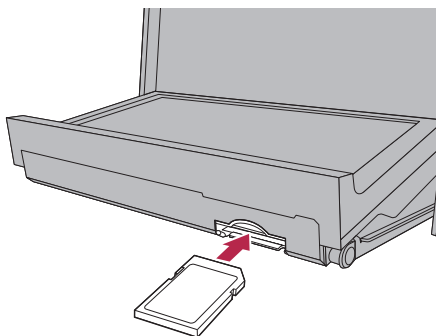

4 Press the **▲** button.

The LCD panel closes.

- If data related to map data, such as customised POI data, is stored on the SD memory card, the navigation system restarts.

Ejecting an SD memory card (for AVIC-F30BT)

1 Press the **▲** button.

The "Monitor Setup" screen appears.

2 Touch [Eject SD].



The LCD panel opens.

3 Press the middle of the SD memory card gently until it clicks.

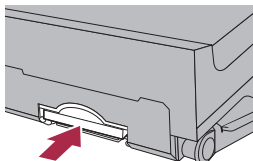

4 Pull the SD memory card out straight.

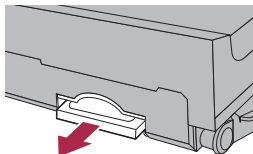

5 Press the ▲ button.

The LCD panel closes.

- When you eject the SD memory card by touching [Eject SD], the model information that you are using will be automatically stored into the SD memory card. The utility programme NavGate FEEDS will use this information to recognise the model that you use.

When the data related to map data is stored

- This description is for AVIC-F30BT. If data related to map data, such as customised POI data, is stored on the SD memory

card, operating procedures are slightly different.

1 Press the ▲ button and then touch [Eject SD].

2 Touch [Yes].



The navigation system restarts, and then the LCD panel opens.

3 Eject the SD memory card.

4 Press the ▲ button.

The LCD panel closes.

Inserting an SD memory card (for AVIC-F930BT and AVIC-F9310BT)

● Insert an SD memory card into the SD card slot.

Insert the SD memory card with the terminal contacts facing down, and press the card until it clicks and locks completely.

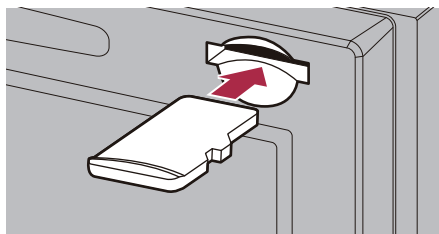

- If data related to map data, such as customised POI data, is stored on the SD memory card, the navigation system restarts.

Basic operation

Ejecting an SD memory card (for AVIC-F930BT and AVIC-F9310BT)

1 Press the **▲** button.

The touch panel keys for ejecting the media appear.

2 Touch [Eject SD].

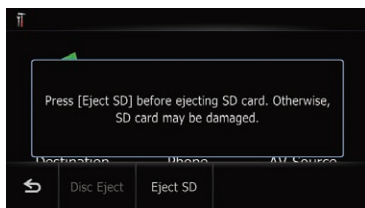

A message prompting you to remove the SD memory card appears.

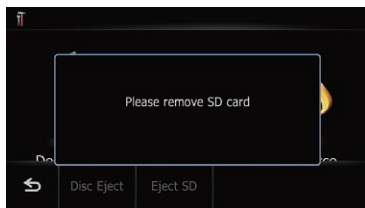

3 Press the middle of the SD memory card gently until it clicks.



4 Pull the SD memory card out straight.

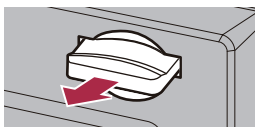

When the data related to map data is stored

- This description is for AVIC-F930BT and AVIC-F9310BT.

If data related to map data, such as customised POI data, is stored on the SD memory card, operating procedures are slightly different.

1 Press the **▲** button and then touch [Eject SD].

2 Touch [Yes].

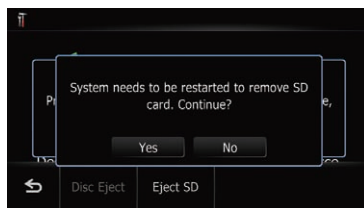

The navigation system restarts, and a message prompting you to remove the SD memory card appears.

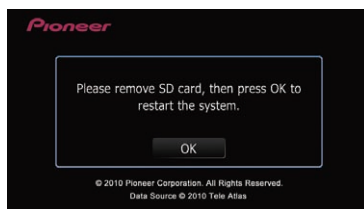

3 Eject the SD memory card while the message is displayed.

Eject the SD memory card before touching [OK].

4 Touch [OK].

The navigation system restarts. ▣

Plugging and unplugging a USB storage device

⚠ CAUTION

- To prevent data loss and damage to the storage device, never remove it from this navigation system while data is being transferred.

Basic operation

- If data loss or corruption occurs on the storage device for any reason, it is usually not possible to recover the data. Pioneer accepts no liability for damages, costs or expenses arising from data loss or corruption.
- ❑ Compatibility with all USB storage devices is not guaranteed.
This navigation system may not achieve optimum performance with some USB storage devices.
- ❑ Connection via a USB hub is not possible.

Plugging in a USB storage device

- **Plug a USB storage device into the USB and mini-jack connector.**

USB and mini-jack connector

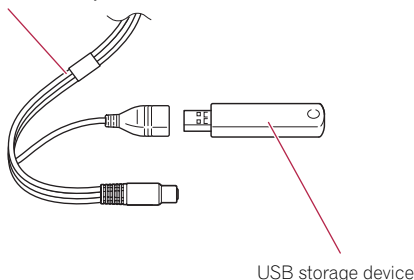

Unplugging a USB storage device

- **Pull out the USB storage device after checking that no data is being accessed.** ❑

Connecting and disconnecting an iPod

⚠ CAUTION

- To prevent data loss and damage to the storage device, never remove it from this navigation system while data is being transferred.
- If data loss or corruption occurs on the storage device for any reason, it is usually not possible to recover the data. Pioneer accepts

no liability for damages, costs or expenses arising from data loss or corruption.

Connecting your iPod

Using the USB interface cable for iPod enables you to connect your iPod to the navigation system.

- ❑ A USB interface cable for iPod (CD-IU51V) (sold separately) is required for connection.
- ❑ For details about iPod compatibility with this navigation system, refer to the information on our website.
- ❑ Connection via a USB hub is not possible.

- 1 Check that no USB storage device is connected.**

- 2 Connect your iPod.**

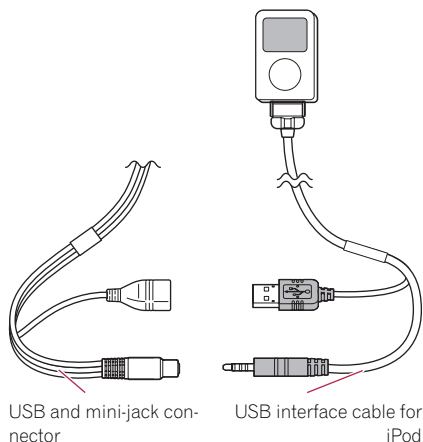

Disconnecting your iPod

- **Pull out the USB interface cable for iPod after checking that no data is being accessed.** ❑

Basic operation

Startup and termination

1 Start the engine to boot up the system.

After a short pause, the splash screen comes on for a few seconds.

- To protect the LCD screen from damage, be sure to touch the touch panel keys with your finger only and gently touch the screen.

2 Turn off the vehicle engine to terminate the system.

The navigation system is also turned off.

On first-time startup

When you use the navigation system for the first time, select the language that you want to use.

1 Start the engine to boot up the system.

After a short pause, the splash screen comes on for a few seconds.

2 Touch the language that you want to use on the screen.



3 Touch the language that you want to use for the voice guidance.



The navigation system will now restart.

4 Read the disclaimer carefully, checking its details, and then touch [OK] if you agree to the conditions.

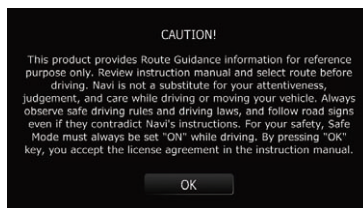

The map screen appears.

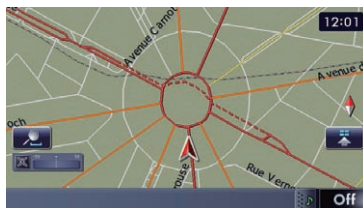

Regular startup

● Start the engine to boot up the system.

After a short pause, the splash screen comes on for a few seconds.

- The screen shown will differ depending on the previous conditions.
- When there is no route, the disclaimer appears after the navigation system reboots. Read the disclaimer carefully, checking its details, and then touch [OK] if you agree to the conditions.
- If the anti-theft function is activated, you must enter your password. Read the disclaimer carefully, checking its details, and then touch [OK] if you agree to the conditions.

Screen switching overview

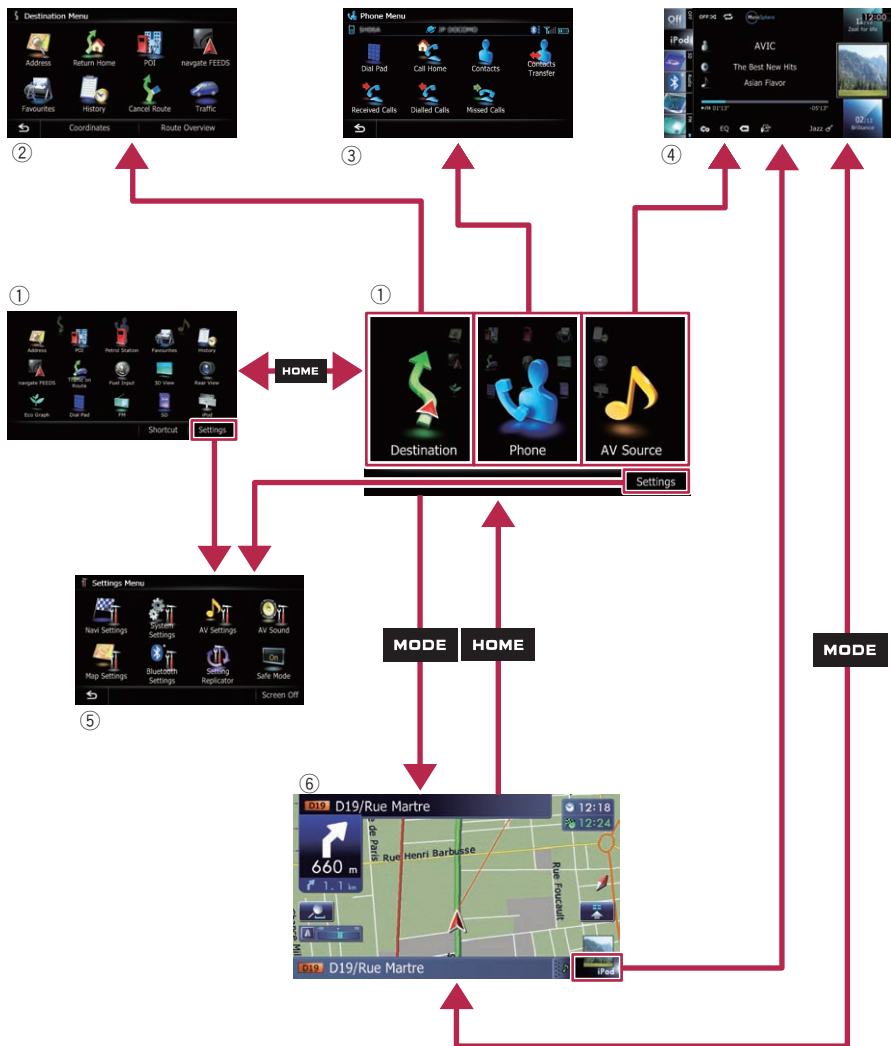

How to use the navigation menu screens

What you can do on each menu

① Top Menu

Press the **HOME** button to display the "**Top Menu**" screen.

This is the starting menu to access the desired screens and operate the various functions.

There are two types of the "**Top Menu**" screen.

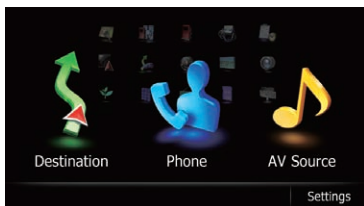

Classic Menu



Shortcut Menu

□ In this manual, Classic Menu will be referred to as "**Top Menu**".

② Destination Menu

You can search for your destination on this menu. You can also check or cancel your set route from this menu.

③ Phone Menu

You can access the screen that is related to hands-free phoning.

④ AV operation screen

This is the screen that normally appears when you play the AV source.

⑤ Settings Menu

You can access the screen to customise settings.

⑥ Map screen

You can use this screen to check the current vehicle position information and route to the destination. □

Shortcut Menu

Registering your favourite menu items in shortcuts allows you to quickly jump to the registered menu screen by a simple touch on the Shortcut Menu screen.

Selecting the shortcut

□ Up to 15 menu items can be registered in shortcuts.

1 Press the HOME button repeatedly to display the Shortcut Menu screen.

□ When you use the navigation system for the first time or no items are set on shortcut, a message will appear. Touch **[Yes]** to proceed to next step.

2 Touch **[Shortcut]**.

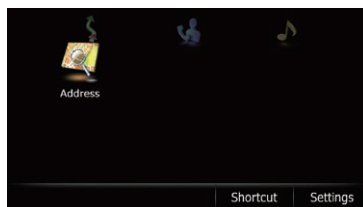

The Shortcut selection screen appears.

3 Touch the tab on the right edge or scroll the bar to display the icon that you want to set to shortcut.



Scroll bar

4 Touch and hold the icon that you want to add to shortcut.

How to use the navigation menu screens

5 Move the icon to the left side of the screen, and then release it.

The selected item is added to shortcut.

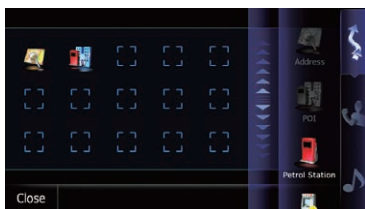

Removing a shortcut

1 Touch and hold the icon of the shortcut you want to remove.

2 Move the icon to the right side of the screen, and then release it.

Operating list screens (e.g. POI list)

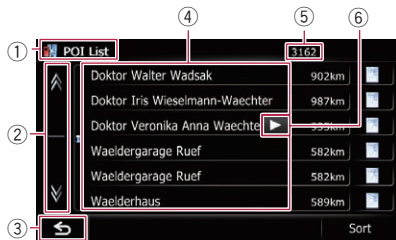

① **Screen title**

②

Touching or on the scroll bar scrolls through the list and allows you to view the remaining items.

③

The previous screen returns.

④ **Listed items**

Touching an item on the list allows you to narrow down the options and proceed to the next operation.

⑤ **Number of possible choices**

If there are 10 000 or more possible choices, "****" is displayed.

⑥

If all of the characters cannot be displayed within the displayed area, touching the key to the right of the item allows you to see remaining characters.

Operating the on-screen keyboard



① **Screen title**

The screen title appears.

② **Text box**

Displays the characters that are entered. If there is no text in the box, an informative guide with text appears.

③ **Keyboard**

Touch the keys to enter the characters.

④

The previous screen returns.

⑤ **Keys**

Switches the on-screen keyboard layout.

⑥ **Sym., Others, 0-9**

You can enter other characters of alphabet.

You can also enter text with marks such as [&] or [+] or numbers.

Touch to toggle the selection.

Even if you use any of "A", "Ä", "Å", "Æ", the displayed result is the same.

⑦ **OK**

Confirms the entry and allows you to proceed to the next step.

⑧

Deletes the input text one letter at a time, beginning at the end of the text. Continuing to touch the button deletes all of the text.

How to use the map

Most of the information provided by your navigation system can be seen on the map. You need to become familiar with how information appears on the map.

How to read the map screen

This example shows an example of a 2D map screen.

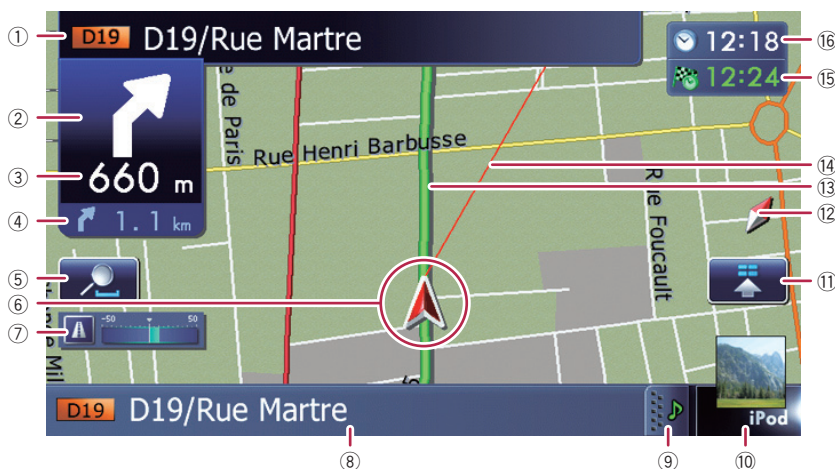

- Information with an asterisk (*) appears only when the route is set.
 - Depending on the conditions and settings, some items may not be displayed.
- ① **Name of the street to be used (or next guidance point)***
 - ② **Next direction of travel***
As you get closer to the guidance point, the colour of the item changes to green.
 - Touching this item enables you to hear the next guidance again.
 - You can select between display and non-display.
 - ➔ For details, refer to *Displaying manoeuvres* on page 135.
 - ③ **Distance to the guidance point***
Shows the distance to the next guidance point.
 - Touching this item enables you to hear the next guidance again.
 - ④ **Second Manoeuvre Arrow***

Shows the turning direction after next guidance point and the distance to there.

- ➔ For details, refer to *Displaying manoeuvres* on page 135.

- ⑤ **Map control**
Touching  displays touch panel keys for changing the map scale and the map orientation.
- ⑥ **Current position**
Indicates the current location of your vehicle. The apex of the triangular mark indicates your orientation and the display moves automatically as you drive.
 - The apex of the triangular mark is the proper current position of the vehicle.
- ⑦ **Eco-Meter**
Displays a graph comparing the past average fuel mileage and the average fuel mileage since the navigation system was last started.
 - ➔ For details, refer to *Displaying the fuel consumption information* on page 135.

How to use the map

⑧ **Street name (or city name) that your vehicle is travelling along**

➡ For details, refer to *Setting the current street name display* on page 134.

⑨ **Extension tab for the AV information bar**

Touching this tab opens the AV information bar and enables you to briefly view the current status on the AV source. Touching it again retracts the bar.

⑩ **Shortcut to the AV operation screen**

The AV source currently selected is shown. Touching the indicator displays the AV operation screen of the current source directly.

☐ If you connect your iPod to this navigation system, the artwork for the album that is playing appears.

⑪ **Quick Access icon**

Displays the "Quick Access" menu.

➡ For details, refer to *Using shortcut menus on the map* on page 29.

⑫ **Map orientation indicator**

- When "North up" is selected,  is displayed.

- When "Heading up" is selected,  is displayed.

☐ The red arrow indicates north.

➡ For details, refer to *Switching the map orientation* on page 28.

⑬ **Current route***

The route currently set is highlighted in colour on the map. If a waypoint is set on the route, the route after the next waypoint is highlighted in another colour.

⑭ **Direction line***

The direction towards your destination (next waypoint, or the position of a cursor) is indicated with a straight line.

⑮ **Multi-Info window**

Each touch of Multi-Info window changes the display information as follows.

- **Distance to the destination (or distance to waypoint)***
- **Estimated time of arrival at your destination or waypoint***

The estimated time of arrival is an ideal value calculated based on the value set for "Average Speed" and the actual

driving speed. The estimated time of arrival is only a reference value, and does not guarantee arrival at that time.

- **Travel time to your destination or waypoint***

⑯ **Current time**

Meaning of guidance flags



Destination

The checkered flag indicates your destination.



Waypoint

The blue flags indicate your waypoints.



Guidance point

The next guidance point (next turning point, etc.) is shown by a yellow flag.

Enlarged map of the intersection

When "Close Up View" in the "Map Settings" screen is "On", an enlarged map of the intersection appears.



➡ For details, refer to *Setting the auto-zoom display* on page 132.

How to use the map

Display during motorway driving

In certain locations of the motorway, lane information is available. The map indicates the recommended lane to be in to easily manoeuvre the next guidance.



While driving on the motorway, motorway exit numbers and motorway signs may be displayed in the vicinity of interchanges and exits.

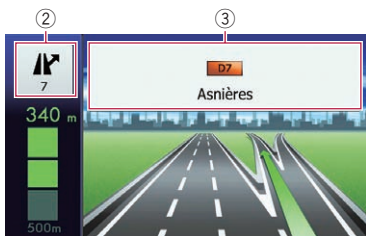

- ① **Lane information**
 - ② **Motorway exit information**
Displays the motorway exit.
 - ③ **Motorway signs**
These show the road number and give directional information.
- If the data for these items is not contained in the built-in memory, the information is not available even if there are the signs on the actual road.

Types of the road stored in the map database

Roads included in the route guidance

Turn by Turn Routable Roads contain full attribute data and can be used for full Route Gui-

dance. Pioneer Navigation will display full route guidance, including turn-by-turn voice directions and arrow icons.

Roads without turn-by-turn instructions

Routable roads (the route displayed and highlighted in violet) have only basic data and can only be used to plot a navigable route. Pioneer Navigation will only display a navigable route on the map (only the arrival guidance for the destination or a waypoint is available). Please review and obey all local traffic rules along the highlighted route for your safety. No turn-by-turn directions will be displayed on these roads.

Non routable roads (pink colour road)

Map display is possible, but it cannot be used for route calculation. Please review and obey all local traffic rules along this route. (For your safety.)

Operating the map screen

Changing the scale of the map

You can change the map scale between 25 metres and 2 000 kilometres (25 yards and 1 000 miles).

1 Display the map screen.

2 Touch on the map screen.

 and  with the map scale appear.



How to use the map

3 Touch or to change the map scale.

- If you do not operate the function for a few seconds, the touch panel keys for map display control disappear.
- If you touch the direct scale key, the map is changed to the selected scale directly.



Switching the map orientation

You can switch how the map shows your vehicle's direction between "Heading up" and "North up".

- Heading up:
The map display always shows the vehicle's direction as proceeding toward the top of the screen.
- North up:
The map display always has north at the top of the screen.
- The map orientation is fixed at "North up" when the map scale is 50 kilometres (25 miles) or more.
- The map orientation is fixed at "Heading up" when the 3D map screen is displayed.

1 Display the map screen.

2 Touch on the map screen.

 or  appears.



3 Touch or to switch the vehicle's direction.

Each time you touch the key changes the setting.

- If you do not operate the function for a few seconds, the touch panel keys for map display control disappear.

Scrolling the map to the position you want to see

1 Display the map screen.

2 Touch and drag the map in the desired direction to scroll.



① Cursor

② Distance from the current position

Positioning the cursor to the desired location results displaying in a brief informational overview about the location at the bottom of screen, with the street name and other information for this location. (The information shown varies depending on the position.)

- The scrolling increment depends on your dragging length.
- If you touch , the map returns to the current position.
- Pressing **MODE** button returns the map to the current position.

Viewing information about a specified location

An icon appears at registered places (home location, specific places, **Favourites** entries) and places where there is a POI icon or traffic information icon. Place the scroll cursor over the icon to view detailed information.

1 Scroll the map and move the scroll cursor to the icon you want to view.

How to use the map

2 Touch .

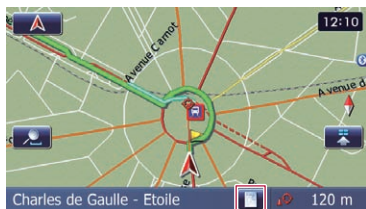

The “**Information List**” screen appears.

3 Touch the item that you want to check the detailed information.

Information for a specified location appears.



The information shown varies according to the location. (There may be no information for that location.)

- For details, refer to *Setting the display of icons of favourite locations* on page 134.
- For details, refer to *Displaying POI on the map* on page 136.
- For details, refer to *How to read traffic information on the map* on page 52.
- ☐ Touching [Call] enables you to call the position if a telephone number is available. (Pairing with mobile phone featuring Bluetooth wireless technology is required.)
 - For details, refer to *Dialling from the map* on page 63.

Using shortcut menus on the map

“**Quick Access**” menu allows you to perform various tasks, such as route calculation for the location indicated by the cursor or registering a location in “**Favourites**”, faster than using the navigation menu.

You can customise “**Quick Access**” displayed on screen. The “**Quick Access**” described here are prepared as the default setting.

- For details, refer to *Selecting the “Quick Access” menu* on page 138.
- ☐ Items marked with an asterisk (*) cannot be removed from the “**Quick Access**” menu.

● When the map is displayed, touch .



Quick Access menu

: **Route Options***

Displayed when the map is not scrolled. This item can be selected only during route guidance.

You can modify the conditions for route calculation and recalculate the current route.

- For details, refer to *Modifying the route calculation conditions* on page 43.

: **Destination***

Displayed when the map is scrolled. Set the route to the place specified with the cursor.

: **Registration**

Register information on the location indicated by the cursor to “**Favourites**”.

- For details, refer to *Registering a location by scroll mode* on page 47.

: **Vicinity Search**

Find POIs (Points Of Interest) in the vicinity of the cursor.

- For details, refer to *Searching for a nearby POI* on page 39.

: **Overlay POI**

Displays icons for surrounding facilities (POI) on the map.

- For details, refer to *Displaying POI on the map* on page 136.

: **Volume**

How to use the map

Displays the “**Volume Settings**” screen.

- ➔ For details, refer to *Setting the Volume for Guidance and Phone* on page 142.

: **Contacts**

Displays the “**Contacts List**” screen.

- ➔ For details, refer to *Calling a number in the phone book* on page 61.

Close

Hides the “**Quick Access**” menu. 

Switching the view mode

Various types of screen displays can be selected for navigation guidance.

1 Display the “Map Settings” screen.

- ➔ For details, refer to *Displaying the screen for map settings* on page 132.

2 Touch [View Mode].

The “**View Mode**” screen appears.

3 Touch the type that you want to set.

You can select the following types:

- **2D View** (default):
Displays a normal map (2D map).



- **3D View:**

Displays a map with an aerial view (3D map).



- **Street View:**

Information on the next four guidance points closest to the current location appear in order from top to bottom on the left side of the screen. The following information is displayed.



- Name of the next route to be taken by the vehicle
- Arrow indicating the direction of the vehicle
- Distance to the guidance points
- This mode is available when the route is set.

- **Rear View:**

Displays the rear view image on the left side of the screen and the map on the right side of the screen.



- This mode is available when the rear view camera setting is set to “**On**”.
- ➔ For details, refer to *Setting for rear view camera* on page 143.

- **Eco Graph:**

Displays a graph for eco-driving on the left side of the screen and the map on the right side of the screen.

How to use the map

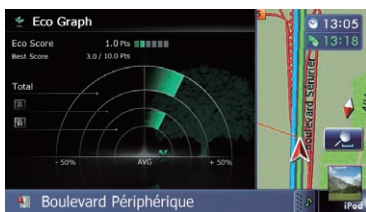

- ➞ For details, refer to *Checking the eco-friendly driving status* on the next page.

This navigation system is equipped with eco-friendly driving functions that can be used to estimate whether you are driving in an environmentally friendly way.

This chapter describes these functions.

- The fuel mileage calculated is based on a theoretical value determined from vehicle speed and position information from the navigation system. The fuel mileage displayed is only a reference value, and does not guarantee the mileage displayed can be obtained.
- The eco-friendly driving functions are an estimate of the real time fuel consumption to average fuel consumption ratio and is not an actual value.
- The eco-friendly driving functions and calculations take into consideration the location of the GPS position and speed of the vehicle in determining a value.

Checking the eco-friendly driving status

This function estimates approximate fuel mileage based on your driving, compares that with your average fuel mileage in the past, and displays the results in a graph.

The graph appears when the map display is set to **"Eco Graph"**.

1 Display the "Map Settings" screen.

- ➔ For details, refer to *Displaying the screen for map settings* on page 132.

2 Touch [View Mode].

The **"View Mode"** screen appears.

3 Touch [Eco Graph].

The **"Eco Graph"** screen appears.

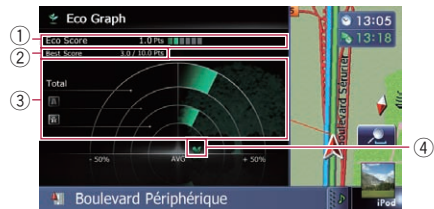

① Eco Score

The result of the comparison of your past average fuel mileage and current average fuel mileage appears as a value from **0.0 Pts** (points) to **10.0 Pts**. The higher the value, the better the fuel mileage when compared to past route guidance.

The green gauge indicates the current score, and the grey gauge indicates the best score to date.

The **"Eco Score"** is updated every 5 minutes.

- This is not displayed when **"Eco Score"** is set to **"Off"** or when no route is set.

② Best Score

Displays the best score to date.

- This is not displayed when **"Eco Score"** is set to **"Off"** or when no route is set.

③ Average fuel mileage comparison graph

Displays a comparison of the average fuel mileage up to the point the navigation system was last stopped (past average fuel mileage) and the current average fuel mileage. The display is updated every 3 seconds. The more the value moves in the direction of **+**, the better the fuel mileage. There are three different graph bars.

• Total

A comparison of the past average fuel mileage and the average fuel mileage of the current drive.

• : Ordinary Road

A comparison of the past average fuel mileage and the average fuel mileage for 90 seconds in the past, while the vehicle is driving on an ordinary road.

• : Motorway

Eco-friendly driving functions

A comparison of the past average fuel mileage and the average fuel mileage for 90 seconds in the past, while the vehicle is driving on a motorway.

④ Animal icons

The number of displayed animal icons increases or decreases according to the value of "Eco Score".

- This is not displayed when "Eco Score" is set to "Off" or when no route is set.
- Even if you use the "Eco Graph" function immediately after you start using the navigation system for the first time, ☒ may be displayed and the function may not be available.
- ➔ For details, refer to *Troubleshooting* on page 171.
- The display settings can be changed.
- ➔ For details, refer to *Changing the eco-function setting* on page 131.

Displaying Eco Drive Level guidance

This navigation system is equipped with the "Eco Drive Level" function that estimates how well you have driven in an environmentally friendly way.

The points of "Eco Drive Level" change according to "Eco Score" when the vehicle reaches the destination. When a certain number of points is reached, the level increases and a message appears.

Tree icon

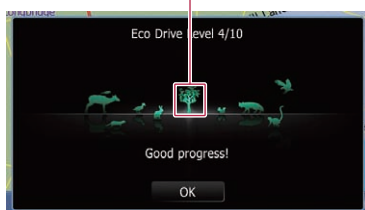

As the level increases, a tree icon changes from a young tree to a big tree.

- This is not displayed when "Eco Drive Level" is set to "Off".
- ➔ For details of the operation, refer to *Changing the eco-function setting* on page 131.

Sudden start alert

If the speed of the vehicle exceeds 41 km/h (25.5 mph) within 5 seconds from the time it is started, a message appears and a warning sound beeps.

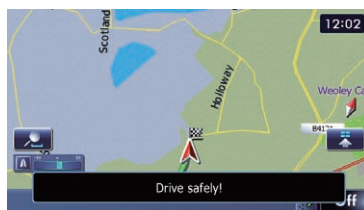

- ➔ For details of the operation, refer to *Changing the eco-function setting* on page 131.

CAUTION

For safety reasons, these route-setting functions are not available while your vehicle is in motion. To enable these functions, you must stop in a safe place and put on the handbrake before setting your route.

- Some information regarding traffic regulations depends on the time when the route calculation is performed. Thus, the information may not correspond with a certain traffic regulation when your vehicle actually passes through the location in question. Also, the information on the traffic regulations provided will be for a passenger vehicle, and not for a truck or other delivery vehicles. Always follow the actual traffic regulations when driving.

The basic flow of creating your route

- 1 Park your vehicle in a safe place and apply the handbrake.

↓
- 2 Display the **"Destination Menu"** screen.
 - For details of the operations, refer to *Screen switching overview* on page 22.

↓
- 3 Select the method of searching for your destination.

↓
- 4 Enter the information about your destination to calculate route.

↓
- 5 Confirm the location on the map.
 - For details, refer to *Setting a route to your destination* on page 42.

↓
- 6 The navigation system calculates the route to your destination, and then shows the route on the map.

↓
- 7 Check and decide the route.
 - For details, refer to *Setting a route to your destination* on page 42.

↓
- 8 Your navigation system sets the route to your destination, and the map of your surroundings appears.

↓
- 9 Release the handbrake, drive in accordance with navigation guidance.



Searching for and selecting a location

Searching for a location by address

The most frequently used function is “**Address**”, in which the address is specified and the destination is searched.

You can select the method of searching for a location by address.

- Searching for a street name first
- Searching for a city name first
- Finding the location by specifying the post-code

Searching for a street name first

- ❑ Depending on the search results, some steps may be skipped.
- ❑ When you enter characters, the system will automatically search the database for all possible options. Only the characters you enter are active.
- ❑ If the search candidates number reaches 20 or less, the screen automatically changes to the search result screen.

1 Display the “Destination Menu” screen.

- ➡ For details of the operations, refer to *Screen switching overview* on page 22.

2 Touch [Address].

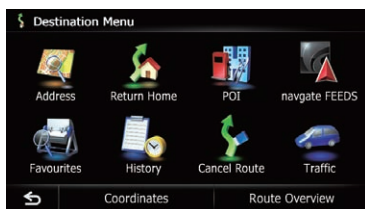

3 Touch the key next to “Zone” to display the country list.

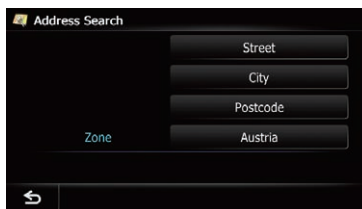

4 Touch one of the items on the list to set the country as search area.



The screen returns to the previous screen.

5 Touch [Street].

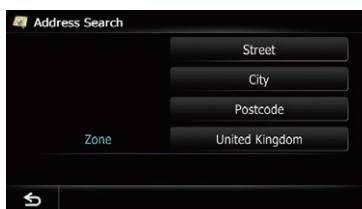

6 Enter the street name and then touch [OK].



The “**Street Selection**” screen appears.

7 Touch the street you want.

- 8 Enter the city name and then touch [OK].



The “Select City” screen appears.

- 9 Touch the desired city name.

- If you touch , the geographic centre of the city appears on the map screen.

- 10 Enter the house number and then touch [OK].



The “House Number Selection” screen appears.

- 11 Touch the desired house number range.

The searched location appears on the map screen.

- ➔ For the subsequent operations, refer to *Setting a route to your destination* on page 42.

Searching for a city name first

- ❑ Depending on the search results, some steps may be skipped.
- ❑ When you enter characters, the system will automatically search the database for all possible options. Only the characters you enter are active.
- ❑ If the search candidates number reaches 20 or less, the screen automatically changes to the search result screen.

- 1 Display the “Destination Menu” screen.

- ➔ For details of the operations, refer to *Screen switching overview* on page 22.

- 2 Touch [Address].

The “Address Search” screen appears.

- 3 Touch [City].

- 4 Enter the city name and then touch [OK].



The “Select City” screen appears.

- 5 Touch the desired city name.

- If you touch , the geographic centre of the city appears on the map screen.

- 6 Enter the street name and then touch [OK].



The “Street Selection” screen appears.

- 7 Touch the street you want.

Searching for and selecting a location

8 Enter the house number and then touch [OK].



The “**House Number Selection**” screen appears.

9 Touch the desired house number range.

The searched location appears on the map screen.

- ➔ For the subsequent operations, refer to *Setting a route to your destination* on page 42.

Finding your destination by specifying the postcode

If you know the postcode of your destination, you can use it to find your destination.

- Depending on the search results, some steps may be skipped.

1 Display the “Destination Menu” screen.

- ➔ For details of the operations, refer to *Screen switching overview* on page 22.

2 Touch [Address].

The “**Address Search**” screen appears.

3 Touch the key next to “Zone” to display the country list.

4 Touch one of the items on the list to set the country as search area.

The screen returns to the previous screen.

5 Touch [Postcode].

The “**Enter Postcode**” screen appears.

6 Input the postcode.

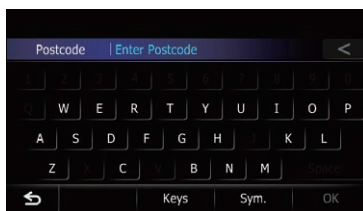

A list of cities with the specified postcode is shown (except for the following cases).

British postcode:

The searched location appears on the map screen.

Netherlands postcode:

If you input a partial postcode (4 digits) or a complete postcode (6 digits), and touch [OK], a list of cities is shown.

Proceed to Step 7.

7 Touch the city or area where your destination is located.

- If you touch , the geographic centre of the city appears on the map screen.

8 Enter the street name and then touch [OK].

The “**Street Selection**” screen appears.

- If there is no house number, the searched location appears on the map screen.

9 Touch the street you want.

The “**Enter House Number**” screen appears.

- If the selected street has only one matching location, the searched location appears on the map screen.

10 Enter the house number and then touch [OK].

The “**House Number Selection**” screen appears.

11 Touch the desired house number range.

The searched location appears on the map screen.

- ➔ For the subsequent operations, refer to *Setting a route to your destination* on page 42. 

Setting up a route to your home

If your home location is stored, the route to your home can be calculated by touching a single key.

1 Display the “Destination Menu” screen.

- ➔ For details of the operations, refer to *Screen switching overview* on page 22.

2 Touch [Return Home].

- ☐ If you have not registered your home location, a message appears. Touch [Register] to start registration.
 - ➔ For details, refer to *Registering your home* on page 130. 

Searching for Points of Interest (POI)

Information about various facilities (Points Of Interest – POI), such as petrol stations, car parks or restaurants, is available. You can search for a POI by selecting the category (or entering the POI Name).

Searching for POIs by preset categories

You can search for POIs with a single touch from the preset category.

1 Display the “Destination Menu” screen.

- ➔ For details of the operations, refer to *Screen switching overview* on page 22.

2 Touch [POI].

3 Touch the desired category.

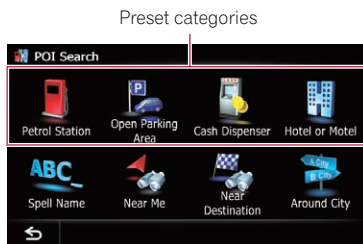

The “POI List” screen appears.

4 Touch the POI you want.

The searched location appears on the map screen.

- ➔ For the subsequent operations, refer to *Setting a route to your destination* on page 42.

Searching for a POI directly from the name of the facilities

- ☐ If the search candidates number reaches 20 or less, the screen automatically changes to the search result screen.

1 Display the “Destination Menu” screen.

- ➔ For details of the operations, refer to *Screen switching overview* on page 22.

2 Touch [POI].

The “POI Search” screen appears.

3 Touch [Spell Name].

4 Enter the POI name and then touch [OK].

The “POI List” screen appears.

- If you change the country to search, touch the country key and display the “Zone Selection” screen to change the setting.

Searching for and selecting a location

Country key

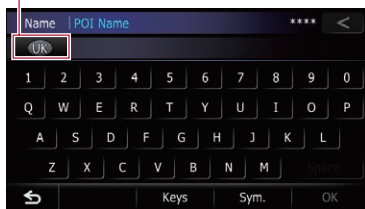

- ❑ Once the country has been selected, you only have to change countries when your destination is outside of the country you selected.

5 Touch the POI you want.

The searched location appears on the map screen.

- If you touch [**Sort**], the order of POI can be sorted.
 - ❑ Current order is indicated on the upper right of the screen.
 - : Sorts the items in the list alphabetically.
 - : Sorts the items in the list in order by distance from the vehicle position.
 - ➔ For the subsequent operations, refer to *Setting a route to your destination* on page 42.

Searching for a nearby POI

You can search for POIs in your surroundings.

1 Display the “Destination Menu” screen.

- ➔ For details of the operations, refer to *Screen switching overview* on page 22.

2 Touch [POI].

The “POI Search” screen appears.

3 Touch [Near Me].

POIs are divided into several categories.

4 Touch the category you want.

The “POI List” screen appears.

- ❑ If there are more detailed categories within the selected category, repeat this step as many times as necessary.

5 Touch the POI you want.

The searched location appears on the map screen.

- ➔ For the subsequent operations, refer to *Setting a route to your destination* on page 42.

Searching for POIs around the destination

- ❑ This function is available when the route is set.

1 Display the “Destination Menu” screen.

- ➔ For details of the operations, refer to *Screen switching overview* on page 22.

2 Touch [POI].

The “POI Search” screen appears.

3 Touch [Near Destination].

POIs are divided into several categories.

4 Touch the category you want.

The “POI List” screen appears.

- ❑ If there are more detailed categories within the selected category, repeat this step as many times as necessary.

5 Touch the POI you want.

The searched location appears on the map screen.

- ➔ For the subsequent operations, refer to *Setting a route to your destination* on page 42.

Searching for POIs around the city

You can search for POIs around a specified city.

- ❑ If the search candidates number reaches 20 or less, the screen automatically changes to the search result screen.

1 Display the “Destination Menu” screen.

- ➔ For details of the operations, refer to *Screen switching overview* on page 22.

2 Touch [POI].

The “POI Search” screen appears.

3 Touch [Around City].

Searching for and selecting a location

4 Enter the city name and then touch [OK].

The “Select City” screen appears.

- If you change the country to search, touch the country key and display the “Zone Selection” screen to change the setting.

Country key

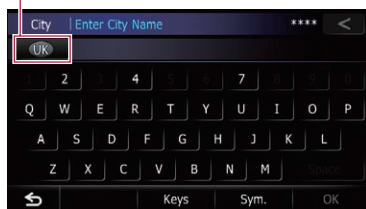

- Once the country has been selected, you only have to change countries when your destination is outside of the country you selected.

5 Touch the desired city name.

The “POI List” screen appears.

- If you touch , the geographic centre of the city appears on the map screen.

6 Touch the category you want.

POIs are divided into several categories.

7 Touch the POI you want.

The searched location appears on the map screen.

- ➔ For the subsequent operations, refer to *Setting a route to your destination* on page 42. 

Selecting destination from “Favourites”

Storing locations you visit frequently saves time and effort.

Selecting an item from the list provides an easy way to specify the position.

- This function is not available if no locations have been registered in “Favourites”.
- ➔ For details, refer to *Storing favourite locations* on page 47.

1 Display the “Destination Menu” screen.

- ➔ For details of the operations, refer to *Screen switching overview* on page 22.

2 Touch [Favourites].

3 Touch the entry you want.



The searched location appears on the map screen.

- ➔ For the subsequent operations, refer to *Setting a route to your destination* on page 42. 

Searching for POIs by using the data on the SD memory card

Creating a customised POI is possible by using the utility programme NavGate FEEDS which is available separately, on your PC. (NavGate FEEDS will be available on our website.) Storing the customised POI properly and inserting the SD memory card enables the system to use the data for searches.

1 Store the item into the SD memory card by using the NavGate FEEDS.

2 Insert an SD memory card into the SD card slot.

- ➔ For details of the operation, refer to *Inserting and ejecting an SD memory card* on page 17.

3 Display the “Destination Menu” screen.

- ➔ For details of the operations, refer to *Screen switching overview* on page 22.

4 Touch [navgate FEEDS].

The “Select POI” screen appears.

Searching for and selecting a location

5 Touch the item you want.

6 Touch the POI you want.

The searched location appears on the map screen.

- ➔ For the subsequent operations, refer to *Setting a route to your destination* on the next page. 

Selecting a location you searched for recently

The places that you have set as destination or waypoint in the past are automatically stored in “History”.

- If no location is stored in Destination History, you cannot select [History]. (If you perform a route calculation, you can select [History].)
- “History” can store up to 100 locations. If the entries reach the maximum, the new entry overwrites the oldest one.

1 Display the “Destination Menu” screen.

- ➔ For details of the operations, refer to *Screen switching overview* on page 22.

2 Touch [History].

3 Touch the entry you want.



The searched location appears on the map screen.

- ➔ For the subsequent operations, refer to *Setting a route to your destination* on the next page. 

Searching for a location by coordinates

Entering a latitude and longitude pinpoints the location.

1 Display the “Destination Menu” screen.

- ➔ For details of the operations, refer to *Screen switching overview* on page 22.

2 Touch [Coordinates].

3 Touch [East] or [West], and then enter the longitude.

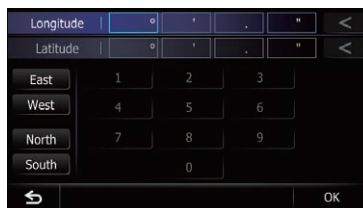

To enter W 50°1'2.5" for example, touch [West], [0], [5], [0], [0], [1], [0], [2], and [5].

4 Touch [North] or [South], and then enter the latitude.

To enter N 5°1'2.5" for example, touch [North], [0], [5], [0], [1], [0], [2], and [5].

5 Touch [OK].

The searched location appears on the map screen.

- ➔ For the subsequent operations, refer to *Setting a route to your destination* on the next page. 

Setting a route to your destination

1 Search for a location.

- ➔ For details, refer to Chapter 6.

After searching for the destination, the Location confirmation screen appears.

2 Touch [OK].

Location confirmation screen

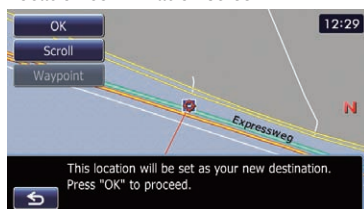

The destination is set, and then route calculation starts.

When the route calculation is completed, Route confirmation screen appears.

- If you press the **MODE** button during route calculation, the calculation is cancelled and the map screen appears.
- If you touch **[Scroll]**, the map display is changed to the scroll mode. In the scroll mode, you can display the location more precisely to register it, or make settings.
- If you touch **[Waypoint]**, the location is added to the "Waypoints List" screen.
 - ☐ If a destination is not set, **[Waypoint]** is not available.

3 Touch [OK].

Route confirmation screen

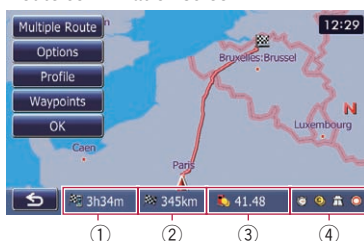

Sets the displayed route as your route, and starts the route guidance.

- ① Travel time to your destination

- ② Distance to the destination
- ③ Estimated fuel cost to your destination
 - ➔ For details, refer to *Inputting the fuel consumption information for calculating the fuel cost* on page 128.
- ④ Route calculation condition
 - If you touch **[S]**, the message confirming whether to cancel the calculated route appears. If you touch **[Yes]**, the calculated route is cancelled and the map screen appears.



① Multiple Route

- ➔ For details, refer to *Displaying multiple routes* on this page.

② Options

- ➔ For details, refer to *Modifying the route calculation conditions* on the next page.

③ Profile

- ➔ For details, refer to *Checking the current itinerary* on page 44.

④ Waypoints

- ➔ For details, refer to *Editing waypoints* on page 45.

Displaying multiple routes

You can select a desired route from multiple route options. Calculated routes are shown in different colours.

- ☐ If you set waypoints, you cannot display multiple routes.

1 Touch [Multiple Route] on the Route confirmation screen.

Multiple route options appear.

2 Touch **[1]** to **[6]**.

Another route is displayed.

3 Touch [OK].

Route confirmation screen appears. ☐

Checking and modifying the current route

Displaying the route overview

1 Press the HOME button to display the “Top Menu” screen.

2 Touch [Destination].

The “Destination Menu” screen appears.

3 Touch [Route Overview].

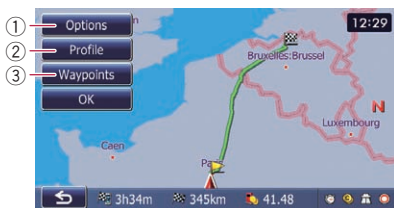
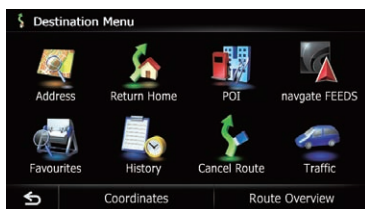

① Options

➔ For details, refer to *Modifying the route calculation conditions* on this page.

② Profile

➔ For details, refer to *Checking the current itinerary* on the next page.

③ Waypoints

➔ For details, refer to *Editing waypoints* on page 45.

“Route Overview” is active only when the route is set.

4 Touch [OK].

Modifying the route calculation conditions

You can modify the conditions for route calculation and recalculate the current route.

1 Display the “Route Overview” screen.

➔ For details, refer to *Displaying the route overview* on this page.

2 Touch [Options].

3 Touch the desired items to change the route calculation conditions and then touch [OK].



The route is recalculated, and the Route confirmation screen appears.

Items that users can operate

Settings marked with an asterisk (*) show that these are default or factory settings.

Route Condition

This setting controls how the route should be calculated by taking into account the time, distance or main road.

Determines which condition takes priority for route calculation.

Fast*:

Calculates a route with the shortest travel time to your destination as a priority.

Short:

Calculates a route with the shortest distance to your destination as a priority.

Main Road:

Calculates a route that passes major arterial roads as a priority.

Avoid Toll Road

This setting controls whether toll roads (including toll areas) should be taken into account.

Off*:

Calculates a route that may include toll roads (including toll areas).

 **On:**

Calculates a route that avoids toll roads (including toll areas).

- The system may calculate a route that includes toll roads even if “On” is selected.

Avoid Ferry

This setting controls whether ferry crossings should be taken into account.

 **Off*:**

Calculates a route that may include ferries.

 **On:**

Calculates a route that avoids ferries.

- The system may calculate a route that includes ferries even if “On” is selected.

Avoid Motorway

This setting controls whether motorways may be included in the route calculation.

 **Off*:**

Calculates a route that may include motorways.

 **On:**

Calculates a route that avoids motorways.

- The system may calculate a route that includes motorways even if “On” is selected.

Time restrictions

This setting controls whether streets or bridges that have traffic restrictions during a certain time should be taken into account.

- If you want to set your route to avoid raised draw bridges, select “On”.

 **On*:**

Calculates a route while avoiding streets or bridges with traffic restrictions during a certain time.

 **Off:**

Calculates a route while ignoring traffic restrictions.

- The system may calculate a route that includes streets or bridges that are subject to traffic restrictions during a certain time even if “On” is selected.

CAUTION

If the time difference is not set correctly, the navigation system cannot consider traffic regulations correctly. Set the time difference correctly.

- ➔ For details, refer to *Setting the time difference* on page 141.

Learning Route

The system learns the travel history of your vehicle for each road.

This setting controls whether or not the travel history should be taken into account.

 **On*:**

Calculates a route with the travel history taken into account.

 **Off:**

Calculates a route without the travel history taken into account.

Clear:

Clears the current travel history.

Checking the current itinerary

You can check the route details.

1 Display the “Route Overview” screen.

- ➔ For details, refer to *Displaying the route overview* on the previous page.

2 Touch [Profile].

The “Route Profile” screen appears.



Checking and modifying the current route

Editing waypoints

You can edit waypoints (locations you want to visit on the way to your destination) and recalculate the route so that it passes through these locations.

Adding a waypoint

Up to 5 waypoints can be set, and waypoints and final destination can be sorted automatically or manually.

1 Display the “Route Overview” screen.

- ➔ For details, refer to *Displaying the route overview* on page 43.

2 Touch [Waypoints].

The “Waypoints List” screen appears.

3 Touch [Add].



The “Select Search Method” screen appears.

4 Search for a location.

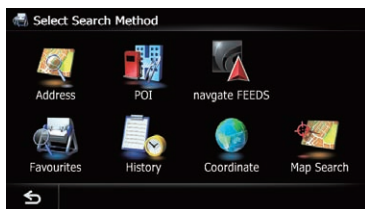

- ➔ For details, refer to Chapter 6.

5 Touch [OK].



6 Touch [OK] on the “Waypoints List” screen.



The route is recalculated, and the Route confirmation screen appears.

- ❑ If you set waypoints, you cannot display multiple routes.

Deleting a waypoint

You can delete waypoints from the route and then recalculate the route. (You can delete successive waypoints.)

1 Display the “Route Overview” screen.

- ➔ For details, refer to *Displaying the route overview* on page 43.

2 Touch [Waypoints].

The “Waypoints List” screen appears.

3 Touch [Delete] next to the waypoint that you want to delete.

The touched waypoint will be deleted from the list.

4 Touch [OK] on the “Waypoints List” screen.

The route is recalculated, and the Route confirmation screen appears.

5 Touch [OK].

The map of the current position appears.

Sorting waypoints

You can sort waypoints and recalculate the route.

- You cannot sort waypoints that you have already passed.

1 Display the “Route Overview” screen.

- ➔ For details, refer to *Displaying the route overview* on page 43.

2 Touch [Waypoints].

The “Waypoints List” screen appears.

3 Touch [Sort].

The “Sort Waypoints” screen appears.

4 Touch the waypoint or destination.



Put them in the desired order.

- If you touch **[Automatic]**, the destination and waypoints are sorted in the order of a nearest waypoint from the current location in the direct aerial path.
- If you touch **[Clear]**, waypoint sort is cancelled.

5 Touch [OK].

The “Waypoints List” screen appears.

6 Touch [OK] on the “Waypoints List” screen.

The route is recalculated, and the Route confirmation screen appears.

7 Touch [OK].

The map of the current position appears.

1 Display the “Destination Menu” screen.

- ➔ For details of the operations, refer to *Screen switching overview* on page 22.

2 Touch [Cancel Route].

A message confirming the cancellation of the current route appears.

3 Touch [Yes].

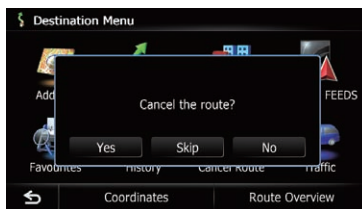

The current route is deleted, and a map of your surroundings reappears.

- If you touch **[Skip]**, the next waypoint is skipped and a new route is calculated. All other waypoints remain.

When the route calculation is completed, Route confirmation screen appears.

- [Skip]** is available only when a waypoint is set.
- If you touch **[No]**, the previous screen returns without deleting the route.

Cancelling the route guidance

If you no longer need to travel to your destination, follow the steps below to cancel the route guidance.

Registering and editing locations

Storing favourite locations

Storing your favourite locations as “Favourites” provides you with the opportunity to save the time and effort of re-entering this information. Stored items can be made available on “Favourites” later.

Registering a location by “Favourites”

“Favourites” can store up to 400 locations. Home location is counted as one of the items in “Favourites”.

1 Display the “Destination Menu” screen.

- For details of the operations, refer to *Screen switching overview* on page 22.

2 Touch [Favourites].

The “Favourites” screen appears.

3 Touch [Add].

The “Select Search Method” screen appears.

4 Search for a location.

- For details about the search methods, refer to Chapter 6.

5 When the map of the location you want to register is displayed, touch [OK].

The location is registered, and then the “Edit Favourite” screen appears.

- For details, refer to *Editing the favourite location in the list* on this page.

6 Touch [OK].

The registration is complete.

Registering a location by scroll mode

- ☐ This function is available when “Registration” is set in the “Quick Access” menu.
 - For details, refer to *Selecting the “Quick Access” menu* on page 138.

- 1 Touch and drag the screen to scroll the map to the position that you want to register.



- 2 Touch  to display the “Quick Access” menu.

3 Touch .

The location is registered, and then the “Edit Favourite” screen appears.

- For details, refer to *Editing the favourite location in the list* on this page.

4 Touch [OK].

The registration is complete. .

Editing registered locations

Editing the favourite location in the list

1 Display the “Destination Menu” screen.

- For details of the operations, refer to *Screen switching overview* on page 22.

2 Touch [Favourites].

The “Favourites” screen appears.

3 Touch next to the location that you want to edit.

The “Edit Favourite” screen appears.

4 Touch the item that you want to change the setting.

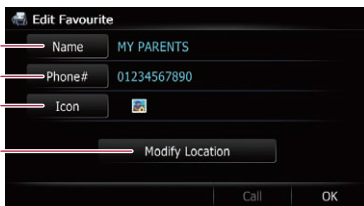

- 1 Name

You can enter the desired name.

- Up to 17 characters can be input for the name.

② Phone#

You can edit the registered phone number. To dial the number, touch **[Call]**.
The maximum digits you can enter for the phone number is 15.

③ Icon

You can change the symbol displayed on the map and **"Favourites"**.

④ Modify Location

You can change the registered location by scrolling the map.

5 Touch [OK].

The registration is complete.

Editing your home

When you have already registered your home, you can edit the information of your home.

1 Display the "Destination Menu" screen.

- ➔ For details of the operations, refer to *Screen switching overview* on page 22.

2 Touch [Favourites].

- Home location is displayed on the top of the list.

3 Touch next to the home location.



The **"Edit Favourite"** screen appears.

4 Touch the item that you want to change the setting.

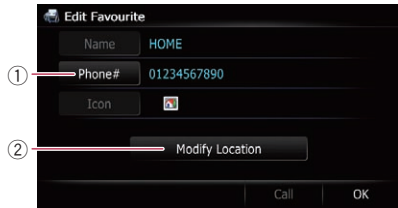

① Phone#

To dial the number, touch **[Call]**.

② Modify Location

You can change the registered location by scrolling the map.

- For home information, **[Name]** and **[Icon]** are not editable.

5 Touch [OK].

The registration is complete.

Sorting the favourite locations in the list

1 Display the "Destination Menu" screen.



- ➔ For details of the operations, refer to *Screen switching overview* on page 22.

2 Touch [Favourites].

The **"Favourites"** screen appears.

3 Touch [Sort].

Each time you touch **[Sort]** changes the sort order.

- Current order is indicated on the upper right of the screen.
 - : Sorts the items in the list in order of the recently used items.
 - : Sorts the items in the list alphabetically.
 - : Sorts the items in the list in order by distance from the vehicle position.

Registering and editing locations

Deleting a favourite location from the list

- 1 Display the “Destination Menu” screen.
 - For details of the operations, refer to *Screen switching overview* on page 22.
- 2 Touch [Favourites].
The “Favourites” screen appears.
- 3 Touch [Delete].
- 4 Select the location you want to delete.



A tick mark appears next to the selected location.

- If you touch [All], you can select all entries. If you want to deselect all entries, touch [None].

- 5 Touch [Delete].

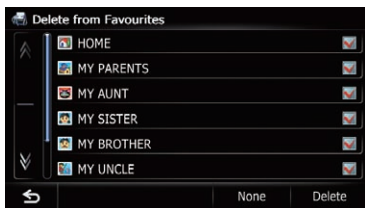

A message will appear asking you to confirm the deletion.

- 6 Touch [Yes].

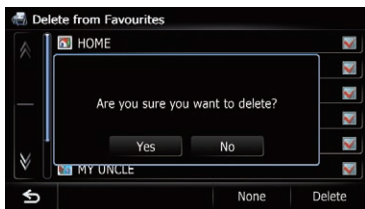

The data you selected is deleted.

- If you touch [No], the deletion is cancelled.

Exporting and importing favourite locations

Exporting favourite locations

You can export the “Favourites” data to an SD memory card for editing by using the utility programme NavGate FEEDS which is available separately, on your PC.

- If there is previous data in the SD memory card, the data is overwritten with new data.

- 1 Insert an SD memory card into the SD card slot.

- For details of the operation, refer to *Inserting and ejecting an SD memory card* on page 17.

- 2 Display the “Destination Menu” screen.

- For details of the operations, refer to *Screen switching overview* on page 22.

- 3 Touch [Favourites].

The “Favourites” screen appears.

- 4 Touch .

Data export starts.

After the data is exported, the completion message appears.



- 5 Touch [OK].

The “Favourites” screen appears.

Importing favourite locations

You can import the locations that you have edited on the utility programme NavGate FEEDS to “Favourites”.

- When a location that is already registered in “Favourites” is imported, the location is overwritten.

- 1 Store the item into the SD memory card by using the NavGate FEEDS.

2 Insert an SD memory card into the SD card slot.

- ☞ For details of the operation, refer to *Inserting and ejecting an SD memory card* on page 17.

3 Display the “Destination Menu” screen.

- ☞ For details of the operations, refer to *Screen switching overview* on page 22.

4 Touch [Favourites].

The “Favourites” screen appears.

5 Touch .

The message confirming whether to replace the stored items appears.



6 Touch [Yes].

Data import starts.

After importing the data is finished, the “Favourites” screen appears. .

Deleting the destination history from the list

Items in “History” can be deleted. All entries in “History” can be deleted at once.

1 Display the “Destination Menu” screen.

- ☞ For details of the operations, refer to *Screen switching overview* on page 22.

2 Touch [History].

The “Destination History List” screen appears.

3 Touch [Delete].

The “Delete from History” screen appears.

4 Select the location you want to delete.

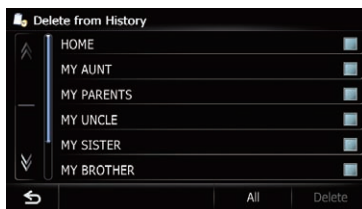

A tick mark appears next to the selected location.

- If you touch **[All]**, you can select all entries. If you want to deselect all entries, touch **[None]**.

5 Touch [Delete].



A message will appear asking you to confirm the deletion.

6 Touch [Yes].

The data you selected is deleted.

- If you touch **[No]**, the deletion is cancelled. .

Using traffic information

You can check real-time traffic information transmitted by the Traffic Message Channel (TMC) of the FM Radio Data System (RDS) on the screen. Such traffic information is updated periodically. When the navigation system receives updated traffic information, the navigation system will overlay the traffic information on your map and also display detailed text information when available. When you are travelling along a route and there is traffic information on your current route, the system will detect it and ask you if you would like to be rerouted, or suggest another route automatically.

- ❑ The system acquires the traffic information up to 150 km in radius from the vehicle position. (If there is a lot of traffic information around your vehicle, the radius will be shorter than 150 km.)
- ❑ The navigation system provides the following functions by using the information from RDS-TMC service:
 - Displaying a list of traffic information
 - Displaying traffic information on a map
 - Suggesting a route to avoid traffic jams by using traffic information
- ❑ The term “traffic jam” in this section indicates the following types of traffic information: slow, queuing and stationary traffic and closed/blocked roads. This information is always taken into consideration when checking your route, and the information related with these events cannot be turned off. If you select other traffic information in “**Traffic Settings**”, the information can be displayed in a list or on a map.
 - ➔ For details, refer to *Selecting traffic information to display* on page 54.

Checking all traffic information

Traffic information is displayed on a screen in the form of a list. This allows you to check how many traffic incidents have occurred, their location and their distance from your current position.

1 Display the “Destination Menu” screen.

- ➔ For details of the operations, refer to *Screen switching overview* on page 22.

2 Touch [Traffic].

The “**Traffic Menu**” screen appears.

3 Touch [Traffic List].

The “**Traffic List**” screen appears.

The list with received traffic information is shown.

4 Select an incident you want to view in detail.



The details of the selected incident are displayed.

- ❑ Touching an incident you want to see allows you to view the detailed information of the incident. If the information cannot be displayed on one screen, touch or to view the remaining information.
- ❑ Touching allows you to check the location on a map. (Traffic information without positional information cannot be checked on a map.)
- If you touch [**Sort**], the traffic information can be sorted.

Each time you touch the key changes the setting.

- : You can sort the traffic information by distance from your current position. When you touch [**Traffic List**], the list displayed will be sorted according to the linear distance from the vehicle position to the traffic information. When you touch [**Traffic on Route**], the list displayed will be sorted according to the distance from the vehicle position to the traffic information.
- : You can sort the traffic information in alphabetical order.
- : You can sort the traffic information according to the incident.

The list will be sorted in the order of closed/blocked roads, traffic jam, accidents, road works and others.

Current order is indicated on the upper right of the screen.

▪ If you touch **[Refresh]** while new traffic information is received, current information is changed and old information is removed. The traffic information list is updated to reflect the new situation.

5 Touch .

The previous screen returns. 

Checking traffic information on the route

All traffic information on the current route is displayed on screen in a list.

1 Display the “Destination Menu” screen.

➔ For details of the operations, refer to *Screen switching overview* on page 22.

2 Touch **[Traffic]**.

The “**Traffic Menu**” screen appears.

3 Touch **[Traffic on Route]**.



The “**Traffic on Route**” screen appears.

The method for checking the content displayed on the screen is the same as “**Traffic List**” screen.

➔ For details, refer to *Checking all traffic information* on the previous page. 



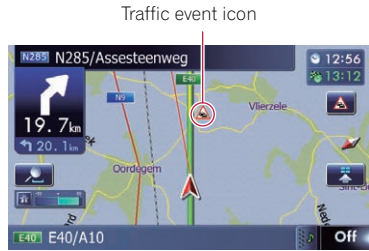

How to read traffic information on the map

The traffic event information displayed on the map is as follows.

-  A line is displayed only when the map scale is 5 km (2.5 miles) or lower.
-  Icons appear only when the scale on the map is 20 km (10 miles) or lower. If the scale is changed, the icons are resized according to the selected scale.



Traffic event icon

-  with yellow line:
Slow and queuing traffic
-  with red line:
Stationary traffic
-  with black line:
Closed/blocked roads
-  etc.:
Accidents, constructions, etc. 

Setting an alternative route to avoid traffic jams

The navigation system checks at regular intervals whether or not there is the traffic information on your route. If the navigation system detects any traffic jams on your current route, the system tries to find a better route in the background.

-  The following types of traffic incidents on the route will be checked: slow, queuing and stationary traffic, and closed/blocked roads except for closed motorway exits/entrances.

Using traffic information

Checking for traffic jams automatically

If there is information about traffic jams on your current route and if an alternative route can be found, the navigation system will recommend a new alternative route automatically. In such a case, the following screen will appear.



- ① Difference in distance and travel time between the existing route and new route.
 - ② Distance from the current position of your vehicle to the point of entry into the new route.
- There is no action if the system cannot find any traffic jam information on your route or the system cannot find an alternative.

1 Touch [New].

The recommended route is displayed on the screen.

- If you touch **[Current]** while the recommended route is displayed, the screen switches to the current route display.

2 Touch [OK].

The displayed route is set.

- When no selection is made, the screen returns to the previous screen.

Checking traffic information manually

Touching the notification icon on the map screen allows you to check traffic information on your route while the icon is displayed. The notification icon is only displayed on the navigation map screen if there is any traffic information on your route.

- The notification icon is not available if your vehicle deviates from the route.

1 Set [Show Traffic Incident] to "View".

- For details, refer to *Displaying the traffic notification icon* on page 134.

2 Display the map screen.

The icon appears when the system acquires traffic information on the current route.

3 Touch the icon while the icon is displayed.

Notification icon



Traffic information on the current route is displayed on the map screen.

4 Touch [Diversion] to search for an alternative route.



After touching **[Diversion]**, the route is recalculated taking all traffic jams on your current route into account.

- [Diversion]** will be available only when the system can find traffic jams.
- Notification icon shows the nearest traffic information on the route. However, if you touch **[Diversion]**, the route is recalculated by taking into account not only this information, but also all traffic jam information on the route.
- For details, refer to *Checking for traffic jams automatically* on this page.

- If you touch **[List]**, the "Traffic on Route" screen appears.
- If you touch **[Back]**, the message disappears and the map screen returns.

Selecting traffic information to display

There are different types of traffic information that can be received via the RDS-TMC service, and you can select which types will be incorporated and displayed on your navigation system.

1 Display the “Destination Menu” screen.

- ➔ For details of the operations, refer to *Screen switching overview* on page 22.

2 Touch [Traffic].

The “Traffic Menu” screen appears.

3 Touch [Traffic Settings].

The “Traffic Settings” screen appears.

4 Touch [Displayed Traffic Info].

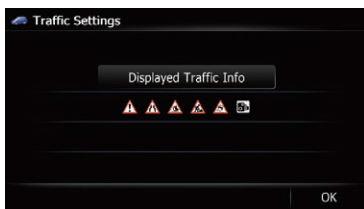

The “Traffic Type Settings” screen appears.

5 Touch the traffic information item to display.

A tick mark appears next to the selected traffic information.

- If you touch [All], you can select all entries. If you want to deselect all entries, touch [None].

6 Touch [OK].

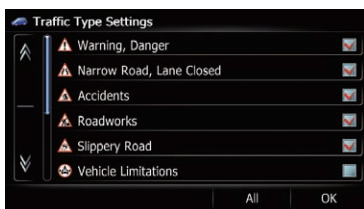

The selected traffic information icon is added to the screen.

7 Touch [OK].

Selecting preferred RDS-TMC service provider manually

A default preferred TMC service provider for each country has been set. The navigation system tunes to the radio station with good reception among the preferred RDS-TMC service providers. If you want to set another preferred RDS-TMC service provider, you can manually select one from available RDS-TMC service providers.

1 Display the “Destination Menu” screen.

- ➔ For details of the operations, refer to *Screen switching overview* on page 22.

2 Touch [Traffic].

The “Traffic Menu” screen appears.

3 Touch [TMC Provider Selection].

4 Touch the desired service provider on the list.

After touching a service provider, the system starts tuning to the selected RDS-TMC service provider. When the tuning is successful, the system returns to the map display.

Registering and connecting a Bluetooth device

If your devices feature Bluetooth® technology, this navigation system can be connected to your devices wirelessly. This section describes how to set up a Bluetooth connection.

For details about the connectivity with the devices featuring Bluetooth wireless technology, refer to the information on our website.

Preparing communication devices

This navigation system has a built-in function to use devices featuring Bluetooth wireless technology.

➤ For details, refer to *Notes for hands-free phoning* on page 68.

You can register and use devices that feature the following profiles with this navigation system.

- HFP (Hands Free Profile)
 - A2DP (Advanced Audio Distribution Profile)
- ❑ If the registered device features both HFP and A2DP, the hands-free connection is made and then the Bluetooth audio connection is made.
- If the registered device features either profile, the corresponding connection is made.
- ❑ When the navigation system is turned off, the Bluetooth connection is also disconnected. When the system restarts, the system automatically attempts to reconnect the previously-connected device. Even when the connection is severed for some reason, the system automatically reconnects the specified device (except when the connection is severed due to device operation). ❑

Registering your Bluetooth devices

You need to register your devices featuring Bluetooth wireless technology when you connect it for the first time. A total of 5 devices can be registered. Three registration methods are available:

- Searching for nearby Bluetooth devices
 - Pairing from your Bluetooth devices
 - Searching for a specified Bluetooth device
- ❑ If you try to register more than 5 devices, the system will ask you to select one of the registered devices to delete.
- For details, refer to *Deleting a registered device* on page 58.

Searching for nearby Bluetooth devices

The system searches for available Bluetooth devices near the navigation system, displays them in a list, and registers them for connection.

1 Activate the Bluetooth wireless technology on your devices.

For some Bluetooth devices, no specific-action is necessary to activate Bluetooth wireless technology. For details, refer to the instruction manual of your devices.

2 Display the “Settings Menu” screen.

- For details of the operations, refer to *Screen switching overview* on page 22.

3 Touch [Bluetooth Settings].

The “Bluetooth Settings” screen appears.

4 Touch [Registration].

The “Nearby Device List” screen appears. The system searches for Bluetooth devices waiting for the connection and displays them in the list if a device is found.

- ❑ Up to 30 devices will be listed in the order that the devices are found.

5 Wait until your Bluetooth device appears in the list.





- If you cannot find the Bluetooth device that you want to connect, check that the device is waiting for the Bluetooth wireless technology connection.

6 Touch the Bluetooth device name you want to register.

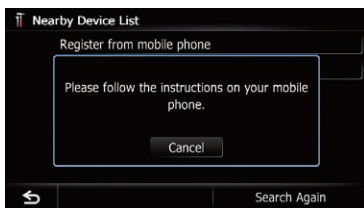

- If you touch [Search Again], the system starts searching for Bluetooth devices waiting for connection, and displays them in the list format when any devices are detected.

7 Enter the password (the default password is "1111") using the Bluetooth device.

Enter the password while the message "Please follow the instructions on your mobile phone." appears.

The device is registered in the navigation system.

After the device is successfully registered, the Bluetooth connection is established from the navigation system.

Pairing from your Bluetooth devices

You can register the Bluetooth device by setting the navigation system to standby mode and requesting connection from the Bluetooth device.

1 Activate the Bluetooth wireless technology on your devices.

For some Bluetooth devices, no specific-action is necessary to activate Bluetooth wireless technology. For details, refer to the instruction manual of your devices.

2 Display the "Settings Menu" screen.

- For details of the operations, refer to *Screen switching overview* on page 22.

3 Touch [Bluetooth Settings].

The "Bluetooth Settings" screen appears.

4 Touch [Registration].

The "Nearby Device List" screen appears.

5 Touch [Register from mobile phone].

The navigation system waits for a Bluetooth wireless technology connection.

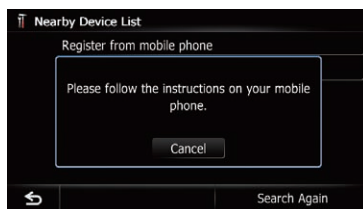

6 Register the navigation system on your Bluetooth device.

If your device asks you to enter a password, enter the password of the navigation system. When the device is successfully registered, the connection settings are made from the device.

- If registration fails, repeat the procedure from the beginning.

Registering and connecting a Bluetooth device

Searching for a specified Bluetooth device

If you cannot connect your Bluetooth device using the nearby device search and if your Bluetooth device is found in the list, try the following method.

1 Activate the Bluetooth wireless technology on your devices.

For some Bluetooth devices, no specific-action is necessary to activate Bluetooth wireless technology. For details, refer to the instruction manual of your devices.

2 Display the “Settings Menu” screen.

- ➔ For details of the operations, refer to *Screen switching overview* on page 22.

3 Touch [Bluetooth Settings].

The “Bluetooth Settings” screen appears.

4 Touch [Registration].

The “Nearby Device List” screen appears.

5 Touch [Select specific devices].

The “Select specific devices” screen appears.

6 Touch the Bluetooth device name to be connected.

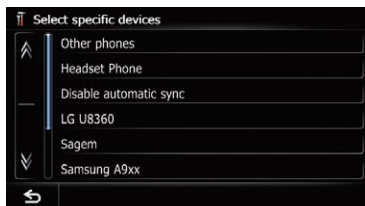

The system searches for Bluetooth devices waiting for the connection and displays them in the list if a device is found.

- If you cannot find the desired device name on the list, touch **[Other phones]** to search the devices available nearby.

7 Wait until your Bluetooth device appears in the list.



- If you cannot find the Bluetooth device that you want to connect, check that the device is waiting for the Bluetooth wireless technology connection.

8 Touch the Bluetooth device name you want to register.



- If you touch **[Search Again]**, the system starts searching for Bluetooth devices waiting for connection, and displays them in the list format when any devices are detected.

9 Enter the password (the default password is “1111”) using the Bluetooth device.

Enter the password while the message “**Please follow the instructions on your mobile phone.**” appears.

The device is registered in the navigation system.

After the device is successfully registered, the Bluetooth connection is established from the navigation system.

Deleting a registered device

When you have already registered 5 Bluetooth devices and you want to add another one, you must first delete one of the registered devices.

- If a registered phone is deleted, all the phone book entries and call history lists that correspond to the phone will be also cleared.

1 Display the “Settings Menu” screen.

- ➔ For details of the operations, refer to *Screen switching overview* on page 22.

2 Touch **[Bluetooth Settings]**.

The “**Bluetooth Settings**” screen appears.

3 Touch **[Registration]**.

A message prompting you to delete a registered device appears.

4 Touch **[OK]**.



The “**Delete from Connection List**” screen appears.

5 Touch the Bluetooth device name that you want to delete.



The device is deleted. □

Connecting a registered Bluetooth device manually

The navigation system automatically connects the Bluetooth device selected as the target of connection. However, connect the Bluetooth device manually in the following cases:

- Two or more Bluetooth devices are registered, and you want to manually select the device to be used.
- You want to reconnect a disconnected Bluetooth device.
- Connection cannot be established automatically for some reason.

If you start connection manually, carry out the following procedure. You can also connect the Bluetooth device by having the navigation system detect it automatically.

1 Activate the Bluetooth wireless technology on your devices.

For some Bluetooth devices, no specific-action is necessary to activate Bluetooth wireless technology. For details, refer to the instruction manual of your devices.

2 Display the “Settings Menu” screen.

- ➔ For details of the operations, refer to *Screen switching overview* on page 22.

3 Touch **[Bluetooth Settings]**.

The “**Bluetooth Settings**” screen appears.

4 Touch **[Connection]**.

The “**Connection List**” screen appears.

Registering and connecting a Bluetooth device

5 Touch the name of the device that you want to connect.

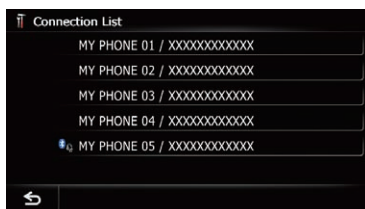

The “**Select Profile**” screen appears.

6 Touch the profile that you want to connect.

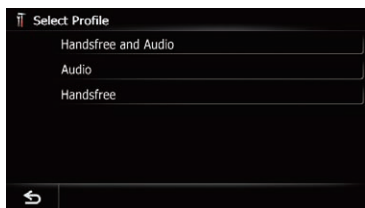

You can select the following profiles:

- **Handsfree and Audio:**
Connects the device as the hands-free phone and the Bluetooth audio player.
- **Audio:**
Connects the device as Bluetooth audio player.
- **Handsfree:**
Connects the device as the hands-free phone.

Connection starts.



When a connection is successfully established, a connection complete message appears and the map screen returns by touching [OK].

- To cancel the connection to your device, touch [Cancel].
- If connection fails, check whether your device is waiting for a connection and then retry.

Setting for priority connecting

The selected device is set for priority connecting.

And one of the following icons is indicated next to the device name.

- : Appears when the device is registered so that it will be preferentially paired with both the hands-free and Bluetooth audio connection.
- : Appears when the device is registered so that it can be preferentially paired with the hands-free connection.
- : Appears when the device is registered so that it will be preferentially paired with the Bluetooth audio connection.

⚠ CAUTION

For your safety, avoid talking on the phone as much as possible while driving.

If your mobile phone features Bluetooth technology, this navigation system can be connected to your mobile phone wirelessly. Using this hands-free function, you can operate the navigation system to make or receive phone calls. You can also transfer the phone book data stored in your mobile phone to the navigation system. This section describes how to set up a Bluetooth connection and how to operate a mobile phone featuring Bluetooth technology on the navigation system.

For details about the connectivity with the devices featuring Bluetooth wireless technology, refer to the information on our website.

Displaying the phone menu

Use the “Phone Menu” if you connect the mobile phone to the navigation system for utilisation.

➔ For details, refer to Chapter 11.

1 Press the HOME button to display the “Top Menu” screen.

2 Touch [Phone].

The “Phone Menu” screen appears.

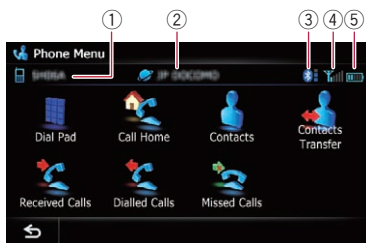

- ① Name of connected mobile phone
- ② Network name of the mobile phone company
- ③ Strength of the Bluetooth connection between the navigation system and the device
- ④ Reception status of the mobile phone
- ⑤ Battery status of the mobile phone

Making a phone call

You can make a phone call in many different ways.

Direct dialling

1 Display the “Phone Menu” screen.

➔ For details, refer to *Displaying the phone menu* on this page.

2 Touch [Dial Pad].

The “Dial Input” screen appears.

3 Touch the number keys to enter the phone number.



The phone number that was input is displayed.

When the input is complete, [OK] becomes active.

- If you touch , the entered number is deleted one digit at a time from the end of the number. Press and hold to delete all digits.
- If you touch , the previous screen returns.

4 Touch [OK] to make a call.

☐ To cancel the call after the system starts dialling, touch .

5 Touch to end the call.

Using hands-free phoning

Making a call home easily

You can call home without taking the time to enter the phone number if the phone number has been registered.

1 Display the “Phone Menu” screen.

- ➔ For details, refer to *Displaying the phone menu* on the previous page.

2 Touch [Call Home].

Dialling home starts.

- If you have not registered your home number, a message appears. Touch [Register] to start registration.
 - ➔ For details, refer to *Registering your home* on page 130.

Calling a number in the phone book

You can select and call a contact from the phone book entries transferred to the navigation system.

- Before using this function, you need to transfer the phone book entries stored in your mobile phone to the navigation system.
 - ➔ For details, refer to *Transferring the phone book* on page 64.

Searching for a contact to call on the alphabet tabs

1 Display the “Phone Menu” screen.

- ➔ For details, refer to *Displaying the phone menu* on the previous page.

2 Touch [Contacts].

The “Contacts List” screen appears.

3 Touch alphabet tabs.

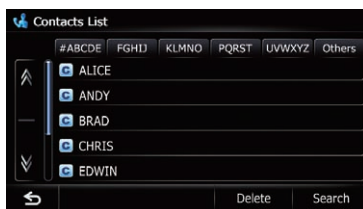

The screen jumps to the top of the page displaying the entries that start with the selected letter or number.

- Touching [#ABCDE] displays all entries that start with symbols or numbers.
- Touching [Others] displays the page including entries that are not assigned to any of the other tabs.

4 Touch the desired name on the list.

The “Contacts Type Selection” screen appears.

5 Touch the desired entry on the list to make a call.

6 Touch to end the call.

Calling a number by searching by name

1 Display the “Phone Menu” screen.

- ➔ For details, refer to *Displaying the phone menu* on the previous page.

2 Touch [Contacts].

The “Contacts List” screen appears.

3 Touch [Search].

The “Contacts Name Search” screen appears. You can search by the names registered in the “Contacts List” screen.

- 4 Enter the desired name and then touch [OK].

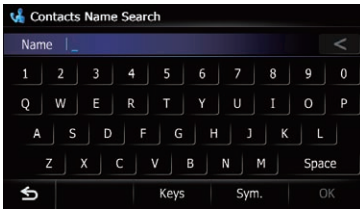

The “**Contacts Name Search Results**” screen appears.

- 5 Touch the desired name on the list.
The “**Contacts Type Selection**” screen appears.
- 6 Touch the desired entry on the list to make a call.
- 7 Touch  to end the call.

Dialling from the history

The most recent calls made (dialled), received and missed are stored in the call history list. You can browse the call history list and call numbers from it.

- Each call history saves 30 calls per registered mobile phone. If the number of calls exceeds 30, the oldest entry will be deleted.

- 1 Display the “**Phone Menu**” screen.
- ➔ For details, refer to *Displaying the phone menu* on page 60.
- 2 Touch [Received Calls], [Dialled Calls] or [Missed Calls].
The selected call history list appears.
- 3 Touch an entry on the list.



Dialling starts.

- To cancel the call after the system starts dialling, touch .
- If you touch [Detail], the “**Detailed Information**” screen appears.

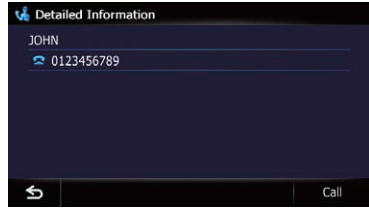



You can check the details of the party before making a phone call.

- 4 Touch  to end the call.

Dialling a favourite location

You can make a call to an entry stored in the “**Favourites**” list.

- 1 Display the “**Destination Menu**” screen.
- ➔ For details of the operations, refer to *Screen switching overview* on page 22.
- 2 Touch [Favourites].
The “**Favourites**” screen appears.
- 3 Touch  next to the location that you want to make a call.
The “**Edit Favourite**” screen appears.
- 4 Touch [Call] to make a call.
- To cancel the call after the system starts dialling, touch .
- 5 Touch  to end the call.

Dialling a facility's phone number

You can make a call to facilities with phone number data.

- You cannot make a call to locations or POIs that have no phone number data.
- 1 Display the “**Destination Menu**” screen.
- ➔ For details of the operations, refer to *Screen switching overview* on page 22.

Using hands-free phoning

2 Touch [POI].

The "POI Search" screen appears.

3 Search for the POI.

The "POI List" screen appears.

- ➔ For details of the operation, refer to *Searching for Points of Interest (POI)* on page 38.

4 Touch next to the POI that you want to call.

The "POI Information" screen appears.

5 Touch [Call] to make a call.

- To cancel the call after the system starts dialling, touch .

6 Touch to end the call.

Dialling from the map

You can make a call by selecting the icon of a registered location or a POI icon from the map screen.

- You cannot make a call to locations or POIs that have no phone number data.

1 Scroll the map, and place the cursor on an icon on the map.

2 Touch .

The "Information List" screen appears.

3 Touch the POI you want.

The "POI Information" screen appears.

4 Touch [Call] to make a call.

- To cancel the call after the system starts dialling, touch .

5 Touch to end the call.

Receiving a phone call

You can perform hands-free answering by using the navigation system.

Answering an incoming call

The system informs you that it is receiving a call by displaying a message and producing a ring sound.



- You can set the system to automatically answer incoming calls. If not set to automatically answer incoming calls, you will have to answer the calls manually.
 - ➔ For details, refer to *Answering a call automatically* on page 66.
- If the voice on the other end of the call is too quiet to hear, you can adjust the volume of the received voice.
 - ➔ For details, refer to *Setting the Volume for Guidance and Phone* on page 142.
- The registered name appears if the phone number of the received call is already registered in "Contacts".
- Depending on the caller ID service, the phone number of the received call may not be displayed. "Unknown" appears instead.

1 To answer an incoming call, touch .

The operation menu during a call appears.

- If you touch [Vol -] or [Vol +], you can adjust the ring tone volume.
- If you touch  an incoming call is rejected.

The rejected call is recorded in the missed call history list.

- ➔ For details, refer to *Dialling from the history* on the previous page.

2 Touch to end the call.



The call ends.

- ❑ You may hear a noise when you hang up the phone.
- If you touch [**Vol -**] or [**Vol +**], you can adjust the volume when talking.
- If you touch [**Close Menu**], the operation menu during call is minimised.

To display the menu again, touch .



Transferring the phone book

You can transfer the phone book entries from your mobile phone to the phone book of the navigation system.

- ❑ Depending on the mobile phone, phone book may be called Contacts, Business Card or something else.
- ❑ With some mobile phones, it may not be possible to transfer the entire phone book at once. In this case, transfer addresses one at a time from your phone book using your mobile phone.
- ❑ If you connect the mobile phone featuring auto-synchronisation function, phone book transfer or synchronisation will be automatically performed.

- ❑ A maximum of 1 000 entries can be transferred per mobile phone. If the entries exceed 1 000, the extra entries will not be transferred. If more than one number is registered for one person, such as work place and home, each number may be counted separately.
- ❑ Each entry can hold up to 5 phone numbers.
- ❑ Depending on the mobile phone that is connected to this navigation system via Bluetooth technology, this navigation system may not be able to display the phone book correctly. (Some characters may be garbled.)
- ❑ If the phone book in the mobile phone contains image data, the phone book may not be correctly transferred.
- ❑ The transferred data cannot be edited on the navigation system.

1 Connect the mobile phone that has the phone book to transfer.

- ➔ For details, refer to *Connecting a registered Bluetooth device manually* on page 58.

2 Touch [**Contacts Transfer**] on the "Phone Menu" screen.

3 Check that the following screen is displayed, and operate your mobile phone to transfer the phone book entries.

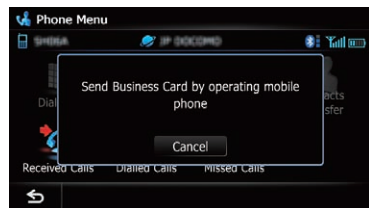

When data transfer is finished, a message asking whether you want to transfer more data appears.

Touch [**Yes**] to continue the transfer.

Using hands-free phoning

4 Touch [No].



The transferred data is imported to the navigation system.

When the data is successfully imported, an import complete message is displayed and the **“Contacts List”** screen appears.

- It may take time depending on how many entries will be transferred.

Deleting registered contacts

1 Display the **“Phone Menu”** screen.

- ➔ For details, refer to *Displaying the phone menu* on page 60.

2 Touch [Contacts].

The **“Contacts List”** screen appears.

3 Touch [Delete].

The **“Delete from Contacts”** screen appears.

4 Touch the entry you want to delete.

A tick mark appears next to the entry.

- If you touch **[All]**, you can select all entries. If you want to deselect all entries, touch **[None]**.

5 Touch [Delete].

The message confirming whether to delete the entry appears.

6 Touch [Yes].

The entry is deleted.

- If you touch **[No]**, the deletion is cancelled.

Changing the phone settings

Editing the device name

You can change the device name to be displayed on your mobile phone. (Default is **“PIONEER NAVI”**.)

1 Display the **“Settings Menu”** screen.

- ➔ For details of the operations, refer to *Screen switching overview* on page 22.

2 Touch [Bluetooth Settings].

The **“Bluetooth Settings”** screen appears.

3 Touch [Device Name].

The keyboard to enter the name appears.

4 Touch **[<]** to delete the current name, and enter the new name by using the keyboard.



- Up to 16 characters can be entered for a device name.

5 Touch [OK].

The name is changed.

Editing the password

You can change the password to be used for authentication on your mobile phone. (Default is **“1111”**.)

- Four to eight characters can be entered for a password.

1 Display the **“Settings Menu”** screen.

- ➔ For details of the operations, refer to *Screen switching overview* on page 22.

2 Touch [Bluetooth Settings].

The **“Bluetooth Settings”** screen appears.

3 Touch [Password].

The **“Set Password”** screen appears.

4 Touch  to delete the current password, and enter the new password by using the keyboard.

5 Touch [OK].

The password is changed.

Stopping Bluetooth wave transmission

You can stop transmission of electric waves by turning off the Bluetooth function. If you do not use the Bluetooth wireless technology, we recommend selecting "Off".

1 Display the "Settings Menu" screen.

- ➔ For details of the operations, refer to *Screen switching overview* on page 22.

2 Touch [Bluetooth Settings].

The "Bluetooth Settings" screen appears.

3 Touch [Bluetooth On/Off].

Each touch of [Bluetooth On/Off] changes the settings as follows:

- **On** (default):
Turns on Bluetooth function.
- **Off**:
Turns off Bluetooth function.

Echo cancelling and noise reduction

When you are operating hands-free phoning in the vehicle, you may hear an undesirable echo. This function reduces the echo and noise while you are using hands-free phoning, and maintains a certain sound quality.

1 Display the "Settings Menu" screen.

- ➔ For details of the operations, refer to *Screen switching overview* on page 22.

2 Touch [Bluetooth Settings].

The "Bluetooth Settings" screen appears.

3 Touch [Echo Cancel].

Each touch of [Echo Cancel] changes the settings as follows:

- **On** (default):

Activates echo cancelling and noise reduction.

- **Off:**

Deactivates echo cancelling and noise reduction.

Answering a call automatically

The navigation system automatically answers incoming calls to the mobile phone, so you can answer a call while driving without taking your hands off the steering wheel.

1 Display the "Settings Menu" screen.

- ➔ For details of the operations, refer to *Screen switching overview* on page 22.

2 Touch [Bluetooth Settings].

The "Bluetooth Settings" screen appears.

3 Touch [Auto Answer Preference].

The "Auto Answer Preference" screen appears.

4 Touch the desired option.

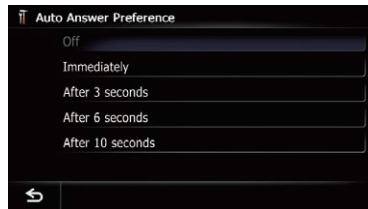

On this screen, you can select the following items:

- **Off** (default):
No automatic response. Respond manually.
- **Immediately**:
Answers immediately.
- **After 3 seconds**:
Answers after three seconds.
- **After 6 seconds**:
Answers after six seconds.
- **After 10 seconds**:
Answers after ten seconds.

Using hands-free phoning

Setting the automatic rejection function

If this function is on, the navigation system automatically rejects all incoming calls.

1 Display the "Settings Menu" screen.

- ➔ For details of the operations, refer to *Screen switching overview* on page 22.

2 Touch [Bluetooth Settings].

The "Bluetooth Settings" screen appears.

3 Touch [Refuse All Calls].

Each touch of [Refuse All Calls] changes the settings as follows:

- **Off** (default):
Accepts all incoming calls.
- **On**:
Rejects all incoming calls.
- If both "Refuse All Calls" and "Auto Answer Preference" are activated, "Refuse All Calls" takes priority and all incoming calls are automatically rejected.
- If "Refuse All Calls" is set to "On", rejected incoming calls will not be stored in the missed call list.

Clearing memory

You can clear the memory of each item that corresponds to the connected mobile phone: phone book, dialled/received/missed call history list and preset dials.

1 Display the "Settings Menu" screen.

- ➔ For details of the operations, refer to *Screen switching overview* on page 22.

2 Touch [Bluetooth Settings].

The "Bluetooth Settings" screen appears.

3 Touch [Clear Memory].

The "Clear Memory" screen appears.

4 Touch the desired option.

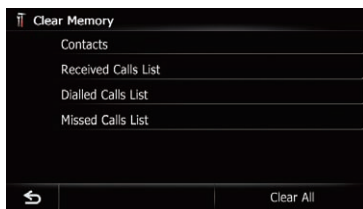

On this screen, you can select the following items:

- **Contacts**:
Clears the registered phone book.
- **Received Calls List**:
Clears the received call history list.
- **Dialled Calls List**:
Clears the dialled call history list.
- **Missed Calls List**:
Clears the missed call history list.
- If you touch [Clear All], all the data is cleared that correspond to the connected mobile phone.

5 Touch [Yes].

Data on the selected item is cleared from this navigation system's memory.

- If you do not want to clear the memory that you have selected, touch [No].

Updating the Bluetooth wireless technology software

Update files will be available for download in the future. You will be able to download the latest update from an appropriate website to your PC.

- Before you download the files and install the update, read through the instructions on the website. Follow the instructions on the website for steps until [Firmware update] becomes active.

1 Store the updated files into the SD memory card.

2 Insert an SD memory card into the SD card slot.

- ➔ For details of the operation, refer to *Inserting and ejecting an SD memory card* on page 17.

Using hands-free phoning

3 Display the “Settings Menu” screen.

- ➔ For details of the operations, refer to *Screen switching overview* on page 22.

4 Touch [Bluetooth Settings].

The “Bluetooth Settings” screen appears.

5 Touch [Firmware update].

The current version is displayed.



6 Touch [Firmware update].

The message confirming whether or not to start the update will appear.

7 Touch [Yes].

Update starts.

8 Wait until the upgrade process is complete.

A message will appear after the update is complete.

9 Touch [OK].

The message disappears, and the map screen returns.

10 Eject the SD memory card.

Notes for hands-free phoning

General notes

- Connection to all mobile phones featuring Bluetooth wireless technology is not guaranteed.
- The line-of-sight distance between this navigation system and your mobile phone must be 10 metres or less when sending and receiving voice and data via Bluetooth technology. However, the actual transmission distance may be shorter than the estimated distance, depending on the usage environment.

- With some mobile phones, the ring sound may not be output from the speakers.
- If private mode is selected on the mobile phone, hands-free phoning may be disabled.

Registration and connection

- Mobile phone operations vary depending on the type of mobile phone. Refer to the instruction manual that came with your mobile phone for detailed instructions.
- With mobile phones, phone book transfer may not work even though your phone is paired with the navigation system. In that case, disconnect your phone, perform pairing again from your phone to the navigation system, and then perform the phone book transfer.

Making and receiving calls

- You may hear a noise in the following situations:
 - When you answer the phone by using the button on the phone.
 - When the person on the other end of line hangs up the phone.
- If the person on the other end of the phone call cannot hear the conversation due to an echo, decrease the volume level for hands-free phoning. This may reduce the echo.
- With some mobile phones, even if you press the accept button on the mobile phone when a call comes in, hands-free phoning may not be performed.
- The registered name appears if the phone number of the received call is already registered in the phone book. When one phone number is registered under different names, the name that comes first in the phone book is displayed.
- If the phone number of the received call is not registered in the phone book, the phone number of the received call appears.

The received call history and the dialled number history

- Calls made or editing performed only on your mobile phone will not be reflected to the dialled number history or phone book in the navigation system.

Using hands-free phoning

- You cannot make a call to the entry of an unknown user (no phone number) in the received call history.
- If calls are made by operating your mobile phone, no history data will be recorded in the navigation system.

Phone book transfers

- If there are more than 1 000 phone book entries on your mobile phone, all entries may not be downloaded completely.
- With some mobile phones, it may not be possible to transfer all items in the phone book at one time. In this case, transfer items one by one from your mobile phone.
- Depending on the mobile phone, this navigation system may not display the phone book correctly. (Some characters may be garbled, or first and last names may be reversed.)
- If the phone book in the mobile phone contains image data, the phone book may not be transferred correctly. (Image data cannot be transferred from the mobile phone.)
- Depending on the mobile phone, phone book transfer may not be available.

This chapter describes the basic operations of the AV source.

You can play or use the following sources with your Pioneer navigation system.

- TUNER (FM, MW/LW)
- CD
- ROM (in MP3, AAC, WMA)
- DVD-Video
- DivX
- USB
- SD

The following sources can be played back or used by connecting an auxiliary device.

- iPod
- Bluetooth audio
- AV input 1 (AV1)
- AV input 2 (AV2)

Displaying the AV operation screen

- Press the **MODE** button when the map screen is displayed.

- The AV operation screen can also be displayed by touching **[AV Source]** on the "Top Menu".

Selecting a source

Source icons

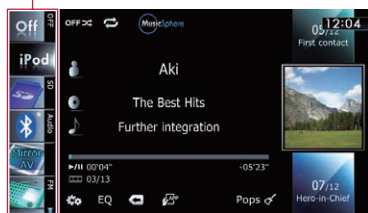

- 1 Touch, then drag any source icons up or down to display additional source icons.

The AV source icons will scroll, and previously hidden icons will appear.

- 2 Tap the icon of the source you want to select.

The operation screen of the selected source appears.

- The currently selected source icon is highlighted. □

Operating list screens (e.g. iPod list screen)

This describes the operations when a list screen is displayed.

- For information on how to display the list screen, refer to the descriptions within the desired source portion of this manual.

Switching between the AV operation screen and the list screen

The following example describes how to switch between the AV operation screen and the artist list screen of iPod.

- 1 Touch the appropriate key to display the list that you want.



- 2 Touch the key on the right edge of the screen.

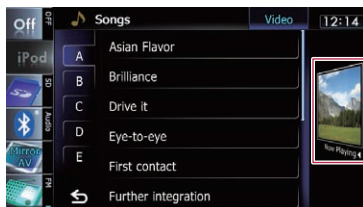

The AV operation screen returns.

Basic operations of the AV source

Selecting an item

1 Scroll the list by dragging items up or down to display the item you want to select.



- Flicking a list item enables you to quickly scroll through the list.
To stop scrolling, gently touch the list.

2 Tap the item.

- The item currently selected is highlighted.

Returning to the previous display

- Touch  to return to the previous screen.

Using the radio (FM)

You can listen to the radio by using the navigation system. This section describes operations for radio (FM).

The functions related to RDS (Radio Data System) are available only in areas with FM stations broadcasting RDS signals. Even if the navigation system is receiving an RDS station, not all the functions related with RDS will be available.

Starting procedure

1 Display the AV operation screen.

- ➔ For details of the operations, refer to *Displaying the AV operation screen* on page 70.

2 Tap [FM] on the left edge of the screen to display the "FM" screen.

3 Use the touch panel keys on the screen to control the radio.

- ➔ For details, refer to *Using the touch panel keys* on the next page.

Shows that the frequency selected is being broadcast in stereo.

- ⑥ **TEXT indicator**
Shows when radio text is received.
- ⑦ **NEWS indicator**
Shows the status of news programmes.
- ⑧ **TRFC indicator**
Shows the status of traffic announcements.
- ⑨ **Current time**
- ⑩ **Programme service name or frequency indicator**
Shows the frequency of the preset item. If the programme service name can be obtained, the programme service name is shown instead of the frequency.
- ⑪ **Preset number indicator**
Shows what preset item has been selected.
- ⑫ **PTY indicator**
Shows the programme type of the current station (when available).
- ⑬ **Radio text display area**
Displays the radio text currently received.
- ⑭ **Source icon**
Shows which source has been selected.

Reading the screen

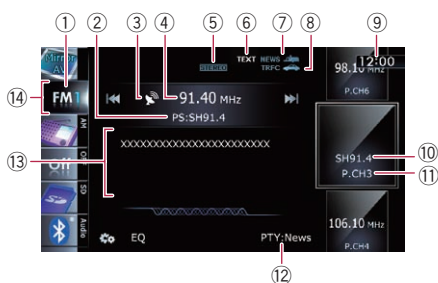

① Band indicator

Shows which band the radio is tuned to: FM1 to FM3.

② Programme service name indicator

Shows the programme service name (station name) of the current station.

③ Signal level indicator

④ Frequency indicator

⑤ STEREO indicator

Using the radio (FM)

Using the touch panel keys

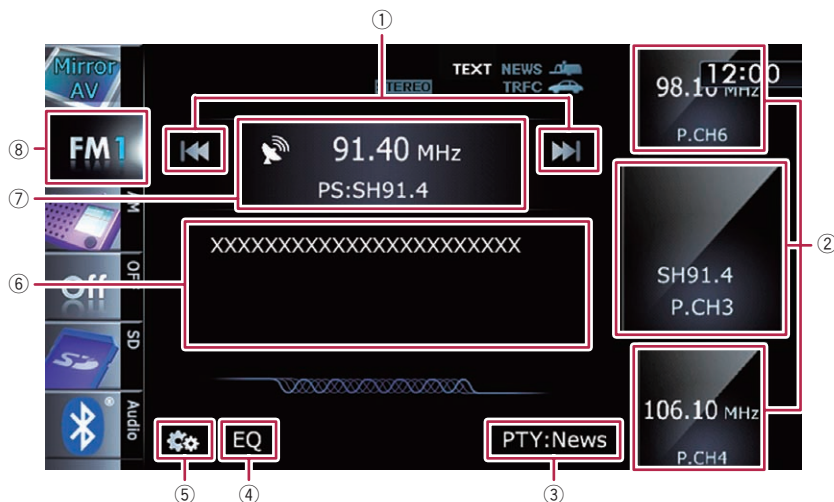

① Performs manual tuning

To tune manually, touch [◀◀] or [▶▶] briefly. The frequencies move up or down one step at a time.

Performs seek tuning

To perform seek tuning, touch and hold [◀◀] or [▶▶] for about one second and then release. The tuner will scan frequencies until a broadcast strong enough for good reception is found.

- You can cancel seek tuning by touching either [◀◀] or [▶▶] briefly.
- If you keep holding [◀◀] or [▶▶], you can skip broadcasting frequencies. Seek tuning will start at the time you release the keys.

② Selects a preset channel

The keys can be used to switch preset channels.

Scroll by dragging the keys up or down to display the preset channel you want to select, and tap the channel.

- The lower keys and the upper keys appear only when the preset channel is selected.

③ Searches for an RDS station by PTY information

- ➔ For details, refer to *Searching for an RDS station by PTY information* on page 76.

④ Recalls equaliser curves

- ➔ For details, refer to *Using the equaliser* on page 152.

⑤ Displays the “Function” menu

- ➔ For details, refer to *Using advanced functions* on page 75.

⑥ Displays radio text screen

⑦ Switches between the AV operation screen and the preset list display

You can switch the screen display according to your preference.

- ➔ For details of the operation, refer to *Switching between the AV operation screen and the list screen* on page 70.

⑧ Selects an FM band

Tapping the key repeatedly switches between the following FM bands: **FM1**, **FM2**, or **FM3**.

- This function is convenient for preparing different preset lists for each band.

Storing and recalling broadcast frequencies

With a tap of any of the preset tuning keys (“P1” to “P6”), you can easily store up to six broadcast frequencies for later recall (also with the tap of a key).

1 Select a frequency that you want to store in memory.

2 Display the preset channel list.

- For details, refer to *Switches between the AV operation screen and the preset list display* on the previous page.

3 Keep touching a preset tuning key [P1] to [P6].

Preset list display



Preset tuning keys

- For details of the list operations, refer to *Operating list screens (e.g. iPod list screen)* on page 70.

The selected radio station has been stored in memory.

The next time you tap the same preset tuning key “P1” to “P6”, the radio station frequencies are recalled from memory.

- ❑ Up to 18 FM stations, six for each of the three FM bands can be stored in memory.

Using radio text

This tuner can display radio text data transmitted by RDS stations, such as station information, the title of the currently broadcast song and the name of the artist.

- ❑ The tuner automatically memorises the three latest radio text broadcasts received,

replacing text from the least recent reception with new text when it is received.

- ❑ When no radio text is received, “No Text” is displayed.

Viewing the three latest radio text

You can display the currently received radio text and the three most recent radio text transmissions.

1 Display the radio text screen.

- For details, refer to *Displays radio text screen* on the previous page.

2 Press the TRK button.

Pressing the button switches the text contents from the current radio text to the most recent three radio text transmissions.

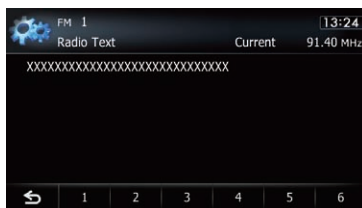

- ❑ If there is no radio text data in memory, the display will not change.

Storing and recalling radio text

You can store data from up to six radio text transmissions in the touch panel keys “1” to “6”.

1 Display the radio text you want to store in memory.

- For details, refer to *Viewing the three latest radio text* on this page.

2 Touch and hold any of the keys [1] to [6] to store the displayed radio text.

The selected radio text is stored in memory. The next time you press the same keys in the radio text display, the stored text is recalled from memory.

Using the radio (FM)

- If the radio text data is already stored under all keys, the new text will overwrite the existing one. ▣

Operating by hardware buttons

Pressing the TRK button

You can now preset channels up or down.

Pressing and holding the TRK button

You can perform seek tuning. ▣

Using advanced functions

- Touch  on the "FM" screen.

The "Function" menu appears.

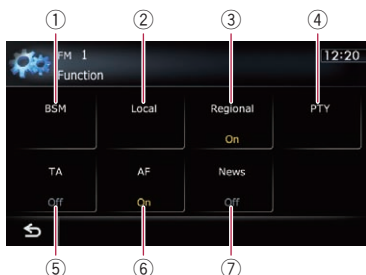

- ① Stores the strongest broadcast frequencies
 - ② Tunes in strong signals
 - ③ Limits stations to regional programming
 - ④ Searches for an RDS station by PTY information
 - ⑤ Receives traffic announcements
 - ⑥ Tunes into alternative frequencies
 - ⑦ Uses news programme interruption
- ▣ For details of each function, refer to sections below with the relative titles.

Storing the strongest broadcast frequencies

BSM (best stations memory) lets you automatically store the six strongest broadcast frequencies under the preset tuning keys "P1" to "P6" and, once stored there, you can tune into them with the touch of a key.

- Storing broadcast frequencies with BSM may replace broadcast frequencies you have already saved.

1 Touch on the "FM" screen.

The "Function" menu appears.

2 Touch [BSM].

3 Touch [Start] to begin a search.

"BSM" begins to flash. While "BSM" is flashing, the six strongest broadcast frequencies will be stored under the preset tuning keys "P1" to "P6" in order of their signal strength. When this is complete, "BSM" stops flashing.

- ▣ If you touch [Stop], the storage process is cancelled.

Tuning in strong signals

Local seek tuning allows you to tune in only those radio stations with sufficiently strong signals for good reception.

1 Touch on the "FM" screen.

The "Function" menu appears.

2 Touch [Local].

3 Touch [On] to turn local seek tuning on.

- ▣ If you touch [Off], local seek tuning is turned off.

4 Touch [◀Prev] or [Next▶] to set the sensitivity.

There are four levels of sensitivity for FM.

Level: 1 — 2 — 3 — 4

- The level "4" setting allows reception of only the strongest stations, while lower settings let you receive weaker stations.

Limiting stations to regional programming

When AF is used to automatically retune frequencies, the regional function limits the selection to stations broadcasting regional programmes.

1 Touch on the "FM" screen.

The "Function" menu appears.

2 Touch [Regional].

Each touch of [Regional] turns it on or off.

- Regional programming and regional networks are organised differently depending on the country (i.e., they may change according to the time, country or broadcast area).
- The preset number may disappear on the display if the tuner tunes in a regional station that differs from the originally set station.
- The regional function can be turned on or off independently for each FM band.

Searching for an RDS station by PTY information

You can search for general types of broadcasting programmes.

➔ For details, refer to *PTY list* on page 79.

1 Touch on the "FM" screen.

The "Function" menu appears.

2 Touch [PTY].

3 Touch [◀Prev] or [Next▶] to select a programme type.

There are four programme types:

NEWS&INF — Popular — Classics — Others

4 Touch [Start] to begin a search.

The tuner searches for a station broadcasting that programme type.

- If you touch [Stop], the search is cancelled.
- The programmes of some stations may differ from that indicated by the transmitted PTY.

- If no station is broadcasting the type of programme you searched for, "Not Found" is displayed for about two seconds and then the tuner returns to the original station.

Receiving traffic announcements

TA (traffic announcement standby) lets you receive traffic announcements automatically, no matter what source you are listening to. TA can be activated for both a TP station (a station that broadcasts traffic information) or another enhanced network's TP station (a station carrying information that cross-references TP stations).

1 Tune in a TP station or another enhanced network's TP station.

2 Touch [TA] on the "Function" menu to turn traffic announcement standby on.

- To turn traffic announcements standby off, touch [TA] again.

3 Use the VOL (+/-) button or Multi-control to adjust the TA volume when a traffic announcement begins.

The newly set volume is stored in memory and recalled for subsequent traffic announcements.

4 Touch [Cancel] while a traffic announcement is being received to cancel the announcement.

The tuner returns to the original source but remains in standby mode until [TA] is touched again.

You can also cancel the announcement by changing the source or band.

- The system switches back to the original source following traffic announcement reception.
- Only TP stations and other enhanced networks' TP stations are tuned in during seek tuning or BSM when the TA function is on.

Using the radio (FM)

Tuning into alternative frequencies

If you are listening to a broadcast and the reception becomes weak or there are other problems, the navigation system will automatically search for a different station in the same network that is broadcasting a stronger signal.

1 Touch on the "FM" screen.

The "Function" menu appears.

2 Touch [AF].

Each touch of [AF] turns it on or off.

- Only RDS stations are tuned in during seek tuning or BSM when AF is on.
- When you recall a preset station, the tuner may update the preset station with a new frequency from the station's AF list. No preset number appears on the display if the RDS data for the station received differs from that for the originally stored station.
- Sound may be temporarily interrupted by another programme during an AF frequency search.
- AF can be turned on or off independently for each FM band.

PI Seek operation

If the unit fails to find a suitable alternative frequency, or if you are listening to a broadcast and the reception becomes weak, the navigation system will automatically search for a different station with the same programming. During the search, "PI Seek" is displayed and the output is muted. Muting is discontinued after completion of the PI Seek, whether or not a different station is found.

Activating the Auto PI seek for preset stations

When preset stations cannot be recalled, as when travelling long distances, the unit can be set to perform PI Seek during preset recall.

- The default setting for Auto PI Seek is off.
- ➔ For details, refer to *Switching Auto PI seek* on page 150.

Using news programme interruption

When a news programme is broadcast from a PTY code news station, the navigation system can switch from any station to the news broadcast station. When the news programme ends, reception of the previous programme resumes.

1 Touch on the "FM" screen.

The "Function" menu appears.

2 Touch [News].

Each touch of [News] turns it on or off. A news programme can be cancelled by touching [Cancel].



You can also cancel the news programme by changing the source or band.

Interruption icon status



When the information interruption setting is enabled, the interruption icon is displayed. The interruption icon display may change depending on the programme reception status.

- ➔ For details of the operation, refer to *Receiving traffic announcements* on the previous page.
- ➔ For details of the operations, refer to *Using news programme interruption* on this page.
- The interruption icon is displayed on all AV source operation screens.

TRFC indicator

Indicator	Meaning
	Information interruption is activated, but you will not receive data since there is none.
	Information interruption is activated, and currently receiving data.
(No display)	Information interruption is deactivated.

NEWS indicator

Indicator	Meaning
	Information interruption is activated, but you will not receive data since there is none.
	Information interruption is activated, and currently receiving data.
(No display)	Information interruption is deactivated.

Using the radio (FM)

PTY list

General	Specific	Type of programme
NEWS&INF	News	News
	Affairs	Current affairs
	Info	General information and advice
	Sport	Sports
	Weather	Weather reports/meteorological information
	Finance	Stock market reports, commerce, trading, etc.
Popular	Pop Mus	Popular music
	Rock Mus	Contemporary modern music
	Easy Mus	Easy listening music
	Oth Mus	Non categorised music
	Jazz	Jazz
	Country	Country music
	Nat Mus	National music
	Oldies	Oldies music, golden oldies
	Folk Mus	Folk music
Classics	L. Class	Light classical music
	Classic	Serious classical music
Others	Educate	Educational programmes
	Drama	All radio plays and serials
	Culture	National or regional culture
	Science	Nature, science and technology
	Varied	Light entertainment
	Children	Children's
	Social	Social affairs
	Religion	Religion affairs or services
	Phone In	Phone In
	Touring	Travel programmes, not for announcements about traffic problems
	Leisure	Hobbies and recreational activities
	Document	Documentaries



You can listen to the radio using this navigation system. This section describes operations for radio (MW/LW).

Starting procedure

1 Display the AV operation screen.

- For details of the operations, refer to *Displaying the AV operation screen* on page 70.

2 Tap [AM] on the left edge of the screen to display the "AM" screen.

3 Use the touch panel keys on the screen to control the radio.

- For details, refer to *Using the touch panel keys* on the next page.

Reading the screen

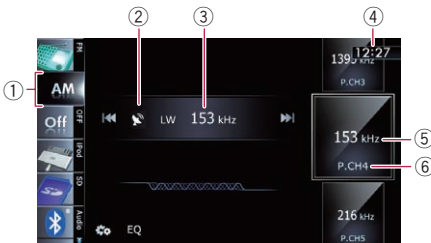

① Source icon

Shows which source has been selected.

② Signal level indicator

③ Frequency indicator

④ Current time

⑤ Frequency indicator

Shows the frequency of the preset item.

⑥ Preset number indicator

Shows what preset item has been selected.

Using the radio (AM)

Using the touch panel keys

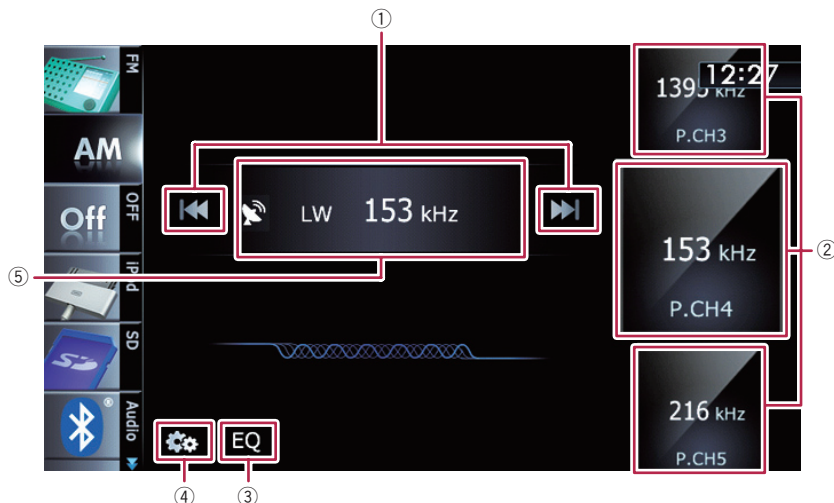

① Performs manual tuning

To tune manually, touch [◀◀] or [▶▶] briefly. The frequencies move up or down one step at a time.

Performs seek tuning

To perform seek tuning, touch and hold [◀◀] or [▶▶] for about one second and then release. The tuner will scan frequencies until a broadcast strong enough for good reception is found.

- You can cancel seek tuning by touching either [◀◀] or [▶▶] briefly.
- If you keep holding [◀◀] or [▶▶], you can skip broadcasting frequencies. Seek tuning will start at the time you release the keys.

② Selects a preset channel

The keys can be used to switch preset channels.

Scroll by dragging the keys up or down to display the preset channel you want to select, and tap the channel.

- The lower keys and the upper keys appear only when the preset channel is selected.

③ Recalls equaliser curves

➤ For details, refer to *Using the equaliser* on page 152.

④ Displays the “Function” menu

➤ For details, refer to *Using advanced functions* on the next page.

⑤ Switches between the AV operation screen and the preset list display

You can switch the screen display according to your preference.

➤ For details of the operation, refer to *Switching between the AV operation screen and the list screen* on page 70.

Storing and recalling broadcast frequencies

With a tap of any of the preset tuning keys (“P1” to “P6”), you can easily store up to six broadcast frequencies for later recall (also with the tap of a key).

1 Select a frequency that you want to store in memory.

Using the radio (AM)

2 Display the preset channel list.

- ➔ For details, refer to **Switches between the AV operation screen and the preset list display** on the previous page.

3 Keep touching a preset tuning key [P1] to [P6].

Preset list display

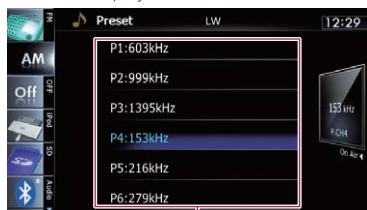

Preset tuning keys

- ➔ For details of the list operations, refer to **Operating list screens (e.g. iPod list screen)** on page 70.

The selected radio station has been stored in memory.

The next time you tap the same preset tuning key "P1" to "P6", the radio station frequencies are recalled from memory.

Operating by hardware buttons

Pressing the TRK button

You can move preset channels up or down.

Pressing and holding the TRK button

You can perform seek tuning.

Using advanced functions

- Touch  on the "AM" screen.

The "Function" menu appears.

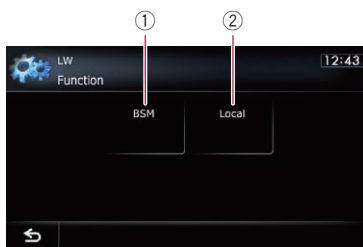

- ① **Stores the strongest broadcast frequencies**

- ② **Tunes in strong signals**

- ➔ For details of each function, refer to sections below with the relative titles.

Storing the strongest broadcast frequencies

BSM (best stations memory) lets you automatically store the six strongest broadcast frequencies under the preset tuning keys "P1" to "P6" and, once stored there, you can tune into them with the touch of a key.

- Storing broadcast frequencies with BSM may replace broadcast frequencies you have already saved.

1 Touch on the "AM" screen.

The "Function" menu appears.

2 Touch [BSM].

3 Touch [Start] to begin a search.

"BSM" begins to flash. While "BSM" is flashing, the six strongest broadcast frequencies will be stored under the preset tuning keys "P1" to "P6" in order of their signal strength. When this is complete, "BSM" stops flashing.

- If you touch [Stop], the storage process is cancelled.

Tuning in strong signals

Local seek tuning allows you to tune in only those radio stations with sufficiently strong signals for good reception.

Using the radio (AM)

1 Touch on the "AM" screen.

The "Function" menu appears.

2 Touch [Local].

3 Touch [On] to turn local seek tuning on.

- If you touch [Off], local seek tuning is turned off.

4 Touch [◀Prev] or [Next▶] to set the sensitivity.

There are two levels of sensitivity for MW/LW.

Level: **1** — **2**

- The level "2" setting allows reception of only the strongest stations, while lower settings let you receive weaker stations. □

You can play a normal music CD using the built-in drive of the navigation system. This section describes how.

Starting procedure

1 Display the AV operation screen.

- For details of the operations, refer to *Displaying the AV operation screen* on page 70.

2 Insert the disc you want to play into disc-loading slot.

Playback starts from the first track of the CD.

- For details, refer to *Inserting and ejecting a disc* on page 15.
- ❑ If the disc is already set, tap [Disc] on the left edge of the screen.
- For details, refer to *Selecting a source* on page 70.

3 Use the touch panel keys on the screen to control the disc.

- For details, refer to *Using the touch panel keys* on the next page.

Reading the screen

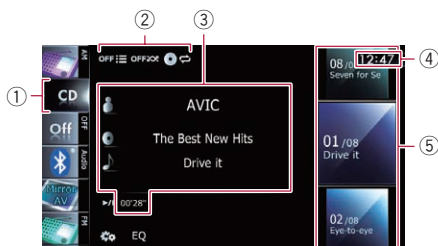

① Source icon

Shows which source has been selected.

② Playback condition indicator

Indicates the current playback condition.

Scanning tracks of a CD

Indicator	Meaning
	Cancels the scan play.
	Plays the beginning of each track in the current repeat play range for about 10 seconds.

Playing tracks in random order

Indicator	Meaning
	Does not play tracks in random order.
	Plays all tracks in the current disc in random order.

Setting a repeat play range

Indicator	Meaning
	Repeats the current disc.
	Repeats just the current track.

③ Current track information

- : **Artist name**
Shows the artist name of the track currently playing (when available).
- : **Album title**
Shows the title of the album of the current track (when available).
- : **Track title**
Shows the title of the track currently playing (when available).
- **Play time**
Shows the elapsed playing time within the current track.
 "-----" is displayed if there is no corresponding information.

④ Current time

⑤ Track information

- **Track number indicator**
Shows the track number and the total number of tracks in the current repeat range.
- **Track title indicator**

Using the touch panel keys



① Scans tracks of a CD

Scan play is performed by touching only one key.

➔ For details of the operation, refer to **Scans tracks of a CD** on the next page.

② Plays tracks in random order

All of the tracks in the disc can be played at random by touching only one key.

➔ For details of the operation, refer to **Plays tracks in random order** on the next page.

③ Sets a repeat play range

The repeat play range can be changed by touching only one key.

➔ For details, refer to **Changes the repeat range** on the next page.

④ Selects a track to play

Scrolling the keys up or down displays tracks, and tapping a track starts playback.

Tapping the lower key during random playback skips to the next track. Tapping the upper key jumps to the start of the current track.

⑤ Recalls equaliser curves

➔ For details, refer to **Using the equaliser** on page 152.

⑥ Displays the “Function” menu

➔ For details, refer to **Using advanced functions** on the next page.

⑦ Playback and Pause

Touching [▶/⏸] switches between playback and pause.

⑧ Selects a track from the list

Touching the key displays the list which lets you see the list of track titles on a disc. You can play a track on the list by tapping it.



☐ “-----” is displayed if there is no corresponding information.

➔ For details, refer to **Operating list screens** (e.g. iPod list screen) on page 70.

⑨ Switches the media file type played

➔ For details, refer to **Switches the media file type played** on page 90. ☐

Operating by hardware buttons

Pressing the TRK button

You can skip tracks forward or backward.

Pressing and holding the TRK button

You can perform fast reverse or fast forward.

Using advanced functions

- Touch  on the "CD" screen.

The "Function" menu appears.

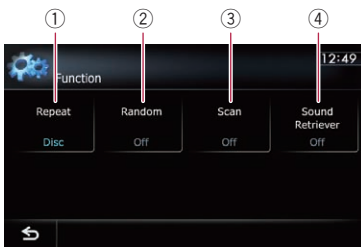

① Changes the repeat range

Each touch of **[Repeat]** changes the setting as follows:

- **Disc:** Repeats the current disc.
 - **Track:** Repeats just the current track.
- If you perform track search or fast forward or reverse, track repeat playback is automatically cancelled.

② Plays tracks in random order

Each touch of **[Random]** turns it on or off.

- If you turn the random play on when the repeat play range is set to "Track", the repeat play range changes to "Disc" automatically.

③ Scans tracks of a CD

Each touch of **[Scan]** turns it on or off. Scan play lets you hear the first 10 seconds of each track on the CD. When you find the track you want, touch **[Scan]** to turn scan play off.

- After scanning is finished, normal playback of the tracks will begin again.

- If you turn the scan play on when the repeat play range is set to "Track", the repeat play range changes to "Disc" automatically.

④ Uses "Sound Retriever" function

"Sound Retriever" function automatically enhances compressed audio and restores rich sound.

Each touch of **[Sound Retriever]** changes the setting as follows:

- **MODE 1:** Activates "Sound Retriever" function.
- **MODE 2:** Activates "Sound Retriever" function.
- **Off:** Deactivates "Sound Retriever" function.

- "MODE 2" has a stronger effect than "MODE 1" and is more effective when playing back highly compressed audio data.

Playing music files on ROM

You can play a disc that contains compressed audio files using the built-in drive of the navigation system. This section describes these operations.

- In the following description, the MP3, WMA, AAC files are collectively referred to as “Compressed audio file”.

Starting procedure

1 Display the AV operation screen.

- ➔ For details of the operations, refer to *Displaying the AV operation screen* on page 70.

2 Insert the disc you want to play into disc-loading slot.

Playback starts from the first file of the ROM.

- ➔ For details, refer to *Inserting and ejecting a disc* on page 15.
- If the disc is already set, tap [Disc] on the left edge of the screen.
- ➔ For details, refer to *Selecting a source* on page 70.

3 Use the touch panel keys on the screen to control the disc.

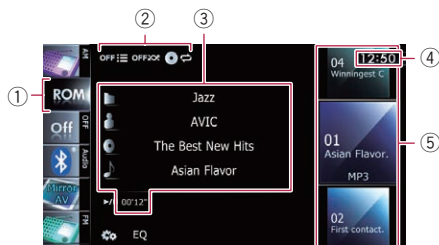

- ➔ For details concerning operations, refer to *Using the touch panel keys* on page 89. 

Reading the screen





- ① **Source icon**
Shows which source has been selected.
- ② **Playback condition indicator**
Indicates the current playback condition.



Scanning folders and files

Indicator	Meaning
	Cancels the scan play.
	Plays the first audio files of each folder for about 10 seconds when the repeat range is set to “Disc”. Plays the beginning of each audio file in the current folder for about 10 seconds when the repeat range is set to “Folder”.





Playing files in random order

Indicator	Meaning
	Does not play files in random order.
	Plays all audio files in the current repeat play range in random order.

Setting a repeat play range

Indicator	Meaning
	Repeats all compressed audio files.
	Repeats just the current file.
	Repeats the current folder.

③ Current file information

-  **Folder name**
Shows the folder name currently playing.
-  **Artist name**
Shows the artist name currently playing (when available).
-  **Album title**
Shows the title of the album of the current file (when available).
-  **Track title**
Shows the title of the track currently playing (when available).
□ If the title of a track is not available, the file name appears.
- **Play time**
Shows the elapsed playing time within the current file.

□ "-----" is displayed if there is no corresponding information.

④ **Current time**

⑤ **File information**

- **File number indicator**
- **File name indicator**
- **File type indicator**

Shows the type of audio files. □

Playing music files on ROM

Using the touch panel keys

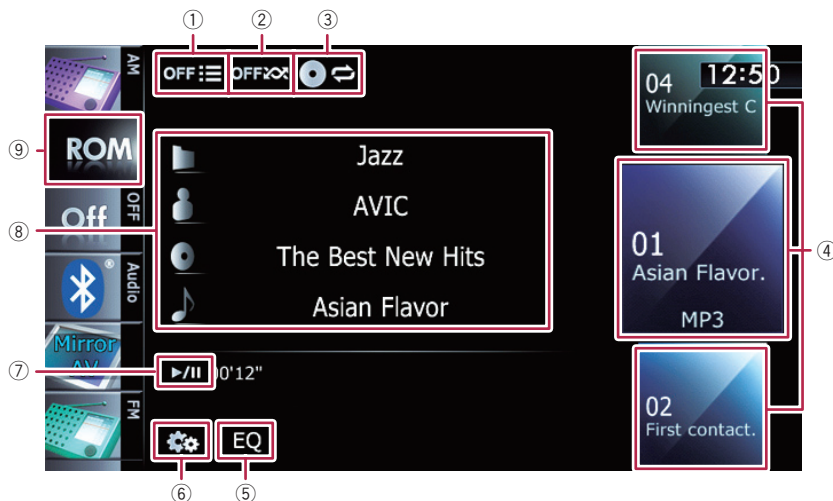

① Scans folders and files

Scan play is performed by touching only one key.

➔ For details of the operation, refer to **Scans folders and files** on the next page.

② Plays files in random order

The files in the current repeat play range can be played at random by touching only one key.

☐ If the disc contains a mixture of various media file types, all tracks or files within the current part ("CD" or "ROM") are played randomly.

➔ For details, refer to **Plays files in random order** on the next page.

③ Sets a repeat play range

The repeat play range can be changed by touching only one key.

➔ For details, refer to **Changes the repeat range** on the next page.

④ Selects a file to play

Scrolling the keys up or down displays files, and tapping a file starts playback.

Tapping the lower key during random playback skips to the next file. Tapping the upper key jumps to the start of the current file.

⑤ Recalls equaliser curves

➔ For details, refer to *Using the equaliser* on page 152.

⑥ Displays the "Function" menu

➔ For details, refer to *Using advanced functions* on the next page.

⑦ Playback and Pause

Touching [▶/⏸] switches between playback and pause.

⑧ Selects a file from the list

Touching the key displays the list which lets you see the list of track titles or folder names on a disc.

☐ If the title of a track is not available, the file name appears.

Tapping a folder on the list shows its content. You can play a file on the list by tapping it.

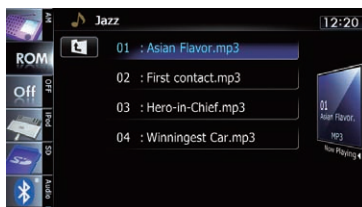

➤ For details, refer to *Operating list screens* (e.g. *iPod list screen*) on page 70.

Touching **[L]** displays the content of the upper folder (parent folder). If the uppermost folder is listed, **[L]** cannot be used.

⑨ Switches the media file type played

When playing a disc containing a mixture of various media file types, you can switch between media file types to play.

Tap the key repeatedly to switch between the following media file types:

CD (audio data (CD-DA)) — **ROM** (compressed audio file) — **DivX** (DivX video files) **[M]**

Operating by hardware buttons

Pressing the TRK button

You can skip files forward or backward.

Pressing and holding the TRK button

You can perform fast reverse or fast forward. **[M]**

Using advanced functions

● Touch **[F]** on the "ROM" screen.

The "Function" menu appears.

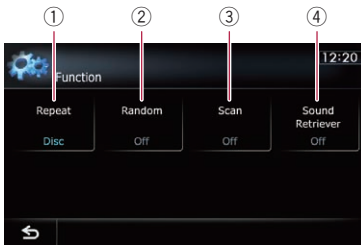

① Changes the repeat range

Each touch of **[Repeat]** changes the setting as follows:

- **Disc**: Repeats all compressed audio files.
- **Track**: Repeats just the current file.

- **Folder**: Repeats the current folder.

- If you select another folder during repeat play, the repeat play range changes to "**Disc**".

- If you perform fast reverse or fast forward during "**Track**", the repeat play range changes to "**Folder**".

- When "**Folder**" is selected, it is not possible to playback a subfolder of that folder.

- When playing discs with compressed audio files and audio data (CD-DA), repeat play is performed within the currently playing data session even if "**Disc**" is selected.

② Plays files in random order

Each touch of **[Random]** turns it on or off. When the random play is turned on, the files in the current repeat play range are randomly played.

- If you turn the random play on when the repeat play range is set to "**Track**", the repeat play range changes to "**Folder**" automatically.

③ Scans folders and files

Scan play lets you hear the first 10 seconds of each file. Scan play is performed in the current repeat play range.

Each touch of **[Scan]** turns it on or off.

When you find the file you want, touch **[Scan]** to turn the scan play off.

- After completion of file or folder scanning, normal playback of the files will begin again.

- If you turn the scan play on when the repeat play range is set to "**Track**", the repeat play range changes to "**Folder**" automatically.

- If you turn the scan play on while the repeat play range is set to "**Disc**", scan play is performed for only the first file of each folder.

④ Uses "Sound Retriever" function

"**Sound Retriever**" function automatically enhances compressed audio and restores rich sound.

Each touch of [**Sound Retriever**] changes the setting as follows:

- **MODE 1**: Activates "**Sound Retriever**" function.
- **MODE 2**: Activates "**Sound Retriever**" function.
- **Off**: Deactivates "**Sound Retriever**" function.
- ☐ **"MODE 2"** has a stronger effect than "**MODE 1**" and is more effective when playing back highly compressed audio data. ☐

You can play a DVD-Video using the built-in drive of the navigation system. This section describes operations for playing a DVD-Video.

Starting procedure

1 Display the AV operation screen.

- ➔ For details of the operations, refer to *Displaying the AV operation screen* on page 70.

2 Insert the disc you want to play into disc-loading slot.

The source changes and then playback will start.

- ➔ For details, refer to *Inserting and ejecting a disc* on page 15.
- If the disc is already set, tap [Disc] on the left edge of the screen.
- ➔ For details, refer to **Selecting a source** on page 70.

3 Use the touch panel keys on the screen to control the disc.

- ➔ For details, refer to *Using the touch panel keys* on the next page. □

④ Audio channel indicator

Shows the current audio channel type, such as "Mch" (Multi-channel).

⑤ Subtitle number indicator

Shows the subtitle number currently selected.

⑥ Subtitle language indicator

Shows the subtitle language currently selected.

⑦ Viewing angle indicator

Shows what viewing angle has been selected.

⑧ Current time

⑨ Digital sound format indicator

Shows which digital sound format (surround sound format) has been selected.

⑩ Play time indicator

Shows the elapsed playing time within the current title.

⑪ Source icon

Shows which source has been selected. □

Reading the screen



① Title number indicator

Shows the title number currently playing.

② Audio track indicator

Shows the audio track number and audio language currently selected.

③ Chapter number indicator

Shows the chapter number currently playing.

Playing a DVD-Video

Using the touch panel keys

Playback screen (page 1)

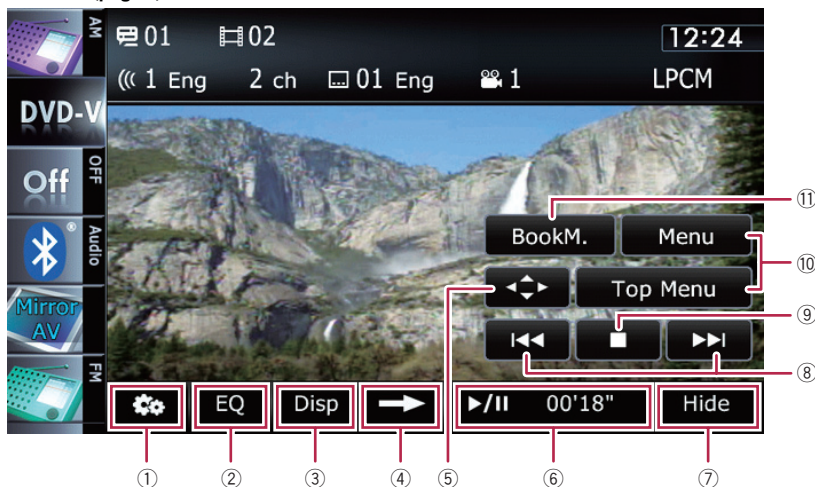

Playback screen (page 2)

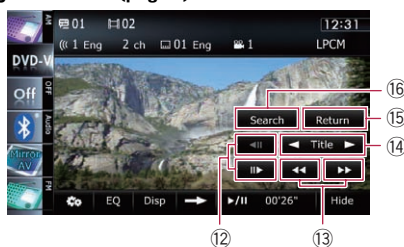

Playback screen (page 3)

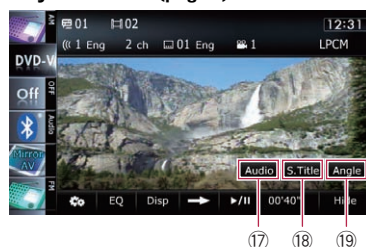

- ❑ With some discs, the icon  may be displayed, meaning that the operation is invalid.

- ① **Displays the “Function” menu**
 - ➔ For details, refer to *Using advanced functions* on page 96.
- ② **Recalls equaliser curves**
 - ➔ For details, refer to *Using the equaliser* on page 152.
- ③ **Switches the display**

Touching [**Disp**] changes the indication on the information plate as follows:

Disc information display — Repeat range and L/R select display

- ④ **Switches to the next page of touch panel keys**

- ⑤ **Displays the DVD menu keypad**
 - ➔ For details, refer to *Using DVD menu by touch panel keys* on page 95.

- ⑥ **Playback and Pause**

Touching [**▶/||**] switches between playback and pause.

- ⑦ **Hides the touch panel keys and information of the current video**

Touching [**Hide**] shows only the current video.

- ❑ If you want to display the touch panel keys and information of the current video again, touch anywhere on the LCD screen.

Playing a DVD-Video

⑧ Skips forward or backward

Touching [▶▶] skips to the start of the next chapter. Touching [◀◀] once skips to the start of the current chapter. Touching it twice quickly will skip to the previous chapter.

⑨ Stops playback

⑩ Displays the DVD menu

You can display the menu by touching [Menu] or [Top Menu] while a disc is playing. Touching either of these keys again lets you start playback from the location selected from the menu. For details, refer to the instructions provided with the disc.

⑪ Resumes playback (Bookmark)

➡ For details, refer to *Resuming playback (Bookmark)* on this page.

⑫ Frame-by-frame playback (or slow-motion playback)

➡ For details, refer to *Frame-by-frame playback* on page 96.

➡ For details, refer to *Slow motion playback* on page 96.

⑬ Fast reverse or forward

Touch and hold [◀◀] or [▶▶] to perform fast reverse or forward.

If you keep touching [◀◀] or [▶▶] for five seconds, fast reverse/fast forward continues even if you release either of these keys. To resume playback at a desired point, touch [▶/||] or opposite key of [◀◀] or [▶▶] which you touched.

⑭ Skips the title forward or backward

Touching [▶] skips to the start of the next title. Touching [◀] skips to the start of the previous title.

⑮ Performs an operation (such as resuming) that is stored on the disc

When using a DVD that has a point recorded that indicates where to return to, the DVD returns to the specified point and begins playback from that point.

⑯ Searches for a desired scene and starts playback from a specified time

➡ For details, refer to *Searching for a specific scene and starting playback from a specified time* on the next page.

⑰ Changes the audio track (Multi-audio)

Each touch of [Audio] switches between audio tracks recorded in the disc.

- ❑ DTS audio format cannot be output, so select an audio track other than DTS audio format.
- ❑ Display indications such as **MPEG-A** and **Mch** describe the audio track recorded on the DVD. This indication may not be the same as the actual sound currently output from the navigation system.

⑱ Changes the subtitle (Multi-subtitle)

Each touch of [S.Title] switches between the subtitle languages recorded on the disc.

⑲ Changes the viewing angle (Multi-angle)

Each touch of [Angle] switches between viewing angles.

- ❑ During playback of a scene shot from multiple angles, the angle icon  is displayed. Turn the angle icon display on or off using the "DVD/DivX® Setup" menu.
- ➡ For details, refer to *Setting the angle icon display* on page 102.

Resuming playback (Bookmark)

The Bookmark function lets you resume playback from a selected scene the next time the disc is loaded.

● Touch [BookM.].



You can bookmark one point for each of up to five discs. If you try to memorise another point for the same disc, the older bookmark will be overwritten by the newer one.

- ❑ To clear the bookmark on a disc, touch and hold [BookM.].

Playing a DVD-Video

Searching for a specific scene and starting playback from a specified time

You can search for the scene you want by specifying a title or a chapter, and the time.

- Chapter search and time search are not available when disc playback has been stopped.

1 Touch [Search] and then touch [Title] (title), [Chapter] (chapter), [Time] (time).

2 Touch the keys to input the target number or time and then touch [Enter].

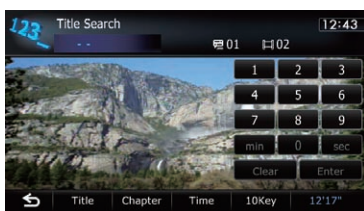

For titles, chapters

- To select 3, touch [3] and [Enter] in order.
- To select 10, touch [1] and [0] and [Enter] in order.

For time (time search)

- To select 5 minutes 3 seconds, touch [5], [min], [3], [sec] and [Enter] in order.
- To select 71 minutes 00 seconds, touch [7], [1], [min] and [Enter] in order.
- To select 100 minutes 05 seconds, touch [1], [0], [0], [5], [sec] and [Enter] in order.
- To cancel an input number, touch [Clear]. To cancel the input numbers, touch and hold [Clear].

Direct number search

You can use this function when you need to enter a numerical command during DVD playback.

1 Touch [Search].



2 Touch [10Key].

3 Touch [0] to [9] to input the desired number.

4 While the input number is displayed, touch [Enter].

Operating the DVD menu

You can operate the DVD menu by touching the menu item on the screen directly.

- This function can be used when the  key is displayed on the lower right corner of the LCD screen.
- This function may not work properly with some DVD disc content. In that case, use touch panel keys to operate the DVD menu.
- If you touch the screen while  is displayed, the touch panel keys will not be displayed.

1 Touch the screen to display the touch panel keys.

2 Touch [Top Menu] or [Menu] to display touch panel keys to operate the DVD menu.

3 Touch the desired menu item.

- If you touch , the touch panel keys for selecting the menu item are displayed.

Using DVD menu by touch panel keys

If items on the DVD menu appear, the touch panel keys may overlay them. If so, select an item using those touch panel keys.

1 Touch [▲], [▼], [◀] or [▶] to select the desired menu item.



- ❑ If the touch panel keys for DVD menu selection disappear, touching anywhere on the screen, then touch . The touch panel keys are displayed again.

2 Touch [Enter].

Playback starts from the selected menu item. The way to display the menu differs depending on the disc.

- If you touch [Position], the display position of touch panel keys is changed each time you touch it.
- If you touch [Hide], the touch panel keys disappear and the  icon is displayed. You can select a menu item by touching it.

Frame-by-frame playback

This lets you move ahead one frame at a time during pause.

● Touch [II▶] during pause.

Each time you touch [II▶], you move ahead one frame.

- ❑ To return to normal playback, touch [▶/II].
- ❑ With some discs, images may be unclear during frame-by-frame playback.

Slow motion playback

This lets you slow down playback speed.

1 Touch and hold [II▶] until is displayed during playback.

The icon  is displayed, and forward slow motion playback begins.

- ❑ To return to normal playback, touch [▶/II].

2 Touch [◀II] or [II▶] to adjust playback speed during slow motion playback.

Each time you touch [◀II] or [II▶] it changes the speed in four steps in the following order:

1/16 ↔ 1/8 ↔ 1/4 ↔ 1/2

- ❑ There is no sound during slow motion playback.
- ❑ With some discs, images may be unclear during slow motion playback.

- ❑ Reversed slow motion playback is not possible. 

Operating by hardware buttons

Pressing the TRK button

You can skip chapters forward or backward.

Pressing and holding the TRK button

You can perform fast reverse or fast forward. 

Using advanced functions

● Touch on the "DVD-V" screen.

The "Function" menu appears.

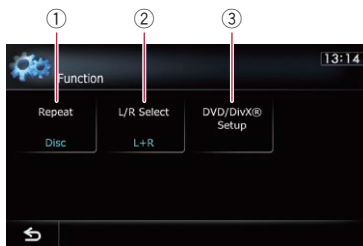

① Changes the repeat range

Each touch of [Repeat] changes the setting as follows:

- **Disc:** Plays throughout the current disc.
- **Chapter:** Repeats just the current chapter.
- **Title:** Repeats just the current title.
- ❑ If you perform chapter (title) search, fast forward, fast reverse or slow motion playback, the repeat play range changes to "Disc".
- ❑ This function is not available when disc playback has been stopped.

② Selects audio output

When playing DVDs recorded with LPCM audio, you can switch the audio output. Touch [L/R Select] repeatedly until the desired audio output appears on the display.

Playing a DVD-Video

Each touch of **[L/R Select]** changes the settings as follows:

- **L+R:** Left and right
 - **L:** Left
 - **R:** Right
 - **Mix:** Mixing left and right
- This function is not available when disc playback has been stopped.

③ DVD setup adjustments

- ➔ For details, refer to *Displaying DVD/DivX® Setup menu* on page 102.

You can play a DivX disc using the built-in drive of the navigation system. This section describes those operations.

Starting procedure

1 Display the AV operation screen.

- For details of the operations, refer to *Displaying the AV operation screen* on page 70.

2 Insert the disc you want to play into disc-loading slot.

The source changes and then playback will start.

- For details, refer to *Inserting and ejecting a disc* on page 15.
- ☐ If the disc is already set, tap [Disc] on the left edge of the screen.
- For details, refer to **Selecting a source** on page 70.

3 Use the touch panel keys on the screen to control the disc.

- For details, refer to *Using the touch panel keys* on the next page. ◻

④ Audio channel indicator

Shows the current audio channel type, such as "Mch" (Multi-channel).

⑤ Subtitle number indicator

Shows the subtitle number currently selected.

⑥ Repeat range indicator

Shows which repeat range has been selected.
➤ For details, refer to **Changes the repeat range** on page 101.

⑦ Current time

⑧ Digital sound format indicator

Shows the digital sound format (surround sound format) currently selected.

⑨ Play time indicator

Shows the elapsed playing time within the current file.

⑩ Source icon

Shows which source has been selected. ◻

Reading the screen

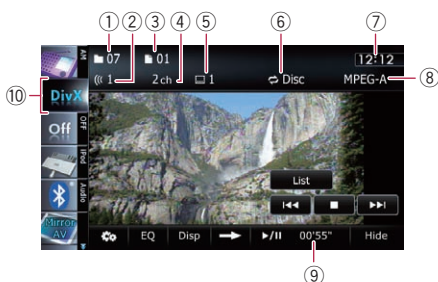

① Folder number indicator

Shows the folder number currently playing.

② Audio track indicator

Shows the audio track number currently selected.

③ File number indicator

Shows the file number currently playing.

Playing a DivX video

Using the touch panel keys

Playback screen (page 1)

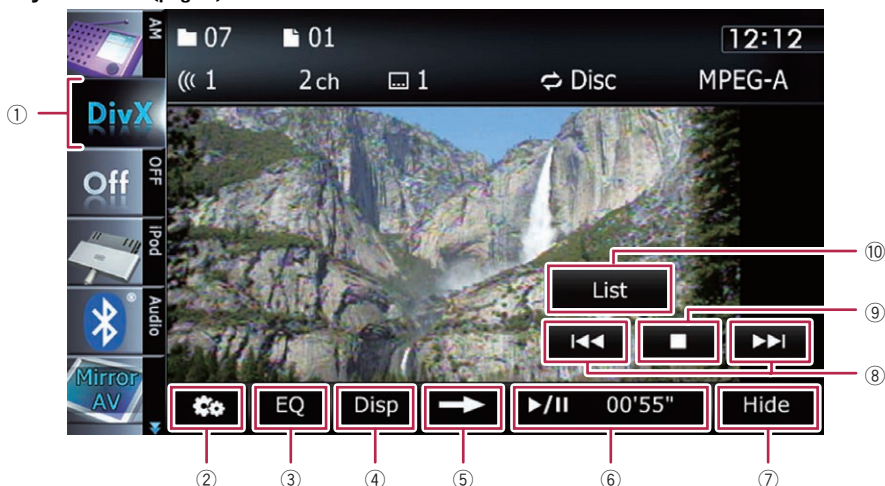

Playback screen (page 2)

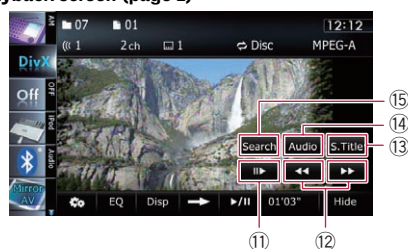

- ❑ With some discs, the icon  may be displayed, meaning that the operation is invalid.

① Switches the media file type played

When playing a disc containing a mixture of various media file types, you can switch between media file types to play.

Tap the key repeatedly to switch between the following media file types:

CD (audio data (CD-DA)) — **ROM** (compressed audio file) — **DivX** (DivX video files)

② Displays the “Function” menu

➔ For details, refer to *Using advanced functions* on page 101.

③ Recalls equaliser curves

- ➔ For details, refer to *Using the equaliser* on page 152.

④ Switches the information

Touching [**Disp**] changes the content of the information panel as follows:

Disc information display — Current folder name display

⑤ Switches to the next page of touch panel keys

⑥ Playback and Pause

Touching [**▶/||**] switches between playback and pause.

⑦ Hides the touch panel keys and information of the current video

Touching [**Hide**] shows only the current video.

Playing a DivX video

- ❑ If you want to display the touch panel keys and information of the current video again, touch anywhere on the LCD screen.

⑧ Skips forward or backward

Touching [▶▶] skips to the start of the next file. Touching [◀◀] once skips to the start of the current file. Touching it twice quickly will skip to the previous file.

⑨ Stops playback

When [■] is touched once to stop playback, playback can be resumed from the stopped position. When [■] is touched two times to stop playback, playback returns to the beginning.

⑩ Selects a file from the list

Touching the key displays the list which lets you find file names or folder names on a disc.

- ❑ A dash (-) is displayed if there is no corresponding information.

Tapping a folder on the list shows its content. You can play a file on the list by tapping it.



- For details, refer to *Operating list screens* (e.g. *iPod list screen*) on page 70.

The contents of the folder in which the currently playing file is located are displayed. Touching [⏏] displays the content of the upper folder (parent folder). If the uppermost folder is listed, [⏏] cannot be used.

⑪ Frame-by-frame playback (or slow-motion playback)

- For details, refer to *Frame-by-frame playback* on this page.

- For details, refer to *Slow motion playback* on this page.

⑫ Fast reverse or forward

Touch and hold [◀◀] or [▶▶] to perform fast reverse or forward.

If you keep touching [◀◀] or [▶▶] for five seconds, fast reverse/fast forward continues even if you release either of these keys. To resume playback at a desired point, touch [▶/||] or opposite key of [◀◀] or [▶▶] which you touched.

⑬ Changes the subtitle (Multi-subtitle)

Each touch of [S.Title] switches between the subtitle languages recorded on the disc.

⑭ Changes audio tracks (Multi-audio)

Each touch of [Audio] switches between audio tracks.

⑮ Searches for a desired scene and starts playback from a specified time

- For details, refer to *Starting playback from a specified time* on the next page.

Frame-by-frame playback

This lets you move ahead one frame at a time during pause.

● Touch [||▶] during pause.

Each time you touch [||▶], you move ahead one frame.

- ❑ To return to normal playback, touch [▶/||].
- ❑ With some discs, images may be unclear during frame-by-frame playback.

Slow motion playback

This lets you slow down playback speed.

● Touch and hold [||▶] until ▶▶ is displayed during playback.

The icon ▶▶ is displayed, and forward slow motion playback begins.

- ❑ To return to normal playback, touch [▶▶] or [◀◀], etc.
- ❑ There is no sound during slow motion playback.
- ❑ With some discs, images may be unclear during slow motion playback.
- ❑ Reversed slow motion playback is not possible.

Playing a DivX video

Starting playback from a specified time

You can search for a desired scene by specifying the time.

- Time search is not possible when disc playback has been stopped.

1 Touch [Search].

2 Touch the keys to input the target number or time and then touch [Enter].

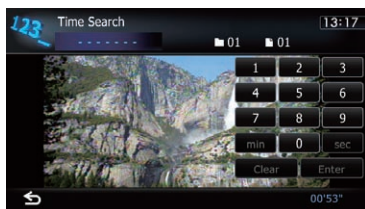

- To select 5 minutes 3 seconds, touch [5], [min], [3], [sec] and [Enter] in order.
- To select 71 minutes 00 seconds, touch [7], [1], [min] and [Enter] in order.
- To select 100 minutes 05 seconds, touch [1], [0], [0], [5], [sec] and [Enter] in order.
- To cancel an input number, touch [Clear]. To cancel the input numbers, touch and hold [Clear].

Operating by hardware buttons

Pressing the TRK button

You can skip files forward or backward.

Pressing and holding the TRK button

You can perform fast reverse or fast forward.

Using advanced functions

- Touch  on the "DivX" screen.

The "Function" menu appears.

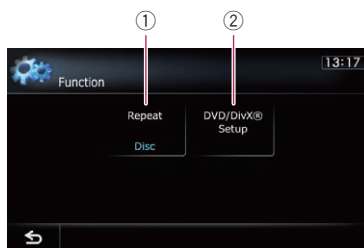

① Changes the repeat range

Each touch of [Repeat] changes the setting as follows:

- **Disc:** Plays throughout the current disc.
- **File:** Repeats just the current file.
- **Folder:** Repeats just the current folder.
- If you select another folder during repeat play, the repeat play range changes to "Disc".
- If you perform fast reverse or fast forward during "File", the repeat play range changes to "Folder".
- When "Folder" is selected, it is not possible to playback a subfolder of that folder.
- When playing discs with compressed audio files and audio data (CD-DA), repeat play is performed within DivX videos even if "Disc" is selected.

② DVD setup adjustments

- ➔ For details, refer to *Displaying DVD/DivX® Setup menu* on the next page.

This chapter describes how to configure the DVD-Video/DivX player.

Displaying DVD/DivX® Setup menu

1 Play the disc that contains DVD-Video or DivX.

2 Display the AV operation screen.

- For details of the operations, refer to *Displaying the AV operation screen* on page 70.

3 Touch .

The “Function” menu appears.

4 Touch [DVD/DivX® Setup].

The “DVD/DivX® Setup” screen appears.

5 Touch the desired function.



Setting the top-priority languages

You can assign the top-priority language to the top-priority subtitle, audio and menu in initial playback. If the selected language is recorded on the disc, subtitles, audio and menu are displayed or output in that language.

1 Display the “DVD/DivX® Setup” screen.

- For details, refer to *Displaying DVD/DivX® Setup menu* on this page.

2 Touch [Subtitle Language], [Audio Language] or [Menu Language].

Each language menu is displayed and the currently set language is selected.

3 Touch the desired language.

When you select “Others”, a language code input display is shown. Input the four-digit code of the desired language then touch [Enter].

- For details, refer to *Language code chart for DVDs* on page 105.
- ☐ If the selected language is not recorded on the disc, the default language specified on the disc is output and displayed.
- ☐ You can also switch the subtitle and audio language by touching [S.Title] or [Audio] during playback. Even if you touch [S.Title] or [Audio] to switch the subtitle or audio language, this setting will not change. 

Setting the angle icon display

You can set the angle icon  to display in scenes where the angle can be switched.

1 Display the “DVD/DivX® Setup” screen.

- For details, refer to *Displaying DVD/DivX® Setup menu* on this page.

2 Touch [Multi Angle].

Each time you touch the key changes the setting.

- **On** (default):
Displays the angle icon in scenes where the angle can be switched.
- **Off**:
Hides the angle icon. 

DVD-Video or DivX setup

Setting the aspect ratio

There are two kinds of displays. A wide screen display has a width-to-height ratio (TV aspect) of 16:9, while a regular display has a TV aspect of 4:3. If you use a regular rear display with a TV aspect of 4:3, you can set the aspect ratio suitable for your rear display. (We recommend use of this function only when you want to fit it to the rear display.)

- When using a regular display, select either "**Letter Box**" or "**Panscan**". Selecting "**16:9**" may result in an unnatural image.



1 Display the "DVD/DivX® Setup" screen.

- ➔ For details, refer to *Displaying DVD/DivX® Setup menu* on the previous page.

2 Touch [TV Aspect].

Each touch of [TV Aspect] changes the setting as follows:

- **16:9:** Wide screen image (16:9) is displayed as it is (initial setting).
- **Letter Box:** The image is in the shape of a letter box with black bands at the top and bottom of the screen.
- **Panscan:** The image is cut short at the right and left of the screen.

- When playing discs that do not have a panscan system, the disc is played back with "**Letter Box**" even if you select "**Panscan**" setting. Confirm whether the disc package bears the  mark.
- Some discs do not enable changing of the TV aspect. For details, refer to the disc's instructions. 

Setting the parental lock

Some DVD-Video discs let you use parental lock to set restrictions so that children cannot watch violent or adult-oriented scenes. You can set the parental lock level in steps as desired.

- When you set a parental lock level and then play a disc featuring parental lock, code number input indications may be dis-

played. In this case, playback will begin when the correct code number is input.

Setting the code number and level

When you first use this function, register your code number. If you do not register a code number, parental lock will not operate.

1 Display the "DVD/DivX® Setup" screen.

- ➔ For details, refer to *Displaying DVD/DivX® Setup menu* on the previous page.

2 Touch [Parental Level].

3 Touch [0] to [9] to input a four-digit code number.



4 While the input number is displayed, touch [Enter].

The code number is registered, and you can now set the level.

5 Touch any of [1] to [8] to select the desired level.

The parental lock level is set.

- **Level 8:** Playback of the entire disc is possible (initial setting).
- **Level 7 to Level 2:** Playback of discs for children and non-adult oriented discs is possible.
- **Level 1:** Only playback of discs for children is possible.
- If you want to change the parental level already set, enter the registered code number and then select the parental level.
- We recommend that you keep a record of your code number in case you forget it.
- The parental lock level is recorded on the disc. You can confirm it by looking at the disc package, the included literature or the disc itself. You cannot use parental lock with discs that do not feature a recorded parental lock level.
- With some discs, parental lock operates to skip certain scenes only, after which normal playback resumes. For details, refer to the disc's instructions.

- ❑ If you forget the registered code number, touch  10 times on the number input screen. The registered code number is cancelled, letting you register a new one. 

Setting the auto play

When a DVD disc with DVD menu is inserted, this unit will cancel the DVD menu automatically and start playback from the first chapter of the first title.

- ❑ This function is available for DVD-Video.
- ❑ Some DVDs may not operate properly. If this function is not fully operable, turn this function off and start playback.

1 Display the “DVD/DivX® Setup” screen.

- ➔ For details, refer to *Displaying DVD/DivX® Setup menu* on page 102.

2 Touch [Auto Play].

Each touch of [Auto Play] changes the settings as follows:

- **Off** (default):
Deactivates the auto play function.
- **On**:
Activates the auto play function.
- ❑ When “Auto Play” is set to “On”, the repeat range is automatically set to “Disc”. 

Setting the subtitle file for DivX

You can select whether to display DivX external subtitles or not.

- ❑ If no DivX external subtitle files exist, the original DivX subtitles are displayed even when “Custom” is selected.

1 Display the “DVD/DivX® Setup” screen.

- ➔ For details, refer to *Displaying DVD/DivX® Setup menu* on page 102.

2 Touch [Subtitle File].

Touching [Subtitle File] switches this setting between “Original” and “Custom”.

- ❑ Up to 42 characters can be displayed on one line. If more than 42 characters are set, the line breaks and the characters are displayed on the next line.
- ❑ Up to 126 characters can be displayed on one screen. If more than 126 characters are set, the excess characters will not be displayed.
- ❑ The DivX subtitles will be displayed even when the subtitle file setting is on if no corresponding subtitle files exist.
- ❑ Up to three subtitle lines can be displayed at once. 

DVD-Video or DivX setup

Language code chart for DVDs

Two-letter code, input code	Language	Two-letter code, input code	Language	Two-letter code, input code	Language
aa, 0101	Afar	ia, 0901	Interlingua	rn, 1814	Rundi
ab, 0102	Abkhazian	ie, 0905	Interlingue	ro, 1815	Romanian
af, 0106	Afrikaans	ik, 0911	Inupiaq	ru, 1821	Russian
am, 0113	Amharic	in, 0914	Indonesian	rw, 1823	Kinyarwanda
ar, 0118	Arabic	is, 0919	Icelandic	sa, 1901	Sanskrit
as, 0119	Assamese	it, 0920	Italian	sd, 1904	Sindhi
ay, 0125	Aymara	ja, 1001	Japanese	sg, 1907	Sango
az, 0126	Azerbaijani	ji, 1009	Yiddish	sh, 1908	Serbo-Croatian
ba, 0201	Bashkir	jw, 1023	Javanese	si, 1909	Sinhala
be, 0205	Belarusian	ka, 1101	Georgian	sk, 1911	Slovak
bg, 0207	Bulgarian	kk, 1111	Kazakh	sl, 1912	Slovenian
bh, 0208	Bihari	kl, 1112	Kalaallisut	sm, 1913	Samoan
bi, 0209	Bislama	km, 1113	Central Khmer	sn, 1914	Shona
bn, 0214	Bengali	kn, 1114	Kannada	so, 1915	Somali
bo, 0215	Tibetan	ko, 1115	Korean	sq, 1917	Albanian
br, 0218	Breton	ks, 1119	Kashmiri	sr, 1918	Serbian
ca, 0301	Catalan	ku, 1121	Kurdish	ss, 1919	Swati
co, 0315	Corsican	ky, 1125	Kirghiz; Kyrgyz	st, 1920	Sotho, Southern
cs, 0319	Czech	la, 1201	Latin	su, 1921	Sundanese
cy, 0325	Welsh	ln, 1214	Lingala	sv, 1922	Swedish
da, 0401	Danish	lo, 1215	Lao	sw, 1923	Swahili
de, 0405	German	lt, 1220	Lithuanian	ta, 2001	Tamil
dz, 0426	Dzongkha	lv, 1222	Latvian	te, 2005	Telugu
ee, 0505	Ewe	mg, 1307	Malagasy	tj, 2007	Tajik
el, 0512	Greek	mi, 1309	Maori	th, 2008	Thai
en, 0514	English	mk, 1311	Macedonian	ti, 2009	Tigrinya
eo, 0515	Esperanto	ml, 1312	Malayalam	tk, 2011	Turkmen
es, 0519	Spanish	mn, 1314	Mongolian	tl, 2012	Tagalog
et, 0520	Estonian	mo, 1315	Moldavian	tn, 2014	Tswana
eu, 0521	Basque	mr, 1318	Marathi	to, 2015	Tonga
fa, 0601	Persian	ms, 1319	Malay	tr, 2018	Turkish
fi, 0609	Finnish	mt, 1320	Maltese	ts, 2019	Tsonga
fj, 0610	Fijian	my, 1325	Burmese	tt, 2020	Tatar
fo, 0615	Faroese	na, 1401	Nauru	tw, 2023	Twi
fr, 0618	French	ne, 1405	Nepali	uk, 2111	Ukrainian
fy, 0625	Western Frisian	nl, 1412	Dutch; Flemish	ur, 2118	Urdu
ga, 0701	Irish	no, 1415	Norwegian	uz, 2126	Uzbek
gd, 0704	Gaelic	oc, 1503	Occitan	vi, 2209	Vietnamese
gl, 0712	Galician	om, 1513	Oromo	vo, 2215	Volapuk
gn, 0714	Guarani	or, 1518	Oriya	wo, 2315	Wolof
gu, 0721	Gujarati	pa, 1601	Panjabi; Punjabi	xh, 2408	Xhosa
ha, 0801	Hausa	pl, 1612	Polish	yo, 2515	Yoruba
hi, 0809	Hindi	ps, 1619	Pushto; Pashto	zh, 2608	Chinese
hr, 0818	Croatian	pt, 1620	Portuguese	zu, 2621	Zulu
hu, 0821	Hungarian	qu, 1721	Quechua		
hy, 0825	Armenian	rm, 1813	Romansh		



You can play the compressed audio files stored in the external storage device (USB, SD).

- In the following description, the SD memory card and USB memory device are collectively referred to as the “external storage device (USB, SD)”. If it indicates the USB memory device only, it is referred to as the “USB storage device”.

Starting procedure

1 Display the AV operation screen.

- ➔ For details of the operations, refer to *Displaying the AV operation screen* on page 70.

2 Insert the SD memory card into the SD card slot or plug the USB storage device into the USB connector.

- ➔ For details, refer to *Plugging in a USB storage device* on page 20.
- ➔ For details, refer to *Inserting and ejecting an SD memory card* on page 17.

- Playback is performed in order of folder numbers. Folders are skipped if they contain no playable files. If there are no playable files in folder 01 (root folder), playback starts from folder 02.

3 Tap [USB] or [SD] on the left edge of the screen to display the “USB” or “SD” screen.

4 Use the touch panel keys on the screen to control the external storage device (USB, SD).

- ➔ For details, refer to *Using the touch panel keys (Music)* on page 108. □

Reading the screen

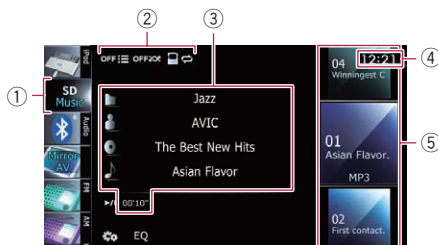

- This unit may not achieve optimum performance with some external storage devices.
- You can playback the files on a USB storage device compliant with Mass Storage Class. For details about the USB Class, refer to the manual supplied with the USB storage device.

① Source icon

Shows which source has been selected.

② Playback condition indicator

Indicates the current playback condition.

Scanning folders and files



Indicator	Meaning
	<p>Cancels the scan play.</p>
	<p>Plays the first audio files of each folder for about 10 seconds when the repeat range is set to “Media”.</p> <p>Plays the beginning of each audio file in the current folder for about 10 seconds when the repeat range is set to “Folder”.</p>

Playing files in random order





Indicator	Meaning
	Does not play files in random order.
	Plays all audio files in the current repeat play range in random order.

Playing music files (from USB or SD)

Setting a repeat play range

Indicator	Meaning
	Repeats all compressed audio files in the selected external storage device (USB, SD).
	Repeats just the current file.
	Repeats the current folder.

③ Current file information

-  **Folder name**
Shows the folder name currently playing.
-  **Artist name**
Shows the artist name currently playing (when available).
-  **Album title**
Shows the title of the album of the current file (when available).
-  **Track title**
Shows the title of the track currently playing (when available).
 If the title of a track is not available, the file name appears.
- **Play time**
Shows the elapsed playing time within the current file.
 "-----" is displayed if there is no corresponding information.

④ Current time

⑤ File information

- **File number indicator**
- **File name indicator**
- **File type indicator**
Shows the type of audio files.

Using the touch panel keys (Music)

**① Scans folders and files**

Scan play is performed by touching only one key.

➔ For details of the operation, refer to **Scans folders and files** on the next page.

② Plays files in random order

The files in the current repeat play range can be played at random by touching only one key.

➔ For details of the operation, refer to **Plays files in random order** on the next page.

③ Sets a repeat play range

The repeat play range can be changed by touching only one key.

➔ For details, refer to **Changes the repeat range** on the next page.

④ Selects a file to play

Scrolling the keys up or down displays files, and tapping a file starts playback.

Tapping the lower key during random playback skips to the next file. Tapping the upper key jumps to the start of the current file.

⑤ Recalls equaliser curves

➔ For details, refer to *Using the equaliser* on page 152.

⑥ Displays the “Function” menu

➔ For details, refer to *Using advanced functions* on the next page.

⑦ Playback and Pause

Touching [▶/⏸] switches between playback and pause.

⑧ Selects a file from the list

Touching the key displays the list which lets you find track titles or folder names on an external storage device (USB, SD). Tapping a folder on the list shows its content. You can play a file on the list by tapping it.

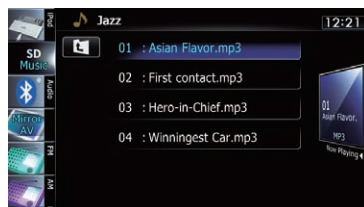

➔ For details, refer to *Operating list screens* (e.g. *iPod list screen*) on page 70.

Touching [⏪] displays the content of the upper folder (parent folder). If the uppermost folder is listed, [⏪] cannot be used.

Playing music files (from USB or SD)

⑨ Switches the operation screen

Tapping this key switches between the screen to operate music files and the screen to operate video files. This touch panel key is available only when there are both audio and video files in the external storage device (USB, SD). 

Operating by hardware buttons

Pressing the TRK button

You can skip files forward or backward.

Pressing and holding the TRK button

You can perform fast reverse or fast forward. 

Using advanced functions

- Touch  on the "USB" or "SD" screen. The "Function" menu appears.



① Changes the repeat range

Each touch of [**Repeat**] changes the setting as follows:

- **Media**: Repeats all compressed audio files in the selected external storage device (USB, SD).
 - **Track**: Repeats just the current file.
 - **Folder**: Repeats the current folder.
- If you skip the file forward or backward when the repeat play range in "Track", the repeat play range changes to "Folder".

② Plays files in random order

Random play lets you playback files in random order within the current repeat range. Each touch of [**Random**] turns it on or off.

- If you turn the random play on when the repeat play range is set to "Track", the repeat play range changes to "Folder" automatically.

③ Scans folders and files

Scan play lets you hear the first 10 seconds of each file. Scan play is performed in the current repeat play range.

Each touch of [**Scan**] turns it on or off.

When you find the file you want, touch [**Scan**] to turn the scan play off.

- After all files or folders scanning are finished, normal playback will begin again.
- If you turn the scan play on when the repeat play range is set to "Track", the repeat play range changes to "Folder" automatically. 

You can play the video files stored in the external storage device (USB, SD).

- ❑ In the following description, the SD memory card and USB memory device are collectively referred to as the “external storage device (USB, SD)”. If it indicates the USB memory device only, it is referred to as the “USB storage device”.

Starting procedure

1 Display the AV operation screen.

- ➔ For details of the operations, refer to *Displaying the AV operation screen* on page 70.

2 Insert the SD memory card into the SD card slot or plug the USB storage device into the USB connector.

- ➔ For details, refer to *Plugging in a USB storage device* on page 20.
- ➔ For details, refer to *Inserting and ejecting an SD memory card* on page 17.
- ❑ Playback is performed in order of folder numbers. Folders are skipped if they contain no playable files. If there are no playable files in folder 01 (root folder), playback starts from folder 02.

3 Tap [USB] or [SD] on the left edge of the screen to display the “USB” or “SD” screen.

4 Touch the screen to display the touch panel keys.

5 Use the touch panel keys on the screen to control the external storage device (USB, SD).

- ➔ For details, refer to *Using the touch panel keys (Video)* on the next page. 

Reading the screen

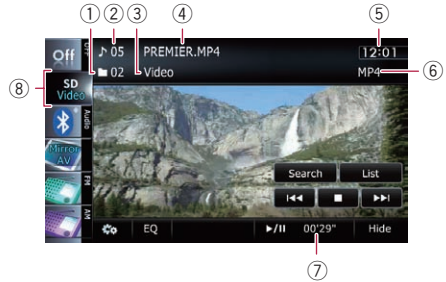

- ❑ This unit may not achieve optimum performance with some external storage devices.
- ❑ You can playback the files on a USB storage device compliant with Mass Storage Class. For details about the USB Class, refer to the manual supplied with the USB storage device.

① Folder number indicator

② File number indicator

③ Current folder name indicator

Shows the folder name currently playing.

④ File name indicator

Shows the file name currently playing.

⑤ Current time

⑥ File type indicator

Shows the type of audio file currently playing.

⑦ Play time indicator

Shows the elapsed playing time within the current file.

⑧ Source icon

Shows which source has been selected. 

Playing video files (from USB or SD)

Using the touch panel keys (Video)

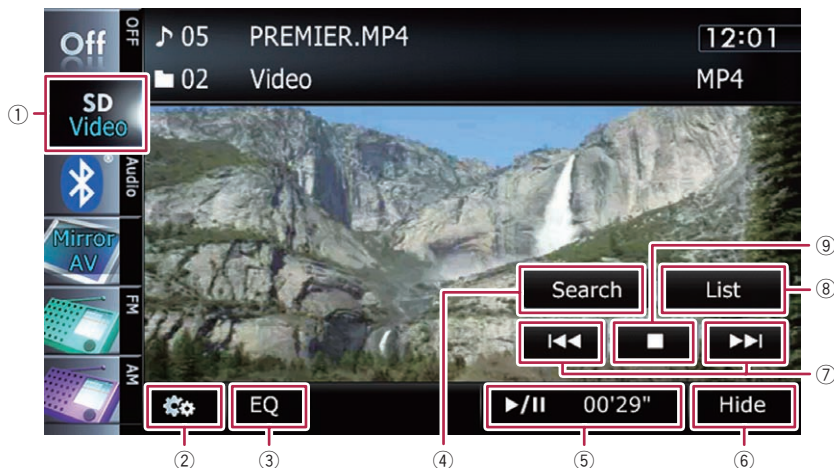

- ① **Switches the operation screen**
Tapping this key switches between the screen to operate music files and the screen to operate video files. This touch panel key is available only when there are both audio and video files in the external storage device (USB, SD).
- ② **Displays the "Function" menu**
➤ For details, refer to *Using advanced functions* on the next page.
- ③ **Recalls equaliser curves**
➤ For details, refer to *Using the equaliser* on page 152.
- ④ **Searches for a desired scene and starts playback from a specified time**
➤ For details, refer to *Searching for a specific scene and starting playback from a specified time* on the next page.
- ⑤ **Playback and Pause**
Touching [▶/||] switches between playback and pause.
- ⑥ **Hides the touch panel keys and information of the current video**
Touching [Hide] shows only the current video.
 If you want to display the touch panel keys and information of the current video again, touch anywhere on the LCD screen.
- ⑦ **Skips forward or backward**

Touching [▶▶] skips to the start of the next file. Touching [◀◀] once skips to the start of the current file. Touching it twice quickly will skip to the previous file.

Fast reverse or forward

Touch and hold [◀◀] or [▶▶] to fast reverse or fast forward.

- There is no sound on fast reverse or forward.

- ⑧ **Selects a file from the list**
You can select and play the title you want from the list.

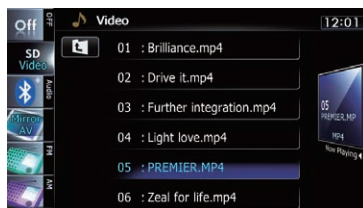

- For details, refer to *Operating list screens* (e.g. iPod list screen) on page 70.

The contents of the folder in which the currently playing file is located are displayed. Touching [◀] displays the content of the upper folder (parent folder). If the uppermost folder is listed, [◀] cannot be used.

⑨ Stops playback

Searching for a specific scene and starting playback from a specified time

You can search for a desired scene by specifying the time.

1 Touch [Search].

2 Touch the keys to input the target number or time and then touch [Enter].

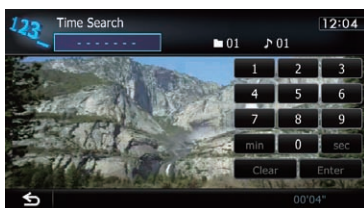

- To select 5 minutes 3 seconds, touch [5], [min], [3], [sec] and [Enter] in order.
- To select 71 minutes 00 seconds, touch [7], [1], [min] and [Enter] in order.
- To select 100 minutes 05 seconds, touch [1], [0], [0], [5], [sec] and [Enter] in order.
- To cancel an input number, touch [Clear]. To cancel the input numbers, touch and hold [Clear].

Operating by hardware buttons

Pressing the TRK button

You can skip files forward or backward.

Pressing and holding the TRK button

You can perform fast reverse or fast forward.

Using advanced functions

1 Tap [USB] or [SD] on the left edge of the screen to display the "USB" or "SD" screen.

- For details of the operations, refer to *Displaying the AV operation screen* on page 70.

2 Touch the screen to display the touch panel keys.

3 Touch .

The "Function" menu appears.

- If the touch panel keys are not shown, touch anywhere on the screen to display them.

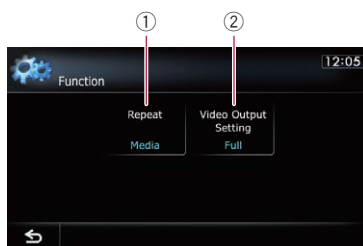

① Changes the repeat range

Each touch of [Repeat] changes the setting as follows:

- **Media:** Repeats all video files in the selected external storage device (USB, SD).
- **File:** Repeats just the current file.
- **Folder:** Repeats the current folder.
- If you skip the file forward or backward when the repeat play range in "File", the repeat play range changes to "Folder".

② Changes the screen size of video

If a video file is played, you can select the display mode between normal and full screen.

Each touch of [Video Output Setting] changes the setting as follows:

- **Normal:** Enlarges the display size while maintaining the aspect ratio.
- **Full:** Displays the image full-screen although the aspect ratio may be changed.

Using an iPod (iPod)

Using the USB interface cable for iPod enables you to connect your iPod to the navigation system.

- A USB interface cable for iPod (CD-IU51V) (sold separately) is required for connection.

Starting procedure

1 Display the AV operation screen.

- ➔ For details of the operations, refer to *Displaying the AV operation screen* on page 70.

2 Connect your iPod.

The source changes and then playback will start.

- ➔ For details, refer to *Connecting your iPod* on page 20.
- If the iPod is already connected, tap **[iPod]** on the left edge of the screen.
 - ➔ For details, refer to **Selecting a source** on page 70.
- If no video is output when iPod is selected as AV source, check the setting in "**AV1 Input**" on the "**AV System Settings**" menu.
 - ➔ For details, refer to *Setting video input 1 (AV1)* on page 148.

3 Use the touch panel keys on the screen to control your iPod.

- ➔ For details of the operation, refer to *Using the touch panel keys* on page 115. □

Reading the screen

Music

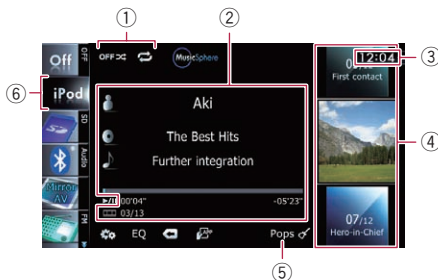

Video

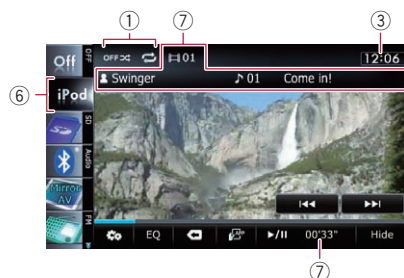

① Playback condition indicator

Indicates the current playback condition.

Setting the shuffle play

Indicator	Meaning
	Cancels the shuffle play.
	Plays back songs or videos in random order within the selected list.
	Selects an album randomly, and then plays back all songs in that album in order.
	The actions while this indicator is displayed on the video operation screen vary depending on the connected iPod.

Setting a repeat play range

Indicator	Meaning
	Repeats all songs or videos in the selected list.
	Repeats just the current song or video.

② Current song (episode) information

- : **Artist name (podcast title)**
Shows the artist name currently playing. When a podcast is played, the podcast title is displayed (when available).
- : **Album title (release date)**
Shows the title of the album for the song. When a podcast is played, the release date is displayed (when available).
- : **Song title (episode)**

Shows the title of the current song.
When a podcast is played, the episode is displayed (when available).

-  **Chapter number**
Shows the current chapter number and total number of chapters when the file with chapters played (when available).

- **Play time**
Shows the elapsed playing time within the current song (episode).
 "-----" is displayed if there is no corresponding information.

③ Current time

④ Song (episode) information

- **Song number indicator**
Shows the number of the song and the total number of songs in the selected list.
- **Song title (episode) indicator**
- **Album artwork**
Album art of the current song is displayed if it is available.



⑤ Genre indicator

Shows the genre of the current song.

⑥ Source icon

Shows which source has been selected.

⑦ Current video information

-  **Chapter number**
Shows the current chapter number when the video with chapters played (when available).
-  **Artist name (podcast title)**
Shows the artist name currently playing.
When a podcast is played, the podcast title is displayed (when available).
-  **File number indicator**
Shows the number of the file currently playing (when available).
- **File name indicator**
Shows the file name currently playing (when available).
- **Play time indicator**
Shows the elapsed playing time within the current file.
 "-----" is displayed if there is no corresponding information.

- If characters recorded on the iPod are not compatible with this navigation system, they may turn into garbled characters. 

Using an iPod (iPod)

Using the touch panel keys

Music

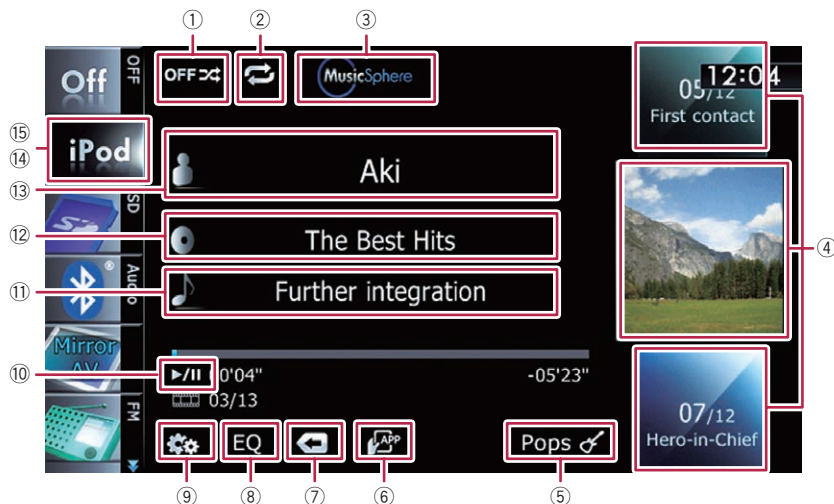

Video

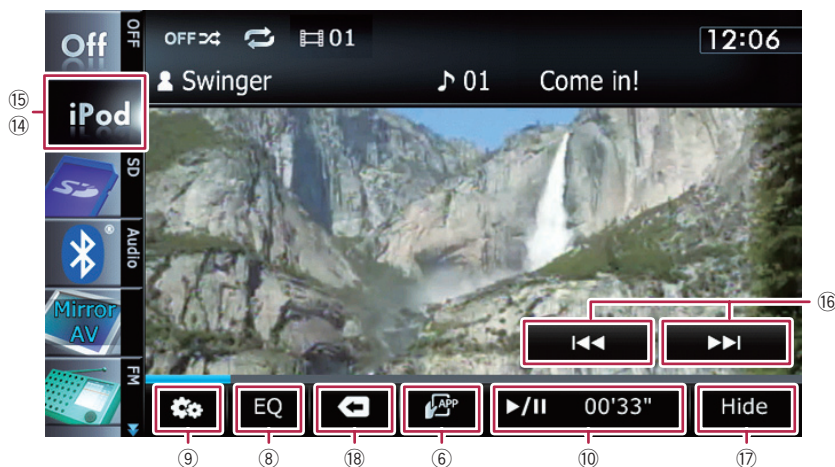

- ① **Sets the shuffle play for music**
The shuffle play setting can be changed by touching only one key.
➔ For details, refer to **Sets the shuffle play for music** on page 120.
- ② **Sets a repeat play range**

The repeat play range can be changed by touching only one key.

➔ For details, refer to **Sets repeat play** on page 119.

- ③ **Displays the "MusicSphere" screen**

Using an iPod (iPod)

Touching the key displays the **MusicSphere** screen, and a playlist created with the PC application (**MusicSphere**) can be played.

➔ For details, refer to *Playing MusicSphere* on page 119.

④ Selects a song to play

Scrolling the keys up or down displays songs, and tapping a song starts playback.

Tapping the lower key during shuffle playback skips to the next song. Tapping the upper key once skip to the start of the current song. Tapping it again will skip to the previous song. When the song with chapters played, chapter can be skipped back and forward.

⑤ Displays the genre list

⑥ Switches the control mode of iPod functions

Touching the key lets you control the functions of an iPod connected to the navigation system from the iPod.

➔ For details, refer to *Operating the functions from your iPod* on page 118.

⑦ Displays the top category menu

Touching the key displays the top category for song playback.

Displays the previously selected list

If you select the song from the list to play after touching , touching the key displays the previous list.

⑧ Recalls equaliser curves

➔ For details, refer to *Using the equaliser* on page 152.

⑨ Displays the "Function" menu

➔ For details, refer to *Using advanced functions* on page 119.

⑩ Playback and Pause

Touching  switches between playback and pause.

⑪ Displays the song list

⑫ Displays the album list

⑬ Displays the artist list

⑭ Switches the operation screen

Tapping this key displays the touch panel key (**[Video]** or **[Music]**) to switch between the screen to operate video files and the screen to operate music files.

➔ For details of the operation, refer to *Starting the video playback* on the next page.

❑ This touch panel key is available only when there are both audio and video file in your iPod.

❑ If iPod fifth generation is connected, the following settings are automatically changed when the operation screen is switched to the one to operate video files.

- "Repeat" is set to "All".
- "Shuffle" is set to "Off".

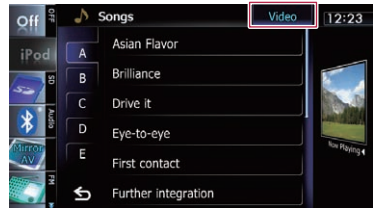

❑ Touching **[Video]** or **[Music]** on the list screens enables you to perform the equivalent operation.





⑮ Displays the top category menu





Touching the key displays the top category menu for song or video playback.

⑯ Skips back or forward to another video

Touching  skips to the start of the next video. Touching  once skips to the start of the current video. Touching again will skip to the previous video. When the video with chapters played, chapter can be skipped back and forward.

Fast reverse or forward



Touch and hold  or  to fast reverse or fast forward.

If you keep touching  or  for five seconds, fast reverse/fast forward continues even if you release either of these keys. To resume playback at a desired point, touch ,  or .

⑰ Hides the touch panel keys and information of the current video

Touching **[Hide]** shows only the current video.

Using an iPod (iPod)

- If you want to display the touch panel keys and information of the current video again, touch anywhere on the LCD screen.
- 18 **Displays the top category menu for video**
Touching the key displays the top category for video playback.
- Displays the previously selected list**
If you select the video from the list to play after touching , touching the key displays the previous list. .

Operating by hardware buttons

Pressing the TRK button

You can skip songs, videos or podcasts forward or backward.

When the song, video or podcast with chapter played, you can skip chapter forward or backward.

Pressing and holding the TRK button

You can perform fast reverse or fast forward. .

Starting the video playback

This navigation system can play video if an iPod with video capabilities is connected.

- 1 **Touch [iPod] on the left edge of the screen to display the touch panel key to switch to a video source.**
- 2 **Tap [Music].**

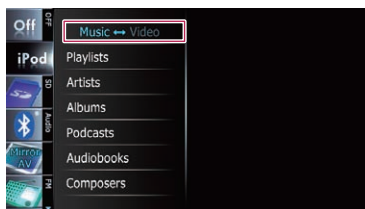

A list of videos by category appears.

- 3 **Tap one of the categories in that contains the video you want to play.**

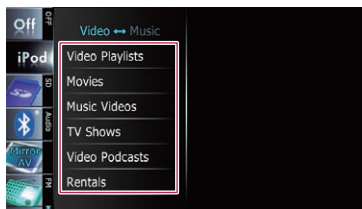

- 4 **Tap your desired item on the list to narrow down them until the video list appears.**

➤ For details, refer to *Narrowing down a song or video with the list* on this page.

- 5 **On the video list, tap the video you want to play.**

Video playback will start.

- 6 **Touch the screen to display the touch panel keys.**

➤ For details of the operation, refer to *Using the touch panel keys* on page 115. .

Narrowing down a song or video with the list

Tapping an item on list allows you to search for a song or video and play it in your iPod.

- 1 **Display a list screen.**
 - For details, refer to *Displays the genre list* on the previous page.
 - For details, refer to *Displays the song list* on the previous page.
 - For details, refer to *Displays the album list* on the previous page.
 - For details, refer to *Displays the artist list* on the previous page.
- If you touch , the top category menu screen is displayed. Tap the category of your preference.

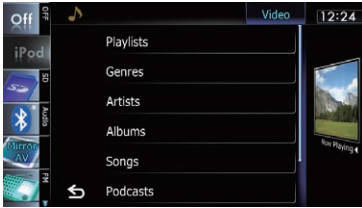

2 Scroll by dragging tabs up or down to display the character that you want to refine.

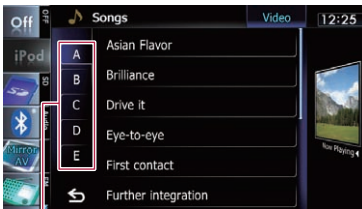

Character tabs

3 Tap the tab to select the character and display the page which includes applicable options.



- ❑ An article listed below and space at the beginning of the artist name will be ignored and the next character will be taken into account for searching.
 - “A” or “a”
 - “AN”, “An”, or “an”
 - “THE”, “The”, or “the”

4 Scroll the list by dragging items up or down to display the item you want to select.

Refine the item until the song title (episode) is displayed on the list.

- ❑ Tapping **[All]** on the list includes all options in the current list. For example, if you tap **[All]** after tapping **[Artists]**, you can proceed to the next screen with all artists in the list selected.
- ❑ After you select artists, albums, genres, podcasts, or composers, go on to touch and hold one of the list to start playing the first song in the selected list and display the next hierarchy.

5 On the song (episode) or video list, tap the song (episode) or video you want to play.

- ❑ After you select the song (episode) or video using this function, touching  displays the list previously selected. 

Operating the functions from your iPod

You can control the navigation system via the connected iPod. When you change the screen of the navigation system to “**Application Mode**”, sound is output from the speakers of your vehicle.

In the “**Application Mode**” screen, the following operations are available from this navigation system.

- Playback and Pause
- Fast reverse or forward
- Skip forward or backward
- Adjusting the volume
- Touch  to switch the mode.

The “**Application Mode**” screen appears.

- ➔ For details, refer to **Switches the control mode of iPod functions** on page 116.

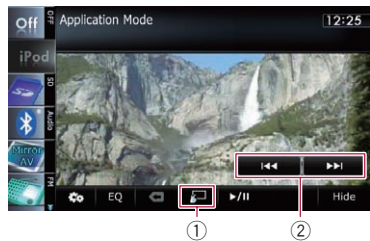

- ① Switches to the normal mode.
- ② Operates the iPod.

The operations activated by touching vary depending on the connected iPod. 

Using an iPod (iPod)

Playing MusicSphere

You can play playlists created with the PC application (**MusicSphere**) using an exciting graphic interface.

- ❑ PC application (**MusicSphere**) will be available on our website.

Starting procedure

1 Display the music operation screen of the iPod.

- For details of the operation, refer to *Starting procedure* on page 113.

2 Touch .

- For details of the operations, refer to *Displays the "MusicSphere" screen* on page 115.

Reading the screen

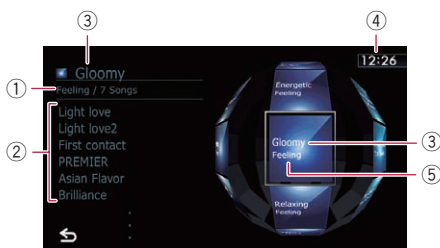

① Category name and total number of songs

Shows the category name and the total number of playable songs in the playlist currently selected.

② Song title indicator

Shows six songs including the first song played after selecting the playlist.

③ Playlist name indicator

Shows the name of the playlist currently selected.

④ Current time

⑤ Category name

Shows the category name in the playlist.

Using the touch panel keys

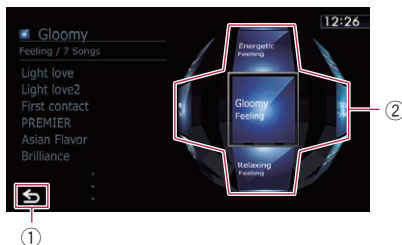

① Switches to the AV operation screen

② Plays the playlist

Tapping a key moves the playlist to the centre of the screen, and tapping the centre key starts playback.

- ❑ To change the playlist to be displayed, rotate the sphere by dragging the keys up, down, left, or right. 

Using advanced functions

● Touch on the "iPod" screen.

The "Function" menu appears.

- ❑ This menu is not available when you change the screen of the navigation system to "Application Mode".

- For details, refer to *Operating the functions from your iPod* on the previous page.

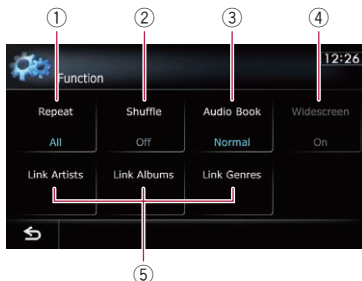

① Sets repeat play

There are two repeat play types for playback.

Each touch of [Repeat] changes the setting as follows:

Using an iPod (iPod)

- **All:** Repeats all songs or videos in the selected list.
- **One:** Repeats just the current song or video.

② Sets the shuffle play for music

This function shuffles songs or albums and plays them in random order.

Each touch of [**Shuffle**] changes the setting as follows:

- **Off:** Does not shuffle.
- **Songs:** Plays back songs or videos in random order within the selected list.
- **Albums:** Selects an album randomly, and then plays back all songs in that album in order.

③ Sets the audiobook play speed

While listening to an audiobook on iPod, playback speed can be changed.

Each touch of [**Audio Book**] changes the setting as follows:

- **Normal:** Playback in normal speed
- **Faster:** Playback faster than normal speed
- **Slower:** Playback slower than normal speed

④ Plays video in wide screen mode

If the video is compatible with wide screen format, set "**Widescreen**" to "**On**" in order to view the video image in the wide screen.

Each touch of [**Widescreen**] changes the setting as follows:

- **On:** Outputs the wide-screen video from an iPod.
- **Off:** Outputs the normal-sized video from an iPod.
- Display size is changed after you change "**Widescreen**" setting and select the video to play.
- This setting is available only during the video operation.

⑤ Plays songs related to the currently playing song

You can play songs related to the currently playing song, using of the following lists.

- **Link Artists:** Songs related to the currently playing artist will be played in the album order.
- **Link Albums:** Songs related to the currently playing album will be played.
- **Link Genres:** Songs related to the currently playing genre will be played in the artist order.

Using the Bluetooth audio player

You can control the Bluetooth audio player.

- ❑ Before using the Bluetooth audio player, you need to register and connect the device to this navigation system.
 - ➔ For details, refer to *Registering your Bluetooth devices* on page 55.
- ❑ Operations may vary depending on the kind of a Bluetooth audio player.
- ❑ Depending on the Bluetooth audio player connected to this navigation system, the available operations with this navigation system are limited to the following two levels:
 - A2DP profile (Advanced Audio Distribution Profile): Only playing back songs on your audio player is possible.
 - A2DP profile and AVRCP profile (Audio/Video Remote Control Profile): Playing back, pausing, selecting songs, etc., are possible.
- ❑ Since there are a number of Bluetooth audio players available on the market, operations with your Bluetooth audio player using this navigation system vary greatly in range. Please refer to the instruction manual that came with your Bluetooth audio player as well as this manual while operating your player on this navigation system.
- ❑ While you are listening to songs on your Bluetooth audio player, please refrain from operating your mobile phone as much as possible. If you try operating on your mobile phone, the signal from your mobile phone may cause a noise on the song playback.
- ❑ Even if you switch to another source while listening to a song on your Bluetooth audio player, the playback of song continues to elapse.
- ❑ Depending on the Bluetooth audio player you connected to this navigation system, operations on this navigation system to control the player may differ from those explained in this manual.
- ❑ When you are talking on a mobile phone connected to this unit via Bluetooth wireless technology, song playback from your

Bluetooth audio player connected to this unit may be paused.

Starting procedure

1 Display the AV operation screen.

- ➔ For details of the operations, refer to *Displaying the AV operation screen* on page 70.

2 Tap [Audio] on the left edge of the screen to display the "Audio" screen.

3 Use the touch panel keys on the screen to control the Bluetooth audio player.

- ➔ For details, refer to *Using the touch panel keys* on page 123. 



Reading the screen





① Playback condition indicator

Indicates the current playback condition if the connected Bluetooth audio player features AVRCP 1.3.

Playing files in random order



Indicator	Meaning
	Does not play files in random order.
	Plays all audio files in the current repeat play range in random order.

Setting a repeat play range

Indicator	Meaning
	Does not repeat.
	Repeats just the current file.
	Repeats all audio files in the Bluetooth audio player.

② Current file information

If the connected Bluetooth audio player features AVRCP 1.3, the following file information will be displayed.

-  **Artist name**
Shows the artist name currently playing (when available).
 -  **Album title**
Shows the title of the album of the current file (when available).
 -  **Track title**
Shows the title of the track currently playing (when available).
 - **Play time indicator**
Shows the elapsed playing time within the current file.
 - **File number indicator**
Shows the file number currently playing (when available).
- In the following cases, file information will only be displayed after a file starts or resumes playing:
- You connect the Bluetooth audio player compatible with AVRCP1.3, and operate the player to start playing.
 - You select another file when playback is paused.

③ Current time**④ Source icon**

Shows which source has been selected.

⑤ Device name indicator**⑥ Connection status indicator**

Shows whether the device featuring Bluetooth technology is connected or not.

Using the Bluetooth audio player

Using the touch panel keys



- ① **Plays files in random order**
All of the files within the repeat play range can be played at random by touching only one key.
 - This function is available only when the connected Bluetooth audio player features AVRCP 1.3.
 - ➔ For details, refer to **Plays files in random order** on the next page.
- ② **Sets a repeat play range**
The repeat play range can be changed by touching only one key.
 - This function is available only when the connected Bluetooth audio player features AVRCP 1.3.
 - ➔ For details, refer to **Changes the repeat range** on the next page.
- ③ **Playback and Pause**
Touching [▶] or [⏸] switches between playback and pause.
- ④ **Connects the Bluetooth audio player**
Touching [Connect] displays the connection standby screen and the navigation system waits for the Bluetooth wireless connection request.
- ⑤ **Recalls equaliser curves**

➔ For details, refer to *Using the equaliser* on page 152.

- ⑥ **Displays the "Function" menu**
➔ For details, refer to *Using advanced functions* on the next page. □

Operating by hardware buttons

Pressing the TRK button

You can skip files forward or backward.

Pressing and holding the TRK button

You can perform fast reverse or fast forward. □

Using advanced functions

❑ This menu is available only when the connected Bluetooth audio player features AVRCP 1.3.

● **Touch  on the "Audio" screen.**

The "Function" menu appears.

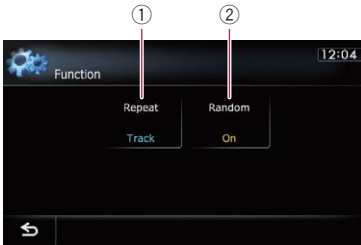

① **Changes the repeat range**

Each touch of [**Repeat**] changes the setting as follows:

- **All**: Repeats all audio files in the Bluetooth audio player.
- **Track**: Repeats just the current file.
- **Off**: Does not repeat.

❑ If you skip the file forward or backward when the repeat play range in "**Track**", the repeat play range changes to "**All**".

② **Plays files in random order**

Random play lets you playback files in random order within the current repeat range. Each touch of [**Random**] turns it on or off. ❑

Using AV input

You can display the video image output by the equipment connected to the navigation system. For details of the connection method, refer to Installation Manual.

! CAUTION

For safety reasons, video images cannot be viewed while your vehicle is in motion. To view video images, you must stop in a safe place and apply the handbrake.

Reading the screen



① **Current time**

② **Source icon**

Shows which source has been selected.

Using AV1

You can display the video image output by the equipment connected to video input 1.

1 Touch [AV1 Input] on the “AV System Settings” menu.

➔ For details, refer to *Setting video input 1 (AV1)* on page 148.

2 Display the AV operation screen.

➔ For details of the operations, refer to *Displaying the AV operation screen* on page 70.

3 Tap [AV1] on the left edge of the screen.

The image is displayed on the screen.

4 Touch the screen to display the touch panel keys.

Using AV2

You can display the video image output by the equipment connected to video input 2.

1 Touch [AV2 Input] on the “AV System Settings” menu.

➔ For details, refer to *Setting video input 2 (AV2)* on page 148.

2 Display the AV operation screen.

➔ For details of the operations, refer to *Displaying the AV operation screen* on page 70.

3 Tap [AV2] on the left edge of the screen.

The image is displayed on the screen.

4 Touch the screen to display the touch panel keys.

Using the touch panel keys

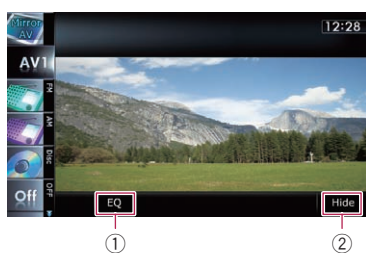

① **Recalls equaliser curves**

➔ For details, refer to *Using the equaliser* on page 152.

② **Hides the touch panel keys**

Touching [Hide] hides the touch panel keys.

If you want to display the touch panel keys again, touch anywhere on the LCD screen.

Displaying the screen for navigation settings

1 Press the HOME button to display the “Top Menu” screen.

2 Touch [Settings].

The “Settings Menu” screen appears.

- This can also be operated using the “Short-cut Menu” screen.

3 Touch [Navi Settings].

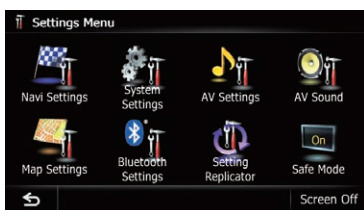

The “Navi Settings” menu appears.

4 Touch the item that you want to change the setting.

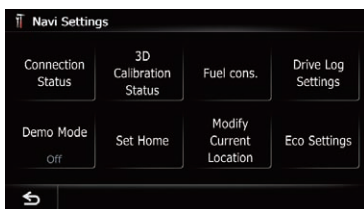

- If you touch , the previous screen returns.

Checking the connections of leads

Check that leads are properly connected between the navigation system and the vehicle. Please also check whether they are connected in the correct positions.

1 Display the “Navi Settings” screen.

- ➔ For details, refer to *Displaying the screen for navigation settings* on this page.

2 Touch [Connection Status].

The “Connection Status” screen appears.

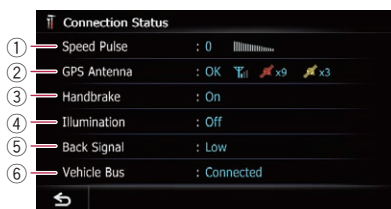

① **Speed Pulse**

The Speed Pulse value detected by the navigation system is shown. “0” is shown while the vehicle is stationary.

② **GPS Antenna**

Indicates the connection status of the GPS aerial, the reception sensitivity, and from how many satellites the signal is received.

Colour	Signal communication	Used in positioning
Orange	Yes	Yes
Yellow	Yes	No

- When the GPS aerial is connected to this navigation system, “OK” is displayed.
When the GPS aerial is not connected to this navigation system, “NOK” is displayed.
- If reception is poor, please change the installation position of the GPS aerial.

③ **Handbrake**

When the handbrake is applied, “On” is displayed. When the handbrake is released, “Off” is displayed.

④ **Illumination**

When the headlights or small lamps of a vehicle are on, “On” is displayed. When the small lamps of a vehicle are off, “Off” is displayed. (If the orange/white lead is not connected, “Off” appears.)

⑤ **Back Signal**

Customising preferences

When the gear lever is shifted to "R", the signal switches to "High" or "Low". (One of these is displayed depending on the vehicle.)

⑥ Vehicle Bus

When the optional Vehicle Bus adapter is connected, "Connected" is displayed. If not connected, "-" is displayed. 

Checking sensor learning status and driving status

- ❑ The navigation system can automatically use its sensor memory based on the outer dimensions of the tyres.

1 Display the "Navi Settings" screen.

- ➔ For details, refer to *Displaying the screen for navigation settings* on the previous page.

2 Touch [3D Calibration Status].

The "3D Calibration Status" screen appears.

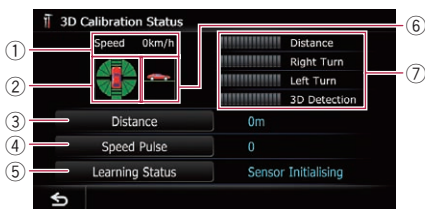

① Speed

Indicates the speed detected by the navigation system. (This indication may be different from the actual speed of your vehicle, so please do not use this instead of the speedometer.)

② Acceleration or deceleration/Rotational speed

Indicates acceleration or deceleration velocity of your vehicle. Also, rotational speed when your vehicle turns to left or right is shown.

③ Distance

Indicates driving distance.

④ Speed Pulse

Indicates the total number of speed pulses.

⑤ Learning Status

Indicates the current driving mode.

⑥ Inclination

Indicates the degree of slope of the street that you are currently on.

⑦ Degree of learning

Sensor learning situations for distance (**Distance**), right turn (**Right Turn**), left turn (**Left Turn**) and 3D detection (**3D Detection**) are indicated by the length of bars.

- ❑ When tyres have been changed or chains fitted, turning on the Speed Pulse allows the system to detect the fact that the tyre diameter has changed, and automatically replaces the value for calculating distance.
- ❑ If a separately sold speed pulse generator (ND-PG1) is connected, the distance calculation value cannot be replaced automatically.

Clearing status

You can delete the learned results stored in "Distance", "Speed Pulse" or "Learning Status".

1 Touch [Distance] or [Speed Pulse].

The following message appears.



2 Touch [Yes].

Clears the results stored in "Distance" or "Speed Pulse".

3 Touch [Learning Status].

The following message appears.



4 Touch [All].

Clears all leaning results.

- Touch **[All]** for the following cases:
 - After changing the installation position of the navigation system
 - After changing the installation angle of the navigation system
 - After moving the navigation system to another vehicle
- If you touch **[Distance]**, all learned results stored in "**Distance**" are cleared. □

Using the fuel consumption function

Inputting the fuel consumption information for calculating the fuel cost

You can estimate the fuel cost to your destination by entering the fuel consumption information in the navigation system.

➔ For details, refer to *Setting a route to your destination* on page 42.

1 Display the "Navi Settings" screen.

- ➔ For details, refer to *Displaying the screen for navigation settings* on page 126.

2 Touch [Fuel cons.].

The "**Fuel Mileage Setting**" screen appears.

3 Enter the fuel consumption information.



Enter the following items:

- **Surface Road Fuel Mileage:**
Enter the fuel cost when you drive on ordinary roads.
- **Motorway Fuel Mileage:**
Enter the fuel cost when you drive on the motorway.
- **Fuel Price Per Unit:**
Enter the fuel unit price.
- **Fuel Unit:**
Set the fuel unit.
- **Currency:**
Set the unit of currency.
- The unit in "**Surface Road Fuel Mileage**" and "**Motorway Fuel Mileage**" depend on the one chosen in "**Fuel Unit**".
 - When "**Fuel Unit**" is set to "**Litre**".
Enter how much fuel you need to travel 100 kilometres (60 miles).
 - When "**Fuel Unit**" is set to "**Gallon**".
Enter how many kilometres (miles) you get to a gallon.

When all the items are entered, inputting the fuel consumption information is complete.

Calculating the fuel consumption

When you enter the fuelling information to the navigation system, and export the data to SD memory cards, you can check the fuel consumption information by using the utility programme NavGate FEEDS, which is available separately, on your PC.

- Up to 24 sets of data can be stored. You can also export the data, as described below.

Customising preferences

If the entries reach the maximum number, a new entry will overwrite the oldest one.

These calculations are based only on the information that you provide and not on any data from the vehicle. The fuel mileage displayed is only a reference value, and does not guarantee the fuel mileage displayed can be obtained.

1 Display the "Navi Settings" screen.

- For details, refer to *Displaying the screen for navigation settings* on page 126.

2 Touch [Fuel cons.].

The "Fuel Mileage Setting" screen appears.

3 Touch [Fuel Price Calculation].



The "Fuel Price Calculation" screen appears.

4 Enter the fuel consumption information.

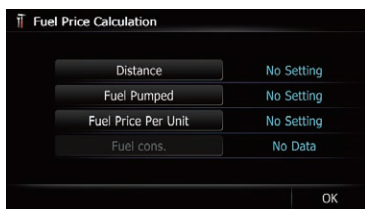

Enter the following items:

- **Distance:**
Enter the distance travelled since the previous fuelling.
 - The distance is entered automatically only when the distance travelled since the previous fuelling is recorded.
- **Fuel Pumped:**
Enter the amount of fuel pumped.

- **Fuel Price Per Unit:**

Enter the fuel unit price.

When all the items are entered, the fuel consumption is displayed next to "Fuel cons.".

5 Touch [OK].

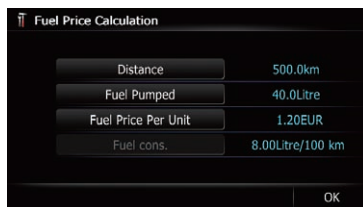

The "Fuel Mileage Setting" screen appears.

Exporting the data of fuel cost information

Exporting the fuel cost data to an SD memory card is possible.

- The data stored in this navigation system will be cleared as exporting it to the SD memory card.
- If there is previous data in the SD memory card, the data is overwritten with new data.

1 Insert an SD memory card into the SD card slot.

- For details of the operation, refer to *Inserting and ejecting an SD memory card* on page 17.

2 Display the "Navi Settings" screen.

- For details, refer to *Displaying the screen for navigation settings* on page 126.

3 Touch [Fuel cons.].

The "Fuel Mileage Setting" screen appears.

4 Touch [Export].



After a message confirming whether to export the data appeared, exporting the data to the SD memory card starts.

The “**Fuel Mileage Setting**” screen appears when it is done.

Recording your travel history

Activating the track logger enables you to record your driving history (called “track log” below). You can review the travel history later.

- If an SD memory card is inserted into the SD card slot, the track logs will be stored in the SD memory card.

1 Insert an SD memory card into the SD card slot.

- ➔ For details of the operation, refer to *Inserting and ejecting an SD memory card* on page 17.

2 Display the “Navi Settings” screen.

- ➔ For details, refer to *Displaying the screen for navigation settings* on page 126.

3 Touch [Drive Log Settings].

The “**Drive Log Settings**” screen appears.

4 Touch [Drive Log Settings].

Each time you touch the key changes the setting.

- **Off** (default):
You cannot export your track log to the SD memory card.
- **On**:
You can store your track log to the SD memory card.

- While the setting is “**On**”, the navigation system continues to store the track logs in the inserted SD memory card.

5 Touch [Type].

Each time you touch the key changes the setting.

- **Private** (default):
Changes the track log attribute to “**Private**”.
- **Business**:
Changes the track log attribute to “**Business**”.
- **Other**:
Changes the track log attribute to “**Other**”.

Using the demonstration guidance

This is a demonstration function for retail stores. After a route is set, touching this key starts the simulation of route guidance.

1 Display the “Navi Settings” screen.

- ➔ For details, refer to *Displaying the screen for navigation settings* on page 126.

2 Touch [Demo Mode].

Each time you touch the key changes the setting.

- **Off** (default):
The demonstration guidance is set off.
- **On**:
Repeats the demonstration guidance.

3 Display the map screen.

The demonstration guidance will begin.

Registering your home

Registering your home position saves time and effort. Also, routes to home positions can be calculated easily with a single touch of the key from the “**Destination Menu**”. The registered home position can also be modified later.

Customising preferences

1 Display the “Navi Settings” screen.

- For details, refer to *Displaying the screen for navigation settings* on page 126.

2 Touch [Set Home].

The “Set Home” screen appears.

3 Touch [Home].

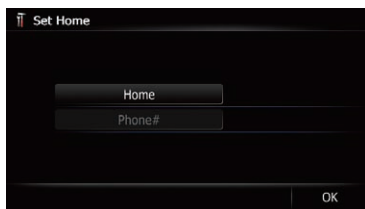

The “Select Search Method” screen appears.

- If you touch [Phone#], you can edit your home phone number.
 - [Phone#] is only available when you have already registered your home phone number.

4 Search for a location.

- For details, refer to Chapter 6.

After searching for a point, the map of the selected position is displayed.

5 Touch [OK].

The location is registered, and then the “Set Home” screen appears.

6 Touch [OK].

The registration is complete.

Correcting the current location

Touch the screen to adjust the current position and direction of the vehicle displayed on the map.

1 Display the “Navi Settings” screen.

- For details, refer to *Displaying the screen for navigation settings* on page 126.

2 Touch [Modify Current Location].

3 Scroll to the position where you want to set, then touch [OK].

4 Touch the arrow key on the screen to set the direction, then touch [OK].

Changing the eco-function setting

You can change the eco-function setting.

1 Display the “Navi Settings” screen.

- For details, refer to *Displaying the screen for navigation settings* on page 126.

2 Touch [Eco Settings].

The “Eco Settings” screen appears.

3 Touch each item.



Eco Score

- **On** (default): Displays “Eco Score”.
- **Off**: Hides “Eco Score”.
 - For details, refer to *Checking the eco-friendly driving status* on page 32.

Eco Drive Level

- **On** (default): After you arrive the destination, a message appears and a beep sounds if the level of “Eco Drive Level” have increased or decreased.
- **Off**: No message appears and no sound beeps when the vehicle reaches the destination.
 - For details, refer to *Displaying Eco Drive Level guidance* on page 33.

Rapid Start Warning

- **Off** (default):
No message appears and no sound beeps when the vehicle experiences a sudden start.
 - **On**:
A message appears and a sound beeps when the vehicle experiences a sudden start.
- ➔ For details, refer to *Sudden start alert* on page 33.

Clear Eco Record

Fuel consumption data are cleared.

4 Touch [OK].

The settings are complete.

Displaying the screen for map settings

1 Press the HOME button to display the “Top Menu” screen.

2 Touch [Settings].

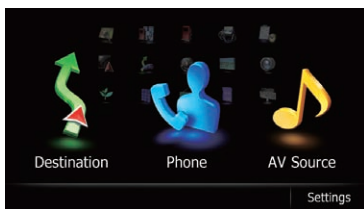

The “Settings Menu” screen appears.

3 Touch [Map Settings].

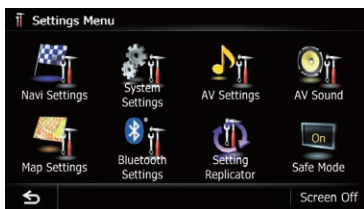

The “Map Settings” screen appears.

4 Touch the item that you want to change the setting.

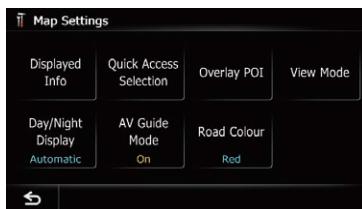

- If you touch , the previous screen returns.

Setting the auto-zoom display

This setting enables switching to an enlarged map around the point where your vehicle is approaching an intersection, entrance/exit of motorway or a junction.

1 Display the “Map Settings” screen.

- ➔ For details, refer to *Displaying the screen for map settings* on this page.

2 Touch [Displayed Info].

The “Displayed Information” screen appears.

3 Touch [Close Up View].

Each time you touch the key changes the setting.

- **On** (default):
Switches to an enlarged map.
- **Off**:
Does not switch to an enlarged map.

Setting the detailed city map

- The detailed city map and this setting are available for AVIC-F30BT only.

You can select whether to display the city map when in certain metropolitan city areas.

- The city map is displayed when the map scale is 50 metres (0.05 mile) or less.

Customising preferences

1 Display the "Map Settings" screen.

- For details, refer to *Displaying the screen for map settings* on the previous page.

2 Touch [Displayed Info].

The "Displayed Information" screen appears.

3 Touch [City Map].

Each time you touch the key changes the setting.

- **On** (default):
Automatically switches to the city map when in a city map area.
- **Off**:
Does not show the city map.
 - Even if you switch "City Map" to "On", city map cannot be displayed in areas where there is no city map data.

Setting the barrier graphic for city map

- The detailed city map and this setting are available for AVIC-F30BT only.

On the city map screen, you can display a "barrier graphic" pattern where no city map data is available. This prevents a normal map of a different scale from being displayed at the same time, greatly enhancing the clarity of the city map on screen.

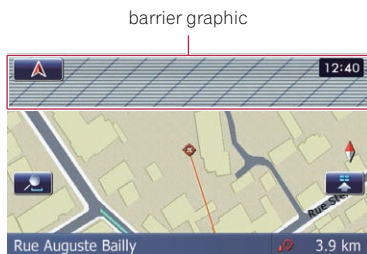

1 Display the "Map Settings" screen.

- For details, refer to *Displaying the screen for map settings* on the previous page.

2 Touch [Displayed Info].

The "Displayed Information" screen appears.

3 Touch [City Map Barrier].

Each time you touch the key switches between "On" and "Off".

- **On** (default):
Displays the barrier graphic for city map. When the vehicle position or cursor enters the barrier graphic area, the graphic disappears and a normal map is displayed full screen.
- **Off**:
Does not display the barrier graphic for city map. When the vehicle position or cursor enters the area where no city map data is available, a normal map is displayed full screen.

Setting the speed limit display

Selects whether to display or hide the speed limit of the current road.



Speed Limit

1 Display the "Map Settings" screen.

- For details, refer to *Displaying the screen for map settings* on the previous page.

2 Touch [Displayed Info].

The "Displayed Information" screen appears.

3 Touch [Show Speed Limit].

Each time you touch the key changes the setting.

- **Hide** (default):
Hides the speed limit on the map.
- **View**:
Displays the speed limit on the map.

Displaying the traffic notification icon

Selects whether to display or hide the traffic notification icons on the map when incidents occur on your route.

➔ For details, refer to *Checking traffic information manually* on page 53.

1 Display the “Map Settings” screen.

➔ For details, refer to *Displaying the screen for map settings* on page 132.

2 Touch [Displayed Info].

The “Displayed Information” screen appears.

3 Touch [Show Traffic Incident].

Each time you touch the key changes the setting.

- **View** (default):
Displays the icons on the map.
- **Hide:**
Hides the icons on the map.

Displaying the Bluetooth connection icon

Selects whether to display or hide the icon for current status of the phone connection via Bluetooth wireless technology.

Bluetooth connection icon



1 Display the “Map Settings” screen.

➔ For details, refer to *Displaying the screen for map settings* on page 132.

2 Touch [Displayed Info].

The “Displayed Information” screen appears.

3 Touch [Bluetooth Connected].

Each time you touch the key changes the setting.

- **View** (default):
Displays the Bluetooth connection icon on the map.
- **Hide:**
Hides the Bluetooth connection icon on the map.

Setting the current street name display

Selects whether to display or hide the street name (or city name) that your vehicle is traveling along.

1 Display the “Map Settings” screen.

➔ For details, refer to *Displaying the screen for map settings* on page 132.

2 Touch [Displayed Info].

The “Displayed Information” screen appears.

3 Touch [Current Street Name].

Each time you touch the key changes the setting.

- **View** (default):
Displays the street name (or city name) on the map.
- **Hide:**
Hides the street name (or city name) on the map.

Setting the display of icons of favourite locations

You can select whether to display the “Favourites” icon on the map.

- “Favourites” icons are displayed when the map scale is 20 kilometres (10 miles) or less.
- ➔ For details, refer to *Editing the favourite location in the list* on page 47.

Customising preferences

1 Display the “Map Settings” screen.

- For details, refer to *Displaying the screen for map settings* on page 132.

2 Touch [Displayed Info].

The “**Displayed Information**” screen appears.

3 Touch [Favourites Icon].

Each time you touch the key changes the setting.

- **On** (default):
Displays the “**Favourites**” icon on the map.
- **Off**:
Hides the “**Favourites**” icon on the map.

Displaying the 3D landmarks

- The 3D landmarks and this setting are available for AVIC-F30BT only.
- 3D landmark only appears when the view mode is “**3D View**” and the map scale is set to 200 m (0.25 mile) or lower.

You can select whether to display the 3D landmark on the map.

1 Display the “Map Settings” screen.

- For details, refer to *Displaying the screen for map settings* on page 132.

2 Touch [Displayed Info].

The “**Displayed Information**” screen appears.

3 Touch [3D Land Mark].

Each time you touch the key changes the setting.

- **On** (default):
Displays the 3D landmark on the map.
- **Off**:
Hides the 3D landmark on the map.

Displaying manoeuvres

Selects whether to display or hide manoeuvres on the map.



1 Display the “Map Settings” screen.

- For details, refer to *Displaying the screen for map settings* on page 132.

2 Touch [Displayed Info].

The “**Displayed Information**” screen appears.

3 Touch [Show Manoeuvre].

Each time you touch the key changes the setting.

- **View** (default):
Displays manoeuvres on the map.
- **Hide**:
Hides manoeuvres on the map.

Displaying the fuel consumption information

Selects whether to display Eco-Meter, indicating the fuel consumption information, on the map.

- Eco-Meter appears when “**2D View**” or “**3D View**” is selected.

1 Display the “Map Settings” screen.

- For details, refer to *Displaying the screen for map settings* on page 132.

2 Touch [Displayed Info].

The “**Displayed Information**” screen appears.

3 Touch [Show Eco Meter].

Each time you touch the key changes the setting.

- **View** (default):

Displays Eco-Meter on the map.

- **Hide:**
Hides Eco-Meter on the map.

Displaying POI on the map

Displays icons for the surrounding facilities (POI) on the map.

- POI icons are not displayed when the map scale is 1 kilometre (0.75 mile) or more.

Displaying preinstalled POIs on the map

- You can select up to 10 items from the subcategories or detailed categories.

1 Display the “Map Settings” screen.

- ➔ For details, refer to *Displaying the screen for map settings* on page 132.

2 Touch [Overlay POI].

The “Overlay POI” screen appears.

3 Touch [Display] to change the setting to “On”.

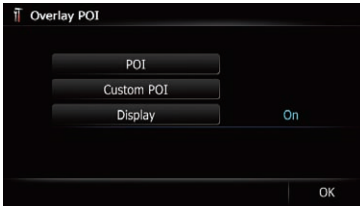

- If you do not want to display the POI icon on the map, touch **[Display]** to turn it “Off”. (Even if “Display” is turned “Off”, the POI selection setting is retained.)

4 Touch [POI].

The “Overlay POI (Main Category)” screen appears.

5 Touch the main category you want.



A list of subcategories under the selected main category appears.

- Categories that are already selected will have a blue tick mark.

6 Touch the subcategory to display.

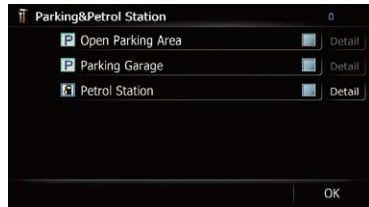

A red tick mark appears next to the selected category. To cancel the selection, touch the entry again.

If there are detailed categories within the subcategory, **[Detail]** is active. If you select the subcategory such, all detailed categories within the subcategory is selected and **[Detail]** becomes inactive.

- If you touch **[Detail]**, the detailed categories under the subcategory are displayed. Select a detailed category of your preference and touch **[OK]**.
 - When only a few detailed categories are selected, a blue tick mark will appear next to the selected subcategory.

7 Touch [OK].

The “Overlay POI (Main Category)” screen returns.

If you want to select or deselect other items, repeat these steps as many as necessary.

8 To finish the selection, touch [OK] in the “Overlay POI (Main Category)” screen.

Customising preferences

Displaying the customised POIs

Creating a customised POI is possible by using the utility programme NavGate FEEDS which is available separately, on your PC. (NavGate FEEDS will be available on our website.) Storing the customised POI properly and inserting the SD memory card enables the system to display the icons on the map screen.

- ❑ You can select up to 10 items from the sub-categories or detailed categories.

1 Insert an SD memory card into the SD card slot.

- ➔ For details of the operation, refer to *Inserting and ejecting an SD memory card* on page 17.

2 Display the “Map Settings” screen.

- ➔ For details, refer to *Displaying the screen for map settings* on page 132.

3 Touch [Overlay POI].

The “Overlay POI” screen appears.

4 Touch [Display] to change the setting to “On”.

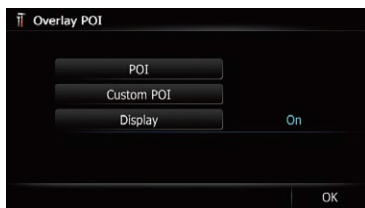

- ❑ If you do not want to display the POI icon on the map, touch [Display] to turn it “Off”. (Even if “Display” is turned “Off”, the POI selection setting is retained.)

5 Touch [Custom POI].

The list of POI categories appears.

6 Touch the items you want to display.



7 To finish the selection, touch [OK].

Changing the view mode

Various types of screen displays can be selected for navigation guidance.

- ➔ For details of the operation, refer to *Switching the view mode* on page 30.

Setting the map colour change between day and night

To improve the visibility of the map during the evening, you can set the timing for changing the combination of the map colour.

1 Display the “Map Settings” screen.

- ➔ For details, refer to *Displaying the screen for map settings* on page 132.

2 Touch [Day/Night Display].

Each time you touch the key changes the setting.

- **Automatic** (default):
You can change the colours of a map between daytime and nighttime according to whether the vehicle lights are on or off.
- **Day:**
The map is always displayed with daytime colours.
- ❑ To use this function with “Automatic”, the orange/white lead of the navigation system must be connected correctly.

Changing the road colour

You can set the road colour to bluish or red-dish.

1 Display the “Map Settings” screen.

- ➔ For details, refer to *Displaying the screen for map settings* on page 132.

2 Touch [Road Colour].

Each time you touch the key changes the setting.

- **Red** (default):
Changes to red based road colours.
- **Blue:**
Changes to blue based road colours. 

Changing the setting of navigation interruption screen

You can set whether to automatically switch to the navigation screen from the AV screen when your vehicle approaches a guidance point such as an intersection.

1 Display the “Map Settings” screen.

- ➔ For details, refer to *Displaying the screen for map settings* on page 132.

2 Touch [AV Guide Mode].

Each time you touch the key changes the setting.

- **On** (default):
Switches from the AV operation screen to the map screen.
- **Off:**
Does not switch the screen.
- This setting is effective only when “**Close Up View**” is set to “**On**”. 

Selecting the “Quick Access” menu

Select items to display on the map screen. In the list displayed on screen, the items with red tick marks are displayed on the map screen.

Touch the item you want to display and then touch **[OK]** when a red check appears. You can select up to five items.

1 Display the “Map Settings” screen.







- ➔ For details, refer to *Displaying the screen for map settings* on page 132.

2 Touch [Quick Access Selection].





The “**Quick Access Selection**” screen appears.

3 Touch the item that you want to set in “Quick Access”.

You can select the following items:

- Settings marked with an asterisk (*) show that these are default or factory settings.
-  **Registration***
Register information on the location indicated by the cursor to “**Favourites**”.
➔ For details, refer to *Registering a location by scroll mode* on page 47.
-  **Vicinity Search***
Find POIs (Points Of Interest) in the vicinity of the cursor.
➔ For details, refer to *Searching for a nearby POI* on page 39.
-  **Overlay POI***
Displays icons for surrounding facilities (POI) on the map.
➔ For details, refer to *Displaying POI on the map* on page 136.
-  **Volume***
Displays the “**Volume Settings**” screen.
➔ For details, refer to *Setting the Volume for Guidance and Phone* on page 142.
-  **Contacts***
Displays the “**Contacts List**” screen.
➔ For details, refer to *Calling a number in the phone book* on page 61.
-  **Whole Route Overview**
Displays the entire route (currently set) with the “**Route Overview**” screen.
➔ For details, refer to *Displaying the route overview* on page 43.
-  **Traffic on Route**
Displays a list of traffic information on the route.

Customising preferences

- For details, refer to *Checking traffic information on the route* on page 52.
-  **Traffic List**
Displays a list of traffic events information.
 - For details, refer to *Checking all traffic information* on page 51.
-  **Day/Night Display**
Switches **Day/Night Display** setting.
 - For details, refer to *Setting the map colour change between day and night* on page 137.
-  **Favourites Icon**
Switches **Favourites Icon** setting.
 - For details, refer to *Setting the display of icons of favourite locations* on page 134.
-  **Position Fix**
When the vehicle position enters a different street parallel to the street you are travelling, the vehicle position returns to the street you are travelling.

4 To finish the setting, touch [OK].

Displaying the screen for system settings

1 Press the HOME button to display the “Top Menu” screen.

2 Touch [Settings].

The “Settings Menu” screen appears.

- This can also be operated using the “Shortcut Menu” screen.

3 Touch [System Settings].

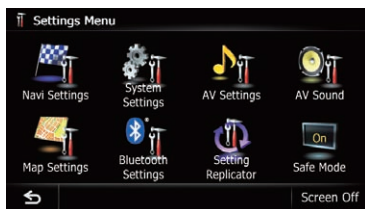

The “System Settings” screen appears.

4 Touch the item that you want to change the setting.

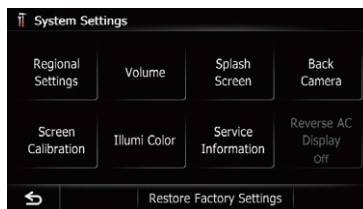

- If you touch , the previous screen returns.

Customising the regional settings

1 Display the “System Settings” screen.

- For details, refer to *Displaying the screen for system settings* on this page.

2 Touch [Regional Settings].

The “Regional Settings” screen appears.



Selecting the language

You can set the languages used on the programme and voice guidance. Each language can be set separately.

1 Display the “System Settings” screen.

- For details, refer to *Displaying the screen for system settings* on this page.

2 Touch [Regional Settings].

The “Regional Settings” screen appears.

3 Touch [Program Language].

The language list is displayed.

4 Touch the desired language.

After the language is selected, the previous screen returns.

5 Touch [Voice Language].

The “**Voice Language Selection**” screen appears.

6 Touch the desired language.

After the language is selected, the previous screen returns.

7 Touch [OK] on the “Regional Settings” screen.

A message confirming whether to restart the navigation system appears.

8 Touch [OK].

The navigation system restarts.

- If you press the **MODE** or **HOME** button, the setting procedure is cancelled.

Installing additional files for voice guidance (TTS files)

TTS file is used to read out the street name in the route guidance by navigation system. If the latest TTS file is available, you can replace the current TTS file with the latest one.

- ☐ For AVIC-F30BT, the TTS file will be also used on the guidance voice of voice recognition.

1 Use your PC to copy the folder named “Voice” onto the top-most directory of the SD memory card.

The “**Voice**” folder is stored on the supplied CD-ROM. Use your PC to copy it.

2 Insert an SD memory card into the SD card slot.

- For details of the operation, refer to *Inserting and ejecting an SD memory card* on page 17.

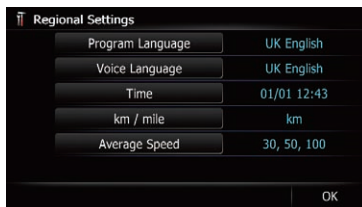
3 Touch [Voice Language].

The “**Voice Language Selection**” screen appears.

4 Touch [Setup Voice].

The “**Voice Language Setup**” screen appears.

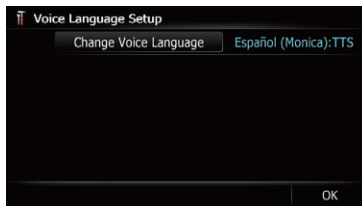
5 Touch [Change Voice Language].

The “**Voice Language Selection (SD)**” screen appears.

6 Touch the desired language.

After a while, loading completes and the “**Regional Settings**” screen returns.

7 Touch [OK] on the “Regional Settings” screen.

A message confirming whether to restart the navigation system appears.

8 Touch [OK].

The navigation system restarts.

- If you press the **MODE** or **HOME** button, the setting procedure is cancelled.

Customising preferences

Setting the time difference

Adjusts the system's clock. Set the time difference (+, -) from the time originally set in your navigation system.

1 Display the "System Settings" screen.

- ➔ For details, refer to *Displaying the screen for system settings* on page 139.

2 Touch [Regional Settings].

The "Regional Settings" screen appears.

3 Touch [Time].

The "Time Settings" screen appears.

4 To set the time difference, touch [+] or [-].

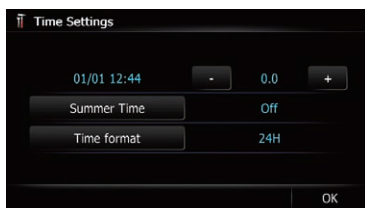

The time difference shows how many hours differ from the time originally set in the navigation system (Central European Time) and the current location of your vehicle. Touching [+] or [-] changes the time difference display in half-hour increments.

The time difference can be set from "-4" to "+9" hours.

5 Touch [Summer Time].

Summer time setting is off by default. Touch [Summer Time] to change the setting if you are in the summer time period.

6 Touch [Time format].

Each time you touch the key changes the setting.

- **24H** (default):
Changes the display to 24-hour format.
- **12H**:
Changes the display to 12-hour format with am/pm.

Changing the unit between km and miles

This setting controls the unit of distance and speed displayed on your navigation system.

1 Display the "System Settings" screen.

- ➔ For details, refer to *Displaying the screen for system settings* on page 139.

2 Touch [Regional Settings].

The "Regional Settings" screen appears.

3 Touch [km / mile].

A message confirming whether to change the setting appears.

4 Touch [Yes].

Each time you touch the key changes the setting.

- **km** (default):
Shows distance in kilometres.
- **mile**:
Shows distance in miles.
- **Mile&Yard**:
Shows distance in miles and yards.
- If you touch [No], the setting is cancelled.

Changing the virtual speed of the vehicle

When calculating the expected time of arrival and the travel time to the destination, set the average speed for the motorway or ordinary roads using [+] and [-].

1 Display the "System Settings" screen.

- ➔ For details, refer to *Displaying the screen for system settings* on page 139.

2 Touch [Regional Settings].

The "Regional Settings" screen appears.

3 Touch [Average Speed].

The "Average Speed Settings" screen appears.

4 Touch [+] or [-] to set the speed.



- The estimated time of arrival may not be taken into account other parameters than this speed value.

5 Touch [OK].

The settings are complete.

Setting the Volume for Guidance and Phone

The sound volume for the navigation can be set. You can separately set the volume of the route guidance and the beep sound.

1 Display the "System Settings" screen.

- ➔ For details, refer to *Displaying the screen for system settings* on page 139.

2 Touch [Volume].

The "Volume Settings" screen appears.

3 Touch [+] or [-] to set their volume.

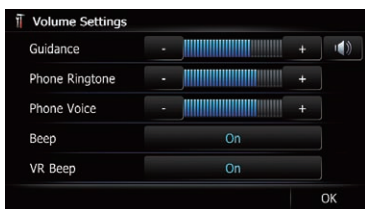

On this screen, you can operate the following items.

- **Guidance**
This setting controls the guidance volume of navigation.
 - When set to , guidance is output.
 - When set to , no guidance is output.

- **Phone Ringtone**

This setting controls the incoming ring tone volume.

- **Phone Voice**

This setting controls the incoming voice volume.

- "Phone Ringtone" and "Phone Voice" adjustments are needed only when the mobile phone featuring Bluetooth technology is connected.
- Volume of the AV source is adjusted by the **VOL (+/-)** button or Multi-control.
 - ➔ For details, refer to *Checking part names and functions* on page 12.
- If you touch the key next to "**Beep**", the setting is changed.
 - **On** (default):
A beep sounds.
 - **Off**:
The beep sound is muted.
- If you touch the key next to "**VR Beep**", the setting is changed.
 - This function is available for AVIC-F30BT only.

Each time you touch the key changes the setting.

- **On** (default):
Voice recognition beep is enabled.
- **Off**:
Voice recognition beep is disabled.

4 To finish the setting, touch [OK].

Changing the preinstalled splash screen

You can change the splash screen to the other images preinstalled in the navigation system.

1 Display the "System Settings" screen.

- ➔ For details, refer to *Displaying the screen for system settings* on page 139.

2 Touch [Splash Screen].

The "Select Splash Screen" screen appears.

3 Touch the image to use as the splash screen from the list.

The image is displayed on the screen.

Customising preferences

4 Touch [OK].

The image is set as the splash screen, and the "System Settings" screen returns.

Changing to the splash screen stored in the SD memory card

You can change the splash screen to other images stored in the SD memory card. Copy your chosen image to the SD memory card, and select the image to import.

- ❑ Splash screen images should be used with- in the following formats;
 - BMP or JPEG files
 - Allowable horizontal and vertical size are 2 592 pixels x 1 944 pixels or smaller
 - Allowable data size is 6 MB or smaller
- ❑ Proper compatibility with allowable files is not guaranteed.
- ❑ Imported original images will be stored in the built-in memory, but the ability to save these images cannot be guaranteed completely. If your original image data is deleted, insert the SD memory card again and re-import the original image.
- ❑ The maximum number of images, including the images in the built-in memory, that can be imported and displayed on the list is 200.

1 Create a folder named "Pictures" on the top-most directory of the SD memory card.

2 Store the picture files in the "Pictures" folder.

3 Insert an SD memory card into the SD card slot.

- ➔ For details of the operation, refer to *Inserting and ejecting an SD memory card* on page 17.

4 Display the "System Settings" screen.

- ➔ For details, refer to *Displaying the screen for system settings* on page 139.

5 Touch [Splash Screen].

The "Select Splash Screen" screen appears.

6 Touch [Select from SD].

The "Select Splash Screen" screen appears.

7 Touch the image to use as the splash screen from the list.

The image is displayed on the screen.

8 Touch [OK].

The image is set as the splash screen, and the "System Settings" screen returns.

- ❑ Images imported from the SD memory card are added to the list on "Select Splash Screen".

Setting for rear view camera

The following two functions are available. The rear view camera feature requires a separately sold rear view camera (e.g. ND-BC4). (For details, consult your dealer.)

Rear view camera

The navigation system features a function that automatically switches to the full-screen image of the rear view camera installed on your vehicle. When the gearstick is in the REVERSE (R) position, the screen automatically switches to full-screen rear view camera image.

Switching to the "Parking Assist" screen

When the following conditions are met, touch  on the screen of the rear view camera to switch to the "Parking Assist" screen.

- Vehicle Bus adapter must be connected.
 - Your vehicle must be equipped with a parking sensor.
- ➔ For details of the operations, refer to *Displaying obstacle detection information* on page 160.

Camera for Rear view mode

Rear view can be displayed at all times (e.g. when monitoring an attached trailer, etc.) as a split screen where map information is partially displayed. Please be aware that with this setting, camera image is not resized to fit, and that a portion of what is seen by the camera is not viewable.

➔ For details, refer to *Setting for rear view camera* on the previous page.



CAUTION

Pioneer recommends the use of a camera which outputs mirror reversed images, otherwise the screen image may appear reversed.

- Immediately verify whether the display changes to a rear view camera image when the gearstick is moved to REVERSE (R) from another position.
- When the screen changes to full-screen rear view camera image during normal driving, switch to the opposite setting in “Polarity”.

1 Display the “System Settings” screen.

➔ For details, refer to *Displaying the screen for system settings* on page 139.

2 Touch [Back Camera].

The “Back Camera Settings” screen appears.

3 Touch [Camera].

This changes the setting to “On”.

- You can only switch to “Rear View” if this setting is “On”.

4 Touch [Polarity] to select an appropriate setting for polarity.

Each time you touch [Polarity] switches between the following polarity:

- **Battery:** When the polarity of the connected lead is positive while the gearstick is in the REVERSE (R) position
- **GND:** When the polarity of the connected lead is negative while the gearstick is in the REVERSE (R) position

Adjusting the response positions of the touch panel (touch panel calibration)

If you feel that the touch panel keys on the screen deviate from the actual positions that respond to your touch, adjust the response positions of the touch panel screen.

- Do not use a sharp pointed tool such as a ballpoint pen or a mechanical pen, which could damage the screen.

1 Display the “System Settings” screen.

➔ For details, refer to *Displaying the screen for system settings* on page 139.

2 Touch [Screen Calibration].

A message confirming whether to start the calibration appears.

3 Gently touch the centre of + mark displayed on the screen.

The target indicates the order.

After you touch all marks, the adjusted position data is saved.

- Do not turn off the engine while saving the adjusted position data.
 - If you press the **MODE** button, the previous adjustment position returns.
 - If you press and hold the **MODE** button, the adjustment is cancelled.

Setting the illumination colour

The illumination colour can be selected from 8 different colours. Furthermore, the illumination colour can be switched between these 8 colours in order.

Selecting the colour from the preset colours

1 Display the “System Settings” screen.

➔ For details, refer to *Displaying the screen for system settings* on page 139.

2 Touch [Illumi Color].

The “Illumination Color” screen appears.

Customising preferences

3 Touch the colour you want.

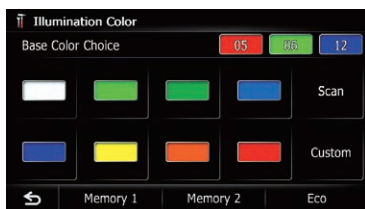

Available options:

- Coloured keys: Selects the desired preset colour
- **Memory 1/Memory 2:** Colours registered in the memory
 - ➔ For details, refer to *Creating a user-defined colour and storing it to memory* on this page.
- **Scan:** Shifts between the eight default colours in sequence gradually.
- **Eco:** The colours change in the order of white, red, amber, yellow, green, and blue as the number of points in the “**Eco Score**” increases.
 - The illumination lights in white when “**Eco Score**” is set to “**Off**” or when no route is set.

Creating a user-defined colour and storing it to memory

You can create a user-defined colour and set it as the illumination colour.

1 Display the “System Settings” screen.

- ➔ For details, refer to *Displaying the screen for system settings* on page 139.

2 Touch [Illumi Color].

The “**Illumination Color**” screen appears.

3 Touch [Custom].

The “**Illumination Color**” screen appears.

- If [Scan] is set, [Custom] cannot be selected.

4 Touch [+] or [-] to adjust the values for Red, Green and Blue to create a favourite colour.



Watch the illumination of hardware keys while adjusting the colour.

Each time you touch **[+]** or **[-]** increases or decreases the value of the selected item. **+31** to **+00** is displayed as the value is increased or decreased.

- An entry cannot be stored with all of the values set to “**+00**”.

5 Touch [Memory 1] or [Memory 2] to store the illumination colour.

6 Touch [OK] to return to the previous screen.

Checking the version information

1 Display the “System Settings” screen.

- ➔ For details, refer to *Displaying the screen for system settings* on page 139.

2 Touch [Service Information].

The “**Service Information Screen**” screen appears.

3 Check the version information.

Reversing the climate control status display

If the left/right display of the climate control status screen does not match that of vehicle, the display can be reversed.

- To configure this setting, the optional Vehicle Bus adapter must be connected.

- ➔ For details of the operations, refer to *Displaying the operating status of the climate control panel* on page 160.

1 Display the “System Settings” screen.

- ➔ For details, refer to *Displaying the screen for system settings* on page 139.

2 Touch [Reverse AC Display].

Each time you touch the key changes the setting.

- **Off** (default):
The climate control status display is not reversed.
- **On**:
The climate control status display is reversed. 

Selecting the video for rear display

- This function is available for AVIC-F30BT only.
The setting is fixed at “**Mirror AV**” for AVIC-F930BT and AVIC-F9310BT.

You can choose either to show the same image as the front screen or to show the selected source on the rear display.

1 Display the AV operation screen.

- ➔ For details of the operations, refer to *Displaying the AV operation screen* on page 70.

2 Tap on the left edge of the screen.

- The appearance of this key changes according to the current setting.
- While the tuner is receiving an emergency announcement, traffic announcement, or news programme, the current setting cannot be changed.

Each touch of  changes the settings as follows:

- **Mirror AV**: The video on the front screen of the navigation unit is output to the rear display
- **DISC**: The video and sound of the DVDs are output to the rear display

- **iPod**: The video and sound of the iPod are output to the rear display
- **AV1**: The video and sound of **AV1** are output to the rear display
- **AV2**: The video and sound of **AV2** are output to the rear display
- When “**Mirror AV**” is selected, the following restrictions are applied to rear display.
 - When selecting “**Rear View**” in the map display, nothing is displayed.
 - All sounds cannot be output for rear display.
 - When playing back video files on the external storage device (USB, SD), the video image is not output.
- When “**DISC**” is selected, the following restriction is applied to rear display.
 - When a CD or MP3/WMA/AAC disc is set in the built-in DVD drive, only the sound is output.
- When “**iPod**” is selected, the following restriction is applied to rear display.
 - The video image and sound are output only when the corresponding setting on “**AV1 Input**” is “**iPod**”.
- When “**AV1**” or “**AV2**” is selected, the following restrictions are applied to rear display.
 - The video image and sound are output only when “**AV1**” or “**AV2**” has both video and sound.
 - The video image and sound are output only when the corresponding setting on “**AV1 Input**” or “**AV2 Input**” are “**Video**”. 

Adjusting the picture

CAUTION

For safety reasons, you cannot use some of these navigation functions while your vehicle is in motion. To enable these functions, you must stop in a safe place and apply the handbrake. Refer to Important Information for the User (a separate manual).

Customising preferences

You can adjust the picture for each source and rear view camera.

1 Press and hold the MODE button.

The “Picture Adjustment” screen appears.

2 Touch [+] or [-] to adjust the desired item.



- **Brightness:** Adjusts the black intensity.
- **Contrast:** Adjusts the contrast.
- **Colour:** Adjusts the colour saturation.
- **Colour Temp.:** Adjusts the tone of colour (which colour is emphasised, red or blue).
- **Dimmer:** Adjusts the brightness of display.
- Touching [**Camera**] switches to the picture adjustment screen for the rear view camera.
- Touching [**Source**] while adjusting the rear view camera image returns you to the previous screen.
- The adjustments of “**Brightness**” and “**Contrast**” are stored separately when your vehicle’s headlights are off (daytime) and when your vehicle’s headlights are on (nighttime). These are switched automatically depending on whether the vehicle’s headlights are on or off.
- The adjustments of “**Dimmer**” is stored separately when your vehicle’s headlights are off (daytime) and when your vehicle’s headlights are on (nighttime). “**Dimmer**” is switched automatically only when the value of nighttime is lower than the value of daytime.
- You cannot adjust “**Colour**” for the source without a video and navigation map display.
- The setting contents can be memorised separately for the following screen and the video image.

• Audio source

- **AM/FM/CD/ROM/iPod(Music)/SD (audio)/USB(audio)/Bluetooth audio/source off screen/menu screens/others**

• Video source

- **AV1 and iPod(Video)**
- **DVD-V and DivX**
- **SD(Video) and USB(Video)**
- **AV2(Video)**
- Rear view camera image

• Map screen

- The picture adjustment may not be available with some rear view cameras.
- Because of the LCD screen characteristics, you may not be able to adjust the screen at low temperatures.

3 Touch [+] or [-] to adjust the desired item.

Each touch of [+] or [-] increases or decreases the level of the desired item.

4 Touch [↶].

The previous screen returns.

Displaying the screen for AV system settings

1 Press the HOME button to display the “Top Menu” screen.

2 Touch [Settings].

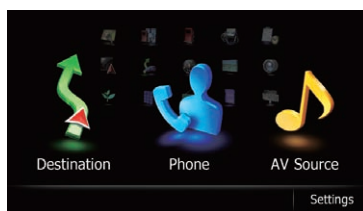

The “Settings Menu” screen appears.

3 Touch [AV Settings].

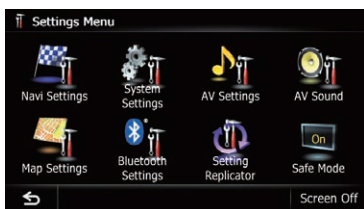

The "AV System Settings" menu appears.

4 Touch the item that you want to change the setting.

AVIC-F30BT

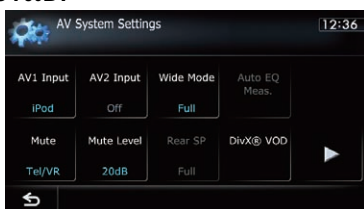

AVIC-F930BT, AVIC-F9310BT



- If you touch , the previous screen returns.

Setting video input 1 (AV1)

You can switch this setting according to the connected component.

- ☐ This setting applies to mini-jack input.

1 Display the "AV System Settings" screen.

- For details, refer to *Displaying the screen for AV system settings* on the previous page.

2 Touch [AV1 Input].

Each touch of [AV1 Input] changes the setting as follows:

- **iPod:** iPod connected with the USB Interface cable for iPod (CD-IU51V) (sold separately)
- **Video:** External video component
- **Off:** No video component is connected.
- ☐ Use "AV1 Input" when connecting CD-RM10 (sold separately) through the external video component.

Setting video input 2 (AV2)

You can switch this setting according to the connected component.

- ☐ This setting applies to RCA inputs (AUDIO INPUT and VIDEO INPUT) on the back of the system.

1 Display the "AV System Settings" screen.

- For details, refer to *Displaying the screen for AV system settings* on the previous page.

2 Touch [AV2 Input].

Each touch of [AV2 Input] changes the setting as follows:

- **Off:** No video component is connected.
- **Video:** External video component

Changing the wide screen mode

1 Display the "AV System Settings" screen.

- For details, refer to *Displaying the screen for AV system settings* on the previous page.

2 Touch [Wide Mode].

Each touch of [Wide Mode] changes the setting as follows:

- **Full (full)**
A 4:3 picture is enlarged in the horizontal direction only, enabling you to enjoy a 4:3 TV picture (normal picture) without any omissions.
- **Cinema (cinema)**

Customising preferences

A picture is enlarged by the same proportion as "Full" or "Zoom" in the horizontal direction and by an intermediate proportion between "Full" and "Zoom" in the vertical direction; ideal for a cinema-sized picture (wide screen picture) where captions lie outside the frame.

• Zoom (zoom)

A 4:3 picture is enlarged in the same proportion both vertically and horizontally; ideal for a cinema-sized picture (wide screen picture).

• Normal (normal)

A 4:3 picture is displayed normally, giving you no sense of disparity since its proportions are the same as that of the normal picture.

- You can only adjust "Wide Mode" when selecting an AV source with video.
- Different settings can be stored for each video source.
- The same setting is automatically applied for the following grouping.
 - DVD-V and DivX
 - AV1 and AV2
- When viewing videos, select an appropriate wide screen mode that matches its original aspect ratio to view it comfortably.
- Remember that use of this system for commercial or public viewing purposes may constitute an infringement on the author's rights protected by the Copyright Law.
- The navigation map and the rear view camera picture is always viewed at "Full".

Setting the rear output

The navigation system's rear output can be used for a full-range speaker or subwoofer connection. If you switch "Rear SP" to "Sub. W", you can connect a rear speaker lead directly to a subwoofer without using an auxiliary amp.

Initially, the navigation system is set for a rear full-range speaker connection ("Full").

- Both rear speaker leads output and RCA rear output are switched simultaneously in

this setting. (When you use the product without RCA rear output, this setting only applies to the rear speaker leads.)

- "Rear SP" can be set only when the source is selected to "Off".
- AVIC-F9310BT is not compatible with the wiring that the subwoofer is directly connected to rear speaker leads. Always use the setting with "Full".

1 Display the "AV System Settings" screen.

- For details, refer to *Displaying the screen for AV system settings* on page 147.

2 Touch [Rear SP].

Each touch of [Rear SP] changes the settings as follows:

- **Full**
When no subwoofer is connected to the rear output, select "Full".
- **Sub. W**
When a subwoofer is connected to the rear output, select "Sub. W".

Switching the muting/attenuation timing

You can mute the AV source volume or attenuate the output signal.

- Even if this setting is "Off", the navigation system will mute or attenuate the AV source volume when the mute signal is output via MUTE lead.

1 Display the "AV System Settings" screen.

- For details, refer to *Displaying the screen for AV system settings* on page 147.

2 Touch [Mute].

Each touch of [Mute] changes the settings as follows:

AVIC-F30BT

- **Guide/Tel/VR:** The volume is muted or attenuated according to the following conditions.

- When the navigation outputs the guidance voice.
- When you use a mobile phone via Bluetooth technology (dialling, talking, incoming call).
- When the voice recognition mode is activated.
- **Tel/VR:** The volume is muted or attenuated according to the following conditions.
 - When you use a mobile phone via Bluetooth technology (dialling, talking, incoming call).
 - When the voice recognition mode is activated.
- **Off:** The volume does not change.

AVIC-F930BT, AVIC-F9310BT

- **Guide/Tel:** The volume is muted or attenuated according to the following conditions.
 - When the navigation outputs the guidance voice.
 - When you use a mobile phone via Bluetooth technology (dialling, talking, incoming call).
- **Tel:** The volume is muted or attenuated when you use a mobile phone via Bluetooth technology (dialling, talking, incoming call).
- **Off:** The volume does not change.
- AV source volume returns to normal when the corresponding action ends.

Switching the muting/attenuation level

You can select the muting/attenuation level of “Mute”. This setting is also effective for a mute signal that has been received from the MUTE lead connected to the navigation unit.

- This menu is not available when AV source is “Off”.

1 Display the “AV System Settings” screen.

- ➔ For details, refer to *Displaying the screen for AV system settings* on page 147.

2 Touch [Mute Level].

Each touch of [Mute Level] changes the settings as follows:

- **20dB:** The volume becomes 1/10.
- **10dB:** The volume becomes 1/3.
- **All:** The volume becomes 0.
- When you select “All”, no audio adjustments are possible during the sound is turned off.
- When you select “20dB” or “10dB”, no audio adjustments are possible during the sound is attenuated.
- AV source volume returns to normal when the corresponding action ends.
- Even when a mute signal has been received from MUTE lead connected to the navigation unit, navigation voice guidance cannot be attenuated or muted.

Switching Auto PI seek

The navigation system can automatically search for a different station with the same programming, even during preset recall.

- “Auto PI” can be set only when the source is selected to “Off”.

1 Display the “AV System Settings” screen.

- ➔ For details, refer to *Displaying the screen for AV system settings* on page 147.

2 Touch [Auto PI].

Each touch of [Auto PI] changes the settings as follows:

- **Off** (default):
Deactivates the Auto PI seek function.
- **On:**
Activates the Auto PI seek function.

Setting the FM tuning step

Normally the FM tuning step employed by seek tuning is 50 kHz. When “AF” or “TA” is on, the tuning step automatically changes to 100 kHz. But you can set the tuning step to 50 kHz when “AF” or “TA” is on.

Customising preferences

- ❑ “FM Step” can be set only when the source is selected to “Off”.

1 Display the “AV System Settings” screen.

- For details, refer to *Displaying the screen for AV system settings* on page 147.

2 Touch [FM Step].

Each time you touch [FM Step] will switch the FM tuning step between 50 kHz and 100 kHz while “AF” or “TA” is on.

- ❑ The tuning step remains at 50 kHz during manual tuning.

Displaying your DivX VOD registration code

In order to play DivX VOD (video on demand) content on this navigation system, you first need to register the unit with your DivX VOD content provider. You do this by generating a DivX VOD registration code, which you submit to your provider.

- ❑ This feature is available when the selected source is **CD**, **ROM**, **DivX**, or **DVD-V**.

1 Display the “AV System Settings” screen.

- For details, refer to *Displaying the screen for AV system settings* on page 147.

2 Touch [DivX® VOD].

The screen where you can choose to display a registration code or deregistration code is displayed.

- ❑ If a registration code has already been activated, it cannot be displayed.

3 Touch [Registration Code].

Your 10-digit registration code is displayed.

- ❑ Make a note of the code as you will need it when you register with a DivX VOD provider.

Displaying your DivX VOD deregistration code

A registration code registered with a deregistration code can be deleted.

- ❑ This feature is available when the selected source is **CD**, **ROM**, **DivX**, or **DVD-V**.

1 Display the “AV System Settings” screen.

- For details, refer to *Displaying the screen for AV system settings* on page 147.

2 Touch [DivX® VOD].

The screen where you can choose to display a registration code or deregistration code is displayed.

- ❑ If a registration code has not been activated, the deregistration code is not displayed.

3 Touch [Deregistration Code].

Your 8-digit deregistration code is displayed.

- ❑ Make a note of the code as you will need it when you deregister with a DivX VOD provider. 

Displaying the screen for AV sound settings

1 Press the HOME button to display the “Top Menu” screen.

2 Touch [Settings].

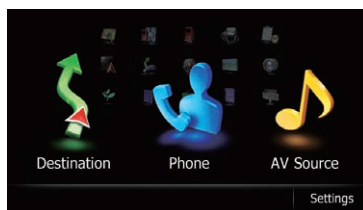

The “Settings Menu” screen appears.

3 Touch [AV Sound].

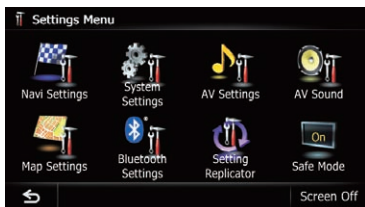

The "AV Sound Settings" screen appears.

- You cannot make adjustments in the following situations:
 - AV source is "Off".
 - During muting/attenuation

4 Touch the item that you want to change the setting.



- If you touch , the previous screen returns.

Using balance adjustment

You can select a fader/balance setting that provides an ideal listening environment in all occupied seats.

1 Display the "AV Sound Settings" screen.

- ➔ For details, refer to *Displaying the screen for AV sound settings* on the previous page.

2 Touch [FAD/BAL].

When "Sub. W" is selected in "Rear SP", [Balance] will be displayed instead of [FAD/BAL] and front/rear speaker balance cannot be adjusted.

- ➔ For details, refer to *Setting the rear output* on page 149.

3 Touch [▲] or [▼] to adjust front/rear speaker balance.

Each time you touch [▲] or [▼], the front/rear speaker balance moves towards the front or the rear.

"Front: 15" to "Rear: 15" is displayed as the front/rear speaker balance moves from front to rear.

Set "Front:" and "Rear:" to "0" when using a two-speaker system.

4 Touch [◀] or [▶] to adjust left/right speaker balance.

Each time you touch [◀] or [▶], the left/right speaker balance moves towards the left or the right.



"Left: 15" to "Right: 15" is displayed as the left/right speaker balance moves from left to right.

Using the equaliser

The equaliser lets you adjust equalisation to match vehicle interior acoustic characteristics as desired.

Recalling equaliser curves

There are seven stored equaliser curves that you can easily recall at any time. Here is a list of the equaliser curves:

Equaliser curve

S.Bass (Super Bass) is a curve in which only low-pitched sound is boosted.

Powerful is a curve in which low-pitched and high-pitched sounds are boosted.

Natural is a curve in which low-pitched and high-pitched sounds are slightly boosted.

Customising preferences

Equaliser curve

Vocal is a curve in which the midrange, which is the human vocal range, is boosted.

Flat is a flat curve in which nothing is boosted.

Custom1 is an adjusted equaliser curve that you create. A separate custom curve can be created for each source.

Custom2 is an adjusted equaliser curve that you create. If you select this curve, the effect is applied to all AV sources.

- ❑ When **"Flat"** is selected, no supplement or correction is made to the sound. This is useful to check the effect of the equaliser curves by switching alternatively between **"Flat"** and a set equaliser curve.
- ❑ You cannot select **"Custom1"** and **"Custom2"** when **"Auto EQ"** is **"On"**.
 - ➔ For details, refer to *Using the auto-adjusted equaliser* on the next page.

1 Display the "AV Sound Settings" screen.

- ➔ For details, refer to *Displaying the screen for AV sound settings* on page 151.

2 Touch [EQ].

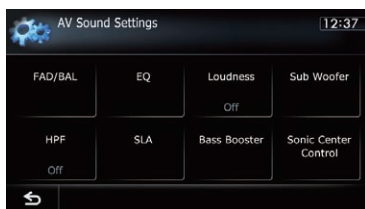

3 Touch the equaliser you want.

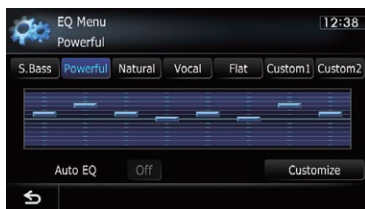

- ❑ If **Auto EQ** has been set to **"On"**, an image corresponding to each equaliser curve you selected appears.

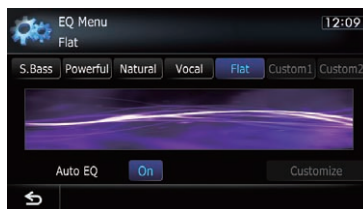

- ➔ For details of the operations, refer to *Adjusting the equaliser curve automatically (Auto EQ)* on the next page.

Customising the equaliser curves

You can adjust the currently selected equaliser curve setting as desired. Adjustments can be made with a 8-band graphic equaliser.

- ❑ This function is not available when **"Auto EQ"** is **"On"**.
 - ➔ For details, refer to *Using the auto-adjusted equaliser* on the next page.

The difference between "Custom1" and "Custom2"

- A separate **"Custom1"** curve can be created for each source. If you make adjustments when a curve **"S.Bass (Super Bass)"**, **"Powerful"**, **"Natural"**, **"Vocal"**, **"Flat"**, or **"Custom1"** is selected, the equaliser curve settings will be memorised in **"Custom1"**.
- A **"Custom2"** curve can be created common to all sources. If you make adjustments when **"Custom2"** curve is selected, the **"Custom2"** curve will be updated.
- The **"Custom1"** curve is applied to each of the source selected, but you can apply the same curve to the following sources.
 - **AM** and **FM**
 - **AV1** and **AV2**
 - **CD**, **ROM**, **DVD-V**, and **DivX**
 - **SD** and **USB**
- ❑ The different curve can be memorised between **iPod** and **USB**.

1 Display the “AV Sound Settings” screen.

- ➔ For details, refer to *Displaying the screen for AV sound settings* on page 151.

2 Touch [EQ].

3 Touch one of the keys to select a curve that you want to use as the basis of customising.

4 Touch [Customize].

5 Touch the frequency that you want to adjust the level.

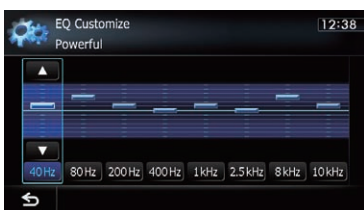

6 Touch [▲] or [▼] to adjust the level of the equaliser band.

Each time you touch [▲] or [▼], the level of the equaliser band increases or decreases.

Using the auto-adjusted equaliser

You can set the auto-adjusted equaliser to suit the vehicle's acoustics. To use this function, the vehicle's acoustics must be measured in advance.

- ➔ For details of the operations, refer to *Adjusting the equaliser curve automatically (Auto EQ)* on this page.
- ☐ To manually adjust the equaliser curve, set “Auto EQ” to “Off”.

1 Display the “AV Sound Settings” screen.

- ➔ For details, refer to *Displaying the screen for AV sound settings* on page 151.

2 Touch [EQ].

3 Touch the key next to “Auto EQ” to turn the auto-adjusted equaliser on or off.

4 Select the equaliser curve.

Adjusting the equaliser curve automatically (Auto EQ)

By measuring the vehicle's acoustics, the equaliser curve can be adjusted automatically to suit the interior of the vehicle.

! WARNING

A loud tone (noise) may be emitted from the speakers when measuring the vehicle's acoustics. Never perform the Auto EQ measurement while driving.

! CAUTION

- Thoroughly check the conditions before performing Auto EQ, as the speakers may be damaged if this is performed under the following conditions:
 - When the speakers are incorrectly connected. (For example, when a rear speaker is connected as a subwoofer output.)
 - When a speaker is connected to a power amp delivering output higher than the speaker's maximum input power capability.
- If the microphone for acoustical measurement (sold separately) is not placed in an appropriate location, the measurement tone may become loud and measurement may take a long time, resulting in battery drainage. Be sure to place the microphone in the specified location.

Customising preferences

Before operating the Auto EQ function

- Perform Auto EQ in as quiet a place as possible, with the vehicle engine and air conditioning switched off. Also, cut power to car phones or mobile phones in the vehicle, or remove them from the vehicle before performing Auto EQ. Sounds other than the measurement tone (surrounding sounds, engine sound, telephones ringing, etc.) may prevent correct measurement of the vehicle's acoustics.
- Be sure to perform Auto EQ using the microphone for acoustical measurement (sold separately). Using another microphone may prevent measurement, or result in incorrect measurement of the vehicle's acoustics.
- To perform Auto EQ, the front speakers must be connected.
- When this navigation system is connected to a power amp with input level control, Auto EQ may not be able to be performed if the power amp's input level is set below the standard level.
- When this navigation system is connected to a power amp with an LPF, turn the LPF off before performing Auto EQ. Also, set the cut-off frequency for the built-in LPF of an active subwoofer to the highest frequency.
- The distance has been calculated by computer to provide the optimum delay to ensure accurate results. Do not change this value.
 - The reflected sound within the vehicle is strong and delays occur.
 - The LPF on active subwoofers or external amps delay the lower sounds.
- If an error occurs during measurement, a message appears and measurement is cancelled. Check the following before measuring the vehicle's acoustics.
 - Front speakers (left/right)
 - Rear speakers (left/right)
 - Noise

- Microphone for acoustical measurement (sold separately)
- Low battery

Performing Auto EQ

- ❑ Auto EQ changes the audio settings as follows:
 - "Auto EQ" on the "EQ Menu" screen is set to "On".
 - ➔ For details, refer to *Using the auto-adjusted equaliser* on the previous page.
 - The fader/balance settings return to the centre position.
 - ➔ For details, refer to *Using balance adjustment* on page 152.
 - The equaliser curve switches to "Flat".
 - ➔ For details, refer to *Using the equaliser* on page 152.
 - The front and rear speakers will automatically be adjusted to a high pass filter setting.
- ❑ Previous settings for Auto EQ will be overwritten.
- ❑ For AVIC-F30BT users
 - Do not press the ▲ button to open or close the panel when you are using the microphone.

1 Stop the vehicle in a place that is quiet, close all the doors, windows and sun roof, and then turn the engine off.

If the engine is left running, engine noise may prevent correct Auto EQ.

- ❑ If driving restrictions are detected during measurement, measurement is cancelled.

2 Fix the microphone for acoustical measurement (sold separately) in the centre of the headrest of the driver's seat, facing forward.

The Auto EQ may differ depending on where you place the microphone. If desired, place the microphone on the front passenger seat and perform Auto EQ.

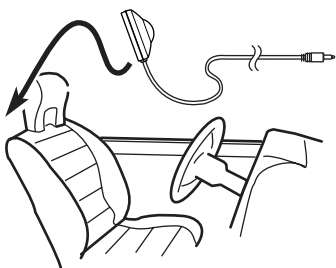

3 Turn the ignition switch to ON or ACC.

If the vehicle's air conditioner or heater is turned on, turn it off. Noise from the fan in the air conditioner or heater may prevent correct Auto EQ.

4 Turn off the AV source.

- ➔ For details of the operations, refer to *Displaying the AV operation screen* on page 70.

5 Set the video setting for the rear display to "Mirror AV".

- ➔ For details of the operations, refer to *Selecting the video for rear display* on page 146.
- ☐ This function is available for AVIC-F30BT only.

6 Display the "AV System Settings" screen.

- ➔ For details, refer to *Displaying the screen for AV system settings* on page 147.

7 Touch [Auto EQ Meas.].

The "Auto EQ Measurement" screen appears.

8 Plug the microphone into the mini-jack connector.

USB and mini-jack connector

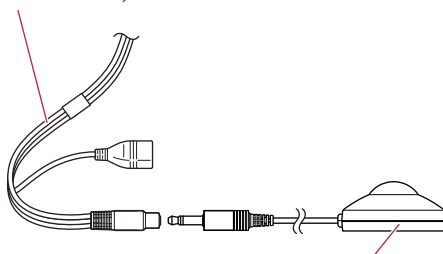

Microphone for acoustical measurement (sold separately)

9 Touch [Start].

A 10-second countdown starts.

10 Exit the vehicle and keep the door closed until the countdown finishes.

When the countdown is over, a measurement tone (noise) is emitted from the speakers and the Auto EQ measurement begins.

11 Wait until the measurement is completed.

When Auto EQ is completed, a message is displayed indicating that the measurement is completed.

- ☐ If the vehicle's acoustics cannot be measured correctly, an error message will be displayed.
- ☐ The measurement time varies depending on the type of vehicle.
- ☐ To stop the measurement, touch [Stop].

12 Touch [OK].

13 Store the microphone carefully in the glove compartment or another safe place.

If the microphone is subjected to direct sunlight for an extended period of time, high temperatures may cause distortion, colour change or malfunction.

Using sonic centre control

Sound that is suited for the listening position can easily be created with this function.

Customising preferences

1 Display the “AV Sound Settings” screen.

- For details, refer to *Displaying the screen for AV sound settings* on page 151.

2 Touch [Sonic Center Control].

3 Touch [◀] or [▶] to select a listening position.

- ❑ The larger the value of the range: “**Left7**” to “**Right7**” setting, the greater the delay of the speaker output.
- ❑ When “**Left**” is set, the left speaker output is delayed. When “**Right**” is set, the right speaker output is delayed.

Adjusting loudness

Loudness compensates for deficiencies in the low- and high-sound ranges at low volume.

1 Display the “AV Sound Settings” screen.

- For details, refer to *Displaying the screen for AV sound settings* on page 151.

2 Touch [Loudness].

Each time you touch [Loudness], the level is selected in the following order:

Off — **Low** — **Mid** — **High**

Using subwoofer output

The navigation system is equipped with a subwoofer output mechanism, which can be turned on or off.

- ❑ This function is not available when “**Sub Woofer**” is “**Off**”.

1 Display the “AV Sound Settings” screen.

- For details, refer to *Displaying the screen for AV sound settings* on page 151.

2 Touch [Sub Woofer].

3 Touch [On].

The subwoofer output is turned on.



- If you touch [Off], the subwoofer output is turned off.

4 Touch [Reverse] or [Normal] to select the phase of subwoofer output.

5 Touch [+] or [-] next to “Level” to adjust the output level.

“+6” to “-24” is displayed as the level is increased or decreased.

6 Touch [◀] or [▶] next to “Frequency(Hz)” to select cut-off frequency.

Each time you touch [◀] or [▶], cut-off frequencies are selected in the following order: **50Hz** — **63Hz** — **80Hz** — **100Hz** — **125Hz**. Only frequencies lower than those in the selected range are output from the subwoofer.

Using the high pass filter

When you cut lower sounds from the subwoofer output frequency, activate **HPF** (high pass filter). Only frequencies higher than those in the selected range are output from the front or rear speakers.

1 Display the “AV Sound Settings” screen.

- For details, refer to *Displaying the screen for AV sound settings* on page 151.

2 Touch [HPF].

Each time you touch [HPF] selects cut-off frequencies in the following order:

Off — **50Hz** — **63Hz** — **80Hz** — **100Hz** — **125Hz**

Adjusting source levels

SLA (source level adjustment) lets you adjust the volume level of each source to prevent radical changes in volume when switching between sources.

- Settings are based on the FM tuner volume level, which remains unchanged.
- You cannot select **[SLA]** when the FM tuner is selected as the AV source.

1 Compare the FM tuner volume level with the level of the source you wish to adjust.

2 Display the “AV Sound Settings” screen.

- ➔ For details, refer to *Displaying the screen for AV sound settings* on page 151.

3 Touch [SLA].

4 Touch [+] or [-] to adjust the source volume.

“+8dB” to “-8dB” is displayed as the source volume is increased or decreased.

The following AV sources are set to the same source level adjustment volume automatically.

- **CD, ROM, and DivX**
- **SD and USB**
- **AV1 and AV2**

- The different source volume level can be set between **iPod** and **USB**.

Enhancing bass (Bass Booster)

You can enhance bass sounds that are often muted by driving noise.

1 Display the “AV Sound Settings” screen.

- ➔ For details, refer to *Displaying the screen for AV sound settings* on page 151.

2 Touch [Bass Booster].

3 Touch [+] or [-] to adjust the range from 0 to 6.

Replicating the settings

You can import settings you have made on the utility programme NavGate FEEDS which is available separately to the navigation system.

1 Use NavGate FEEDS to replicate the settings and store them on an SD memory card.

2 Insert an SD memory card into the SD card slot.

- ➔ For details of the operation, refer to *Inserting and ejecting an SD memory card* on page 17.

3 Press the HOME button to display the “Top Menu” screen.

4 Touch [Settings].

The “**Settings Menu**” screen appears.

5 Touch [Setting Replicator].

A message confirming whether to update the settings appears.

6 Touch [Yes].

Update starts.

After the settings are updated, a message confirming whether to restart the navigation system appears.

7 Touch [OK].

The navigation system restarts.

Setting the safe mode

For safety reasons, you can limit the functions that are available while your vehicle is in motion.

1 Press the HOME button to display the “Top Menu” screen.

2 Touch [Settings].

The “**Settings Menu**” screen appears.

Customising preferences

3 Touch [Safe Mode].

Each time you touch the key changes the setting.

- **On** (default):
Activates the safe mode function.
- **Off**:
Deactivates the safe mode function.

Turning off the screen

By turning off the backlight of the LCD screen, you can turn off the screen display without turning off the voice guidance.

1 Press the HOME button to display the "Top Menu" screen.

2 Touch [Settings].

The "Settings Menu" screen appears.

3 Touch [Screen Off].

The screen is turned off.

- Touch anywhere on the screen to turn it back on.

Displaying the operation status of vehicle equipment

By connecting the optional Vehicle Bus adapter, you can display the operation status of the vehicle's parking sensor function and climate control panel on the navigation screen.

CAUTION

- For information on installing the Vehicle Bus adapter, see the operating manual of the Vehicle Bus adapter.
- After installing the Vehicle Bus adapter, be sure to check operations.
- For details about vehicle models that are compatible with Vehicle Bus adaptors, refer to the information on our website.
- Functions and displays vary depending on the vehicle model. For details about the functions available according to model, refer to the information on our website.

Displaying obstacle detection information

CAUTION

This function is intended solely to assist the driver's vision. It does not detect all dangers and obstacles and is not a substitute for your attentiveness, judgement, and care while parking your vehicle.

Turn on the parking assist sensor on your vehicle, and the navigation screen will switch to the "Parking Assist" screen.

- This function is available only for vehicles equipped with a parking sensor system.
- The "Parking Assist" screen is not displayed until the navigation screen has started.

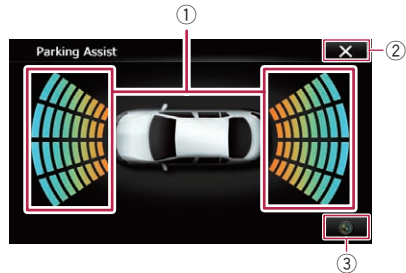

- ① Displays the position of detected obstacles.
- ② The previous screen returns.
- ③ Switches the display to the rear view camera image.
 - The display switches only when the rear view camera setting is set to "On" and the gearstick is in the REVERSE (R) position. □

Displaying the operating status of the climate control panel

When you operate the climate control panel of the vehicle, the navigation screen switches automatically to the "Climate" screen.

- The settings of the climate control panel operated before the navigation system is started are not displayed on the screen.
- Any climate control panel settings of the vehicle that are turned off are not displayed on the screen.
- If the information displayed on the navigation screen is reversed for the left and right sides of the vehicle, change the "Reverse AC Display" setting to "On".
 - ➔ For details of the operations, refer to *Reversing the climate control status display* on page 145.

Displaying the operation status of vehicle equipment

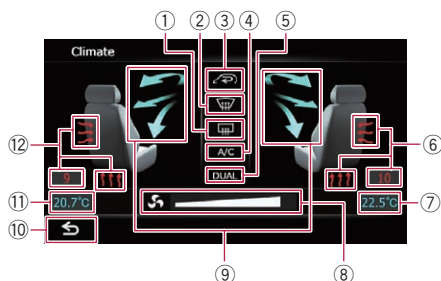

- ① Displays that the rear window heating setting is on.
- ② Displays that the front window heating setting is on.
- ③ Displays that the internal circulation mode setting is on.
- ④ Displays that the A/C setting is on.
- ⑤ Displays that the dual A/C function is on.
- ⑥ Displays the seat heating setting for the right seat.
- ⑦ Displays the internal temperature setting for the right seat.
- ⑧ Displays the fan speed.
- ⑨ Displays the fan direction.
- ⑩ The previous screen returns.
 - If you do not operate the climate control panel for a few seconds, the previous screen is displayed automatically.
- ⑪ Displays the internal temperature setting for the left seat.
- ⑫ Displays the seat heating setting for the left seat.

- ❑ This function is available for AVIC-F30BT only.

To ensure safe driving



CAUTION

For your safety, avoid viewing the screen in the voice operation as much as possible while driving.

The voice operation is available when "**Voice Language**" is set to one of the following languages:

- UK English/UK English (Serena):TTS
- Español/Español (Monica):TTS
- Deutsch/Deutsch (Steffi):TTS
- Français/Français (Virginie):TTS
- Italiano/Italiano (Silvia):TTS
- Nederlands/Nederlands (Claire):TTS
- ➡ For details, refer to *Selecting the language* on page 139.



Basics of the voice operation

Your Pioneer navigation system uses the latest in voice recognition technology. You can use voice commands to operate many of its functions. This chapter describes where you can use voice commands, and also what commands the system accepts.

You can use voice commands to operate the following functions:

- Searching for a location by address
- Setting the route to the selected POI
- Hands-free phoning
- Switching the AV source

Flow of the voice operation

You can start the voice operation any time even when the map screen is displayed or AV is operating. (Some operations are not avail-

able.) The basic steps of the voice operations are as follows.

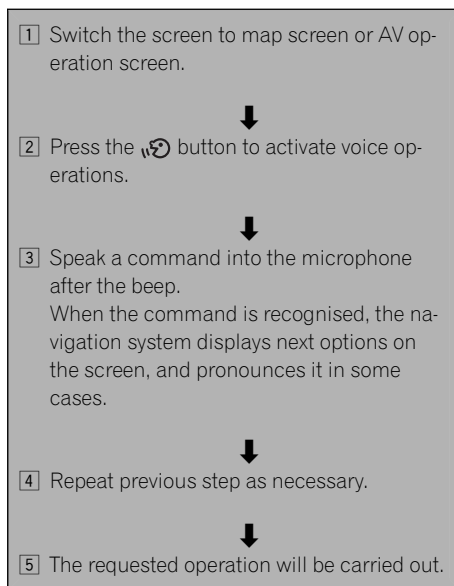

- ❑ The voice operation may not be operable for a minute after the navigation system has booted up.
- ❑ The voice operation will be activated 30 seconds after the map screen is displayed. If the  button does not respond, display the disclaimer screen and then touch [OK]. The map screen is displayed.



Starting the voice operation

- **Press the  button when the map screen or the AV operation screen is displayed.**

The voice operation screen appears.

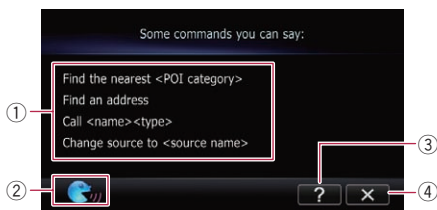
Operating your navigation system with voice



- ① Voice help menu:
Displays a list of commands for the voice operation.
- ② Voice operation condition indicator:
When  is indicated, the navigation system can recognise your voice commands.
- ③ :
Touch to listen to the brief operating instruction.
- ④ :
Touch to cancel the voice operation.
You can cancel the voice operation feature at any time by saying "Cancel". After you cancel voice operations, the display returns to the screen displayed before the voice operation screen appeared.

How to use the voice operation

Searching for a location by address

In this example, you want to search for a location by address and set it as your destination.

- ❑ The area in which address search is available depends on the [Voice Language] setting, as listed in the following table.

Voice Language	Available search area
UK English UK English (Serena):TTS	United Kingdom
Español Español (Monica): TTS	Spain, Andorra
Deutsch Deutsch (Steffi):TTS	Germany
Français Français (Virginie): TTS	France, Monaco

Voice Language	Available search area
Italiano Italiano (Silvia):TTS	Italy, San Marino, Vatican City
Nederlands Nederlands (Claire): TTS	Netherlands

- ❑ When the list of candidates with number appears, say the number that you want to select.
When you select the entry next to "1", say "Number 1".
- ❑ If there are multiple items that correspond to the name you gave, the list screen appears. In this case, touch the item you want to select from the list.

1 Press the MODE button to display the map screen or the AV operation screen.

2 Press the  button to activate voice operations.

A list of commands for the voice operation appears. After a message, the beep indicates that the system is ready to accept your voice command. Say a command after this beep.

3 Say "I need directions".

A message prompting you to select a search by address or by POI appears.

4 Say "Find an address".

A message prompting the next operation is given.

5 Say the city name that you want to set to your destination.

6 Say the street name that you want to set to your destination.

7 Say the house number that you want to set to your destination.

Your navigation system sets the route to your destination, and the map of your surroundings appears.

- If you say “**Just go there**”, the navigation system sets the route to the representative location of the city or the street.

Search for POI in vicinity

In this example, you want to search for a POI and set it as your destination.

- When the list of candidates with number appears, say the number that you want to select.
When you select the entry next to “1”, say “**Number 1**”.
- If there are multiple items that correspond to the name you gave, the list screen appears. In this case, touch the item you want to select from the list.

1 Press the MODE button to display the map screen or the AV operation screen.

2 Press the  button to activate voice operations.

A list of commands for the voice operation appears. After a message, the beep indicates that the system is ready to accept your voice command. Say a command after this beep.

3 Say “I need directions”.

A message prompting you to select a search by address or by POI appears.

4 Say “Point of interest”.

The list of POI categories appears.

5 Say the category that you want to set to your destination.

The list of candidates with number appears.

6 Say the number that you want to select.

Your navigation system sets the route to your destination, and the map of your surroundings appears.

Calling the entry on the phone book

A method for dialling the entry named “Nancy” is described here along with an operational example.

1 Press the MODE button to display the map screen or the AV operation screen.

2 Press the  button to activate voice operations.

3 Say “Call Nancy” to make a call.

A message confirming whether to dial appears.

4 Say “Yes”.
Dialling starts. 

Operating your navigation system with voice

Available basic voice commands

The navigation system can also recognise the words in the following list.

- Terms written in italics are voice commands.

Basic commands

Voice commands and operations

Back → The previous screen returns.

Cancel → Cancels the voice operation.

Help → Outputs the brief operating instruction by voice.

Next page, Previous page → Switches the page.

Last page, First page → Switches to the last or first page.

Voice operation for AV source

AV source selection

Voice commands and operations

Change Source to DISC → Switches the AV source to **Disc**.

Change Source to FM → Switches the AV source to **FM**.

Change Source to AM → Switches the AV source to **AM**.

Change Source to SD → Switches the AV source to **SD**.

Change Source to USB → Switches the AV source to **USB**.

Change Source to iPod → Switches the AV source to **iPod**.

Change Source to Bluetooth audio → Switches the AV source to **Audio** (Bluetooth audio).

Built-in DVD drive, external storage device (USB, SD)

Voice commands and operations

Shuffle play → Plays all songs randomly.

Pause → Pauses the track or file currently playing.

Resume → Resumes the track or file currently playing.

Next song → Plays the next track or file.

Previous song → Plays the previous track or file, or returns to the beginning of the track or file currently playing.

Voice commands related to hands-free phoning

- ❑ You can make a phone call by voice dialling if the mobile phone featuring Bluetooth wireless technology is being paired with the navigation system.
- ❑ For <entry's name> shown on the following chart, say the name of the entry stored in "**Contacts**".
- ❑ For <phone number> shown on the following chart, say the desired phone number.

Voice commands and operations

Call <entry's name> → Makes a call to the entry (*1).

Call <entry's name> General → Displays the message confirming whether to dial → Say *Yes* → Dials the general phone number of the entry (*2).

Call <entry's name> Mobile → Displays the message confirming whether to dial → Say *Yes* → Dials the mobile phone number of the entry (*2).

Call <entry's name> Home → Displays the message confirming whether to dial → Say *Yes* → Dials the home phone number of the entry (*2).

Call <entry's name> Office → Displays the message confirming whether to dial → Say *Yes* → Dials the office phone number of the entry (*2).

Call <entry's name> Other → Displays the message confirming whether to dial → Say *Yes* → Dials the other phone number of the entry (*2).

Call <phone number> → Displays the message confirming whether to dial → Say *Yes* → Dials the phone number.

Make a call → Say the phone number you want to call → Displays the message confirming whether to dial → Say *Yes* → The system starts dialling to the number.

Make a call → Say the name of entry stored on "**Contacts**" you want to call → Displays the message confirming whether to dial → Say *Yes* → The system starts dialling to the number (*1).

Find the nearest → Displays the category list → Say the category that you want to set to your destination → Displays the list of candidates with number → *Show me details for <the number that you want to select>* → *Call* → Dialing starts.

(*1) If the entry has multiple phone number data, selection list may appear. In such case, say the type of phone number.

(*2) If there is no corresponding type on the entry, the system may suggest you other phone numbers of the entry. In such case, say the type of phone number.



Tips for the voice operation

For your voice commands to be correctly recognised and interpreted, ensure that conditions are suitable for recognition.

Close the vehicle windows

Please note that wind through the vehicle window or miscellaneous noise from outside the vehicle can interfere with voice operation.

Position the microphone carefully

For optimum pick-up, the microphone should be fixed at a suitable distance directly in front of the driver.

Pause before giving a command

Speaking too soon may cause the recognition to fail.

Pronounce your commands carefully

Speak slowly, deliberately, and clearly.

Other functions

Setting the anti-theft function

You can set a password for the navigation system. If the back-up lead is cut after the password is set, the navigation system prompts for the password at the time of next boot up.

Setting the password

1 Press the HOME button to display the "Top Menu" screen.

2 Touch [Settings].

The "Settings Menu" screen appears.

- This can also be operated using the "Short-cut Menu" screen.

3 Touch Area1, followed by Area2, and then touch and hold Area3.

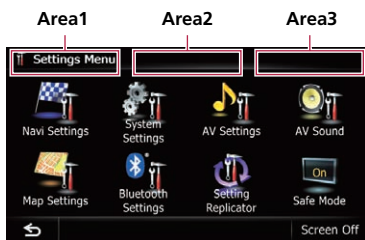

- When the AVIC-F930BT is being installed and a password has not been set up, the password setting screen is displayed when the front panel is detached and re-attached.

4 Touch [Set Password].

The password setting screen appears.

5 Enter the password you want to set.

- 5 to 16 characters can be entered for a password.

6 Touch [OK].

7 Reenter the password to confirm the setting.

8 Touch [OK].

Password protection is applied.

- If you want to change the password currently set, enter the current password and then enter the new one.

Entering the password

On the password input screen, you must enter the current password. If you enter an incorrect password three times, the screen is locked and operations using touch panel keys are disabled.

1 Enter the password.

2 Touch [OK].

If you enter the correct password, the navigation system will be unlocked.

Deleting the password

The current password can be deleted.

1 Press the HOME button to display the "Top Menu" screen.

2 Touch [Settings] on the "Top Menu".

3 Touch Area1, followed by Area2, and then touch and hold Area3.

4 Touch [Clear password].

The password setting screen appears.

5 Enter the current password.

6 Touch [OK].

7 Touch [Yes].

The message for deletion appears and then the current password is deleted.

Forgotten password

Contact the nearest authorised Pioneer Service Station. □

Returning the navigation system to the default or factory settings

You can return settings or recorded content to the default or factory settings. There are some methods to clear user data, and the situations and the cleared content are different for each method. For information regarding the content that is cleared by each method, see the list presented later.

Method 1: Remove the vehicle battery

This transforms the system into the same state as when the navigation system is uninstalled.

Method 2: Touch [Restore Factory Settings]

➤ For details, refer to *Restoring the default setting* on this page.

Method 3: Touch [Clear user information] on the "Select Items to Reset" screen

➤ For details, refer to *Returning the navigation system to the initial state* on this page.

Method 4: Touch [Reset] on the "Select Items to Reset" screen

➤ For details, refer to *Returning the navigation system to the initial state* on this page.

Restoring the default setting

Resets various settings registered to the navigation system and restores them to the default or factory settings.

Be sure to read "Setting items to be deleted" before you perform this operation.

➤ For details, refer to *Setting items to be deleted* on the next page.

1 Display the "System Settings" screen.

➤ For details, refer to *Displaying the screen for system settings* on page 139.

2 Touch [Restore Factory Settings].

The message confirming whether to restore the settings appears.

3 Touch [Yes].

Returning the navigation system to the initial state

You can return settings or recorded content to the default or factory settings.

Be sure to read "Setting items to be deleted" before you perform this operation.

➤ For details, refer to *Setting items to be deleted* on the next page.

1 Park your vehicle in a safe place and apply the handbrake.

2 Turn the ignition switch off and back on.

The navigation system restarts, and the splash screen appears.

3 Press and hold the MODE button and the TRK (◀◀) button while the splash screen appears.

For users of AVIC-F30BT, press the **MODE** button and the **TRK** (◀) button.

The "Select Items to Reset" screen appears.

4 Touch [Clear user information] or [Reset].

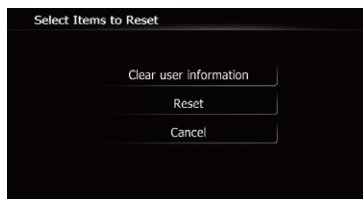

The message confirming whether to erase the data appears.

5 Touch [Yes].

The recorded contents are cleared.

Other functions

Setting items to be deleted

The items to be deleted vary depending on the reset method. The items listed in the following table return to the default or factory settings. Any items not listed below will be retained.

—: The setting will be retained.

✓: The setting will be cleared and returned to the default or factory settings.

□ Bold indicates functions or command names.

- **Method 1: Remove the vehicle battery**
- **Method 2: Touch [Restore Factory Settings]**
- **Method 3: Touch [Clear user information] on the "Select Items to Reset" screen**
- **Method 4: Touch [Reset] on the "Select Items to Reset" screen**

Navigation functions	Method 1	Method 2	Method 3	Method 4	
Map function	View mode and scale setting on the map	—	—	✓	✓
	Direction of the map	—	—	✓	✓
	Last cursor position on the map screen	—	✓	✓	✓
Route setting	Current route	✓	—	✓	✓
	Guidance state of the current route	—	—	✓	✓
	Vehicle position information	—	—	✓	✓
	Options	—	✓	✓	✓
Others	Keyboard	—	✓	✓	✓
	Learnt data used in Learning Route	✓	—	✓	✓
Destination	Point registered in Favourites	—	—	✓	—
	History	—	—	✓	—
Map Settings	View Mode	—	—	✓	✓
	Other settings	—	✓	✓	✓
Navi Settings	3D Calibration Status	—	—	—	—
	Drive Log Settings	—	—	✓	—
	Demo Mode	✓	✓	✓	✓
	Set Home	—	—	✓	—
	Modify Current Location	—	—	✓	✓
	Other settings	—	✓	✓	✓
System Settings	Program Language, Voice Language	—	—	✓	✓
	Time	—	—	✓	✓
	Back Camera	✓	—	—	—
	Other settings	—	✓	✓	✓

Other functions

Navigation functions		Method 1	Method 2	Method 3	Method 4
Bluetooth Settings	All settings (*1)	—	✓	✓	✓
Phone Menu	All settings (*1)	—	✓	✓	✓
Other functions	Anti-theft password	—	—	—	—

(*1) All stored data of 5 users is deleted.

AV functions		Method 1	Method 2	Method 3	Method 4
Volume		✓	—	—	—
AV Settings	Wide Mode, Mute	✓	—	✓	✓
	Other settings	✓	—	—	—
AV Sound	All settings	✓	—	—	—
CD, ROM, DVD-V, DivX, FM, AM, Audio (Bluetooth audio)	All settings (*2)	✓	—	—	—
SD, USB	All settings (*2)	✓	—	✓	✓
Other functions	Picture Adjustment	✓	—	—	—
	Tilt	✓	—	—	—

(*2) All settings including the setting on the "Function" menu are deleted.



Appendix

Troubleshooting

If you have problems operating your navigation system, refer to this section. The most common problems are listed below, along with likely causes and solutions. If a solution to your problem cannot be found here, contact your dealer or the nearest authorised Pioneer service facility.

Problems with the navigation screen

Symptom	Cause	Action (Reference)
The power doesn't turn on. The navigation system doesn't operate.	Leads and connectors are incorrectly connected.	Confirm once more that all connections are correct.
	The fuse is blown.	Rectify the reason for the fuse blowing, then replace the fuse. Be very sure to install a correct fuse with the same rating.
	Noise and other factors are causing the built-in microprocessor to operate incorrectly.	Park your vehicle in a safe place, and turn off the engine. Turn the ignition key back to off (ACC OFF). Then start the engine again, and turn the power to the navigation system back on.
You cannot position your vehicle on the map without a significant positioning error.	The GPS aerial is in an unsuitable location.	The quality of signals from the GPS satellites is poor, causing reduced positioning accuracy. Check the GPS signal reception and the position of the GPS aerial if necessary.
	Obstacles are blocking signals from the satellites.	The quality of signals from the GPS satellites is poor, causing reduced positioning accuracy. Check the GPS signal reception and the position of the GPS aerial if necessary, or continue driving until reception improves. Keep the aerial clean.
	The position of satellites relative to your vehicle is inadequate.	The quality of signals from the GPS satellites is poor, causing reduced positioning accuracy. Continue driving until reception improves.
	Signals from the GPS satellites have been modified to reduce accuracy. (GPS satellites are operated by the US Department of Defense, and the US government reserves the right to distort positioning data for military reasons. This may lead to greater positioning errors.)	The quality of signals from the GPS satellites is poor, causing reduced positioning accuracy. Wait until reception improves.
	If a vehicle phone or mobile phone is used near the GPS aerial, GPS reception may be lost temporarily.	The quality of signals from the GPS satellites is poor, causing reduced positioning accuracy. When using a mobile phone, keep the aerial of the mobile phone away from the GPS aerial.

Appendix

Symptom	Cause	Action (Reference)
You cannot position your vehicle on the map without a significant positioning error.	Something covers the GPS aerial.	Do not cover the GPS aerial with spray paint or vehicle wax, because this may block the reception of GPS signals. Snow buildup can also degrade the signals.
	Signals from the vehicle's speed pulse are not being picked up properly.	Check that the cables are properly connected. If necessary, consult the dealer that installed the system.
	The navigation system may not be mounted securely in your vehicle.	Check that the navigation system is securely mounted and, if necessary, consult the dealer that installed the system.
	The navigation system is installed with an extreme angle exceeding the installation angle limitations.	Confirm the installation angle. (The navigation system must be installed within the allowed installation angle. For details, refer to Installation Manual.)
	Indication of the position of your vehicle is misaligned after a U-turn or reversing.	Check whether or not the reverse gear signal input lead (violet) is connected properly. (The navigation system works properly without the lead connected, but positioning accuracy will be adversely affected.)
"Eco Graph" is not available.	The navigation system is unable to obtain past average fuel mileage data, so "Eco Graph" cannot be displayed.	Drive about 10 km on a road without obstructions. Then park your vehicle in a safe place, turn off the navigation system and turn the power to the navigation system back on.
The map colour does not switch automatically between daytime and nighttime.	"Day/Night Display" is set to "Day".	Check "Day/Night Display" setting and make sure "Automatic" is selected. (Page 137)
	The orange/white lead is not connected.	Check the connection.
The screen is too bright.	Picture quality adjustment of the display is not correct.	Adjust the picture quality. (Page 146)
The display is very dim.	The vehicle's light is turned ON, and "Automatic" is selected on "Day/Night Display".	Read about "Day/Night Display" setting and, if desired, select "Day". (Page 137)
	Picture quality adjustment of the display is not correct.	Adjust the picture quality. (Page 146)
No sounds of AV source are produced. The volume level will not rise.	The volume level is low.	Adjust the volume level.
	The attenuator or mute is on.	Turn the attenuator or mute off.
	A speaker lead is disconnected.	Check the connection.
The volume of navigation guidance and beeps cannot be adjusted.	VOL (+/-) button or Multi-control is used to adjust the volume.	Turn the volume up or down using "Volume" on the "System Settings" menu. (Page 142)
The person on the other end of the phone call cannot hear the conversation due to an echo.	The voice from the person on the other end of the phone call is output from the speakers and then picked up by the microphone again, creating an echo.	Use the following methods to reduce the echo: —Lower the volume on the receiver —Have both parties pause slightly before speaking

Appendix

Symptom	Cause	Action (Reference)
There's no picture.	The handbrake cord is not connected.	Connect the handbrake cord, and apply the handbrake.
	The handbrake is not applied.	Connect the handbrake cord, and apply the handbrake.
	The backlight of the LCD panel is turned off.	Turn on the backlight. (Page 159)
Rear display picture disappears.	The source disc being listened to in the navigation system has been ejected.	Before ejecting the disc, switch the source. This problem may occur when certain connection methods are used.
	There is a problem with the rear display, for example a faulty wiring connection.	Check the rear display and its connection.
	An AV source that cannot output to the rear display is selected.	Select an appropriate AV source.
Nothing is displayed and the touch panel keys cannot be used.	The setting for the rear view camera is incorrect.	Select the appropriate setting for the rear view camera.
	The gearstick was placed in [R] when the rear view camera was not connected.	Select the correct polarity setting for " Back Camera ". (Page 143)
There is no response when the touch panel keys are touched, or a different key responds.	The touch panel keys deviate from the actual positions that respond to your touch for some reason.	Perform touch panel calibration. (Page 144)
The external storage device (USB, SD) cannot be used.	The USB storage device has been removed immediately after plugging it.	Park your vehicle in a safe place, and turn off the engine. Turn the ignition key back to off (ACC OFF). Then start the engine again, and turn the power to the navigation system back on.

Problems in the AV screen

Symptom	Cause	Action (Reference)
CD or DVD playback is not possible.	The disc is inserted upside down.	Insert the disc with the label upward.
	The disc is dirty.	Clean the disc.
	The disc is cracked or otherwise damaged.	Insert a normal, round disc.
	The files on the disc are an irregular file format.	Check the file format.
	The disc format cannot be played back.	Replace the disc.
	The loaded disc is a type this system cannot play.	Check what type of disc it is. (Page 186)
The screen is covered by a caution message and the video cannot be shown.	The handbrake lead is not connected or applied.	Connect the handbrake lead correctly, and apply the handbrake.
	The handbrake interlock is activated.	Park your vehicle in a safe place and apply the handbrake.

Appendix

Symptom	Cause	Action (Reference)
No video output from connected equipment.	"AV1 Input" or "AV2 Input" setting is incorrect.	Correct the settings. (Page 125)
No video output from connected iPod.	The connection of the USB interface cable for iPod is incorrect.	Connect both the USB plug and the RCA cable side. (If only one of these connection has been made, the iPod will not work properly.) (Page 20)
The audio or video skips.	The navigation system is not firmly secured.	Secure the navigation system firmly.
No sounds are produced.	Cables are not connected correctly.	Connect the cables correctly.
The volume level will not rise.	The system is performing still, slow motion, or frame-by-frame playback with DVD-Video.	There is no sound during still, slow motion, or frame-by-frame playback with DVD-Video.
	The system is paused or performing, fast reverse or forward during the disc playback.	For the media other than music CD (CD-DA), there is no sound on fast reverse or forward.
The icon  is displayed, and operation is not possible.	The operation is not compatible with the video configuration.	This operation is not possible. (For example, the DVD playing does not feature that angle, audio system, subtitle language, etc.)
The picture stops (pauses) and the navigation system cannot be operated.	The reading of data is impossible during disc playback.	Stop playback once, and start playback again.
The picture is stretched, with incorrect aspect ratio.	The aspect setting is incorrect for the display.	Select the appropriate setting for that image. (Page 148, Page 103)
A parental lock message is displayed and DVD playback is not possible.	Parental lock is on.	Turn parental lock off or change the level. (Page 103)
Parental lock for DVD playback cannot be cancelled.	The code number is incorrect.	Input the correct code number. (Page 103)
Playback is not with the audio language and subtitle language settings selected in "DVD/DivX® Setup".	The DVD playing does not feature dialogue or subtitles in the language selected in "DVD/DivX® Setup".	Switching to a selected language is not possible if the language selected in "DVD/DivX® Setup" is not recorded on the disc. (Page 102)
The picture is extremely unclear/distorted and dark during playback.	The disc features a signal to prohibit copying. (Some discs may have this.)	Since the navigation system is compatible with the copy guard analogue copy protect system, the picture may suffer from horizontal stripes or other imperfections when a disc with that kind of protection signal is viewed on some displays. This does not mean the navigation system is malfunctioning.
iPod cannot be operated.	The iPod is frozen.	<ul style="list-style-type: none"> • Reconnect the iPod with the USB interface cable for iPod. • Update the iPod software version.
	An error has occurred.	<ul style="list-style-type: none"> • Reconnect the iPod with the USB interface cable for iPod. • Park your vehicle in a safe place, and turn off the engine. Turn the ignition key back to off (ACC OFF). Then start the engine again, and turn the power to the navigation system back on. • Update the iPod software version.

Appendix

Problems with the phone screen

Symptom	Cause	Action (Reference)
Dialling is not possible because the touch panel keys for dialling are inactive.	Your phone is out of range for service.	Retry after re-entering the range for service.
	The connection between the mobile phone and the navigation system cannot be established now.	Perform the connection process.

If the screen becomes frozen...

Park your vehicle in a safe place, and turn off the engine. Turn the ignition key back to off (ACC OFF). Then start the engine again, and turn the power to the navigation system back on.



Appendix

Messages and how to react to them

The following messages may be displayed by your navigation system. Refer to the table below to identify the problem, then take the suggested corrective action.

There are occasions when you may see error messages other than those shown here. In such a case, follow the instructions given on the display.

Messages for navigation functions

Message	Cause	Action (Reference)
Route calculation was not possible.	Route calculation has failed because of a malfunction in map data, software, or hardware.	<ul style="list-style-type: none"> • Change the destination. • Consult the Pioneer Local dealer if this message persists.
Route calculation not possible: destination is too far.	The destination is too far.	Set a destination closer to the starting point.
Route calculation not possible: destination is too close.	The destination is too close.	Set a destination farther from the starting point.
Route calculation not possible: navigation cannot be provided around destination or starting point.	The destination, waypoint(s), or starting point are in an area where no road exists (e.g. a mountain) and the route calculation is impossible.	<ul style="list-style-type: none"> • Set a destination and waypoint(s) on roads. • Reset the destination after you drive the vehicle to any road.
Route to destination cannot be calculated.	The destination or waypoint(s) are in an isolated island, etc. without a ferry and the route calculation is impossible. If there is no road connected to your starting point or destination, this message will appear.	Change the destination.
Failed to make the route profile.	In rare cases, a route calculation error may occur.	<ul style="list-style-type: none"> • Retry. • Consult the Pioneer Local dealer if this message persists.
No picture folder. Save jpeg file to /Pictures/ folder	Cannot load the image because "Pictures" folder is not found in the inserted external storage device.	Use appropriate data and store it correctly. (Page 143)
	"Pictures" folder exists on the SD memory card but there is no loadable data in the folder.	Use appropriate data and store it correctly. (Page 143)
Data Read error.	Failed to read the data for some reason.	Use appropriate data and store it correctly. (Page 143)
The file is corrupt	The data is damaged or an attempt was made to set an image file that was not made to specifications as the splash screen.	Use appropriate data and store it correctly. (Page 143)

Appendix

Message	Cause	Action (Reference)
Connection failed.	The mobile phone's Bluetooth wireless technology is turned off.	Activate the target phone's Bluetooth wireless technology.
	The mobile phone is paired (connected) with another device.	Cancel the pairing (connection) and retry.
	Rejection has been received from the mobile phone.	Operate the target phone and accept the connection request from the navigation system. (Furthermore, check the connection settings on your mobile phone.)
	The target mobile phone cannot be found.	Check whether your mobile phone is activated and, whether the distance to your mobile phone is not too far.
Could not find any available phone.	No available phone exists in the surroundings when the system searches for connectable mobile phones featuring Bluetooth wireless technology.	<ul style="list-style-type: none"> • Activate the target phone's Bluetooth wireless technology. • Check whether your mobile phone is activated and, whether the distance to your mobile phone is not too far.
Registration failed.	The mobile phone's Bluetooth wireless technology is turned off during the registration step.	Keep turning the target phone's Bluetooth wireless technology on during the registration.
	Rejection by the mobile phone has received.	Operate the target phone and accept the registration request from the navigation system. (Furthermore, check the connection settings on your mobile phone.)
	Registration step has failed for some reason.	Retry the registration and if the registration still fails, try registering using your mobile phone.



Appendix

Messages for audio functions

When problems occur with AV source playback, an error message appears on the display. Refer to the table below to identify the problem, then take the suggested corrective action. If the error persists, record the error message and contact your dealer or your nearest Pioneer service centre. The messages in “()” will appear on the rear display.

Built-in DVD drive

Message	Cause	Action (Reference)
Reading error (ERROR-02-XX)	Dirty	Clean the disc.
	Scratched disc	Replace the disc.
	The disc is loaded upside down.	Check that the disc is loaded correctly.
Playback error. Please remove the disc.	There is an electrical or mechanical error.	<ul style="list-style-type: none"> • Replace the disc. • Set the ACC to off and then set it to on again.
Region code cannot be matched (DIFFERENT REGION DISC)	The disc does not have the same region number as the navigation system.	Replace the DVD-Video with one bearing the correct region number.
Unreadable disc	This type of disc cannot be played by the navigation system.	Replace the disc with one the navigation system can play. (Page 189, Page 205)
Playback error due to irregular temperature. Please remove the disc. (THERMAL PROTECTION IN MOTION)	The temperature of the navigation system is out of the normal operating range.	Wait until the unit's temperature returns to within normal operating limits.
Tracks that cannot be played back will be skipped (FILE SKIPPED)	Files that are protected by digital rights management (DRM).	The protected files are skipped.
Cannot play back all tracks (PROTECTED DISC)	All the files on the inserted disc are secured by DRM.	Replace the disc.
Flash write error. Unable to write to flash memory. (CAN NOT SAVE DATA)	The playback history for VOD contents cannot be saved for some reason.	<ul style="list-style-type: none"> • Retry. • If the message appears frequently, consult your dealer.
Your device is not authorised to play this protected DivX video. (YOUR DEVICE IS NOT AUTHORIZED TO PLAY THIS DivX PROTECTED VIDEO)	The device does not match the device registered with the VOD provider. VOD content cannot be played back.	Check whether this device has been registered with the VOD provider.
Video resolution not supported. (VIDEO RESOLUTION NOT SUPPORTED)	High definition (HD) DivX video cannot be played.	Create playable one and retry.

SD/USB/iPod

Message	Cause	Action (Reference)
Tracks that cannot be played back will be skipped	Files that are protected by digital rights management (DRM).	The protected files are skipped.
	This type of file cannot be played by this unit.	Replace it with the playable file. (Page 189, Page 205)

Appendix

Message	Cause	Action (Reference)
Cannot play back all tracks	All the files on the inserted external storage device are secured by DRM.	Store playable files.
	All of the files cannot be played by this unit.	Replace it with the playable file. (Page 189, Page 205)
USB flash drive was disconnected for device protection. Do not connect this USB flash drive to the unit. To restart USB, restart the unit.	The USB connector or USB cable is short-circuited.	Confirm that the USB connector or USB cable is not caught in something or damaged.
	The connected USB storage device consumes more than 1 A (maximum allowable current).	Disconnect the USB storage device and do not use it. Turn the ignition switch to off, then back ACC to on or turn the ignition switch on and then connect the compliant USB storage device.
	The USB interface cable for iPod is short-circuited.	Confirm that USB interface cable for iPod or USB cable is not caught in something or damaged.
Authorization failure. iPod is not connected.	The iPod is not compatible with this navigation system.	Use an iPod of a compatible version.
	Communication failure	<ul style="list-style-type: none"> • Disconnect the cable from iPod. Once iPod main menu is displayed, connect the cable again. • If the message appears frequently, consult your dealer.



Appendix

Positioning technology

Positioning by GPS

The Global Positioning System (GPS) uses a network of satellites orbiting the Earth. Each of the satellites, which orbit at a height of 21 000 km, continually broadcasts radio signals giving time and position information. This ensures that signals from at least three can be picked up from any open area on the earth's surface.

The accuracy of the GPS information depends on how good the reception is. When the signals are strong and reception is good, GPS can determine latitude, longitude and altitude for accurate positioning in three dimensions. But if signal quality is poor, only two dimensions, latitude and longitude, can be obtained and positioning errors are somewhat greater.

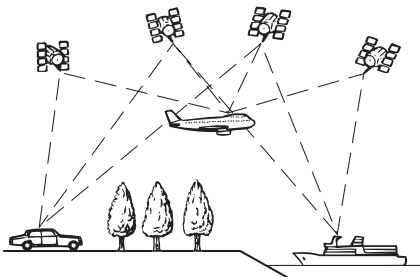

Positioning by dead reckoning

The built-in sensor in the navigation system also calculates your position. The current location is measured by detecting driving distance with the speed pulse, the turning direction with the gyro sensor and inclination of the road with the G sensor.

The built-in sensor can even calculate changes of altitude, and correct the discrepancies in the distance travelled caused by driving along winding roads or up slopes.

If you use this navigation system with connecting the speed pulse, the system will become more accurate than no connection of speed

pulse. So you connect the speed pulse without fail to get the accuracy of positioning.

- ❑ The position of the speed detection circuit vary depending on the vehicle model. For details, consult your authorised Pioneer dealer or an installation professional.
- ❑ Some types of vehicles may not output a speed signal while driving at just a few kilometres per hour. In such a case, the current location of your vehicle may not be displayed correctly while in traffic jam or in a car park.

How do GPS and dead reckoning work together?

For maximum accuracy, your navigation system continually compares GPS data with your estimated position as calculated from the data of built-in sensor. However, if only the data from the built-in sensor is available for a long period, positioning errors are gradually compounded until the estimated position becomes unreliable. For this reason, whenever GPS signals are available, they are matched with the data of the built-in sensor and used to correct it for improved accuracy.

- ❑ If you use chains on your wheels for winter driving or put on the spare wheel, errors may suddenly increase because of difference in wheel diameter. Initialise the sensor status and it may recover the accuracy to normal condition.
 - ➔ For details, refer to *Clearing status* on page 127.

Appendix

Map matching

As mentioned, the positioning systems used by this navigation system are susceptible to certain errors. Their calculations may, on occasion, place you in a location on the map where no road exists. In this situation, the processing system understands that vehicles travel only on roads, and can correct your position by adjusting it to a nearby road. This is called map matching.

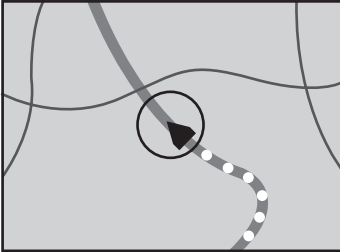

With map matching

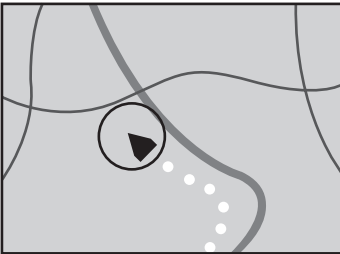

Without map matching



Handling large errors

Positioning errors are kept to a minimum by combining GPS, dead reckoning and map matching. However, in some situations, these functions may not work properly, and the error may become bigger.

When positioning by GPS is impossible

- GPS positioning is disabled if signals cannot be received from more than two GPS satellites.
- In some driving conditions, signals from GPS satellites may not reach your vehicle. In this case, it is impossible for the system to use GPS positioning.



In tunnels or enclosed parking garages

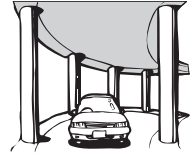

Under elevated roads or similar structures



When driving among high buildings



When driving through a dense forest or tall trees

- If a car phone or mobile phone is used near the GPS aerial, GPS reception may be lost temporarily.
- Do not cover the GPS aerial with spray paint or car wax, because this may block the reception of GPS signals. Snow buildup can also degrade the signals, so keep the aerial clear.
- ❑ If a GPS signal has not been received for a long time, your vehicle's actual position and the current position mark on the map may diverge considerably or may not be updated. In such case, once GPS reception is restored, accuracy will be recovered.

Appendix

Conditions likely to cause noticeable positioning errors

For various reasons, such as the state of the road you are travelling on and the reception status of the GPS signal, the actual position of your vehicle may differ from the position displayed on the map screen.

- If you make a slight turn.

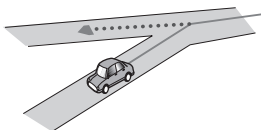

- If there is a parallel road.

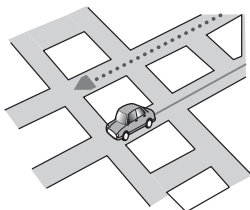

- If there is another road very nearby, such as in the case of an elevated motorway.

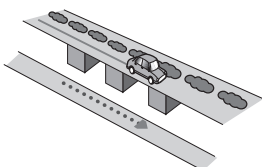

- If you take a recently opened road that is not on the map.

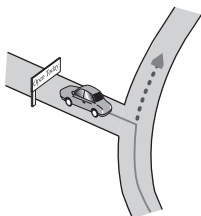

- If you drive in zigzags.

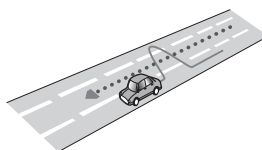

- If the road has a series of hairpin bends.

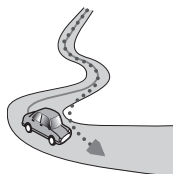

- If there is a loop or similar road configuration.

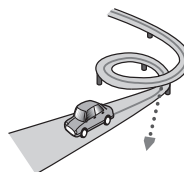

- If you take a ferry.

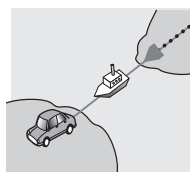

- If you are driving on a long, straight road or a gently curving road.

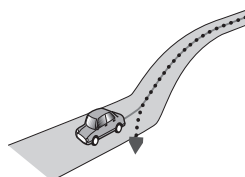

Appendix

- If you are on a steep mountain road with many height changes.

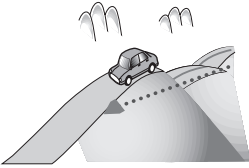

- If you enter or exit a multi-storey car park or similar structure using a spiral ramp.

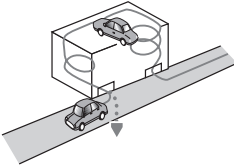

- If your vehicle is turned on a turntable or similar structure.

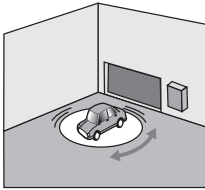

- If your vehicle's wheels spin, such as on a rough track or in snow.



- If you put on chains, or change your tyres for ones with a different size.

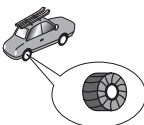

- If trees or other obstacles block the GPS signals for a considerable period.

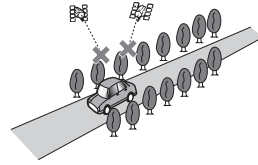

- If you drive very slowly, or in a start-and-stop manner, as in a traffic jam.

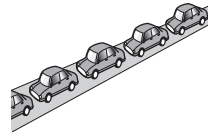

- If you join the road after driving around a large car park.

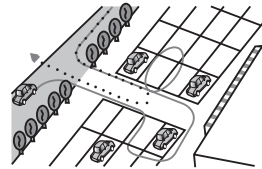

- When you drive around a roundabout.

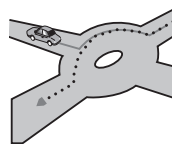

- When starting driving immediately after starting the engine.

Appendix

Route setting information

Route search specifications

Your navigation system sets a route to your destination by applying certain built-in rules to the map data. This section provides some useful information about how a route is set.



CAUTION

When a route is calculated, the route and voice guidance for the route are automatically set. Also, for day or time traffic regulations, only information about traffic regulations applicable at the time when the route was calculated is considered. One-way streets and street closures may not be taken into consideration. For example, if a street is open during the morning only, but you arrive later, it would be against the traffic regulations so you cannot drive along the set route. When driving, please follow the actual traffic signs. Also, the system may not know some traffic regulations.

- The calculated route is one example of the route to your destination decided by the navigation system while taking the type of streets or traffic regulations into account. It is not necessarily an optimum route. (In some cases, you may not be able to set the streets you want to take. If you need to take a certain street, set a waypoint on that street.)
- If the destination is too far, there may be instances where the route cannot be set. (If you want to set a long-distance route going across several areas, set waypoints along the way.)
- During voice guidance, turns and intersections from the motorway are announced. However, if you pass intersections, turns, and other guidance points in rapid succession, some may delay or not be announced.
- It is possible that guidance may direct you off a motorway and then back on again.
- In some cases, the route may require you to travel in the opposite direction to your

current heading. In such cases, you are instructed to turn around, so please turn around safely by following the actual traffic rules.

- In some cases, a route may begin on the opposite side of a railway or river from your actual current location. If this happens, drive towards your destination for a while, and try route calculation again.
- When there is a traffic jam ahead, a detour route may not be suggested if driving through the traffic jam would still be better than taking the detour.
- There may be instances when the starting point, the waypoint and the destination point are not on the highlighted route.
- The number of roundabout exits displayed on the screen may differ from the actual number of roads.

Route highlighting

- Once set, the route is highlighted in bright colour on the map.
- The immediate vicinity of your starting point and destination may not be highlighted, and neither will areas with particularly complex road layouts. Consequently, the route may appear to be cut off on the display, but voice guidance will continue.

Auto reroute function

- If you deviate from the set route, the system will re-calculate the route from that point so that you remain on track to the destination.
- This function may not work under certain conditions. 

Handling and care of discs

Some basic precautions are necessary when handling your discs.

Appendix

Built-in drive and care

- Use only conventional, fully circular discs. Do not use shaped discs.



- Do not use cracked, chipped, warped, or otherwise damaged discs as they may damage the built-in drive.
- When using discs that can be printed on label surfaces, check the instructions and the warnings of the discs. Depending on the discs, inserting and ejecting may not be possible. Using such discs may result in damage to this equipment.
- Do not touch the recorded surface of the discs.
- Store discs in their cases when not in use.
- Avoid leaving discs in excessively hot environments including under direct sunlight.
- Do not attach labels, write on or apply chemicals to the surface of the discs.
- Do not attach commercially available labels or other materials to the discs.
 - The discs may warp making the disc unplayable.
 - The labels may come off during playback and prevent ejection of the discs, which may result in damage to the equipment.
- To clean a disc, wipe it with a soft cloth, moving outward from the centre.



- Condensation may temporarily impair the built-in drive's performance. Leave it to adjust to the warmer temperature for about one hour. Also, wipe any damp discs with a soft cloth.

- Playback of discs may not be possible because of disc characteristics, disc format, recorded application, playback environment, storage conditions and so on.
- Road shocks may interrupt disc playback.
- Read the precautions for discs before using them.

Ambient conditions for playing a disc

- At extremely high temperatures, a temperature cutout protects this product by switching it off automatically.
- Despite our careful design of the product, small scratches that do not affect actual operation may appear on the disc surface as a result of mechanical wear, ambient conditions for use or handling of the disc. This is not a sign of the malfunction of this product. Consider it to be normal wear and tear. ■

Playable discs

DVD-Video and CD

DVD and CD discs that display the logos shown below generally can be played on this built-in DVD drive.

DVD-Video



CD



Appendix

- ❑ **DVD** is a trademark of DVD Format/Logo Licensing Corporation.
- ❑ It is not possible to play DVD-Audio discs. This DVD drive may not be able to play all discs bearing the marks shown above.



AVCHD recorded discs

This unit is not compatible with discs recorded in AVCHD (Advanced Video Codec High Definition) format. Do not insert AVCHD discs. If inserted, the disc may not be ejected.

Playing DualDisc

- DualDiscs are two-sided discs that have a recordable CD for audio on one side and a recordable DVD for video on the other.
- Playback of the DVD side is possible with this navigation system. However, since the CD side of DualDiscs is not physically compatible with the general CD standard, it may not be possible to play the CD side with this navigation system.
- Frequent loading and ejecting of a DualDisc may result in scratches to the disc.
- Serious scratches can lead to playback problems on this navigation system. In some cases, a DualDisc may become stuck in the disc-loading slot and will not eject. To prevent this, we recommend you refrain from using DualDisc with this navigation system.
- Please refer to the manufacturer for more detailed information about DualDiscs.

Dolby Digital

This product will down-mix Dolby Digital signals internally and the sound will be output in stereo.

- ❑ Manufactured under licence from Dolby Laboratories. "Dolby" and the double-D symbol are trademarks of Dolby Laboratories.

Detailed information for playable media

Compatibility

Common notes about disc compatibility

- Certain functions of this product may not be available for some discs.
- Compatibility with all discs is not guaranteed.
- It is not possible to playback DVD-ROM/ DVD-RAM discs.
- Playback of discs may become impossible with direct exposure to sunlight, high temperatures, or depending on the storage conditions in the vehicle.

DVD-Video discs

- DVD-Video discs that have incompatible region numbers cannot be played on this DVD drive. The region number of the player can be found on this product's chassis.

DVD-R/DVD-RW/DVD-R DL (Dual Layer) discs

- Unfinalised discs which have been recorded with the Video format (video mode) cannot be played back.
- Discs which have been recorded with the Video Recording format (VR mode) cannot be played back.
- DVD-R DL (Dual Layer) discs which have been recorded with Layer Jump recording cannot be played back.
- For detailed information about recording mode, please contact the manufacturer of media, recorders, or writing software.

Appendix

CD-R/CD-RW discs

- Unfinalised discs cannot be played back.
- It may not be possible to playback CD-R/CD-RW discs recorded on a music CD recorder or a personal computer because of disc characteristics, scratches or dirt on the disc, or dirt, scratches or condensation on the lens of the built-in drive.
- Playback of discs recorded on a personal computer may not be possible, depending on the recording device, writing software, their settings, and other environmental factors.
- Please record with the correct format. (For details, please contact manufacturer of media, recorders, or writing software.)
- Titles and other text information recorded on a CD-R/CD-RW disc may not be displayed by this product (in the case of audio data (CD-DA)).
- Read the precautions with CD-R/CD-RW discs before using them.

Common notes about the external storage device (USB, SD)

- Do not leave the external storage device (USB, SD) in any location with high temperatures.
- Depending on the kind of the external storage device (USB, SD) you use, this navigation system may not recognise the storage device or files may not be played back properly.
- The text information of some audio and video files may not be correctly displayed.
- File extensions must be used properly.
- There may be a slight delay when starting playback of files on an external storage device (USB, SD) with complex folder hierarchies.
- Operations may vary depending on the kind of an external storage device (USB, SD).
- It may not be possible to play some music files from SD or USB because of file characteristics, file format, recorded applica-

tion, playback environment, storage conditions, and so on.

USB storage device compatibility

- ➔ For details about USB storage device compatibility with this navigation system, refer to *Specifications* on page 205.
- Protocol: bulk
- You cannot connect a USB storage device to this navigation system via a USB hub.
- Partitioned USB storage device is not compatible with this navigation system.
- Firmly secure the USB storage device when driving. Do not let the USB storage device fall onto the floor, where it may become jammed under the brake or accelerator pedal.
- There may be a slight delay when starting playback of audio files encoded with image data.
- Some USB storage devices connected to this navigation system may generate noise on the radio.
- Do not connect anything other than the USB storage device.

The sequence of audio files on USB storage device

For USB storage device, the sequence is different from that of USB storage device.

SD memory card and SDHC memory card

- ➔ For details about SD memory card compatibility with this navigation system, refer to *Specifications* on page 205.

Handling guidelines and supplemental information

- This system is not compatible with Multi Media Card (MMC).
- Copyright protected files cannot be played back.

Appendix

Notes specific to DivX files

- Only DivX files downloaded from DivX partner sites are guaranteed for proper operation. Unauthorised DivX files may not operate properly.
- DRM rental files cannot be operated until playing back is started.
- The navigation system corresponds to a DivX file display of up to 1 590 minutes 43 seconds. Search operations beyond this time limit are prohibited.
- DivX VOD file playback requires supplying the ID code of this navigation system to the DivX VOD provider. Regarding the ID code, refer to *Displaying your DivX VOD registration code* on page 151.
- Plays all versions of DivX video (including DivX 6) with standard playback of DivX media files.
- For more details about DivX, visit the following site:
<http://www.divx.com/>

DivX subtitle files

- Srt format subtitle files with the extension “.srt” can be used.
- Only one subtitle file can be used for each DivX file. Multiple subtitle files cannot be associated.
- Subtitle files that are named with the same character string as the DivX file before the extension are associated with the DivX file. The character strings before the extension must be exactly the same. However, if there is only one DivX file and one subtitle file in a single folder, the files are associated even if the file names are not the same.
- The subtitle file must be stored in the same folder as the DivX file.
- Up to 255 subtitle files may be used. Any more subtitle files will not be recognised.
- Up to 64 characters can be used for the name of the subtitle file, including the extension. If more than 64 characters are used for the file name, the subtitle file may not be recognised.
- The character code for the subtitle file should comply with ISO-8859-1. Using characters other than ISO-8859-1 may cause the characters to be displayed incorrectly.
- The subtitles may not be displayed correctly if the displayed characters in the subtitle file include control code.
- For materials that use a high transfer rate, the subtitles and video may not be completely synchronised.
- If multiple subtitles are programmed to display within a very short time frame, such as 0.1 seconds, the subtitles may not be displayed at the correct time.

Appendix

Media compatibility chart

General

Media	CD-R/-RW	DVD-R/-RW/-R DL	USB storage de- vice	SD memory card
File system	ISO9660 level 1, ISO9660 level 2, Romeo and Joliet	ISO9660 level 1, ISO9660 level 2, Romeo, Joliet and UDF 1.02	FAT16/FAT32	
Maximum number of folders	700		300	
Maximum number of files	999	3 500	2 500	
Playable file types	MP3, WMA, AAC, DivX		MP3, WMA, AAC, WAV, AVI, WMV, MPEG-4	
Note:	Maximum playback time of audio file stored in the external storage device (USB, SD): 7.5 h (450 minutes)			

MP3 compatibility

Media	CD-R/-RW	DVD-R/-RW/-R DL	USB storage de- vice	SD memory card
File extension	.mp3			
Bit rate	8 kbps to 320 kbps (CBR), VBR			
Sampling frequency	16 kHz to 48 kHz (32 kHz, 44.1 kHz, 48 kHz for emphasis)		8 kHz to 48 kHz	
ID3 tag	ID3 tag Ver. 1.0, 1.1, 2.2, 2.3		ID3 tag Ver. 1.0, 1.1, 2.2, 2.3, 2.4	
Notes:	<ul style="list-style-type: none"> Ver. 2.x of ID3 tag is given priority when both Ver. 1.x and Ver. 2.x exist. The navigation system is not compatible with the following: MP3i (MP3 interactive), mp3 PRO, m3u playlist 			

Appendix

WMA compatibility

Media	CD-R/-RW	DVD-R/-RW/-R DL	USB storage de- vice	SD memory card
File extension	.wma			
Bit rate	5 kbps to 320 kbps (CBR), VBR			
Sampling frequency	8 kHz to 48 kHz			
Note: The navigation system is not compatible with the following: Windows Media™ Audio 9 Professional, Lossless, Voice				

WAV compatibility

Media	CD-R/-RW	DVD-R/-RW/-R DL	USB storage de- vice	SD memory card
File extension	WAV files on the CD-R/-RW, DVD-R/-RW/-R DL cannot be played.		.wav	
Format			Linear PCM (LPCM), IMA-ADPCM	
Sampling frequency			LPCM: 16 kHz to 48 kHz IMA-ADPCM: 22.05 kHz and 44.1 kHz	
Quantisation bits			LPCM: 8 bits and 16 bits MS ADPCM: 4 bits	
Note: The sampling frequency shown in the display may be rounded.				

AAC compatibility

Media	CD-R/-RW	DVD-R/-RW/-R DL	USB storage de- vice	SD memory card
File extension	.m4a			
Bit rate	8 kbps to 320 kbps (CBR)			
Sampling frequency	8 kHz to 44.1 kHz		8 kHz to 48 kHz	
Note: The navigation system plays back AAC files encoded by iTunes.				

Appendix

DivX compatibility

Media	CD-R/-RW	DVD-R/-RW/-R DL	USB storage device	SD memory card
File extension	.avi/.divx		DivX files on the external storage device (USB, SD) cannot be played.	
Profile (DivX version)	Home Theater Ver. 3.11/Ver. 4.x/Ver. 5.x/Ver. 6.x			
Compatible audio codec	MP3, Dolby Digital			
Bit rate (MP3)	8 kbps to 320 kbps (CBR), VBR			
Sampling frequency (MP3)	16 kHz to 48 kHz (32 kHz, 44.1 kHz, 48 kHz for emphasis)			
Maximum image size	720 pixels × 576 pixels			
Maximum file size	4 GB			
Notes:				
<ul style="list-style-type: none"> The navigation system is not compatible with the following: DivX Ultra format, DivX files without video data, DivX files encoded with LPCM (Linear PCM) audio codec Depending on the file information composition, such as the number of audio streams, there may be a slight delay in the start of playback on discs. If a file contains more than 4 GB, playback stops before the end. Some special operations may be prohibited because of the composition of DivX files. Files with high transfer rates may not be played back correctly. The standard transfer rate is 4 Mbps for CDs and 10.08 Mbps for DVDs. 				

Appendix

Video files compatibility (USB, SD)

File extension		.avi	.mp4, .m4v		.wmv
Format		MPEG-4	MPEG-4	H.264	WMV
Compatible video codec		MPEG-4	MPEG-4	H.264	WMV
Compatible audio codec		Linear PCM (LPCM), IMA-ADPCM MP3	AAC	AAC	WMA
Recommended video specifications	Image size: QVGA (320 pixels x 240 pixels)	Bit rate: 768 kbps Frame rate: 30 fps	Bit rate: 768 kbps Frame rate: 30 fps	Bit rate: 384 kbps Frame rate: 30 fps	Bit rate: 384 kbps Frame rate: 30 fps
Maximum bit rate:	Image size: WQVGA (400 pixels x 240 pixels)	Bit rate: 2 Mbps Frame rate: 30 fps	Bit rate: 2 Mbps Frame rate: 30 fps	Bit rate: 1 Mbps Frame rate: 30 fps	Bit rate: 768 kbps Frame rate: 30 fps
	Image size: VGA (640 pixels x 480 pixels)	Bit rate: 1 Mbps Frame rate: 30 fps	Bit rate: 1 Mbps Frame rate: 30 fps	Bit rate: 576 kbps Frame rate: 30 fps	Bit rate: 576 kbps Frame rate: 30 fps
Maximum file size		2 GB			
Maximum playback time		150 minutes			

Common notes

- The navigation system may not operate correctly, depending on the application used to encode WMA files.
- Depending on the version of Windows Media™ Player used to encode WMA files, album names and other text information may not be correctly displayed.
- There may be a slight delay when starting playback of audio files encoded with image data.
- The navigation system is not compatible with packet write data transfer.
- This navigation system can recognise up to 32 characters, beginning with the first character, including extension for the file and folder name. Depending on the display area, the navigation system may try to display them with a reduced font size. However, the maximum number of the characters that you can display varies according to the width of each character, and of the display area.
- Folder selection sequence or other operations may be altered, depending on the encoding or writing software.
- Regardless of the length of blank section between the songs of original recording, compressed audio discs play with a short pause between songs.

Appendix

Example of a hierarchy

The following figure is an example of the tier structure in the disc. The numbers in the figure indicate the order in which folder numbers are assigned and the order to be played back.

 Folder

 File

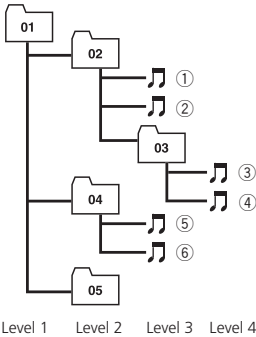

Notes

- This product assigns folder numbers. The user cannot assign folder numbers.
- If there is a folder that does not contain any playable file, the folder itself will display in the folder list but you cannot check any files in the folder. (A blank list will appear.) Also, these folders will be skipped without displaying the folder number. 

Bluetooth



Bluetooth is a short-range wireless radio connectivity technology that is developed as a cable replacement for mobile phones, handheld PCs and other devices. Bluetooth operates in 2.4 GHz frequency range and transmits voice and data at speeds up to 1 megabit per

second. Bluetooth was launched by a special interest group (SIG) comprising Ericsson Inc., Intel Corp., Nokia Corp., Toshiba and IBM in 1998, and it is currently developed by nearly 2000 companies worldwide.

- The *Bluetooth*[®] word mark and logos are registered trademarks owned by Bluetooth SIG, Inc. and any use of such marks by Pioneer Corporation is under licence. Other trademarks and trade names are those of their respective owners. 

SD and SDHC logo



SD Logo is a trademark of SD-3C, LLC.



SDHC Logo is a trademark of SD-3C, LLC.



microSD Logo is a trademark of SD-3C, LLC.



microSDHC Logo is a trademark of SD-3C, LLC. 

Appendix

WMA/WMV

Windows Media is either a registered trademark or trademark of Microsoft Corporation in the United States and/or other countries.

- ❑ This product includes technology owned by Microsoft Corporation and cannot be used or distributed without a licence from Microsoft Licensing, Inc. ❑

DivX



DivX is a compressed digital video format created by the DivX video codec from DivX, Inc. This unit can play DivX video files recorded on CD-R/RW/ROM and DVD-R/RW/ROM discs. Keeping the same terminology as DVD video, individual DivX video files are called "Titles". When naming files/titles on a CD-R/RW or a DVD-R/RW disc prior to burning, keep in mind that by default they will be played in alphabetical order.

- ❑ DivX®, DivX Certified® and associated logos are trademarks of DivX, Inc. and are used under licence.

ABOUT DIVX VIDEO: DivX® is a digital video format created by DivX, Inc. This is an official DivX Certified device that plays DivX video. Visit www.divx.com for more information and software tools to convert your files into DivX video.

ABOUT DIVX VIDEO-ON-DEMAND: This DivX Certified® device must be registered in order to play purchased DivX Video-on-Demand (VOD) movies. To obtain your registration code, locate the DivX VOD section in *Displaying your DivX VOD registration code*. Go to vod.divx.com for more information on how to complete your registration.

- ➔ For details, refer to *Displaying your DivX VOD registration code* on page 151. ❑

AAC

AAC is short for Advanced Audio Coding and refers to an audio compression technology standard used with MPEG-2 and MPEG-4. Several applications can be used to encode AAC files, but file formats and extensions differ depending on the application which is used to encode. This unit plays back AAC files encoded by iTunes. ❑

Detailed information regarding connected iPod devices



CAUTION

- Pioneer accepts no responsibility for data lost from an iPod, even if that data is lost while using the navigation system. Please back up your iPod data regularly.
- Do not leave the iPod in direct sunlight for extended amounts of time. Extended exposure to direct sunlight can result in iPod malfunction due to the resulting high temperature.
- Do not leave the iPod in any location with high temperatures.
- Firmly secure the iPod when driving. Do not let the iPod fall onto the floor, where it may become jammed under the brake or accelerator pedal.

For details, refer to the iPod manuals.

Appendix

iPod and iPhone



“Made for iPod” and “Made for iPhone” mean that an electronic accessory has been designed to connect specifically to iPod or iPhone, respectively, and has been certified by the developer to meet Apple performance standards.

Apple is not responsible for the operation of this device or its compliance with safety and regulatory standards.

Please note that the use of this accessory with iPod or iPhone may affect wireless performance.

iPhone, iPod, iPod classic, iPod nano, and iPod touch are trademarks of Apple Inc., registered in the U.S. and other countries.

iTunes

iTunes is a trademark of Apple Inc., registered in the U.S. and other countries. 

Using the LCD screen correctly

Handling the LCD screen

- When the LCD screen is subjected to direct sunlight for a long period of time, it will become very hot, resulting in possible damage to the LCD screen. When not using this navigation system, avoid exposing it to direct sunlight as much as possible.
- The LCD screen should be used within the temperature ranges shown in *Specifications*.
- Do not use the LCD screen at temperatures higher or lower than the operating temperature range, because the LCD screen

may not operate normally and could be damaged.

- The LCD screen is exposed in order to increase its visibility within the vehicle. Please do not press strongly on it as this may damage it.
- Do not push the LCD screen with excessive force as this may scratch it.
- Never touch the LCD screen with anything besides your finger when operating the touch panel functions. The LCD screen can scratch easily.

Liquid crystal display (LCD) screen

- If the LCD screen is near the vent of an air conditioner, make sure that air from the air conditioner is not blowing on it. Heat from the heater may break the LCD screen, and cool air from the cooler may cause moisture to form inside the navigation unit, resulting in possible damage.
- Small black dots or white dots (bright dots) may appear on the LCD screen. These are due to the characteristics of the LCD screen and do not indicate a malfunction.
- The LCD screen will be difficult to see if it is exposed to direct sunlight.
- When using a mobile phone, keep the aerial of the mobile phone away from the LCD screen to prevent disruption of the video in the form of disturbances such as spots or coloured stripes.

Maintaining the LCD screen

- When removing dust from the LCD screen or cleaning it, first turn the system power off, then wipe with a soft dry cloth.
- When wiping the LCD screen, take care not to scratch the surface. Do not use harsh or abrasive chemical cleaners.

LED (light-emitting diode) backlight

A light emitting diode is used inside the display to illuminate the LCD screen.

- At low temperatures, using the LED backlight may increase image lag and degrade the image quality because of the characteristics of the LCD screen. Image quality will improve with an increase in temperature.
- The product lifetime of the LED backlight is more than 10 000 hours. However, it may decrease if used in high temperatures.
- If the LED backlight reaches the end of its product lifetime, the screen will become dimmer and the image will no longer be visible. In that case, please consult your dealer or the nearest authorised Pioneer Service Station. 

Appendix

Display information

Destination Menu



	Page
Address	35
Return Home	38
POI	
Petrol Station	
Open Parking Area	38
Cash Dispenser	
Hotel or Motel	
Spell Name	38
Near Me	39
Near Destination	39
Around City	39
navigate FEEDS	40
Favourites	40, 47
History	41, 50
Cancel Route	46
Traffic	51
Coordinates	41
Route Overview	43

Phone Menu

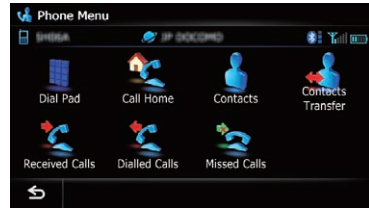

	Page
Dial Pad	60
Call Home	61
Contacts	61
Contacts Transfer	64
Received Calls	62
Dialed Calls	62
Missed Calls	62

Appendix

Settings Menu

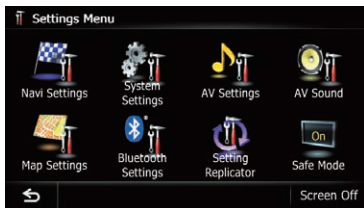

	Page
Navi Settings	126
System Settings	139
AV Settings	147
AV Sound	151
Map Settings	132
Bluetooth Settings	65
Setting Replicator	158
Safe Mode	158

Navi Settings menu

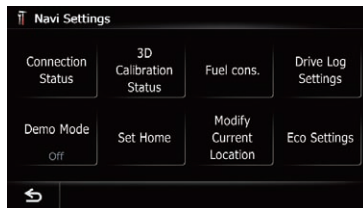

	Page
Connection Status	126
3D Calibration Status	127
Fuel cons.	128
Drive Log Settings	130
Demo Mode	130
Set Home	130
Modify Current Location	131
Eco Settings	131

Appendix

System Settings menu

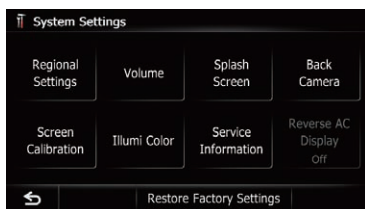

	Page
Regional Settings	
Program Language	139
Voice Language	139
Time	141
km / mile	141
Average Speed	141
Volume	142
Splash Screen	142
Back Camera	143
Screen Calibration	144
Illumi Color	144
Service Information	145
Reverse AC Display	145
Restore Factory Settings	168

Map Settings menu

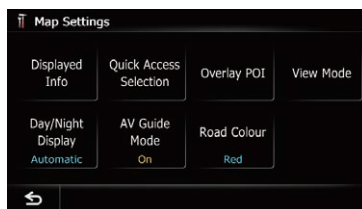

	Page
Displayed Info	
Close Up View	132
City Map	132
City Map Barrier	133
Show Speed Limit	133
Show Traffic Incident	134
Bluetooth Connected	134
Current Street Name	134
Favourites Icon	134
3D Land Mark	135
Show Manoeuvre	135
Show Eco Meter	135
Quick Access Selection	138
Overlay POI	136
View Mode	30
Day/Night Display	137
AV Guide Mode	138
Road Colour	138

Appendix

Bluetooth Settings menu

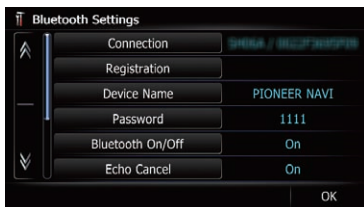

	Page
Connection	58
Registration	55
Device Name	65
Password	65
Bluetooth On/Off	66
Echo Cancel	66



	Page
Auto Answer Preference	66
Refuse All Calls	67
Clear Memory	67
Firmware update	67

AV System Settings menu



	Page
AV1 Input	148
AV2 Input	148
Wide Mode	148
Auto EQ Meas.	154
Mute	149
Mute Level	150
Rear SP	149
DivX® VOD	151

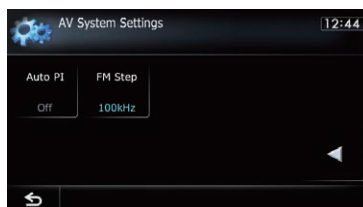

	Page
Auto PI	150
FM Step	150

Appendix

AV Sound Settings menu



	Page
FAD/BAL (Balance)	152
EQ	152
Loudness	157
Sub Woofer	157
HPF	157
SLA	158
Bass Booster	158
Sonic Center Control	156



Appendix

Glossary

AAC

AAC is short for Advanced Audio Coding and refers to an audio compression technology standard used with MPEG-2 and MPEG-4.

Aspect ratio

This is the width-to-height ratio of a TV screen. A regular display has an aspect ratio of 4:3. Wide screen displays have an aspect ratio of 16:9, providing a bigger picture for exceptional presence and atmosphere.

Bit rate

This expresses data volume per second, or bps units (bits per second). The higher the rate, the more information is available to reproduce the sound. Using the same encoding method (such as MP3), the higher the rate, the better the sound.

Built-in sensor

The built-in sensor that enables the system to estimate your vehicle's position.

CD-DA

This stands for a general music CD (commercial-release audio CD). In this manual, this word is sometime used for a distinction between data CDs (which include compressed audio files) and general music CDs.

Chapter

Titles of DVD-Video are in turn divided into chapters which are numbered in the same way as the chapters of a book. With discs featuring chapters, you can quickly find a desired scene with chapter search.

Current location

The present location of your vehicle; your current location is shown on the map by a red triangle mark.

Destination

A location you choose as the end point of your journey.

DivX

DivX is a popular media technology created by DivX, Inc. DivX media files contain highly compressed video with high visual quality that maintains a relatively small file size. DivX files can also include advanced media features like menus, subtitles, and alternate audio tracks. Many DivX media files are available for download online, and you can create your own using your personal content and easy-to-use tools from DivX.com.

DivX Certified

DivX Certified products are officially tested by the creators of DivX and guaranteed to play all versions of DivX video, including DivX 6.

Favourites

A frequently visited location (such as your workplace or a relative's home) that you can register to allow easy routing.

GPS

Global Positioning System. A network of satellites that provides navigation signals for a variety of purposes.

Guidance point

These are important landmarks along your route, generally intersections. The next guidance point along your route is indicated on the map by the yellow flag icon.

Home location

Your registered home location.

ID3 tag

This is a method of embedding track-related information in an MP3 file. This embedded information can include the track title, the artist's name, the album title, the music genre, the year of production, comments and other data. The contents can be freely edited using software with ID3 tag editing functions. Although the tags are restricted by the number of characters, the information can be viewed when the track is played back.

Appendix

ISO 9660 format

This is the international standard for the format logic of DVD/CD-ROM folders and files. For the ISO9660 format, there are regulations for the following two levels:

- **Level 1:**
The file name is in 8.3 format (the name consists of up to eight characters, half-byte English capital letters, half-byte numerals and the “_” sign, with a file-extension of three characters).
- **Level 2:**
The file name can have up to 31 characters (including the separation mark “.” and a file extension). Each folder contains less than eight hierarchies.
- **Extended formats**
Joliet:
File names can have up to 64 characters.
Romeo:
File names can have up to 128 characters.

JPEG

This stands for Joint Photographic Experts Group, and is an international still image compression standard.

MP3

MP3 is short for MPEG Audio Layer 3. It is an audio compression standard established by a working group (MPEG) of the ISO (International Organization for Standardization). MP3 is able to compress audio data to about 1/10th the size of a conventional disc.

MPEG

This stands for Moving Pictures Experts Group, and is an international video image compression standard.

Multi-angle

With regular TV programmes, although multiple cameras are used to simultaneously shoot scenes, only images from one camera at a time are transmitted to your TV. Some DVDs feature scenes shot from multiple angles, letting you choose your viewing angle as desired.

Multi-audio (Multilingual dialogue)

Some videos feature dialogue recorded in multiple languages or audio recorded in multiple tracks. For example, dialogue in up to eight languages can be recorded on a single DVD-Video, letting you choose the language as desired.

Multi-session

Multi-session is a recording method that allows additional data to be recorded later. When recording data on a CD-ROM, CD-R or CD-RW, etc., all data from beginning to end is treated as a single unit or session. Multi-session is a method of recording more than two sessions in one disc.

Multi-subtitle

For example, subtitles in up to 32 languages can be recorded on a single DVD-Video, letting you choose as desired.

Packet write

This is a general term for a method of writing individual files to a CD-R, etc. whenever required, just as is done with files on floppy or hard disks.

Parental lock

Some DVD-Video discs with violent or adult-oriented scenes feature parental lock which prevents children from viewing such scenes. With this kind of disc, if you set the unit's parental lock level, playback of scenes inappropriate for children will be disabled, or these scenes will be skipped.

Phone book

An address book on user's phone is collectively referred to as “Phone book”. Depending on the mobile phone, the phone book may be called a name such as “Contacts”, “Business card” or something else.

Point Of Interest (POI)

Any of a range of locations stored in the data, such as railway stations, shops, restaurants, and amusement parks.

Appendix

Region number

DVD players and DVD discs feature region numbers indicating the area in which they were purchased. Playback of a DVD is not possible unless it features the same region number as the DVD player.

Route setting

The process of determining the ideal route to a specific location; route setting is done automatically by the system when you specify a destination.

Set route

The route marked out by the system to your destination. It is highlighted in bright colour on the map.

Title

DVD-Video discs have a high data capacity, enabling recording of multiple videos on a single disc. If, for example, one disc contains three separate videos, they are divided into title 1, title 2 and title 3. This lets you enjoy the convenience of title search and other functions.

Track log

Your navigation system logs routes that you already passed through if the track logger is activated. This recorded route is called a "track log". It is handy when you want to check a route travelled or if returning along a complex route.

VBR

VBR is short for variable bit rate. Generally speaking, CBR (constant bit rate) is more widely used. But by flexibly adjusting the bit rate according to the needs of audio compression, it is possible to produce compression-priority data.

Voice guidance

The giving of directions by navigation voice while in guidance.

Waypoint

A location that you choose to visit before your destination; a journey can be built up from multiple waypoints and the destination.

WMA

WMA is short for Windows Media™ Audio and refers to an audio compression technology that is developed by Microsoft Corporation. WMA data can be encoded by using Windows Media Player version 7 or later. 

Appendix

Specifications

General

Rated power source	14.4 V DC (allowable voltage range: 12.0 V to 14.4 V DC)
Earthing system	Negative type
Maximum current consumption	10.0 A
Dimensions (W × H × D):	
AVIC-F30BT	
DIN	
Chassis	188 mm × 118 mm × 157 mm
Nose	170 mm × 96 mm × 28 mm
D	
Chassis	178 mm × 100 mm × 165 mm
Nose	170 mm × 96 mm × 20 mm
AVIC-F930BT	
DIN	
Chassis	188 mm × 118 mm × 157 mm
Nose	170 mm × 96 mm × 20 mm
D	
Chassis	178 mm × 100 mm × 165 mm
Nose	170 mm × 96 mm × 12 mm
AVIC-F9310BT	
D	
Chassis	178 mm × 100 mm × 165 mm
Nose	220 mm × 133 mm × 21 mm
Weight:	
AVIC-F30BT	2.81 kg
AVIC-F930BT	2.52 kg
AVIC-F9310BT	2.24 kg
NAND flash memory	4 GB

Navigation

GPS receiver:	
System	L1, C/Acode GPS SPS (Standard Positioning Service)
Reception system	32-channel multi-channel reception system
Reception frequency	1 575.42 MHz
Sensitivity	-140 dBm (typ)
Position update frequency	Approx. once per second
GPS aerial:	
Aerial	Micro strip flat aerial/right-handed helical polarisation
Aerial cable	3.55 m
Dimensions (W × H × D)	33 mm × 15 mm × 36 mm

Weight 73.7 g

Display

Screen size/aspect ratio:	
AVIC-F30BT	7 inch wide/16:9
AVIC-F930BT	6.1 inch wide/16:9
AVIC-F9310BT	6.1 inch wide/16:9
Effective display area:	
AVIC-F30BT	157 mm × 83 mm
AVIC-F930BT	137 mm × 72 mm
AVIC-F9310BT	137 mm × 72 mm
Pixels	384 000 (800 × 480)
Display method	TFT Active matrix driving
Backlight	LED
Colour system	PAL/NTSC compatible
Tolerable temperature range:	
Power on	-10°C to +60°C
Power off	-20°C to +80°C
Angle adjustment	
AVIC-F30BT	0° to 22°
AVIC-F930BT	0°
AVIC-F9310BT	0°

Audio

Maximum power output	50 W × 4 50 W × 2 ch/4Ω + 70 W × 1 ch/2Ω (for subwoofer)
Continuous power output	22 W × 4 (50 Hz to 15 kHz, 5%THD, 4Ω LOAD, Both Channels Driven)
Load impedance	4Ω (4Ω to 8Ω [2Ω for 1 ch] allowable)
Preout output level (max):	
AVIC-F30BT	4.0 V
AVIC-F930BT	2.2 V
AVIC-F9310BT	2.2 V
Preout impedance:	
AVIC-F30BT	100Ω
AVIC-F930BT	1 kΩ
AVIC-F9310BT	1 kΩ
Equaliser (8-Band Graphic Equaliser):	
Frequency	40 Hz/80 Hz/200 Hz/400 Hz/ 1 kHz/2.5 kHz/8 kHz/10 kHz
Gain	±12 dB
Loudness contour:	
Low	+3.5 dB (100 Hz), +3 dB (10 kHz)
Mid	+10 dB (100 Hz), +6.5 dB (10 kHz)
High	+11 dB (100 Hz), +11 dB (10 kHz) (volume: -30 dB)
HPF:	
Frequency	50 Hz/63 Hz/80 Hz/100 Hz/ 125 Hz
Slope	-12 dB/oct

Appendix

Subwoofer:

Frequency	50 Hz/63 Hz/80 Hz/100 Hz/ 125 Hz
Slope	-18 dB/oct
Gain	-24/+6 dB
Phase	Normal/Reverse

Bass boost:

Gain	0 dB to +12 dB
------------	----------------

DVD Drive

System	DVD-Video, CD, MP3, WMA, AAC, DivX system
Usable discs	DVD-Video, DVD-R(DL), DVD-RW, CD-ROM, CD-DA, CD-R/RW
Region number	2
Signal format:	
Sampling frequency	44.1 kHz/48 kHz/96 kHz
Number of quantisation bits	16 bit/20 bit/24 bit; linear
Frequency response	5 Hz to 44 000 Hz (with DVD, at sampling frequency 96 kHz)
Signal-to-noise ratio	97 dB (1 kHz) (IEC-A net- work) (CD: 96 dB (1 kHz) (IEC-A network))
Dynamic range	95 dB (1 kHz) (CD: 94 dB (1 kHz))
Distortion	0.008 % (1 kHz)
Output level:	
Video	1.0 V _{p-p} /75 Ω (±0.2 V)
Audio	1.0 V (1 kHz, 0 dB)
Number of channels	2 (stereo)
MP3 decoding format	MPEG-1 & 2 Audio Layer 3
WMA decoding format	Ver.9.0 L3
AAC decoding format	MPEG-4 AAC (only encoded by iTunes): .m4a
DivX decoding format	Home Theater Ver.3.11, Ver.4.X, Ver.5.X, Ver.6.X: .avi, .divx

USB

USB standard spec.	USB 2.0 High Speed
Max current supply	1 A
File system	FAT16, FAT32
USB class	Mass storage class
Decoding format	MP3/WMA/AAC/WAVE/ H.264/MPEG4/WMV

SD (AVIC-F30BT)

SD memory card, SDHC memory card	
Compatible physical format	Version 2.00
File system	FAT16, FAT32
Decoding format	MP3/WMA/AAC/WAVE/ H.264/MPEG4/WMV

SD (AVIC-F930BT and AVIC-F9310BT)

microSD card, microSDHC card	
Compatible physical format	Version 2.00
File system	FAT16, FAT32
Decoding format	MP3/WMA/AAC/WAVE/ H.264/MPEG4/WMV

Bluetooth

Version	Bluetooth 2.0+EDR
Output power	+4 dBm Max. (Power class 2)

FM tuner

Frequency range	87.5 MHz to 108.0 MHz
Usable sensitivity	9 dBf (0.8 μV/75 Ω mono, S/N: 30 dB)
Signal-to-noise ratio	72 dB (IEC-A network)
Distortion	0.3 % (at 65 dBf, 1 kHz, stereo)
Frequency response	30 Hz to 15 000 Hz (±3 dB)
Stereo separation	45 dB (at 65 dBf, 1 kHz)

MW tuner

Frequency range	531 kHz to 1 602 kHz (9 kHz)
Usable sensitivity	25 μV (S/N: 20 dB)
Signal-to-noise ratio	62 dB (IEC-A network)

LW tuner

Frequency range	153 kHz to 281 kHz
Usable sensitivity	28 μV (S/N: 20 dB)
Signal-to-noise ratio	62 dB (IEC-A network)

RDS-TMC tuner

Rated power source	13.8 V DC (allowable voltage range: 10.0 V to 14.5 V DC)
Earthing system	Negative type Maximum current consumption 60 mA
Dimensions (W × H × D)	68 mm × 49 mm × 19 mm
Weight	180 g



Note

Specifications and design are subject to possible modifications without notice due to improvements. □



<http://www.pioneer.eu>

Visit **www.pioneer.co.uk** (or **www.pioneer.eu**) to register your product.

Visite **www.pioneer.es** (o **www.pioneer.eu**) para registrar su producto.

Zum Registrieren Ihres Produktes besuchen Sie bitte **www.pioneer.de** (oder **www.pioneer.eu**) .

Visitez **www.pioneer.fr** (ou **www.pioneer.eu**) pour enregistrer votre appareil.

Si prega di visitare il sito **www.pioneer.it** (o **www.pioneer.eu**) per registrare il prodotto.

Bezoek **www.pioneer.nl** (of **www.pioneer.eu**) om uw product te registreren.

Посетите **www.pioneer-rus.ru** (или **www.pioneer.eu**) для регистрации приобретенного Вами изделия.

PIONEER CORPORATION

1-1, Shin-ogura, Saiwai-ku, Kawasaki-shi,
Kanagawa 212-0031, JAPAN

PIONEER ELECTRONICS (USA) INC.

P.O. Box 1540, Long Beach, California 90801-1540, U.S.A.
TEL: (800) 421-1404

PIONEER EUROPE NV

Haven 1087, Keetberglaan 1, B-9120 Melsele, Belgium/Belgique
TEL: (0) 3/570.05.11

Published by Pioneer Corporation.
Copyright ©2011 by Pioneer Corporation.
All rights reserved.