

USER MANUAL



SHOOT WOW!
SHARE NOW!



NX300

ENG This user manual includes detailed usage instructions for your camera. Please read this manual thoroughly.

Copyright information

- Microsoft Windows and the Windows logo are registered trademarks of the Microsoft Corporation.
- Mac and Apple App Store are registered trademarks of the Apple Corporation.
- Google Play Store is a registered trademark of Google, Inc.
- Adobe, the Adobe logo, Photoshop and Lightroom are either registered trademarks or trademarks of Adobe Systems Incorporated in the United States and/or other countries.
- microSD™, microSDHC™, and microSDXC™ are registered trademarks of the SD Association.
- HDMI, the HDMI logo, and the term “High Definition Multimedia Interface” are trademarks or registered trademarks of HDMI Licensing LLC.
- Wi-Fi®, the Wi-Fi CERTIFIED logo, and the Wi-Fi logo are registered trademarks of the Wi-Fi Alliance.
- Trademarks and trade names used in this manual are the property of their respective owners.



- Camera specifications or contents of this manual may be changed without prior notice due to upgrade of camera functions.
- You are not allowed to reuse or distribute any part of this manual without prior permission.
- We recommend using your camera within the country where you purchase it.
- Use this camera responsibly and adhere to all laws and regulations concerning its use.

PlanetFirst represents Samsung Electronics' commitment to sustainable development and social responsibility through eco-driven business and management activities.

Health and safety information

Always comply with the following precautions and usage tips to avoid dangerous situations and ensure peak performance of your camera.



Warning—situations that could cause injury to yourself or others

Do not disassemble or attempt to repair your camera.

This may result in electric shock or damage to the camera.

Do not use your camera near flammable or explosive gases and liquids.

This may cause a fire or explosion.

Do not insert flammable materials into the camera or store these materials near the camera.

This may cause a fire or electric shock.

Do not handle your camera with wet hands.

This may result in electric shock.

Prevent damage to subjects' eyesight.

Do not use the flash in close proximity (closer than 1 m/3 ft) to people or animals. If you use the flash too close to your subject's eyes, this can cause temporary or permanent eyesight damage.

Keep your camera away from small children and pets.

Keep your camera and all accessories out of the reach of small children and animals. Small parts may cause choking or serious injury if swallowed. Moving parts and accessories may present physical dangers as well.

Do not expose the camera to direct sunlight or high temperatures for an extended period of time.

Prolonged exposure to sunlight or extreme temperatures can cause permanent damage to your camera's internal components.

Avoid covering the camera or charger with blankets or clothes.

The camera may overheat, which may distort the camera or cause a fire.

Do not handle the power supply cord or go near the charger during a thunderstorm.

This may result in electric shock.

If liquid or foreign objects enter your camera, immediately disconnect all power sources, such as the battery or charger, and then contact a Samsung service center.

Comply with any regulations that restrict the use of a camera in a certain area.

- Avoid interference with other electronic devices.
- Turn off the camera when in an aircraft. Your camera can cause interference with aircraft equipment. Follow all airline regulations and turn off your camera when directed by airline personnel.
- Turn off the camera near medical equipment. Your camera can interfere with medical equipment in hospitals or health care facilities. Follow all regulations, posted warnings, and directions from medical personnel.

Avoid interference with pacemakers.

Maintain the distance between this camera and all pacemakers to avoid potential interference, as recommended by the manufacturer and research groups. If you have any reason to suspect that your camera is interfering with a pacemaker or other medical device, turn off the camera immediately and contact the manufacturer of the pacemaker or medical device for guidance.



Caution—situations that could cause damage to your camera or other equipment

Remove the batteries from your camera when storing it for an extended period of time.

Installed batteries may leak or corrode over time and cause serious damage to your camera.

Use only authentic, manufacturer-recommended, Lithium-ion replacement batteries. Do not damage or heat the battery.

Inauthentic, damaged, or heated batteries may cause a fire or personal injury.

Use only Samsung-approved batteries, chargers, cables and accessories.

- Using unauthorized batteries, chargers, cables or accessories can cause batteries to explode, damage your camera, or cause injury.
- Samsung is not responsible for damage or injuries caused by unapproved batteries, chargers, cables or accessories.

Use the battery only for its intended purpose.

Misusing the battery may cause a fire or electric shock.

Do not touch the flash while it fires.

The flash is very hot when fired and may burn your skin.

When you use the AC charger, turn off the camera before you disconnect the power to the AC charger.

Failing to do so may result in fire or electric shock.

Disconnect the charger from the wall socket when not in use.

Failing to do so may result in fire or electric shock.

Do not use a damaged power supply cord, plug, or loose outlet when you charge batteries.

This may cause a fire or electric shock.

Do not allow the AC charger to come in contact with the +/- terminals on the battery.

This may cause a fire or electric shock.

Do not drop or subject the camera to strong impacts.

Doing so may damage the screen or external or internal components.

Exercise caution when you connect cables and install batteries and memory cards.

If you force the connectors, improperly connect cables, or improperly install batteries and memory cards, you can damage ports, connectors, and accessories.

Keep cards with magnetic strips away from the camera case.

Information stored on the card may be damaged or erased.

Never use a damaged battery, or memory card.

This may result in electric shock or camera malfunction or cause a fire.

Do not place the camera in or near magnetic fields.

Doing so may cause the camera to malfunction.

Do not use the camera if the screen is damaged.

If the glass or acrylic parts are broken, visit a Samsung service center to have the camera repaired.

Check that the camera is operating properly before use.

The manufacturer takes no responsibility for any loss of files or damage that may result from camera malfunction or improper use.

You must plug the small end of the USB cable into your camera.

If the cable is reversed, it may damage your files. The manufacturer is not responsible for any loss of data.

Do not expose the lens to direct sunlight.

This may discolor the image sensor or cause it to malfunction.

If the camera overheats, remove the battery and allow it to cool down.

- Prolonged usage of the camera may overheat the battery and raise the internal temperature of the camera. If the camera stops operating, remove the battery and allow it to cool down.
- High internal temperatures may result in noise in your photos. This is normal and does not affect your camera's overall performance.

Avoid interference with other electronic devices.

Your camera emits radio frequency (RF) signals that may interfere with unshielded or improperly shielded electronic equipment, such as pacemakers, hearing aids, medical devices, and other electronic devices in homes or vehicles. Consult the manufacturers of your electronic devices to solve any interference problems you experience. To prevent unwanted interference, use only Samsung-approved devices or accessories.

Use your camera in the normal position.





Avoid contact with your camera's internal antenna.

Data transference and your responsibilities



- Data transferred via WLAN could be leaked, so avoid transferring sensitive data in public areas or on open networks.
- The camera manufacturer is not liable for any data transfers that infringe on copyrights, trademarks, intellectual property laws, or public decency ordinances.

Indications used in this manual

Icons used in this manual

Icon	Function
	Additional information
	Safety warnings and precautions
[]	Camera buttons. For example, [Shutter] represents the shutter button.
()	Page number of related information
→	The order of options or menus you must select to perform a step; for example: Select  → Quality (represents select  , and then Quality).
*	Annotation

Mode indications

Mode	Indication
Smart Auto	
Program	P
Aperture Priority	A
Shutter Priority	S
Manual	M
Lens Priority	
Smart	
Wi-Fi	Wi-Fi

Contents

Tips

Concepts in Photography

Shooting postures	13
Holding the camera	13
Standing photography	13
Crouching photography	14
Using the display	14
Low-angle shot.....	15
High-angle shot.....	15
Aperture	16
Aperture value and the depth of field	17
Shutter speed	18
ISO sensitivity	19
How the aperture setting, shutter speed, and ISO sensitivity control exposure	20
Correlation between focal length, angle, and perspective	21
Depth of field	22
What controls out-of-focus effects?.....	22
Optical preview	24
Composition	24
Rule of Thirds.....	24
Photos with two subjects	25
Flash	26
Flash guide number.....	26
Bounce Photography	27

Chapter 1

My Camera

Getting started	29
Unpacking.....	29
Camera layout	30
Using the DIRECT LINK button.....	32
Inserting the battery and memory card	33
Removing the battery and memory card	33
Using the memory card adapter.....	33
Charging the battery and turning on your camera	34
Charging the battery.....	34
Turning on your camera	34
Performing the initial setup	35
Selecting functions (options)	36
Selecting with buttons.....	36
Selecting by touch	36
Using MENU	37
E.g. Selecting the photo size in P mode	37
Using the Smart panel.....	38
E.g. Adjust the exposure value in P mode	38

Display icons	40	Shooting modes	53
In Shooting mode	40	AUTO Smart Auto mode	54
Capturing photos	40	P Program mode.....	56
Recording videos	41	Program Shift	56
About the level gauge	41	A Aperture Priority mode	57
In Playback mode.....	42	S Shutter Priority mode.....	58
Viewing photos	42	M Manual mode	59
Playing videos.....	42	Framing mode	59
Changing the information displayed	43	Using the Bulb function	60
Lenses	44	<i>i</i> Lens Priority mode.....	60
Lens layout.....	44	Using <i>i</i> Depth	60
Locking or unlocking the lens.....	45	Using i-Function in P/A/S/M modes	61
Lens markings	47	Using <i>i</i> Zoom	63
Accessories	48	S Smart mode	64
External flash layout.....	48	Using the Best Face mode	65
Connecting the external flash.....	49	Capturing panoramic photos.....	66
GPS module layout (optional)	51	Recording a video	68
Attaching the GPS module	51	3D mode.....	69
		Available functions by shooting mode	71

Chapter 2

Shooting Functions

- Size and Resolution 73**
 - Photo size..... 73
 - Quality..... 74
- ISO sensitivity 75**
- White Balance 76**
 - Customizing preset White Balance options 77
- Picture Wizard (photo styles)..... 79**
- AF mode..... 80**
 - Single AF..... 81
 - Continuous AF..... 81
 - Manual focus..... 82
- AF area..... 83**
 - Selection AF 83
 - Multi AF..... 84
 - Face detection AF..... 84
 - Self-Portrait AF 85
- Touch AF..... 86**
 - Touch AF..... 86
 - Tracking AF..... 86
 - One touch shot 87
- Focus assist..... 88**
 - MF Assist..... 88
 - Focus Peaking..... 88
- Optical Image Stabilization (OIS)..... 89**

- Drive (shooting method) 90**
 - Single..... 90
 - Continuous..... 90
 - Burst..... 91
 - Timer..... 91
 - Auto Exposure Bracketing (AE Bracket)..... 92
 - White Balance Bracketing (WB Bracket)..... 92
 - Picture Wizard Bracketing (P Wiz Bracket)..... 93
 - Bracketing setting..... 93
- Flash..... 94**
 - Reducing the red-eye effect..... 95
 - Adjusting the flash intensity..... 95
- Metering..... 97**
 - Multi..... 97
 - Spot..... 98
 - Center-weighted 98
 - Measuring the exposure value of the focus area 99
- Dynamic Range 100**
- Smart Filter..... 101**
- Exposure compensation 102**
- Exposure lock..... 103**
- Video functions 104**
 - Movie size..... 104
 - Movie quality 104
 - Multi Motion 105
 - Fader 105
 - Voice..... 106
 - Wind cut 106

Chapter 3

Playback/Editing

Searching and managing files..... 108

- Viewing photos..... 108
- Viewing image thumbnails..... 108
- Viewing files by category..... 109
- Viewing files as a folder..... 109
- Protecting files..... 110
 - Lock/Unlock all files..... 110
- Deleting files..... 111
 - Deleting a single file..... 111
 - Deleting multiple files..... 111
 - Deleting all files..... 112

Viewing photos..... 113

- Enlarging a photo..... 113
- Viewing a slide show..... 113
- Auto rotating..... 114
- Creating a print order (DPOF)..... 114

Playing videos..... 115

- Trimming a video during playback..... 115
- Capturing an image during playback..... 116

Editing photos..... 117

- Cropping a photo..... 117
- Rotating a photo..... 118
- Resizing photos..... 118
- Adjusting your photos..... 119
- Retouching faces..... 120
- Reducing red-eye..... 120
- Applying Smart Filter effects..... 121

Chapter 4

Wireless network

Connecting to a WLAN and configuring network settings..... 123

- Connecting to a WLAN..... 123
 - Setting network options..... 124
 - Manually setting the IP address..... 124
- Using the login browser..... 125
- Network connection tips..... 126
- Entering text..... 127

Saving files to a smart phone automatically..... 128

Sending photos or videos to a smart phone..... 129

Using a smart phone as a remote shutter release..... 131

Using Auto Backup to send photos or videos..... 133

- Installing the program for Auto Backup on your PC..... 133
- Sending photos or videos to a PC..... 133

Sending photos or videos via email..... 135

- Changing email settings..... 135
 - Storing your information..... 135
 - Setting an email password..... 136
 - Changing the email password..... 137
- Sending photos or videos via email..... 137

Using photo or video sharing websites..... 139

- Accessing a website..... 139
- Uploading photos or videos..... 140

Using AllShare Play to send files..... 141

- Uploading photos to online storage..... 141
- Viewing photos or videos on devices that support AllShare Play..... 142

Sending photos using Wi-Fi Direct..... 144

Chapter 5

Camera settings menu

User settings..... 146
 ISO Customizing 146
 ISO Step..... 146
 Auto ISO Range 146
 Noise Reduction 146
 Bracket Set 147
 DMF (Direct Manual Focus) 147
 Color space 148
 Distortion Correct 149
 iFn Customizing 149
 User Display..... 149
 Key Mapping..... 150
 Grid Line 151
 AF Lamp..... 151
Setting 152

Chapter 6

Connecting to external devices

Viewing files on an HDTV or 3D TV..... 158
 Viewing files on an HDTV 158
 Viewing files on a 3D TV..... 159
Transferring files to your computer..... 160
 Transferring files to your Windows OS computer..... 160
 Connecting the camera as a removable disk..... 160
 Disconnecting the camera (for Windows XP)..... 161
 Transferring files to your Mac OS..... 161
Using programs on a PC..... 163
 Installing programs from the provided CD..... 163
 Available programs when using i-Launcher 163
 Using i-Launcher 163
 Requirements for Windows OS..... 163
 Requirements for Mac OS..... 164
 Opening i-Launcher..... 164
 Using Multimedia Viewer..... 165
 Downloading the firmware..... 166
 Downloading the PC Auto Backup program 166
 Installing Adobe Photoshop Lightroom 167
 Using Adobe Photoshop Lightroom 167

Chapter 7

Appendix

Error messages 169

Maintaining the camera..... 170

- Cleaning the camera 170
 - Camera lens and display 170
 - Image sensor 170
 - Camera body 170
- Using or storing the camera 171
 - Inappropriate places to use or store the camera 171
 - Using on beaches or shores 171
 - Storing for extended period of time 171
 - Using the camera with caution in humid environments 172
 - Other cautions 172
- About memory card 173
 - Supported memory card 173
 - Memory card capacity 174
 - Cautions when using memory cards 176
- About the battery 177
 - Battery specifications 177
 - Battery life 178
 - Low battery message 178
 - Notes about using the battery 178
 - Cautions about using the battery 179
 - Notes about charging the battery 179
 - Notes about charging with a computer connected 180
 - Handle and dispose of batteries and chargers with care 180

Before contacting a service center 181

Camera specifications 184

Glossary 189

Optional accessories 195

Index 197

FCC notice 200

Concepts in Photography

Shooting postures

A correct posture for stabilizing the camera is necessary for taking a good photo. Even if you hold a camera correctly, the wrong posture can cause the camera to shake. Stand up straight and remain still to maintain a steady base for your camera. When shooting with a low shutter speed, hold your breath to minimize body movement.

Holding the camera

Hold the camera with your right hand and place your right index finger on the shutter button. Place your left hand under the lens for support.

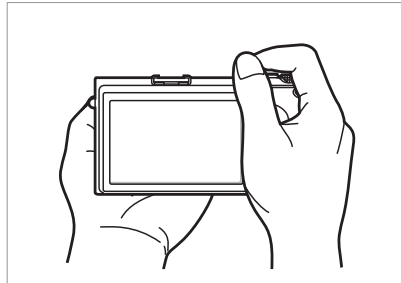
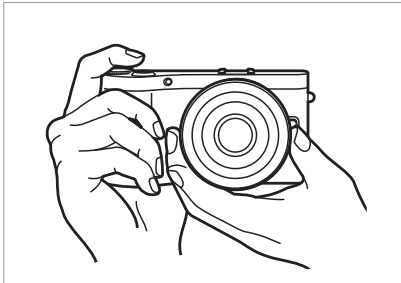

Standing photography

Compose your shot; stand up straight with your feet shoulder-length apart, and keep your elbows pointed down.

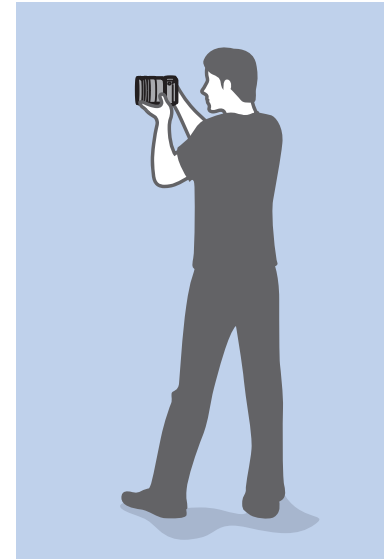
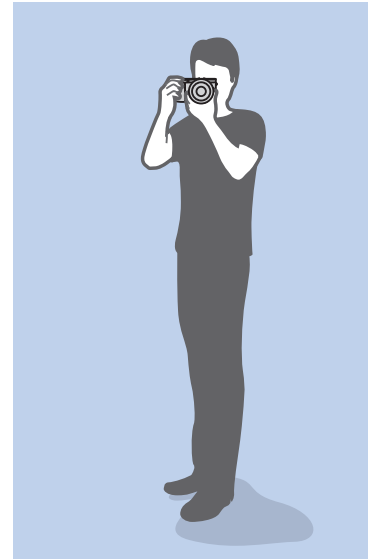

Crouching photography

Compose your shot, crouch with one knee touching the ground, and keep a straight posture.

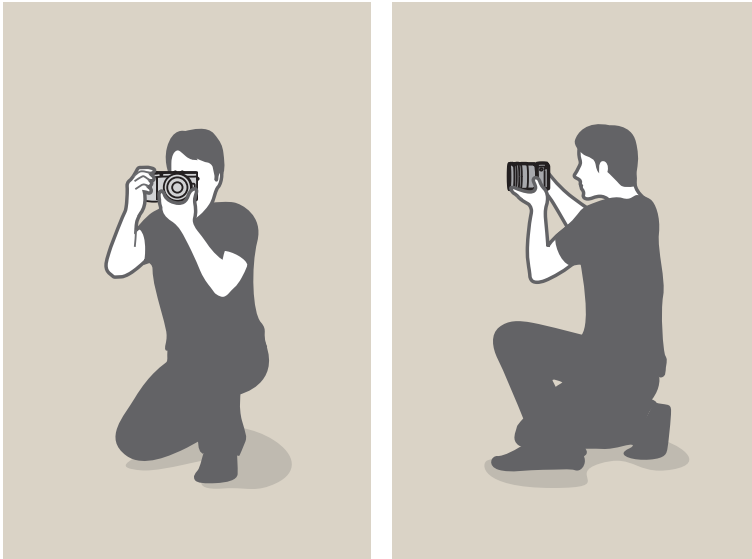

Using the display

To take photos at high or low angles, tilt the display up or down. You can tilt the display up to 90° upwards (B) or 45° downwards (C).

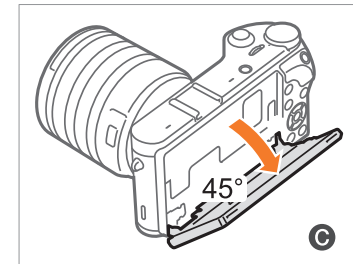
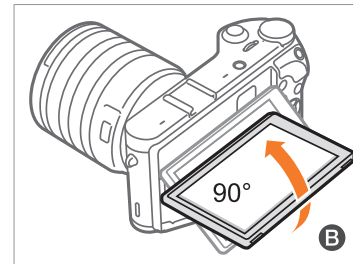
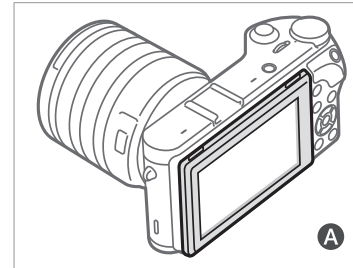

- Keep the display closed (A) when the camera is not in use.
- Tilt the display only within the angle allowed. Failing to do so may damage your camera.

Low-angle shot

A low-angle shot is a shot from a camera positioned below your eyeline, looking up the subject.

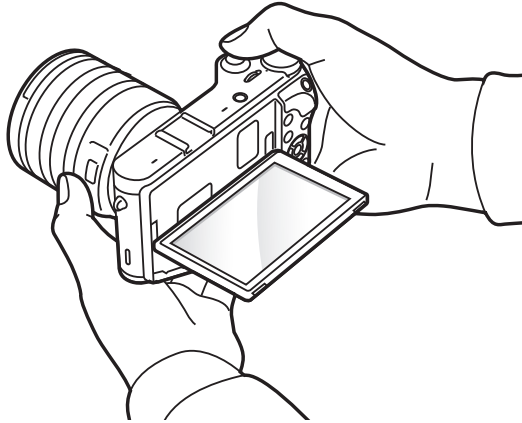

High-angle shot

A high-angle shot is a shot from a camera positioned above your eyeline, looking down on the subject.

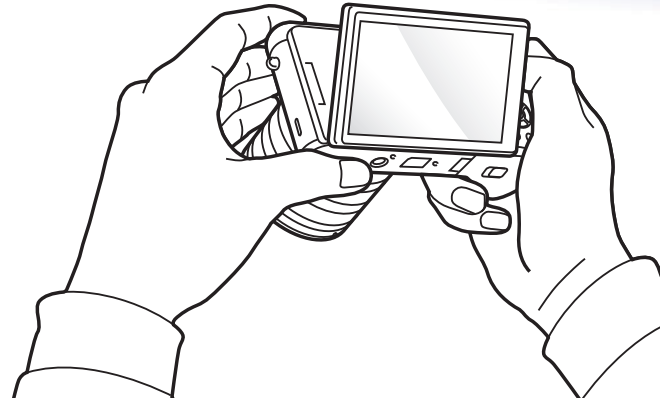

Aperture

The aperture, a hole that controls the amount of light that enters the camera, is one of the three factors that determine the exposure. The aperture housing contains thin, metal plates that open and close to let light through the aperture and into the camera. The size of the aperture is closely related to the brightness of a photo: the larger the aperture, the brighter the photo; the smaller the aperture, the darker the photo.

Aperture sizes

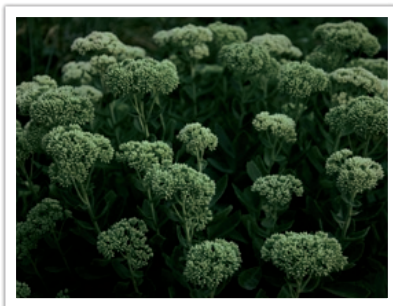
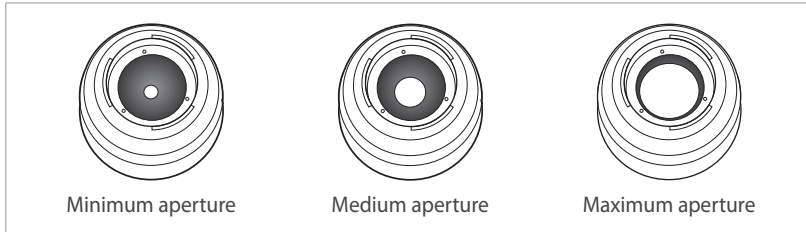

Darker photo
(aperture opened slightly)



Brighter photo
(aperture opened wide)

The size of the aperture is represented by a value known as an “F-number.” The f-number represents the focal length divided by the diameter of the lens. For example, if a lens with a 50 mm focal length has an f-number of F2, the diameter of the aperture is 25 mm. ($50 \text{ mm} / 25 \text{ mm} = F2$) The smaller the f-number, the greater the size of the aperture.

The opening in the aperture is described as the Exposure Value (EV). Increasing the Exposure Value (+1 EV) means the amount of light doubles. Decreasing the Exposure Value (-1 EV) means the amount of light halves. You can also use the exposure compensation feature to fine-tune the amount of light by subdividing exposure values into 1/2, 1/3 EV, and so on.

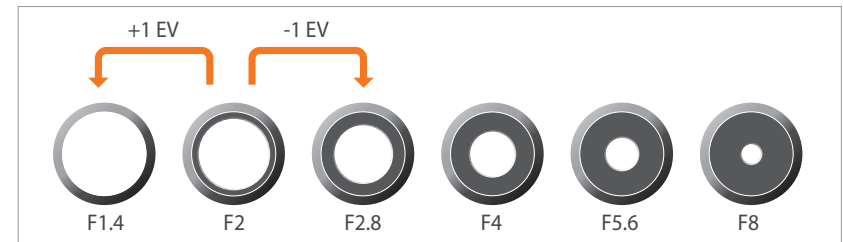

Exposure Value Steps

Aperture value and the depth of field

You can blur or sharpen the background of a photo by controlling the aperture. It is closely related to the depth of field (DOF), which can be expressed as small or large.



A photo with a large DOF



A photo with a small DOF



The aperture housing contains several blades. These blades move together and control the amount of light passing through the center of the aperture. The number of blades also affects the shape of light when shooting night scenes. If an aperture has an even number of blades, light divides into an equal number of sections. If the number of blades is odd, the number of sections is double the number of blades.

For example, an aperture with 8 blades divides light into 8 sections and an aperture with 7 blades into 14 sections.

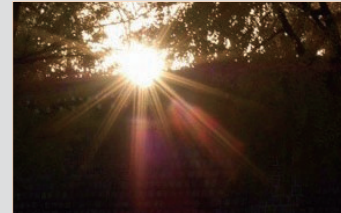

7 blades

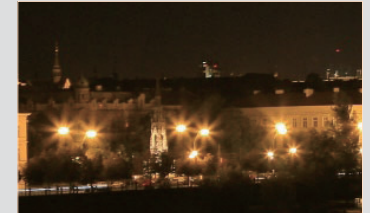

8 blades

Shutter speed

Shutter speed refers to the amount of time it takes to open and close the shutter, and it is an important factor in the brightness of a photo, as it controls the amount of light which passes through the aperture before it reaches the image sensor.

Usually, the shutter speed is manually adjustable. The measurement of the shutter speed is known as the "Exposure Value" (EV), which is marked in intervals of 1 s, 1/2 s, 1/4 s, 1/8 s, 1/15 s, 1/1000 s, 1/2000 s, and so on.

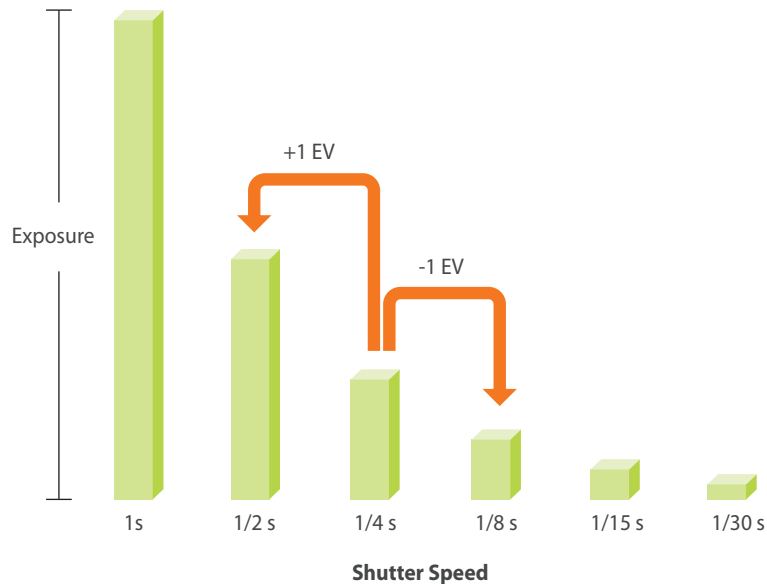

Therefore, the faster the shutter speed, the less light will be let in. Likewise, the slower the shutter speed, the more light will be let in.

As the photos below illustrate, a slow shutter speed allows more time to let light in, so the photo becomes brighter. On the other hand, a fast shutter speed allows less time to let light in and the photo becomes darker and more easily freezes subjects in motion.

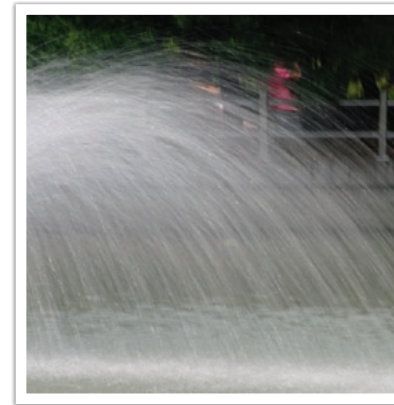

0.8 s

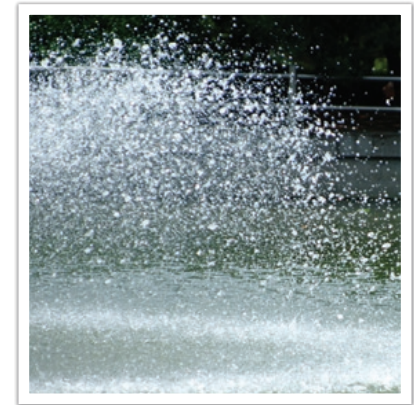

0.004 s

ISO sensitivity

The exposure of an image is determined by the sensitivity of the camera. This sensitivity is based on international film standards, known as ISO standards. On digital cameras, this sensitivity rating is used to represent the sensitivity of the digital mechanism that captures the image.

ISO sensitivity doubles as the number doubles. For example, an ISO 200 setting is capable of capturing images at twice the speed of an ISO 100 setting. However, higher ISO settings can result in “noise”—small specks, spots, and other phenomena in a photo that give the shot a noisy or dirty appearance. As a general rule, it is best to use a low ISO setting to prevent noise in your photos, unless you are shooting in darkened environments or at night.

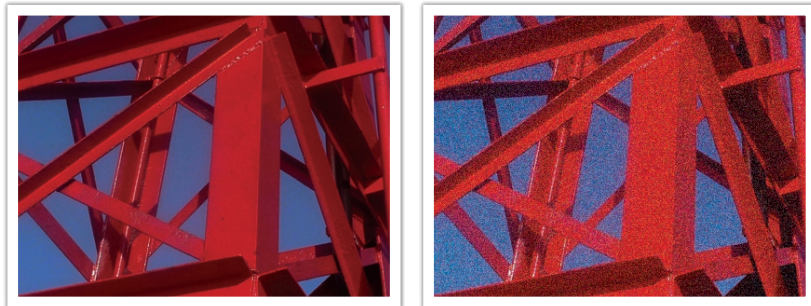

Changes in the quality and brightness according to ISO sensitivity

Because a low ISO sensitivity means the camera will be less sensitive to light, you need more light to have an optimal exposure. When using a low ISO sensitivity, open the aperture more or reduce the shutter speed to allow more light to enter the camera. For example, on a sunny day when light is abundant, a low ISO sensitivity does not require a low shutter speed. However, in a dark place or at night, a low ISO sensitivity and a fast shutter speed will result in a blurry photo.



A photo captured with a tripod and high sensitivity





A blurred photo with a low ISO sensitivity

How the aperture setting, shutter speed, and ISO sensitivity control exposure

The aperture setting, shutter speed, and ISO sensitivity are closely interconnected in photography. The aperture setting controls the opening that regulates the light that enters the camera, while the shutter speed determines the length of time that light is allowed to enter. ISO sensitivity determines the speed at which the film reacts to light. Together, these three aspects are described as the triangle of exposure.

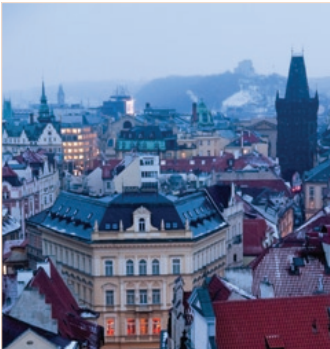
A change in shutter speed, aperture value, or ISO sensitivity can be offset by adjustments to the others to maintain the amount of light. The results, however, change according to the settings. For example, shutter speed is useful in expressing movement, aperture can control the depth of field, and ISO sensitivity can control the graininess of a photo.

	Settings	Results
Aperture value	Wide aperture = more light Narrow aperture = less light	 Wide = small depth of field Narrow = large depth of field

	Settings	Results
Shutter speed	Fast speed = less light Slow speed = more light	 Fast = still Slow = blurry
ISO sensitivity	High sensitivity = more sensitive to light Low sensitivity = less sensitive to light	 High = more grainy Low = less grainy

Correlation between focal length, angle, and perspective

Focal length, which is measured in millimeters, is the distance between the middle of the lens to its focal point. It affects the angle and perspective of captured images. A short focal length translates into a wide angle, which allows you to capture a wide shot. A long focal length translates into a narrow angle, which allows you to capture telephoto shots.

Short focal length

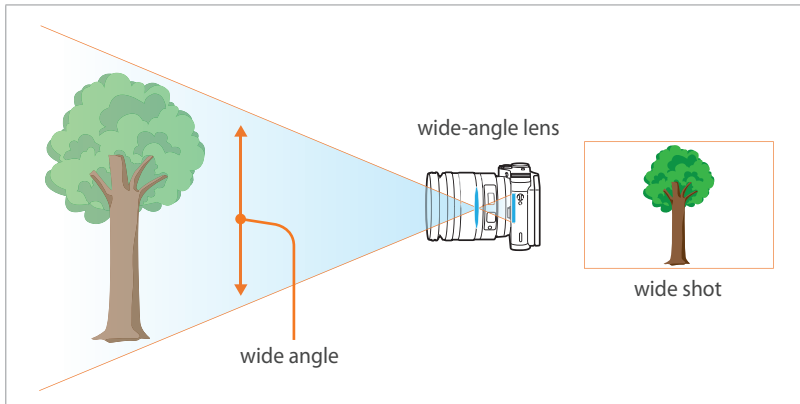

Long focal length

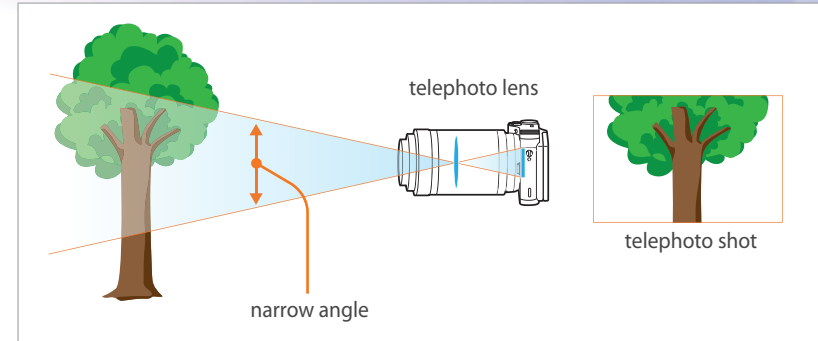

Look at these photos below and compare the changes.



18 mm angle

55 mm angle

200 mm angle



Normally, a lens with a wide angle is suitable for shooting landscapes and a lens with a narrow angle is recommended for shooting sports events or portraits.

Depth of field

Portraits or still-life photos mostly acclaimed by people are the ones on which the background is out of focus so the subject looks pronounced. Depending on the focused areas, a photo can be blurred or sharpened. This is called 'a low DOF' or 'a high DOF'.

The depth of field is the focused area around the subject. Therefore, a small DOF signifies that the focused area is narrow and a large DOF means the focused area is wide.

A photo with a small DOF, which stresses the subject and makes the rest of it blurred, can be obtained by using a telescope lens or selecting a low aperture value. Conversely, a photo with a large DOF which shows all the elements on the photo sharply focused can be achieved by using a wide angle lens or selecting a high aperture value.



Small Depth of Field

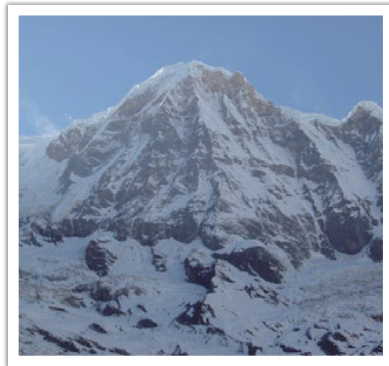

Large Depth of Field

What controls out-of-focus effects?

DOF depends on aperture value

The wider the aperture is (namely the lower the aperture value), the lower the DOF becomes. Under the condition where the other values including shutter speed and ISO sensitivity are equal, a low aperture value leads to a photo with a low DOF.



55 mm F5.7



55 mm F22

DOF depends on focal length

The longer the focal length is, the lower the DOF gets. A telescope lens with a longer focal length than a telescope lens with a short focal length is better to capture a photo of a low DOF.

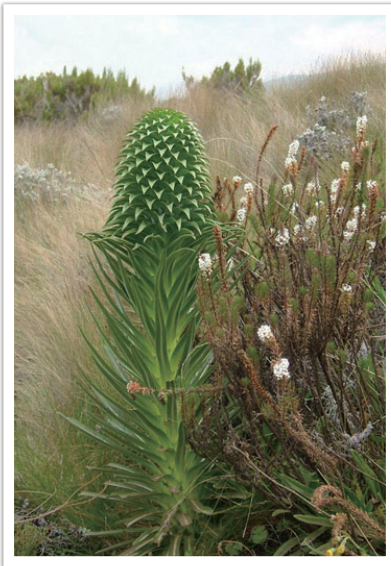

A photo captured with a 18 mm telescope lens



A photo captured with a 100 mm telescope lens

DOF depends on the distance between the subject and the camera

The shorter the distance between the subject and the camera is, the lower the DOF gets. Therefore, taking a photo close to a subject can result in a photo of low DOF.



A photo captured with a 100 mm telescope lens

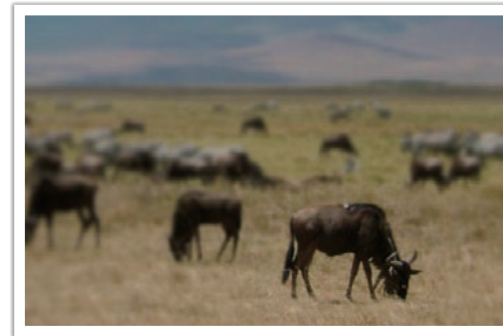

A photo captured close to the subject

Optical preview

You can press the Custom button to view the optical preview before capturing a photo. The camera adjusts the aperture to the predefined settings and shows the results on the screen. Set the Custom button to **Optical preview**. (p. 150)

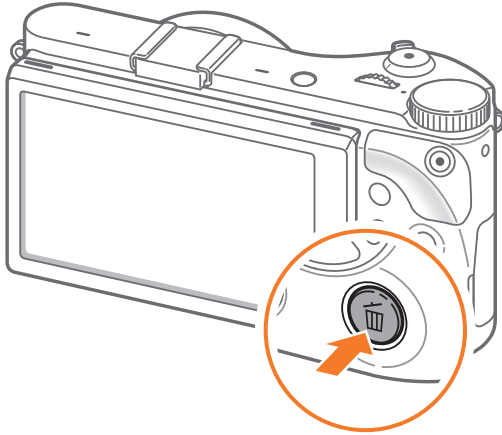

Composition

It is fun to capture a photo of the beauty of world with a camera. No matter how the world is beautiful, however, a poor composition cannot capture the beauty of it.

When it comes to composition, it is very important to prioritize subjects.

Composition in photography means arranging objects in a photo. Usually, abiding by the rule of thirds leads to a good composition.

Rule of Thirds

To use the rule of thirds, divide the image into a 3x3 pattern of equal rectangles.

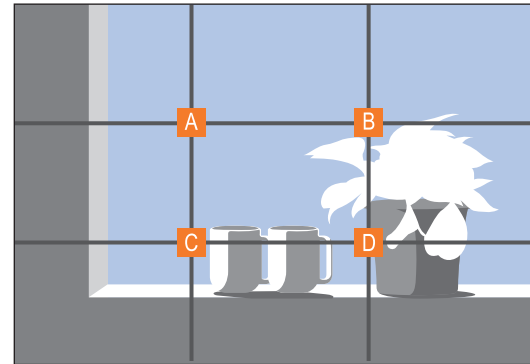

To compose photos that best emphasize the subject, make sure the subject is located at one of the corners of the center rectangle.

Using the rule of thirds will create photos with stable and compelling compositions. Below are a few examples.

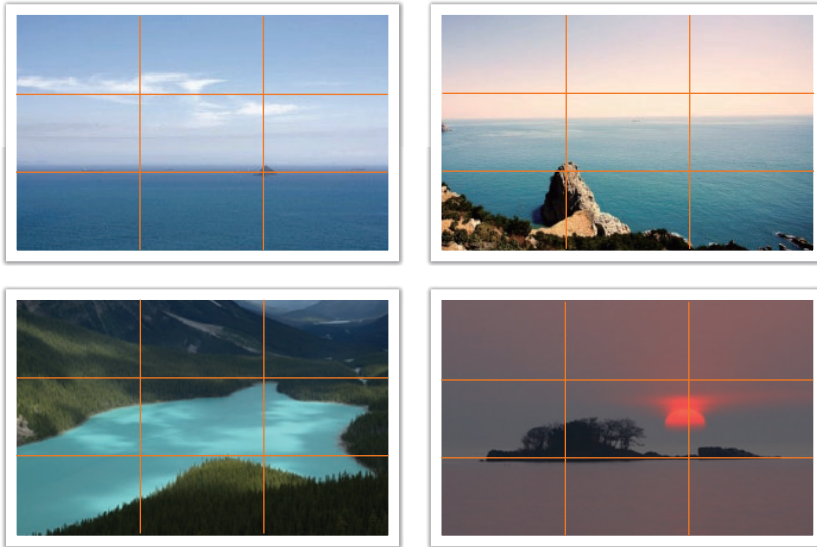

Photos with two subjects

If your subject is in one corner of the photo, it creates an unbalanced composition. You can stabilize the photo by capturing a second subject in the opposite corner to balance the weight of the photo.

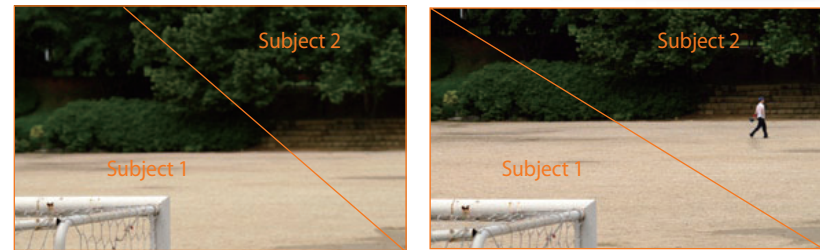

Unstable

Stable

When taking landscape photos, centering the horizon will create an unbalanced effect. Give more weight to the photo by moving the horizon up or down.



Unstable

Stable

Flash

Light is one of the most important components in photography. It's not easy, however, to have an enough amount of light anytime and anywhere. Making use of a flash allows you to optimize light settings and create a variety of effects.

Flash, also known as strobe or speed light, helps to create adequate exposure in low-light conditions. It is also useful in light-abundant situations. For example, flash can be used in compensating the exposure of a subject's shadow or capturing clearly both the subject and the background in backlit conditions.



Before correction



After correction

Flash guide number

The model number of a flash refers to the flash's power, and the maximum amount of light created is represented by a value known as a "guide number." The bigger the guide number, the more light is emitted from the flash. The guide number is achieved by multiplying the distance from the flash to the subject and the aperture value when the ISO sensitivity is set to 100.

Guide number = Flash to Subject Distance X Aperture value

Aperture value = Guide number / Flash to Subject Distance

Flash to Subject Distance = Guide number / Aperture value

Therefore, if you know the guide number of a flash, you can estimate an optimum flash to subject distance when setting the flash manually. For example, if a flash has a guide number of GN 20 and is 4 meters away from the subject, the optimal aperture value is F5.0.

Bounce Photography

Bounce photography refers to the method of bouncing light off of the ceiling or walls so that the light spreads evenly over the subject. Normally, photos captured with flash may appear unnatural and cast shadows. Subjects in photos captured with bounce photography cast no shadows and look smooth due to evenly spread light.





Chapter 1

My Camera

Learn about your camera's layout, display icons, lens, optional accessories,
and basic functions.

Getting started

Unpacking

Check your product box for the following items.

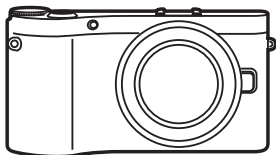

Camera
(including the body cap and hot-shoe cover)

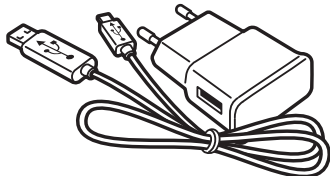

AC adapter/USB cable

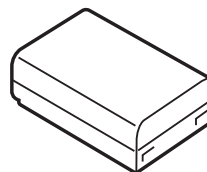

Rechargeable battery



External flash

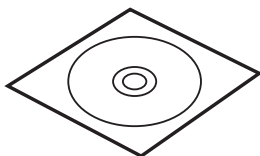

Software CD-ROM
(User manual included)

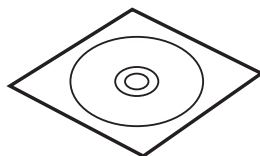

Adobe Photoshop Lightroom DVD-ROM

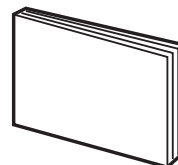

Quick Start Guide



Strap



- The illustrations may differ from your actual items.
- You can purchase optional accessories at a retailer or a Samsung service center. Samsung is not responsible for any problems caused by using unauthorized accessories. For information about accessories, refer to page 195.

Camera layout

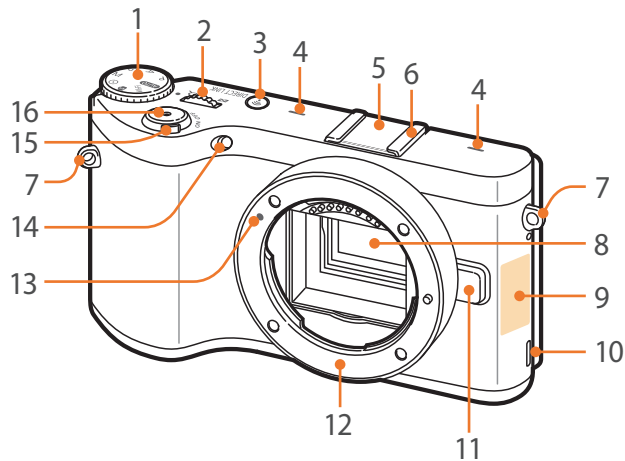

No.	Name
1	Mode dial <ul style="list-style-type: none"> • AUTO: Smart Auto mode (p. 54) • P: Program mode (p. 56) • A: Aperture Priority mode (p. 57) • S: Shutter Priority mode (p. 58) • M: Manual mode (p. 59) • i: Lens Priority mode (p. 60) • S: Smart mode (p. 64) • Wi-Fi: Wi-Fi (p. 122)
2	Jog dial <ul style="list-style-type: none"> • In the Menu screen: Move to a desired menu item. • In the Smart panel: Adjust a selected option. • In Shooting mode: Adjust shutter speed or aperture value in some shooting modes or change the size of a focus area. • In Playback mode: View thumbnails, enlarge or reduce a photo, or open or close a folder of continuous or burst shots in Playback mode.
3	DIRECT LINK button : Start a preset Wi-Fi function. (p. 32)

No.	Name
4	Microphone
5	Hot-shoe cover
6	Hot-shoe
7	Eyelet for camera strap
8	Image sensor
9	Internal antenna/NFC tag * Avoid contact with the internal antenna while using the wireless network.
10	Speaker
11	Lens release button
12	Lens mount
13	Lens mount index
14	AF-assist light/Timer lamp
15	Power switch
16	Shutter button

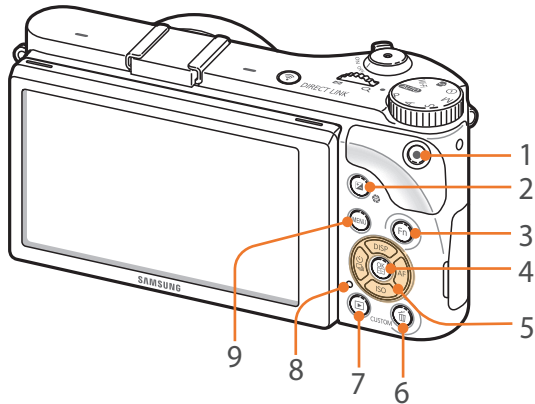

No.	Name
1	Video recording button Start recording a video.
2	EV adjust button (p. 102) Press and hold the button, and then scroll the jog dial to adjust the exposure value. In M mode, the aperture value will be adjusted.
3	Fn button Access the Smart panel and fine-tune some settings.
4	OK button <ul style="list-style-type: none"> • In the Menu screen: Save the selected options. • In Shooting mode: Allow you to select a focus area manually in some shooting modes.
5	Navigation button <ul style="list-style-type: none"> • In Shooting mode <ul style="list-style-type: none"> - DISP: View camera settings and change options. - ISO: Select an ISO value. - ⚙️: Select a drive option. - AF: Select an AF mode. • In other situations Move up, down, left, right, respectively.

No.	Name
6	Delete/Custom button <ul style="list-style-type: none"> • In Shooting mode: Perform the assigned function. (p. 150) • In Playback mode: Delete files.
7	Playback button Enter Playback mode.
8	Status lamp Indicate the status of the camera. <ul style="list-style-type: none"> • Blinking: When saving a photo, shooting a video, sending data to a computer, connecting to WLAN, or sending a photo. • Steady: When there is no data transfer, when data transfer to a computer is complete, or charging the battery.
9	MENU button Access options or menus.

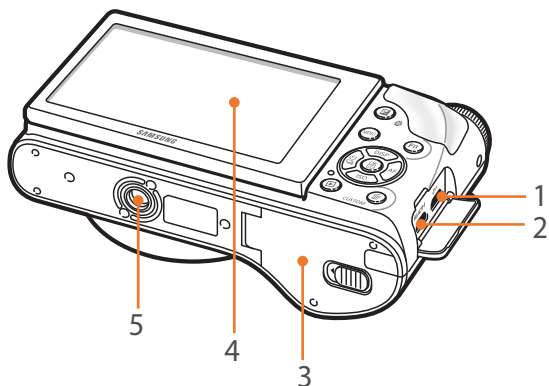

No.	Name
1	USB and shutter release port Connect the camera to a computer or shutter release. Use a shutter release cable with a tripod to minimize camera movement.
2	HDMI port
3	Battery chamber/Memory card cover Insert a memory card and battery.
4	Display <ul style="list-style-type: none"> To take photos at high or low angles, tilt the display up or down. (p. 14) Touch the screen to select a menu or an option. (p. 36)
5	Tripod mount

Using the DIRECT LINK button

You can turn on the Wi-Fi feature conveniently by pressing [**DIRECT LINK**]. Press [**DIRECT LINK**] again to return to the previous mode.

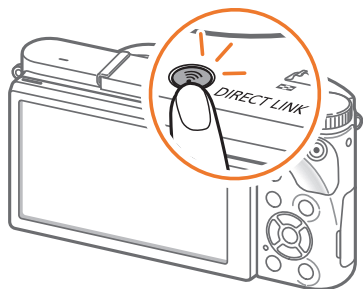

Setting the DIRECT LINK button

You can select a Wi-Fi function to launch when you press [**DIRECT LINK**]. (p. 150)

To set a **DIRECT LINK** option,

In Shooting mode, press [**MENU**] → → **Key Mapping** → **DIRECT LINK** → an option.

Inserting the battery and memory card

Learn how to insert the battery and an optional memory card into the camera.

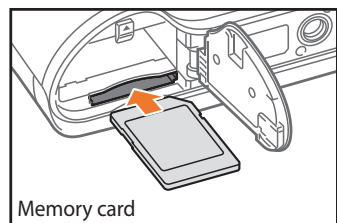
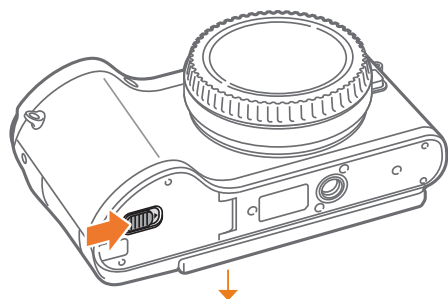

Insert a memory card with the gold-colored contacts facing down.

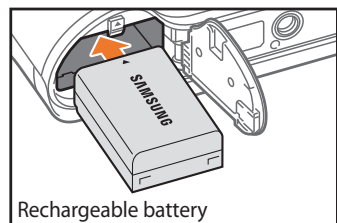

Insert the battery with the Samsung logo facing up.

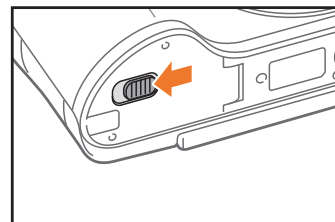
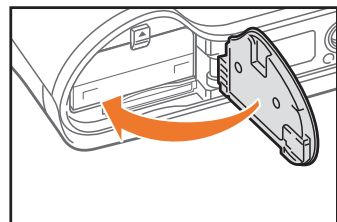

Removing the battery and memory card

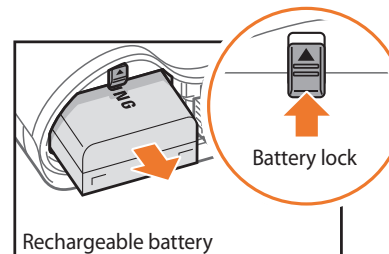

Slide the lock up to release the battery.

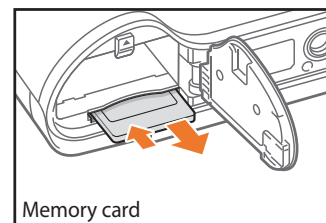

Push the card gently until it disengages from the camera, and then pull it out of the slot.

Using the memory card adapter

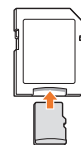

To use micro memory cards with this product, a PC, or a memory card reader, insert the card into an adapter.



While the status lamp of the camera is blinking, do not remove the memory card or battery. Doing so may damage the data stored on the memory card or your camera.

Charging the battery and turning on your camera

Charging the battery

Before you use the camera for the first time, you must charge the battery. Plug the small end of the USB cable into your camera, and then plug the other end of the USB cable into the AC adapter.

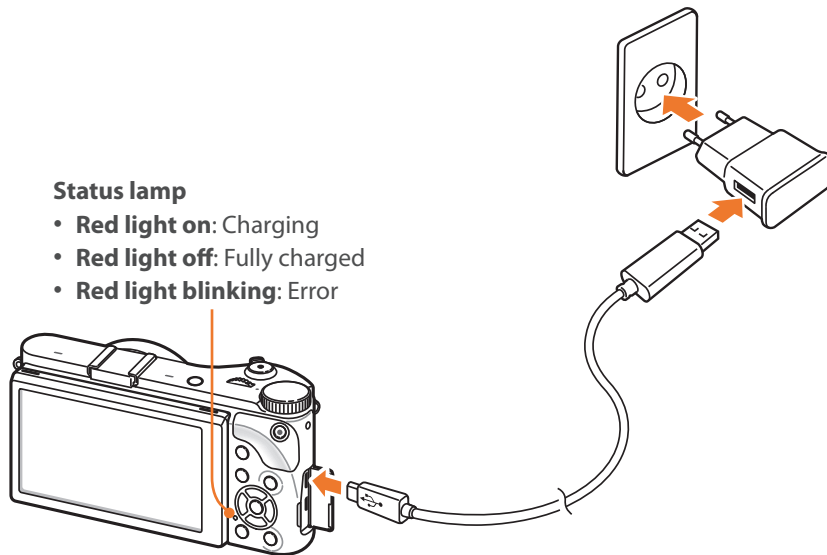

- Use only the AC adapter and USB cable supplied with your camera. If you use another AC adapter, the camera battery may not charge or work properly.
- You can charge the battery with the USB cable only when the camera is turned off.

Turning on your camera

Set the Power switch to **ON**.

- To turn your camera off, set the Power switch to **OFF**.
- The initial setup screen appears when you turn on the camera for the first time. (p. 35)

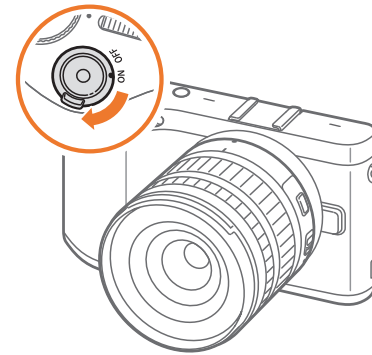

Performing the initial setup

When you turn on your camera for the first time, the initial setup screen appears. The language is preset for the country or region where the camera is sold. You can change the language as desired. You can also select an item by touching it on the screen.

1 Press **[ISO]** to select **Time Zone**, and then press **[AF]** or **[OK]**.

2 Press **[DISP/ISO]** to select a time zone, and then press **[OK]**.

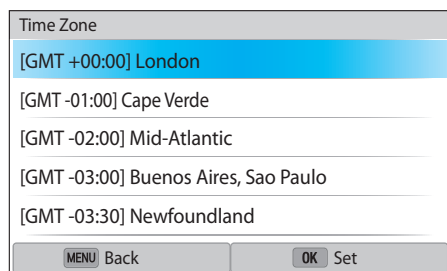

3 Press **[ISO]** to select **Date & Time**, and then press **[AF]** or **[OK]**.

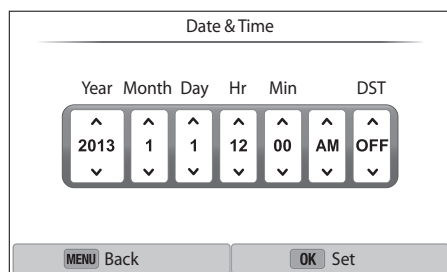

- The screen may differ depending on the language selected.

4 Press **[DISP/AF]** to select an item (Year/Month/Day/Hr/Min/DST).

5 Press **[DISP/ISO]** to set the option, and then press **[OK]**.

6 Press **[ISO]** to select **Date Type**, and then press **[AF]** or **[OK]**.

7 Press **[DISP/ISO]** to select a date type, and then press **[OK]**.

8 Press **[ISO]** to select **Time Type**, and then press **[AF]** or **[OK]**.

9 Press **[DISP/ISO]** to select a time type, and then press **[OK]**.

10 Press **[MENU]** to finish the initial setup.

Selecting functions (options)

Selecting with buttons

Scroll the jog dial or press [DISP/ISO/⏏/AF] to move, and then press [OK] to select an option.

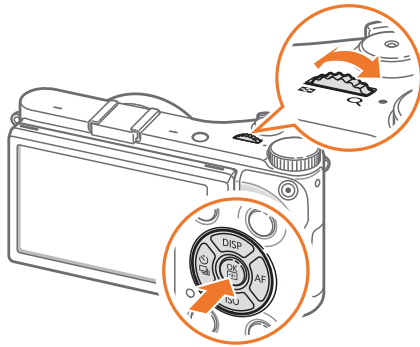

Selecting by touch



Do not use sharp objects, such as pens or pencils, to touch the screen. You can damage the screen.

Touching: Touch an icon to select a menu or an option.



Dragging: Touch and hold an area on the screen, and then drag your finger.

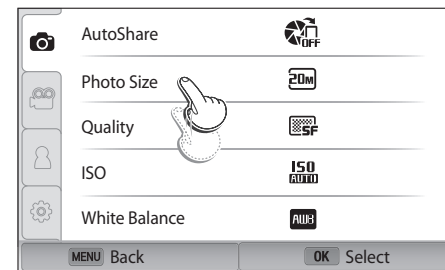

Flicking: Gently flick your finger across the screen.

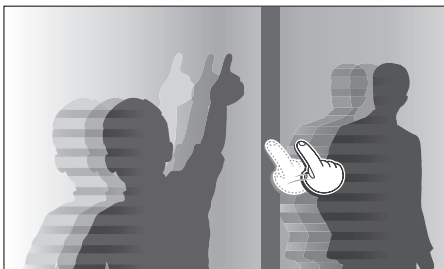

- The touch screen may not recognize your inputs if you touch multiple items at the same time.
- When you touch or drag the screen, discolorations may occur. This is not a malfunction, but a characteristic of the touch screen. Touch or drag lightly to minimize the discolorations.
- The touch screen may not work properly if you use the camera in extremely humid environments.
- The touch screen may not work properly if you apply screen protection film or other accessories to the screen.
- Depending on the viewing angle, the screen may appear dim. Adjust the brightness or viewing angle to improve the resolution.

Using MENU

Press [MENU] or touch **MENU** on the screen, and then change shooting options or settings.

E.g. Selecting the photo size in P mode

- 1 Rotate the mode dial to **P**.
- 2 Press [MENU] or touch **MENU**.
- 3 Press [] → [DISP/ISO] to move to , and then press [].
 - You can also touch on the screen.
- 4 Scroll the jog dial or press [DISP/ISO] to move to **Photo Size**, and then press [].
 - You can also drag the option list, and then touch an option.

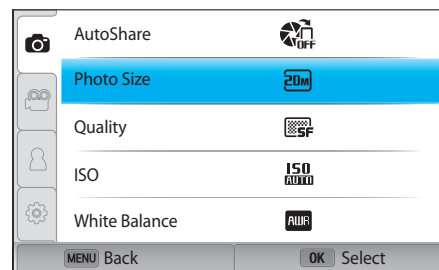

5 Scroll the jog dial or press [DISP/ISO] to move to an option, and then press [OK].

- You can also drag the option list, and then touch an option.
- Press [MENU] or touch **Back** to go back to the previous menu.

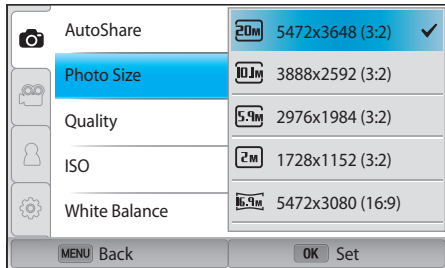

6 Press [MENU] or touch **Back** to switch to Shooting mode.

Using the Smart panel

Press [Fn] or touch **Fn** on the screen to access some functions such as Exposure, ISO, and White Balance.

E.g. Adjust the exposure value in P mode

- 1 Rotate the mode dial to **P**.
- 2 Press [Fn] or touch **Fn**.

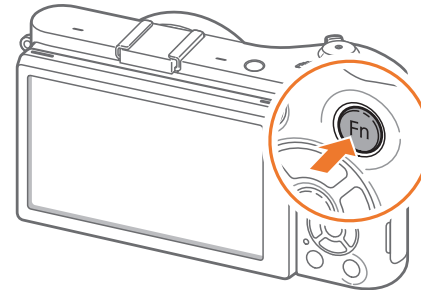

- 3 Press [DISP/ISO//AF] to move to **EV**, and then press [].
- You can directly select an option by scrolling the jog dial without having to press [].
 - You can also select an option by touching it.

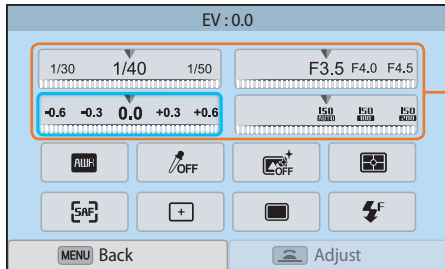

You can adjust some options by dragging them.

- 4 Scroll the jog dial or press [/AF] to adjust the exposure value, and then press [].
- You can also drag the dial on the screen, and then select **Set** to adjust the option.

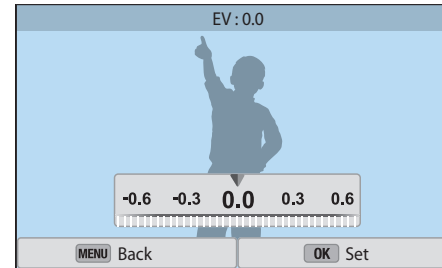

Display icons

In Shooting mode

Capturing photos

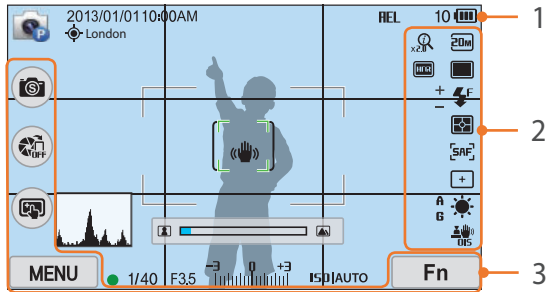

1. Shooting information

Icon	Description
	Shooting mode
2013/01/01	Current date
10:00AM	Current time
	GPS activated*
London	Location information*
	Memory card not inserted**
HEL	Auto exposure lock (p. 103)
10	Available number of photos
	<ul style="list-style-type: none"> : Fully charged : Partially charged : Empty (recharge the battery)

Icon	Description
	Auto focus frame
	Spot metering area
	Camera shake
	Manual focus scale
	Level gauge (p. 41)
	Histogram (p. 150)
	Focus
1/40	Shutter speed
F3.5	Aperture value
	Exposure adjustment value
ISO AUTO	ISO sensitivity (p. 75)

* These icons appear when you attach an optional GPS module.

** Photos that were captured without inserting a memory card cannot be transferred to a memory card or a computer.

2. Shooting options

Icon	Description
	Photo size
	Drive mode
	Flash (p. 94)
	Flash intensity adjustment
	Metering (p. 97)

Icon	Description
	AF mode (p. 80)
	Focus area
	Face detection
	White Balance (p. 76)
A B G M	White Balance micro adjustment
	Optical Image Stabilization (OIS) (p. 89)
	Zoom on
x2.0	Zoom ratio
	RAW file
	Dynamic Range (p. 100)

3. Shooting options (Touch)

Icon	Description
	Change Smart mode***
	AutoShare
	Touch AF options
	Shooting options
	Smart panel

*** This icon appears only when you select Smart mode.



The icons displayed will change according to the mode you select or the options you set.

Recording videos

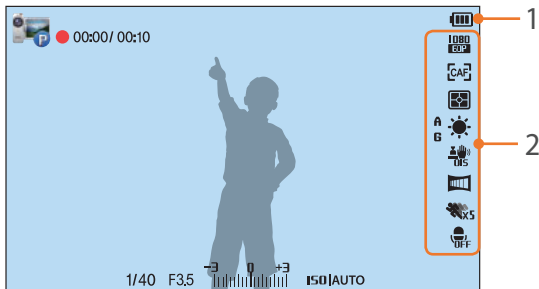

1. Shooting information

Icon	Description
	Shooting mode
00:00/00:10	Current recording time/Available recording time
	<ul style="list-style-type: none"> : Fully charged : Partially charged : Empty (recharge the battery)
1/40	Shutter speed
F3.5	Aperture value
	Exposure value
ISO AUTO	ISO sensitivity (p. 75)

2. Shooting options

Icon	Description
	Video size
	AF mode (p. 80)
	Metering (p. 97)
	White Balance (p. 76)
	Optical Image Stabilization (OIS) (p. 89)
	White Balance micro adjustment
	Fader (p. 105)
	Multi Motion (p. 105)
	Voice recording off (p. 106)



The icons displayed will change according to the mode you select or the options you set.

About the level gauge

The level gauge helps you align the camera with the horizontal and vertical lines on the display. If the level gauge is not level, calibrate the level gauge using the Horizontal Calibration function. (p. 152)

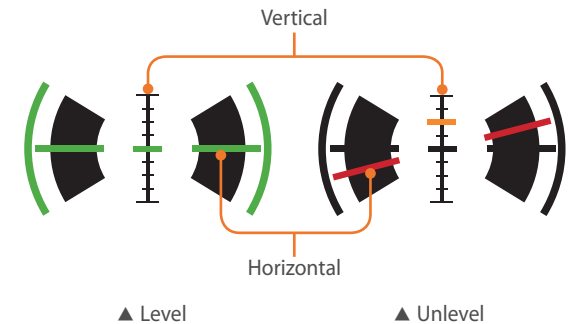

You cannot use the level gauge when you shoot in portrait orientation.

In Playback mode

Viewing photos

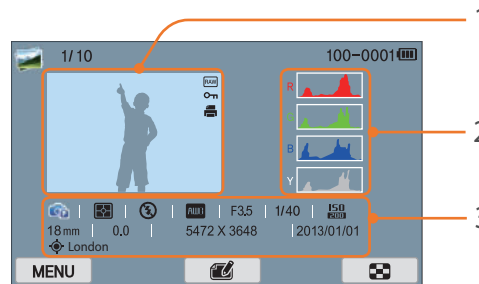
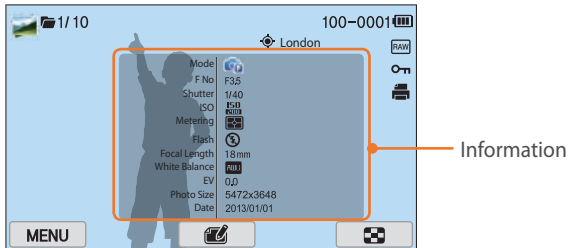

Playing videos

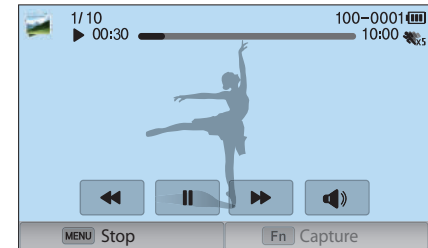

Icon	Description
	Continuously captured file
1/10	Current file/The total number of files
100-0001	Folder number - File number
	File with location information
London	Location information
	RAW file
	Protected file
	Print information added to file (p. 114)
	3D file
MENU	Playback/Editing menu (Touch)
	Editing photos (Touch)
	Trimming a video (Touch)
	Viewing image thumbnails (Touch)

No.	Description
1	Captured photo
2	RGB histogram (p. 150)
3	Shooting mode, Metering, Flash, White Balance, Aperture value, Shutter speed, ISO, Focal length, Exposure value, Photo size, Date, Location information

Icon	Description
	Playback speed
	Multi Motion
00:30	Current playback time
10:00	Video length
	View previous file/Scan backward. (Each time you touch the scan backward icon, you change the scan speed in this order: 2X, 4X, 8X.)
	Pause or resume playback.
	View next file/Scan forward. (Each time you touch the scan forward icon, you change the scan speed in this order: 2X, 4X, 8X.)
	Adjust the volume or mute the sound.

Changing the information displayed

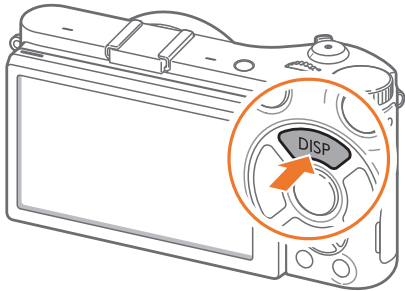

Press [**DISP**] repeatedly to change the display type.

Mode	Display type
Shooting	<ul style="list-style-type: none"> • Display shooting options at the right of the display, AutoShare, Touch AF, and basic shooting information (Shooting mode, Shutter speed, Aperture value, Exposure value, ISO sensitivity, AEL).
	<ul style="list-style-type: none"> • Display all information about shooting including histogram, date, and time. (p. 150)
	<ul style="list-style-type: none"> • Hide information about shooting except basic shooting information.
	<ul style="list-style-type: none"> • Basic shooting information and the level gauge.
Playback	<ul style="list-style-type: none"> • Basic information
	<ul style="list-style-type: none"> • Display all information about the current file.
	<ul style="list-style-type: none"> • Display all information about the current file including RGB histogram.



Lenses

You can purchase optional lenses made exclusively for your NX series camera.

Learn about the functions of each lens and select one that suits your needs and preferences.

Lens layout

SAMSUNG 18-55 mm F3.5-5.6 OIS III lens (example)

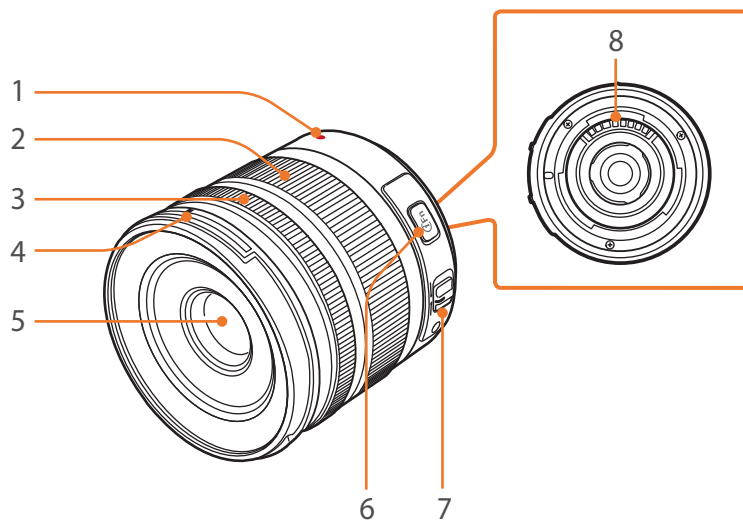

No.	Description
1	Lens mount index
2	Zoom ring
3	Focus ring (p. 88)
4	Lens hood mount index
5	Lens
6	i-Function button (p. 60)
7	AF/MF switch (p. 80)
8	Lens contacts



When not using the lens, attach the lens cap and lens mount cover to protect the lens from dust and scratches.

SAMSUNG 20-50 mm F3.5-5.6 ED II lens (example)

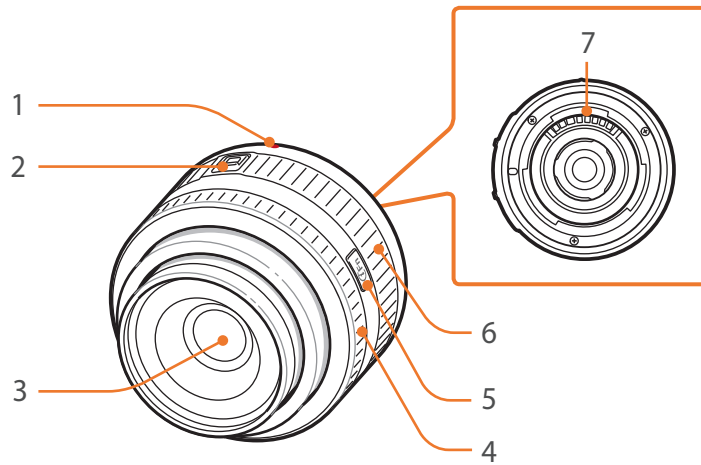

Locking or unlocking the lens

To lock the lens, pull and hold the zoom lock switch away from the camera body and rotate the zoom ring as shown in the illustration.

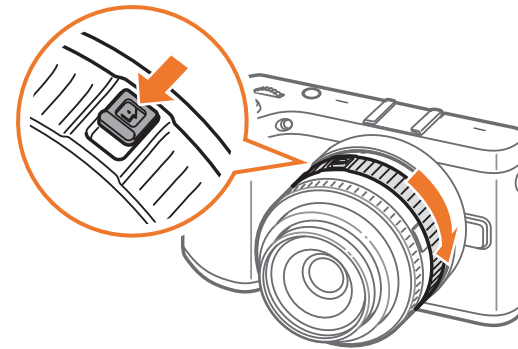

No.	Description
1	Lens mount index
2	Zoom lock switch
3	Lens
4	Focus ring (p. 88)
5	i-Function button (p. 60)
6	Zoom ring
7	Lens contacts

To unlock the lens, rotate the zoom ring as shown in the illustration until you hear the click.

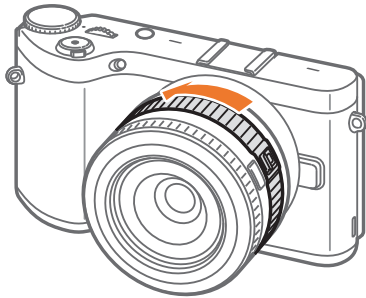

You cannot capture a photo when the lens is locked.

SAMSUNG 16 mm F2.4 lens (example)

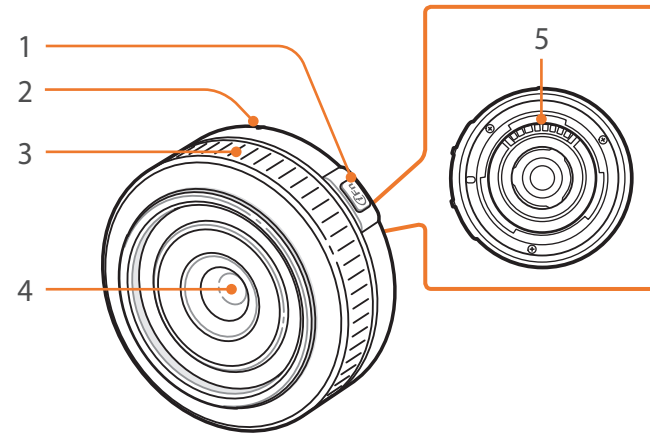

No.	Description
1	i-Function button (p. 60)
2	Lens mount index
3	Focus ring (p. 88)
4	Lens
5	Lens contacts

Lens markings

Find out what the numbers on the lens signify.

SAMSUNG 18-200 mm F3.5-6.3 ED OIS lens (example)

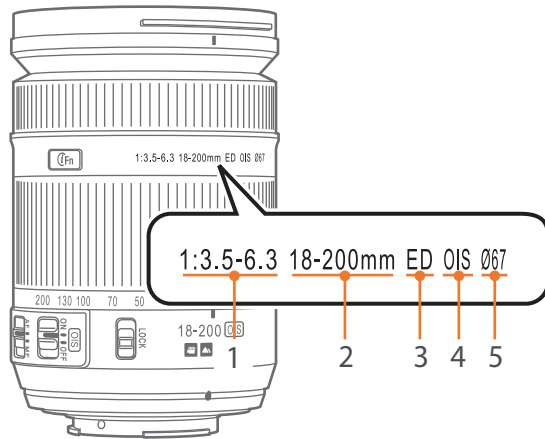

No.	Description
1	Aperture value A range of supported aperture values. For example, 1:3.5–6.3 means the maximum aperture value range from 3.5 to 6.3.
2	Focal length The distance from the middle of the lens to its focal point (in millimeters). This figure is expressed in a range: minimum focal length to maximum focal length of the lens. Longer focal lengths result in narrower angles of view and the subject is magnified. Shorter focal lengths result in wider angles of view.
3	ED ED stands for Extra-low Dispersion. Extra-low dispersion glass is effective in minimizing chromatic aberration (a distortion that occurs when a lens fails to focus all colors to the same convergence point).
4	OIS (p. 89) Optical Image Stabilization. Lenses with this feature can detect camera shake and effectively cancel out the movement inside the camera.
5	Ø The lens diameter. When you attach a filter to the lens, make sure that the diameters of the lens and the filter are the same.

Accessories

You can use accessories including external flash and GPS module that can help you capture better and more convenient photos.

For more information about optional accessories, refer to the manual for each accessory.



- The illustrations may differ from the actual items.
- You can purchase Samsung-approved accessories at a retailer or a Samsung service center. Samsung is not responsible for damage caused by using another manufacturer's accessories.

External flash layout

SEF8A (example)

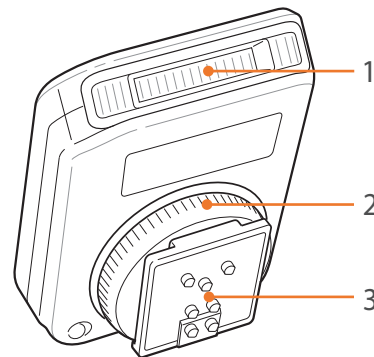

No.	Description
1	Bulb
2	Hot-shoe fastening dial
3	Hot-shoe connection

Connecting the external flash

- 1 Remove the hot-shoe cover from the camera.

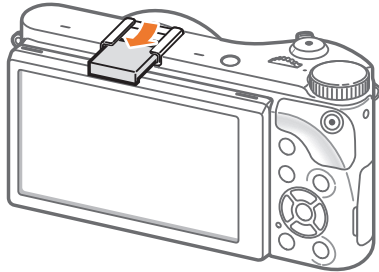

- 2 Mount the flash by sliding it into the hot-shoe.

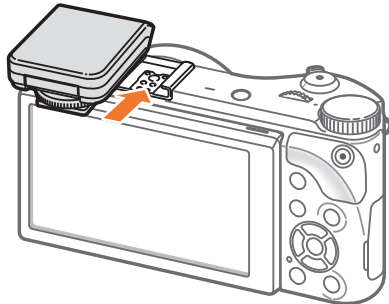

- 3 Lock the flash into place by turning the hot-shoe fastening dial clockwise.

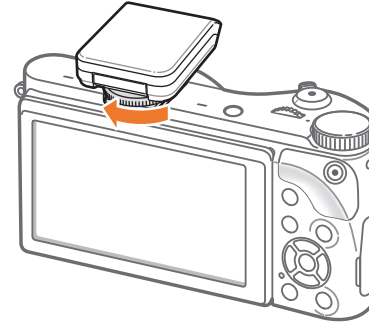

- 4 Lift up the flash for use.

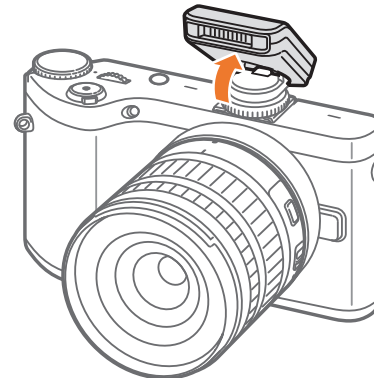



- You can capture a photo with a flash that is not fully charged, but it is recommended to use a fully charged flash.
- Refer to the optional accessories page for available external flashes. (p. 195)
- The available options may differ depending on the shooting mode.
- There is an interval between two bursts of the flash. Do not move until the flash fires a second time.
- SEF8A may not be compatible with other NX series cameras.
- For more details about optional flashes, refer to the user manual for the flash.



Use only Samsung-approved flashes. Using incompatible flashes may damage your camera.

SEF220A (example) (optional)

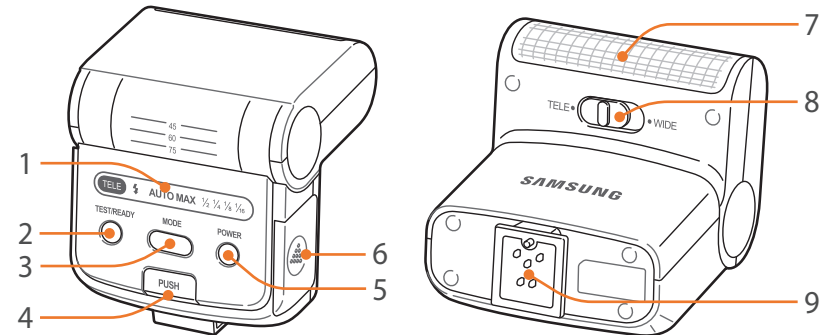

No.	Description
1	Display icons
2	READY lamp/Test button
3	MODE button
4	Flash release button
5	POWER button
6	Battery cover
7	Bulb
8	TELE/WIDE mode switch
9	Hot-shoe connection

GPS module layout (optional)

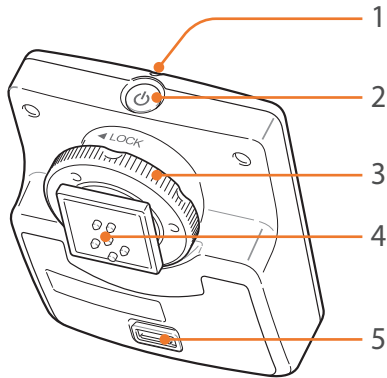

No.	Description
1	Status lamp
2	POWER button
3	Hot-shoe fastening dial
4	Hot-shoe connection
5	Battery cover

Attaching the GPS module

1 Remove the hot-shoe cover from the camera.

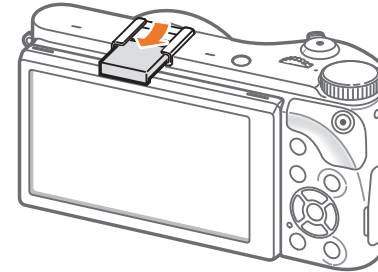

2 Mount the GPS module by sliding it into the hot-shoe.

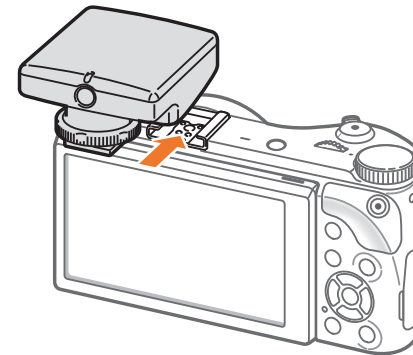

- 3 Lock the GPS module into place by turning the hot-shoe fastening dial towards LOCK.

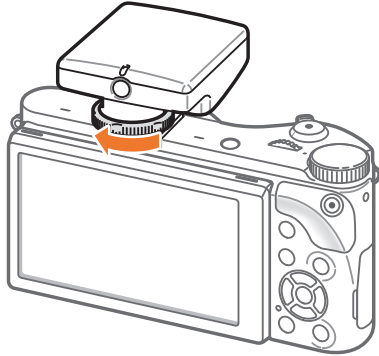

- 4 Press the power button of the GPS module.



Shooting modes

Two simple shooting modes—Smart Auto and Smart mode—help you capture photos with numerous automatic settings. Additional modes allow for greater customization of settings.



Icon	Description
AUTO	Smart Auto mode (p. 54)
P	Program mode (p. 56)
A	Aperture Priority mode (p. 57)
S	Shutter Priority mode (p. 58)
M	Manual mode (p. 59)
i	Lens Priority mode (p. 60)
S	Smart mode (p. 64)
Wi-Fi	Wi-Fi features (p. 122)

AUTO Smart Auto mode

In Smart Auto mode, the camera recognizes surrounding conditions and automatically adjusts factors that contribute to exposure, including shutter speed, aperture value, metering, White Balance, and exposure compensation. As the camera controls most of the functions, some shooting functions are limited. This mode is useful for capturing quick snapshots with the least amount of adjustment.



1 Rotate the mode dial to **AUTO**.





2 Align your subject in the frame.

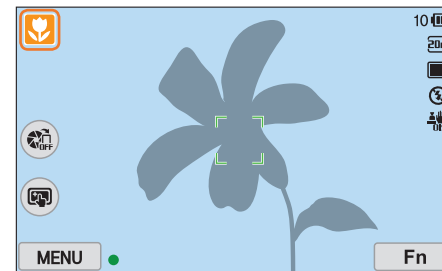











3 Half-press [**Shutter**] to focus.

- The camera selects a scene. An appropriate scene icon appears at the screen.



Recognizable scenes

Icon	Description
	Landscapes
	Scenes with bright white backgrounds
	Landscapes at night
	Portraits at night
	Landscapes with backlighting

Icon	Description
	Portraits with backlighting
	Portraits
	Close-up photos of objects
	Close-up photos of text
	Sunsets
	Indoors, dark
	Partially lit
	Close-up with spot lighting
	Portraits with spot lighting
	Blue skies
	Forested areas typically consist of green-colored subjects
	Close-up photos of colorful subjects
	Camera is stabilized on a tripod and the subject is not moving for a certain period of time. (when shooting in the dark)
	Actively moving subjects
	Fireworks (when using a tripod)



- The camera may detect different scenes, even the same subjects, depending on external factors such as camera shake, lighting, and distance to the subject.
- If the camera does not recognize an appropriate scene mode, it uses the default settings for the Smart Auto mode.
- Even if it detects a face, the camera may not select a portrait mode depending on the subject's position or lighting.
- Even if you use a tripod, the camera may not detect the tripod mode (📵) if the subject is moving.
- The camera consumes more battery power, because it changes settings often to select appropriate scenes.

4 Press **[Shutter]** to capture the photo.

P Program mode

The camera automatically adjusts shutter speed and aperture value so that an optimal exposure value can be achieved.

This mode is useful when you want to capture shots of constant exposure while being able to adjust other settings.



- 1 Rotate the mode dial to **P**.
- 2 Set the desired options.
- 3 Half-press [**Shutter**] to focus, and then press [**Shutter**] to capture the photo.

Program Shift

Program Shift function lets you adjust the shutter speed and aperture value while the camera maintains the same exposure. When you scroll the jog dial to the left, the shutter speed decreases and the aperture value increases. When you scroll the jog dial to the right, the shutter speed increases and the aperture value decreases.

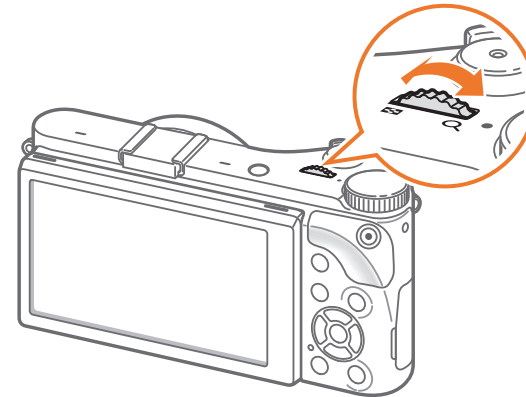

A Aperture Priority mode

In Aperture Priority mode, the camera automatically calculates shutter speed according to the aperture value you choose.

You can adjust the depth of field (DOF) by changing the aperture value. This mode is useful for taking portraits and landscape shots.

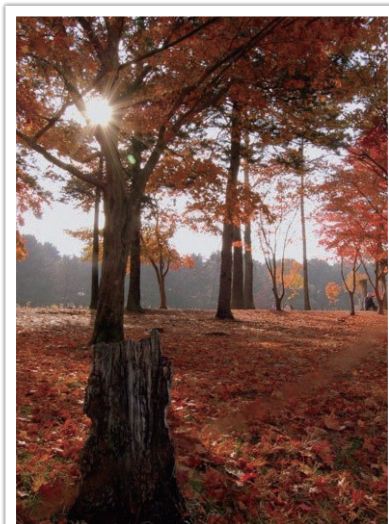

Large Depth of Field

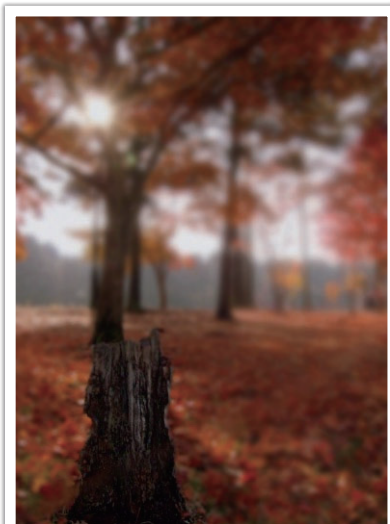

Small Depth of Field

- 1 Rotate the mode dial to **A**.
- 2 Scroll the jog dial to adjust the aperture value.
 - You can also adjust the aperture value by pressing [**Fn**], moving to the aperture value, and then scrolling the jog dial or dragging the screen.
- 3 Set the desired options.
- 4 Half-press [**Shutter**] to focus, and then press [**Shutter**] to capture the photo.



In low-light settings, you may need to increase the ISO sensitivity to prevent blurred photos.

S Shutter Priority mode

In Shutter Priority mode, the camera automatically adjusts the aperture value according to the shutter speed you choose. This mode is useful for capturing photos of fast-moving subjects or for creating tracer effects in a photo.

For example, set the shutter speed to over 1/500 s to freeze the subject. To make the subject appear blurred set the shutter speed to below 1/30 s.



Slow shutter speed

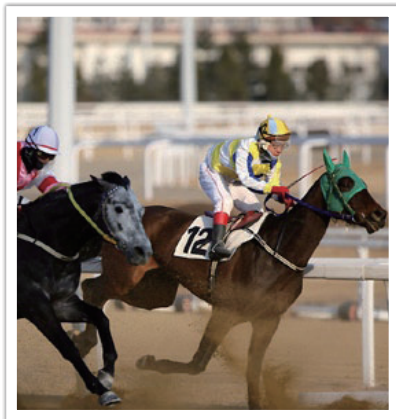

Fast shutter speed

- 1 Rotate the mode dial to **S**.
- 2 Scroll the jog dial to adjust the shutter speed.
 - You can also adjust the shutter speed by pressing [**Fn**], moving to the shutter speed, and then scrolling the jog dial or dragging the screen.
- 3 Set the desired options.
- 4 Half-press [**Shutter**] to focus, and then press [**Shutter**] to capture the photo.



In order to compensate for the reduced amount of light allowed by fast shutter speeds, open the aperture and let in more light. If your photos are still too dark, increase the ISO value.

M Manual mode

Manual mode lets you adjust the shutter speed and aperture value manually. In this mode, you can fully control the exposure of your photos.

This mode is useful in controlled shooting environments, such as a studio, or when it is necessary to fine-tune camera settings. The Manual mode is also recommended for shooting night scenes or fireworks.

- 1 Rotate the mode dial to **M**.
- 2 Scroll the jog dial to adjust the shutter speed.
- 3 Press and hold [, and then rotate the mode dial to adjust the aperture value.
 - You can also adjust the shutter speed or the aperture value by pressing [**Fn**], moving to the shutter speed or the aperture value, and then scrolling the jog dial or dragging the screen.
- 4 Set the desired options.
- 5 Half-press [**Shutter**] to focus, and then press [**Shutter**] to capture the photo.

Framing mode

When you adjust the aperture value or shutter speed, the exposure changes according to the settings, so the display may darken. With this function on, the brightness of the display is constant regardless of the settings, so you can better frame your shot.

To use Framing Mode,

In Shooting mode, press [**MENU**] →  → **Framing Mode** → an option.

Using the Bulb function

Use the Bulb function to shoot night scenes or the night sky. While you are pressing [**Shutter**], the shutter is left open so you can create moving light effects.

To use a bulb,

Completely scroll the jog dial to the left to **Bulb** → Press and hold [**Shutter**] for the desired time.





- If you set a high ISO value or open the shutter for a long time, image noise may increase.
- Drive options, flash, and One touch shot cannot be used with the Bulb function.
- The Bulb function is available only in Manual mode.
- Use a tripod and shutter release to prevent your camera from shaking.
- The longer you open the shutter, the longer it takes to save a photo. Do not turn the camera off while the camera saves a photo.
- If you use this function for a long time, use a fully charged battery.



Lens Priority mode

Using Depth

You can adjust the depth of field to blur or sharpen the background.

1 Rotate the mode dial to .

2 Press [**i-Function**] on the lens to select  Depth.

- You can also press [**i-Function**], and then press [/AF] or drag the screen to select  Depth.

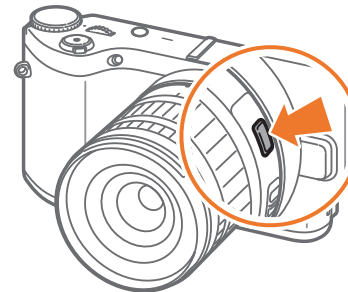

3 Adjust the focus ring to select a value.

- You can also scroll the jog dial to adjust the value.
- You can also drag the slider or touch +/- to adjust the value.

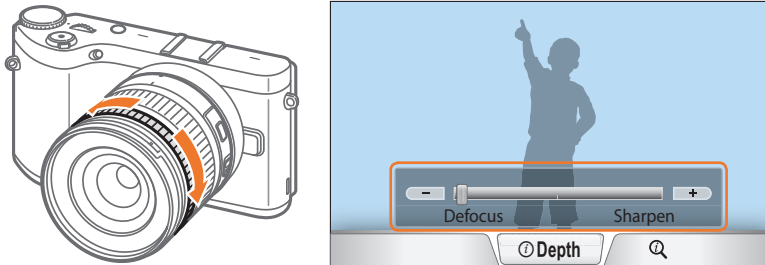

4 Half-press [Shutter] to focus, and then press [Shutter] to capture the photo.



- As you sharpen photos, the aperture value increases and the shutter speed reduces. In dark places, photos may be blurry.
- This function is not available when you set **3D Auto Mode** in 3D mode.

Using i-Function in P/A/S/M modes

When you use the i-Function button on an i-Function lens, you can manually select and adjust shutter speed, aperture value, exposure value, ISO sensitivity, and White Balance on the lens.

1 Rotate the mode dial to **P**, **A**, **S**, or **M**.

2 Press [**i-Function**] on the lens to select a setting.

- You can also press [**i-Function**], and then press [**AF**] or drag the screen to select a setting.

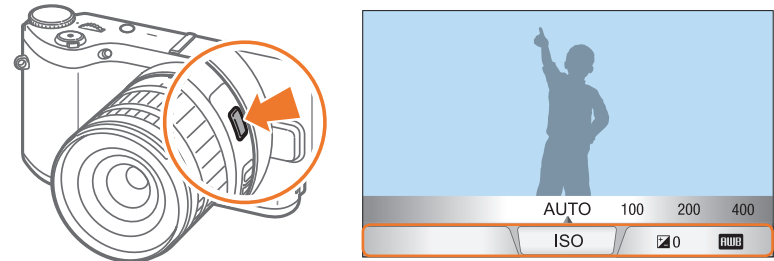

3 Adjust the focus ring to select an option.

- You can also scroll the jog dial or drag the screen to select an option.

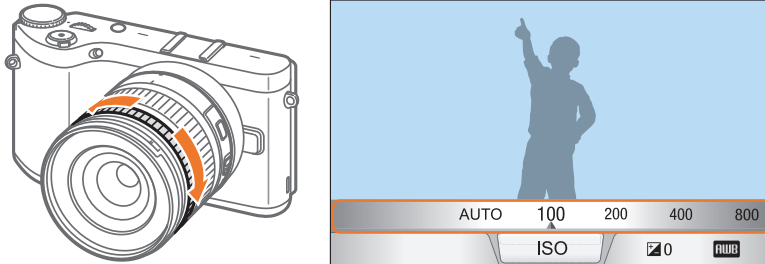

4 Half-press [Shutter] to focus, and then press [Shutter] to capture the photo.

Available options





Shooting mode	P	A	S	M	3D
Aperture	-	O	-	O	-
Shutter Speed	-	-	O	O	-
EV	O	O	O	-	O
ISO	O	O	O	O	-
White Balance	O	O	O	O	O
Zoom	O	O	O	O	-



- To select items to appear when you press [**i-Function**] on the lens in Shooting mode, press [**MENU**] → → **iFn Customizing** → an item.
- This function is not available when you set **3D Auto Mode** in 3D mode.

Using Zoom

The  **Zoom** allows you to zoom in on a subject with less degradation of photo quality than the Digital zoom. However, the photo resolution may change compared to when you zoom in by rotating the zoom ring.



- 1 Rotate the mode dial to **P**, **A**, **S**, **M**, or .
- 2 Press [**i-Function**] on the lens to select  **Zoom**.
 - You can also press [**i-Function**], and then press [/AF] or drag the screen to select  **Zoom**.
- 3 Adjust the focus ring to select a zoom ratio.
 - You can also scroll the jog dial or drag the screen to select an option.
 - Photo resolution varies according to the zoom ratio if you use the  **Zoom**.

	3:2	16:9	1:1
x1.2	4560X3040 (13.9M)	4560X2568 (11.7M)	3040X3040 (9.2M)
x1.4	3888X2592 (10.1M)	3888X2184 (8.5M)	2592X2592 (6.7M)
x1.7	3264X2176 (7.1M)	3264X1840 (6.0M)	2176X2176 (4.7M)
x2	2736X1824 (5.0M)	2736X1536 (4.2M)	1824X1824 (3.3M)

These figures are based on the maximum resolution at each image ratio.

- 4 Half-press [**Shutter**] to focus, and then press [**Shutter**] to capture the photo.





-  **Zoom** is not available when you capture burst shots.
-  **Zoom** is not available when you capture photos in the RAW file format.
-  **Zoom** is deactivated when you record videos by pressing the video recording button.
- This function is not available when you set **3D Auto Mode** in 3D mode.

Smart mode

In Smart mode, you can capture photos with options that are preset for a specific scene.

1 Rotate the mode dial to .

2 Select a scene.

- To select a shooting mode when the mode dial is set to , press [Fn] or touch , and then select a desired mode.

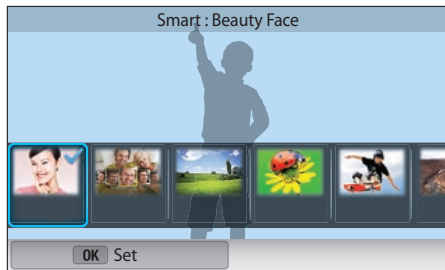

Option	Description
Beauty Face	Capture a portrait with options to hide facial imperfections.
Best Face	Capture multiple photos and replace faces to create the best possible image.
Landscape	Capture still-life scenes and landscapes.

Option	Description
Macro	Capture small or close-up subjects.
Action Freeze	Capture subjects moving at high speed.
Rich Tones	Capture a photo with vibrant colors.
Panorama	Capture a wide panoramic scene in a single photo.
Waterfall	Capture scenes with waterfalls.
Silhouette	Capture subjects as dark shapes against a light background.
Sunset	Capture scenes at sunset, with natural-looking reds and yellows.
Night	Capture multiple photos in low light conditions without a flash. The camera combines them to create a single image that is brighter and has less blurring.
Fireworks	Capture scenes with fireworks.
Light Trace	Capture scenes with the light trailing in low-light conditions.
Creative Shot	Capture photos with effects applied automatically.

3 Half-press [**Shutter**] to focus, and then press [**Shutter**] to capture.

Using the Best Face mode

In Best Face mode, you can capture multiple photos and replace faces to create the best possible image. Use this mode to select the best image for each individual when capturing group photos.

- 1 Rotate the mode dial to **S**, and then select **Best Face**.
- 2 Align your subject in the frame, and then half-press **[Shutter]** to focus.
- 3 Press **[Shutter]** to capture the photo.
 - The camera captures 5 photos consecutively.
 - The first photo is set as the background image.
 - The camera automatically detects faces after shooting.
- 4 Touch a face to replace.

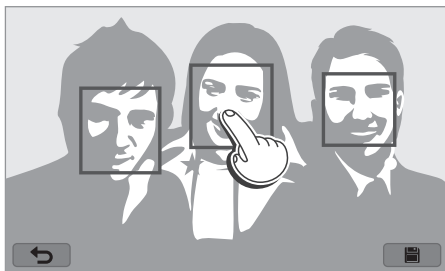

- 5 Touch the best image from the 5 faces that were captured.
 - Repeat steps 4 and 5 to replace the rest faces of the photo.
 - The  icon will appear on the image that the camera recommends.



- 6 Touch  to save the photo.



- Use a tripod to prevent your camera from shaking.
- The resolution is set to 5.9M or smaller.

Capturing panoramic photos

Capture a 2D or 3D panoramic photo. Captured 3D panoramic photos can be viewed only on a 3D TV or 3D monitor.

- 1 Rotate the mode dial to **S**, and then select **Panorama**.
- 2 Press **[MENU]** →  → **Panorama** → **Live Panorama** or **3D**.
- 3 Press **[MENU]** to return to Shooting mode.
- 4 Press and hold **[Shutter]** to start shooting.

- 5 With **[Shutter]** pressed, slowly move the camera in the direction you selected.

- In 3D Panorama mode, you can capture a scene only in horizontal directions.
- An arrow toward the direction of motion is displayed, and the entire shooting image is displayed in the preview box.
- When the scenes are aligned, the camera captures the next photo automatically.

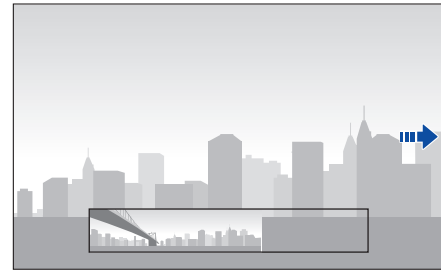

- 6 When you are finished, release **[Shutter]**.

- The camera will automatically save the shots into one photo.
- If you release **[Shutter]** while shooting, the panoramic shooting stops and photos that have been captured are saved.



- The resolution varies depending on the panoramic photo you captured.
- In Panorama mode, some shooting options are not available.
- The camera may stop shooting due to the shooting composition or the subject's movement.
- In Panorama mode, your camera may not capture the entire last scene if you stop moving the camera to improve the photo quality. To capture the entire scene, move your camera slightly beyond the point where you want the scene to end.
- In 3D Panorama mode, your camera may not capture the very beginning or end of a scene due to the nature of the 3D effect. To capture the entire scene, move slightly beyond the beginning and end points you want to capture.
- Photos captured with the 3D function are saved in JPEG (2D) and MPO (3D) formats. On your camera's display, you can view only JPEG files.
- To view 3D files, connect your camera to a 3D TV or 3D monitor with an optional HDMI cable. While viewing, wear proper 3D glasses.
- Capturing photos in 3D Panorama mode may result in a less pronounced 3D effect than those captured with a 3D lens. To increase the 3D effect, attach the optional 3D lens and use 3D mode. (p. 69)





- For best results when capturing panoramic photos, avoid the following:
 - moving the camera too quickly or too slowly
 - moving the camera too little to capture the next image
 - moving the camera at irregular speeds
 - shaking the camera
 - shooting in dark places
 - capturing moving subjects nearby
 - shooting conditions where the brightness or color of light is changing
- Photos taken are automatically saved, and shooting is stopped under the following conditions:
 - if you change the shooting direction while shooting
 - if you move the camera too rapidly
 - if you don't move the camera

Recording a video

In Shooting mode, you can record Full HD videos (1920X1080) by pressing  (Video recording). The camera lets you record a video up to 29 minutes and 59 seconds in length at 60, 30, 24, or 15 fps, and saves the files in MP4 (H.264) format. 60 fps is available only with 1920X1080 and 1280X720 and 24 fps is available only with 1920X810. 15 fps is available only with some Smart Filter options. The sound is recorded via the camera's microphone.

You can set the exposure by adjusting the aperture value and shutter speed for the mode you selected. When you use a lens that does not have an AF/MF switch while recording a video, press [**AF**] to deactivate or activate the AF function. When you use the lens that has an AF/MF switch, the AF function works according to the switch's setting.

Select **Fader** to fade in or out a scene. You can also select **Voice**, **Wind Cut**, or other options to set recording options. (p. 106)

- 1 Rotate the mode dial to **AUTO**, **P**, **A**, **S**, **M**, , or .
 - This feature may not work in some modes.
- 2 Set the desired options.
 - 3 Press  (Video recording) to start recording.
 - 4 Press  (Video recording) again to stop.



- H.264 (MPEG-4 part10/AVC) is the latest video coding format established in 2003 collaboratively by ISO-IEC and ITU-T. Since this format uses a high compression rate, more data can be saved in less memory space.
- If you have the image stabilizer option on when shooting a movie, the camera may record the image stabilizer sound.
- The zoom sound or other lens sounds may be recorded if you adjust the lens while recording a video.
- When using an optional video lens, the autofocus noise is not recorded.
- If you remove the camera lens while recording a movie, the recording will be interrupted. Do not change the lens while recording.
- If you attach an external microphone while recording a movie, sound will not be recorded through the external microphone. (The previous settings are maintained.) If you remove the external microphone while recording a movie, sound will not be recorded. Turn off the camera before attaching or removing the external microphone.

- If you change the shooting angle of the camera suddenly while shooting a movie, the camera may not be able to record images accurately. Use a tripod to minimize camera shake.
- The camera supports only the Multi AF function when recording a video. You cannot use any other focus area setting functions, such as Face Detection AF.
- When the size of a movie file exceeds 4 GB, the camera automatically stops recording even if the maximum recording time (29 minutes and 59 seconds) has not been reached.
- If you use a slow writing memory card, the recording of your movie can be interrupted because the card cannot process data at the rate the video is being shot. If this occurs, replace the card with a faster memory card or reduce the video size (for example, from 1280X720 to 640X480).
- When formatting a memory card, always format using the camera. If you format on another camera or a PC, you can lose files on the card or cause a change in the capacity of the card.
- When you press the video recording button, **Zoom** turns off.
- While recording a video in the same ISO sensitivity, the screen may be darker than taking a photo. Adjust the ISO sensitivity.
- When you record a video in **P**, **A**, or **S** mode, ISO is automatically set to **Auto**.

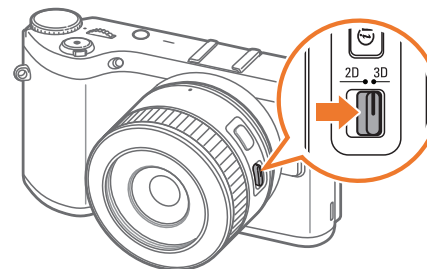

3D mode

You can capture 3D photos or videos with an optional 3D lens.





SAMSUNG 45 mm F1.8 [T6] 2D/3D lens (example)

Set the 2D/3D switch on the lens to **3D**, and then capture a photo or video 1.5-5 m away from the subject.

- 3D mode is always on, regardless of the mode dial of the camera, except **Wi-Fi**.
- To use auto 3D options that enable the camera to set shooting options automatically depending on shooting conditions in 3D mode, press **[MENU]** →  → **3D Auto Mode** → **On**.
- To change the 3D recording option, press **[MENU]** →  → **3D REC Mode** → a desired option.

* Default

Icon	Description
	Side by Side* : Displays two images next to each other.
	Frame Packing : Displays the images for the left and right eye alternately in frames.



- Available shooting options differ compared to other shooting modes.
- You can select either 4.1M (2688X1512) or 2.1M (1920X1080) photo size.
- The video resolution is set to 1920X1080.
- Videos recorded in 3D may be dark or playback may be jittery.
- Shooting in low temperatures may result in color distortion in images and may consume more battery power.
- You may not be able to shoot properly in conditions below 8.5 LV/900 lux. For best results, capture photos in places with sufficient light.
- When you photograph objects that contain polarizing material, such as a display, sunglasses, or a polarizing filter, or use the polarizing material with your lens, the images may appear dark or the 3D effect may not be applied properly.
- Use a tripod to prevent your camera from shaking.
- If you rotate or tilt the camera vertically while shooting, the 3D effect may not be applied properly. Capture images with the camera in the normal position.
- If you shoot in fluorescent lighting or capture images displayed by projectors or TVs, the images may appear black due to the flicker effect.
- In 3D mode, the Enlarge x8 option of MF Assist may not be available.
- The camera's display shows 3D videos only in 2D.
- Photos captured with the 3D function are saved in JPEG (2D) and MPO (3D) formats. On your camera's display, you can view only JPEG files.
- To view 3D files, connect your camera to a 3D TV or 3D monitor with an optional HDMI cable. While viewing, wear proper 3D glasses.

Available functions by shooting mode

For details about shooting functions, see Chapter 2.

Press a shortcut for each function.

Function	Available in	Shortcut
Photo Size (p. 73)	P/A/S/M/ <i>i</i> / S */ AUTO /3D*	-
Quality (p. 74)	P/A/S/M/ <i>i</i> / S *	-
ISO (p. 75)	P/A/S/M	Fn/ISO
White Balance (p. 76)	P/A/S/M/3D*	Fn
Picture Wizard (p. 79)	P/A/S/M/3D	Fn
Smart Filter (p. 101)	P/A/S/M	Fn
AF Mode (p. 80)	P/A/S/M/ <i>i</i> */ S */3D*	Fn
AF Area (p. 83)	P/A/S/M/ <i>i</i> */ S *	Fn/AF
Touch AF (p. 86)	P/A/S/M/ <i>i</i> / S */ AUTO /3D*	-
MF Assist (p. 88)	P/A/S/M/ <i>i</i> / S / AUTO /3D*	-
Focus Peaking (p. 88)	P/A/S/M/ <i>i</i> / S / AUTO	-
Link AE to AF Point (p. 99)	P/A/S/M	-

Function	Available in	Shortcut
Framing Mode (p. 59)	P/A/S/M	-
OIS (Anti-Shake) (p. 89)	P/A/S/M/ <i>i</i> / S */ AUTO *	-
Drive (Continuous/Burst/Timer/Bracketing) (p. 90)	P/A/S/M/ <i>i</i> */ S */ AUTO */3D*	Fn/
Metering (p. 97)	P/A/S/M	Fn
Dynamic Range (p. 100)	P/A/S/M	-
Flash (p. 94)	P*/A*/S*/M*/ <i>i</i> */ S */ AUTO *	Fn
Exposure compensation (p. 102)	P/A/S	Fn/
Exposure lock (p. 103)	P/A/S	-

* Some functions are limited in these modes.

Chapter 2

Shooting Functions

Learn about the functions you can set in Shooting mode.
You can enjoy more customized photos and videos by using the shooting functions.

Size and Resolution













Photo size

As you increase the resolution, your photo or video will include more pixels, so it can be printed on larger paper or displayed on a larger screen. When you use a high resolution, the file size will also increase. Select a low resolution for photos that will be displayed in a digital picture frame or uploaded to the web.



To set the size,

In Shooting mode, press **[MENU]** →  → **Photo Size** → an option.

Icon	Size	Recommended for
	5472x3648 (3:2)	Printing on A1 paper.
	3888x2592 (3:2)	Printing on A2 paper.
	2976x1984 (3:2)	Printing on A3 paper.
	1728x1152 (3:2)	Printing on A5 paper.
	5472x3080 (16:9)	Printing on A1 paper or viewing on an HDTV.
	3712x2088 (16:9)	Printing on A3 paper or viewing on an HDTV.
	2944x1656 (16:9)	Printing on A4 paper or viewing on an HDTV.
	1920x1080 (16:9)	Printing on A5 paper or viewing on an HDTV.
	3648x3648 (1:1)	Printing a square photo on A1 paper.
	2640x2640 (1:1)	Printing a square photo on A3 paper.
	2000x2000 (1:1)	Printing a square photo on A4 paper.
	1024x1024 (1:1)	Printing a square photo on A5 paper.



Available options may differ depending on shooting conditions.

Quality

The camera saves photos in either the JPEG or RAW format.

Photos captured by a camera are often transformed to the JPEG format and stored in the memory according to the settings of the camera at the time of shooting. RAW files are not transformed to the JPEG format and are stored in the memory without any changes.





RAW files have the file extension “SRW”. To adjust and calibrate exposures, White Balances, tones, contrasts, and colors of the RAW files, or to convert them into JPEG or TIFF format, use the Adobe Photoshop Lightroom program found on the supplied DVD-ROM.

Ensure you have enough space on the memory card to save photos in the RAW format.

To set the quality,

In Shooting mode, press [MENU] →  → **Quality** → an option.

Icon	Format	Description
	JPEG	Super Fine: <ul style="list-style-type: none"> Compressed for the best quality. Recommended for printing in large size.
	JPEG	Fine: <ul style="list-style-type: none"> Compressed for better quality. Recommended for printing in normal size.

Icon	Format	Description
	JPEG	Normal: <ul style="list-style-type: none"> Compressed for normal quality. Recommended for printing in small size or uploading to the web.
	RAW	RAW: <ul style="list-style-type: none"> Save a photo without data loss. Recommended for editing after shooting.
	RAW+JPEG	RAW + S.Fine: Save a photo in both the JPEG (S.Fine quality) and RAW format.
	RAW+JPEG	RAW + Fine: Save a photo in both the JPEG (Fine quality) and RAW format.
	RAW+JPEG	RAW + Normal: Save a photo in both the JPEG (Normal quality) and RAW format.



Available options may differ depending on shooting conditions.

ISO sensitivity

The ISO sensitivity value represents the sensitivity of camera to light.

The larger the ISO value, the more sensitive the camera is to light. Consequently, by selecting a higher ISO sensitivity value, you can capture photos in dim or dark places at faster shutter speeds. However, this may increase electronic noise and result in a grainy photo.

To set ISO sensitivity,

In Shooting mode, press [ISO] → an option.

Examples

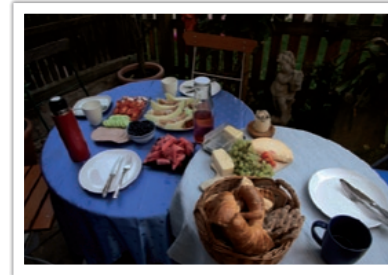

ISO 100



ISO 400



ISO 800



ISO 3200



- You can also set the option by pressing [MENU] →  → ISO → an option in Shooting mode.
- Increase the ISO value in places where flash use is prohibited. You can capture a clear photo by setting a high ISO value without having to secure more light.
- Use the Noise Reduction function in order to reduce the visual noise that can appear on photos of a high ISO value. (p. 146)
- Available options may differ depending on the shooting conditions.

White Balance



White Balance represents the light source that influences on the color of a photo.







The color of a photo depends on the type and quality of the light source. If you want the color of your photo to be realistic, select an appropriate lighting condition to calibrate the White Balance, such as **Auto WB**, **Daylight**, **Cloudy**, **Tungsten**, or adjust color temperature manually.

You can also adjust color for the preset light sources so that the colors of the photo match the actual scene under mixed lighting conditions.

To set the White Balance,

In Shooting mode, press [MENU] →  → **White Balance** → an option.

Icon	Description
	Auto WB: Use automatic settings depending on the lighting conditions.
	Daylight: Select when taking outdoor photos on a sunny day. This option results in photos closest to the natural colors of the scene.
	Cloudy: Select when taking outdoor photos on a cloudy day or in shadows. Photos captured on cloudy days tend to be more bluish than on sunny days. This option offsets that effect.

Icon	Description
	Fluorescent White: Select when shooting under a daylight fluorescent lamp. Especially for white fluorescent light with a color temperature of about 4,200K.
	Fluorescent NW: Select when shooting under a daylight fluorescent lamp. Especially for white fluorescent light of very white hues with a temperature of about 5,000K.
	Fluorescent Daylight: Select when shooting under a daylight fluorescent lamp. Especially for white fluorescent light of slightly bluish hue with a temperature of about 6,500K.
	Tungsten: Select when taking indoor photos under incandescent bulbs or halogen lamps. Incandescent tungsten bulbs tend to have a reddish hue. This option offsets that effect.
	Flash WB: Select when using a flash.
	Custom Set: Use your pre-defined settings. You can manually set the White Balance by pressing [DISP], and then shooting a white sheet of paper. Fill the spot metering circle with the paper and set the White Balance.

Icon	Description
K	<p>Color Temperature: Manually adjust the color temperature of the light source. Color temperature is a measurement in degrees Kelvin that indicates the specific type of light source. As the color temperature increases, the color distribution becomes cooler. Alternatively, as the color temperature decreases, the color distribution becomes warmer. Press [DISP], and then adjust the color temperature.</p> <p>10,000 K — Clear sky</p> <p>8,000 K — Fluorescent H</p> <p>6,000 K — Cloudy</p> <p>5,000 K — Daylight</p> <p>4,000 K — Fluorescent L</p> <p>3,000 K — Halogen lamp</p> <p>2,000 K — Tungsten</p> <p>2,000 K — Candle light</p>

Customizing preset White Balance options

You can also customize preset White Balance options.

To customize preset options, In Shooting mode, press **[MENU]** → → **White Balance** → an option → **[DISP]** → scroll the jog dial, or press **[DISP/ISO/⏏/AF]**.

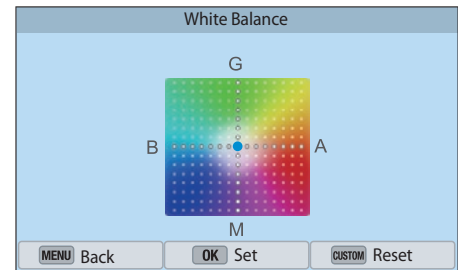

You can also touch an area on the screen.

Available options may differ depending on shooting conditions.

Examples



Auto WB



Daylight

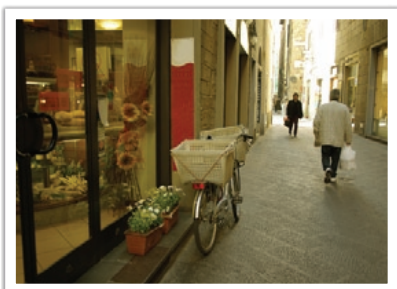

Fluorescent Daylight

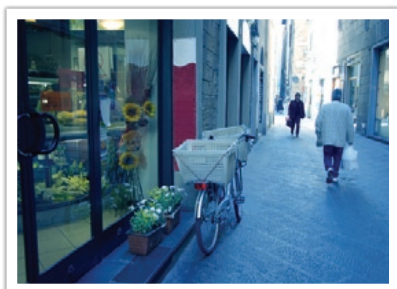

Tungsten



Picture Wizard (photo styles)

Picture Wizard lets you apply different photo styles to your photo to create various looks and emotional moods. You can also create and save your own photo styles by adjusting color, saturation, sharpness, and contrast for each style.

There is no rule for which style is suitable in which conditions. Experiment with different styles and find your own settings.

To set a photo style,

In Shooting mode, press **[MENU]** →  → **Picture Wizard** → an option.

Examples



Standard

Vivid

Portrait



Landscape

Forest

Retro





Cool

Calm

Classic



- You can also adjust the value of the preset style settings. Select a Picture Wizard option, press **[DISP]**, and then adjust color, saturation, sharpness, or contrast.
- To customize your own picture wizard, select , , or , and then adjust the color, saturation, sharpness, and contrast.
- Picture Wizard options cannot be set with Smart Filter options at the same time.

AF mode

Learn how to adjust the camera's focus according to the subjects.

You can select a focusing mode appropriate to the subject among Single Auto Focus, Continuous Auto Focus, and Manual Focus. The AF function is activated when you press **[Shutter]** halfway. In the MF mode, you have to rotate the focus ring on the lens to focus manually.

In most cases, you can have a focus by selecting **Single AF**. Fast moving subjects or subjects of a color similar to the background are difficult to focus. Select an appropriate focusing mode for such instances.

If your lens has an AF/MF switch, you must set the switch according to the selected mode. Set the switch to AF when you select Single AF or Continuous AF. Set the switch to MF when you select Manual Focus.

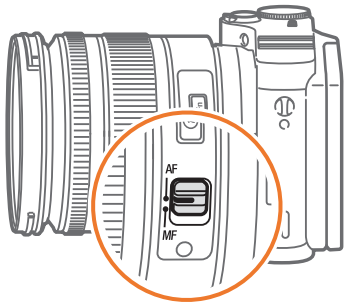

When your lens has no AF/MF switch, press **[AF]** to select a desired AF mode.

To set the auto focus mode,

In Shooting mode, press **[AF]** → an option.



- You can also set the option by pressing **[MENU]** →  → **AF Mode** → an option in Shooting mode.
- The available options may differ depending on the lens in use.

Single AF

Single AF is appropriate for shooting a still subject. When you press **[Shutter]** halfway, the focus fixes in the focus area. The area turns green when the focus is achieved.



Continuous AF

While you are pressing **[Shutter]** halfway, the camera continues to automatic focusing. Once the focus area is fixed on the subject, the subject is always in focus even when moving. This mode is recommended for shooting a person on a bicycle, a running dog, or a car racing scene.



Manual focus

You can manually focus on a subject by rotating the focus ring on the lens. The MF Assist function lets you easily achieve a focus. While you are rotating the focus ring, the focus area is magnified. When you use the Focus Peaking function, the color you selected appears on the focused subject. This mode is recommended for shooting an object similar in color to the background, a night scene, or fireworks.

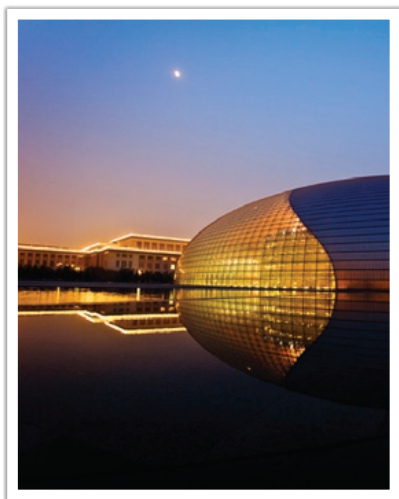

If you use this function, you cannot set Touch AF, AF Area, and Link AE to AF Point options.



AF area

The AF area function changes the positions of the focus area.

Generally, cameras focus on the nearest subject. When there are a lot of subjects, however, unwanted subjects can be in focus. In order to prevent unwanted subjects from being in focus, change the focus area so that a desired subject is in focus. You can get a clearer and sharper photo by selecting an appropriate focus area.

To set the auto focus area,

In Shooting mode, press [MENU] →  → **AF Area** → an option.



- Available options may differ depending on shooting conditions.
- When the AF/MF switch is set to MF, you cannot change the AF area from the shooting menu.
- When you use the Face Detection AF option, the camera focuses on the area with the white frame automatically.
- Depending on the Picture Wizard options, Face Detection may not be effective.
- When you set manual focus, Face Detection may not be available.
- Face Detection may not be effective when:
 - the subject is far from the camera
 - it is too bright or too dark
 - the subject is not facing the camera
 - the subject is wearing sunglasses or a mask
 - the subject's facial expression changes drastically
 - the subject is backlit or the lighting conditions are unstable

Selection AF

You can set the focus on an area you want. Apply an out-of-focus effect to make the subject more distinguishable.

The focus on the photo below was repositioned and resized so that it fits the subject's face.

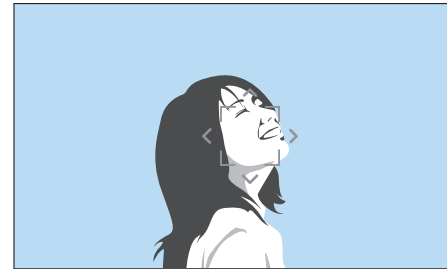

To resize or move the focus area, in Shooting mode, press [⏏]. Use the navigation button to move the focus area. Scroll the jog dial to resize the focus area.

Multi AF

The camera displays a green rectangle in places where focus is set correctly. The photo is divided into two or more areas, and the camera obtains focus points of each area. It is recommended for scenery photos.

When you press [**Shutter**] halfway, the camera displays the focus areas as shown in the photo below.



Face detection AF

The camera focuses on human faces preferentially. Faces of up to 10 people can be detected. This setting is recommended for shooting a group of people.

When you press [**Shutter**] halfway, the camera focuses on faces as shown in the photo below. In cases of shooting a group of people, the camera displays the focus on the nearest person's face in white and the rest of the people's faces in gray.

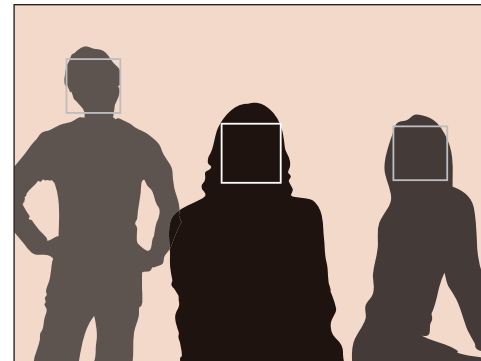

Self-Portrait AF

It can be difficult to check whether your face is in focus when you are taking a self-portrait. When this function is on, the beep from the camera gets faster when your face is located at the center of the composition.

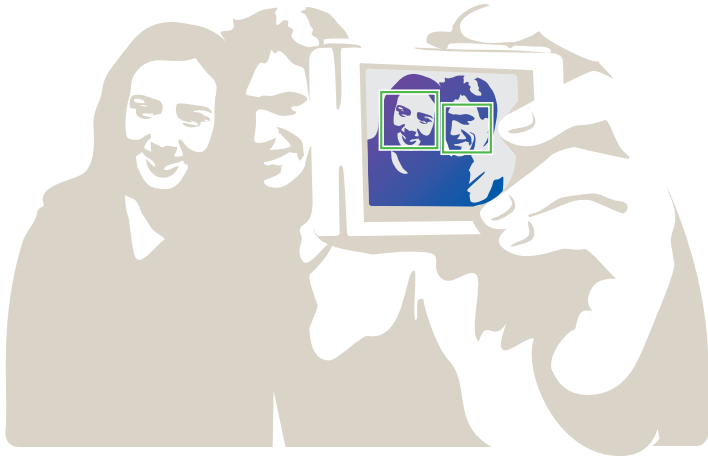

Touch AF

Focus on the subject or capture a photo by touching on the screen.

To set Touch AF,

In Shooting mode, press [MENU] →  → **Touch AF** → an option.



Available options may differ depending on the shooting conditions.

Touch AF

Touch AF allows you to focus on the subject that you touch on the screen.

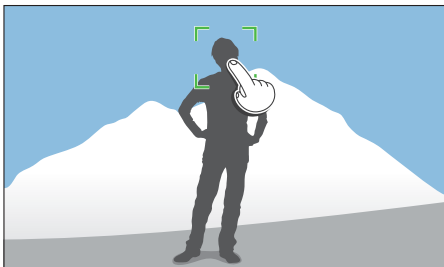

Tracking AF

Tracking AF allows you to track and automatically focus on your subject, even when the subject is moving or when you change the shooting composition.

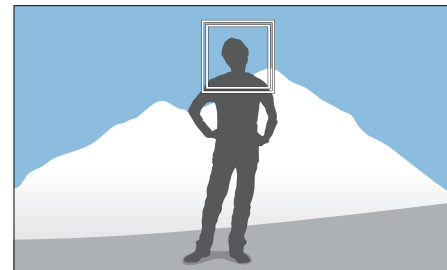

White frame: Your camera is tracking the subject.

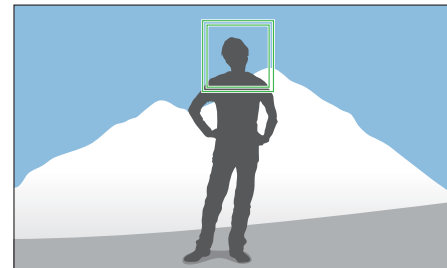

Green frame: Your subject is in focus when you half-press [Shutter].

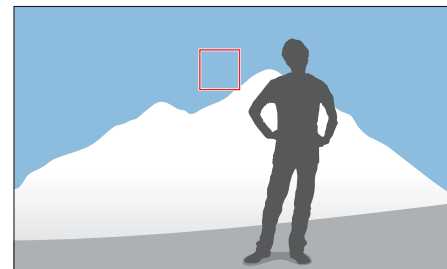

Red frame: Your camera failed to focus.



- If you do not select a focus area, the Auto Focus function does not work.
- Tracking a subject may fail when:
 - the subject is too small
 - the subject moves excessively
 - the subject is backlit or you are shooting in a dark place
 - colors or patterns on the subject and the background are the same
 - the subject includes horizontal patterns, such as blinds
 - the camera shakes excessively
- When tracking fails, the feature will be reset.
- If the camera fails to track the subject, the focus area will be reset.
- If the camera fails to focus, the focus frame will change to red and the focus will be reset.

One touch shot

You can capture a photo with the touch of your finger. As you touch on a subject, the camera focuses on the subject automatically and captures a photo.

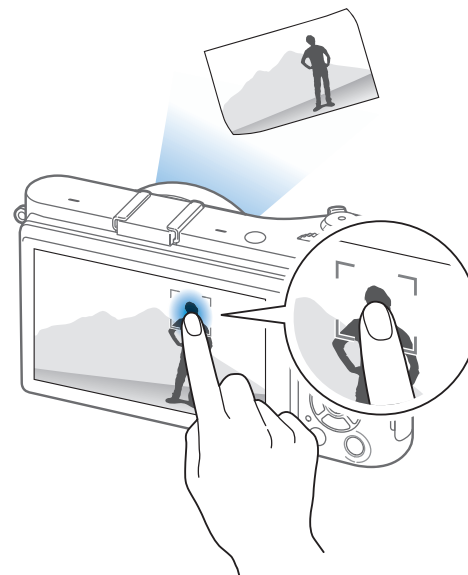

Focus assist

In the manual focus mode, you have to rotate the focus ring on the lens to focus. When you use the MF Assist function or the Focus Peaking function, you can achieve a clearer focus. This function is only available on a lens that supports manual focus.

MF Assist

In the manual focus mode, you can enlarge the scene and easily adjust the focus while rotating the focus ring.

To set the manual focus assist,

In Shooting mode, press [MENU] →  → **MF Assist** → an option.

Option	Description
Off	Do not use the MF Assist function.
Enlarge x5*	The focus area is magnified by 5 times when you rotate the focus ring. 

* Default

Option	Description
Enlarge x8	The focus area is magnified by 8 times when you rotate the focus ring. 

* Default

Focus Peaking

In the manual focus mode, the color you selected appears on the focused subject to help you focus while rotating the focus ring.

To set Focus Peaking options,

In Shooting mode, press [MENU] →  → **Focus Peaking** → an option.

Option	Description
Level	Set a sensitivity for detecting the focused subject. (Off, High, Normal* , Low)
Color	Set a color to appear on the focused subject. (White* , Red, Green)

* Default

Optical Image Stabilization (OIS)

Use the Optical Image Stabilization (OIS) function to minimize camera shake. OIS may not be available with some lenses.



Camera shake tends to occur in dark places or when shooting indoors. In such cases, the camera uses slower shutter speeds in order to increase the amount of light taken in, which can result in a blurry photo. You can prevent this situation by using the OIS function.

If your lens has an OIS switch, you have set the switch to **ON** to use the OIS function.

To set OIS options,

In Shooting mode, press [MENU] →  → **OIS (Anti-Shake)** → an option.

* Default

Icon	Description
	Off: The OIS function is off. (This option may not be available with some lenses.)
	Mode 1*: The OIS function is applied only when you press [Shutter] in full or half.
	Mode 2: The OIS function is on.

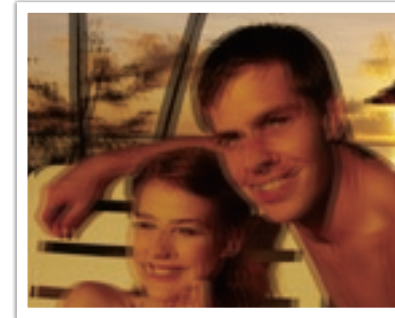

Without OIS correction

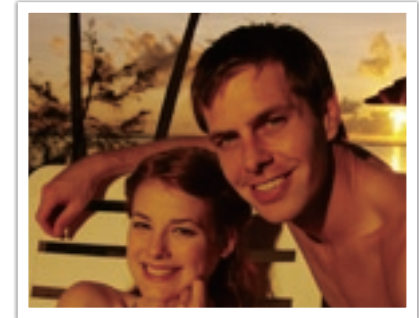

With OIS correction



- OIS may not function properly when:
 - you move your camera to follow a moving subject
 - there is too much camera shake
 - the shutter speed is slow (for example, when you select **Night** in  mode)
 - the battery is low
 - you capture a close-up shot
- If you use the OIS function with a tripod, your images may be blurred by the vibration of the OIS sensor. Deactivate the OIS function when you use a tripod.
- If the camera is hit or dropped, the display will be blurry. If this occurs, turn off the camera, and then turn it on again.
- Use the OIS function only when needed because the function consumes more battery power.
- To set an OIS option on the menu, set the OIS switch on your lens to **ON**.
- This option may not be available with some lenses.
- **Off** may not be available with some lenses.

Drive (shooting method)

You can set the shooting method such as Continuous, Burst, Timer and so on.

Select **Single** to capture one photo at a time. Select **Continuous** or **Burst** to shoot fast moving subjects. Select **AE Bracket**, **WB Bracket**, or **P Wiz Bracket** to adjust exposure, White Balance, or apply Picture Wizard effects. You can also select **Timer** to capture a photo of yourself.

To set the shooting method,

In Shooting mode, press [Q] → an option.



- You can also set the option by pressing [MENU] → [Camera icon] → **Drive** → an option in Shooting mode.
- Available options may differ depending on shooting conditions.

Single

Capture one photo whenever you press [**Shutter**]. Recommended for general conditions.

Continuous

Continuously capture photos while you are pressing [**Shutter**]. You can capture up to 5 photos (**Continuous Normal**) or 8.6 photos (**Continuous High**) per second.



If you select **Continuous High**, the noise reduction function is not available.

Burst

Consecutively capture up to 10 shots per second (3 seconds), 15 shots per second (2 seconds), or 30 shots per second (1 second) when you press **[Shutter]** once. It is recommended for shooting the rapid motion of fast moving subjects such as racing cars.



- To set the number of shots, in Shooting mode, press [MENU] → **Burst**, and then press **[DISP]**.
- The photo size is set to 5M.
- It may take longer to save a photo.
- You cannot use the flash with this option.
- Shutter speed must be faster than 1/30 second.
- Photos captured with this option may be slightly enlarged when saving.
- You cannot set an ISO option higher than ISO 3200.
- This option cannot be used with the RAW file format and is not available when the photo quality is set to RAW.

Timer

Capture a photo with a delay of 2 to 30 seconds. The delay is adjustable in increments of 1 second.

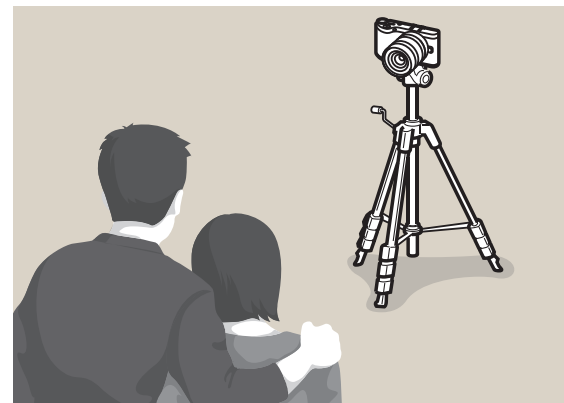

- To set the delay, in Shooting mode, press [MENU] → **Timer**, and then press **[DISP]**.

Auto Exposure Bracketing (AE Bracket)

When you press [**Shutter**], the camera captures 3 consecutive photos: the original, one a step darker, and one a step lighter. Use a tripod to prevent blurry photos as the camera captures three photos continuously. You can adjust the settings in **Bracket Set** menu.



White Balance Bracketing (WB Bracket)

When you press [**Shutter**], the camera captures 3 consecutive photos: the original and two more with different White Balance settings. The original photo is captured when you press [**Shutter**]. The other two are automatically adjusted according to the White Balance you have set. You can adjust the settings in **Bracket Set** menu.



This option cannot be used with the RAW file format and is not available when the photo quality is set to RAW.

Picture Wizard Bracketing (P Wiz Bracket)

When you press **[Shutter]**, the camera captures three consecutive photos, each with a different Picture Wizard setting. The camera captures a photo and applies the three Picture Wizard options you have set to the image captured. You can select three different settings in **Bracket Set** menu.



This option cannot be used with the RAW file format and is not available when the photo quality is set to RAW.

Bracketing setting

You can set up the options for AE Bracket, WB Bracket, and P Wiz Bracket. (p. 147)

To set a bracketing option,







In Shooting mode, press **[MENU]** →  → **Bracket Set** → an option.



Flash

In order to capture a realistic photo of a subject, the amount of light should be constant. When the light source varies, you can use a flash and supply a constant amount of light. Select appropriate settings according to a light source and a subject.

To set flash options,

In Shooting mode, press [MENU] →  → **Flash** → an option.

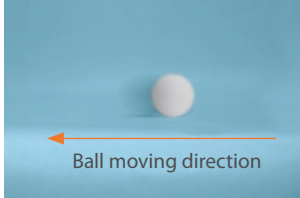
Icon	Description
	Off: Do not use the flash.
	Smart Flash: The camera automatically adjusts the brightness of the flash according to the amount of light in the surrounding environment.
	Auto: The flash automatically fires in dark places.
	Auto Red-eye: The flash automatically fires and reduces red-eyes.
	Fill in: The flash fires whenever you capture a photo. (Brightness is automatically adjusted.)
	Fill-in Red: The flash fires whenever you capture a photo and reduces red-eyes.

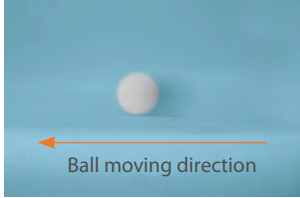
Icon	Description
	<p>1st Curtain: The flash fires immediately after the shutter opens. The camera captures a photo of a subject earlier in an action sequence clearly.</p> 
	<p>2nd Curtain: The flash fires just before the shutter closes. The camera captures a photo of a subject later in an action sequence clearly.</p> 



- The available options may differ depending on shooting conditions.
- There is an interval between two bursts of the flash. Do not move until the flash fires a second time.
- If you select **Off**, the flash does not fire even when an external flash is attached.



Use only Samsung-approved flashes. Using incompatible flashes may damage your camera.

Reducing the red-eye effect

If the flash fires when you capture a photo of a person in the dark, a red glow may appear in the eyes. To reduce the red-eye effect, select **Auto Red-eye** or **Fill-in Red**.



Without red-eye reduction



With red-eye reduction



If the subject is too far from the camera or moves when the first flash fires, red-eyes may not be reduced.

Adjusting the flash intensity

When the flash is on, adjust the flash intensity +/-2 levels.

To set the flash intensity,

In Shooting mode, press [Fn] → **Flash** → an option → [DISP] → scroll the jog dial or press [Z]/[AF] to adjust the flash intensity.

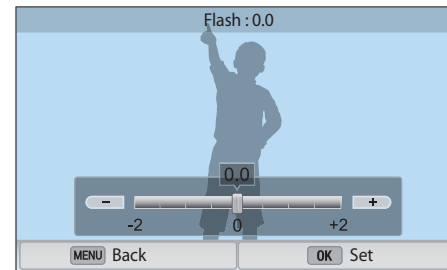



- You can also drag the slider or touch +/- to adjust the intensity.
- Adjusting the flash intensity may not be effective when:
 - the subject is too close to the camera
 - you set a high ISO sensitivity
 - the exposure value is too big or too small
- In some shooting modes, you cannot use this function.
- If you attach an intensity-adjustable external flash to the camera, the intensity settings of the flash will be applied.
- If the subject is too close when you use the flash, some light may be blocked, resulting in a dark photo. Ensure that the subject is within the recommended range, which varies by lens.
- When a lens hood is attached, the light from the flash can be blocked by the hood. Remove the hood to use the flash.



Metering

The metering mode refers to the way in which a camera measures the quantity of light.

The camera measures the amount of light in a scene, and in many of its modes, uses the measurement to adjust various settings. For example, if a subject looks darker than its actual color, the camera captures an overexposed photo of it. If a subject looks lighter than its actual color, the camera captures an underexposed photo of it.

The brightness and overall mood of the photo can also be affected by how the camera measures the amount of light. Select an appropriate setting for a shooting condition.

To set a metering option,

In Shooting mode, press [MENU] →  → **Metering** → an option.

Multi

The Multi mode calculates the amount of light in multiple areas. When light is sufficient or insufficient, the camera adjusts the exposure by averaging the overall brightness of the scene. This mode is suitable for general photos.



Spot

The Spot mode calculates the amount of light in the center. When you capture a photo in conditions where there is a strong backlight behind a subject, the camera adjusts the exposure so as to shoot a subject correctly. For example, when you select the Multi mode in a strong backlight condition, the camera calculates that the overall amount of light is abundant, which results in a darker photo. The Spot mode can prevent this situation as it calculates the amount of light in a designated area.

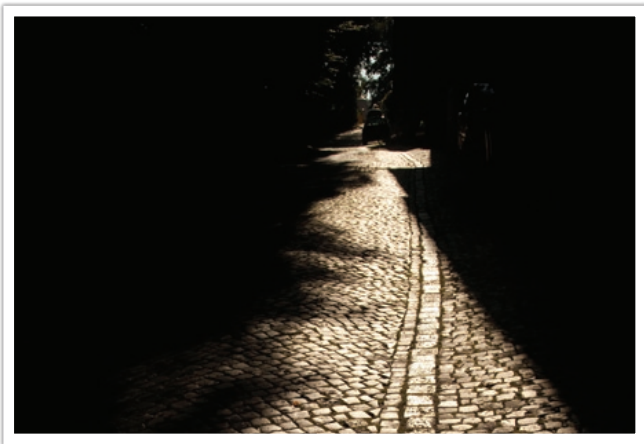

The subject is in bright color while the background is dark. The Spot mode is recommended for a situation like this where a huge difference in the exposure exists between a subject and a background.

Center-weighted

The Center-weighted mode calculates a broader area than the Spot mode does. It sums up the amount of light in the center portion of the shot (60–80 %) and that of the rest of the shot (20–40 %). It is recommended for situations where there is a slight difference in brightness between a subject and a background or an area of the subject is large compared to the overall composition of the photo.



Measuring the exposure value of the focus area

When this function is turned on, the camera automatically sets an optimal exposure by calculating the brightness of the focus area.

This function is only available when you select **Spot** metering or **Multi** metering, and **Selection AF**.

To set this
function,

In Shooting mode, press [MENU] →  → **Link AE to AF Point** → an option.



Dynamic Range

This function automatically corrects the loss of bright detail that can occur due to shading differences in the photo.

To set **Smart Range** options,



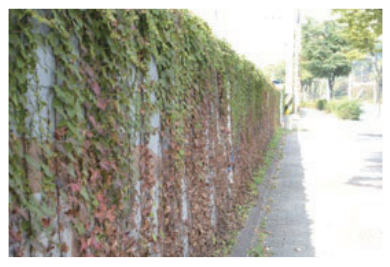

In Shooting mode, press **[MENU]** →  → **Dynamic Range** → an option.



Without Dynamic Range effect



With Dynamic Range effect

Icon	Description
	Off: Do not use Dynamic Range.
	Smart Range+: Correct the loss of bright detail.  You cannot set ISO 100.
	HDR: Capture 2 photos with different exposures, and then combine them to create a single image automatically.  You cannot set an ISO option higher than ISO 3200.



Smart Filter

Smart Filter lets you apply special effects to your photos. You can select various filter options to create special effects that are difficult to be achieved with normal lenses.

To set Smart Filter options,

In Shooting mode, press [MENU] →  → **Smart Filter** → an option.

Option	Description
Off	No effect
Vignetting	Apply the retro-looking colors, high contrast, and strong vignette effect of Lomo cameras.
Miniature	Apply a tilt-shift effect to make the subject appear in miniature.
Colored Pencil	Apply a colored pencil painting effect.
Watercolor	Apply a watercolor painting effect.
Wash drawing	Apply a washed-out effect.
Oil Sketch	Apply an oil painting effect.
Ink Sketch	Apply an ink painting effect.
Acryl	Apply an acryl painting effect.

Option	Description
Negative	Apply a negative film effect.
Red	Desaturate all colors but red.
Green	Desaturate all colors but green.
Blue	Desaturate all colors but blue.
Yellow	Desaturate all colors but yellow.



Smart filter options cannot be set with Picture Wizard options at the same time.

Exposure compensation

The camera automatically sets the exposure by measuring the levels of light from the photo's composition and the position of a subject. If the exposure set by the camera is higher or lower than you expected, you can adjust the exposure value manually. The exposure value is adjustable in ± 3 increments. The camera displays the exposure warning in red for each step beyond ± 3 range.

To adjust the exposure value, while holding down [**Fn**], scroll the jog dial. You can also adjust the exposure value by pressing [**Fn**], and then selecting **EV**.

You can check the exposure value by the position of the exposure level indicator.

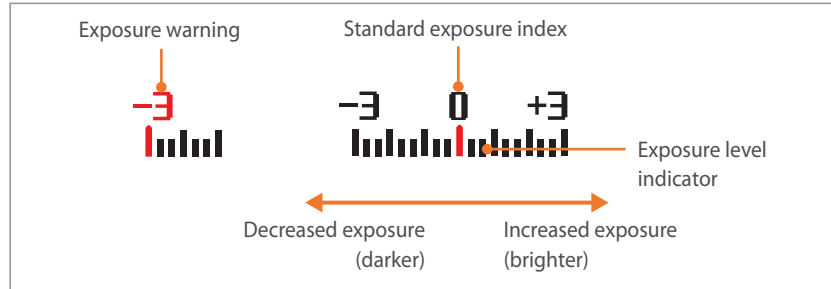

Exposure lock

When you cannot achieve an appropriate exposure because of a strong color contrast, lock the exposure, and then capture a photo.

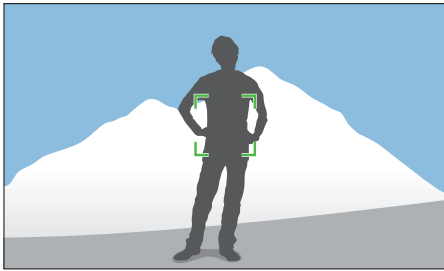

To lock the exposure value, adjust the photo's exposure, and then press the custom button.

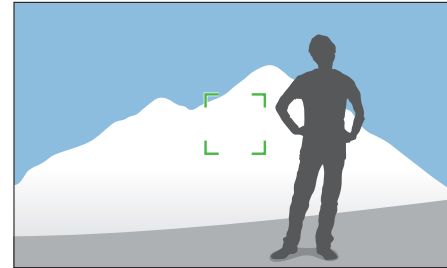

After locking the exposure, aim the lens where you desire, and then press **[Shutter]**.



- Set a function of the custom button to **AEL** to lock the current exposure value. (p. 150)
- This feature is not available in Manual mode.

Video functions









The functions available for video are explained below.

Movie size

Set the movie size.

To set movie size options,

In Shooting mode, press [MENU] →  → **Movie Size** → an option.



Icon	Size	Recommended for
	1920X1080 (60 fps) (16:9)	View on a Full HDTV. (Playable only on full HDTVs capable of playback at 60 fps.)
	1920X1080 (30 fps) (16:9)	View on a Full HDTV.
	1920X1080 (15 fps) (16:9)	View on a Full HDTV. (Available only with some Smart Filter options.)
	1920X810 (24 fps) (Approx. 2.35:1)	View on an HDTV.
	1280X720 (60 fps) (16:9)	View on an HDTV.
	1280X720 (30 fps) (16:9)	View on an HDTV.
	640X480 (30 fps) (4:3)	View on a TV.
	320X240 (30 fps) (4:3)	Post on a website using the wireless network (30 seconds maximum).

Movie quality

Set the Movie quality.

To set movie quality options,

In Shooting mode, press [MENU] →  → **Movie Quality** → an option.







Icon	Extension	Description
	MP4 (H.264)	Normal: Record videos in normal quality.
	MP4 (H.264)	HQ: Record videos in high quality.

Multi Motion

Set the playing speed of a video.

To set playing speed options,

In Shooting mode, press [MENU] →  → **Multi Motion** → an option.

Icon	Description
	x0.25: Record a video and play it at 1/4 normal speed. (Available only with 640x480 or 320x240)
	x0.5: Record a video and play it at 1/2 normal speed. (Available only with 1280x720 (30 fps), 640x480, or 320x240)
	x1: Record a video and play it at normal speed.
	x5: Record a video and play it at 5X normal speed.
	x10: Record a video and play it at 10X normal speed.
	x20: Record a video and play it at 20X normal speed.







- If you select an option other than **x1**, sound will not be recorded.
- The available options may differ depending on shooting conditions.

Fader

You can fade in or fade out a scene using the fader function on the camera without having to do it on a PC. Set the fade in option to gradually fade in at the start of the scene. Set the fade out option to gradually fade out the scene. Use the function appropriately and add dramatic effects on your videos.

To set fader options,

In Shooting mode, press [MENU] →  → **Fader** → an option.

Icon	Description
	Off: Fader function not used.
	In: Scene gradually fades in.
	Out: Scene gradually fades out.
	In-out: The fader function is applied at the start and end of the scene.



When you use the fader function, it may take longer to save a file.

Voice

Sometimes, a muted video is more appealing than the one with sound. Turn the voice off to record a muted video.

To set voice options,

In Shooting mode, press [MENU] →  → **Voice** → an option.

Wind cut

When you record videos in noisy environments, unintended sounds can be recorded in videos. In particular, severe wind noise recorded in videos distracts you from enjoying your videos. Use the Wind Cut function to remove some surrounding noise in addition to wind noise.

To reduce wind sound,

In Shooting mode, press [MENU] →  → **Wind Cut** → an option.





Chapter 3

Playback/Editing

Learn about how to play back and edit photos and videos.
Refer to chapter 6 for editing files on a PC.

Searching and managing files

Learn how to view photo and video thumbnails and how to protect or delete files.



If you perform no operations for a while, information and icons on the screen disappear. When you operate the camera again, they will reappear.

Viewing photos

1 Press [▶].

- The most recent file you captured will be displayed.

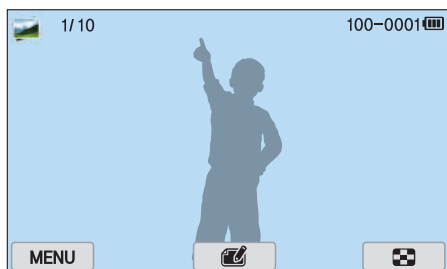

2 Press [🔍]/[AF] to scroll through files.

- You can also drag the image left or right to move to another file.



You may not be able to edit or play back files that were captured with other cameras, due to unsupported sizes or codecs. Use a computer or another device to edit or play back these files.

Viewing image thumbnails

In order to search for photos and videos you want, convert to the thumbnail view. The thumbnail view displays multiple images at a time so that you can easily look through items you wish to find. You can also classify and display files by category, such as date or file type.

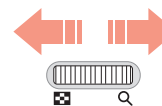
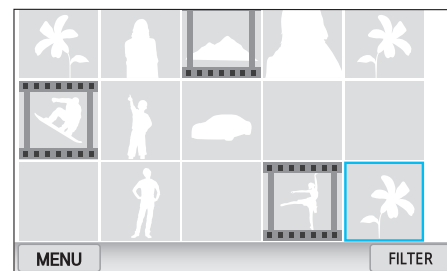

Scroll the jog dial to the left to select the thumbnail view mode.

(Scroll the jog dial to the right to return to the previous mode.)

Viewing files by category

1 In the thumbnail view, press [MENU] →  → **Filter** → a category.

- You can also touch **FILTER** to select a category.

Option	Description	* Default
All*	View files normally.	
Date	View files by the date they were saved.	
Type	View files by the file type.	
Location	View files by the place they were saved. (Only the photos captured with an optional GPS module have the location information.)	

2 Select a list to open it.

3 Select a file to view it.

4 Touch  to return to the previous view.

Viewing files as a folder

Continuous and burst shots appear as a folder. Selecting a folder will play back all photos automatically. Deleting a folder will delete all photos in the folder.

1 In Playback mode, press [/AF] or drag the image left or right to move to a desired folder.

- The camera will automatically play back photos in the folder.

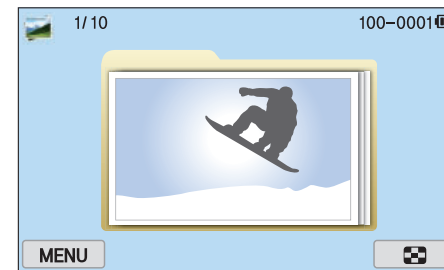

2 Scroll the jog dial to the right to open the folder.



- You can also touch the folder on the screen to open the folder.

3 Press [/AF] or drag the image left or right to move to another file.

4 Scroll the jog dial to the left to return to Playback mode.

Protecting files

Protect your files from accidental deletion.

- 1 In Playback mode, press [MENU] →  → **Protect** → **Select**.
- 2 Press /AF to select a file, and then press .
- 3 Press [Fn].



You cannot delete or rotate a protected file.

Lock/Unlock all files

Lock or unlock all files.

- 1 In Playback mode, press [MENU] →  → **Protect** → **All**.
- 2 Select an option.

Option	Description
Lock	Lock all files.
Unlock	Unlock all files.
Cancel	Return to the previous menu.

Deleting files

Delete files in Playback mode and secure more space on your memory card. Protected files are not deleted.

Deleting a single file

You can select a single file and delete it.

- 1 In Playback mode, select a file, and then press [⏏].
- 2 When the pop-up message appears, select **Yes**.

Deleting multiple files

You can select multiple files and delete them.

- 1 In Playback mode, press [MENU] → [▶] → **Delete** → **Select**.
 - Alternatively, in thumbnails view, press [⏏], and then select files to delete.
- 2 Select files you want to delete by pressing [⏏/AF], and then press [⏏].
 - Press [⏏] again to cancel your selection.
- 3 Press [⏏].
- 4 When the pop-up message appears, select **Yes**.

Deleting all files

You can delete all files on the memory card at once.

- 1 In Playback mode, press [**MENU**].
- 2 Select  → **Delete** → **All**.
- 3 When the pop-up message appears, select **Yes**.



Viewing photos

Enlarging a photo

You can enlarge photos when viewing them in Playback mode. You can also use the Trim function to extract the portion of the image displayed on the screen and save it as a new file.

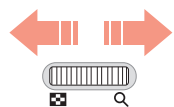
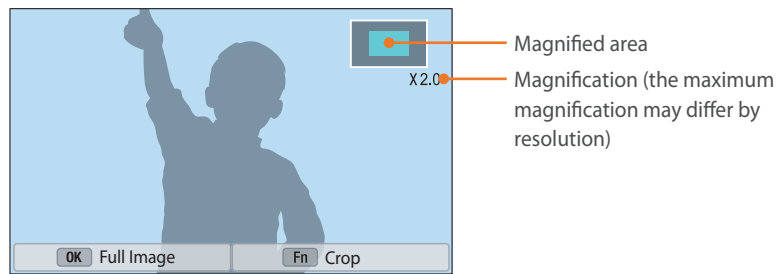

Scroll the jog dial to the right to enlarge a photo.
(Scroll the jog dial to the left to reduce a photo.)

To	Do this
Move magnified area	Press [DISP/ISO/⊞/AF] .
Crop the enlarged image	Press [Fn] . (saved as a new file)
Return to the original image	Press [OK] .



Viewing a slide show

You can view photos in a slide show, apply various effects to the slide show, and play background music.

- 1 In Playback mode, press **[MENU]**.
- 2 Select  → **Slide Show Options**.
- 3 Select a slide show effect option.
 - Skip to step 4 to start a slide show with no effects.

Option	Description
Play Mode	Set whether or not to repeat the slide show. (One Play* , Repeat)
Interval	Set the interval between photos. (1 sec* , 3 sec , 5 sec , 10 sec)
Music	Set background audio.
Effect	<ul style="list-style-type: none"> • Set a scene change effect between photos. • Select Off to cancel effects.

* Default

- 4 Press [**MENU**].
- 5 Select **Start Slide Show**.
- 6 View the slide show.
 - Press [] to pause.
 - Press [] again to resume.
 - Press [**MENU**] to stop the slide show and return to Playback mode.
 - Press [**DISP/ISO**] to adjust the volume level.

Auto rotating

With Auto Rotate on, the camera automatically rotates photos you have captured vertically so they fit the screen horizontally.

To set auto rotate options,



In Playback mode, press [**MENU**] →  → **Auto Rotate** → an option.

Creating a print order (DPOF)

DPOF (Digital Print Order Format) lets you set the print size of a photo and the number of copies to be printed.

The camera saves the DPOF information in the MISC folder of your memory card. If you have set DPOF information for your images, you can take the memory card to a digital printing shop for printing. You cannot set the print order of RAW format files.

Photos with dimensions that are wider than the paper may be cut off on the left and right edges. Ensure that your photo dimensions are compatible with the paper you select.

- 1 In Playback mode, select a photo, and then press [**MENU**].
- 2 Select  → **DPOF**.
- 3 Press [**DISP/ISO**] to set the number of copies.
 - To select another photo, press []/**AF**].
- 4 Press [] to save.

Playing videos

In Playback mode, you can play a video, capture an image from a video, or crop a video to save as another file.

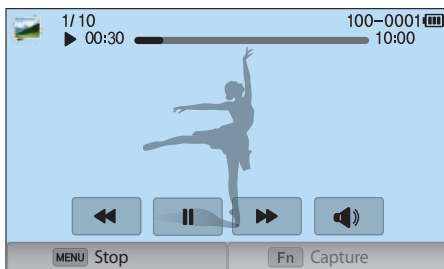

Video viewing controls

Icon/Button	Description
⏮/⏪/[⏮]	View previous file/Scan backward. (Each time you touch the icon or press the button while playing the video, you change the scan speed in this order: 2X, 4X, 8X.)
⏸/▶/[⏸]	Pause or resume playback.
⏭/⏩/[AF]	View next file/Scan forward. (Each time you touch the icon or press the button while playing the video, you change the scan speed in this order: 2X, 4X, 8X.)
🔊/[DISP/ISO]	Adjust the volume or mute the sound.

Trimming a video during playback

- 1 In Playback mode, scroll to a video, and then touch ✂.
- 2 Press [OK] or touch ▶ to start playing the video.
- 3 Press [OK] or touch ⏸ at the point where you want the trimming to begin.
- 4 Press [Fn] or touch **Start Point**.
- 5 Press [OK] or touch ▶ to resume playing the video.
- 6 Press [OK] or touch ⏸ at the point where you want the trimming to end.

7 Press [**Fn**] or touch **End Point**.

8 Press [**Fn**] or touch **Trim** to trim a video.

- You can adjust the scene to be cropped by dragging the handles that appear on the progress bar.

9 When the pop-up message appears, select **Yes**.



- You cannot trim a video recorded in 3D mode.
- The original video should be at least 10 seconds long.
- The camera will save the edited video as a new file and leave the original video intact.

Capturing an image during playback

1 While viewing a video, press [**OK**] or touch **II** at the point where you want to capture an image.

2 Press [**Fn**] or touch **Capture**.



- You cannot capture an image from a video recorded in 3D mode.
- The resolution of the captured image will be the same as the original video.
- The captured image is saved as a new file.

Editing photos

Perform photo editing tasks, such as resizing, rotating, or reducing red-eye effects. Edited photos are saved as new files under different file names. Photos captured in some modes cannot be edited with the Image Edit function.



To edit images,

In Playback mode, scroll to a photo, and then touch  → an option.



- You can also edit images in Playback mode by selecting a photo, and then pressing [Fn] or [MENU] → **Edit Image**.
- Some images may not be edited with the Image Edit function. In this case, use a supplied image editing software.
- The camera will save edited photos as new files.
- When you edit photos, the camera will automatically convert them to a lower resolution. Photos that you rotate or resize manually are not automatically converted to a lower resolution.
- You cannot edit photos while viewing files as a folder. Open the folder and select a photo to edit each photo.

Cropping a photo

- 1 Touch  → .
- 2 Drag the corners of the box to adjust the size of the area.
- 3 Drag the box to move the location of the area.
- 4 Touch **OK**.
- 5 Touch  to save.

Rotating a photo

1 Touch  → .

2 Touch an option.

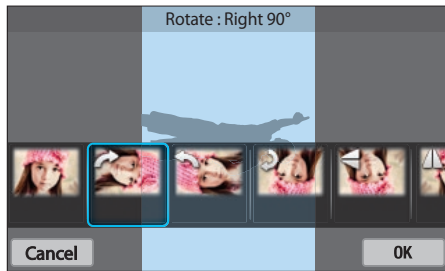

3 Touch **OK**.

4 Touch  to save.



- You can also rotate a photo in Playback mode by pressing [MENU], and then selecting  → **Rotate** → a desired option.
- The camera will overwrite the original file.

Resizing photos

Change the size of a photo and save it as a new file.

1 Touch  → .

2 Touch an option.



3 Touch **OK**.

4 Touch  to save.











Available resize options differ depending on the original size of the photo.

Adjusting your photos

You can correct captured photos by adjusting the brightness, contrast, or saturation.

1 Touch .

2 Touch an adjusting option.

Icon	Description
	Original (Reset to the original image)
	Auto adjustment
	Brightness
	Contrast
	Saturation
	RGB
	Color Temperature
	Exposure
	Hue





3 Press [/AF] to adjust the option.

- You can also drag the slider or touch +/- to adjust the option.





4 Touch **OK**.

5 Touch  to save.

Retouching faces

- 1 Touch  → .
- 2 Press [/AF] to adjust the option.
 - You can also drag the slider or touch +/- to adjust the option.
 - As the number increases, the skin tone becomes brighter and smoother.
- 3 Touch **OK**.
 - To cancel correction, touch .
- 4 Touch  to save.

Reducing red-eye

- 1 Touch  → .
- 2 Touch **OK**.
 - To cancel correction, touch .
- 3 Touch  to save.

Applying Smart Filter effects

Apply special effects to your photos.

- 1 Touch , and then touch an option.

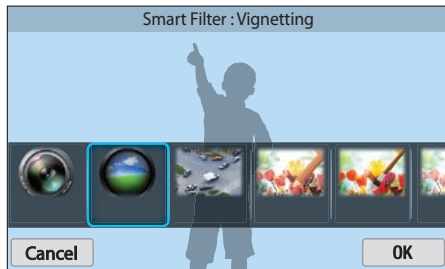

Option	Description
Original	No effect
Vignetting	Apply the retro-looking colors, high contrast, and strong vignette effect of Lomo cameras.
Miniature	Apply a tilt-shift effect to make the subject appear in miniature.
Colored Pencil	Apply a colored pencil painting effect.
Watercolor	Apply a watercolor painting effect.
Wash drawing	Apply a washed-out effect.

Option	Description
Oil Sketch	Apply an oil painting effect.
Ink Sketch	Apply an ink painting effect.
Acryl	Apply an acryl painting effect.
Negative	Apply a negative film effect.
Red	Desaturate all colors but red.
Green	Desaturate all colors but green.
Blue	Desaturate all colors but blue.
Yellow	Desaturate all colors but yellow.

- 2 Touch **OK**.
- 3 Touch  to save.



Chapter 4

Wireless network

Learn how to connect to wireless local area networks (WLANs) and use functions.

Connecting to a WLAN and configuring network settings

Learn to connect via an access point (AP) when you are in a range of a WLAN. You can also configure network settings.

Connecting to a WLAN

1 Rotate the mode dial to **Wi-Fi**.

2 Select , , , or .





3 Press [**MENU**], and then select **Wi-Fi Setting**.

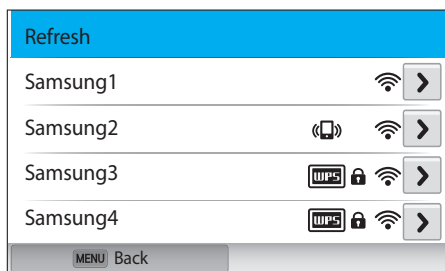

- In some modes, follow the on-screen instructions until the Wi-Fi Setting screen appears.
- The camera automatically searches for available AP devices.

4 Select an AP.



- Select **Refresh** to refresh connectable APs.
- Select **Add wireless network** to add an AP manually. Your AP name must be in English to add the AP manually.

Icon/Option	Description
	Ad hoc AP
	Secured AP
	WPS AP
	Signal strength
	Press [AF] or touch to open network setting options.

- When you select a secured AP, a pop-up window appears. Enter the required passwords to connect to the WLAN. For information about entering text, refer to "Entering text". (p. 127)
- When a login page appears, refer to "Using the login browser". (p. 125)
- When you select an unsecured AP, the camera will connect to the WLAN.
- If you select a WPS profile supported AP, select  → **WPS PIN connection**, and then enter a PIN on the AP device. You can also connect to a WPS profile supported AP by selecting  → **WPS button connection** on the camera, and then pushing the **WPS** button on the AP device.
- The same AP may be listed twice, with different frequencies, because your camera supports the dual band function.

Setting network options

- 1 In the Wi-Fi Setting screen, move to an AP, and then press [AF] or touch ▶.
- 2 Select each option, and then enter the required information.

Option	Description
Network Password	Enter the network password.
IP Setting	Set the IP address automatically or manually.





Manually setting the IP address

- 1 In the Wi-Fi Setting screen, move to an AP, and then press [AF] or touch ▶.
- 2 Select **IP Setting** → **Manual**.
- 3 Select each option, and then enter the required information.

Option	Description
IP	Enter the static IP address.
Subnet Mask	Enter the subnet mask.
Gateway	Enter the gateway.
DNS Server	Enter the DNS address.

Using the login browser

You can enter your login information via the login browser when connecting to some APs, sharing sites, or cloud servers.

Icon	Description
	Close the login browser.
	Move to the previous page.
	Move to the next page.
	Stop loading the page.
	Reload the page.



- You may not be able to select some items depending on the page you connected to. This does not indicate a malfunction.
- The login browser may not close automatically after you log into some pages. If this occurs, close the login browser by touching , and then proceed with the desired operation.
- It may take longer to load the login page due to the page size or network speed. If this occurs, wait until the login information input window appears.

Network connection tips

- You must insert a memory card to use the Wi-Fi features.
- The quality of the network connection will be determined by the AP.
- The further the distance between your camera and the AP, the longer it will take to connect to the network.
- If a nearby device is using the same radio frequency signal as your camera, it may interrupt your connection.
- If your AP name is not in English, the camera may not be able to locate the device or the name may appear incorrectly.
- For network settings or a password, contact your network administrator or network service provider.
- If a WLAN requires authentication from the service provider, you may not be able to connect to it. To connect the WLAN, contact your network service provider.
- Depending on the encryption type, the number of digits in the password may differ.
- A WLAN connection may not be possible in all surroundings.
- The camera may display a WLAN enabled printer on the AP List. You cannot connect to a network via a printer.
- You cannot connect your camera to a network and a TV simultaneously.
- Connecting to a network may incur additional charges. Costs will vary based on the conditions of your contract.
- If you cannot connect to a WLAN, try another AP from the available AP list.
- A login page may appear when you select free WLANs provided by some network service providers. Enter your ID and password to connect to the WLAN. For information about registering or the service, contact the network service providers.
- Be cautious when you enter personal information for an AP connection. Do not enter any payment or credit card information on your camera. The manufacturer is not liable for any problem caused by entering such information.
- Available network connections may differ by country.
- The WLAN feature of your camera must comply with radio transmission laws in your region. To ensure compliance, use the WLAN feature only in the country where you purchased the camera.
- The process for adjusting network settings may differ, depending on network conditions.
- Do not access a network that you are not authorized to use.
- Before you connect to a network, ensure your battery is fully charged.
- You cannot upload or send files captured in some modes.
- Files that you transfer to another device may not be supported by the device. In this case, use a computer to play back the files.

Entering text

Learn how to enter text. The icons in the table let you move the cursor, change the case, etc. Touch a key to enter it.

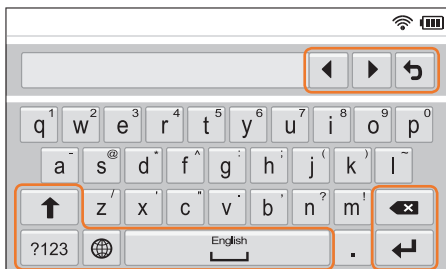

Icon	Description
◀ ▶	Move the cursor.
↶	Stop entering text and return to the previous page.
↑	Change case.
?123	Switch between Symbol/Number mode and the normal mode.
🌐	Change the input language.
␣	Enter a space.
↵	Save the displayed text.
✖	Delete the last letter.



- You can use only the English alphabets in some modes, regardless of the display language.
- You can enter up to 64 characters.
- The screen may differ depending on the input mode.
- Touch and hold a key to enter the character at the upper right corner of the key.

Saving files to a smart phone automatically

The camera connects to a smart phone that supports the AutoShare feature via a WLAN. When you capture a photo with your camera, the photo is saved to the smart phone automatically.



- The AutoShare feature is supported by Galaxy series smart phones or Galaxy Tab models with the Android 2.3 OS or higher or iOS devices with the iOS 6.0 or higher. Before using this feature, check the device's firmware and update it if needed.
- You should install Samsung SMART CAMERA App on your phone or device before using this feature. You can download the application from Samsung Apps, the Google Play Store, or the Apple App Store. Samsung SMART CAMERA App is compatible with Samsung camera models manufactured in 2013 or later.
- To install and launch Samsung SMART CAMERA App on an NFC-enabled smart phone, turn on the NFC feature and place the smart phone near an NFC tag (p. 30) on the camera. This feature is supported by smart phones running Android OS 2.3 or higher. This feature is not available for iOS devices.
- You must insert a memory card to use this feature.
- If you set this function, the setting is maintained even when you change the Shooting mode.
- This feature may not be supported in some modes or may not be available with some shooting options.

1 On the camera, in Shooting mode, press [**MENU**].

2 On the camera, select  → **AutoShare** → **On**.

- If the pop-up message that prompts you to download the application appears, select **Next**.

3 On the smart phone, turn on Samsung SMART CAMERA App.

- For iOS devices, turn on the Wi-Fi feature before turning on the application.
- To start the application automatically on an NFC-enabled smart phone, turn on the function and place the smart phone near the NFC tag (p. 30) on the camera. Verify that the smart phone is connected to your camera, and then skip to step 6.

4 Select the camera from the list and connect the smart phone to the camera.

- The smart phone can connect to only one camera at a time.

5 On the camera, allow the smart phone to connect to your camera.

- If the smart phone has been connected to your camera before, it is connected automatically.
- An icon that shows the connection status () will appear on the camera's screen.

6 On the camera, capture a photo.

- The captured photo is saved to the camera, and then transferred to the smart phone.
- If you recorded a video, it is saved only to the camera.

Sending photos or videos to a smart phone

The camera connects to a smart phone that supports the MobileLink feature via a WLAN. You can easily send photos or videos to your smart phone.



- The MobileLink feature is supported by Galaxy series smart phones or Galaxy Tab models with the Android 2.3 OS or higher or iOS devices with the iOS 6.0 or higher. Before using this feature, check the device's firmware and update it if needed.
- You should install Samsung SMART CAMERA App on your phone or device before using this feature. You can download the application from Samsung Apps, the Google Play Store, or the Apple App Store. Samsung SMART CAMERA App is compatible with Samsung camera models manufactured in 2013 or later.
- To install and launch Samsung SMART CAMERA App on an NFC-enabled smart phone, turn on the NFC feature and place the smart phone near an NFC tag (p. 30) on the camera. This feature is supported by smart phones running Android OS 2.3 or higher. This feature is not available for iOS devices.
- When there are no files in the camera memory, you cannot use this feature.
- If you select files from the smart phone, you can view up to 1,000 recent files and send up to 150 files at a time. If you select files from the camera, you can view files that were selected from the camera. The maximum number of files that can be sent varies depending on the storage space of the smart phone.
- When you send Full HD videos using MobileLink feature, you may not be able to play back files on some devices.
- When using this feature on an iOS device, the device may lose its Wi-Fi connection.
- You cannot send RAW files.

- 1 On the camera, rotate the mode dial to **Wi-Fi**.
- 2 On the camera, select .
 - If the pop-up message that prompts you to download the application appears, select **Next**.
- 3 On the camera, select a sending option.
 - If you select **Select Files from Smartphone**, you can use your smart phone to view and share files stored on the camera.
 - If you select **Select Files from Camera**, you can select files to send from the camera.
- 4 On the smart phone, turn on Samsung SMART CAMERA App.
 - For iOS devices, turn on the Wi-Fi feature before turning on the application.
 - To start the application automatically on an NFC-enabled smart phone, turn on the function and place the smart phone near the NFC tag (p. 30) on the camera. Verify that the smart phone is connected to your camera, and then skip to step 7.

- 5 Select the camera from the list and connect the smart phone to the camera.
 - The smart phone can connect to only one camera at a time.
- 6 On the camera, allow the smart phone to connect to your camera.
 - If the smart phone has been connected to your camera before, it is connected automatically.
- 7 On the smart phone or camera, select files to transfer from the camera.
- 8 On the smart phone, touch the copy button or on the camera, select **Send**.
 - The camera will send the files.



Using a smart phone as a remote shutter release

The camera connects to a smart phone that supports the Remote Viewfinder feature via a WLAN. Use the smart phone as a remote shutter release with the Remote Viewfinder feature. The captured photo will display on the smart phone.









- The Remote Viewfinder feature is supported by Galaxy series smart phones or Galaxy Tab models with the Android 2.3 OS or higher or iOS devices with the iOS 6.0 or higher. Before using this feature, check the device's firmware and update it if needed.
- You should install Samsung SMART CAMERA App on your phone or device before using this feature. You can download the application from Samsung Apps, the Google Play Store, or the Apple App Store. Samsung SMART CAMERA App is compatible with Samsung camera models manufactured in 2013 or later.
- To install and launch Samsung SMART CAMERA App on an NFC-enabled smart phone, turn on the NFC feature and place the smart phone near an NFC tag (p. 30) on the camera. This feature is supported by smart phones running Android OS 2.3 or higher. This feature is not available for iOS devices.
- This function is not available in 3D mode.

- 1 On the camera, rotate the mode dial to **Wi-Fi**.
- 2 On the camera, select .
 - If the pop-up message that prompts you to download the application appears, select **Next**.
- 3 On the smart phone, turn on Samsung SMART CAMERA App.
 - For iOS devices, turn on the Wi-Fi feature before turning on the application.
 - To start the application automatically on an NFC-enabled smart phone, turn on the function and place the smart phone near the NFC tag (p. 30) on the camera. Verify that the smart phone is connected to your camera, and then skip to step 6.
- 4 Select the camera from the list and connect the smart phone to the camera.
 - The smart phone can connect to only one camera at a time.

- 5 On the camera, allow the smart phone to connect to your camera.
- If the smart phone has been connected to your camera before, it is connected automatically.

- 6 On the smart phone, set the following shooting options.



Icon	Description
	Flash option
	Timer option
	Photo size
	Saving location

- While using this feature, some buttons are not available on your camera.
- The zoom button and the shutter button on your smart phone will not function when using this feature.
- Remote Viewfinder mode supports the  and  photo sizes only.

- 7 On the smart phone, touch and hold  to focus.

- The focus is automatically set to **Multi AF**.

- 8 Release  to capture the photo.

- Photos saved to the smart phone will be resized to 1616X1080 when shooting in  and to 1920X1080 when shooting in  resolution.



- When you use this feature, the ideal distance between the camera and the smart phone may vary, depending on your surroundings.
- The smart phone must be within 7 m of the camera to use this feature.
- It will take some time to capture the photo after you release  on the smart phone.
- The Remote Viewfinder function will deactivate when:
 - there is an incoming call on the smart phone
 - either the camera or the smart phone turns off
 - the memory is full
 - device loses its connection to the WLAN
 - the Wi-Fi connection is poor or unstable
 - you perform no operations for approximately 5 minutes while connected

Using Auto Backup to send photos or videos

You can send photos or videos that you captured with the camera to a PC wirelessly.

Installing the program for Auto Backup on your PC

- 1 Install i-Launcher on the PC. (p. 163)
- 2 Connect the camera to the PC with the USB cable.
- 3 When the Auto Backup program icon appears, click it.
 - The Auto Backup program is installed on the PC and the information about the PC will be stored to the camera. Follow the on-screen instructions to complete the installation.
 - You can also save the information about the PC to the camera by connecting the PC and the camera via Wi-Fi.
- 4 Remove the USB cable.



Before installing the program, ensure that the PC is connected to a network. If no internet connection is available, you must install the program from the provided CD.

Sending photos or videos to a PC

- 1 Rotate the mode dial to **Wi-Fi**.
- 2 Select .
 - If the the pop-up message that prompts you to download the application appears, select **Next**.
 - You must configure the backup PC information to use the Auto Backup feature. For more details, refer to "Installing the program for Auto Backup on your PC". (p. 133) If the Auto Backup program is installed on your PC, save the PC information via USB cable or Wi-Fi connection.
 - The camera will automatically attempt to connect to a WLAN via the most recently connected AP device.
 - If the camera has not previously been connected to a WLAN, it will search for available AP devices. (p. 123)

3 Select a backup PC.

- If you have performed a backup before, move to step 4.

4 Select **OK**.

- To cancel sending, select **Cancel**.
- You cannot select individual files to backup. This function backs up only new files on the camera.
- The backup's progress will be shown on the PC monitor.
- When the transfer is completed, the camera will turn off automatically in approximately 30 seconds. Select **Cancel** to return to the previous screen and prevent the camera from turning off automatically.
- To turn off your PC automatically after the transfer is complete, select **Shut down PC after backup**.
- To change the backup PC, select .



- When you connect the camera to the WLAN, select the AP that is connected to the PC.
- The camera will search for available access points even if you are connecting to the same access point again.
- If you turn off the camera or remove the battery while sending files, the file transfer will be interrupted.
- While you are using this feature, the shutter control is disabled on your camera.
- You can connect only one camera to the PC at a time for sending files.
- The backup may be canceled due to network conditions.
- Photos or videos can be sent to a PC one time only. Files cannot be sent again even if you reconnect your camera to another PC.
- When there are no files in the camera memory, you cannot use this feature.
- You must turn off Windows Firewall and any other firewalls before using this feature.
- You can send up to 1,000 recent files.
- On the PC software, the server name must be entered in the Latin alphabet and can contain no more than 48 characters.
- When multiple file types are created at once, only the image files (JPG) will be sent to the PC with this feature.

Sending photos or videos via email

You can change settings in the email menu and send photos or videos stored on the camera via email.

Changing email settings

In the email menu, you can change settings for storing your information. You can also set or change the email password. For information about entering text, refer to "Entering text". (p. 127)

Storing your information

- 1 Rotate the mode dial to **Wi-Fi**.
- 2 Select .
 - The camera will automatically attempt to connect to a WLAN via the most recently connected AP device.
 - If the camera has not previously been connected to a WLAN, it will search for available AP devices. (p. 123)
- 3 Press [**MENU**].
- 4 Select **Sender Setting**.

- 5 Select the **Name** box, enter your name, and then touch .

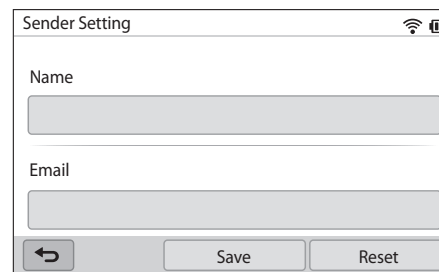

- 6 Select the **Email** box, enter your email address, and then touch .
- 7 Select **Save** to save your changes.
 - To delete your information, select **Reset**.

Setting an email password

- 1 Rotate the mode dial to **Wi-Fi**.
- 2 Select .
 - The camera will automatically attempt to connect to a WLAN via the most recently connected AP device.
 - If the camera has not previously been connected to a WLAN, it will search for available AP devices. (p. 123)
- 3 Press [**MENU**].
- 4 Select **Setting Password** → **On**.
 - To deactivate the password, select **Off**.
- 5 When the pop-up appears, select **OK**.

6 Enter a 4-digit password.

7 Enter the password again.

8 When the pop-up appears, select **OK**.





If you lost your password, you can reset it by selecting **RESET** on the password setting screen. When you reset the information, the previously saved user's setting information, email address, and recently sent email list will be deleted.

Changing the email password

- 1 Rotate the mode dial to **Wi-Fi**.
- 2 Select .
 - The camera will automatically attempt to connect to a WLAN via the most recently connected AP device.
 - If the camera has not previously been connected to a WLAN, it will search for available AP devices. (p. 123)
- 3 Press [**MENU**].
- 4 Select **Change Password**.
- 5 Enter your current 4-digit password.
- 6 Enter a new 4-digit password.
- 7 Enter the new password again.
- 8 When the pop-up appears, select **OK**.

Sending photos or videos via email

You can send photos or videos stored on the camera via email. For information about entering text, refer to "Entering text". (p. 127)

- 1 Rotate the mode dial to **Wi-Fi**.
- 2 Select .
 - The camera will automatically attempt to connect to a WLAN via the most recently connected AP device.
 - If the camera has not previously been connected to a WLAN, it will search for available AP devices. (p. 123)
- 3 Select the **Sender** box, enter your email address, and then touch .
 - If you have previously saved your information, it will be inserted automatically. (p. 135)
 - To use an address from the list of previous senders, select ▼ → an address.

- 4 Select the **Receiver** box, enter an email address, and then touch **↩**.
 - To use an address from the list of previous recipients, select **▼** → an address.
 - Select **+** to add additional recipients. You can input up to 30 recipients.
 - Select **X** to delete an address from the list.
- 5 Select **Next**.
- 6 Select files to send.
 - You can select up to 20 files. The total size must be 7 MB or less.
- 7 Select **Next**.
- 8 Select the comment box, enter your comments, and then touch **↩**.
- 9 Select **Send**.
 - The camera will send the email.



- Even if a photo appears to have transferred successfully, errors with the recipient's email account may cause the photo to be rejected or recognized as spam.
- You may not be able to send an email if no network connection is available or if your email account settings are incorrect.
- You cannot send an email if the file size exceeds the limit. The maximum photo resolution you can send is 2M and the longest video you can upload is a video recorded using **240**. If the selected photo resolution is higher than 2M, it will be automatically resized to a lower resolution.
- If you cannot send an email because of firewall or user authentication settings, contact your network administrator or network service provider.
- When there are no files in the camera memory, you cannot use this feature.
- You can also send an email in Playback mode by pressing **[MENU]**, and then selecting **Share(Wi-Fi)** → **Email**.

Using photo or video sharing websites

Upload your photos or videos to file sharing websites. Available websites will be displayed on your camera. To upload files to some websites, you must visit the website and register before connecting your camera.

Accessing a website

- 1 Rotate the mode dial to **Wi-Fi**.
- 2 Select .
- 3 Select a website.
 - If the pop-up message that prompts you to create an account appears, select **OK**.
 - The camera will automatically attempt to connect to a WLAN via the most recently connected AP device.
 - If the camera has not previously been connected to a WLAN, it will search for available AP devices. (p. 123)

4 Enter your ID and password to log in.

- For information about entering text, refer to "Entering text". (p. 127)
- If you connected to SkyDrive, refer to "Using the login browser". (p. 125)
- To select an ID from the list, select ▼ → an ID.
- If you have previously logged in to the website, you may be logged in automatically.



You must have an existing account on the file sharing website to use this feature.

Uploading photos or videos

- 1 Access the website with your camera.
- 2 Select files to upload.
 - You can select up to 20 files. The total size must be 10 MB or less. (On some websites, the total size or number of files may vary.)
- 3 Select **Upload**.
 - On some websites, you can enter your comments by selecting the comment box. For information about entering text, refer to "Entering text". (p. 127)



- You can set an upload folder for Facebook by pressing [MENU], and then selecting **Upload Folder (Facebook)** on the website's list screen.
- You cannot upload files if the file size exceeds the limit. The maximum photo resolution you can upload is 2M, and the longest video you can upload is a video recorded using 240. If the selected photo resolution is higher than 2M, it will be automatically resized to a lower resolution. (On some websites, the maximum photo resolution may vary.)
- The method of uploading photos or videos may differ depending on the selected website.
- If you cannot access a website because of firewall or user authentication settings, contact your network administrator or network service provider.
- Uploaded photos or videos may be automatically titled with the date they were captured.
- The speed of your internet connection may affect how quickly photos upload or web pages open.
- When there are no files in the camera memory, you cannot use this feature.
- You can also upload photos or videos to file sharing websites in Playback mode by pressing [MENU], and then selecting **Share(Wi-Fi)** → a desired website.
- You cannot upload videos to some websites.
- When you upload photos to SkyDrive, they will be resized to 2M while maintaining their aspect ratios.

Using AllShare Play to send files

You can upload files from your camera to AllShare Play online storage or view files on an AllShare Play device connected to the same AP.

Uploading photos to online storage

1 Rotate the mode dial to **Wi-Fi**.

2 Select  → **Web storage**.

- If the guide message appears, select **OK**.
- The camera will automatically attempt to connect to a WLAN via the most recently connected AP device.
- If the camera has not previously been connected to a WLAN, it will search for available AP devices. (p. 123)
- To change the size for uploaded photos, press [**MENU**], and then select **Upload Image Size**.
- If you have registered more than one web storage, you can select from the list by pressing [**MENU**], and then selecting **Change Web storage**.

3 Enter your ID and password, and then select **Login** → **OK**.

- For information about entering text, refer to "Entering text". (p. 127)
- To select an ID from the list, select ▼ → an ID.
- If you have previously logged in to the website, you may be logged in automatically.



To use this feature, you must create an AllShare Play account and an account with an affiliated online storage service using your PC. After finishing creating accounts, add your online storage account to AllShare Play.

4 Select files you want to upload, and then select **Upload**.



- If you have registered more than one web storage, select a web storage first.
- You cannot upload video files to AllShare Play online storage.
- When there are no files in the camera memory, you cannot use this feature.
- You can upload up to 20 files.
- You can also upload photos in Playback mode by pressing [**MENU**], and then selecting **Share(Wi-Fi)** → **AllShare Play**.

Viewing photos or videos on devices that support AllShare Play

- 1 Rotate the mode dial to **Wi-Fi**.
- 2 Select  → **Nearby devices**.
 - If the guide message appears, select **Yes**.
 - The camera will automatically attempt to connect to a WLAN via the most recently connected AP device.
 - If the camera has not previously been connected to a WLAN, it will search for available AP devices. (p. 123)
 - You can set to allow only selected devices or all devices to connect by pressing [**MENU**], and then selecting **DLNA Access Control** on the screen.
 - A sharing file list is created. Wait until other devices can find your camera.
- 3 Connect the AllShare Play device to a network, and then turn on the AllShare Play feature.
 - Refer to your device's user manual for more information.
- 4 On the camera, allow the AllShare Play device to connect to your camera.
- 5 On the AllShare Play device, select a camera to connect.

- 6 On the AllShare Play device, browse the shared photos or videos.
 - For information about searching for the camera and browsing the photos or videos on the AllShare Play device, refer to the device's user manual.
 - Videos may not play smoothly depending on the type of AllShare Play device or the network condition. For smooth playback, use a 5 Ghz dual-band AP device.

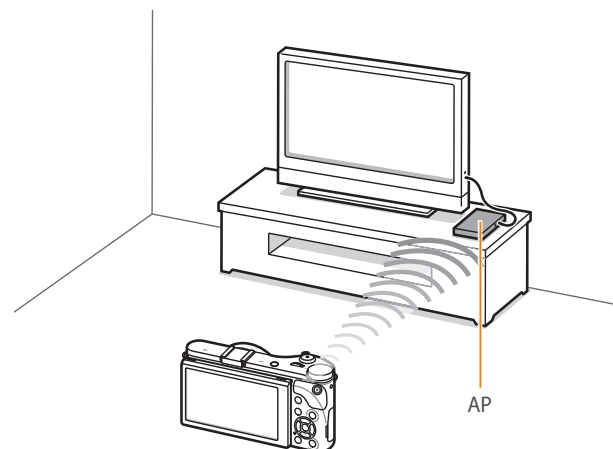

▲ A camera is connected to a TV that supports AllShare Play via WLAN.



- You can share up to 1,000 recent files.
- On an AllShare Play device, you can view only photos or videos captured with your camera.
- The range of the wireless connection between your camera and an AllShare Play device may vary depending on the specifications of the AP.
- If the camera is connected to 2 AllShare Play devices, playback may be slower.
- Photos or videos will be shared in their original sizes.
- You can use this feature only with devices that support AllShare Play.
- Shared photos or videos will not be stored on the AllShare Play device, but they can be stored in the camera to meet the device's specifications.
- Transferring photos or videos to the AllShare Play device may take some time depending on the network connection, the number of files to be shared, or the sizes of the files.
- If you power off the camera abnormally while viewing photos or videos on an AllShare Play device (for example, by removing the battery), the device considers the camera to still be connected.
- The order of photos or videos on the camera may be different than on the AllShare Play device.
- Depending on the number of photos or videos you want to share, it may take some time to load your photos or videos and complete the initial set-up process.
- While viewing photos or videos on the AllShare Play device, continuously using the device's remote or performing additional operations on the device may prevent this feature from working properly.

- If you reorder or sort files on the camera while viewing them on an AllShare Play device, you must repeat the initial set-up process to update the list of files on the device.
- When there are no files in the camera memory, you cannot use this feature.
- We recommend you use a network cable to connect your AllShare Play device to your AP. This will minimize any video 'Stuttering' you may experience when streaming content.
- To view files on an AllShare Play device using the **Nearby devices** feature, enable multicast mode on your AP.
- 1920X1080 (60 fps) videos can be played only on full HDTVs capable of playback at 60 fps.
- You can view 3D files only on 3D-compatible TVs or monitors.

Sending photos using Wi-Fi Direct

When the camera connects via a WLAN to a device that supports the Wi-Fi Direct function, you can send photos to the device. This feature may not be supported on some devices.

- 1 On the device, turn on the Wi-Fi Direct option.
- 2 On the camera, in Playback mode, scroll to a photo.
- 3 Press [**MENU**], and then select **Share(Wi-Fi)** → **Wi-Fi Direct**.
 - When in the single image view, you can send only one photo at a time.
 - When in thumbnails view, you can select multiple photos. Select **Upload** when you are finished selecting photos.
- 4 Select the device from the camera's list of Wi-Fi Direct devices.
 - Ensure that the device's Wi-Fi Direct option is turned on.
 - You can also select your camera from the device's list of Wi-Fi Direct devices.

- 5 On the device, allow the camera to connect to the device.
 - The photo will be sent to the device.



- You can send up to 20 files at a time.
- When there are no photos in the camera memory, you cannot use this feature.
- If you cannot connect to a Wi-Fi Direct device, update the device with the latest firmware. This feature may not be supported on some devices.

Chapter 5

Camera settings menu

Learn about the user settings and general settings menu.
You can adjust the settings to better suit your needs and preferences.

User settings

You can set the user environment with these settings.

To set user options,

In Shooting mode, press [MENU] →  → an option.



Available items and the order of them may differ depending on shooting conditions.

ISO Customizing

ISO Step

You can set the size for the ISO sensitivity by either 1/3 or 1 step.

Auto ISO Range

You can set the maximum ISO value under which each EV step is chosen when you set the ISO to **Auto**.

* Default

Option	Value
1/3 Step	ISO 125, ISO 160, ISO 200, ISO 250, ISO 320, ISO 400, ISO 500, ISO 640, ISO 800, ISO 1000, ISO 1250, ISO 1600, ISO 2000, ISO 2500, ISO 3200*
1 Step	ISO 200, ISO 400, ISO 800, ISO 1600, ISO 3200*

Noise Reduction

Use the Noise Reduction to reduce the visual noise in photos.

* Default

Option	Description
High ISO NR	This function reduces noise that may occur when you set a high ISO sensitivity. (Off , High , Normal* , Low)
Long Term NR	This function reduces noise when you set the camera for a long exposure. (Off , On*)

Bracket Set

You can set up the options for AE Bracket, WB Bracket, and P Wiz Bracket.

Option	Description
AE Bracket Set	Set the exposure interval. (-/+0.3 EV*, -/+0.7 EV, -/+1 EV, -/+1.3 EV, -/+1.7 EV, -/+2 EV, -/+2.3 EV, -/+2.7 EV, -/+3 EV)
WB Bracket Set	Adjust the White Balance interval range of the 3 bracketed photos. (AB-/ +3* , AB-/ +2 , AB-/ +1 , MG-/ +3 , MG-/ +2 , MG-/ +1) For example, AB-/ +3 adjusts the Amber value plus or minus three steps. MG-/ +3 adjusts the Magenta value the same amount.
P Wiz Bracket Set	Select 3 Picture Wizard settings the camera uses to capture the 3 bracketed photos.

DMF (Direct Manual Focus)

You can adjust the focus manually by rotating the focus ring after achieving the focus by half-pressing [**Shutter**]. This feature may not be available with some lenses.

Color space

The color space option allows you to select methods for representing colors. Digital imaging devices such as digital cameras, monitors, and printers have their own methods for representing colors, which are called color spaces.

Option	Description
sRGB	sRGB (Standard RGB) is an international specification to define the color space created by IEC (International Electrotechnical Commission). It is widely used for creating colors on PC monitors and is also the standard color space for Exif. sRGB is recommended for regular images and images you intend to publish on the Internet.
Adobe RGB	Adobe RGB is used for commercial printing and has a larger color range than sRGB. Its wider range of colors helps you to easily edit photos on a computer. Note that individual programs are generally compatible with a limited number of color spaces.

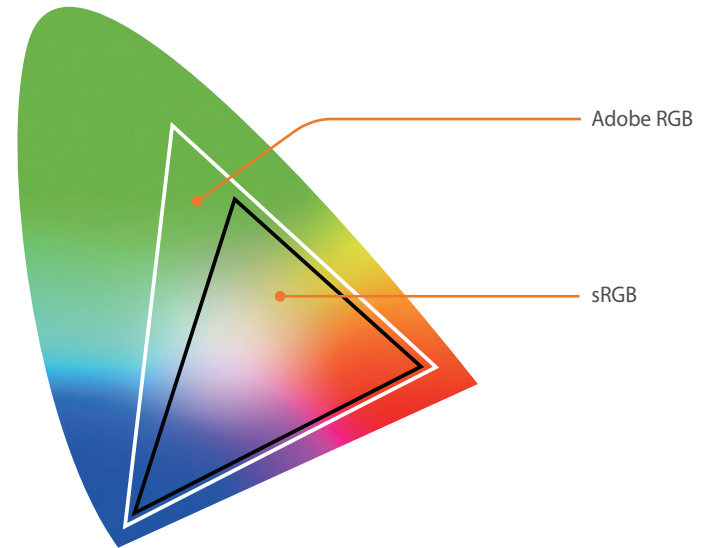

When the color space is set to Adobe RGB, photos will be saved as "_SAMXXXX.JPG".

Distortion Correct

You can correct lens distortion that might occur from lenses. This feature may not be available with some lenses.

iFn Customizing

You can select options that can be adjusted when you press [**i-Function**] on an i-Function lens.

Option	Description
Aperture	Set to adjust the aperture value.
Shutter Speed	Set to adjust the shutter speed.
EV	Set to adjust the exposure value.
ISO	Set to adjust ISO sensitivity.
White Balance	Set to adjust the White Balance.
🕒 Zoom	Set to adjust the zoom ratio.

User Display

You can add or remove shooting information from the display.

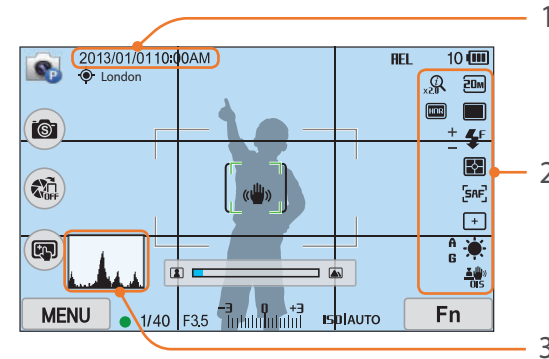

No.	Description
1	Date & Time Set to display the date and time.
2	Icons Set to display icons on the right in Shooting mode.

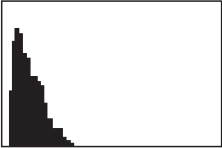
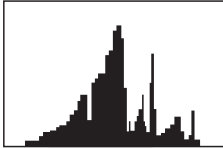
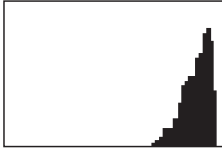
No.	Description
3	<p>Histogram Set the histogram on the display on or off.</p> <p>About histogram A histogram is a graph that shows the brightness distribution of a photo. A histogram inclined to the left indicates a dark photo. A histogram inclined to the right indicates a bright photo. The height of the graph is related to color information. The graph gets higher if a specific color is more common.</p> <div style="display: flex; justify-content: space-around; align-items: center;">    </div> <div style="display: flex; justify-content: space-around; margin-top: 5px;"> Insufficient exposure Balanced exposure Excessive exposure </div>

Key Mapping

You can change the function assigned to the Custom button or DIRECT LINK button.

Button	Function
Custom	<p style="text-align: right;">* Default</p> <p>Set a function of the Custom button.</p> <ul style="list-style-type: none"> • Optical Preview*: Execute the Depth of Field Preview function for the current aperture value. (p. 24) • One Touch WB (White Balance): Execute the Custom White Balance function. • One Touch RAW +: Save a file in the RAW+JPEG format. To save a file in JPEG format, press the button again. • Reset: Reset some settings. • AEL: Execute the auto exposure lock function. • AEL Hold: Keep executing the auto exposure lock function after shooting.
DIRECT LINK	<p>Set a function of the DIRECT LINK button. (AutoShare*, MobileLink, Remote Viewfinder, Auto Backup, Email, SNS & Cloud, AllShare Play)</p>

Grid Line

Select a guide to help you compose a scene.
(**Off***, **3 X 3**, **2 X 2**, **Cross**, **Diagonal**)

AF Lamp

When shooting in dark places, turn the AF lamp on in order to have a better auto focus. The Auto Focus functions more accurately in dark places when the AF lamp is on.





Setting

Learn to configure your camera's settings.





To set Setting options,

In Shooting or Playback mode, press [MENU] →  → an option.

Item	Description
Sound	<p style="text-align: right;">* Default</p> <ul style="list-style-type: none"> • System Volume: Set the sound volume or turn all sound off entirely. (Off, Low, Medium*, High) <div style="border: 1px solid gray; padding: 5px; margin: 5px 0;">  Even if the system volume is turned off, the camera emits the sound while playing a video or a slide show. </div> <ul style="list-style-type: none"> • AF Sound: Set the sound the camera emits when you half-press the shutter button on or off. (Off, On*) • Button Sound: Set the sound the camera emits when you press the buttons or touch the screen on or off. (Off, On*)
Quick View	Set the Quick View time length – the amount of time the camera displays a photo immediately after you capture it. (Off, 1 sec* , 3 sec, 5 sec, Hold)

Item	Description
Display Adjust	<p style="text-align: right;">* Default</p> <p>Adjust the display brightness, auto brightness setting, display color, or level gauge.</p> <ul style="list-style-type: none"> • Display Brightness: You can adjust the display brightness manually. • Auto Brightness: Turn auto brightness on or off. (Off, On*) • Display Color: You can adjust the display color manually. • Horizontal Calibration: Calibrate the level gauge. If the level gauge is not level, position the camera on the level surface, and then follow the on-screen instructions. <div style="border: 1px solid gray; padding: 5px; margin: 5px 0;">  <ul style="list-style-type: none"> • You cannot access the Horizontal Calibration option in Playback mode. • You cannot calibrate the level gauge in portrait orientation. </div>
Auto Display Off	Set the display off time. The display turns off if you do not use the camera for the time you set. (Off, 30 sec* , 1 min, 3 min, 5 min, 10 min)

* Default

Item	Description
Power Save	<p>Set power shut off time. The camera shuts off if you do not use it for the time you set. (30 sec, 1 min*, 3 min, 5 min, 10 min, 30 min)</p> <div style="border: 1px solid #ccc; padding: 5px; background-color: #f9f9f9;">  <ul style="list-style-type: none"> The camera retains the power-off time setting even if you replace the battery. Power Save may not work if the camera is connected to a computer or a TV or playing a slide show or a movie. </div>
Help Guide Display	<p>Set to display help text about menus and functions. (Off, On*)</p> <div style="border: 1px solid #ccc; padding: 5px; background-color: #f9f9f9;">  <p>Press [] to hide the help text.</p> </div>
Language	<p>Set a language the camera shows on the display.</p>
Date & Time	<p>Set date, time, date format, time zone and whether to imprint the date on photos. (Time Zone, Date & Time, Date Type, Time Type, Imprint)</p> <div style="border: 1px solid #ccc; padding: 5px; background-color: #f9f9f9;">  <ul style="list-style-type: none"> The date appears on the lower right side of the photo. When you print a photo, some printers may not print the date appropriately. </div>

* Default

Item	Description
Video Out	<p>Set the video signal output appropriate for your country when connecting the camera to an external video device such as a monitor or HDTV.</p> <ul style="list-style-type: none"> NTSC: USA, Canada, Japan, Korea, Taiwan, Mexico, etc PAL (Supports only PAL B, D, G, H, or I): Australia, Austria, Belgium, China, Denmark, Finland, France, Germany, England, Italy, Kuwait, Malaysia, New Zealand, Singapore, Spain, Sweden, Switzerland, Thailand, Norway, etc
Anynet+ (HDMI-CEC)	<p>When you connect the camera to an HDTV that supports Anynet+ (HDMI-CEC), you can control the play function of the camera with the TV remote control.</p> <ul style="list-style-type: none"> Off: You cannot control the play function of camera with the TV remote control. On*: You can control the play function of camera with the TV remote control.
HDMI Output	<p>When you connect the camera to an HDTV with an HDMI cable, you can change the resolution of the image.</p> <ul style="list-style-type: none"> NTSC: Auto*, 1080p, 720p, 480p, 576p (activates only when PAL is selected) <div style="border: 1px solid #ccc; padding: 5px; background-color: #f9f9f9;">  <p>If the connected HDTV does not support the resolution you select, the camera sets the resolution one level lower.</p> </div>



* Default

Item	Description
3D HDMI Output	<p>Select an option for playing files on a 3D TV.</p> <ul style="list-style-type: none"> • Side by Side*: Displays two images next to each other. • Frame Packing: Displays the images for the left and right eye alternately in frames.
File Name	<p>Set the method of creating file names.</p> <ul style="list-style-type: none"> • Standard*: SAM_XXXX.JPG (sRGB)/_SAMXXXX.JPG (Adobe RGB) • Date: <ul style="list-style-type: none"> - sRGB files - MMDDXXXX.JPG. For example, for a photo captured on Jan. 01, the file name would be 0101XXXX.jpg. - Adobe RGB files - _MDDXXXX.JPG for the months Jan through Sept. For the months Oct through Dec, the month number is replaced by the letters A (Oct.), B (Nov.) and C (Dec.). <p>For example, for a photo captured on Feb. 03, the file name would be _203XXXX.jpg. For a photo captured on Oct. 05, the file name would be _A05XXXX.jpg.</p>



* Default

Item	Description
File Number	<p>Set the method of numbering files and folders.</p> <ul style="list-style-type: none"> • Reset: After using the reset function, the next file name is started at 0001. • Series*: New file numbers continue the existing number sequence, even if you have installed a new memory card, formatted the card, or deleted all photos. <div style="border: 1px solid #ccc; background-color: #f0f0f0; padding: 10px; margin-top: 10px;">  <ul style="list-style-type: none"> • The first folder name is 100PHOTO, if you have selected the sRGB color space and Standard file naming, the first file name is SAM_0001. • File name numbers are increased by 1 from SAM_0001 to SAM_9999. • Folder numbers are increased by 1 from 100PHOTO to 999PHOTO. • The maximum number of files that can be saved in one folder is 9,999. • File numbers are assigned according to DCF (Design rule for Camera File system) specifications. • If you change a file name (for example, on a computer), the camera will not be able to play the file. </div>
Folder Type	<p>Set the type of folder.</p> <ul style="list-style-type: none"> • Standard*: XXXPHOTO • Date: XXX_MMDD

* Default

Item	Description
Format	<p>Format the memory card. Formatting deletes all existing files including protected files. (Yes, No)</p> <div style="border: 1px solid #ccc; padding: 5px; margin-top: 10px;">  <p>Errors can occur if you use a memory card formatted by another brand of camera, a memory card reader, or a computer. Please format memory cards in the camera before using them to capture photos.</p> </div>
Device Information	<p>View the firmware version of the body and the lens, Mac address, and network certification number, or update the firmware.</p> <ul style="list-style-type: none"> • Firmware Update: Update the firmware of the camera body or lens. (Body Firmware, Lens Firmware) <div style="border: 1px solid #ccc; padding: 5px; margin-top: 10px;">  <ul style="list-style-type: none"> • You can download firmware upgrades from www.samsung.com. • You cannot run a firmware upgrade without a fully charged battery. Recharge the battery fully before running a firmware upgrade. • If you update the firmware, user settings and values will be reset. (Date, time, language, and video out will not change.) • Do not turn the camera off while the update is in progress. </div>

* Default

Item	Description
Dual-band Mobile AP	<p>Set a frequency for using the camera as an AP for the AutoShare, MobileLink, or Remote Viewfinder feature. (5 GHz, 2.4 GHz*)</p> <div style="border: 1px solid #ccc; padding: 5px; margin-top: 10px;">  <p>If you use the camera in a country other than the one where it was purchased, the 5 GHz Wi-Fi feature may not function properly, due to differences in radio frequencies. In this case, use the 2.4 GHz Wi-Fi feature instead.</p> </div>
GPS	<ul style="list-style-type: none"> • Geotagging: Set to capture photos with location information using the Global Positioning System (GPS). Location information is added to the Exif data associated with the photo. (Off, On*) • GPS Valid Time Settings: Set the time to use the last location information when the camera fails to receive GPS signals. If the camera fails to receive GPS signals after the specified time, the location information will not be recorded onto the photos. (15 sec*, 30 sec, 1 min, 3 min, 10 min, 30 min) • Location Display: Set to display the location information on the screen in Shooting mode. The location information will appear in Korean only when you are in Korea and the display language is set to Korean. When another language is set, the location information will appear in English. (Off, On*) • GPS Reset: Set to search for GPS satellites closest to your current position. (Yes, No) <div style="border: 1px solid #ccc; padding: 5px; margin-top: 10px;">  <p>To use the GPS function, you must purchase an optional GPS device.</p> </div>

* Default

Item	Description
<p>Sensor Cleaning</p>	<ul style="list-style-type: none"> • Sensor Cleaning: Remove dust from the sensor. • Start-Up Action: When on, the camera performs sensor cleaning each time you turn it on. (Off*, On) <div data-bbox="305 408 942 600" style="background-color: #f0f0f0; padding: 10px; border: 1px solid #ccc;">  <p>As this product uses interchangeable lenses, the sensor can get dust on it when you change lenses. This can lead to dust particles appearing in the photos you capture. It is recommended not to change lenses when you are in a particularly dusty area. Also, make sure to attach the lens cap to the lens when not using it.</p> </div>
<p>Reset</p>	<p>Reset the setup menu and shooting options to the factory defaults. (Date, time, language, and video output settings do not change.) (Yes, No)</p>
<p>Open Source Licenses</p>	<p>View open source licenses.</p>



Chapter 6

Connecting to external devices

Make full use of the camera by connecting it to external devices such as a computer, HDTV or 3D TV.

Viewing files on an HDTV or 3D TV

Play back photos or videos by connecting your camera to an HDTV (3D TV) using an optional HDMI cable.

Viewing files on an HDTV

- 1 In Shooting or Playback mode, press [MENU] →  → **HDMI Output** → an option. (p. 153)
- 2 Turn off your camera and HDTV.
- 3 Connect your camera to your HDTV with the optional HDMI cable.

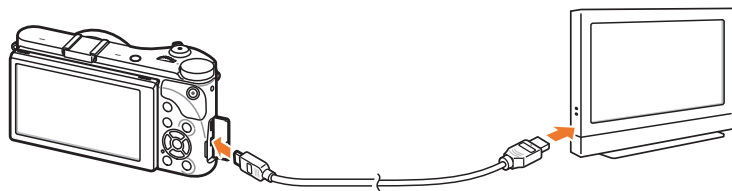

- 4 Turn on your HDTV, and then select the HDMI video source.

- 5 Turn on the camera.

- The camera automatically enters into Playback mode when you connect it to an HDTV.

- 6 View photos or play videos using the camera buttons.



- When using the HDMI cable, you can connect the camera to an HDTV using the Anynet+(CEC) method.
- The Anynet+(CEC) functions allow you to control connected devices using the TV remote control.
- If the HDTV supports Anynet+(CEC), the TV turns on automatically when used in conjunction with the camera. This feature may not be available on some HDTVs.
- When connected to an HDTV by an HDMI cable, the camera cannot capture a photo or video.
- When connected to an HDTV, some of the camera's playback functions may not be available.
- The length of time after which the camera and an HDTV are connected may vary depending on the memory card that you are using. As the main feature of a memory card is to increase the transfer speed, it is not necessarily true to say that a memory card with a faster transfer speed is also fast in using the HDMI function.
- 1920X1080 (60 fps) videos can be played only on full HDTVs capable of playback at 60 fps.

Viewing files on a 3D TV

You can view photos or videos captured in 3D mode or with the 3D Panorama option in Smart mode on a 3D TV.

- 1 In Shooting or Playback mode, press **[MENU]** →  → **HDMI Output** → an option. (p. 153)
- 2 Select **3D HDMI Output** → an option. (p. 154)
- 3 Turn off your camera and 3D TV.
- 4 Connect your camera to your 3D TV with the optional HDMI cable.

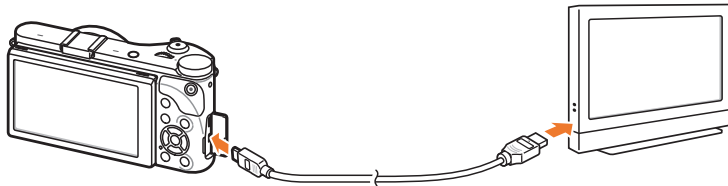

- 5 Turn on your 3D TV, and then select the HDMI video source.
- 6 Turn on your camera.
 - The camera automatically enters into Playback mode when you connect it to a 3D TV.

- 7 Move to a 3D file, and then press **[ISO]** to switch to 3D mode.
 - Press **[ISO]** again to switch to 2D Mode.
- 8 Turn on your TV's 3D function.
 - Refer to your TV's user manual for more details.
- 9 View 3D photos or play 3D videos using the camera buttons.



- You cannot view an MPO file in 3D effect on TVs that do not support the file format.
- Use proper 3D glasses when you view an MPO file or a 3D video file on a 3D TV.
- Capturing photos in 3D Panorama mode may result in a less pronounced 3D effect than those captured in 3D mode with a 3D lens.



Do not view the 3D photos or videos captured by your camera on a 3D TV or 3D monitor for an extended period of time. It may cause unpleasant symptoms, such as eyestrain, fatigue, nausea, and more.

Transferring files to your computer

Transfer files on a memory card to your computer by connecting the camera to the PC.

Transferring files to your Windows OS computer

Connecting the camera as a removable disk

You can connect the camera to your computer as a removable disk.

- 1 Turn off the camera.
- 2 Connect the camera to your computer with the USB cable.

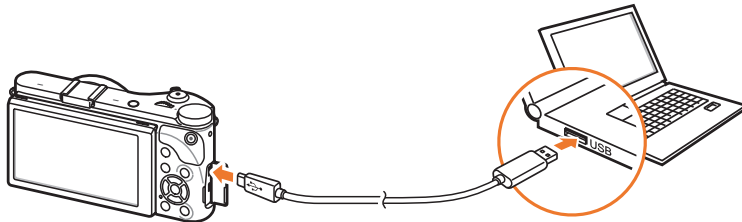

- You must plug the small end of the USB cable into your camera. If the cable is reversed, it may damage your files. The manufacturer is not responsible for any loss of data.
- If you try to plug the USB cable into the HDMI port, the camera may not work properly.



- 3 Turn on the camera.
 - The computer recognizes the camera automatically.
- 4 On your computer, select **My Computer** → **Removable Disk** → **DCIM** → **100PHOTO** or **101_0101**.
- 5 Select the files you want, and then drag or save them to your computer.



If the **Folder Type** is set to **Date**, the folder name appears as "XXX_MMDD". For example, if you capture a photo on January 1, the folder name will be "101_0101".

Disconnecting the camera (for Windows XP)

With Windows Vista, Windows 7, and Windows 8, the methods for disconnecting the camera are similar.

- 1 Ensure that no data is being transferred between the camera and the computer.
 - If the status lamp on your camera is blinking, it means the data transfer is in progress. Please wait until the status lamp stops blinking.
- 2 Click  on the tool bar at the bottom right of your computer screen.

- 3 Click the pop-up message.
- 4 Click the message box indicating safely removed.
- 5 Remove the USB cable.

Transferring files to your Mac OS

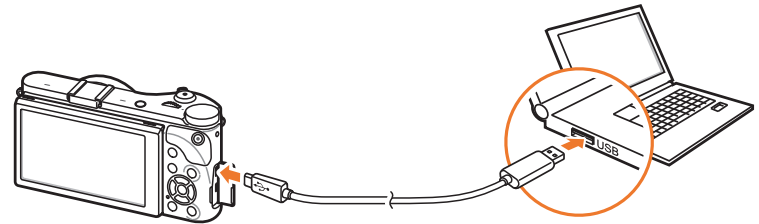

Mac OS 10.5 or later is supported.

- 1 Turn off the camera.
- 2 Connect your camera to a Macintosh computer with the USB cable.



- You must plug the small end of the USB cable into your camera. If the cable is reversed, it may damage your files. The manufacturer is not responsible for any loss of data.
- If you try to plug the USB cable into the HDMI port, the camera may not work properly.

- 3 Turn on the camera.
 - The computer recognizes the camera automatically and displays a removable disk icon.
- 4 Open the removable disk.
- 5 Transfer photos or videos to the Mac OS computer.



Using programs on a PC

You can view and edit files using the provided programs. You can also send the files to a PC wirelessly.

Installing programs from the provided CD

- 1 Insert the installation CD into your PC.
- 2 Select a language.
- 3 Select a program to install.
- 4 Follow the on-screen instructions.
- 5 Click **Exit** to complete the installation.

Available programs when using i-Launcher

Item	Description
Multimedia Viewer	You can view files with Multimedia Viewer.
Firmware Upgrade	You can download the firmware of your camera.
PC Auto Backup	You can send photos or videos that you captured with the camera to a PC wirelessly.

Using i-Launcher

i-Launcher allows you to play back files with Multimedia Viewer and provides a link to download the PC Auto Backup program.

Requirements for Windows OS

Item	Requirements
CPU	Intel® i5 3.3 GHz or higher/ AMD Phenom™ II x4 3.2 GHz or higher
RAM	Minimum 512 MB RAM (1 GB or more recommended)
OS*	Windows XP SP2, Windows Vista, Windows 7, Windows 8
Hard disk capacity	250 MB or more (1 GB and above recommended)
Others	<ul style="list-style-type: none"> • CD-ROM drive • 1024X768 pixels, 16-bit color display compatible monitor (1280X1024 pixels, 32-bit color display recommended) • USB 2.0 port • nVIDIA Geforce 7600GT or higher/ ATI X1600 series or higher • Microsoft DirectX 9.0c or higher

* A 32-bit version of i-Launcher will be installed—even on 64-bit editions of Windows XP, Windows Vista, Windows 7, and Windows 8.



- The requirements are recommendation only. i-Launcher may not work properly even when the computer meets the requirements, depending on the condition of your computer.
- If your computer does not meet the requirements, videos may not play correctly.



The manufacturer is not responsible for any damage that results from using unqualified computers such as a computer you assembled yourself.

Requirements for Mac OS

Item	Requirements
OS	Mac OS 10.5 or higher (except PowerPC)
RAM	Minimum 256 MB RAM (512 MB or more recommended)
Hard disk capacity	Minimum 110 MB
Others	USB 2.0 port, CD-ROM drive

Opening i-Launcher

On your computer, select **Start** → **All Programs** → **Samsung** → **i-Launcher** → **Samsung i-Launcher**. Or, click **Applications** → **Samsung** → **i-Launcher** on your Mac OS computer.

Using Multimedia Viewer

Multimedia Viewer allows you to play back files. From the Samsung i-Launcher screen, click **Multimedia Viewer**.



- Multimedia Viewer supports the following formats:
 - Videos: MP4 (Video: H.264, Audio: AAC), WMV (WMV 7/8/9), AVI (MJPEG)
 - Photos: JPG, GIF, BMP, PNG, TIFF, MPO
- Files that have been recorded with other manufacturers' devices may not play back smoothly.

Viewing photos



No.	Description
1	File name
2	Enlarged area
3	Histogram
4	Open the selected file.
5	Histogram button
6	Rotate to the left/Rotate to the right.
7	Move to the previous file/Move to the next file.
8	Fit the photo to the screen.
9	View the photo in the original size.
10	Zoom in/Zoom out
11	Switches between 2D and 3D mode.

Viewing videos



No.	Description
1	File name
2	Adjust the volume.
3	Open the selected file.
4	Move to the next file.
5	Stop

No.	Description
6	Pause
7	Move to the previous file.
8	Progress bar

Downloading the firmware

From the Samsung i-Launcher screen, click **Firmware Upgrade**.

Downloading the PC Auto Backup program

From the Samsung i-Launcher screen, click **PC Auto Backup**. For information about installing the PC Auto Backup program, refer to page 133.

Installing Adobe Photoshop Lightroom

- 1 Insert Adobe Photoshop Lightroom DVD-ROM into your PC.
- 2 Select a language.
- 3 Follow the on-screen instructions.

Using Adobe Photoshop Lightroom

Photos captured by a camera are often transformed to JPEG formats and stored in the memory according to the settings of the camera at the time of shooting. RAW files are not transformed to JPEG formats and are stored in the memory without any changes. With Adobe Photoshop Lightroom, you can calibrate exposures, White Balances, tones, contrasts, and colors of photos. You can also edit JPEG or TIFF files as well as RAW files. For more information, refer to the program guide.



Chapter 7

Appendix

Get information about error messages, camera maintenance, trouble shooting tips, specifications, and optional accessories.

Error messages

When the following error messages appear, try these remedies.

Error messages	Suggested remedies
Lens is locked	The lens is locked. Rotate the lens counter-clockwise until you hear a click. (p. 45)
Card Error	<ul style="list-style-type: none"> • Turn off your camera, and then turn it on again. • Remove your memory card and insert it again. • Format your memory card.
Low Battery	Insert a charged battery or recharge the battery.
No Image File	Capture photos or insert a memory card that contains photos.
File Error	Delete the damaged file or contact a service center.
Memory Full	Delete unnecessary files or insert a new memory card.
Card Locked	You can lock SD, SDHC, SDXC, or UHS-1 card to prevent files from being deleted. Unlock the card when shooting. (p. 173)

Error messages	Suggested remedies
Folder and file number are max values. Replace the card	File names do not match the DCF standard. Transfer the files on the memory card to your computer and format the card. (p. 155)
Error 00	Turn off your camera and remount the lens. If the message still appears, contact a service center.
Error 01/02	Turn off your camera, remove the battery, and insert again. If the message still appears, contact a service center.

Maintaining the camera

Cleaning the camera

Camera lens and display

Use a brush to remove dust and wipe the lens gently with a soft cloth. If any dust remains, apply lens cleaning liquid to a piece of cleaning paper and wipe gently.

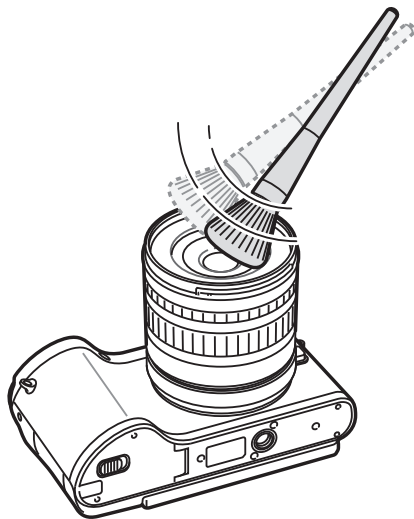

Image sensor

Depending on different shooting conditions, dust may appear in photos because the image sensor is exposed to the external environment. This problem is normal, and the exposure to dust occurs in everyday use of the camera. You can remove dust from the sensor by operating the sensor cleaning function. (p. 156) If dust remains after cleaning the sensor, contact a service center. Do not insert the blower into the mounting opening of the lens.

Camera body

Wipe gently with a soft, dry cloth.



Never use benzene, thinners, or alcohol to clean the device. These solutions can damage the camera or cause it to malfunction.

Using or storing the camera

Inappropriate places to use or store the camera

- Avoid exposing the camera to very cold or very hot temperatures.
- Avoid using your camera in areas with extremely high humidity, or where the humidity changes drastically.
- Avoid exposing the camera to direct sunlight and storing it in hot, poorly-ventilated areas, such as in a car during summer time.
- Protect your camera and the display from impact, rough handling, and excessive vibration to avoid serious damage.
- Avoid using or storing your camera in dusty, dirty, humid, or poorly-ventilated areas to prevent damage to moving parts and internal components.
- Do not use your camera near fuels, combustibles, or flammable chemicals. Do not store or carry flammable liquids, gases, or explosive materials in the same compartment as the camera or its accessories.
- Do not store the camera where there are mothballs.

Using on beaches or shores

- Protect your camera from sand and dirt when you use it on beaches or in other similar areas.
- Your camera is not waterproof. Do not handle the battery, adapter, or memory card with wet hands. Operating the camera with wet hands may cause damage to your camera.

Storing for extended period of time

- When you store the camera for an extended period, place it in a sealed container with an absorbent material, such as silica gel.
- Over time, unused batteries will discharge and must be recharged before use.
- The present date and time can be initialized when the camera is turned on after the camera and battery have been separated for a prolonged period.

Using the camera with caution in humid environments

When you transfer the camera from a cold environment to a warm one, condensation can form on the lens or internal components of the camera. In this situation, turn off the camera and wait for at least 1 hour. If condensation forms on the memory card, remove the memory card from the camera and wait until all moisture has evaporated before reinserting it.

Other cautions

- Do not swing your camera by the strap. This may cause injury to yourself or others or damage to your camera.
 - Do not paint your camera, as paint can clog moving parts and prevent proper operation.
 - Turn off the camera when not using it.
 - Your camera consists of delicate parts. Avoid impacts to the camera.
 - Protect the display from external force by keeping it in the case when not in use. Protect the camera from scratches by keeping it away from sand, sharp implements, or loose change.
 - Do not use the camera if the screen is cracked or broken. Broken glass or acrylic could cause injury to your hands and face. Take the camera to a Samsung service center to have it repaired.
 - Never place cameras, batteries, chargers, or accessories near, on, or in heating devices, such as microwave ovens, stoves, or radiators. These devices may be deformed and can overheat and cause a fire or explosion.
- Do not expose the lens to direct sunlight, as this may discolor the image sensor or cause it to malfunction.
 - Protect your lens from fingerprints and scratches. Clean your lens with a soft, clean, debris-free lens cloth.
 - The camera may turn off if impacted from the outside. This is to protect the memory card. Turn on the camera to use it again.
 - While you use the camera, it may heat up. This is normal and should not affect your camera's lifespan or performance.
 - When you use the camera in low temperatures, it may take some time to turn on, the color of the display may be changed temporarily, or after-images may appear. These conditions are not malfunctions and they will correct themselves when the camera is returned to milder temperatures.
 - Paint or metal on the outside of the camera may cause allergies, itchy skin, eczema, or swelling for people with sensitive skin. If you experience any of these symptoms, stop using the camera immediately and consult a doctor.
 - Do not insert foreign objects into any of your camera's compartments, slots, or access points. Damage due to improper use may not be covered by your warranty.
 - Do not allow unqualified personnel to service the camera or attempt to service the camera yourself. Any damage that results from unqualified service is not covered by your warranty.

About memory card

Supported memory card

This product supports SD (Secure Digital), SDHC (Secure Digital High Capacity), SDXC (Secure Digital eXtended Capacity), UHS-1 (Ultra High Speed-1), microSD, microSDHC, microSDXC, or microUHS-1 memory cards.

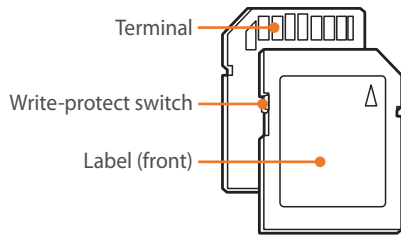

You can prevent files from being deleted by using the write-protect switch on an SD, SDHC, SDXC, or UHS-1 card. Slide the switch down to lock or slide it up to unlock. Unlock the card when capturing photos and videos.

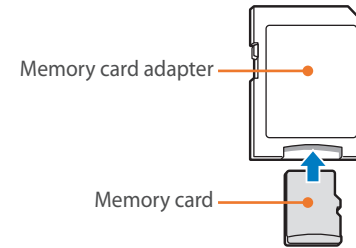

To use micro memory cards with this product, a PC, or a memory card reader, insert the card into an adapter.

Memory card capacity

The memory capacity may differ depending on shooting scenes or shooting conditions. These capacities are based on a 2 GB SD card.

	Size	Quality						
		Super Fine	Fine	Normal	RAW	RAW + S.Fine	RAW + Fine	RAW + Normal
Photo	20.0M (5472X3648)	151	179	218	69	47	49	52
	10.1M (3888X2592)	276	321	384	-	62	64	66
	5.9M (2976X1984)	423	484	565	-	71	72	74
	2.0M (1728X1152)	845	923	1,016	-	82	83	84
	Burst	479	545	631	-	-	-	-
	16.9M (5472X3080)	177	208	252	-	51	53	56
	7.8M (3712X2088)	343	396	467	-	66	68	70
	4.9M (2944X1656)	487	553	640	-	74	75	76
	2.1M (1920X1080)	827	905	999	-	82	83	84
	13.3M (3648X3648)	218	255	307	-	56	58	61
	7.0M (2640X2640)	373	429	504	-	68	70	72
	4.0M (2000X2000)	559	630	721	-	76	77	78
	1.1M (1024X1024)	1,111	1,180	1,258	-	86	86	87

	Size	Quality	
		HQ	Normal
Video	1080 60P 1920X1080 (60 fps)	Approx. 10' 10"	Approx. 12' 43"
	1080 30P 1920X1080 (30 fps)	Approx. 17' 41"	Approx. 22' 09"
	1080 * 15P 1920X1080 (15 fps)	Approx. 23' 38"	Approx. 29' 24"
	810 24P 1920X810 (24 fps)	Approx. 21' 35"	Approx. 27' 02"
	720 60P 1280X720 (60 fps)	Approx. 16' 51"	Approx. 21' 06"
	720 30P 1280X720 (30 fps)	Approx. 29' 11"	Approx. 36' 35"
	480 30P 640X480 (30 fps)	Approx. 120' 47"	Approx. 153' 30"
	240 30P For Sharing (30 fps)	Approx. 218' 48"	Approx. 278' 24"

* **1080 15P** is available only with some Smart Filter options.

- The figures above are measured without using the zoom function.
- Available recording time may vary if you use the zoom.
- Several videos were recorded in succession to determine the total recording time.
- The maximum recording time is 29 minutes and 59 seconds per file.
- The maximum playback time of For Sharing videos is 30 seconds per file.

Cautions when using memory cards

- Avoid memory cards to very cold or very hot temperatures (below 0 °C/32 °F or above 40 °C/104 °F). Extreme temperatures can cause memory cards to malfunction.
- Insert a memory card in the correct direction. Inserting a memory card in the wrong direction may damage your camera and memory card.
- Do not use memory cards that have been formatted by other cameras or by a computer. Reformat the memory card with your camera.
- Turn off the camera when you insert or remove the memory card.
- Do not remove the memory card or turn off your camera while the lamp is blinking, as this may damage your data.
- When the lifespan of a memory card has expired, you cannot store any more photos on the card. Use a new memory card.
- Do not bend, drop, or subject memory cards to heavy impact or pressure.
- Avoid using or storing memory cards near strong magnetic fields.
- Avoid using or keeping memory cards in areas with high temperature, high humidity, or corrosive substances.
- Prevent memory cards from making contact with liquids, dirt, or foreign substances. If dirty, wipe the memory card clean with a soft cloth before you insert the memory card in your camera.
- Do not allow liquids, dirt, or foreign substances to come in contact with memory cards or the memory card slot. Doing so may cause memory cards or the camera to malfunction.
- When you carry a memory card, use a case to protect the card from electrostatic discharges.
- Transfer important data to other media, such as a hard disk, CD, or DVD.
- When you use the camera for an extended period, the memory card may become warm. This is normal and does not indicate a malfunction.
- Use a memory card that meets the standard requirements.



The manufacturer is not responsible for any loss of data.

About the battery

Use only Samsung-approved batteries.

Battery specifications

Item	Description
Model	BP1130
Type	Lithium-ion battery
Cell capacity	1,130 mAh
Voltage	7.6 V
Charging time (When the battery is completely discharged)	Approx. 210 min



Personal injury or death can occur if the battery is handled carelessly or improperly. For your safety, follow these instructions for proper battery handling:

- The battery can ignite or explode if not handled properly. If you notice any deformities, cracks, or other abnormalities in the battery, immediately discontinue use of the battery and contact your manufacturer.
- Use only authentic, manufacturer-recommended battery chargers and charge the battery only by the method described in this user manual.
- Do not place the battery near heating devices or expose to excessively warm environments, such as the inside of an enclosed car in the summertime.
- Do not place the battery in a microwave oven.
- Avoid storing or using the battery in hot, humid places, such as spas or shower enclosures.

- Do not rest the device on flammable surfaces, such as bedding, carpets, or electric blankets for a prolonged period.
- When the device is switched on, do not leave it in any confined space for a prolonged period.
- Do not allow battery terminals to come in contact with metallic objects, such as necklaces, coins, keys, or watches.
- Use only authentic, manufacturer-recommended, Lithium-ion replacement batteries.
- Do not disassemble the battery or puncture the battery with any sharp object.
- Avoid exposing the battery to high pressure or crushing forces.
- Avoid exposing the battery to major impacts, such as dropping it from high places.
- Do not expose the battery to temperatures of 60 °C (140 °F) or above.
- Do not allow the battery to come in contact with moisture or liquids.
- Battery shall not be exposed to excessive heat such as sunshine, fire or the like.

Disposal guidelines

- Dispose of the battery with care.
- Do not dispose of the battery in a fire.
- Disposal regulations may differ by country or region. Dispose of the battery in accordance with all local and federal regulations.

Guidelines for charging the battery

Charge the battery only by the method described in this user manual. The battery can ignite or explode if not charged properly.

Battery life

Shooting mode	Average time / Number of photos
Photos	Approx. 175 min/Approx. 350 photos
Videos	Approx. 110 min (Record videos at 1920X1080 resolution and 60 fps.)

- The figures above are based on Samsung's test standards. Your results may differ depending on your actual usage.
- Available shooting time differs depending on background, shooting interval, and use conditions.
- Several videos were recorded in succession to determine the total recording time.

Low battery message

When the battery has fully discharged, the battery icon will turn red and the "**Low Battery**" message will appear.

Notes about using the battery

- Avoid exposing batteries to very cold or very hot temperatures (below 0 °C/32 °F or above 40 °C/104 °F). Extreme temperatures can reduce the charging capacity of your batteries.
- When you use the camera for an extended period, the area around the battery chamber may become warm. This does not affect the normal use of the camera.
- Do not pull the power supply cord to disconnect the plug from the power outlet, as this may cause a fire or electric shock.
- In temperatures below 0 °C/32 °F, battery capacity and battery life may decrease.
- Battery capacity may decrease in low temperatures, but will return to normal in milder temperatures.
- Remove the batteries from your camera when storing it for an extended period. Installed batteries may leak or corrode over time and cause serious damage to your camera. Storing the camera for extended periods with the battery installed causes the battery to discharge. You may not be able to recharge a fully discharged battery.
- When you do not use the camera for an extended period (3 months or more), check the battery and recharge it regularly. If you let the battery discharge continually, its capacity and life may decrease, which can lead to a malfunction, fire, or explosion.

Cautions about using the battery

Protect batteries, chargers, and memory cards from damage.

Prevent batteries from making contact with metal objects, as this can create a connection between the + and – terminals of your battery and lead to temporary or permanent battery damage and may cause a fire or electric shock.

Notes about charging the battery

- If the status lamp is off, make sure that the battery is inserted correctly.
- If the camera is on while charging, the battery may not fully charge. Turn off the camera before charging the battery.
- Do not use your camera when you are charging the battery. This may cause a fire or electric shock.
- Do not pull the power supply cord to disconnect the plug from the power outlet, as this may cause a fire or electric shock.
- Let the battery charge for at least 10 minutes before turning on the camera.
- If you connect the camera to an external power source when the battery is depleted, using high energy-consuming functions will cause the camera to turn off. To use the camera normally, recharge the battery.
- If you reconnect the power cable when the battery is fully charged, the status lamp turns on for approximately 30 minutes.
- Using the flash or recording videos depletes the battery quickly. Charge the battery until the red status lamp turns off.
- If the status lamp blinks in red, reconnect the cable, or remove the battery and insert it again.
- If you charge the battery when the cable is overheated or the temperature is too high, the status lamp may blink in red. Charging will start when the battery cools down.
- Overcharging batteries may shorten battery life. After charging is finished, disconnect the cable from your camera.
- Do not bend or place heavy objects on the AC cable. Doing so may damage the cable.

Notes about charging with a computer connected

- Use only the provided USB cable.
- The battery may not charge when:
 - you use a USB hub
 - other USB devices are connected to your computer
 - you connect the cable to the port on the front side of your computer
 - the USB port of your computer does not support the power output standard (5 V, 500 mA)

Handle and dispose of batteries and chargers with care

- Never dispose of batteries in a fire. Follow all local regulations when you dispose of used batteries.
- Never place batteries or cameras on or in heating devices, such as microwave ovens, stoves, or radiators. Batteries may explode when they are overheated.



Before contacting a service center

If you are having trouble with your device, try these troubleshooting solutions before contacting a service professional.



When you leave your camera at a service center, be sure to also leave the other components that may have contributed to the malfunction, such as the memory card and battery.

Situation	Suggested remedies
Cannot turn on the camera	<ul style="list-style-type: none"> • Ensure that the battery is inserted. • Ensure that the battery is inserted correctly. • Charge the battery.
The power turns off suddenly	<ul style="list-style-type: none"> • Charge the battery. • Your camera may be in Power save mode or the display turns off automatically. (p. 153) • The camera may be turned off automatically to prevent the memory card from being damaged due to excessive heat. Turn on your camera again.
The camera is losing battery power quickly	<ul style="list-style-type: none"> • The battery may lose power more quickly in low temperatures (below 0 °C/32 °F). Keep the battery warm by putting it into your pocket. • Using the flash or recording videos depletes the battery quickly. Recharge if needed. • Batteries are consumable parts that must be replaced over time. Get a new battery if the battery life is diminishing quickly.

Situation	Suggested remedies
Cannot capture photos	<ul style="list-style-type: none"> • There is no space on the memory card. Delete unnecessary files or insert a new card. • Format the memory card. • The memory card is defective. Get a new memory card. • The memory card is locked. Unlock the card. (p. 173) • Ensure that the camera is switched on. • Charge the battery. • Ensure that the battery is inserted correctly.
The camera freezes	Remove the battery and insert it again.
The camera heats up	While using the camera, it may heat up. This is normal and should not affect your camera's lifespan or performance.
The flash fires unexpectedly	The flash may fire due to static electricity. The camera is not malfunctioning.
The flash does not work	<ul style="list-style-type: none"> • The flash option may be set to Off. (p. 94) • You cannot use the flash in some modes.
The date and time are incorrect	Set the date and time under the  menu. (p. 153)
The display or buttons do not work	Remove the battery and insert it again.

Situation	Suggested remedies
The memory card has an error	<ul style="list-style-type: none"> • Turn off your camera, and then turn it on again. • Remove your memory card, and then insert it again. • Format your memory card. <p>See "Cautions when using memory cards" for more details. (p. 176)</p>
Your computer does not recognize an SDXC or UHS-1 memory card	<p>SDXC and UHS-1 memory cards use the exFAT file system. To use SDXC or UHS-1 memory cards on a Windows XP computer, download and update the exFAT file system driver from the Microsoft website.</p>
Your TV or computer cannot display photos and videos that are stored on an SDXC or UHS-1 memory card	<p>SDXC and UHS-1 memory cards use the exFAT file system. Ensure that the external device is compatible with the exFAT file system before connecting the camera to the device.</p>
Cannot display files	<p>If you change the name of a file, your camera may not play the file (the name of the file should meet the DCF standard). If you encounter this situation, display files on your computer.</p>
The photo is blurry	<ul style="list-style-type: none"> • Ensure that the focus option you set is suitable for the kind of shot you are capturing. • Use a tripod to prevent your camera from shaking. • Ensure that the lens is clean. If not, clean the lens. (p. 170)

Situation	Suggested remedies
The colors in the photo do not match the actual scene	<p>An incorrect White Balance can create unrealistic color. Select the proper White Balance option to suit the light source. (p. 76)</p>
The photo is too bright or too dark.	<p>Your photo is overexposed or underexposed.</p> <ul style="list-style-type: none"> • Adjust the aperture value or the shutter speed. • Adjust the ISO sensitivity. (p. 75) • Turn off or on the flash. (p. 94) • Adjust the exposure value. (p. 102)
Photos are distorted	<p>This camera can have minute distortion when using a wide-angle lens that enables shooting with a wide angle of view. This is normal, and does not cause malfunction.</p>
Playback screen does not appear on the connected external device	<ul style="list-style-type: none"> • Ensure that HDMI cable is properly connected to the external monitor. • Ensure that the memory card is properly recorded.
Your computer does not recognize your camera	<ul style="list-style-type: none"> • Ensure that the USB cable is connected correctly. • Ensure that your camera is switched on. • Ensure that you are using a supported operating system.
Your computer disconnects the camera while transferring files	<p>The file transfer may be interrupted by static electricity. Disconnect the USB cable and connect it again.</p>

Situation	Suggested remedies
Your computer cannot play videos	Videos may not play on some video player programs. To play video files captured with your camera, use the Multimedia Viewer program that you can install with the i-Launcher program on your computer.
i-Launcher is not functioning properly	<ul style="list-style-type: none"> • End i-Launcher and restart the program. • Depending on your computer's specifications and environment, the program may not launch automatically. In this case, click Start → All Programs → Samsung → i-Launcher → Samsung i-Launcher on your Windows computer. (For Windows 8, open Start screen, and then select All apps → Samsung i-Launcher.) Or, click Applications → Samsung → i-Launcher on your Mac OS computer.
Cannot set the DPOF for RAW files	You cannot set the DPOF for RAW files.
Auto Focus does not work	<ul style="list-style-type: none"> • Subject is not in focus. When the subject is outside the AF area, shoot by moving the subject inside the AF area and half-pressing [Shutter]. • Subject is too close. Step back from the subject and shoot. • The focus mode is set to MF. Switch the mode to AF.

Situation	Suggested remedies
AEL feature does not work	AEL feature does not work in AUTO , M , i , and S modes. Select another mode to use this feature.
Lens does not work	<ul style="list-style-type: none"> • Ensure that the lens is properly mounted. • Remove the lens from the camera and re-mount it.
External flash or GPS does not work	Ensure that the external device is properly mounted and turned on.
The date & time settings screen appears when you power on the camera	<ul style="list-style-type: none"> • Set the date and time again. • This screen appears when the camera's internal power source is completely discharged. Insert a fully charged battery and wait at least 72 hours in power off status for the internal power source to be recharged.

Camera specifications

Image Sensor	
Type	CMOS
Sensor size	23.5 X 15.7 mm
Effective pixels	Approx. 20.3 mega-pixels
Total pixels	Approx. 21.6 mega-pixels
Color filter	RGB primary color filter
Lens Mount	
Type	Samsung NX Mount
Available lens	Samsung lenses
Image Stabilization	
Type	Lens shift (depends on lens)
Mode	Off/Mode 1/Mode 2
Distortion Correct	
Off/On (depends on lens)	
i-Function	
① Depth, ① Zoom (X1.2, 1.4, 1.7, 2.0)	
Dust Reduction	
Type	Super sonic drive

Display	
Type	AMOLED with Touch Panel (C-type Touch Control Enabled)
Size	3.31" (Approx. 84.0 mm)
Resolution	WVGA (800X480) 768 k dots (PenTile)
Field of view	Approx. 100 %
Angle	Tiltable (Up 90°, Down 45°)
User display	Grid Line, Icons, Histogram, Distance Scale, Level gauge
Focusing	
Type	Phase Detection & Contrast AF
Focusing point	<ul style="list-style-type: none"> • Total AF point: 105 points (Phase Detection AF), 247 points (Contrast AF) • Selection: 1 point (Free selection) • Multi: Normal 21 (3 X 7) points (Cross point 1), Close up 35 points • Face detection: Max. 10 faces
Mode	Single AF, Continuous AF, Manual Focus, Touch AF & Shutter
AF Assist Lamp	Green LED

Shutter	
Type	Electronically controlled vertical-run focal plane shutter
Speed	<ul style="list-style-type: none"> • Auto: 1/6,000–30 sec. • Manual: 1/6,000–30 sec. (1/3 EV Step) • Bulb (time limit: 4 min)
Exposure	
Metering system	TTL 221 (17 X 13) Block segment
	Metering: Multi, Center-weighted, Spot
	Metering range: EV 0–18 (ISO100 · 30 mm, F2)
Compensation	±3 EV (1/3 EV Step)
AE lock	CUSTOM key
ISO equivalent	<ul style="list-style-type: none"> • 1 Step: Auto, ISO 100, ISO 200, ISO 400, ISO 800, ISO 1600, ISO 3200, ISO 6400, ISO 12800, ISO 25600 • 1/3 Step: Auto, ISO 100, ISO 125, ISO 160, ISO 200, ISO 250, ISO 320, ISO 400, ISO 500, ISO 640, ISO 800, ISO 1000, ISO 1250, ISO 1600, ISO 2000, ISO 2500, ISO 3200, ISO 4000, ISO 5000, ISO 6400, ISO 8000, ISO 10000, ISO 12800, ISO 16000, ISO 20000, ISO 25600

Drive Mode	
Mode	Single, Continuous, Burst (5M only), Timer, Bracket (Auto Exposure, White Balance, Picture Wizard)
Continuous shooting	<ul style="list-style-type: none"> • JPEG: High (8.6 fps), Normal (5 fps) • RAW: High (8.6 fps), Normal (5 fps)
Burst shooting	<ul style="list-style-type: none"> • 10, 15, or 30 frames per second • Up to 30 shots per shutter-press
Bracket shooting	Auto exposure bracketing (±3 EV), White Balance bracketing, Picture Wizard bracketing
Self-timer	2–30 sec. (1 second interval)
Shutter release	SR2NX02 (via Micro USB port) (optional)
Flash	
Type	External Flash (Bundle with SEF8A)
Mode	Smart Flash, Auto, Auto Red-eye, Fill in, Fill-in Red, 1st Curtain, 2nd Curtain, Off
Guide number	8 (based on ISO 100) (SEF8A)
Angle of view	28 mm (35 mm film equivalent)
Sync speed	Less than 1/180 sec.

Flash EV	-2+2 EV (0.5 EV Step)
External flash	Optional Samsung external flashes: SEF42A, SEF220A
Sync terminal	Hot-shoe
White Balance	
Mode	Auto WB, Daylight, Cloudy, Fluorescent White, Fluorescent NW, Fluorescent Daylight, Tungsten, Flash WB, Custom Set, Color Temperature (Manual)
Micro adjustment	Amber/Blue/Green/Magenta 7 steps respectively
Dynamic Range	
Off/Smart Range+/HDR	
Picture Wizard	
Mode	Standard, Vivid, Portrait, Landscape, Forest, Retro, Cool, Calm, Classic, Custom1, Custom2, Custom3
Parameter	Color, Saturation, Sharpness, Contrast
Shooting	
Mode	Smart Auto, Program, Aperture Priority, Shutter Priority, Manual, Lens Priority, Smart

Smart mode	Beauty Face, Best Face, Landscape, Macro, Action Freeze, Rich Tones, Panorama, Waterfall, Silhouette, Sunset, Night, Fireworks, Light Trace, Creative Shot
Smart Filter	Vignetting, Miniature, Colored Pencil, Watercolor, Wash drawing, Oil Sketch, Ink Sketch, Acryl, Negative, Red, Green, Blue, Yellow
Size	<ul style="list-style-type: none"> • JPEG (3:2): 20.0M (5472X3648), 10.1M (3888X2592), 5.9M (2976X1984), 5.0M (2736X1824) (Burst mode only), 2.0M (1728X1152) • JPEG (16:9): 16.9M (5472X3080), 7.8M (3712X2088), 4.9M (2944X1656), 2.1M (1920X1080) • JPEG (1:1): 13.3M (3648X3648), 7.0M (2640X2640), 4.0M (2000X2000), 1.1M (1024X1024) • RAW: 20.0M (5472X3648) * 3D mode with 3D lens is available only with JPEG (16:9) 4.1M (2688X1512) or 2.1M (1920X1080).
Quality	Super Fine, Fine, Normal
RAW standard	SRW (ver.2.0.0)
Color space	sRGB, Adobe RGB

Video	
Type	MP4 (H.264)
Format	Movie: H.264, Sound: AAC
Movie AE mode	Program, Aperture Priority, Shutter Priority, Manual
Movie clip	Audio on/off (Shooting time: Max. 29' 59")
Smart Filter	Vignetting, Miniature, Colored Pencil, Watercolor, Wash drawing, Oil Sketch, Ink Sketch, Acryl, Negative, Red, Green, Blue, Yellow
Size	1920X1080, 1920X810, 1280X720, 640X480, 320X240 (For Sharing)
Frame rate	60 fps, 30 fps, 24 fps (available only with 1920X810), 15 fps (available only with some Smart Filter options)
Multi Motion	x0.25 (640X480, 320X240 only), x0.5 (1280X720 (30 fps), 640X480, 320X240 only), x1, x5, x10, x20
Quality	HQ, Normal
Sound	Stereo
Edit	Still image capture, Time trimming

Playback	
Type	Single image, Thumbnails (15/28), Slide show, Movie
Edit	Smart Filter, Red-eye Fix, Backlight, Resize, Rotate, Face Retouch, Brightness, Contrast
Smart filter	Vignetting, Miniature, Colored Pencil, Watercolor, Wash drawing, Oil Sketch, Ink Sketch, Acryl, Negative, Red, Green, Blue, Yellow
Smart filter size	<ul style="list-style-type: none"> • JPEG (3:2): 5.9M (2976X1984), 5.0M (2736X1824), 2.0M (1728X1152) • JPEG (16:9): 6.2M (3328X1872), 4.9M (2944X1656), 2.1M (1920X1080) • JPEG (1:1): 6.0M (2448X2448), 4.0M (2000X2000), 1.1M (1024X1024)
Storage	
Media	External memory (optional): SD card, SDHC card, SDXC card, UHS-1 card (Class 6 and above recommended)
File format	RAW (SRW (ver.2.0.0)), JPEG (EXIF 2.21), MPO (3D), DCF, DPOF 1.1
GPS	
Type	Geo-tagging with an optional GPS Module (WGS 84)
Feature	Location name (English and Korean only)

Wireless network	
Type	IEEE 802.11b/g/n support Dual Band
Function	MobileLink, Remote Viewfinder, Auto Backup, Email, SNS & Cloud, AllShare Play, AutoShare, Wi-Fi Direct
NFC	
Yes	
Interface	
Digital output	USB 2.0 (micro USB jack)
Video output	<ul style="list-style-type: none"> • NTSC, PAL (selectable) • HDMI
External release	Yes (micro USB)
External microphone	Yes
DC power input	DC 5.0V, 1A via micro USB

Power Source	
Type	Rechargeable battery: BP1130 (1,130 mAh) * The power source may differ depending on your region.
Dimensions (W X H X D)	
122 X 63.7 X 40.7 mm (without protrusions)	
Weight	
284 g (without battery and memory card)	
Operating Temperature	
0–40 °C	
Operating Humidity	
5–85 %	
Software	
i-Launcher, Adobe Photoshop Lightroom	

* Specifications may change without notice to improve performance.

* Other brands and products names are trademarks of respective owners.

AP (Access Point)

An access point is a device that allows wireless devices to connect to a wired network.

Ad-Hoc network

An ad-hoc network is a temporary connection for sharing files or an internet connection and between computers and devices.

AdobeRGB

Adobe RGB is used for commercial printing and has a larger color range than sRGB. Its wider range of colors helps you to easily edit photos on a computer.

AEB (Auto Exposure Bracket)

This feature automatically captures several images at different exposures to help you capture a properly-exposed image.

AEL/AFL (Auto Exposure Lock/Auto Focus Lock)

These features help you lock the exposure or focus on which you want to focus or calculate the exposure.

AF (Auto Focus)

A system that automatically focuses the camera lens on the subject. Your camera uses the contrast to focus automatically.

AMOLED (Active-matrix organic light-emitting diode) / LCD (Liquid Crystal Display)

AMOLED is a visual display that is very thin and light, as it does not need backlighting. LCD is a visual display commonly used in consumer electronics. This display needs a separate backlight, such as CCFL or LED, to reproduce colors.

Aperture

The aperture controls the amount of light that reaches the camera's sensor.

Camera shake (Blur)

If the camera is moved while the shutter is open, the entire image may appear blurred. This occurs more often when the shutter speed is slow. Prevent camera shake by raising the sensitivity, using the flash, or using a faster shutter speed. Alternatively, use a tripod or the OIS function to stabilize the camera.

Cloud Computing

Cloud computing is a technology that allows you to store data on remote servers and to use them from a device with internet access.

Color space

The range of colors that the camera can see.

Color temperature

Color Temperature is a measurement in degrees Kelvin (K) that indicates the hue of a specific type of light source. As the color temperature increases, the color of the light source has a more bluish quality. As the color temperature decreases, the color of the light source has a more reddish quality. At 5,500 degrees Kelvin, the color of the light source is similar to the sun at midday.

Composition

Composition in photography means arranging objects in a photo. Usually, abiding by the rule of thirds leads to a good composition.

DCF (Design rule for Camera File system)

A specification to define a file format and file system for digital cameras created by the Japan Electronics and Information Technology Industries Association (JEITA).

Depth of field

The distance between the nearest and farthest points that can be acceptably focused in a photograph. Depth of field varies with lens aperture, focal length, and distance from the camera to the subject. Selecting a smaller aperture, for example, will increase the depth of field and blur the background of a composition.

DPOF (Digital Print Order Format)

A format for writing printing information, such as selected images and number of prints, on a memory card. DPOF-compatible printers, sometimes available at photo shops, can read the information from the card for convenient printing.

EV (Exposure Value)

All the combinations of the camera's shutter speed and lens aperture that result in the same exposure.

EV Compensation

This feature allows you to quickly adjust the exposure value measured by the camera, in limited increments, to improve the exposure of your photos.

Exif (Exchangeable Image File Format)

A specification to define an image file format for digital cameras created by the Japan Electronic Industries Development Association (JEIDA).

Exposure

The amount of light allowed to reach the camera's sensor. Exposure is controlled by a combination of the shutter speed, the aperture value, and ISO sensitivity.

Flash

A speed light that helps to create adequate exposure in low-light conditions.

Focal length

The distance from the middle of the lens to its focal point(in millimeters). Longer focal lengths result in narrower angles of view and the subject is magnified. Shorter focal lengths result in wider angles of view.

Histogram

A graphical representation of the brightness of an image. The horizontal axis represents the brightness and the vertical axis represents the number of pixels. High points at the left (too dark) and right (too bright) on the histogram indicate a photo that is improperly exposed.

H.264/MPEG-4

A high-compression video format established by international standard organizations ISO-IEC and ITU-T. This codec is capable of providing good video quality at low bit rates developed by the Joint Video Team (JVT).

Image sensor

The physical part of a digital camera that contains a photosite for each pixel in the image. Each photosite records the brightness of the light that strikes it during an exposure. Common sensor types are CCD (Charge-coupled Device) and CMOS (Complementary Metal Oxide Semiconductor).

IP (Internet protocol) address

An IP address is a unique number that is assigned to every device that is connected to the internet.

ISO sensitivity

The sensitivity of the camera to light, based on the equivalent film speed used in a film camera. At higher ISO sensitivity settings, the camera uses a higher shutter speed, which can reduce blur caused by camera shake and low light. However, images with high sensitivity are more susceptible to noise.

JPEG (Joint Photographic Experts Group)

A lossy method of compression for digital images. JPEG images are compressed to reduce their overall file size with minimal deterioration of the image resolution.

Metering

The metering refers to the way in which the camera measures the quantity of light to set the exposure.

MF (Manual Focus)

A system that manually focuses the camera lens on the subject. You can use the focus ring to focus on a subject.

MJPEG (Motion JPEG)

A video format which is compressed as a JPEG image.

MPO (Multi Picture Object)

An image file format that contains multiple images in a file. An MPO file provides a 3D effect on MPO-compatible displays, such as 3D TVs or 3D monitors.

Noise

Misinterpreted pixels in a digital image that may appear as misplaced or random, bright pixels. Noise usually occurs when photos are shot with a high sensitivity or when a sensitivity is automatically set in a dark place.

NFC (Near Field Communication)

NFC is a set of standards for radio communication at very close proximity. You can use NFC-enabled devices to activate features or exchange data with other devices.

NTSC (National Television System Committee)

A video color encoding standard used most commonly in Japan, North America, the Philippines, South America, South Korea, and Taiwan.

Optical zoom

This is a general zoom which can enlarge images with a lens and does not deteriorate quality of images.

PAL (Phase Alternate Line)

A video color encoding standard used in numerous countries throughout Africa, Asia, Europe, and the Middle East.

Quality

An expression of the rate of compression used in a digital image. Higher quality images have a lower rate of compression, which usually results in a larger file size.

RAW (CCD raw data)

The original, unprocessed data, collected directly from the camera's image sensor. White Balance, contrast, saturation, sharpness, and other data can be manipulated with editing software before the image is compressed into a standard file format.

Resolution

The number of pixels present in a digital image. High resolution images contain more pixels and typically show more detail than low resolution images.

Shutter speed

Shutter speed refers to the amount of time it takes to open and close the shutter, and it is an important factor in the brightness of a photo, as it controls the amount of light which passes through the aperture before it reaches the image sensor. A fast shutter speed allows less time to let light in and the photo becomes darker and more easily freezes subjects in motion.

sRGB (Standard RGB)

International standard of color space established by the IEC (International Electrotechnical Commission). This is defined from color space for PC monitors and is also used as the standard color space for Exif.

Vignetting

A reduction of an image's brightness or saturation at the periphery (outer edges) compared to the center of the image. Vignetting can draw interest to subjects positioned in the center of an image.

White Balance (Color balance)

An adjustment of the intensities of colors (typically the primary colors red, green, and blue), in an image. The goal of adjusting the White Balance, or color balance, is to correctly render the colors in an image.







Wi-Fi





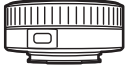

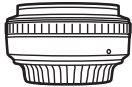
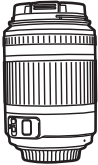
Wi-Fi is a technology that allows electronic devices to exchange data wirelessly over a network.

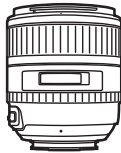
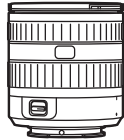

WPS (Wi-Fi Protected Setup)

WPS is a technology that secures wireless home networks.

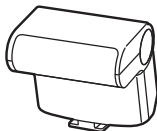
Optional accessories

Lens	
 <p>SAMSUNG 18-55 mm F3.5-5.6 OIS III</p>	 <p>SAMSUNG 20-50 mm F3.5-5.6 ED II</p>
 <p>SAMSUNG 16 mm F2.4</p>	 <p>SAMSUNG 20 mm F2.8</p>
 <p>SAMSUNG 30 mm F2</p>	 <p>SAMSUNG 50-200 mm F4-5.6 ED OIS III</p>
 <p>SAMSUNG 60 mm F2.8 Macro ED OIS SSA</p>	 <p>SAMSUNG 18-200 mm F3.5-6.3 ED OIS</p>

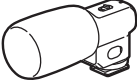
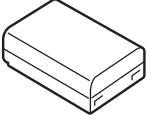
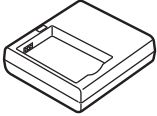
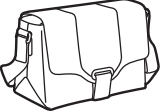
Lens	
 <p>SAMSUNG 85 mm F1.4 ED SSA</p>	 <p>SAMSUNG 12-24 mm F4-5.6 ED</p>
 <p>SAMSUNG 45 mm F1.8</p>	 <p>SAMSUNG 45 mm F1.8 [T6] 2D/3D</p>
External flash	
 <p>SEF42A</p>	 <p>SEF220A</p>
GPS	
 <p>GPS10</p>	

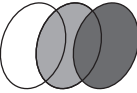
Shutter release (micro USB type)	Microphone
 <p data-bbox="266 432 370 455">SR2NX02</p>	 <p data-bbox="699 432 763 455">EM10</p>
Rechargeable battery	Battery charger
 <p data-bbox="274 683 369 706">BP1130</p>	 <p data-bbox="680 683 788 706">BC3NX01</p>
Camera bag	Camera case
	
Memory card	Filter
	

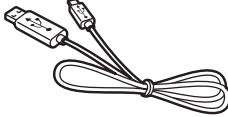
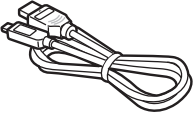
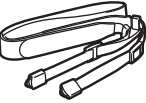
USB cable	HDMI cable
	
Strap	
	



- These illustrations may differ from your actual items. Refer to the user manuals of these optional accessories for details.
- Use only Samsung-approved accessories. Samsung is not responsible for damage caused by using another manufacturer's accessories.

A

Adobe Photoshop Lightroom 167

AllShare Play 141

Aperture 16, 20

Auto Backup 133

Auto focus 80

B

Battery

Caution 177

Charging 34

Insert 33

Best Face mode 65

Bracketing 92

C

Camera

Connecting as removable disk 160

Connecting to PC 160

Disconnecting (Windows) 161

Layout 30

Camera specifications 184

Charging 34

Color space 148

D

Date & Time 153

Depth of Field (DOF) 17, 22

Digital Print Order Format
(DPOF) 114

DIRECT LINK 32

Display brightness 152

Display type 43

Drive 90

E

Enlarging 113

Exposure Value (EV) 16, 102

F

Fader 105

Files

Deleting 111

Photo type 74

Protecting 110

Video type 104

Flash

Bounce photography 27

Flash options 94

Guide number 26

Intensity 95

F-number 16

Focal length 21

Focus assist 88

Focus Peaking 88

I

Icons

Playback mode 42

Shooting mode 40

i-Function 61

i-Launcher 163

Image adjustment

Adjusting photos 119

Red-eye 120

Retouching faces 120

ISO sensitivity 75

i-Zoom 63

L

Lenses

Layout 44

Locking 45

Markings 47

Unlocking 46

M

Maintenance 170

Memory card

Caution 173

Insert 33

Metering 97

MobileLink 129

O

One touch shot 87

Optical Image Stabilization (OIS) 89

Optional accessories

- Attach the GPS module 51
- Connect the flash 49
- Flash layout 48
- GPS module layout 51

P

Panorama mode 66

Photos

- Editing 117
- Enlarging 113
- Shooting options 73
- Viewing on 3D TV 159
- Viewing on camera 108
- Viewing on HDTV 158

Picture Wizard 79

Posture 13

Power save mode 153

R

Red-eye effect

- Playback mode 120
- Shooting mode 95

Remote Viewfinder 131

Resolution

- Playback mode 118
- Shooting mode (Movie) 104
- Shooting mode (Photo) 73

Retouching faces 120

Rotating 118

Rule of thirds 24

S

Service center 181

Settings 152

Shooting modes

- Aperture Priority 57
- Lens Priority 60
- Manual 59
- Program 56
- Recording 68
- Shutter Priority 58
- Smart 64
- Smart Auto 54

Shutter speed 18, 20

Slide show 113

Smart filter

- Playback mode 121
- Shooting mode 101

Smart panel 38

T

Thumbnails 108

Timer 91

Touch AF 86

Touch screen 36

Tracking AF 86

Transferring files

- Mac 161
- Windows 160

TV 158

U

Unpacking 29

V

Video Out 153

Videos

- Capturing 116
- Options 104
- Recording 68
- Viewing 115

W

White balance 76

Wireless network 123

3

3D mode 69



**Correct Disposal of This Product
(Waste Electrical & Electronic Equipment)**

(Applicable in countries with separate collection systems)

This marking on the product, accessories or literature indicates that the product and its electronic accessories (e.g. charger, headset, USB cable) should not be disposed of with other household waste at the end of their working life. To prevent possible harm to the environment or human health from uncontrolled waste disposal, please separate these items from other types of waste and recycle them responsibly to promote the sustainable reuse of material resources.

Household users should contact either the retailer where they purchased this product, or their local government office, for details of where and how they can take these items for environmentally safe recycling.

Business users should contact their supplier and check the terms and conditions of the purchase contract. This product and its electronic accessories should not be mixed with other commercial wastes for disposal.



Correct disposal of batteries in this product

(Applicable in countries with separate collection systems)

This marking on the battery, manual or packaging indicates that the batteries in this product should not be disposed of with other household waste at the end of their working life. Where marked, the chemical symbols Hg, Cd or Pb indicate that the battery contains mercury, cadmium or lead above the reference levels in EC Directive 2006/66. If batteries are not properly disposed of, these substances can cause harm to human health or the environment.

To protect natural resources and to promote material reuse, please separate batteries from other types of waste and recycle them through your local, free battery return system.

CAN ICES-3 (B)/NMB-3(B)

Dispose unwanted electronics through an approved recycler.
To find the nearest recycling location, go to our website:
www.samsung.com/recyclingdirect Or call, (877) 278 - 0799

FCC notice

Caution:

Any changes or modifications in construction of this device which are not expressly approved by the party responsible for compliance could void the user's authority to operate the equipment.

NOTE:

This equipment has been tested and found to comply with the limits for a Class B digital device, pursuant to part 15 of the FCC Rules. These limits are designed to provide reasonable protection against harmful interference in a residential installation. This equipment generates, uses and can radiate radio frequency energy and, if not installed and used in accordance with the instructions, may cause harmful interference to radio communications. However, there is no guarantee that interference will not occur in a particular installation. If this equipment does cause harmful interference to radio or television reception, which can be determined by turning the equipment off and on, the user is encouraged to try to correct the interference by one or more of the following measures:

- Reorientate or relocate the receiving antenna.
- Increase the distance between the equipment and receiver.
- Connect the equipment into an outlet on a circuit different from that to which the receiver is connected.
- Consult the dealer or an experienced radio/TV technician for help.

Declaration of Conformity

Trade Name : Samsung Electronics America, Inc.
Model No. : Samsung NX300
Responsible Party : Samsung Electronics America, Inc.
Address : 85 Challenger Road, Ridgefield Park, NJ 07660
Telephone No. : 1-800-SAMSUNG (726-7864)

This device complies with Part 15 of the FCC Rules.

Operation is subject to the following two conditions:

(1) This device may not cause harmful interference, and (2) this device must accept any interference received, including interference that may cause undesired operation.



This device complies with part 15 of the FCC Rules. Operation is subject to the following two conditions: (1) This device may not cause harmful interference, and (2) this device must accept any interference received, including interference that may cause undesired operation.

RF exposure statements:

This device is for handheld operation only. The antenna(s) used for this transmitter must be installed to provide a separation distance of at least 20 cm from all persons and must not be co-located or operating in conjunction with any other antenna or transmitter.

CAUTION

**RISK OF EXPLOSION IF BATTERY IS REPLACED BY
AN INCORRECT TYPE.
DISPOSE OF USED BATTERIES ACCORDING
TO THE INSTRUCTIONS.**

Operation is subject to the following two conditions:

(1) This device may not cause harmful interference, and
(2) This device must accept any interference received,
including interference that may cause undesired operation.

Caution:

Any changes or modifications to the equipment not expressly
approved by the party responsible for compliance could void
user's authority to operate the equipment.

IC: 649E-NX300

This equipment may be operated in all EU countries.
In France, this equipment may only be used indoors.

Complies with
IDA Standards
DA100790



NTC

Type Approved
No.: ESD-1306913C



TA-2012/1802
APPROVED

28277/SDPPI/2013
1760

TRC/SS/2013/17



Model : NX300
Year of Manufacture : 2013



Please refer to the warranty that came with your product
or visit our website www.samsung.com for after-sales service or inquiries.

