

Canon

PUB. DIE-0414-000

HD Camcorder
Instruction Manual

LEGRIA
HFR36

LEGRIA
HFR37

LEGRIA
HFR38

LEGRIA
HFR306



PAL



HDMI AVCHD™ MP4



HFR38 HFR37 HFR36

Important Usage Instructions

COPYRIGHT WARNING:

Unauthorized recording of copyrighted materials may infringe on the rights of copyright owners and be contrary to copyright laws.

To reduce the risk of electric shock, do not expose this product to dripping or splashing.

The Mains plug is used as the disconnect device. The Mains plug shall remain readily operable to disconnect the plug in case of an accident.

While using the compact power adapter, do not wrap it or cover it with a piece of cloth, and do not place it in confined narrow spaces.

CA-110E identification plate is located on the bottom.

European Union (and EEA) only.



These symbols indicate that this product is not to be disposed of with your household waste, according to the WEEE Directive (2002/96/EC), the Battery Directive (2006/66/EC) and/or your national laws implementing those Directives.

This product should be handed over to a designated collection point, e.g., on an authorized one-for-one basis when you buy a new similar product or to an authorized collection site for recycling waste electrical and electronic equipment (EEE) and batteries and accumulators. Improper handling of this type of waste could have a possible impact on the environment and human health due to potentially hazardous substances that are generally associated with EEE. Your cooperation in the correct disposal of this product will contribute to the effective usage of natural resources.

For more information about the recycling of this product, please contact your local city office, waste authority, approved scheme or your household waste disposal service or visit www.canon-europe.com/environment.

(EEA: Norway, Iceland and Liechtenstein)

REGIONS OF USE

LEGRIA HF R38, LEGRIA HF R37 and LEGRIA HF R36 are in compliance (as of January 2012) with the radio signal regulations of the regions listed below. For details on other regions where they can be used, make inquiries with the contacts listed on the back side of this instruction manual.

REGIONS

Australia, Austria, Belgium, Bulgaria, China (PRC mainland), Cyprus, Czech Republic, Denmark, Estonia, Finland, France*, Germany, Greece, Hong Kong S.A.R., Hungary, Iceland, Ireland, Italy, Latvia, Liechtenstein, Lithuania, Luxembourg, Malta, Netherlands, New Zealand, Norway, Poland, Portugal, Romania, Russia, Singapore, Slovakia, Slovenia, Spain, Sweden, Switzerland, United Kingdom

* France: Cannot be used outdoors.

Statement on EC directive



Hereby, Canon Inc., declares that this WM217 is in compliance with the essential requirements and other relevant provisions of Directive 1999/5/EC.

Please contact the following address for the original Declaration of Conformity:

CANON EUROPA N.V.

Bovenkerkerweg 59-61, 1158 XB Amstelveen, The Netherlands

CANON INC.

30-2, Shimomaruko 3-chome, Ohta-ku, Tokyo 146-8501, Japan

Model

ID0003: LEGRIA HF R36 / LEGRIA HF R37 / LEGRIA HF R38

Trademark Acknowledgements

- SD, SDHC and SDXC Logos are trademarks of SD-3C, LLC.
- Microsoft and Windows are trademarks or registered trademarks of Microsoft Corporation in the United States and/or other countries.
- App Store, iPhone, iTunes, Mac OS and Macintosh are trademarks of Apple Inc., registered in the U.S. and other countries.
- “x.v.Color” and the “x.v.Color” logo are trademarks.
- HDMI, the HDMI logo and High-Definition Multimedia Interface are trademarks or registered trademarks of HDMI Licensing LLC in the United States and other countries.
- “AVCHD” and the “AVCHD” logo are trademarks of Panasonic Corporation and Sony Corporation.
- Manufactured under license from Dolby Laboratories. “Dolby” and the double-D symbol are trademarks of Dolby Laboratories.
- YouTube is a trademark of Google Inc.
- Facebook is a registered trademark of Facebook, Inc.
- Wi-Fi is a registered trademark of the Wi-Fi Alliance.
- Wi-Fi Certified, WPA, WPA2, and the Wi-Fi Certified logo are trademarks of the Wi-Fi Alliance.
- WPS as used on the camcorder’s settings, onscreen displays and in this manual signifies Wi-Fi Protected Setup.
- DLNA, the DLNA Logo and DLNA CERTIFIED are trademarks, service marks, or certification marks of the Digital Living Network Alliance.
- Other names and products not mentioned above may be trademarks or registered trademarks of their respective companies.
- This device incorporates exFAT technology licensed from Microsoft.
- “Full HD 1080” refers to Canon camcorders compliant with high-definition video composed of 1,080 vertical pixels (scanning lines).
- ANY USE OF THIS PRODUCT OTHER THAN CONSUMER PERSONAL USE IN ANY MANNER THAT COMPLIES WITH THE MPEG-2 STANDARD FOR ENCODING VIDEO INFORMATION FOR PACKAGED MEDIA IS EXPRESSLY PROHIBITED WITHOUT A LICENSE UNDER APPLICABLE PATENTS IN THE MPEG-2 PATENT PORTFOLIO, WHICH LICENSE IS AVAILABLE FROM MPEG LA, L.L.C., 250 STEELE STREET, SUITE 300, DENVER, COLORADO 80206.
- This product is licensed under AT&T patents for the MPEG-4 standard and may be used for encoding MPEG-4 compliant video and/or decoding MPEG-4 compliant video that was encoded only (1) for a personal and non-commercial purpose or (2) by a video provider licensed under the AT&T patents to provide MPEG-4 compliant video. No license is granted or implied for any other use for MPEG-4 standard.



Exciting Features and New Functions



HFR38 / HFR37 / HFR36



Wi-Fi Functions

(📖 147)

Enjoy the freedom of Wi-Fi functions by making your camcorder an active part of your Wi-Fi home network or by conveniently accessing Wi-Fi hotspots to upload your videos wherever you may be.

- You can save your recordings wirelessly to a computer in your home network using the supplied software **Network Utility** (📖 154). You can also send your recordings wirelessly to an FTP server (📖 154), for example to send your videos from your vacation spot to a network-attached storage drive back home.
- You can upload your recordings wirelessly, directly from your camcorder to YouTube and Facebook (📖 158).
- You can play back the recordings in your camcorder from DLNA-compatible TV sets and other DLNA media players connected to your home network (📖 162).

Story Creator (📖 67)



Transform your movies into compelling video stories just by recording video following simple pre-scripted suggestions, optimized for various scenarios.

Cinema-Look Filters

(📖 70)



Use professional cinema-look filters to create unique movies with distinctive looks.

AVCHD and MP4 Recording (📖 30)

AVCHD



Record movies in AVCHD and play them back on an HDTV in all their splendor. Alternatively, record movies in MP4 for uploading to the Web and transferring to mobile devices.



Smart AUTO (📖 45)

Smart AUTO automatically selects the best scene mode for the scene you want to shoot. You get spectacular recordings every time without worrying about settings.



Video Snapshot (📖 72)

Shoot or capture short scenes and arrange them into a video clip set to your favorite background music.

Face Detection (📖 99)



The camcorder automatically detects people's faces and adjusts the focus and other settings accordingly for beautiful results.

HFR38 / HFR37 / HFR36

Memory Save (📖 134)

Easily save the whole content of the built-in memory or a memory card onto an external hard drive connected directly to the camcorder. With no need for a computer, this is a very convenient way to save backup copies of your recordings.

Image Stabilization



Dynamic IS (📖 97) compensates for camcorder shake when you shoot video while walking. Powered IS (📖 97) will produce stable shots when you zoom in on distant subjects (full telephoto). Intelligent IS (📖 47) selects the type of image stabilization for the recording situation.

Enjoying Your Recordings on Other Devices

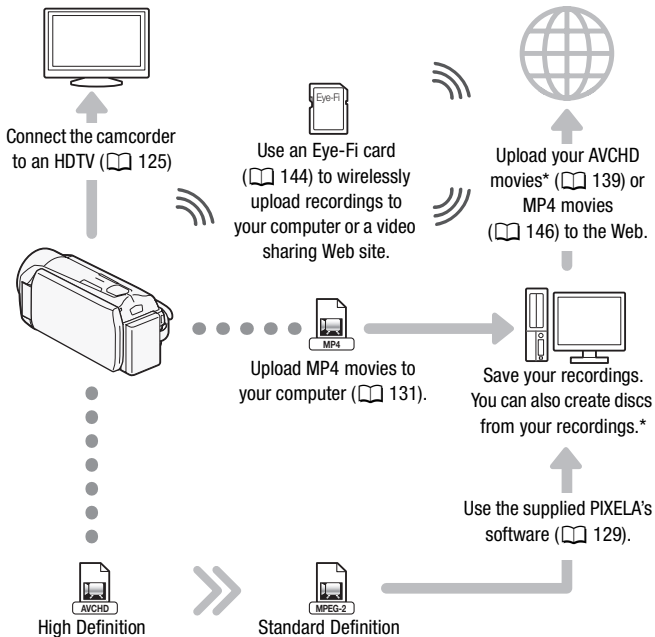

Upload AVCHD movies to your computer (129).

HFR38 / HFR37 / HFR36 You can also choose to convert your AVCHD movies to standard definition files (139) before uploading.

* **HFR38 / HFR37 / HFR36** only.

Enjoying Your Recordings Using the Camcorder's Wi-Fi Functions

DLNA AVCHD



Play video wirelessly directly from the memory on AVCHD- and DLNA-compatible HDTVs and other devices connected to the network (📖 162).

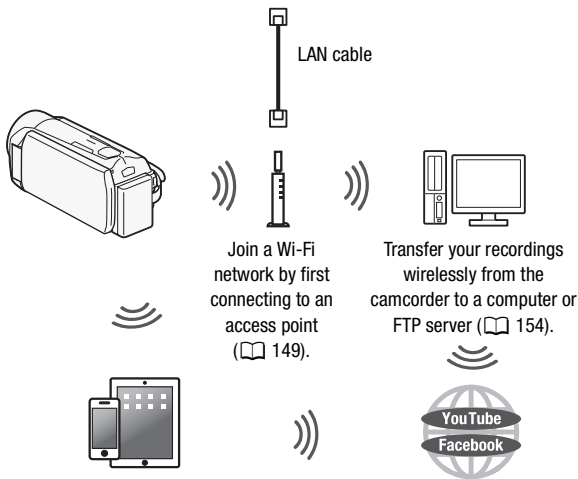

Wirelessly connect to a Wi-Fi-enabled iOS device like an iPhone to upload your recordings (📖 159). Because you do not need to be near your home network, you can even upload videos while traveling!

Upload your recordings wirelessly to YouTube and Facebook (📖 158) to share your videos with friends and family.

Table of contents

■ Introduction

- 5 Exciting Features and New Functions
- 13 About this Manual
- 15 Getting to Know the Camcorder**
- 15 Supplied Accessories and CD-ROMs
- 17 Names of Parts

■ Preparations

19 Getting Started

- 19 Charging the Battery Pack
- 22 Using the Grip Belt
- 23 Opening the Lens Cover and Adjusting the LCD Screen

25 Basic Operation of the Camcorder

- 25 Using the Touch Screen
- 26 Using the Menus
- 30 Operating Modes

33 First Time Settings

- 33 Setting the Date and Time
- 34 Changing the Language
- 35 Changing the Time Zone

36 Using a Memory Card

- 36 Memory Cards Compatible for Use with the Camcorder
- 38 Inserting and Removing a Memory Card
- 39 **HFR38/HFR37/HFR36** Selecting the Memory (Built-in Memory/Memory Card) for the Recordings
- 40 **HFR38/HFR37/HFR36** Relay Recording
- 41 Initializing the Memory

■ **AUTO Mode**

43 Basic Recording

- 43 Shooting Video and Taking Photos in AUTO Mode
- 45 About the Smart AUTO function
- 47 Intelligent IS
- 49 Zooming
- 51 Quick Start

■ **Video**

53 Basic Playback

- 53 Playing Back Video
- 57 3D Flip View
- 58 The [Index Selection] Screen: Selecting the Content to Play Back
- 60 Deleting Scenes and Stories
- 64 Selecting the Playback Starting Point
- 66 Onscreen Displays and Data Code

67 Video Stories and Cinema Style

- 67 Using Story Creator to Create Compelling Stories
- 70 Cinema Mode and Cinema-Look Filters
- 72 Video Snapshot
- 73 Decoration: Adding a Personal Touch
- 78 Playing Back Stories from the Gallery
- 80 Rating Scenes
- 82 Playback with Background Music
- 85 Copying and Moving Scenes Within/Between Stories
- 86 Selecting a Story's Thumbnail Image
- 87 Changing a Story's Title

89 Advanced Functions

- 89 Recording in Manual Mode
- 91 Selecting the Video Quality (Recording Mode)
- 94 Selecting the Frame Rate
- 94 Special Scene Recording Programs and Programmed AE
- 97 Advanced Image Stabilization
 - 97 Powered IS
- 98 Pre-Recording
- 99 Face Detection

- 100 Touch & Track
- 101 Faders
- 102 Manual Exposure Adjustment
- 104 Manual Focus Adjustment
- 105 Tele Macro
- 106 White Balance
- 108 Self Timer
- 109 Audio Recording Level
- 110 Using Headphones
- 112 Capturing Video Snapshot Scenes and Photos from a Movie
- 114 Dividing Scenes

■ Photos

- 116 Viewing Photos
- 118 Deleting Photos
- 120 Slideshow

■ External Connections

- 121 Terminals on the Camcorder**
 - 122 Connection Diagrams
- 125 Playback on a TV Screen**
- 126 Saving and Sharing Your Recordings**
 - 126 **HFR38/HFR37/HFR36** Copying Movies and Photos to a Memory Card
 - 129 Saving Recordings on a Computer
 - 134 **HFR38/HFR37/HFR36** Memory Save: Saving an Entire Memory onto an External Hard Drive
 - 138 Copying Recordings to an External Video Recorder
 - 139 **HFR38/HFR37/HFR36** Uploading AVCHD Movies to the Web
 - 146 Uploading MP4 Movies and Photos to the Web

■ **HFR38 / HFR37 / HFR36 Wi-Fi Functions**

- 147 Introduction to Wi-Fi
- 149 Connecting to a Wi-Fi Network
- 154 Transferring Files to a Computer or FTP Server
- 158 Uploading Recordings to YouTube and Facebook
- 159 Uploading Videos Using an iOS Device
- 162 Wireless Playback on a DLNA-Compatible Device

■ **Additional Information**

166 Appendix: Menu Options Lists

- 166 [Main Functions] Panel
- 170 [Other Settings] Menu

181 Appendix: Onscreen Icons and Displays

186 Trouble?

- 186 Troubleshooting
- 194 List of Messages

204 Do's and Don'ts

- 204 Handling Precautions
- 208 Maintenance/Others
- 209 Using the Camcorder Abroad





210 General Information

- 210 Accessories
- 211 Optional Accessories
- 215 Specifications
- 219 Index

About this Manual

Thank you for purchasing the Canon LEGRIA HF R38 / LEGRIA HF R37 / LEGRIA HF R36 / LEGRIA HF R306. Please read this manual carefully before you use the camcorder and retain it for future reference. Should your camcorder fail to operate correctly, refer to *Troubleshooting* (📖 186).

Conventions Used in this Manual

-  **IMPORTANT:** Precautions related to the camcorder's operation.
-  **NOTES:** Additional topics that complement the basic operating procedures.
-  **POINTS TO CHECK:** Restrictions or requirements regarding the function described.
- : Reference page number within this manual.
- **HF R38**: Text that applies only to the models shown in the icon.
- The following terms are used in this manual:
 - When not specified as “memory card” or “built-in memory”, the term “memory” by itself refers to both.
 - “Scene” refers to one movie unit from the point you press the  button to start recording until you press again to pause the recording.
- The photos included in this manual are simulated pictures taken with a still camera. Unless indicated otherwise, illustrations and menu icons refer to the **HF R38**.

AUTO indicates that a function is available in the operating mode indicated and **AUTO** indicates that the function is not available. The operating mode icons are divided into three groups: the first three icons represent the camera mode, the second three icons represent the recording standard, and the last two represent playback modes. For a detailed explanation refer to *Operating Modes* (📖 30).

Brackets [] are used to refer to control buttons and menu options you will touch on the screen and to other onscreen messages and displays.

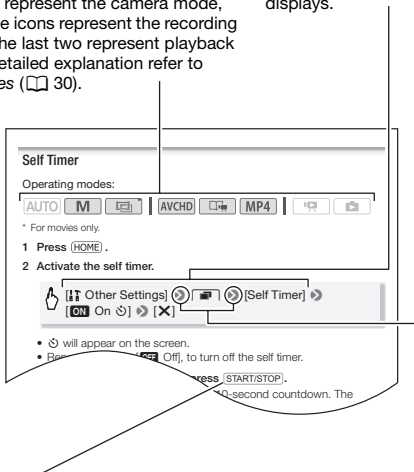

The names of physical buttons and switches on the camcorder are indicated within a “button” frame. For example **START/STOP**.

The **>** arrow is used to abbreviate menu selections. For a detailed explanation on how to use the menus, refer to *Using the Menus* (📖 26). For a concise summary of all available menu options and settings, refer to the appendix *Menu Options Lists* (📖 166).

Supplied Accessories and CD-ROMs

The following accessories are supplied with the camcorder:

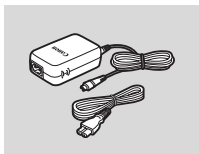

▶ CA-110E Compact Power Adapter
(incl. power cord)



◀ BP-709 Battery Pack



▶ IFC-300PCU/S USB Cable

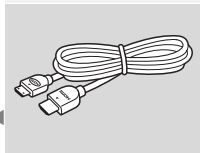

◀ HTC-100/S HDMI Cable

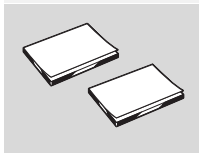

▶ Quick Guide
▶ Wi-Fi Basic Setup Guide*

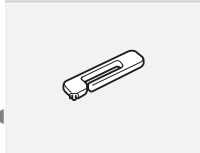

◀ Stylus Pen

* **HFR38** / **HFR37** / **HFR36** only.

The following CD-ROMs and software are supplied with the camcorder:

- **PIXELA CD-ROM**

- **HFR38/HFR37/HFR36** You can use **VideoBrowser** for managing, editing, and playing back AVCHD movies, and **Network Utility** when transferring recordings wirelessly to a computer.
- **HFR306** Use **Transfer Utility** for saving and transferring AVCHD movies and music files you can use as background music.
- A printed Startup Guide for PIXELA's software is also supplied. Refer to this Startup Guide for details about the supplied software.

- **Canon LEGRIA CD-ROM**. Contains the following components.

- Instruction Manual - The full-version instruction manual of the camcorder (this PDF file).
- ImageBrowser EX - This CD-ROM contains an automatic installer for the supplied software ImageBrowser EX, which allows you to save and manage MP4 movies and photos; and upload MP4 movies to CANON iMAGE GATEWAY**, YouTube and Facebook. An Internet connection is required for installation.
- Music data - Music files that can be used as background music during playback. These music files are for exclusive use with the supplied PIXELA's software. The disc cannot be played back on CD players.
- Image mix data - Image files that can be used with the image mix function (image mix frames).

* The CD-ROM includes the instruction manual of the software (on PDF file).

**CANON iMAGE GATEWAY is an online service that allows you to share movies and photos, create video podcasts, make photo albums, and more. This service may not be available in all countries/regions.

Names of Parts

Left side view

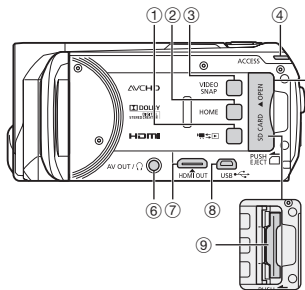

- ① (camera/play) button (32)
- ② HOME button (26)
- ③ VIDEO SNAP (video snapshot) button (72)
- ④ ACCESS indicator (43)
- ⑤ Memory card slot cover
- ⑥ AV OUT terminal (121, 123)/
 (headphones) terminal (110)
- ⑦ HDMI OUT terminal (121, 122)
- ⑧ USB terminal (121, 124, 134, 138)
- ⑨ Memory card slot (38)
- ⑩ START/STOP button (43)
- ⑪ DC IN terminal (19)
- ⑫ Grip belt (22)
- ⑬ Wi-Fi antenna (**HFR38** / **HFR37** / **HFR36** only)

Right side view

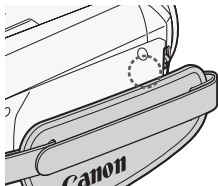
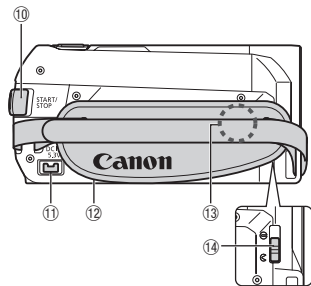

- ⑭ Lens cover switch (23)
- ⑮ Stereo microphone (109)

Front view

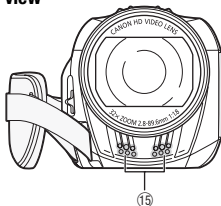

Top view

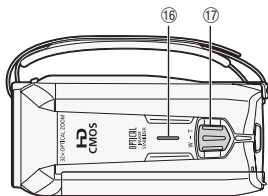

- ⑩ Speaker (55)
- ⑪ Zoom lever (49)
- ⑫ LCD touch screen (23, 25)
- ⑬ POWER button
- ⑭ ON/OFF (CHG) (charge) indicator:
Green – On
Orange – Standby (51)
Red – Charging (19)
- ⑮ Battery attachment unit (19)
- ⑯ **Serial number**

LCD panel

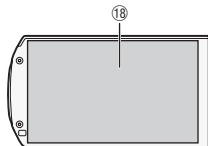

Back view

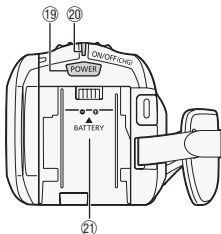

- ⑰ Tripod socket (205)
- ⑱ BATTERY RELEASE switch (20)

Bottom view

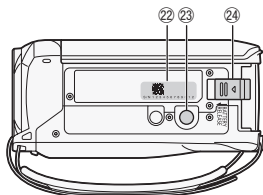



Preparations

This chapter describes basic operations, such as using the touch panel, navigating the menus, and first time settings to help you learn more about your camcorder.

Getting Started

Charging the Battery Pack

The camcorder can be powered with a battery pack or directly using the compact power adapter.

For approximate charging times and recording/playback times with a fully charged battery pack, refer to *Charging, Recording and Playback Times* (📖 212).

- 1 **Connect the power cord to the compact power adapter.**
- 2 **Plug the power cord into a power outlet.**
- 3 **Connect the compact power adapter to the camcorder's DC IN terminal.**
- 4 **Attach the battery pack to the camcorder.**

Press the battery pack softly into the battery attachment unit and slide it up until it clicks in place.

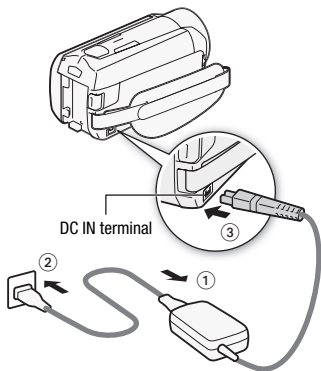

5 Charging will start when the camcorder is turned off.

- If the camcorder was on, the green ON/OFF (CHG) indicator will go out when you turn off the camcorder. After a moment, the ON/OFF (CHG) indicator will turn on in red (battery pack charging). The red ON/OFF (CHG) indicator will go out when the battery pack is fully charged.
- If the indicator flashes, refer to *Troubleshooting* (📖 190).

ON/OFF (CHG) (charge) indicator

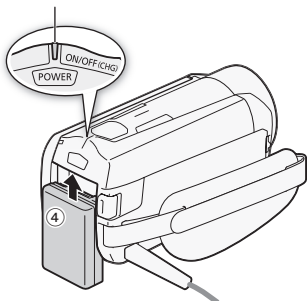

To remove the battery pack

- 1 Slide **BATTERY RELEASE** in the direction of the arrow and hold it pressed down.
- 2 Slide the battery pack and then pull it out.

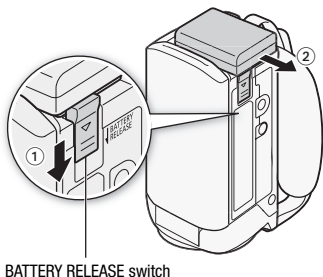

! IMPORTANT

- Turn off the camcorder before connecting or disconnecting the compact power adapter. After pressing **POWER** to turn off the camcorder, important data is updated in the memory. Be sure to wait until the green ON/OFF (CHG) indicator goes out.
- Do not connect to the camcorder's DC IN terminal or to the compact power adapter any electrical equipment that is not expressly recommended for use with this camcorder.

- To prevent equipment breakdowns and excessive heating, do not connect the supplied compact power adapter to voltage converters for overseas travels or special power sources such as those on aircraft and ships, DC-AC inverters, etc.

NOTES

- We recommend charging the battery pack in temperatures between 10 °C and 30 °C. If either the ambient temperature or the battery pack's temperature is outside the range of approx. 0 °C to 40 °C, charging will not start.
- If the ambient temperature or the battery pack's temperature is low, charging may take longer than usual.
- The battery pack will be charged only when the camcorder is off.
- If the power supply was disconnected while charging a battery pack, make sure the ON/OFF (CHG) indicator has gone out before restoring the power supply.
- If remaining battery time is an issue, you can power the camcorder using the compact power adapter so the battery pack will not be consumed.
- Charged battery packs continue to discharge naturally. Therefore, charge them on the day of use, or the day before, to ensure a full charge.
- Optional battery packs for this camcorder can display the remaining battery time. The first time you use an optional battery pack, fully charge it and then use the camcorder until the battery pack is completely exhausted. Doing so will ensure that the remaining recording time will be displayed accurately.
- We recommend that you prepare battery packs to last 2 to 3 times longer than you think you might need.

Using the Grip Belt

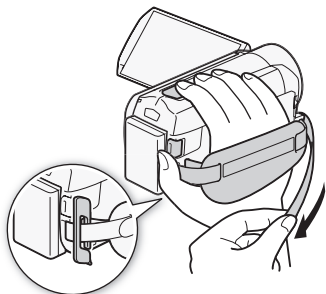

Fasten the grip belt.

Adjust the grip belt so that you can reach the zoom lever with your index finger, and the **START/STOP** button with your thumb.

You can attach the supplied stylus pen to the grip belt.

To remove the grip belt

- 1 Lift the padded handgrip's flap and detach the strap from the Velcro pad.
- 2 Pull the strap to remove it first from the front bracket on the camcorder, then to unthread it from the handgrip and finally to remove it from the rear bracket on the camcorder.

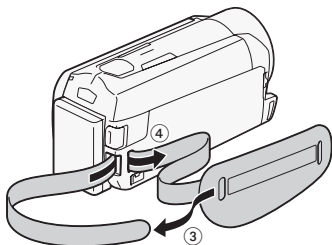
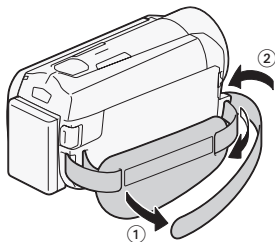

Opening the Lens Cover and Adjusting the LCD Screen

Before you start recording, open the lens cover.

Move the lens cover switch down to  to open the lens cover.

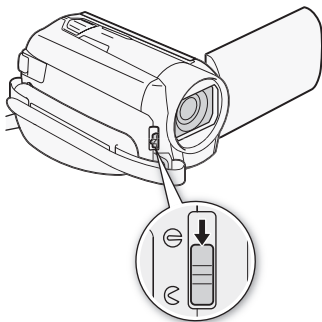



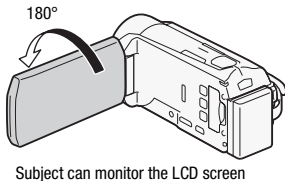
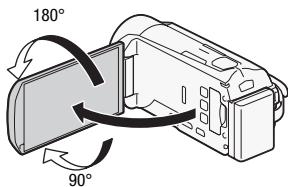

Rotating the LCD Panel

Open the LCD panel 90 degrees.

- You can rotate the panel 90 degrees downward.
- You can rotate the panel 180 degrees toward the lens. Rotating the LCD panel 180 degrees can be useful to allow the camcorder to include yourself in the picture when recording with the self timer.



NOTES

- **About the LCD screen:** The screen is produced using extremely high-precision manufacturing techniques, with more than 99.99% of the pixels operating to specification. Less than 0.01% of the pixels may occasionally misfire or appear as black, red, blue or green dots. This has no effect on the recorded image and does not constitute a malfunction.
- For details about how to take care of the touch screen, refer to *Handling Precautions* ( 204), *Cleaning* ( 208).
- You can adjust the screen's brightness using the   [LCD Brightness] and [LCD Backlight] settings. When the compact power adapter is connected, [LCD Backlight] will automatically change to [H Bright].

Basic Operation of the Camcorder

Using the Touch Screen

The control buttons and menu items that appear on the touch screen change dynamically depending on the operating mode and the task you are performing. With the intuitive touch screen interface you have all the controls at your fingertips. You can also use the supplied stylus pen for a more precise operation.

Touch

Press firmly on an element displayed on the touch screen.

Used to start playing back a scene in an index screen, to select a setting from the menus, to select the subject whom the camcorder will recognize as the main subject of the scene, etc.

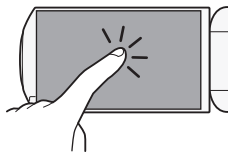

Drag

While applying pressure, swipe your finger up and down or left and right across the screen.

Used to scroll menus, to browse through index screen pages or to adjust slider controls like the volume.

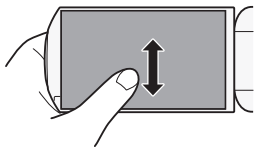

! IMPORTANT

- **The camcorder uses a pressure-sensitive touch screen. Press firmly when using touch operations.**
- In the following cases, you may not be able to perform touch operations correctly.
 - Using your fingernails or hard-tipped objects other than the supplied stylus pen, such as ballpoint pens.
 - Operating the touch screen with wet or gloved hands.
 - Applying excessive force or forcefully scratching the touch screen.
 - Attaching commercially available screen protectors or adhesive film onto the touch screen's surface.

Using the Menu

Many of the camcorder's functions can be adjusted from the [FUNC Main Functions] panel and [Other Settings] menus in the HOME menu. For details about the available menu options and settings, refer to the appendix *Menu Options Lists* (166).

HOME Menu

Operating modes:



The HOME menu is the gateway to most of the camcorder's functions and settings. After you press [HOME], the HOME menu will appear and you can select from the following control buttons. The available control buttons depend on whether the camcorder is in recording or playback mode.

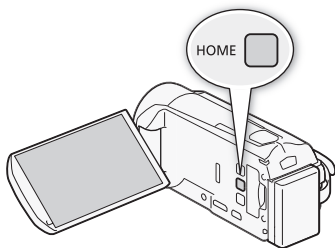



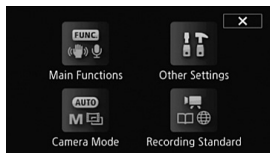



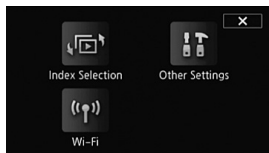









In recording mode



In playback mode
for **HFR38 / HFR37 / HFR36**



- [FUNC Main Functions] - This contains functions commonly used while shooting, such as focus and exposure. Available only in recording mode.
- [Other Settings] - Selecting this control button will open up the [Other Settings] menu, which gives you access to settings such as the video quality (recording mode) and LCD brightness.





- **[ Camera Mode]** - From the [ Camera Mode] menu, you will be able to change whether you record movies in **[ AUTO]** mode (camcorder automatically takes care of many settings), **[ M]** mode (you can manually change settings), or **[ Cinema]** mode (using the cinema-look filters, you can make movies with a cinematic feel). Available only in recording mode. For details on how to set the camera mode, refer to *Recording* ( 30).
- **[ Recording Standard]** - This camcorder can record movies in either the AVCHD or MP4 recording standard. Use this menu to select the standard that best suits your needs. You can also use Story Creator mode ( 67) when choosing to record in AVCHD. Available only in recording mode. For details on how to set the recording standard, refer to *Recording* ( 30).
- **[ Wi-Fi]** - **[ HFR38] / [ HFR37] / [ HFR36]** Allows you to access the various Wi-Fi functions this camcorder has to offer. Available only in playback mode. For more details on Wi-Fi functions, refer to *Wi-Fi Functions* ( 147).
- **[ Index Selection]** - Use this to switch between the various index screens in playback mode ( 58).

[Main Functions] Panel

Operating modes:



* In **[ AUTO]** mode, access to functions is limited.

The [ Main Functions] panel contains frequently used shooting functions. Press **[ HOME]** to open the HOME menu and then touch [ Main Functions] to open the panel. Alternatively, you can touch **[ FUNC.]** in the upper-left portion of the recording screen. Next, touch the function you want to set or adjust.

In **M** mode

Touch to scroll up
or down

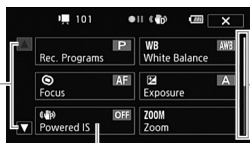

Drag your finger up
and down along the
scroll bar to display
the rest of the panel

Touch the control
button of the
desired function

You may need to drag your finger up and down along the scroll bar or touch [▲] and [▼] to find the control button of the desired function.

[Edit] Panel

Operating modes:



Touch [Edit] to display a panel showing available operations (copying, deleting, etc.), and then touch the operation you want to perform.

In  mode
for **HFR38 / HFR37 / HFR36**

Touch the control
button of the
desired operation

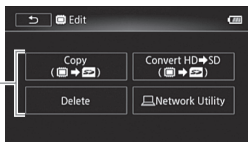

[Other Settings] Menu

Operating modes:



* In **AUTO** mode, access to functions is limited.

- 1 Press **[HOME]** to open the **HOME** menu.
- 2 Touch **[Other Settings]** to open the **[Other Settings]** menus.
- 3 Touch the tab of the desired menu.
- 4 Drag your finger up and down to bring the setting you want to change into the orange selection bar.

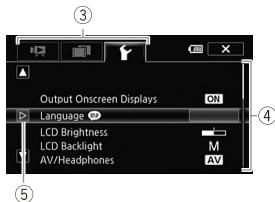

- You can also use the **[▲]** and **[▼]** icons for scrolling.
 - Menu items not available appear grayed out.
 - You can touch any menu item on the screen to bring it directly into the selection bar.
- 5 When the desired menu item is inside the selection bar, touch **[▶]**.
 - 6 Touch the desired option and touch **[X]**.
You can touch **[X]** to close the menu at any time.



Operating Modes

Recording

When recording, the camcorder's operating mode is determined by the [CAMERA] Camera Mode] and [RECORDING] Recording Standard] menus in the HOME menu. First, set the camera mode.

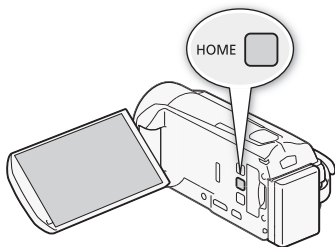





- 1 Press [HOME] to open the HOME menu.
- 2 Touch [CAMERA] Camera Mode] and then touch the desired camera mode.
- 3 Touch [OK].





Camera mode	Operation
 (AUTO mode)	Let the camcorder take care of most of the settings while you concentrate on recording (43). Great for beginners or if you just prefer not to bother with detailed camcorder settings.
 (Manual mode)	Enjoy full access to menus, settings and advanced functions (89).
 (Cinema mode)	Give your recordings a cinematic look and use cinema-look filters to create unique movies (70).

Next, set the recording standard. The recording standard determines the type of data the movie is recorded as — namely, AVCHD or MP4.



- 1 Press [HOME] to open the HOME menu.
- 2 Touch [RECORDING] Recording Standard] and then touch the desired recording standard.
- 3 Touch [OK].

Recording standard	Control button	Operation
		Movies are recorded in AVCHD, which is designed for playback on HDTVs. Select this recording standard if you plan to show off your movies and you want to impress your audience with fantastic picture quality.
		Movies are recorded in AVCHD using Story Creator (📖 67), which allows you to create compelling video stories. Because Story Creator mode records in AVCHD, your movies will look amazing when played back on an HDTV.
		By recording movies in MP4, your movies are smaller in size but retain high quality. This is especially useful for playback on portable devices or sharing on the Web.





NOTES

- You can adjust the video quality using the   [Recording Mode] setting.
- Some portable devices may not be able to play back MP4 movies recorded with this camcorder.

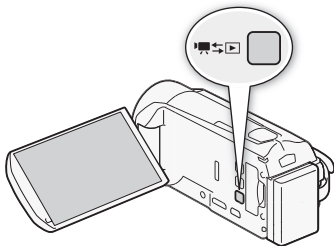
Playback

Press the camera/play button  to switch the camcorder between camera (recording) mode and playback mode. You can press  when the camcorder is off to turn it on directly in playback mode.



Playback mode	Operation
	Playing back movies ( 53).
	Viewing photos ( 116).

NOTES

- **HFR38 / HFR37 / HFR36** When switching to a playback mode, the memory selected for playback will be the same currently used for recording.

First Time Settings

Setting the Date and Time

You will need to set the date and time of the camcorder before you can start using it. The [Date/Time] screen will appear automatically when the camcorder's clock is not set.

When the [Date/Time] screen appears, the year will be selected.

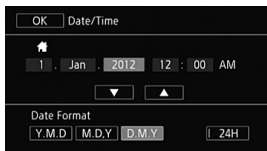



- 1 Touch a field you want to change (year, month, day, hours or minutes).
- 2 Touch [▲] or [▼] to change the field as necessary.
- 3 Set the correct date and time by changing all the fields in the same way.
- 4 Touch [Y.M.D], [M.D,Y] or [D.M.Y] to select the date format you prefer.

In some screens, the date will be displayed in short form (numbers instead of month names), but it will still follow the order you selected.

- 5 Touch [24H] to use 24-hour clock or leave it unselected to use 12-hour clock (AM/PM).
- 6 Touch [OK] to start the clock and close the setup screen.

NOTES

- You can adjust the date and time later on with the   [Date/Time] setting.
- When you do not use the camcorder for about 3 months, the built-in rechargeable lithium battery may discharge completely and the date and time setting may be lost. In such case, recharge the built-in lithium battery ( 207) and set the time zone, date and time again.

Changing the Language

The default language of the camcorder is English. You can set it to one of 27 languages.



Operating modes:



- 1 Press **[HOME]**.
- 2 Select the desired language.



i NOTES

- Some control buttons, such as **[ZOOM]** or **[PHOTO]**, will appear in English regardless of the language selected.

Changing the Time Zone

Change the time zone to match your location. The default setting is Paris.

Operating modes:



- 1 Press **HOME**.
- 2 Open the **[Time Zone/DST]** screen.





- 3 Touch **[🏠]** to set the home time zone, or **[✈️]** to set the time zone of your destination when you are traveling.
- 4 Touch **[▲]** or **[▼]** to set the desired time zone. If necessary, touch **[*]** to adjust for daylight saving time.
- 5 Touch **[✕]** to close the menu.

Using a Memory Card

Memory Cards Compatible for Use with the Camcorder

You can use the following types of commercially available Secure Digital (SD) cards with this camcorder.

As of December 2011, the movie recording function has been tested using SD/SDHC/SDXC memory cards made by Panasonic, Toshiba and SanDisk. For the latest information on cards that can be used, visit your local Canon Web site.

Memory card type:	 SD memory card,  SDHC memory card,  SDXC memory card
SD Speed Class*:	CLASS② CLASS④ CLASS⑥ CLASS⑩
Capacity:	128 MB or larger**.

* When using an SD memory card without a speed class rating, you may not be able to record movies, depending on the memory card used.

**SD memory cards with a capacity of 64 MB or smaller cannot be used to record movies.

NOTES

- **About the Speed Class:** Speed Class is a standard that indicates the minimum guaranteed data transfer speed of memory cards. When you buy a new memory card, look for the Speed Class logo on the package. We recommend using memory cards rated SD Speed Class 4, 6 or 10.

SDXC Memory Cards

You can use SDXC memory cards with this camcorder. When using memory cards with other devices, such as digital recorders, computers and card readers, **make sure that the external device is compatible with SDXC cards**. The table below summarizes compatibility by computer operating system, as of December 2011. For the latest information, however, contact the computer, operating system or memory card manufacturer.

Compatible operating systems for SDXC memory cards

Operating system	Compatibility
Windows 7	Compatible
Windows Vista	Compatible (requires Service Pack 1 or later)
Windows XP	Compatible (requires Service Pack 3 and KB955704 update)
Mac OS X	Compatible (requires version 10.6.5 or later)

IMPORTANT

- If you use an SDXC memory card with a computer OS that is not SDXC-compatible, you may be prompted to format the memory card. In such case, **cancel the operation to prevent data loss**.
- After repeatedly recording, deleting and editing scenes (fragmented memory), it will take longer to write data on the memory and recording may stop. Save your recordings and initialize the memory.

Eye-Fi Cards

This product is not guaranteed to support Eye-Fi card functions (including wireless transfer). In case of an issue with an Eye-Fi card, please check with the card manufacturer.

Also note that an approval is required to use Eye-Fi cards in many countries or regions. Without approval, use of the card is not permitted. If it is unclear whether the card has been approved for use in the area, please check with the card manufacturer.

Inserting and Removing a Memory Card

Make sure to initialize (📖 41) all memory cards before using them with this camcorder.

1 Turn off the camcorder.

Make sure the ON/OFF (CHG) indicator is off.

2 Open the memory card slot cover.

3 Insert the memory card at a slight angle, with the label facing toward the lens, all the way into the memory card slot until it clicks.

- The memory card slot is at a slight angle toward the lens so be careful not to damage the memory card when inserting it.
- Be sure you understand the information provided in Eye-Fi Cards (📖 37) before using an Eye-Fi card.

4 Close the memory card slot cover and press until it clicks.

Do not force the cover closed if the memory card is not correctly inserted.

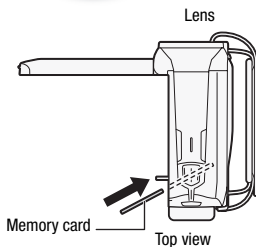
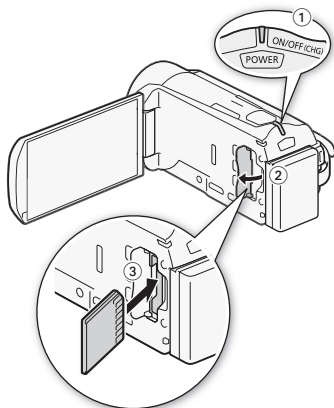

To remove the memory card

Push the memory card once to release it. When the memory card springs out, pull it all the way out.

IMPORTANT

- Memory cards have front and back sides that are not interchangeable. Inserting a memory card facing the wrong direction can cause a malfunction of the camcorder. Be sure to insert the memory card as described in step 3.

HFR38 / HFR37 / HFR36 Selecting the Memory (Built-in Memory/ Memory Card) for the Recordings

You can select to record your movies and photos in the built-in memory or on a memory card. The default memory for recording both is the built-in memory.

Operating modes:



POINTS TO CHECK

- Be sure you understand the information provided in *Eye-Fi Cards* (book 37) before using an Eye-Fi card.

1 Press **HOME**.

2 Select the desired memory.



- * When selecting the memory, you can check the approximate available recording time/number of photos, based on currently used settings.

HFR38 / HFR37 / HFR36 Relay Recording

You can activate the relay recording so if the built-in memory becomes full while recording movies, the recording will continue uninterrupted on the memory card.

Operating modes:



- 1 Insert a memory card that contains no video recordings into the memory card slot.
- 2 Press **[HOME]**.
- 3 Activate the relay recording.



* The approximate available recording time will now reflect the combined space in the memories used for relay recording.

i NOTES

- There will be a momentary stop in the scene at the point where the camcorder switches from one memory to another.
- Any of the following actions will deactivate the relay recording function:
 - Turning off the camcorder.
 - Opening the memory card slot cover.
 - Changing the camcorder's operating mode.
 - Changing the memory used for recording movies.

Initializing the Memory

Initialize memory cards when you use them with this camcorder for the first time. You can also initialize a memory card or the built-in memory (HFR38 / HFR37 / HFR36 only) to permanently delete all the recordings it contains.

HFR38 / HFR37 / HFR36 At the time of purchase, the built-in memory comes pre-initialized and contains music files for use as background music and images for use with the image mix function (image mix frames).

Operating modes:



1 Power the camcorder using the compact power adapter.

Do not disconnect the power source or turn off the camcorder until the initialization is completed.

2 Press **HOME**.

3 Initialize the memory.

HFR38 / HFR37 / HFR36

 [Other Settings] > [Initialize] > [Initialize] > [Complete Initialization]¹ > [Yes]² > [OK] > [X]

HFR306

 [Other Settings] > [Initialize] > [Initialize] > [Complete Initialization]¹ > [Yes]² > [OK] > [X]

¹ Touch this option if you want to physically erase all the data rather than just clear the file allocation table of the memory.

² If you selected the [Complete Initialization] option, you can touch [Cancel] to cancel the initialization while it is in progress. All recordings will be erased and the memory can be used without any problem.

IMPORTANT

- Initializing the memory will permanently erase all recordings. Lost original recordings cannot be recovered. Make sure you save important recordings in advance using an external device (📖 126).
- Initializing a memory card will permanently erase any music files and images you may have transferred to the card. (HFR38/HFR37/HFR36 The music files and image mix frames that come pre-installed in the built-in memory will be restored after it is initialized.) To transfer music files from the supplied LEGRIA CD-ROM to the memory card connected to a computer:
 - Windows users: Remove the memory card from the camcorder, connect it to a computer and use the supplied software **VideoBrowser** (HFR38/HFR37/HFR36 only) or **Transfer Utility** (HFR306 only). For details, refer to the Software Guide (PDF file) of the supplied PIXELA's software.
 - Mac OS users: Remove the memory card from the camcorder and connect it to a computer. Use Finder to transfer music files from the [MUSIC] folder on the supplied LEGRIA CD-ROM to the memory card connected to a computer. Refer to *About the music files* (📖 218) for the folder structure of the memory card.
- At the time of purchase, Eye-Fi cards contain the necessary network configuration software. Be sure to install the software and complete the required configuration setup before you initialize the Eye-Fi card prior to using it with this camcorder.



AUTO Mode

This chapter covers how to easily record video and photos in **AUTO** mode, and how to use basic shooting functions like zoom and Quick Start. To enjoy full access to menus and more advanced functions, refer to *Recording in Manual Mode* (📖 89).

Basic Recording

Shooting Video and Taking Photos in AUTO Mode

With **AUTO** mode, you can take great-looking videos and photos by letting the camcorder automatically adjust settings based on the recording situation.

Operating modes:



POINTS TO CHECK

- **Before you begin recording**, make a test recording first to check that the camcorder is operating correctly.

1 Press [POWER] to turn on the camcorder.

- **HFR38/HFR37/HFR36** By default, movies and photos are recorded in the built-in memory. You can select the memory that will be used to record movies and photos (39).
- Please read the **IMPORTANT** section (47) before using an Eye-Fi card.

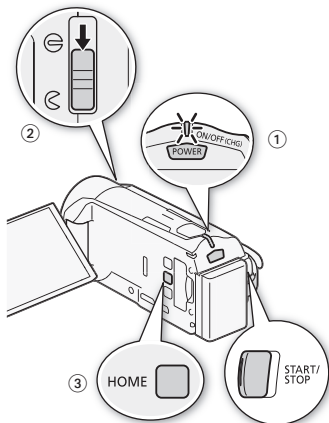

2 Open the lens cover switch.

3 Press [HOME] .

To change the recording standard, refer to *Recording* (30).

4 Set the camcorder to [AUTO] mode.



To record video

Press [START/STOP] to begin recording.

- Press [START/STOP] again to pause the recording.
- The ACCESS indicator will flash from time to time while the scene is being recorded.
- You can turn on the scene rating option in recording mode with the [] > [Rate Scenes (Recording)] setting.

To take photos

Touch [PHOTO].

- You can record photos simultaneously while recording a movie.
- A green icon (⊙) will appear momentarily on the screen and the ACCESS indicator will flash as the photo is recorded. However, if you record a photo while recording a movie, the green icon will not appear. Instead, a ▷ icon will appear in the upper right of the screen.

When you have finished recording

- 1 Make sure that the ACCESS indicator is off.
- 2 Turn off the camcorder.
- 3 Close the LCD panel.
- 4 Close the lens cover.































About AUTO mode







- Only the following functions are available in [AUTO] mode.
 - Zoom (📖 49).
 - Quick Start (📖 51).
 - Video snapshot (📖 72).
 - Face detection (📖 99) to get beautiful shots of people every time, tracking the subject even if the person moves.
 - Touch & Track (📖 100) to track other moving subjects, keeping them in focus and using the best settings to record them.
 - Story Creator (📖 67) to transform your movies into compelling video stories by following simple scripts for various scenarios.
 - Decoration (📖 73) to add a fun personal touch using stamps, drawings, image mix and more.

About the Smart AUTO function

In [AUTO] mode, the camcorder will automatically detect certain characteristics of the subject, background, lighting conditions, etc. It will then adjust various settings (focus, exposure, color, image stabilization, image quality, among others), selecting the best settings for the scene you want to shoot. The Smart AUTO icon will change to one of the following icons.

Smart AUTO icons





Background → (color of the icon)	Bright* (gray)	Blue skies* (light blue)	Vivid colors* (green/red)	Sunsets (orange)
Subject ↓				
People (stationary)	 ()	 ()	 ()	—
People (moving)	 ()	 ()	 ()	—
Subjects other than people, such as landscapes	 ()	 ()	 ()	
Close objects	 /  ( / )	 /  ( / )	 /  ( / )	—

Background → (color of the icon)	Dark (dark blue)		
Subject ↓		Spotlight	Night scene
People (stationary)		—	—
People (moving)		—	—
Subjects other than people, such as landscapes			
Close objects	 / 	—	—

* The icon in parentheses appears under backlight conditions.

Intelligent IS

Intelligent IS allows the camcorder to select the best image stabilization option based on your shooting method. The Intelligent IS icon will change to one of the following icons. In **[M]** and **[RECORD]** modes, you can set the image stabilization manually (📖 97).



Shooting method	Icon
Most general situations; Zooming out (zooming toward W); Following subjects at a distance moving left or right	 (Dynamic IS)
Zooming in (zooming toward T)	 (Powered IS)*
Close-up of a subject	 (Macro IS)
Remaining stationary, such as when using a tripod	 (Tripod mode)





* You can turn off Powered IS through the **[ Main Functions]** panel (📖 97).

! IMPORTANT

- To protect the lens, keep the lens cover closed when you are not recording movies and when you are not using the camcorder.
- Observe the following precautions while the ACCESS indicator is on or flashing. Failing to do so may result in permanent data loss or damage to the memory.
 - Do not open the memory card slot cover.
 - Do not disconnect the power source or turn off the camcorder.
 - Do not change the camcorder's operating mode.
- Be sure to save your recordings regularly (📖 126), especially after making important recordings. Canon shall not be liable for any loss or corruption of data.
- Recordings on an Eye-Fi card will be uploaded automatically after setting the camcorder to playback mode, if you are within the range of a configured network. Always verify that Eye-Fi cards have been approved in the country/region of use. See also *Using an Eye-Fi card* (📖 145).

i NOTES

- **About the power saving mode:** If **[]** **[Power Saving Mode]** **[]** **[Auto Power Off]** is set to **[ON]** On, the camcorder will shut off automatically to save power when it is powered by a battery pack and is left without any operation for 5 minutes. Press **[POWER]** to turn on the camcorder.

- When recording in bright places, it may be difficult to use the LCD screen. In such cases, you can adjust the LCD backlight with the  [LCD Backlight] setting or adjust the brightness of the LCD screen with the  [LCD Brightness] setting.
- Under certain conditions, the Smart AUTO icon that appears on the screen may not match the actual scene. Especially when shooting against orange or blue backgrounds, the Sunset or one of the Blue Skies icons may appear and the colors may not look natural. In such case, we recommend recording in  mode ( 89).
- Photos are recorded as JPG files. The photo size (1920x1080) and quality cannot be changed. At this size, a 1 GB memory card can hold approximately 670 photos. However, the actual number of photos that can be recorded will vary depending on the subject and shooting conditions.

Zooming

There are two ways you can zoom in and out: using the zoom lever on the camcorder or using the zoom controls on the touch screen. You can also select the zoom type (optical, advanced or digital).

Operating modes:



Using the Zoom Lever

Move the zoom lever toward **W** (wide angle) to zoom out. Move it toward **T** (telephoto) to zoom in.

By default, the zoom lever operates at a variable speed – press gently for a slow zoom; press harder for faster zooms.

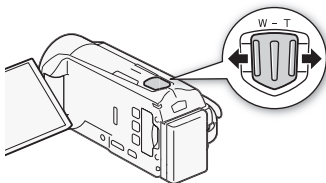

Using the Touch Screen's Zoom Controls

1 Display the zoom controls on the touch screen.

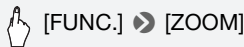

- The zoom controls appear on the left side of the screen.

2 Touch the zoom controls to operate the zoom.

Touch anywhere within the **W** area to zoom out or anywhere within the **T** area to zoom in. Touch closer to the center for a slow zoom; touch closer to the **W/T** icons for faster zooms.



3 Touch **[X]** to hide the zoom controls.

Selecting the Zoom Type

The camcorder offers three types of zoom - optical, advanced and digital.

Operating modes:



* In **AUTO** mode, [Zoom Type] will be set to [**32x** Optical].

 [FUNC.] ➤ [Zoom Type] ➤ Desired zoom type





Options

[32x Optical] For optical zoom, the camcorder uses the optical magnification ratio of the lens.

[51x Advanced] For advanced zoom, the camcorder processes the image beyond the range of the optical zoom to obtain a larger zoom without any deterioration in image quality. At full wide angle, the angle of view with advanced zoom is wider than the angle of view with optical zoom.

[1020x Digital] (HFR37 [2550x Digital]) For digital zoom (light blue area on the zoom bar), the image is processed digitally so image quality will deteriorate the more you zoom in. When you are using digital zoom (zoom position is within the light blue area on the zoom bar), photos cannot be taken.

NOTES

- Keep at least 1 m away from the subject. At full wide angle, you can focus on a subject as close as 1 cm. Using tele macro ( 105), you can focus on a subject as close as 50 cm at full telephoto.
- In **M** or  mode, you can also set  ➤ [Zoom Speed] to one of three constant speeds (3 is the fastest, 1 the slowest). When [Zoom Speed] is set to [**VAR** Variable], the zoom speed will be faster in record pause mode than when actually recording, except when pre-recording ( 98) is activated.

Quick Start

When you close the LCD panel with the camcorder on, the camcorder enters the standby mode. In standby mode the camcorder consumes only about 1/3 the power used when recording, saving energy when you are using a battery pack. Additionally, when you open the LCD panel, the camcorder is ready to start recording in approximately 1 second*, allowing you to record the subject right away.

* The actual time required varies depending on the shooting conditions.

Operating modes:



1 With the camcorder on and in a recording mode, close the LCD panel.

A beep will sound and the green ON/OFF (CHG) indicator will change to orange to indicate the camcorder entered standby mode.

2 When you wish to resume recording, open the LCD panel.

The ON/OFF (CHG) indicator turns back green and the camcorder is ready to record.

! IMPORTANT

- Do not disconnect the power source during standby mode (while the ON/OFF (CHG) indicator is lit in orange).

i NOTES

- The camcorder will not enter standby mode if the LCD panel is closed while the ACCESS indicator is on or flashing or while the HOME menu or menus contained therein (not including the [FUNC] Main Functions panel) are being displayed. The camcorder may also not enter standby mode when the battery charge is too low. Check that the ON/OFF (CHG) indicator changes to orange.

- **About standby mode and auto power off:**

- The camcorder will power off automatically if left in standby mode for 10 minutes. Press **[POWER]** to turn on the camcorder.
- You can select the length of time until shut-off or turn off the Quick Start function altogether with the **[]** **[▶]** **[Power Saving Mode]** **[▶]** **[Quick Start (Standby)]** setting.
- The usual 5-minute auto power off setting of **[Power Saving Mode]** is not applicable while the camcorder is in standby mode.





Video

This chapter covers functions related to movies, including playback, advanced shooting, using Story Creator and other advanced functions. For details about basic video shooting, refer to *AUTO Mode* (📖 43).

Basic Playback

Playing Back Video

You can use the   [Data Code] setting to choose whether to display the recording date (and other information, for AVCHD movies) when you play back videos (📖 66).

Operating modes:



- 1 Press .
- 2 Open the [AVCHD Movies] or [MP4 Movies] index screen, if it is not displayed.

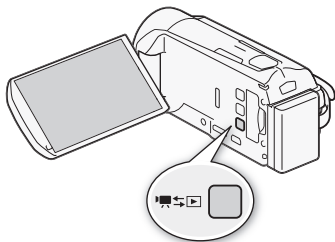

3 Look for the scene you want to play back.

Move the zoom lever toward **W** to show 15 scenes per page; move it toward **T** to show 6 scenes per page.



- 1 Open the index selection screen.
- 2 Memory being read.
- 3 Recording date**.
- 4 Division line between recording dates.
- 5 Drag your finger left/right for the next/previous index page*.
- 6 Display the next/previous index page.
- 7 Scene's timeline (📖 64)**.
- 8 3D Flip View (📖 57)**.

* While browsing through index pages, a larger scroll bar will appear at the bottom of the screen for a few seconds. When you have a large number of scenes it may be more convenient to drag your finger along the scroll bar.

**Not available for MP4 movies.

4 Touch the desired scene to play it back.

- For AVCHD movies, the camcorder will play back the scene selected and continue until the end of the last scene in the index screen. For MP4 movies, the camcorder will play back only one scene.
- Touch the screen to display the playback controls. During playback, the playback controls will disappear automatically after a few seconds without operation. In playback pause, touch the screen again to hide the playback controls.

During playback:

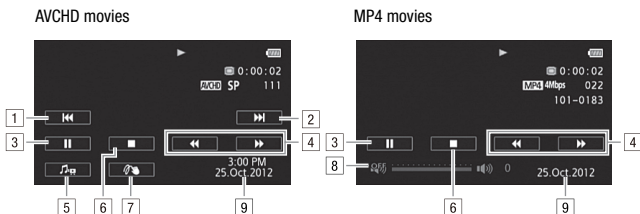

- 1 Jump to the beginning of the scene. Double-tap to jump to the previous scene*.
- 2 Jump to the beginning of the next scene*.
- 3 Pause the playback.
- 4 Fast playback** backward/forward.
- 5 Display the volume (🔊 55) and background music mix balance (🎚️ 82) controls.
- 6 Stop the playback.
- 7 Decoration (📖 73).
- 8 Volume.
- 9 Recording date. Use the [📺] ➡ [Data Code] setting to turn this on and off.

* Not available for MP4 movies.

**Touch several times to increase the playback speed to approximately 5x → 15x → 60x (for AVCHD movies) or 5x → 15x (for MP4 movies) normal speed.

Adjusting the volume for AVCHD movies

- 1 During playback, touch the screen to display the playback controls.
- 2 Touch [🔊], drag your finger along the [Speaker Volume]* bar to adjust the volume and touch [↶].

* When [📺] ➡ [AV/Headphones] is set to [🎧 Headphones], adjust the [Headphone Volume] bar instead.

Adjusting the volume for MP4 movies

- 1 During playback, touch the screen to display the playback controls.
- 2 Drag your finger across the volume bar to adjust the volume.

During playback pause:

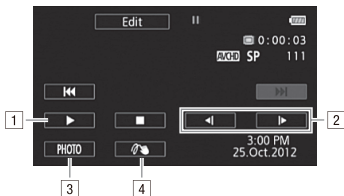

- 1 Resume playback.
- 2 Slow playback* backward/forward.
- 3 Capture the displayed frame as a photo (📖 113)**.
- 4 Decoration (📖 73)**.

* Touch several times to increase the playback speed 1/8 → 1/4 the normal speed.

** Not available for MP4 movies.

! IMPORTANT

- Observe the following precautions while the ACCESS indicator is on or flashing. Failing to do so may result in permanent data loss.
 - Do not open the memory card slot cover.
 - Do not disconnect the power source or turn off the camcorder.
 - Do not change the camcorder's operating mode.
- You may not be able to play back with this camcorder movies recorded on a memory card using another device and then transferred to a memory card connected to a computer.

NOTES

- Depending on the recording conditions, you may notice brief stops in video or sound playback between scenes.
- During fast/slow playback, you may notice some anomalies (blocky video artifacts, banding, etc.) in the playback picture.
- The speed indicated on the screen is approximate.
- Slow reverse playback will look the same as continuous frame reverse.

3D Flip View

Operating modes:



Touch  in the [AVCHD Movies] index screen to switch to 3D Flip View. This fun way of displaying scenes grouped by recording date in a 3D layout can be useful to flip through a large number of recordings.



- 1 Recording date.
- 2 Drag your finger left to go to the next date with recordings.
- 3 Drag your finger up and down to browse through the scenes recorded in the displayed date.
- 4 Drag your finger right to go to the previous date with recordings.
- 5 Return to the [AVCHD Movies] index screen.
- 6 Current scene / Total number of scenes recorded on the selected date.
- 7 Touch the scene in the front to play it back.

The [Index Selection] Screen: Selecting the Content to Play Back

From the [Index Selection] screen you can select the content you want to play back (original scenes by date or by story, or photos, for example). **HFR38/HFR37/HFR36** You can also select the memory from which you want to play back your recordings.

Operating modes:



In any index screen:







Touch [Index Selection].

During single photo view, touch the screen once to display the controls then touch [Index Selection] to open the [Photos] index screen.



- 1 **HFR38/HFR37/HFR36** Touch the tab of the desired memory: built-in memory or memory card.
- 2 Touch a control button to select the content you want to play back.

Options

- [ **AVCHD Movies**] Scenes recorded in AVCHD organized by recording date.
- [ **AVCHD Gallery**] Scenes recorded in AVCHD organized by story ( 78).
- [ **MP4 Movies**] Scenes recorded in MP4.
- [ **Photos**] Photos' index screen.
- [ **SD Movies**] (**HFR38/HFR37/HFR36** only when a memory card is selected) Scenes that were converted to standard definition to upload them to the Web ( 139).

NOTES

- **HFR38/HFR37/HFR36** Fast/slow playback modes are not available for scenes converted to standard definition. Scenes in the [SD Movies] index screen can only be played back at normal speed.
- You cannot jump to the previous or next scene with MP4 movies.

Two playback modes for AVCHD movies: the [AVCHD Movies] index screen vs. the gallery

In the [AVCHD Movies] index screen you can find all the AVCHD movies you have recorded, conveniently organized by recording date. When you play back scenes from the [AVCHD Movies] index screen they will be played back in chronological order.

In the **gallery**, you can find your scenes grouped as video stories. If you record movies using the Story Creator function ( 67), your scenes will appear in the story you created; scenes recorded without using this function will appear in the [Unsorted] story (or [Video Snapshot] story, in the case of video snapshot scenes). When you play back a story from the gallery, scenes will be played back in the order of the story's outline, regardless of their recording date.

Deleting Scenes and Stories

You can delete those scenes and stories that you are not interested in keeping. Deleting scenes allows you also to free up space on the memory.

Deleting a Single Scene

Operating modes:



1 Play back the scene you wish to delete.

When playing back a scene in the gallery, pause the scene you wish to delete and then continue to step 2.

2 Touch the screen to display the playback controls.

3 Delete the scene.



Deleting Scenes from the [AVCHD Movies] or [MP4 Movies] Index Screen

Operating modes:



1 Open the [AVCHD Movies] or [MP4 Movies] index screen.

For AVCHD movies, to delete all the scenes recorded on a specific date, drag your finger left/right until the desired date appears in the title bar.

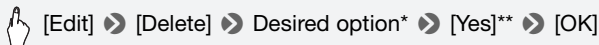

2 Delete the scenes.



* When you select [Select], perform the following procedure to select the individual scenes you want to delete before touching [Yes].

** Touch [Stop] to interrupt the operation while it is in progress. Some scenes may be deleted nevertheless.

To select individual scenes

- 1 Touch on the individual scenes you want to delete.
 - A checkmark ✓ will appear on the scenes you touch. The total number of selected scenes will appear next to the  icon.
 - Touch a selected scene to remove the checkmark. To remove all checkmarks at once, touch [Remove All]  [Yes].
- 2 After selecting all the desired scenes, touch [OK].

Options

[date] Delete all the scenes recorded on the date shown in the control button. For AVCHD movies only.

[Select] Select individual scenes to delete.

[All Scenes] Delete all the scenes.

Deleting a Single Scene from a Story

Operating modes:



- 1 Open the list of scenes of the story that contains the scene you want to delete.

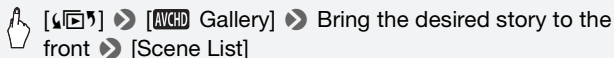

- 2 In the [Scene List] screen, drag your finger up/down to select the scene you want to delete.
- 3 Touch the orange  icon on the left to open the [Edit Scene] screen.
- 4 Delete the scene.

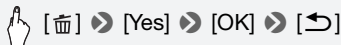

Deleting Scenes from a Story by Rating

Operating modes:



- 1 Open the information screen of the story that contains the scenes you want to delete.

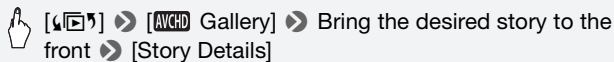

- 2 Open the rating selection screen.

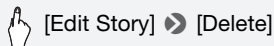

- 3 Touch one or more of the rating buttons to select all the applicable scenes.

- A grayed out rating button indicates that no scenes in the story have been given that particular rating.
- The number of selected scenes appears on the screen.
- Touch the rating button again to remove those scenes from the selection.

- 4 Delete all applicable scenes.



- * Touch [Stop] to interrupt the operation while it is in progress. Some scenes may be deleted nevertheless.

Deleting Stories

Operating modes:



Deleting a story permanently deletes all the scenes it contains. The two preexisting stories, [Unsorted] and [Video Snapshot], cannot be deleted.

1 Open the gallery.



2 Select the story you want to delete.

Drag your finger right/left to bring the desired story to the front.

3 Delete the story.

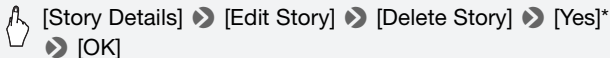

* Touch [Stop] to interrupt the operation while it is in progress. Some scenes may be deleted nevertheless.

! IMPORTANT

- Be careful when deleting recordings. Once deleted, scenes cannot be recovered.
- Deleting a story permanently deletes all the scenes it contains.
- When deleting scenes, scenes will be removed from the [AVCHD Movies] or [MP4 Movies] index screen and from any stories in the gallery they may have belonged to, regardless of the method used to delete them.
- Save copies of important scenes before deleting them (129).
- Observe the following precautions while the ACCESS indicator is on or flashing (while scenes are being deleted).
 - Do not open the memory card slot cover.
 - Do not disconnect the power source or turn off the camcorder.
 - Do not change the camcorder's operating mode.

NOTES

- To delete all movies and make all recordable space available again you may prefer to initialize the memory ( 41).

Selecting the Playback Starting Point

If you have a very long scene, you may want to start playing back the scene from a certain point. You can use the movie timeline to break the scene to segments at fixed time intervals ranging from 6 seconds to 6 minutes.

Operating modes:



- 1 Open the [**AVCHD** Movies] index screen.
- 2 Open the scene's [Timeline] screen.



The [Timeline] screen appears. The large thumbnail will show the first frame of the scene. Below it, the timeline ruler shows frames taken from the scene at fixed intervals.

- 3 **Touch the desired frame in the timeline ruler to start playing back the scene from that point.**

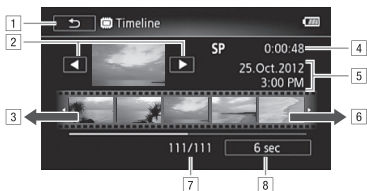

- 1 Touch twice to return to the index screen.
- 2 Previous/next scene.
- 3 Drag your finger left along the ruler to display the next 5 frames.
- 4 Scene's recording mode and length.
- 5 Recording date and time.
- 6 Drag your finger right along the ruler to display the previous 5 frames.
- 7 Current scene / Total number of scenes.
- 8 Currently selected interval between frames.

To change the interval between frames



[6 sec] ➤ Desired interval ➤ [↶]

Onscreen Displays and Data Code

With every scene or photo recorded, the camcorder keeps a data code. For AVCHD movies, the data code includes date/time of recording, information about the camera setup, etc. For MP4 movies, the data code is the date of recording. You can choose the information to be displayed.

Operating modes:



- 1 Press **HOME**.
- 2 Select the information to be displayed.

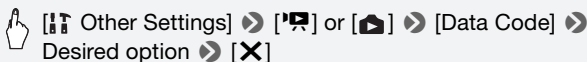

i NOTES

- The data code will appear when the screen is touched, regardless of the selected option.

Video Stories and Cinema Style

Using Story Creator to Create Compelling Stories

Story Creator is a helpful function that offers suggestions for typical scenes in a number of situations. With Story Creator, creating interesting video stories is as easy as selecting one of the story themes, such as [Travel], [Party] or [Kids & Pets], and following the suggested categories to record video. During playback, select your story from the gallery to play back the scenes you recorded as a single, compelling video story (📖 78).

Operating modes:



Creating a New Story

- 1 Press **[HOME]**.
- 2 Start Story Creator mode.

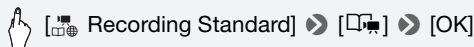

- 3 Touch **[Create New Story]** and select the desired theme.
Drag your finger left/right to bring the desired story theme to the front.
- 4 Touch **[Create Story]** and then select the story scene (category).

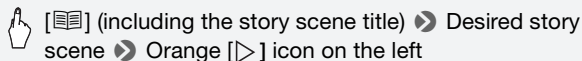

Initially, the current date will be used as the story's title, but you can change it by touching **[Keyboard]** (📖 87).

- 5 Touch **[To Recording Screen]**.

A confirmation screen will appear that shows the selected theme, story scene (category), shooting advice and the recommended shooting length.

6 Touch [OK].

- A new story will be created and the camcorder will enter record pause mode. The selected story scene category will appear at the bottom of the screen.
- If you touch [?], a screen showing the selected theme, story scene (category), shooting advice and the recommended shooting length will appear.

Recording a Scene within a Story

Press [START/STOP] to record movies within the selected story scene (category).

- Use the displayed recommended length as a reference when recording scenes.
- Scenes will be recorded under the story and story scene currently selected.
- You can also record video snapshot scenes (📖 72).

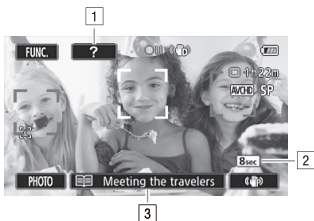

- 1 Shooting tip for the current category.
- 2 Recommended length of scenes in this category.
- 3 Currently selected story scene (category). You can touch here to return to the list of story scenes.

To select a different story scene (category)

- 1 Touch [📖] (including the story scene title) at the bottom of the screen.
- 2 Drag your finger up/down to select another category and touch the orange [▶] icon on the left.

To exit Story Creator mode

- 1 Press **[HOME]**.
- 2 Touch **[Recording Standard]** and then select a different recording standard.

NOTES

- When recording video snapshot scenes, you can have the camcorder automatically link the length of video snapshot scenes to the recommended length of story scenes with the **[Video Snapshot Length]** setting.
- Relay recording is not available during Story Creator mode.

Recording Additional Scenes within an Existing Story

- 1 Press **[HOME]**.
- 2 Start Story Creator mode.

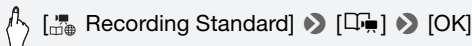

- 3 Touch **[Continue Existing Story]** and select the desired story.
Drag your finger left/right to bring the desired story to the front and then touch **[Continue Story]**.
- 4 Touch **[Story List]** (including the story scene title).
The list of story scenes will appear. The numbers on the right will show how many scenes you have recorded in each story scene (category).
- 5 Drag your finger up/down to select a category and touch the orange **[Play]** icon on the left.
- 6 Touch **[To Recording Screen]** and then press **[START/STOP]** to record a scene within the selected story scene.

Cinema Mode and Cinema-Look Filters

In  (cinema) mode, the camcorder will adjust the frame rate and several other picture-related settings to give your recordings a cinematic look. In this mode you can also use a variety of professional cinema-look filters to create unique movies with a distinctive appearance.

Operating modes:



- 1 Press **HOME** .
- 2 Set the camera mode to  .

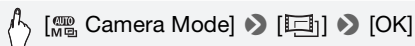

- 3 Select the desired cinema-look filter.

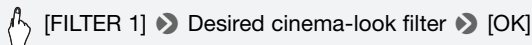

- The selected cinema-look filter will be applied and its number will appear on the control button.

Options (♦ Default value)

The camcorder offers 7 cinema-look filters. Select the desired filter while previewing the effect on the screen.

[1: **Cinema Standard**]♦

[2: **Vivid**]

[3: **Cool**]

[4: **Nostalgic**]

[5: **Sepia**]

[6: **Old Movies**]

[7: **Dramatic B&W**]

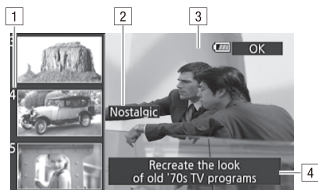

- 1 Filter number (will appear on the control button)
- 2 Filter name
- 3 Preview the effect on the screen
- 4 Brief description (onscreen guidance)

NOTES

- Photos cannot be recorded while the camcorder is set to  mode.

Video Snapshot

Record a series of short scenes. Then, play back your video snapshot scenes set to your favorite music (📖 82) to create your own fun music video. You will be surprised how by changing the background music, you can give your scenes an entirely new feel.

The default length of a video snapshot scene is 4 seconds but you can change it to 2 or 8 seconds, or to the length recommended for the selected story scene (category) in Story Creator, with the [📺] ▶ [Video Snapshot Length] setting.

Operating modes:



1 Press VIDEO SNAP.

- A blue border appears on the screen.
- Press VIDEO SNAP again to return to normal video recording mode.

2 Press START/STOP.

- The camcorder records for a few seconds (the blue frame serves as a visual progress bar) and then automatically returns to record pause mode.
- When the camcorder stops recording, the screen will momentarily turn black as if a camera shutter had released.

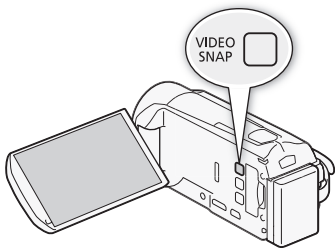

i NOTES

- Changing the camcorder to playback mode will deactivate the video snapshot mode.

Decoration: Adding a Personal Touch

Add a new level of enjoyment to your scenes by decorating them. You can add animated graphics, stamps and even your own freehand drawings. The supplied stylus pen will be especially useful for decorating scenes.

You can decorate scenes as they are being recorded, during playback or just before converting them to standard definition (HFR38 / HFR37 / HFR36 only;  140).

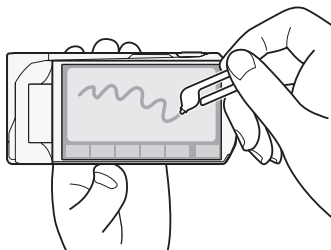

Decorating Scenes while Recording

Operating modes:



1 Open the decoration screen.



- The decoration screen will open automatically also when you stow the LCD panel with the touch screen facing out.
- 2 Use a tool from the toolbar as explained in the following procedures.
 - 3 Press **[START/STOP]** to record movies with your decorations.
You can add decorations even while recording a scene.
 - 4 Touch **[X]** to exit the decoration screen.

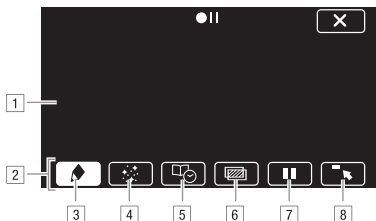

- 1 Canvas - The area where you will draw and see your decorations in action.
- 2 Toolbar.
- 3 [🖋️ Pens and Stamps] Select the type of pen or stamp and its color. You can also save a canvas or load a previously saved canvas.
- 4 [🌟 Animated Stamps] Select animated stamps to add to your decoration.
- 5 [🗉 Captions] Add the date, date and time, story title* or story theme* as a caption that will be included in the recording.
- 6 [🖼️]** (Image Mix) Choose one of 27 different frames to add onto the canvas. Image mix can be used in combination with the pens, stamps and animated stamps.
- 7 [⏸]** In recording mode: pause the live video. Touch [⏸] again to restore the live video. You can add decorations to and record the frozen image.
In playback mode: pause the playback. Touch [▶] to resume playing back the scene.
- 8 [🔼] Minimize the toolbar to the top of the screen to view almost all of the canvas. Touch [🔽] to restore the toolbar.

* Not available in  mode.

** Not available in  mode and for MP4 movies.

To use [Pens and Stamps]

- 1 Touch .

The [Pens and Stamps] screen will appear.

- 2 Select the desired pen or stamp from [Tools].

- 3 Select white or black from [Colors].

Alternatively, you can touch  and select a color from the color palette.

- 4 Draw freely on the canvas.

Touch  ➤ [Clear] ➤ [Yes] to clear the canvas and start again.

- 5 When you finish drawing, save the canvas.



* The freehand drawings and stamps will be saved in the built-in memory (**HFR38**/**HFR37**/**HFR36** only) or on a memory card (**HFR306** only).

To load a previously saved canvas

In the decoration screen:

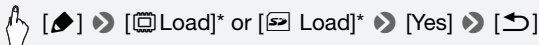

* The camcorder will apply the last freehand drawings and stamps that were saved in the built-in memory (**HFR38**/**HFR37**/**HFR36** only) or on a memory card (**HFR306** only).

To use [Animated Stamps]

- 1 Touch .

The [Animated Stamps] screen will appear.

- 2 Touch one of the control buttons.

- 3 Touch anywhere on the canvas to place the selected animated stamp. You can also drag some animated stamps to a different location.

To use [Captions]



- 1 Touch .

The [Captions] screen will appear.

- 2 Touch [Date] or [Time].

When recording a scene using Story Creator, you can also select [Title] (the story's title) or [Story Scene] (the story scene category).

- 3 Select the desired text settings and touch .

- Touch  (white text on dark background),  (white text) or  (black text).

- 4 Touch the caption and drag it to the desired location.

To use image mix

To use the image mix function when recording on a memory card, you will need to connect the memory card to a computer and transfer the image mix data from the supplied LEGRIA CD-ROM to the memory card in advance.

See *About the image files for the Image Mix function* ( 218).

Operating modes:



- 1 Touch  to open the [Select Image] screen.

- 2 Touch [+] or [-] to select a different image mix frame.

HFR38 / HFR37 / HFR36 You can touch one of the memory icons at the bottom of the screen to read image mix frames saved on a different memory (only when recording on or playing back scenes from a memory card).

- 3 Touch  to mix the selected frame with the live video.







Operating modes:



- 1 From the [AVCHD Movies] index screen or gallery, play back the scene you want to decorate.
- 2 Touch the screen to display the playback controls.
- 3 Touch [] to open the decoration screen.
- 4 Decorate the scene using the tools from the toolbar as explained in the previous section.

In playback mode, the decorations will not be saved with the original recording.

NOTES

- Initializing a memory will erase any [Pens and Stamps] drawing canvas and image files you may have saved. (HFR38/HFR37/HFR36 The image mix frames that come pre-installed in the built-in memory will be restored after it is initialized.)
- When   [Autostart Decoration] is set to [ON On], the decoration screen will open automatically when you stow the LCD panel with the LCD screen facing out.
- Animated stamps and captions cannot be used at the same time.
- HFR38/HFR37/HFR36 When   [Rec Media for Movies] is set to  (the built-in memory), you will not be able to select image mix frames saved on a memory card.
- Image mix cannot be selected during playback or while converting a scene to standard definition ( 139; HFR38/HFR37/HFR36 only). Select the image mix during playback pause or before starting the conversion.
- For AVCHD movies, decorations will appear in the thumbnails of scenes in the [AVCHD Movies] index screen and gallery. For MP4 movies, decorations will not appear in thumbnails.

Playing Back Stories from the Gallery

You can play back recordings made using Story Creator to play them back as a single compelling video story following the order of the story's script. Regular scenes and video snapshot scenes recorded without using Story Creator, will appear in the gallery under the [Unsorted] or [Video Snapshot] stories. When playing back stories from the gallery, you can choose to play back only scenes with a certain rating.

Operating modes:



1 Open the gallery.

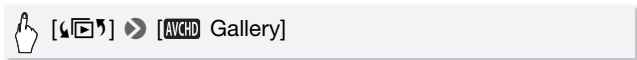

- 1 Open the [Index Selection] screen (87).
- 2 Drag your finger right or left to select a story.
- 3 Story's theme.
- 4 Selected story (large thumbnail in the front).
- 5 Story's title (87).
- 6 Details about the story (number of scenes, total playback time) and editing options.
- 7 List of scenes recorded in the selected story.

2 Select the story you want to play back.

Drag your finger right/left to bring the desired story to the front.

3 Select the rating of the scenes you want to play back.

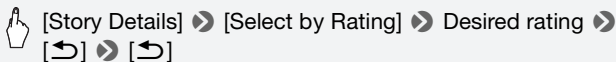

4 Touch the story's thumbnail to start the playback.

- The complete story will be played back from the first scene to the last. When playback ends, the camcorder will return to the gallery.
- During the playback of a story other than [Unsorted] or [Video Snapshot], touch the screen and then touch [] to display the scene's category during playback. Touch the screen and then touch [] again to turn the story scene display off.
- Playback controls are the same as when playing back scenes from the [AVCHD Movies] or [MP4 Movies] index screen (55).

IMPORTANT

- Observe the following precautions while the ACCESS indicator is on or flashing. Failing to do so may result in permanent data loss.
 - Do not open the memory card slot cover.
 - Do not disconnect the power source or turn off the camcorder.
 - Do not change the camcorder's operating mode.

NOTES

- If playback of a scene in the gallery is interrupted, you cannot resume playback at the point it stopped. The story will start over from the beginning the next time you play it back.

Rating Scenes

You can rate story scenes immediately after recording them or during playback. You can then select multiple scenes with the same rating, for example, in order to play back or copy only your favorite scenes.

Rating Scenes Immediately After Recording

Operating modes:



- 1 Press **[HOME]**.
- 2 Activate the scene rating function.

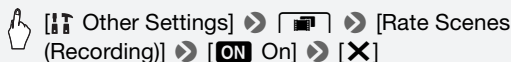

To rate scenes

Immediately after recording a scene, rating buttons will appear at the bottom of the screen. Touch one of the rating buttons to rate the scene from one to three stars. You can touch [**• • •**] to leave the scene unrated or to classify it in a separate category (for example, just for outtakes).

To turn off the scene rating function

When the rating buttons appear after recording a scene, touch [**X**] and then touch [Off]. This will also leave the current the scene unrated.

Rating Scenes from the List of Scenes

Operating modes:



- 1 Press **[HOME]**.

- 2 Open the list of scenes of the story that contains the scenes you want to rate.

 [⏪] [⏩] ➤ [AVCHD Gallery] ➤ Bring the desired story to the front ➤ [Scene List]

- 3 In the [Scene List] screen, drag your finger up/down to select the scene you want to rate.
- 4 Touch the orange [▶] icon on the left to open the [Edit Scene] screen.
- 5 Touch the control button of the desired rating and touch [↩] twice to return to the gallery.

Rating Scenes During Playback

Operating modes:



- 1 Play back from the gallery the story that contains the scenes you want to rate.
- 2 During playback of a scene you want to rate, pause the playback and rate the scene.

 Touch the screen ➤ [||] ➤ [Edit] ➤ [Rating] ➤ Desired rating ➤ [X]

- 3 Touch [▶] to resume the playback and rate other scenes in the same way or touch [■] to return to the gallery.

Playback with Background Music

You can play back movies (or a photo slideshow) using one of the supplied music tracks as background music.

Operating modes:



The supplied LEGRIA CD-ROM contains 3 music tracks you can use as background music. **HFR38** / **HFR37** / **HFR36**: The music files come pre-installed in the built-in memory.

You can mix the original audio and the background music and adjust the background music mix balance to your preference.



POINTS TO CHECK

- To play back scenes or a slideshow of photos recorded on a memory card, you will need to connect the memory card that contains your recordings to a computer and transfer the music tracks in advance. See the NOTES section (84).

1 Press **[HOME]**.

2 Open the gallery or **[AVCHD Movies]** index screen.



3 Press **[HOME]**.

4 Select the music track.

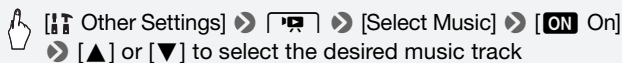

➤ **[▲]** or **[▼]** to select the desired music track

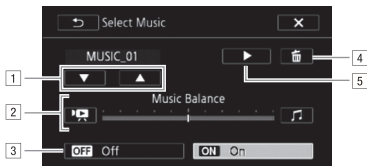

- 1 Select the desired music track.
- 2 Adjust the background music balance.
- 3 Play back the original sound (no background music).
- 4 Delete the music track selected.
- 5 Listen to the music track selected. Touch again (■) to stop the playback.

5 Adjust the mix balance between the original sound and the background music.

Touch [🔊] (more of the original sound) or [🎵] (more of the background music) or drag your finger along the [Music Balance] bar to adjust the background music balance as desired.

6 Touch [X] and then touch a story or scene to start the playback with the selected background music.

To adjust the background music balance during playback

- 1 During playback, touch the screen to display the playback controls.
- 2 Touch [🎵], drag your finger along the [Music Balance] bar to adjust the background music balance as desired and touch [↩].

To delete a music track

In the [Select Music] screen, touch [▲] or [▼] to select the track you want to delete.



[🗑] ➡ [Yes]

IMPORTANT

- If you use copyrighted songs and music tracks in your video creations, remember that music under copyright may not be used without permission from the copyright holder, except for cases permitted under applicable laws, such as for personal use. Make sure to follow applicable laws when using music files.

NOTES

- Initializing a memory card will permanently erase any music files you may have transferred to the card. (**HFR38/HFR37/HFR36** The music files that come pre-installed in the built-in memory will be restored after it is initialized.) To transfer music files from the supplied LEGRIA CD-ROM to the memory card connected to a computer:
 - Windows users: Remove the memory card from the camcorder, connect it to a computer and use the supplied software **VideoBrowser** (**HFR38/HFR37/HFR36** only) or **Transfer Utility** (**HFR306** only). For details, refer to the Software Guide (PDF file) of the supplied PIXELA's software.
 - Mac OS users: Remove the memory card from the camcorder and connect it to a computer. Use Finder to transfer music files from the [MUSIC] folder on the supplied LEGRIA CD-ROM to the memory card connected to a computer. Refer to *About the music files* ( 218) for the folder structure of the memory card.
- Transfer music files to the memory card connected to a computer that contains the recordings you want to play back with background music.

Copying and Moving Scenes Within/Between Stories

You can copy and move scenes in the gallery within the same story scene (category), between story scenes in the same story, and between stories recorded in the same memory.

Operating modes:



- 1 Open the list of scenes of the story that contains the scene you want to copy or move.

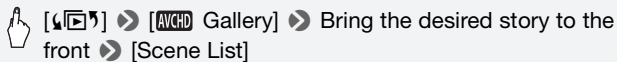

- 2 In the [Scene List] screen, drag your finger up/down to select the scene you want to copy/move.
- 3 Touch the orange [▷] icon on the left to open the [Edit Scene] screen and touch [Copy] or [Move].

- 4 Select the destination.

Drag your finger right/left to select the desired story and touch its thumbnail. Then, drag your finger up/down to select the desired category and touch the orange [▷] icon on the left. And last, drag your finger up/down to move the orange bar within the category to select the position of the scene.

- 5 Copy or move the scene.



- ¹ This step is not necessary when copying/moving a scene into a story scene category that contains no other scenes.
- ² When copying a scene, you can touch [Stop] to interrupt the operation while it is in progress.
- ³ This step is not necessary when moving a scene.

NOTES

- You cannot copy or move scenes to the two preexisting stories, [Unsorted] and [Video Snapshot].

Selecting a Story's Thumbnail Image

Initially, the image used as the story's thumbnail is the first frame of the first scene in the story. You can set your favorite scene as the thumbnail that will represent the story in the gallery.

Operating modes:



1 Open the gallery.



2 Select the story whose thumbnail you want to change.

Drag your finger right/left to bring the desired story to the front.

3 Open the [Story Thumbnail] screen.

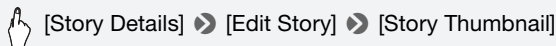

4 Locate the frame you want to use as the story's thumbnail.

Playback controls will appear on the screen (📖 55). Use any special playback modes (fast/slow playback, frame reverse/advance) as necessary to locate the desired image.

5 Touch [Set] to change the story's thumbnail.

6 Touch [↩] to return to the gallery.

Changing a Story's Title

When you first create a story, the current date will be used as the story's title but you can change the title later on. The title can be up to 14 characters long (available characters are limited). The title of the two preexisting stories, [Unsorted] and [Video Snapshot] cannot be changed.

Operating modes:



1 Open the gallery.



2 Select the story whose title you want to change.

Drag your finger right/left to bring the desired story to the front.

3 Open the [Edit Title] screen.

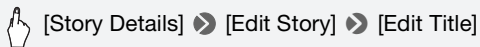

4 Use the virtual keyboard to change the title.

5 Touch [OK] ➤ [↶] ➤ [↷] to return to the gallery.



- 1 Switch between letters and numbers/special characters.
- 2 Change the position of the cursor.
- 3 Delete the character to the cursor's left (backspace).
- 4 Caps Lock. When the numerical keyboard is displayed, [#%?] switches between set 1 and set 2 of special characters.

i NOTES

- We recommend using the supplied stylus pen to enter characters.
- **HFR38** / **HFR37** / **HFR36** When you import files with the supplied software **VideoBrowser** using the option to join and import music and video files from the gallery, some special characters in the story's title (/, \, <, >, :, *, ", |, ?) will be changed to an underscore (_) in the file name.

Advanced Functions

Recording in Manual Mode

When the camcorder is set to **[M]** mode, you can enjoy full access to the menus and manually adjust the exposure, focus, white balance and many more of the camcorder's settings to your preference. Even in this mode, though, the camcorder can help you with the settings. For example, by using Special Scene recording programs (📖 94).

Operating modes:



1 Press **[POWER]** to turn on the camcorder.

- **[HFR38] / [HFR37] / [HFR36]** By default, movies and photos are recorded in the built-in memory. You can select the memory that will be used to record movies and photos (📖 39).
- Please read the **IMPORTANT** section (📖 47) before using an Eye-Fi card.

2 Open the lens cover switch.

3 Press **[HOME]**.

To change the recording standard, refer to *Recording* (📖 30).

4 Set the camcorder to **[M]** mode.

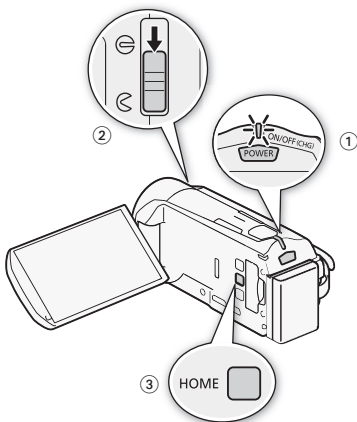



[**AUTO** / **M**] Camera Mode] ➤ [**M**] ➤ [OK]

5 Record movies and photos.

The procedure is the same as in **[AUTO]** mode (📖 43).

IMPORTANT

- To protect the lens, keep the lens cover closed when you are not recording movies and when you are not using the camcorder.
- Observe the following precautions while the ACCESS indicator is on or flashing. Failing to do so may result in permanent data loss or damage to the memory.
 - Do not open the memory card slot cover.
 - Do not disconnect the power source or turn off the camcorder.
 - Do not change the camcorder's operating mode.
- Be sure to save your recordings regularly ( 126), especially after making important recordings. Canon shall not be liable for any loss or corruption of data.
- Recordings on an Eye-Fi card will be uploaded automatically after setting the camcorder to playback mode, if you are within the range of a configured network. Always verify that Eye-Fi cards have been approved in the country/region of use. See also *Using an Eye-Fi card* ( 145).

NOTES



- The zoom, Quick Start function, power saving modes, etc. operate the same way in **M** mode as in **AUTO** mode. For details, refer to *AUTO Mode* ( 43).
- Photos cannot be recorded while the digital zoom is activated (light blue area on the zoom bar) or while fading in or fading out a scene.

Reviewing the Latest Scene Recorded

You can review the last 4 seconds of the last scene recorded with the camcorder without switching to playback mode. While reviewing the latest scene, the picture will be played back without sound.

Operating modes:



 [FUNC.]  [ Review Recording]

NOTES

- For MP4 movies, you cannot review the last movie recorded if, after you recorded the movie, you performed another operation such as opening a menu.

Selecting the Video Quality (Recording Mode)

The camcorder offers 5 recording modes for recording AVCHD movies and 2 for MP4 movies. Changing the recording mode will change the recording time available on the memory. For AVCHD movies, select MXP or FXP mode for better movie quality; select LP mode for longer recording times.

For MP4 movies, you can choose one of two bit rates. Bit rate indicates how much information is recorded in 1 second of video. Select 4 Mbps for smaller file sizes and faster uploads.

The following table gives approximate recording times.

Operating modes:



1 Press **HOME**.

2 Select the recording mode.



For MP4 movies, a single scene can be recorded continuously for 30 minutes. The **30min** icon in the upper left is a reminder of this. If the file size reaches 4 GB even before 30 minutes has elapsed, however, recording will stop.



NOTES

- Movies recorded in MXP mode cannot be saved on AVCHD discs. Use an external Blu-ray Disc recorder to copy MXP movies onto Blu-ray discs. **HFR38** / **HFR37** / **HFR36** Alternatively, you can use the supplied software **VideoBrowser** to create AVCHD discs*.
- The camcorder uses a variable bit rate (VBR) to encode video so the actual recording times will vary depending on the content of the scenes.
- You cannot create a video disc of MP4 movies that is playable on commercially available players.

* MXP scenes will be converted to an image quality similar to that of FXP scenes.

Approximate recording times

◆ Default value

AVCHD movies in MXP mode are recorded in 1,920 x 1,080 resolution. AVCHD movies recorded using other recording modes are recorded in 1,440 x 1,080 resolution. MP4 movies are recorded in 1,280 x 720 resolution.

For AVCHD movies:

Recording mode →	MXP	FXP	XP+	SP◆	LP
Memory ↓					
4 GB Memory card	20 min.	30 min.	40 min.	1 hr. 10 min.	1 hr. 30 min.
8 GB Memory card/ HFR37 / HFR36 Built-in memory ¹	40 min.	1 hr.	1 hr. 25 min.	2 hr. 20 min.	3 hr.
16 GB Memory card	1 hr. 25 min.	2 hr. 5 min.	2 hr. 50 min.	4 hr. 45 min.	6 hr. 5 min.
32 GB Memory card/ HFR38 Built-in memory ¹	2 hr. 55 min.	4 hr. 10 min.	5 hr. 45 min.	9 hr. 35 min.	12 hr. 15 min. ²

For MP4 movies:

Recording mode →	9 Mbps	4 Mbps
Memory ↓		
4 GB Memory card	55 min.	2 hr. 5 min.
8 GB Memory card/ HFR37 / HFR36 Built-in memory ¹	1 hr. 50 min.	4 hr. 10 min.
16 GB Memory card	3 hr. 50 min.	8 hr. 25 min.
32 GB Memory card/ HFR38 Built-in memory ¹	7 hr. 40 min.	16 hr. 55 min.

¹ **HFR38** / **HFR37** / **HFR36** At the time of purchase, the built-in memory contains about 70 MB of music files (background music), 5 MB of image files (image mix frames) and about 2 MB of file management data.

² A single scene can be recorded continuously for 12 hours; at that point, the camcorder will stop for about 3 seconds before resuming recording.

Selecting the Frame Rate

You can change the frame rate (the number of frames recorded per second) to change the look of your movies. When recording MP4 movies, the frame rate will be [25P 25P].

Operating modes:



- 1 Press **HOME**.
- 2 Select the frame rate.



Options ^(Default value)

[50i 50i (Standard)][♦] 50 fields per second, interlaced. Standard frame rate of PAL analog TV signals.

[PF25 PF25]** Shooting at 25 frames per second, progressive*. Using this frame rate will give your recordings a cinematic look. Recording in  mode will further enhance the effect.

* Recorded as 50i.

** Default option for  mode.

NOTES

- The frame rate can be set independently for **M** and  modes.



Special Scene Recording Programs and Programmed AE

Recording in a very bright ski resort or capturing the full colors of a sunset or a fireworks display becomes as easy as selecting a Special Scene recording program.

On the other hand, you can select the Programmed AE (AE: auto exposure) recording program. With this recording program, the camcorder automatically adjusts the shutter speed and aperture while you are able to adjust the other settings.



Operating modes:



 [FUNC.] ➤ [Rec. Programs] ➤ [ SCN: Portrait]* ➤
Desired recording program ➤ []

* To set the Programmed AE recording program, select [**P** Programmed AE] instead and then touch []. The rest of the procedure is not necessary.

Options (Default value)

[ **SCN: Portrait**] The camcorder uses a large aperture, to achieve a sharp focus on the subject while blurring the background.



[ **SCN: Sports**] To record sports scenes such as tennis or golf.



[ **SCN: Night Scene**] To record nightscapes with lower noise.

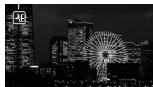

[ **SCN: Snow**] To record in bright ski resorts without the subject being underexposed.



[ **SCN: Beach**] To record on a sunny beach without the subject being underexposed.



[ **SCN: Sunset**] To record sunsets in vibrant colors.



[🌙 SCN: Low Light] To record in low-light situations.



[📀 SCN: Spotlight] To record spotlit scenes.



[🎆 SCN: Fireworks] To record fireworks.



i NOTES

- [👤 SCN: Portrait]/[🏊 SCN: Sports]/[❄️ SCN: Snow]/[🏖️ SCN: Beach]: The picture may not appear smooth during playback.
- [👤 SCN: Portrait]: The blur effect of the background increases the more you zoom in (T).
- [❄️ SCN: Snow]/[🏖️ SCN: Beach]: The subject may become overexposed on cloudy days or in shaded places. Check the image on the screen.
- [🌙 SCN: Low Light]:
 - Moving subjects may leave a trailing afterimage.
 - Picture quality may not be as good as in other modes.
 - White points may appear on the screen.
 - Autofocus may not work as well as in other modes. In such case, adjust the focus manually.
- [🎆 SCN: Fireworks]:
 - To avoid camcorder blur (blur due to the camcorder moving) we recommend using a tripod.

Advanced Image Stabilization

The image stabilizer reduces camcorder blur (blur due to the camcorder moving) so you can get nice, stable shots. Select the image stabilization mode according to the shooting conditions.

Operating modes:



1 Press **HOME**.

2 Select the IS mode.



Options (♦ Default value)

- [Dynamic]♦** Compensates for a higher degree of camcorder shake, such as when shooting while walking, and is more effective as the zoom approaches full wide angle.
- [Standard]** Compensates for a lower degree of camcorder shake, such as when shooting while remaining stationary, and is suitable for shooting natural-looking scenes.
- [Off]** Use this setting when the camcorder is mounted on a tripod.



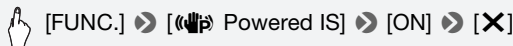

Powered IS

You can use Powered IS to make the image stabilization even more powerful. Powered IS is most effective when you are stationary and zooming in on far subjects using high zoom ratios (the more you approach the telephoto end). Holding the LCD panel with your left hand will add to the stability of the shot.



- By default, the custom control button (179) is set to [Powered IS].

NOTES

- If the degree of camcorder shake is too high, the image stabilizer may not be able to fully compensate.
- [ Dynamic] is available only when [Zoom Type] is set to [ 32x Optical].
- For surveying and following shots, when you pan the camcorder from side to side or tilt it up and down, we recommend setting the IS mode to [ Dynamic] or [ Standard].

Pre-Recording

The camcorder will start recording 3 seconds before you press **[START/STOP]**, ensuring you do not miss important shooting opportunities. This is especially useful when it is difficult to predict when to start recording.

Operating modes:



1 Activate the pre-recording function.



-  will appear on the screen.
- Repeat, selecting [OFF], to turn off pre-recording.

2 Press **[START/STOP]**.

The scene recorded in the memory will start 3 seconds before **[START/STOP]** was pressed.

NOTES

- The camcorder will not record the full 3 seconds prior to pressing **[START/STOP]** if the button was pressed within 3 seconds of having turned on pre-recording or having finished the previous recording.
- Any of the following actions will deactivate the pre-recording function.
 - Leaving the camcorder without any operation for 5 minutes.
 - Changing the operating mode.
 - Pressing **[VIDEO SNAP]**.
 - Opening the decoration screen.
 - Closing the LCD panel to set the camcorder to standby mode.
 - Touching any of the following control buttons in the [Main Functions] panel: [Rec. Programs], [White Balance], [Faders], [Decoration] or [Review Recording].
 - Opening the [Other Settings] menus.

Face Detection



The camcorder automatically detects people's faces and uses this information to select the optimal settings for beautiful videos and photos.

Operating modes:



* Face detection is always activated in **[AUTO]** mode.

POINTS TO CHECK

- Select a recording program other than [ SCN: Night Scene], [ SCN: Low Light] or [ SCN: Fireworks].

By default, face detection is activated. If the function was turned off, perform the following procedure to turn it on.

1 Press **[HOME]**.

2 Activate face detection.

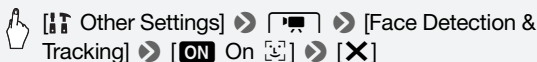

To select the main subject

If there is more than one person in the picture, the camcorder will automatically select one person it determines is the main subject. The main subject is indicated by a white face detection frame and the camcorder will optimize the settings for that person. Other faces will have gray frames.

Touch a different face on the touch screen to optimize the camcorder's settings for that person using the Touch & Track function.



Main subject

i NOTES

- The camcorder may mistakenly detect the faces of non-human subjects. In such case, turn face detection off.
- In certain cases, faces may not be detected correctly. Typical examples include:
 - Faces extremely small, large, dark or bright in relation to the overall picture.
 - Faces turned to the side, at a diagonal or partially hidden.
- Face detection cannot be used when the shutter speed used is slower than 1/25 or when the digital zoom is activated at more than 144x zoom.
- When face detection is activated, the slowest shutter speed used by the camcorder is 1/25.

Touch & Track

When recording a group of people using face detection, the camcorder will automatically detect one person as the main subject. You can use Touch & Track to tell the camcorder to track and optimize settings for a different person. You can also use Touch & Track to always keep in focus other moving subjects, such as pets or moving vehicles.

Operating modes:



1 Make sure face detection is activated (📖 99).

Face detection is always activated in **AUTO** mode.

2 Point the camcorder at a moving subject and touch the subject on the touch screen.

- A white double frame will appear around the subject and track it as it moves.
- Touch [Cancel ] to remove the frame and cancel the tracking.

NOTES

- Touching somewhere with a color or pattern unique to the subject will make it easier to track. However, if there is another subject in the vicinity that shares similar characteristics to the selected subject, the camcorder may start tracking the incorrect subject. Touch the screen again to select the desired subject.
- In certain cases, Touch & Track may not be able to track the subject. Typical examples include:
 - Subjects extremely small or large in relation to the overall picture.
 - Subjects too similar to the background.
 - Subjects lacking sufficient contrast.
 - Fast moving subjects.
 - When shooting indoors with insufficient lighting.

Faders

The camcorder offers two professional looking transition effects to fade-in or fade-out scenes. You have the option to activate the fader only one time or every time you start or stop recording.

Operating modes:



 [FUNC.] ➤  Faders] ➤ Desired fader* ➤ [X]



* You can preview the transition effect on the screen.

- The icon of the selected fader appears in green.

To fade in/out

Press **[START/STOP]** in record pause mode (●||) to start recording with a fade in. Press **[START/STOP]** while recording (●) to fade out and pause the recording.

NOTES

- When you apply a fader, not only the picture but also the sound will fade in or out.
- Faders cannot be used in the following cases:
 - While using the [Old Movies] cinema-look filter in  mode.
 - When recording scenes with decorations.
 - When recording video snapshot scenes.
 - While pre-recording is activated.
- You can select whether to fade to/from a black screen or a white screen with the  ➤ [Fader Setting] setting.

Manual Exposure Adjustment

At times, backlit subjects may appear too dark (underexposed) or subjects under very strong lights may appear too bright or glaring (overexposed). To correct this, you can adjust the exposure manually or use the Touch AE function to automatically set the optimal exposure for the subject you select. This is convenient when the brightness of the subject you want to shoot is noticeably brighter/darker than the general brightness of the image.

Operating modes:



POINTS TO CHECK

- Select a recording program other than [ SCN: Fireworks].

1 Open the exposure adjustment screen.



2 Touch a subject that appears inside the frame.

- The Touch AE mark () will flash and the exposure will be adjusted automatically so the area you touched will be correctly exposed. You have the option to further adjust the exposure manually as necessary.
- You can touch [**M**] instead to adjust the exposure manually without activating the Touch AE function.
- The manual adjustment dial appears and the adjustment value is set at ± 0 .
- Touch [**M**] again to return the camcorder to automatic exposure.









3 Touch [] or [] or drag your finger along the dial to set the exposure adjustment value.

The adjustment range may vary depending on the initial brightness of the image, and some values may be grayed out.

4 Touch [**X**] to lock the exposure at the selected value.

During exposure lock,  and the selected exposure adjustment value will appear on the screen.

NOTES

- If the recording program is changed during exposure lock, the camcorder will return to automatic exposure.
 - When shooting subjects with a strong light source behind them, the camcorder automatically corrects for the backlight*. You can turn off the automatic backlight correction with the []  [Auto Backlight Correction] setting. Note that the automatic backlight correction is not available in the following cases.
 - In [] mode, when using a cinema-look filter other than [Cinema Standard].
 - When using the [] SCN: Night Scene], [] SCN: Snow], [] SCN: Beach], [] SCN: Sunset] or [] SCN: Spotlight] recording program.
- * Except in [] mode when using a cinema-look filter other than [Cinema Standard].

Manual Focus Adjustment

Autofocus may not work well on the following subjects. In such case, focus manually.

- Reflective surfaces
- Subjects with low contrast or without vertical lines
- Fast moving subjects
- Through wet windows
- Night scenes

Operating modes:



POINTS TO CHECK

- Adjust the zoom before you start the procedure.



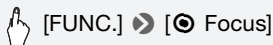



1 Open the manual focus screen.



2 Touch a subject that appears inside the frame.

- The Touch AF mark () will flash and the focusing distance will be adjusted automatically. You have the option to further adjust the focus manually as necessary.
- You can touch **[MF]** instead to adjust the focus manually without activating the Touch AF function.
- The manual focus controls appear.
- Touch **[MF]** again to return the camcorder to autofocus.

3 Touch and hold or to adjust the focus.

- The center of the screen will be magnified to help you focus more easily. You can also turn off this function with the   [Focus Assistance] setting.
- The focusing distance displayed will change as you adjust the focus. The focusing distance will be displayed for about 2 seconds. You can change the units used for the distance display with the   [Distance Units] setting.
- If you wish to focus on faraway subjects such as mountains or fireworks, touch and hold  until the focusing distance changes to .

4 Touch [X] to lock the focus at the selected distance.

During manual focus, [MF] will appear on the screen.

NOTES

- During manual focus, you can touch inside the frame to activate the Touch AF function and autofocus on a subject.

Tele Macro

Using tele macro, the camcorder can focus at a shorter distance (up to 50 cm from the subject at full telephoto), allowing you get closer shots of small subjects like flowers and insects. This function also adds a soft focus to the background, so the subject not only looks larger but it also stands out more.



Operating modes:



- * In **AUTO** mode, tele macro will be activated automatically when you zoom in to full telephoto and bring the camcorder up close to the subject.

POINTS TO CHECK



- Select a recording program other than [: SCN: Fireworks].

 [FUNC.] ➤ [ZOOM] ➤ []* (tele macro) ➤ [X]

* Touch again to turn off the tele macro function.

- The camcorder will automatically adjust the zoom to the telephoto end.

NOTES

- Any of the following actions will deactivate the tele macro function.
 - Turning off the camcorder.
 - Pressing .
 - Setting the camcorder to **AUTO** mode.
 - Zooming out toward **W** (wide angle).
 - Changing the recording program to [ SCN: Fireworks].
- Tele macro cannot be turned on/off while recording.

White Balance

The white balance function helps you to accurately reproduce colors under different lighting conditions so that white objects will always look truly white in your recordings.

Operating modes:



POINTS TO CHECK

- Set the recording program to [**P** Programmed AE].

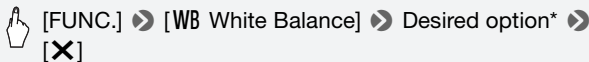



* When you select [ Custom WB], set the custom white balance with the following procedure before touching [**X**].

To set the custom white balance



Point the camcorder at a white object, so it fills the whole screen, and touch [**Set WB**].

When the adjustment is completed,  stops flashing and disappears. The camcorder will retain the custom white balance even if you turn it off.

Options (♦ Default value)

- [**AWB Automatic**]♦ The camcorder automatically sets the white balance for natural looking colors.
- [ **Daylight**] To record outdoors.
- [ **Tungsten**] To record under tungsten and tungsten-type (3-wavelength) fluorescent lighting.
- [ **Custom WB**] Use the custom white balance setting to make white subjects appear white under colored lighting.

NOTES

- **When you select the custom white balance:**
 - Set [Zoom Type] ( 50) to [**32x**] Optical.
 - Reset the white balance when you change locations or the lighting or other conditions change.
 - Depending on the light source,  may keep flashing. The result will still be better than with [**AWB Automatic**].
- Custom white balance may provide better results in the following cases:
 - Changing lighting conditions
 - Close-ups
 - Subjects in a single color (sky, sea or forest)
 - Under mercury lamps, certain types of fluorescent lights and LED lights

Self Timer

Operating modes:



* For movies only.

1 Press **[HOME]**.

2 **Activate the self timer.**



- will appear on the screen.
- Repeat, selecting **[OFF Off]**, to turn off the self timer.

Movies: In record pause mode, press **[START/STOP]**.

The camcorder starts recording after a 10-second countdown. The countdown appears on the screen.

Photos: In record pause mode, touch **[PHOTO]**.

- The camcorder will record the photo after a 10-second countdown. The countdown appears on the screen.
- Photos cannot be recorded while the camcorder is set to mode.

NOTES

- Once the countdown has begun, any of the following actions will cancel the self timer.
 - Pressing **[START/STOP]**, when recording movies.
 - Touching **[PHOTO]**, when recording photos.
 - Turning off the camcorder.
 - Changing the camcorder's operating mode.
 - Closing the LCD panel to set the camcorder to standby mode.

Audio Recording Level

You can adjust the audio recording level of the built-in microphone. You can display the audio level indicator while recording.

Operating modes:



Manual Adjustment of the Audio Recording Level

1 Open the manual audio recording level adjustment screen.

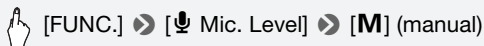

- The audio level indicator and current audio recording level will appear on the screen.
- Touch [**A**] (automatic) to return the camcorder to automatic audio recording levels.

Manual audio level adjustment

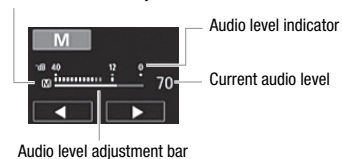

2 Touch and hold [**◀**] or [**▶**] to adjust the audio recording level as necessary.

As a guideline, adjust the audio recording level so that the audio level meter will go to the right of the -12 dB mark (yellow area) only occasionally.

3 Touch [**✕**] to lock the audio recording level at the current level.

To display the audio level indicator



Usually, the audio level indicator will be displayed only after activating the manual adjustment of the audio recording level. You can choose to display it also when the audio level is adjusted automatically.

 [FUNC.] ➤ [🎤 Mic. Level] ➤ [A] (automatic) ➤
[Audio Level Indicator] ➤ [X]

NOTES

- When the audio level meter reaches the red point (0 dB), the sound may be distorted.
- If the audio level is too high and the sound gets distorted, activate the microphone attenuator with the  ➤ [Microphone Attenuator] setting.
- We recommend using headphones to check the sound level while adjusting the audio recording level or when the microphone attenuator is activated.

Using Headphones

Use headphones for playback or to check the audio level while recording. The headphones are connected to the AV OUT/ terminal, which is used for both the headphones and the audio/video output. Before connecting the headphones, follow the procedure below to change the function of the terminal from AV output to  (headphones) output.

Operating modes:







   |    |  

- 1 Press .
- 2 Change the function of the terminal to headphones output.

 [🔧 Other Settings] ➤  ➤ [AV/Headphones] ➤
[🎧 Headphones] ➤ [↩]

- 3 Connect the headphones to the AV OUT/ terminal.

4 Adjust the volume as necessary.



 [Volume]  [] or []* to adjust the volume  []

* You can also drag your finger along the [Headphones] bar.

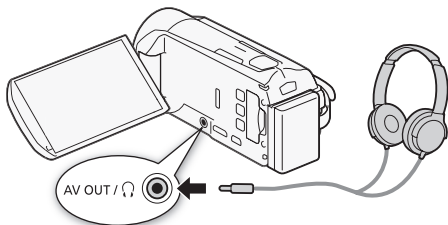

-  will appear on the screen.





To adjust the volume during playback

In  mode, and in  mode during slideshow playback, adjust the headphones volume the same way you adjust the speaker's volume ( 55, 120).

IMPORTANT

- When using headphones, make sure to lower the volume to an appropriate level.
- Do not connect the headphones to the AV OUT/ terminal if the  icon does not appear on the screen. The noise output in such case may be harmful to your hearing.

NOTES

- Use commercially available headphones with a \varnothing 3.5 mm minijack and a cable no longer than 3 m.
- Even if [AV/Headphones] was set to [ Headphones] in a playback mode, the function of the AV OUT/ terminal will return automatically to AV output when you turn off the camcorder.

Capturing Video Snapshot Scenes and Photos from a Movie

You can capture video snapshot scenes or photos from a previously recorded scene. For example, you may want to print photos from video recorded at a party or create a small video clip using video snapshot scenes from the highlights of an event.



Operating modes:



Capturing a Video Snapshot Scene

1 Play back the scene or story from which you want to capture the video snapshot scene.

2 Press **[START/STOP] to capture the video snapshot scene.**

The camcorder captures the video snapshot scene for about 4 seconds (the blue frame serves as a visual progress bar), and then enters playback pause mode. You can change the length of the video snapshot scenes you capture to 2 or 8 seconds with the   [Video Snapshot Length] setting.

3 Touch **[■] to stop the playback.**

NOTES

- A video snapshot scene can be captured only during playback; it cannot be captured during playback pause mode.
- The captured video snapshot scene is saved to the same memory that contains the source scene.
- Video snapshot scenes cannot be captured from any of the following types of scenes.
 - Scenes shorter than 1 second
 - **HFR38/HFR37/HFR36** Scenes that were edited using the supplied software **VideoBrowser** and were then transferred to a memory card connected to the computer.
- When the source scene is itself a video snapshot scene, you may not be able to capture a video snapshot scene depending on the length of the source scene and the length currently selected for video snapshot scenes.

- When you start capturing a video snapshot scene less than 1 second from the end of the scene, the video snapshot scene will be captured starting from the beginning of the following scene.
- During the playback of video snapshot scenes captured from a previously recorded movie, you may notice some anomalies in the picture/sound at the point where the playback switches to a new scene.

Capturing Photos

The size of the captured photos will be 1920x1080 and it cannot be changed.

Please read the IMPORTANT section before using an Eye-Fi card.

- 1 **Play back the scene or story from which you want to capture the photo.**
- 2 **Pause the playback at the point you want to capture.**
- 3 **Touch [PHOTO].**
- 4 **Touch the screen and then touch [■] to stop the playback.**

IMPORTANT

- When capturing photos on an Eye-Fi card, photos will be uploaded automatically if you are within the range of a configured network. Always verify that Eye-Fi cards have been approved in the country/region of use. See also *Using an Eye-Fi card* (📖 145).

NOTES

- The data code of the photos will reflect the date and time of recording of the original scene.
- Photos captured from a scene with a lot of fast movement may be blurred.
- Photos will be recorded on the memory selected for recording photos.

Dividing Scenes

You can divide scenes in order to leave out the best parts and later cut out the rest.

Operating modes:



- 1 Play back the scene you want to divide.
- 2 Pause the playback at the point where you want to divide the scene.
- 3 Open the scene division screen.

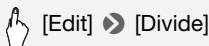

- 4 Bring the scene to a precise point, if necessary.

Playback controls will appear on the screen (📖 55). Use any special playback modes (fast playback, frame reverse/advance) as necessary to locate the desired point.

- 5 Divide the scene.

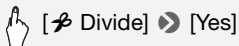

- The video from the division point to the end of the scene will appear as a new scene in the index screen.

NOTES

- When advancing/reversing frames while dividing the scenes, the interval between frames is about 0.5 seconds.
- If the scene cannot be divided at the point where you paused the playback, advance/reverse a frame and then divide the scene.
- During the playback of a scene that was divided, you may notice some anomalies in the picture/sound at the point where the scene was cut.
- The following scenes cannot be divided:
 - Video snapshot scenes and other scenes that are too short (less than 3 seconds).
 - **HFR38**/**HFR37**/**HFR36** Scenes that were edited using the supplied software **VideoBrowser** and were then transferred to a memory card connected to the computer.
- Scenes cannot be divided within 1 second from the beginning or the end of the scene.



Photos

Refer to this chapter for details on viewing photos and other photo-related operations.

Viewing Photos

Operating modes:



1 Press .

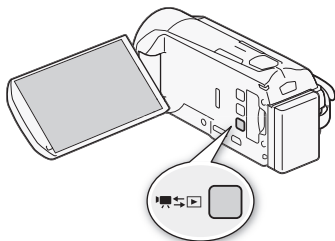

2 Open the [ Photos] index screen, if it is not displayed.

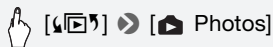

3 Look for the photo you want to play back.

Move the zoom lever toward **W** to show 15 photos per page; move it toward **T** to show 6 photos per page.



- 1 Open the [📷] [📷] Index Selection] screen (📖 58).
- 2 Memory being read.
- 3 Drag your finger left/right for the next/previous index page*.
- 4 Display the next/previous index page.

* While browsing through index pages, a larger scroll bar will appear at the bottom of the screen for a few seconds. When you have a large number of photos it may be more convenient to drag your finger along the scroll bar.

4 Touch the photo you wish to view.

- The photo is displayed in single photo view.
- Drag your finger left/right to browse through the photos one by one.





To return to the index screen from single photo view

- 1 Touch the screen to display the playback controls.
- 2 Touch [📷].

Photo Jump Function

When you have recorded a large number of photos, you can jump easily through the photos using the scroll bar.

- 1 Touch the screen to display the playback controls.
- 2 Jump through the photos using the scroll bar.



 Drag your finger left and right along the scroll bar
 

IMPORTANT

- Observe the following precautions while the ACCESS indicator is on or flashing. Failing to do so may result in permanent data loss.
 - Do not open the memory card slot cover.
 - Do not disconnect the power source or turn off the camcorder.
 - Do not change the camcorder's operating mode.
- Even if you transfer them to a memory card connected to a computer, the following image files may not be displayed correctly using the camcorder.
 - Images not recorded with this camcorder.
 - Images edited on a computer.
 - Images whose file names have been changed.

Deleting Photos

You can delete those photos that you are not interested in keeping.

Operating modes:



Deleting a Single Photo

- 1 In single photo view, select the photo you want to delete.
- 2 Touch the screen to display the playback controls.
- 3 Delete the photo.



[Edit] ➤ [Delete] ➤ [🗑️ Proceed] ➤ [Yes]

- 4 Drag your finger left/right to select another photo to delete or touch [X].

1 Open the [📷 Photos] index screen.

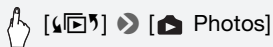

2 Delete the photos.

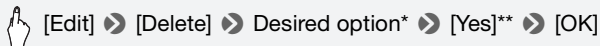

* When you select [Select], perform the following procedure to select the individual photos you want to delete before touching [Yes].

**Touch [Stop] to interrupt the operation while it is in progress. Some photos will be deleted nevertheless.

To select individual photos

1 Touch on the individual photos you want to delete.

- A checkmark ✓ will appear on the photos you touch. The total number of selected photos will appear next to the icon.
- Touch a selected photo to remove the checkmark. To remove all checkmarks at once, touch [Remove All] ➤ [Yes].

2 After selecting all the desired photos, touch [OK].

Options

[Select] Select individual photos to delete.

[All Photos] Delete all the photos.

! IMPORTANT

- Be careful when deleting photos. Deleted photos cannot be recovered.
- Photos that were protected with other devices and then transferred to the memory card when it was connected to a computer cannot be deleted with this camcorder.

Slideshow

You can play a slideshow of all the photos and even set it to music.

Operating modes:



- 1 Open the [📷 Photos] index screen.

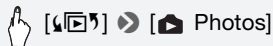

- 2 Select the music track to use during the photo slideshow.

Refer to steps 3 and 4 of *Playback with Background Music* (📖 82).

- 3 Touch the photo that will open the slideshow to display it in single photo view.
- 4 Touch the screen to display the playback controls, then touch [▶] to play back the slideshow set to the selected music track.

During the photo slideshow

- Touch the screen and drag your finger left and right along the volume bar to adjust the volume.
- Touch the screen and touch [⏏] to stop the slideshow.

To change the slideshow's transition effects

- 1 Press [HOME].
- 2 Select the transition effect.





External Connections

This chapter explains how to connect your camcorder to an external device such as a TV, VCR, or computer. **HFR38 / HFR37 / HFR36** You can also use the camcorder's convenient Wi-Fi functions (📖 147).

Terminals on the Camcorder

Open the LCD panel to access the terminals on the camcorder.

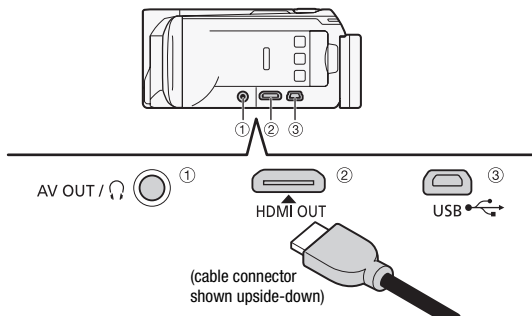

① **AV OUT / 🎧 Terminal**

② **HDMI OUT Terminal***

The HDMI OUT terminal offers a high-quality digital connection that combines audio and video in a single convenient cable. This terminal is an HDMI mini receptacle. When using a commercially available HDMI cable, make sure the HDMI cable is Type A to Type C.

③ **USB Terminal**

This terminal is a mini-AB receptacle. You can use the supplied USB cable to connect to a computer or other digital devices with standard-A receptacles; or use the optional UA-100 USB Adapter to connect to the camcorder an external hard drive or similar storage device with a standard-A cable (**HFR38 / HFR37 / HFR36** only).

* When connecting an HDMI cable to the camcorder, make sure to align the triangle marks on the cable's connector and on the camcorder's terminal.





Connection Diagrams

In the following connection diagrams, the left side shows the terminals on the camcorder and the right side shows (for reference only) an example of terminals on a connected device.

Connection 1

HDMI

Type: Digital • Quality: High definition • Output only

Connect to a high-definition TV (HDTV) with an HDMI input terminal. If your HDTV supports HDMI-CEC, you can activate this with the   [Control for HDMI] setting. You can check the standard of the current output signal with the   [HDMI Status] setting.

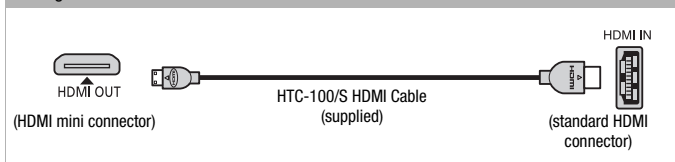

About the HDMI™ connection

The HDMI (High-Definition Multimedia Interface) connection (1) is a convenient all-digital connection using a single cable for both video and audio. When you connect the camcorder to an HDTV equipped with an HDMI terminal, you can enjoy video and audio playback at the highest quality.

- The HDMI OUT terminal on the camcorder is for output only. Do not connect it to an HDMI output terminal on an external device, as this may damage the camcorder.
- While the camcorder is connected to an HDTV using connection 1, there will be no video output from the AV OUT/ terminal.
- Correct operation cannot be guaranteed when connecting the camcorder to DVI monitors.
- Depending on the HDTV, correct playback of personal video content may not be possible using connection 1. Try another connection.

Type: Analog • Quality: Standard definition • Output only

Connect to a standard TV or a VCR with audio/video input terminals. Change the following settings on the camcorder:

- [] / [] ➤ [TV Type] according to the TV set (widescreen or 4:3), if the TV cannot automatically detect and change the aspect ratio
- [] ➤ [AV/Headphones] to [**AV** AV]



In all respects, exactly the same connection as connection 2.

Connect to a standard TV or VCR with SCART input terminal. Requires a SCART adapter (commercially available).

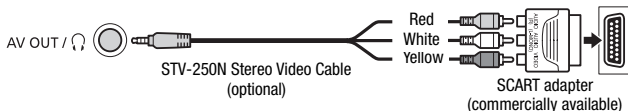

Type: Digital data connection • Output only

Connect to a computer to save your recordings, to a compatible digital video recorder to copy your recordings, or to an external hard drive to easily save a perfect copy of an entire memory (**HFR38/HFR37/HFR36** only).

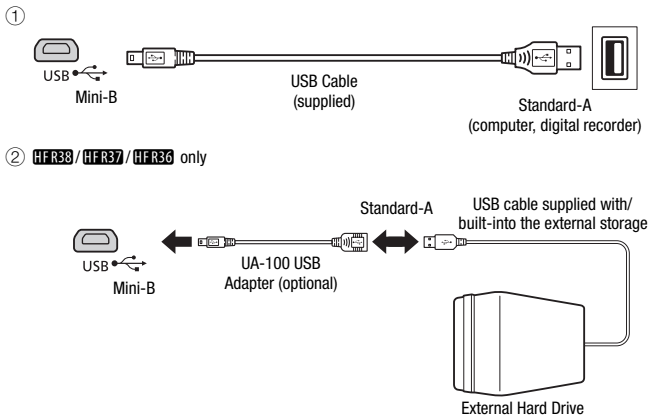
**i** NOTES

- Power the camcorder using the compact power adapter and only then connect it to the computer using the supplied USB cable in the following cases.
 - To save your recordings on a computer.
 - To save a memory onto an external hard drive.
- Sound from the built-in speaker will be muted while a cable is connected to the HDMI OUT terminal or AV OUT/🔊 terminal.

Playback on a TV Screen

Connect the camcorder to a TV to enjoy your recordings with family and friends. Playback on an HDTV using the HDMI OUT terminal will ensure the best playback quality.

Operating modes:



1 Turn off the camcorder and the TV.

2 Connect the camcorder to the TV.

Refer to *Connection Diagrams* (📖 122) and select the most appropriate connection for your TV.



3 Turn on the connected TV.

On the TV, select as the video input the same terminal to which you connected the camcorder. Refer to the instruction manual of the connected TV.

4 Turn on the camcorder and set it to or mode.

Play back the movies or photos.

NOTES

- To correctly play back movies recorded with x.v.Color (📖 174) on an HDTV compatible with this standard, additional settings may be required on the connected HDTV. Refer to the TV's instruction manual.
- You can also play video directly from your memory card on AVCHD-compatible HDTVs and digital recorders with a card slot **compatible with the type of memory used***.
- We recommend powering the camcorder using the compact power adapter.
- Connection  or : When you play back your 16:9 movies on standard TV sets with a 4:3 aspect ratio, the TV set will switch automatically to widescreen mode if it is compatible with the WSS system. Otherwise, change the aspect ratio of the TV manually.

* Refer to the instruction manual of the device. Depending on the device used, correct playback may not be possible even if the device is AVCHD-compatible. In such case, play back the recordings on the memory card using the camcorder.

Saving and Sharing Your Recordings

HFR38 / HFR37 / HFR36 Copying Movies and Photos to a Memory Card

You can copy your recordings from the built-in memory to a memory card. Scenes and photos will be copied from the index screen or from a story in the gallery in the built-in memory to the same index screen or story on the memory card.

Please read the IMPORTANT section (📖 129) before using an Eye-Fi card.

Copying Scenes from the [AVCHD Movies] or [MP4 Movies] Index Screen

Operating modes:



1 Open the [AVCHD Movies] or [MP4 Movies] index screen.

- Check that you have selected the (built-in memory) tab.
- For AVCHD movies, to copy all the scenes recorded on a specific date, drag your finger left/right until the desired date appears in the title bar.

2 Copy the scenes.

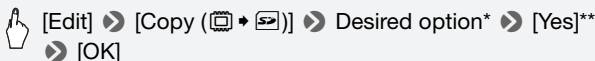

* When you select [Select], perform the following procedure to select the individual scenes you want to copy before touching [Yes].

** Touch [Stop] to interrupt the operation while it is in progress.

To select individual scenes

1 Touch on the individual scenes you want to copy.

- A checkmark ✓ will appear on the scenes you touch. The total number of selected scenes will appear next to the icon.
- Touch a selected scene to remove the checkmark. To remove all checkmarks at once, touch [Remove All] [Yes].

2 After selecting all the desired scenes, touch [OK].

Options

[date] Copy all the scenes recorded on the date shown in the control button. For AVCHD movies only.

[Select] Select individual scenes to copy.

[All Scenes] Copy all the scenes.

Copying Scenes from a Story by Rating

Operating modes:



1 Open the gallery and bring the desired story to the front.



- Check that you have selected the  (built-in memory) tab.

2 Select the rating of the stories you want to copy.

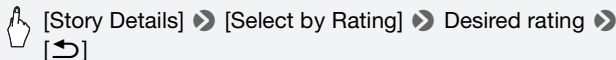

3 Copy all the applicable scenes.

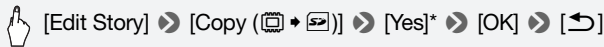

- * Touch [Stop] to interrupt the operation while it is in progress.

Copying a Single Photo

Operating modes:



1 In single photo view, select the photo you want to copy.

2 Touch the screen to display the playback controls.

3 Copy the photo.



4 Drag your finger left/right to select another photo to copy or touch [X].

Copying Photos from the Index Screen

Operating modes:



1 Open the [Photos] index screen.

Check that you have selected the  (built-in memory) tab.

2 Copy the photos.

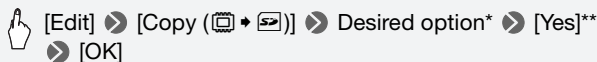



* When you select [Select], perform the following procedure to select the individual photos you want to copy before touching [Yes].

**Touch [Stop] to interrupt the operation while it is in progress.

To select individual photos

1 Touch on the individual photos you want to copy.

- A checkmark ✓ will appear on the photos you touch. The total number of selected photos will appear next to the  icon.
- Touch a selected photo to remove the checkmark. To remove all checkmarks at once, touch [Remove All]  [Yes].

2 After selecting all the desired photos, touch [OK].

Options

[Select] Select individual photos to copy.

[All Photos] Copy all the photos.

IMPORTANT

- Observe the following precautions while the ACCESS indicator is on or flashing. Failing to do so may result in permanent data loss.
 - Do not open the memory card slot cover.
 - Do not disconnect the power source or turn off the camcorder.
 - Do not change the camcorder's operating mode.
- When copying photos onto an Eye-Fi card, photos will be uploaded automatically if you are within the range of a configured network. Always verify that Eye-Fi cards have been approved in the country/region of use. See also *Using an Eye-Fi card* ( 145).

NOTES

- In the following cases, you will not be able to copy recordings to the memory card:
 - If the memory card slot cover is open.
 - If the LOCK switch on the memory card is set to prevent writing.
 - If the file numbering is at maximum ( 175).
 - If there is no memory card in the memory card slot.
- Scenes that were edited using the supplied software **VideoBrowser** and were then transferred to a memory card connected to the computer cannot be copied to another memory card.
- If there is not enough space on the memory card, as many files as possible will be copied before stopping the operation.

Saving Recordings on a Computer

Movies recorded with this camcorder are saved in the built-in memory (**HFR38** / **HFR37** / **HFR36** only) or on a memory card. Because space is limited, make sure to save your recordings on a computer on a regular basis.

This section explains how to save your recordings on a computer using a USB connection. Use the supplied software **VideoBrowser** (**HFR38** / **HFR37** / **HFR36** only) or **Transfer Utility** (**HFR306** only) for AVCHD movies and the supplied software **ImageBrowser EX** for MP4 movies.

HFR38 / **HFR37** / **HFR36** Refer to *Wi-Fi Functions* ( 147) for details on saving your recordings wirelessly.

Saving AVCHD Movies (Windows only)

With the supplied software **VideoBrowser** (**HFR38**/**HFR37**/**HFR36** only) or **Transfer Utility** (**HFR306** only), you can save to your computer the scenes you have recorded.

Installation

Install the software before you connect the camcorder to the computer for the first time. Refer to the Startup Guide (supplied leaflet) and follow the instructions in the Software Guide (PDF file) to install the supplied PIXELA's software.

Connecting the Camcorder to a Computer



- 1 Power the camcorder using the compact power adapter.
- 2 Open the [**AVCHD** Movies] or [**AVCHD** Gallery] index screen.
- 3 Connect the camcorder to the computer using the supplied USB cable.

Connection -. Refer to *Connection Diagrams* ( 124).

- 4 **Camcorder: Select [All (for PC only)].**

Camcorder: When the connection is successfully established, [USB Connection] appears on the screen.

- 5 **Computer: The supplied PIXELA's software will start up automatically.**

- **VideoBrowser** (**HFR38**/**HFR37**/**HFR36** only) : Click  in the menu panel to start transferring files. For details about using the software, click  to open the Software Guide (PDF file).
- **Transfer Utility** (**HFR306** only) : Click [Video file import] to start transferring files. For details about using the software, click [Help] to open the Software Guide (PDF file).

Saving MP4 Movies and Photos (Windows/Mac OS)

With the supplied software **ImageBrowser EX** you can save MP4 movies and photos to your computer and easily organize them. The main system requirements are as follows.

OS	CPU	Memory
Windows 7 (SP1, 32/64-bit)	Intel® Core™ 2 Duo, 1.66 GHz	1 GB (for 32-bit) 2 GB (for 64-bit)
Windows Vista (SP2, 32/64-bit)		1 GB
Windows XP (SP3, 32-bit only)		1 GB
Mac OS X v10.6	Intel® Core™ Duo, 2.00 GHz	1 GB

Installation

Install the software before you connect the camcorder to the computer for the first time. Make sure to install the software even if you have a different version of **ImageBrowser EX** on your computer. The auto-update function of the software may make available to you features optimized for this camcorder.

The 'ImageBrowser EX' User Guide will also be installed with the software.



POINTS TO CHECK

- Before installing the software, make sure your computer is connected to the Internet.
- 1 Turn on the computer.
 - 2 Insert the LEGRIA CD-ROM into the computer's disc drive.
 - 3 **Windows:** Open the drive into which you inserted the CD-ROM using Windows Explorer.
Mac OS: Click the CD-ROM icon on the desktop.
 - 4 Click/Double-click the Disc_Setup.exe icon.

5 In the installer panel, select your language and then click [Easy Installation].

6 Follow the onscreen instructions.

For Windows users, the User Account Control window appears, follow the instructions to continue.

To check that the software was installed correctly

You can check that the software was installed correctly by looking for the ImageBrowser EX icon in the following location.

Windows: From the Start Menu, All Programs ➤ Canon Utilities ➤ ImageBrowser EX

Mac OS: In the Dock, on the Desktop.

If you cannot find the icon, check your Internet connection and install the software again.

First-time connection to a computer running Windows

Windows users only: The first time you connect the camcorder to the computer, you also need to select the CameraWindow auto-launch setting.

Connecting the Camcorder to a Computer



- 1 Power the camcorder using the compact power adapter.
- 2 Open the [MP4 Movies] or [Photos] index screen.
- 3 Connect the camcorder to the computer using the supplied USB cable.
 - Connection [3]-①. Refer to *Connection Diagrams* (📖 124).
 - Camcorder: When the connection is successfully established, [USB Connection] appears on the screen.
- 4 Save the recordings onto the computer.

Refer to relevant sections in the 'ImageBrowser EX' User Guide.

IMPORTANT

- **When the camcorder is connected to a computer:**
 - Do not open the memory card slot cover and do not remove the memory card.
 - Do not access, change or delete any of the camcorder's folders or files directly from the computer as this may result in permanent data loss. Always use only the supplied software to save your recordings on the computer and, if necessary, to transfer previously saved video files to a memory card connected to the computer.
- Observe the following precautions while the ACCESS indicator is on or flashing. Failing to do so may result in permanent data loss.
 - Do not open the memory card slot cover.
 - Do not disconnect the USB cable.
 - Do not turn off the camcorder or the computer.
 - Do not change the camcorder's operating mode.
- Operation may not work correctly depending on the specifications/settings of your computer.
- If you wish to use the recordings on your computer, make copies of them first. Use the copied files, retaining the originals.

NOTES

- With the supplied software **VideoBrowser** (**HFR38** / **HFR37** / **HFR36** only) or **Transfer Utility** (**HFR306** only) you can also choose to save complete stories from the gallery. In such case, all the scenes in the story will be merged and saved as a single video file.
- **Users of Windows 7, Windows Vista, Windows XP and Mac OS X:** Your camcorder is equipped with the standard Picture Transfer Protocol (PTP) allowing you to transfer photos (JPEG only) simply by connecting the camcorder to a computer using the supplied USB cable, without having to install the supplied software **ImageBrowser EX**.
- If you connect the camcorder to the computer while it is set to  mode, the process of creating scene thumbnails will start automatically. If your intention was to save photos to the computer, you can touch [Skip] to stop the process and use the computer's Safely Remove Hardware function (Windows) or Eject function (Mac OS) to end the connection to the camcorder. Disconnect the USB cable, set the camcorder to  mode and restore the connection.

HFR38 / HFR37 / HFR36 Memory Save: Saving an Entire Memory onto an External Hard Drive



You can easily save all the movies and photos you recorded onto a commercially available external hard drive connected directly to the camcorder*. You can also use the camcorder to play back your recordings directly from the hard drive. Initialize the hard drive (📖 137) when you use it with this camcorder for the first time.

* If the USB cable supplied with the external hard drive has a standard-A connector, you will need to use the optional UA-100 USB Adapter or commercially available USB adapter.

Operating modes:



Saving a Memory onto an External Hard Drive

- 1 Power the camcorder using the compact power adapter.
- 2 Press  to set the camcorder to playback mode.
- 3 Connect the camcorder to the external hard drive using the optional UA-100 USB Adapter.
Connection -. Refer to *Connection Diagrams* (📖 124).
- 4 Save the entire contents of the desired memory.

 [Save to Hard Drive] ➤ Desired memory ➤ [Yes]*
➤ [OK]

* Touch [Stop] ➤ [Yes] ➤ [OK] to interrupt the operation while it is in progress.

- After selecting the memory, you can check the name of the folder that will be created on the hard drive. Every memory save operation will create a separate memory save folder with the date (in numerical form) used as the folder name; up to 10 memory save folders can be created for any given date and up to 300 memory save folders can be saved on a single hard drive.

Before disconnecting the external hard drive

Before turning off or physically disconnecting the external hard drive, be sure to safely end the connection to the camcorder to avoid damage to your files. From the [External Hard Drive] screen:



[Safely Remove Hard Drive] ► [Yes]

! IMPORTANT

- Make sure you power the camcorder with the compact power adapter before you save a memory to the external hard drive. If the compact power adapter becomes disconnected, the connection between the camcorder and the hard drive will end, which may lead to the corruption of data in the hard drive.

i NOTES

- Initialize the external hard drive (📖 137) when you use it with this camcorder for the first time.
- You cannot select both the built-in memory and memory card to save them simultaneously.
- You cannot use the following types of external hard drives.
 - USB-powered portable hard drives
 - Hard drives with a capacity over 2 TB
 - USB flash drives or media connected to card readers
- If the external hard drive is partitioned, only the first partition will be recognized.

Playing Back Previously Saved Recordings from the External Hard Drive

1 Power the camcorder using the compact power adapter.

2 Press  to set the camcorder to playback mode.

3 Connect the camcorder to the external hard drive using the optional UA-100 USB Adapter.

Connection -②. Refer to *Connection Diagrams* (📖 124).

4 Touch [Play Back from Hard Drive] and select the memory save folder you wish to play back.

- If you performed multiple memory save operations on the same day (for example, if you saved the built-in memory and then a memory

card), the folder name of memory save folders following the first one will end in a numerical suffix.

- The [AVCHD Movies] index screen will appear.

5 Play back the movies, stories and photos as you would do any other memory.

To switch to another memory save folder, touch [X] and then repeat step 4.

6 When you have finished playing back, be sure to safely end the connection to the external hard drive before physically disconnecting it.

From the gallery or index screen:

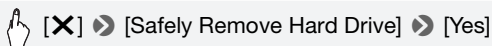

To delete a memory save folder

With the external hard drive connected to the camcorder:

- 1 Select the memory save folder you want to delete.
- 2 Press [HOME].
- 3 Delete the memory save folder.

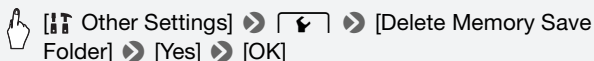

- 4 Safely end the connection to the external hard drive before physically disconnecting it.
 - Be careful when deleting recordings. Once deleted, recordings cannot be recovered.

- Observe the following precautions while the external hard drive's access indicator is on or flashing.
 - Do not disconnect the USB cable.
 - Do not disconnect the camcorder or the external hard drive.
 - Do not change the camcorder's operating mode.

Initializing the External Hard Drive

1 Power the camcorder using the compact power adapter.

Do not disconnect the power source or turn off the camcorder until the initialization is completed.

2 Press to set the camcorder to playback mode.

3 Connect the camcorder to the external hard drive using the optional UA-100 USB Adapter.

Connection -. Refer to *Connection Diagrams* ( 124).

4 Press .

5 Initialize the external hard drive.



¹ Touch this option if you want to physically erase all the data rather than just clear the file allocation table of the hard drive. For large-capacity hard drives this operation can take several hours.

² If you selected the [Complete Initialization] option, you can touch [Cancel] > [OK] to cancel the initialization while it is in progress. All recordings will be erased and the hard drive can be used without any problem.

6 Safely end the connection to the external hard drive before physically disconnecting it.

IMPORTANT

- Initializing the external hard drive will permanently erase all the data on the hard drive (including your recordings, previous data not saved with the camcorder, and partitioned drives). Make sure to copy in advance important data to a computer or other device.

Copying Recordings to an External Video Recorder

Operating modes:



In High Definition

Connect the camcorder to Blu-ray Disc recorders and other AVCHD-compatible digital video recorders using the supplied USB cable to make perfect copies of your movies in high definition. If the external digital video recorder has an SD memory card slot*, you can use the memory card to copy your movies without connecting the camcorder.

* Make sure the external device is compatible with the type of memory card used.

Connecting

- 1 Power the camcorder using the compact power adapter.
- 2 Open the [AVCHD Movies], [MP4 Movies] index screen or gallery.
- 3 Connect the camcorder to the digital video recorder using the supplied USB cable.

Connection 3-1. Refer to *Connection Diagrams* (124).

- 4 **HFR38 / HFR37 / HFR36 Camcorder:** Select the memory that contains the scenes you want to copy.
 - Select an option other than [All (for PC only)].
 - When the connection is successfully established, [USB Connection] appears on the screen.



Recording

Details will vary depending on the device used so be sure to refer to the instruction manual of the digital video recorder.





In Standard Definition



You can copy your movies by connecting the camcorder to a VCR or a digital video recorder with analog audio/video inputs. Video output will be in standard definition, although the original scenes are in high definition.

Connecting

Connect the camcorder to the VCR using Connection  or . Refer to *Connection Diagrams* ( 123).

Recording

- 1 External recorder: Load a blank cassette or disc and set the recorder to record pause mode.**
- 2 Turn on the camcorder and set it to  mode.**
 - We recommend powering the camcorder using the compact power adapter.
 - Verify that   [AV/Headphones] is set to [ AV].
- 3 Camcorder: Locate the scene or story you wish to copy and pause the playback shortly just before the desired scene.**
- 4 Camcorder: Resume playback.**

By default, onscreen displays will be embedded in the output video signal. You can change this using the   [Output Onscreen Displays] setting.
- 5 External recorder: Start recording when the scene you wish to copy appears; stop recording when it ends.**
- 6 Camcorder: Stop playback.**

/ / Uploading AVCHD Movies to the Web

In order to share your AVCHD movies on YouTube and Facebook, you need to convert them. This conversion can be completed in the camcorder itself or on a computer using the supplied software **Video-Browser**.

MP4 movies do not need to be converted as such in the camcorder or computer. You can share your MP4 movies (and photos) from a computer using the supplied software **ImageBrowser EX** ( 146).

Installation

Install the software before you connect the camcorder to the computer for the first time. Refer to the Startup Guide (supplied leaflet) and follow the instructions in the Software Guide (PDF file) to install the supplied PIXELA's software.

Converting Scenes into Standard Definition from the [AVCHD Movies] Index Screen

Operating modes:





- 1 Power the camcorder using the compact power adapter.**
- 2 Make sure there is a memory card in the memory card slot with sufficient available space.**
- 3 Open the [AVCHD Movies] index screen.**
 - Check that you have selected the (built-in memory) tab.
 - To convert all the scenes recorded on a specific date, drag your finger left/right until the desired date appears in the title bar.
- 4 Touch [Edit] ➤ [Convert HD➔SD (➔)] and select one of the options for converting multiple scenes.**
 - You can convert all the scenes recorded on the date shown in the control button, select individual scenes to convert or convert all the scenes.
 - When you select [Select], perform the procedure described below to select the individual scenes you want to convert.
- 5 Review the conversion settings and touch [Next].**
 - If a copyright notice appears, read it carefully and touch [OK] if you agree.
 - Before touching [Next], you can touch [] to change the conversion settings as described below.
- 6 Touch [START] to convert the scenes.**
 - Before touching [START], you can touch [] to decorate the converted SD movies (73), or touch [] to adjust the volume (55) and background music balance (83).
 - You can also decorate the scenes as they are being converted.
 - Touch [STOP] to interrupt the operation while it is in progress.

7 When the conversion is completed, a confirmation screen will appear.

To select individual scenes (step 4)

1 Touch on the individual scenes you want to convert.

- A checkmark ✓ will appear on the scenes you touch. The total number of selected scenes will appear next to the  icon.
- Touch a selected scene to remove the checkmark. To remove all checkmarks at once, touch [Remove All]  [Yes].

2 After selecting all the desired scenes, touch [OK].

To select the bit rate (step 5)

Using a higher bit rate will result in better video quality for the converted scenes, while a lower bit rate will result in smaller file sizes and faster uploads.

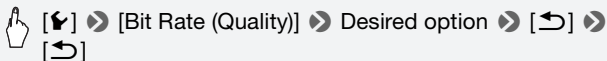

To automatically divide scenes (step 5)

If you are converting a long scene, you can have the camcorder divide it into 10-minute SD movies to make uploading easier.

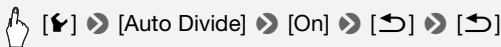

Converting Scenes into Standard Definition from a Story by Rating

Operating modes:





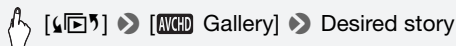

1 Open the gallery and bring the desired story to the front.

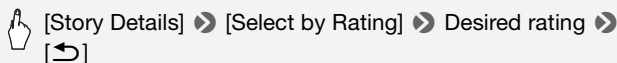

- Check that you have selected the  (built-in memory) tab.

2 Select the rating of the stories you want to convert.



3 Touch [Edit Story] > [Convert HD→SD (→)] and continue the conversion to standard definition from step 5 in the previous procedure ( 140).

NOTES

- **When converting scenes from a story:**

- All the scenes are merged into one converted SD movie.
- If the converted SD movie is too large, it will be split into smaller 10-minute long movies.
- The maximum total playback time of the scenes to be converted is 12 hours.

Operating modes:



1 Connect the camcorder to the computer using the supplied USB cable.

Connection 3-①. Refer to *Connection Diagrams* (124).

2 Select [All (for PC only)].

3 VideoBrowser will start up automatically.

Click the YouTube icon in the menu panel and follow the software's instructions to upload your SD movies to the Web. For details about using the software, click to open the Software Guide (PDF file).

! IMPORTANT

- While the camcorder is connected to the computer, do not open the memory card slot cover and do not remove the memory cards.
- Observe the following precautions while the ACCESS indicator is on or flashing. Failing to do so may result in permanent data loss.
 - Do not open the memory card slot cover.
 - Do not disconnect the USB cable.
 - Do not disconnect the compact power adapter or turn off the camcorder or the computer.

i NOTES

- The time required to convert scenes is approximately equal to the total playback time of the converted scenes. In most cases this is still faster than converting the scenes in the computer so we recommend you convert scenes in the camcorder.
- Movies cannot be converted if the file numbering is at maximum (175).
- You can check and play back the converted SD movies from the [SD Movies] index screen on the memory card.

Uploading your Videos Using an Eye-Fi Card

If you are using an Eye-Fi card, you can automatically upload movies to your favorite video sharing Web site. You will need to have installed the software supplied with your Eye-Fi card and completed all the required configuration setup in advance. Refer to the instruction manual of the Eye-Fi card. Also, note that not all Eye-Fi cards can upload AVCHD movies. Check compatibility in advance.

Please read the IMPORTANT section before using an Eye-Fi card.

Operating modes:



1 Insert your Eye-Fi card into the memory card slot and make sure there is sufficient available space on the memory card.

For MP4 movies, step 2 is not necessary. If you are within the range of a configured network, Web upload will start automatically.

2 Convert the desired movies (📖 140).



- If you are within the range of a configured network, Web upload will start automatically.
- The status of the wireless communication is shown by the Eye-Fi icon as follows:
 - 📶 (grayed out) Communication not established
 - 📶 (white, flashing) Connecting; 📶 (white, continuously on) Wireless upload on standby
 - 📶 (animated) Wireless upload in progress
 - 📶 [Eye-Fi Communication] is set to [OFF Off]
 - 📶 Wireless upload stopped by the camcorder (📖 191)
 - 📶 Error reading from the Eye-Fi card (📖 190)

IMPORTANT

Using an Eye-Fi Card

- This product is not guaranteed to support Eye-Fi card functions (including wireless transfer). In case of an issue with an Eye-Fi card, please check with the card manufacturer. Also note that an approval is required to use Eye-Fi cards in many countries or regions. Without approval, use of the card is not permitted. If it is unclear whether the card has been approved for use in the area, please check with the card manufacturer.
- Do not use Eye-Fi cards on airplanes and in other places where wireless communication is forbidden. Remove the Eye-Fi card from the camcorder beforehand.

NOTES

- Depending on the amount of data to be uploaded and the network's wireless connection conditions, it can take some time to upload video files. If the wireless connection is too weak, the wireless upload may fail and the video files will be registered as incomplete uploads.
- **About power saving when using an Eye-Fi card:**
 - Wireless communication drains the power of the battery pack faster than usual. We recommend powering the camcorder using the compact power adapter.
 - While files are being uploaded wirelessly, the camcorder's automatic power off function will be disabled.
- While using an Eye-Fi Card, the ACCESS indicator may flash from time to time.
- Wireless communication via the Eye-Fi card is available only in playback mode. Any wireless transfer in progress will be stopped if you set the camcorder to recording mode.
- **HFR38 / HFR37 / HFR36** Wireless communication via the Eye-Fi card is not available when using the camcorder's Wi-Fi functions.
- You can turn off the wireless communication with the   [Eye-Fi Communication]* setting.
- If the LOCK switch on the Eye-Fi card is set to prevent writing, you will not be able to turn the wireless communication on/off and the status icon will change to . To use wireless communication make sure the switch on the Eye-Fi card is not in the LOCK position.

* This menu option will appear only when using an Eye-Fi card.

Uploading MP4 Movies and Photos to the Web

With the supplied software **ImageBrowser EX**, you can upload your MP4 movies to YouTube and photos to Facebook from your computer. Additionally, you can use **CANON iMAGE GATEWAY*** to create video podcasts, make photo albums and more.

* This service may not be available in all countries/regions.

Installation

Install the software before you connect the camcorder to the computer for the first time. The software is compatible with computers running Windows or Mac OS operating systems. Refer to *Saving MP4 Movies and Photos (Windows/Mac OS)* (📖 131).

Connecting to the Computer and Uploading your Recordings

Refer to the relevant sections in the 'ImageBrowser EX' User Guide (PDF file).



HFR38 / HFR37 / HFR36

Wi-Fi Functions

This chapter contains information about how to operate the Wi-Fi functions of your camcorder, starting with the Wi-Fi network setup needed to add your camcorder to an existing Wi-Fi network.

Introduction to Wi-Fi

The camcorder's Wi-Fi functions allow you to send files wirelessly, which means that you will not need to fuss with cables. You can wirelessly connect the camcorder to a Wi-Fi network (wireless LAN) using an access point (commonly referred to as infrastructure mode) or directly to an iOS device* without using a wireless access point (commonly referred to as ad hoc mode). The steps you will perform will depend on how you plan to use your recordings. Refer to *Glossary* (📖 165) for a definition of the frequently used terms in this text.

* "iOS device" is used in this text to collectively refer to Wi-Fi-enabled iOS devices.

Wi-Fi connection A

Infrastructure mode

Connect the camcorder to an access point on a Wi-Fi network (📖 149). Use this connection if you plan to save your recordings on a computer or FTP server (📖 154) and then upload videos to YouTube and Facebook (📖 158).

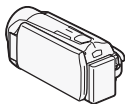

Access point

Computer

Connect the camcorder to an iOS device (📖 159). Use this connection type if you plan to upload videos to YouTube and Facebook on the go (📖 158).



iOS device

Connect the camcorder to an access point on a Wi-Fi network (📖 149). Use this connection if you plan to play back videos on a DLNA-compatible TV (📖 162) connected to the network using a LAN cable.

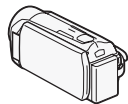

LAN cable

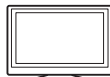

Access point

HDTV

About the camcorder's Wi-Fi standard

The camcorder's Wi-Fi standard complies with the IEEE 802.11b/g/n protocol and operates in the 2.4 GHz band. As such, the maximum data transfer rate is 11 Mbps for IEEE 802.11b, 54 Mbps for IEEE 802.11g, and 150 Mbps for IEEE 802.11n. Note that these are theoretical values and actual data transfer rates may differ.

i NOTES

- While using Wi-Fi functions, the camcorder's automatic power off function will be disabled.

Connecting to a Wi-Fi Network

Wirelessly connecting to a Wi-Fi network via an access point (wireless router) is commonly referred to as infrastructure mode. If your wireless router supports Wi-Fi Protected Setup (WPS), setup will be easy and require minimal configuring. Refer to *Wi-Fi Protected Setup* below. If your wireless router does not support WPS or you wish to manually configure settings, refer to *Manual Setup* (📖 151).

Refer also to the instruction manual of your wireless router and other devices you will use.

General requirements

- Correctly configured Wi-Fi network or hotspot that uses the 802.11b/g/n protocol.



✔ POINTS TO CHECK

- Using an unprotected Wi-Fi network can expose your files and data to monitoring by unauthorized third parties. Be aware of the risks involved.

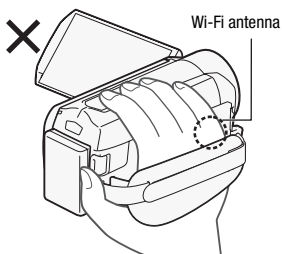

- When using the camcorder's Wi-Fi functions, do not cover the right side of the camcorder with your hand or other object. The Wi-Fi antenna is located on the right side and covering it may interfere with wireless signals.

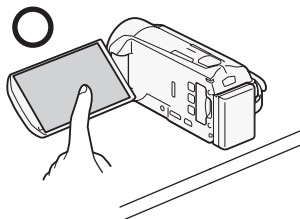

Place the camcorder on a table or similar surface and then use the Wi-Fi functions, as shown in the illustration on the left.

Operating modes:



Wi-Fi Protected Setup (WPS)

To use WPS to make a connection using infrastructure mode, make sure your wireless router has the WPS logo. If your wireless router has a WPS button, setup will be easy and all automatic.



Some wireless routers that support WPS do not have a dedicated button but use a PIN code instead. Both cases are explained in the following procedure. For setup using a PIN code, you will need to know in advance how to activate the wireless router's WPS function.

To enter text for the various settings, use the virtual keyboard (📖 88).

- 1 Set the camcorder to playback mode and then press **HOME** .
- 2 Set up a new connection point.



[Wi-Fi] ➤ [Wi-Fi Setup] ➤ [Network Setup] ➤
Desired connection point ([1] to [3]) ➤ [Set Up
New]* ➤ [WPS: Button] or [WPS: PIN Code]

* To replace the settings of an existing connection point, touch [Edit] instead and then manually change the settings. To delete the settings, touch [Delete] and then [Yes].

- You can set up up to three connection points for infrastructure mode ([1] to [3]). Once set up, you can use the same Wi-Fi network without any further settings.

- 3 **WPS button setup:** Press and hold the WPS button on your wireless router.

WPS PIN code setup: After a PIN code appears on the camcorder's screen, enter it into your wireless router's setup screen.

In most cases, the wireless router's setup screen is accessed using your Web browser. For details about how to activate the Wi-Fi protected setup, refer to the instruction manual of your wireless router.

4 Within 2 minutes, touch [OK] on the camcorder's screen.

You can touch [Stop] and then [OK] to interrupt the Wi-Fi Protected Setup while it is in progress.

5 Touch [Automatic] to automatically obtain an IP address.

- To assign the IP address manually, touch [Manual] and perform the procedure in *To manually assign an IP address* below.
- A screen to test the settings will appear.

6 Select whether to test the settings.

- You can touch [Check Current Configuration] to review the network settings.
- If you touched [Yes], a test of the settings will be performed and a confirmation screen will appear. Touch [OK].

7 Save the settings of the connection point.

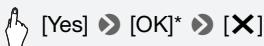

- * After touching [OK], you can review the network settings. Touch [Wi-Fi Setup] ➤ [Check Current Configuration] ➤ Desired connection point ((📶) 1) to ((📶) 3) ➤ [▼] or [▲] ➤ [↶] three times when finished.

To manually assign an IP address (step 5)

After touching [Manual] in step 5:

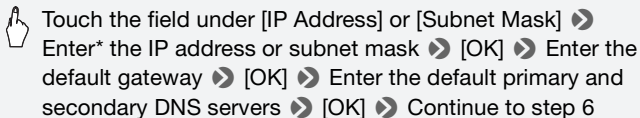

- * An interface similar to the virtual keyboard for text fields (📄 88) will appear except it will contain only the keys necessary for this step.

Manual Setup

Perform this procedure to wirelessly connect the camcorder to the wireless router (using infrastructure mode) if your router does not support WPS, you wish to manually configure settings, or if your wireless router's network name (SSID) cannot be detected due to the stealth function being enabled.

To enter text for the various settings, use the virtual keyboard (📖 88).

✔ POINTS TO CHECK

- You may need to know in advance the encryption key and other settings of the wireless router. Refer to the wireless router's setup screen or ask the network administrator.

1 Set the camcorder to playback mode and then press [HOME].

2 Set up a new connection point.



[Wi-Fi] ➤ [Wi-Fi Setup] ➤ [Network Setup] ➤
Desired connection point ([1] to [3]) ➤ [Set Up
New]* ➤ [Manual Setup]

* To replace the settings of an existing connection point, touch [Edit] instead and then manually change the settings. To delete the settings, touch [Delete] and then [Yes].

- You can set up up to three connection points for infrastructure mode ([1] to [3]). Once set up, you can use the same Wi-Fi network without any further settings.
- The camcorder will automatically detect available nearby Wi-Fi networks and display their SSID.

3 Touch [▲] or [▼] to select the desired access point and then touch [OK].

- Wi-Fi networks with a stealth function that do not broadcast their network name will not be detected by the camcorder. To use such an access point, touch [Enter Manually] and perform the procedure described in *To manually enter a wireless access point* (📖 153).
- If the desired access point is protected, the 🔒 icon will appear next to the network name. In such case, continue to step 4; otherwise, skip to step 5.

4 Touch the [Encryption Key] control button to enter the encryption key or password of the wireless access point and then touch [OK].

- If the encryption method of the wireless access point is set to WEP, the WEP index key will appear on the screen. Select the same index key of the access point.

5 Touch [Automatic] to automatically obtain an IP address.

- To assign the IP address manually, touch [Manual] and perform the procedure in *To manually assign an IP address* (📖 151).
- A screen to test the settings will appear.

6 Select whether to test the settings.

- You can touch [Check Current Configuration] to review the network settings.
- If you touched [Yes], a test of the settings will be performed and a confirmation screen will appear. Touch [OK].

7 Save the settings of the connection point.

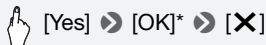

- * After touching [OK], you can review the network settings. Touch [Wi-Fi Setup] ➤ [Check Current Configuration] ➤ Desired connection point ([📶] 1) to ([📶] 3) ➤ [▼] or [▲] ➤ [↶] three times when finished.

To manually enter a wireless access point (step 3)

Enter the details of the wireless access point.

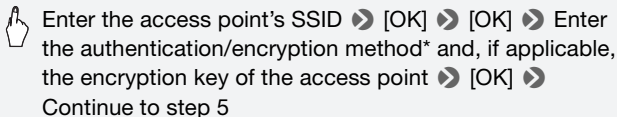

- * If you select [Open], you can select [No Encryption] or [WEP]. If you select, [Open] ➤ [WEP] or [Shared Key WEP], you will need to specify the WEP index key.

NOTES

- The functions available and the setup method will vary depending on the specifications and characteristics of the Wi-Fi network you want to use.
- When using Wi-Fi functions, wireless communication with an Eye-Fi card is not possible.

Transferring Files to a Computer or FTP Server

You can wirelessly transfer recordings directly to a computer running the supplied software **Network Utility** (Windows only) or an FTP server. First, set where the files will be transferred to (file transfer destination) and then transfer the files. If you are transferring files to a computer running **Network Utility**, you also have the option of uploading the files to YouTube and Facebook (📖 158).



✔ POINTS TO CHECK

- If you have not done so already, complete the Wi-Fi network setup (📖 149) in advance.

General requirements

For computers running Windows OS:

- A computer correctly connected to the same network as the camcorder with the supplied software **Network Utility** correctly installed, configured and running (📶 appears in the notification area, depending on the OS). **Network Utility** will be installed automatically after you install **VideoBrowser**. For details about the software, refer to the 'Network Utility Software Guide' (PDF file on the PIXELA disc in the folder \Network Utility\Manual\English).

For FTP servers:

- Correctly configured FTP server, such as a Macintosh computer or network-attached storage (NAS) drive. You will need to enter the IP address, port, user name, password and file transfer destination as part of the manual setup.

Operating modes:



File Transfer Destination Setup for Windows Computers

- 1 Power the camcorder using the compact power adapter.
- 2 Set the camcorder to playback mode and then press **[HOME]**.
- 3 Connect the camcorder to the Wi-Fi network.

 [(i) Wi-Fi] ➤ [Wi-Fi Setup] ➤ [Transfer Destination Setup] ➤ [Computer (Network Utility)] ➤ [**▼**]* ➤ Desired connection point** ➤ [OK]**

* This step is not necessary when the file transfer destination is not configured.

** This step is not necessary when only one connection point is detected.

- Select the connection point corresponding to the Wi-Fi network to which the computer running Network Utility is also connected.
 - If several computers connected to the network are running Network Utility, a selection screen will appear. In such case, continue to step 4; otherwise, skip to step 5.
- 4 Touch [**▲**] or [**▼**] to select the specific computer you want to use for transferring files wirelessly from the camcorder and then touch [OK].
 - 5 When the confirmation screen appears, save the settings of the connection point.

 [Yes] ➤ [OK] ➤ [**✕**]

File Transfer Destination Setup for FTP Servers

- 1 Set the camcorder to playback mode and then press **[HOME]**.
- 2 Connect the camcorder to the Wi-Fi network.

 [(i) Wi-Fi] ➤ [Wi-Fi Setup] ➤ [Transfer Destination Setup] ➤ [FTP Server]

3 Enter the details of the FTP server.



[✓] ➤ Enter* the IP address for [FTP Server] and [21] for [Port]
➤ [OK] ➤ Enter the user name and password ➤ [OK] ➤
Enter [/] for [Destination Folder] ➤ [OK]

* An interface similar to the virtual keyboard for text fields (📖 88) will appear except it will contain only the keys necessary for this step.

- The destination folder may differ depending on the FTP server. Check the FTP server's settings.
- A confirmation screen will appear.

4 Save the settings of the connection point.



[Yes] ➤ [OK] ➤ [✗]

- Before touching [Yes], you can touch [Check Current Configuration] to review the network settings.

Transferring Recordings

1 Power the camcorder using the compact power adapter.

Do not disconnect the power source or turn off the camcorder until the transfer is completed.

2 Set the camcorder to playback mode and then press **HOME** .

3 Touch **[Wi-Fi]** and then touch **[Transfer Files]**.

If the memory card slot cover is open, the option will not be available. Make sure the cover is closed properly.

4 Select the memory that contains the recordings you wish to transfer wirelessly and touch **[OK]**.

- You can select more than one memory.
- Touch [All files] to transfer all the recordings, or [New files] to transfer only those recordings that have not been previously transferred.
- Once connected, the wireless transfer will begin automatically.
- You can touch [Stop] and then [✗] to cancel the wireless transfer while it is in progress.

5 Touch **[OK]**.

IMPORTANT

- Do not open the memory card slot cover during wireless transfer.
- Observe the following precautions when transferring files. Failing to do so may interrupt the transfer and incomplete files may remain at the transfer destination.
 - Do not disconnect the power source or turn off the camcorder.
 - Do not change the camera mode.
- If the file transfer is interrupted, select [New Files] and perform the file transfer again.
- If incomplete files remain at the transfer destination, check the content and make sure they are safe to delete before deleting them.

NOTES

- AVCHD movies transferred using **Network Utility** will be saved in the Videos folder on the computer by default. If you start **VideoBrowser** after you transfer AVCHD movies, the destination folder will automatically be added to the software's Library.
- MP4 movies transferred using **Network Utility** will be saved in the same location as AVCHD movies. If you start **ImageBrowser EX** after you transfer MP4 movies, the same destination folder will automatically be added to **ImageBrowser EX**. If you change the destination folder in **Network Utility** before transferring files, make the same change in the **ImageBrowser EX** settings.
- Depending on the wireless router's settings and capability, it can take some time to upload video files.

Uploading Recordings to YouTube and Facebook

You can upload movies to YouTube and movies and photos to Facebook using the supplied software **Network Utility** running on a Windows computer.

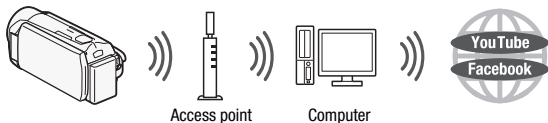

POINTS TO CHECK

- If you have not done so already, complete the Wi-Fi network setup (📖 149) and file transfer destination setup (📖 154) in advance.

General requirements



- A computer correctly connected to a network with the supplied software **Network Utility** correctly installed, configured (including your YouTube and Facebook account settings) and running (📶 is in the notification area). **Network Utility** will be installed automatically after you install **VideoBrowser**. For details about the software, refer to the 'Network Utility Software Guide' (PDF file on the PIXELA disc in the folder \Network Utility\Manual\English).

Operating modes:



* Photos can be uploaded to Facebook only.

- 1 Set the camcorder to playback mode and then open the index screen that contains the recordings you want to upload.
- 2 Select the service you wish to upload to.

 [Edit] ➤  Network Utility ➤ Desired service ➤ Touch the desired recording

- 3 If you are uploading to YouTube, read the YouTube agreement carefully and touch [I Agree] if you agree.
- 4 Touch the desired connection point to connect the camcorder to the network and then touch [OK].

Once connected, or if only one connection point has been set up, the wireless upload will begin automatically. You can touch [Stop] and then [X] to cancel the wireless upload while it is in progress.

- 5 Touch [OK].

NOTES

- Depending on the wireless router's settings and capability, it can take some time to upload video files.

Uploading Videos Using an iOS Device

You can connect the camcorder to an iOS device* to upload your recordings to YouTube and Facebook even when you are away from your home network. Make sure you have downloaded and are using the Movie Uploader app provided by PIXELA, available for free from the App Store (<http://itunes.com/apps/movieuploader>). The Wi-Fi connection between the camcorder and iOS device is commonly referred to as ad hoc mode, meaning that the camcorder will connect directly to the iOS device without using an access point.

* "iOS device" is used in this text to collectively refer to Wi-Fi-enabled iOS devices.



Operating modes:



Setting Up a Wi-Fi Connection (Ad hoc Mode)

- 1 Set the camcorder to playback mode and then press **[HOME]** .
- 2 Set up a new connection point.

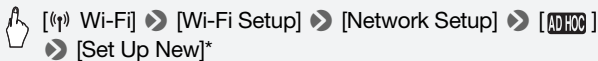

* To replace the current settings, touch [Edit] instead and then manually change the settings. To delete the settings, touch [Delete] and then [Yes].

- 3 Enter the details of the connection.

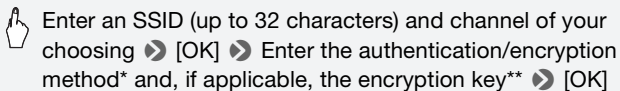

* If you select [Open], you can select [No Encryption] or [WEP]. If you select [Shared Key WEP], you will need to specify the WEP index key.

**Enter an encryption key of your choosing. The encryption key must be one of the following.

- 5 or 10 alphanumeric characters
- 10 or 26 hexadecimal characters (0-9, A-F)

- 4 Touch **[Automatic]** to automatically obtain an IP address.

- 5 Touch **[No]**.

- You can touch [Check Current Configuration] to review the network settings.

- 6 Save the settings of the connection point.

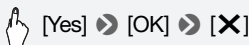

NOTES

- If you attempt to test the settings and the camcorder is able to send a Wi-Fi signal, then a message will be displayed indicating that the connection was successfully established even when the camcorder has not established a connection to the iOS device.

Uploading Videos

- 1 **Camcorder: Set the camcorder to playback mode and then press **HOME**.**
- 2 **Camcorder: Select the ad hoc Wi-Fi connection.**



* If the memory card slot cover is open, the option will not be available. Make sure the cover is closed properly.

- 3 **Camcorder: Touch **[OK]**.**
The camcorder will connect as a media server.
- 4 **iOS device: Touch **Settings** ➤ **Wi-Fi** and then turn **Wi-Fi** on.**
A list of active networks will appear.
- 5 **iOS device: On the network selection screen, select the network set in the camcorder. If necessary, enter the password and then touch **[Join]**.**
A checkmark will appear next to the selected network.
- 6 **iOS device: Use the **Movie Uploader** app to upload the camcorder's movies.**
For details about the Movie Uploader app, visit <http://www.pixela.co.jp/oem/canon/e/movieuploader/> (English only)
- 7 **Camcorder: When you have finished, touch **[End]** to end the **Wi-Fi** connection.**

IMPORTANT

- Do not open the memory card slot cover during the wireless connection.

NOTES

- Depending on the wireless router's settings and capability, it can take some time to upload video files.
- The procedure above may differ depending on the version of iOS you are using.

Wireless Playback on a DLNA-Compatible Device

If you have a DLNA-compatible player, such as an HDTV, on your home network, you can watch your recordings* wirelessly. In such case, the camcorder acts as a digital media server (DMS) and the HDTV acts as a digital media player (DMP). From the HDTV, you can easily search for recordings in the camcorder and play them back.

* Many DLNA players do not support playback of MP4 movies.

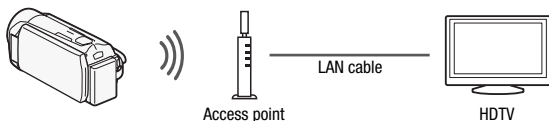

POINTS TO CHECK

- If you have not done so already, complete the Wi-Fi network setup ( 149) in advance.

General requirements

- An HDTV or other media player certified as a DLNA Digital Media Player (DMP), correctly configured and connected to the network. We recommend using a LAN cable to connect the HDTV or media player. Look for the DLNA Certified logo on the HDTV and refer to the instruction manual of the HDTV for details on connecting it to the network.



Operating modes:



1 Set the camcorder to playback mode and then press  .

- 2 Camcorder: Touch [(Wi-Fi)] and then touch [DLNA Media Server].**
 - If the memory card slot cover is open, the option will not be available. Make sure the cover is closed properly.
 - If only one connection point has been set up, the wireless connection will be established. Skip to step 4.
- 3 Camcorder: Touch the desired connection point and then touch [OK].**
- 4 DLNA Digital Media Player: Select your camcorder model from the list and then play back your recordings.**
 - The ACCESS indicator blinks during the connection.
 - Refer to the DLNA device's instruction manual for details on the procedure.
- 5 Play back the videos in the folder that appears (built-in memory or memory card).**
- 6 Camcorder: When you have finished playing back, touch [End] to end the Wi-Fi connection.**

If playback is not smooth

If the video's playback is not smooth, you can play back the video in standard definition.

- 1 Press **[HOME]**.
- 2 Enable conversion to standard definition.

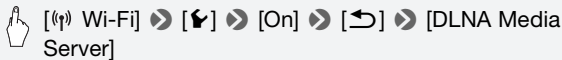

- Touch [Off] when you want to play back your movies in AVCHD.

! IMPORTANT

- Do not open the memory card slot cover during the wireless connection.

NOTES

- Playback may not appear smooth depending on the wireless router's settings and capability. In such case, try the following.
 - Remove any objects between the camcorder and wireless access point that may interfere with the wireless signal.
 - Move the camcorder closer to the wireless access point.
 - Turn off the wireless functions of other wireless devices other than the DLNA-compatible device being used for playback.
 - Switch the wireless access point to IEEE802.11n and activate channel bonding. Refer to its instruction manual for details.

If these do not improve playback, the cause may be due to conditions unique to the surrounding area. Use the supplied HDMI cable to connect the camcorder to the device.

Glossary

This is a glossary of some of the basic terms used frequently in this chapter. The documentation for your wireless router may also contain a glossary you can refer to.

Access Point

A wireless access point (WAP) is a device that allows wireless devices, like your camcorder, to connect to a wired network (including to the Internet) using the Wi-Fi standard. In most cases, this will be your wireless router.

Ad hoc mode

A Wi-Fi connection made directly from one device to another without using an access point.

DLNA

Digital Living Network Alliance. A standard for easy communication and content sharing among consumer electronic devices, computers and mobile devices across a home network.

FTP server

An FTP server is an application running on a computer that allows users to transfer files to and from that computer.

Infrastructure mode

A Wi-Fi connection in which devices are connected through an access point.

IP Address

Exclusive number assigned to each device connected to the network.

SSID

Service Set Identifier. This is simply the public name of a Wi-Fi network.

WPS

Wi-Fi Protected Setup. Standard for easy and secure setup of Wi-Fi networks created by the Wi-Fi Alliance.



Additional Information



This chapter contains troubleshooting advice, screen messages, handling and maintenance tips, and other information.













Appendix: Menu Options Lists

Menu items not available appear grayed out. For details about how to select an item, refer to *Using the Menus* (📖 26). For details about each function, see the reference page. Menu options without a reference page are explained after the tables. Underlined menu options indicate default values. Unless otherwise specified, functions available for AVCHD movies include movies made using Story Creator mode.

Main Functions] Panel

Main Functions] Panel - Recording Modes











Control Button	Setting options/Function	AUTO	M		
[Rec. Programs]	<u>[P Programmed AE]</u>	–	●	–	94
	[👤 SCN: Portrait], [🏃 SCN: Sports], [🌃 SCN: Night Scene], [❄️ SCN: Snow], [🏖️ SCN: Beach], [🌅 SCN: Sunset], [💡 SCN: Low Light], [🎪 SCN: Spotlight], [🎆 SCN: Fireworks]	–	●	–	94
[WB White Balance]	[<u>AWB Automatic</u>], [☀️ Daylight], [🔥 Tungsten], [👤 Custom WB]	–	●	●	106
[👁️ Focus]	[<u>MF</u>] (manual focus): Toggle on or <u>off</u> , Touch AF frame	–	●	●	104
[📷 Exposure]	[<u>M</u>] (manual exposure): Toggle on or <u>off</u> , Touch AE frame	–	●	●	102
[👁️ Powered IS] ¹	[ON], [OFF]	●	●	●	97
[ZOOM]	Zoom controls, [START]/[STOP] control	●	●	●	49
	[👤] (tele macro): Toggle on or <u>off</u>	–	●	●	105

Control Button	Setting options/Function	AUTO	M		
[Zoom Type]	[32x Optical], [51x Advanced], [1020x Digital], HFR37 [2550x Digital]	–	●	●	50
[ Mic. Level]	[A] (automatic), [M] (manual) [Audio Level Indicator]: Toggle on or <u>off</u>	–	●	●	109
[ Faders]	[OFF] Off], [F1] Fade Trigger: Once], [F1] Fade Trigger: Always], [F2] Wipe: Once], [F2] Wipe: Always]	–	●	●	101
[ Decoration]	[ Pens and Stamps], [ Animated Stamps], [ Captions] ²	●	●	●	73
	[] (image mix): Toggle <u>on</u> or off, [] (pause live video)	●	●	–	
	[] (minimize toolbar)	●	●	●	
[ Pre REC]	[ON], [OFF]	–	●	●	98
[ Review Recording]	–	–	●	●	90



¹ The default setting is on in **AUTO** mode and off in other camera modes.

² Some options are available only when recording a story using Story Creator.

[Edit] Panel - Mode

Control Button	 [AVCHD Movies] Index Screen	 [MP4 Movies] Index Screen	 [SD Movies] Index Screen	Playback Pause	
HFR38 / HFR37 / HFR36 From the built-in memory: [Copy ( )]	<date>, [Select], [All Scenes]	[Select], [All Scenes]	–	–	126
HFR38 / HFR37 / HFR36 From the built-in memory: [Convert HD  SD ( )]	<date>, [Select], [All Scenes]	–	–	–	140
[Delete]	<date>, [Select], [All Scenes]	[Select], [All Scenes]	[This Scene], [All Scenes]	[This Scene]	60
[Divide]	–	–	–	●	114
HFR38 / HFR37 / HFR36 [ Network Utility]	YouTube, Facebook	YouTube, Facebook	YouTube, Facebook	–	158

In the gallery:

Control Button	[Edit Story] from the [Story Details] screen	[Edit Scene] from the [Scene List] screen	Playback Pause	
HFR38 / HFR37 / HFR36 From the built-in memory: [Copy ( )]	<by scene rating>	–	–	127

Control Button	[Edit Story] from the [Story Details] screen	[Edit Scene] from the [Scene List] screen	Playback Pause	
HFR38 / HFR37 / HFR36 From the built-in memory: [Convert HD → SD (📷 → 📁)]	<by scene rating>	–	–	142
[Delete] or [🗑️]	<by scene rating>	[This Scene]	[This Scene]	60
[Delete Story]*	●	–	–	63
[Story Thumbnail]*	●	–	–	86
[Edit Title]*	●	–	–	87
[Copy]	–	●	–	85
[Move]	–	●	–	85
[Divide]	–	–	●	114
[Rating]	–	[★★★★], [★★★●], [★★●●], [●●●●] (unrated), [----] (others)		80

* Operation not available for the two preexisting stories, [Unsorted] and [Video Snapshot].













[Edit] Panel - Mode

Control Button	Index Screen	Single Photo View	
HFR38 / HFR37 / HFR36 From the built-in memory: [Copy (📷 → 📁)]	[Select], [All Photos]	●	127, 128
[Delete]		●	118
HFR38 / HFR37 / HFR36 [🌐 Network Utility]	Facebook	–	146

Other Settings] Menus

When the camcorder is in **AUTO** mode, you will not be able to access the  menu.

Camera Setup

Menu item	Setting options	AVCHD	MP4	
[Self Timer]	[ON On  , [OFF Off]	●	●	108
[Zoom Speed]	[VAR Variable], [ Speed 3], [ Speed 2], [ Speed 1]	●	●	49
[Focus Assistance]*	[ON On], [OFF Off]	●	●	–
[Face Detection & Tracking]	[ON On  , [OFF Off]	●	●	99
[Auto Backlight Correction]	[ON On], [OFF Off]	●	●	103
[Auto Slow Shutter]	[ON On], [OFF Off]	●	●	–
[Flicker Reduction]*	[OFF Off], [50Hz 50 Hz], [60Hz 60 Hz]	●	●	–
[Fader Setting]*	[BLACK Black Screen], [WHITE White Screen]	●	●	101
[Onscreen Markers]	[OFF Off], [ Level (White)], [ Level (Gray)], [ Grid (White)], [ Grid (Gray)]	●	●	–
[Image Stabilizer]	[ Dynamic], [ Standard], [OFF Off]	●	●	97
[Wind Screen]*	[A Automatic], [OFF Off 	●	●	–
[Microphone Attenuator]*	[A Automatic], [ON On ATT]	●	●	–

* Option available only for recording movies.

[Focus Assistance]: When focus assistance is activated, the image at the center of the screen is magnified to help you focus manually (📖 104).

- Using focus assistance will not affect the recordings. It will be cancelled automatically after 4 seconds or when you start recording.

[Auto Slow Shutter]: The camcorder automatically uses slow shutter speeds to obtain brighter recordings in places with insufficient lighting.

- Minimum shutter speed used: 1/25; 1/12 when the frame rate is set to [PF25 PF25] or [25P 25P].
- The auto slow shutter can only be activated when the recording program is set to [P Programmed AE], but the setting will not change even if you set the camcorder to [AUTO AUTO] mode.
- If a trailing afterimage appears, set the slow shutter to [OFF Off].

[Flicker Reduction]: If the screen starts to flicker when recording movies under fluorescent lights, change the setting to reduce the effect.

Flicker reduction can be activated only when the recording program is set to [P Programmed AE].

[Onscreen Markers]: You can display a grid or a horizontal line at the center of the screen. Use the markers as a reference to make sure your subject is framed correctly (vertically and/or horizontally).

- Using the onscreen markers will not affect the recordings.





[Wind Screen]: The camcorder automatically reduces the background sound of wind when recording outdoors.

- Some low-frequency sounds will be suppressed along with the sound of wind. When recording in surroundings unaffected by wind or if you want to record low-frequency sounds, we recommend setting the wind screen to [OFF Off ].

[Microphone Attenuator]: Helps prevent audio distortions.

[A Automatic]: The camcorder will automatically activate the microphone attenuator as necessary for optimal audio recording levels so high audio levels will not be distorted.

[ON On ATT]: The microphone attenuator will be activated at all times to reproduce more faithfully the sound dynamics. [ATT ATT] will appear on the screen.

Menu item	Setting options			
[Select Music]*	[OFF Off], [ON On] When [ON On] - list of music tracks, [Music Balance]  [♪] (Original sound/Background music)	●	●	82
[Data Code]	[OFF Off], [Date Date], [Time Time]*, [Date and Time]*, [Camera Data]*	●	●	—
[Slideshow Transition]	[OFF Off], [Dissolve], [Slide Image]	—	●	120
[TV Type]	[4:3 4:3 TV], [16:9 Wide TV]	●	●	—

* Option available only for AVCHD movies.

[Data Code]: Displays the date and/or time when the scene or photo was recorded.

[Camera Data]: Displays the aperture (f-stop) and shutter speed used when recording the scene or photo.















[TV Type]: When you connect the camcorder to a TV using the optional STV-250N Stereo Video Cable, select the setting according to the type of TV in order to display the picture in full and in the correct aspect ratio.



[4:3 4:3 TV]: TV sets with 4:3 aspect ratio.

[16:9 Wide TV]: TV sets with 16:9 aspect ratio.

- When the TV type is set to [4:3 4:3 TV], during the playback of video originally recorded with an aspect ratio of 16:9, the picture will not be displayed fullscreen.
- This option is not available when the camcorder is connected to an HDTV using the supplied HDMI cable.

Recording & Connections Setup

Menu item	Setting options	AVCHD	MP4			
HFR38 / HFR37 / HFR36 [Rec Media for Movies]	 (built-in memory),  (memory card), [Relay Recording]: [OFF Off], 	●	●	–	–	39
[Recording Mode]	[MXP High Quality 24 Mbps], [FXP High Quality 17 Mbps], [XP+ High Quality 12 Mbps], [SP Standard Play 7 Mbps], [LP Long Play 5 Mbps] [9Mbps 9 Mbps], [4Mbps 4 Mbps]	●	–	–	–	91
[Frame Rate] ¹	[50i 50i (Standard)], [PF25 PF25]	●	–	–	–	94
HFR38 / HFR37 / HFR36 [Rec Media for Photos]	 (built-in memory),  (memory card)	●	●	● ²	–	39
[Video Snapshot Length] ¹	[2sec 2 sec], [4sec 4 sec], [8sec 8 sec] [Story Length-Based]: Toggle <u>on</u> or off	●	–	● ²	–	72, 112
[Rate Scenes (Recording)] ¹	[ON On], [OFF Off]	●	–	–	–	–
[Available Space in Memory]	 * (built-in memory),  * (memory card) * HFR38 / HFR37 / HFR36 only.	●	●	–	–	–
[Used Space in Memory]	 * (built-in memory),  * (memory card) * HFR38 / HFR37 / HFR36 only.	–	–	●	●	–
[x.v.Color] ¹	[ON On color], [OFF Off]	●	–	–	–	–
[File Numbering]	[ Reset], [ Continuous]	●	●	●	●	–

Menu item	Setting options	AVCHD	MP4			
HFR38 / HFR37 / HFR36 [External Hard Drive Info] ³	—	—	—	●	●	—

¹ Option not available in **AUTO** mode.

² Option available only for AVCHD movies.

³ This is the only option available when an external hard drive is connected to the camcorder.

[Rate Scenes (Recording)]: When set to [**ON** On], the scene rating scene will appear after every scene you record.

[Available Space in Memory]/[Used Space in Memory]: Displays a screen where you can verify how much of the built-in memory (HFR38/HFR37/HFR36 only) or the memory card is currently available for recording or how much is in use ( indicates photos).

- Estimated figures about available movie recording time and available number of photos are approximate and based on the recording mode currently in use and a photo size of 1920x1080.
- In the information screen of a memory card you can also check its Speed Class.
- HFR38/HFR37/HFR36 The [Total space] shown for the built-in memory indicates actually usable space. It may be slightly smaller than the nominal built-in memory capacity listed in the specifications.

[x.v.Color]: Uses a color space with an extended gamut to achieve deeper colors, closer to real life.

- Use this function to record video only when you intend to play back your recordings on an HDTV compatible with x.v.Color, connected to the camcorder using the supplied HDMI cable. If recordings made with x.v.Color are played back on a non-compatible TV, colors may not be reproduced correctly.

[File Numbering]: Select the file numbering method to be used on a new memory card. Photos and MP4 movies are automatically assigned consecutive numbers from 0101 to 9900, and stored in folders containing up to 100 files. Folders are numbered from 101 to 998.



















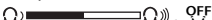

[ Reset]: File numbers will restart from 101-0101 every time you insert a new memory card.











[ Continuous]: File numbers will continue from the number following that of the last file recorded with the camcorder.



- If the memory card you insert already contains a file with a larger number, a new file will be assigned a number one higher than that of the last file on the memory card.
- We recommend using the [ Continuous] setting.
- The file number indicates the name and location of the file on the memory card. For example, the file name of a photo numbered 101-0107 is “IMG_0107.JPG”, stored under the folder “DCIM\101\CANON” while an MP4 movie with the same file number will have the file name “MVI_0107.MP4”.

[External Hard Drive Info]: When the camcorder is connected to an external hard drive, this setting displays information about the hard drive.

System Setup

Menu item	Setting options	AVCHD	MP4			
[Output Onscreen Displays] ¹	[ON On], [OFF Off]	●	●	●	●	–
[Language 	[Česky], [Dansk], [Deutsch], [Ελληνικά], [English], [Español], [Français], [Italiano], [Magyar], [Melayu], [Nederlands], [Norsk], [Polski], [Português], [Română], [Suomi], [Svenska], [Türkçe], [Русский], [Українська], [العربية], [فارسی], [ភាសាខ្មែរ], [简体中文], [繁體中文], [한국어], [日本語]	●	●	●	●	34
[LCD Brightness]		●	●	●	●	–
[LCD Backlight]	[H Bright], [M Normal], [L Dim]	●	●	●	●	–
[LCD Mirror Image]	[ON On], [OFF Off]	●	●	–	–	–
[AV/Headphones]	[AV AV], [ Headphones]	●	●	●	●	110
[Volume]	Speaker:  , OFF 	–	–	●	●	55
	Headphones:  , OFF 	●	●	●	●	110
[Notification Sounds]	[ High Volume], [ Low Volume], [OFF Off]	●	●	●	●	–
[Custom Control Button] ¹	[Rec. Programs], [WB White Balance], [ Focus], [ Exposure], [ Powered IS], [Zoom], [Zoom Type], [ Mic. Level], [ Faders], [ Decoration], [ Pre REC], [ Review Recording]	●	●	–	–	–
[Autostart Decoration]	[ON On], [OFF Off]	●	●	–	–	–

Menu item	Setting options	AVCHD	MP4			
[Power Saving Mode]	[Auto Power Off]: [OFF Off], [ON On] [Quick Start (Standby)]: [Off], [<u>10 min</u>], [20 min], [30 min]	●	●	●	●	–
HFR38 / HFR37 / HFR36 [Initialize  /  HFR306 [Initialize ]	[ Built-in Mem.]*, [ Mem. Card]* * HFR38 / HFR37 / HFR36 only. [Complete Initialization]: Toggle on or <u>off</u>	●	●	●	●	41
HFR38 / HFR37 / HFR36 [Initialize HDD] ²	–	–	–	●	●	137
HFR38 / HFR37 / HFR36 [Delete Memory Save Folder] ²	–	–	–	●	●	136
[Time Zone/DST]	[] (home time zone) or [] (travel time zone): [<u>Paris</u>], list of world time zones [] (DST adjustment): Toggle on or <u>off</u>	●	●	●	●	35
[Date/Time]	[Date/Time]: – [Date Format]: [Y.M.D], [M.D,Y], [<u>D.M.Y</u>] (Y- year, M- month, D- day) [24H]: Toggle on (24-hour clock) or <u>off (12-hour clock)</u>	●	●	●	●	33
[Battery Info] ³	–	●	●	●	●	–
[Control for HDMI] ¹	[ON On], [OFF Off]	●	●	●	●	–
[HDMI Status] ¹	–	●	●	●	●	–
[Distance Units] ¹	[m meters], [ft feet]	●	●	–	–	–
[Demo Mode] ¹	[ON On], [OFF Off]	●	●	–	–	–
[Firmware]	–	–	–	–	●	–

Menu item	Setting options	AVCHD	MP4			
[Reset All]	[No], [Yes]	●	●	●	●	—
[Eye-Fi Communication] ⁴	[A Automatic], [OFF Off]	—	—	●	●	144

¹ Option not available in **AUTO** mode.

² Option available only after connecting an external hard drive to the camcorder.

³ Option available only when using the optional BP-718 or BP-727 Battery Pack.

⁴ Option available only after having inserted an Eye-Fi card into the memory card slot.

[Output Onscreen Displays]: When set to [**ON** On], the camcorder's onscreen displays will appear also on the screen of a TV or monitor connected to the camcorder.

[LCD Brightness]: Adjusts the brightness of the LCD screen.

- Changing the brightness of the LCD screen does not affect the brightness of your recordings or the brightness of the playback image on a TV.

[LCD Backlight]: Sets the screen to one of three brightness levels. You can use this to make the screen brighter when recording in bright places, for example.

- Changing the brightness of the LCD screen does not affect the brightness of your recordings or the brightness of the playback image on a TV.
- Using the bright setting will shorten the effective usage time of the battery pack.

[LCD Mirror Image]: When set to [**ON** On], you can rotate the LCD panel 180 degrees to let the subject check the image while you record. While the LCD panel is rotated toward the subject you will not be able to decorate the scene.

[Notification Sounds]: A beep will accompany some operations like turning on the camcorder, the self-timer countdown, etc.

- Set this to [**OFF** Off] to turn off notification sounds.
- While pre-recording ( 98) is activated, the camcorder will not emit any notification sounds.

[Custom Control Button]: On the lower right of the recording screen, a control button that is a shortcut to one of the functions in the [FUNC Main Functions] panel is constantly displayed. By changing this setting, you can change the shortcut, which will allow you to access one of your frequently used functions quickly and conveniently.

- In [AUTO] mode, the default setting is [🎨 Decoration]. In other modes, it is [🔌 Powered IS].

[Autostart Decoration]: When set to [ON On], the decoration screen will open automatically when you stow the LCD panel with the LCD screen facing out.

[Power Saving Mode]: Controls the camcorder's automatic power off settings.

[Auto Power Off]: In order to save power when the camcorder is powered by a battery pack, it will automatically shut off if left without any operation for 5 minutes.

- Approximately 30 seconds before the camcorder shuts off, [Auto Power Off] will appear. Operating any of the camcorder's controls while the message is displayed will prevent the camcorder from shutting off.
- In standby mode, the camcorder will shut off after the time selected for the [Quick Start (Standby)] setting.



[Quick Start (Standby)]: Select whether to activate the Quick Start function (📖 51) when you close the LCD panel in a recording mode and the length of time after which the camcorder will end the standby mode and shut off automatically.

- You can set Quick Start to [Off], for example, if the camcorder is set on a fixed position and you want to keep recording video with the LCD panel closed in order to conserve the battery's power.

[Battery Info]: When you are using an optional battery pack that is compatible with Intelligent System, this option displays a screen where you can verify the battery charge (as a percentage) and the remaining recording time (📄 M, 📄 mode) or playback time (📄 M, 📄 mode).

[Control for HDMI]: Activates the HDMI-CEC (Consumer Electronics Control) function. When you connect the camcorder to an HDTV compatible with HDMI-CEC using the supplied HDMI cable, you can control the camcorder's playback using the remote control of the TV.

- If set to [ON On], when the camcorder is connected to a compatible HDTV using the supplied HDMI cable, the video input on the TV will automatically be set to the camcorder's video input. Then, you can use the up/down/left/right buttons and the OK or SET button on the TV's remote control to play back your recordings.

- Depending on the TV set, additional settings may be required on the TV itself to activate the HDMI-CEC function. Refer to the TV's instruction manual.
- Correct operation of the HDMI-CEC function cannot be guaranteed even when connecting the camcorder to compatible TV sets. If you cannot use the remote control of the TV, set [Control for HDMI] to [OFF Off] and operate the camcorder directly.
- The remote control of the TV can only be used to play back movies or photos ( or  mode only). If the camcorder is connected to the TV while it is set to [AUTO], [M] or  mode, depending on the TV used, turning off the TV will automatically turn off the camcorder even if it is recording at the time.
- We recommend not connecting more than 3 HDMI-CEC compatible devices at a time.
- This option is not available when the camcorder is connected to an HDTV using the supplied HDMI cable.

[HDMI Status]: Displays a screen where you can verify the standard of the output signal from the HDMI OUT terminal.

[Distance Units]: Selects the units to use for the focusing distance display during manual focus.

[Demo Mode]: The demonstration mode displays the camcorder's main features. It starts automatically when the camcorder is powered with the compact power adapter if you leave it turned on without a memory card for more than 5 minutes.

- To cancel the demo mode once it has started, press any button or turn off the camcorder.

[Firmware]: You can verify the current version of the camcorder's firmware, which is the software that controls the camcorder. This menu option is usually unavailable.

[Reset All]: Resets all of the camcorder's settings.

Appendix: Onscreen Icons and Displays

AUTO Recording Movies (using Story Creator)

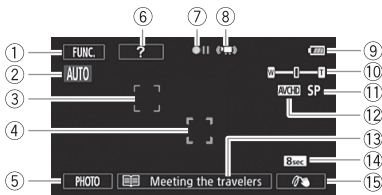

- ① Control button [FUNC.]: Open the [FUNC.] Main Functions panel (27)
- ② Smart AUTO (45)
- ③ Face detection frame (99)
- ④ Touch & Track frame (100)
- ⑤ Control button [PHOTO]: Take a photo (43, 89, 113)
- ⑥ Control button [?]: Displays a shooting tip for the current story scene
- ⑦ Memory operation (185)
- ⑧ Intelligent IS (47)
- ⑨ Remaining battery level; also remaining battery time when using an optional battery pack (185)
- ⑩ Zoom (49)
- ⑪ Recording mode (91)
- ⑫ Recording standard (30)
- ⑬ Current story scene (category) (68); touch to return to the list of story scenes (68)
- ⑭ Recommended scene length (68)
- ⑮ Decoration (73)

Recording Movies

M Manual mode

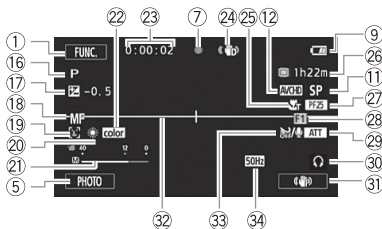

Cinema mode

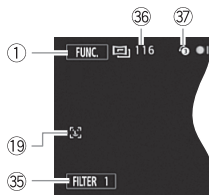

- 16 Recording program (94)
- 17 Manual exposure (102)
- 18 Manual focus (104)
- 19 Face detection (99)
- 20 White balance (106)
- 21 Audio level indicator (109)
- 22 x.v.Color (174)
- 23 While recording/during playback:
Scene counter (hours : minutes :
seconds) ; Self timer (108)
- 24 Image stabilizer (97)
- 25 Tele macro (105)
- 26 Remaining recording time
On the memory card
In the built-in memory*
Relay recording* (40)
* HFR38 / HFR37 / HFR36 only.
- 27 Frame rate (94)
- 28 Fader (101)
- 29 Microphone attenuator (171)
- 30 Headphone output (110)
- 31 Custom control button (179)
- 32 Level marker (171)
- 33 Wind screen off (171)
- 34 Flicker reduction (171)
- 35 Control button [FILTER 1]: Cinema-
look filters (70)
- 36 In record pause mode:
Total number of scenes
- 37 Pre-recording (98)

Playing Movies (during playback)

AVCHD movies:

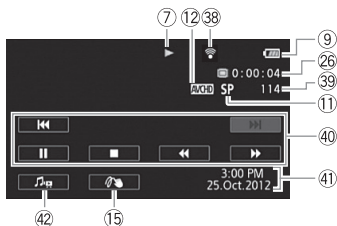

MP4 movies:

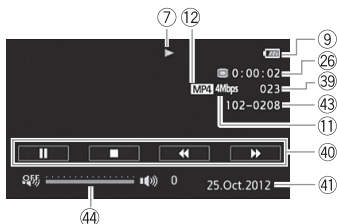



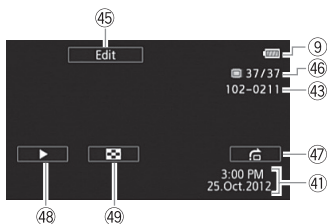

- 38 Eye-Fi wireless communication (144)
- 39 Scene number
- 40 Playback control buttons (55)

- 41 Data code (66, 172)
- 42 Volume and background music balance controls (55, 83)
- 43 File number (175)
- 44 Volume controls (56)

Viewing Photos



- ④⑤ Control button [Edit]: Open the Edit panel (📖 169)
- ④⑥ Current photo / Total number of photos
- ④⑦ Control button []: Photo jump (📖 117)
- ④⑧ Control button []: Slideshow (📖 120)
- ④⑨ Control button []: Return to the [ Photos] index screen (📖 116)

⑦ Memory operation

● Record, ●|| Record pause, ► Playback, || Playback pause, ►► Fast playback, ◀◀ Fast reverse playback, ► Slow playback, ◀ Slow reverse playback, ||► Frame advance, ◀|| Frame reverse.

⑨ Remaining battery level; also remaining battery time when using an optional battery pack

- The icon shows a rough estimate of the remaining charge as a percentage of the full charge of the battery pack.

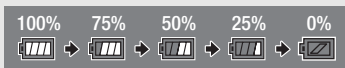

- When the battery charge becomes low, will appear in yellow. When the battery pack is exhausted, will appear in red. Replace or charge the battery pack. Depending on the condition of the camcorder or battery, the actual battery charge may not match what is displayed on the screen.
- When you attach an empty battery pack, the power may turn off without displaying .
- Depending on the conditions under which the camcorder and the battery pack are used, the actual battery charge may not be indicated accurately.
- You can display the charge status of a battery pack with the ► [Battery Info] setting. If the battery pack is exhausted, the battery information may not be displayed.

⑳ Remaining recording time

When there is no more free space on the memory, [End] (built-in memory, **HFR38** / **HFR37** / **HFR36** only) or [End] (memory card) will be displayed in red and the recording will stop.

Troubleshooting

If you have a problem with your camcorder, refer to this section. Sometimes what you think is a malfunction of the camcorder may have the simplest of solutions - please read the "CHECK THIS FIRST" box before going on to the more detailed problems and solutions. Consult your dealer or a Canon Service Center if the problem persists.

CHECK THIS FIRST

Power supply

- Is the battery charged? Is the compact power adapter correctly connected to the camcorder? (📖 19)

Recording

- Did you turn the camcorder on and correctly set it to a recording mode? (📖 43, 89) If you are recording on a memory card, is one correctly inserted into the camcorder? (📖 38)

Playback

- Did you turn the camcorder on and correctly set it to playback mode? (📖 53, 116) If you are playing back recordings from a memory card, is one correctly inserted into the camcorder? (📖 38) Does it contain any recordings?

Other

- Does the camcorder make a rattling sound? The internal lens fixture can move when the camcorder is turned off or in a playback mode. This is not a malfunction.

Power source

The camcorder will not turn on or it turns off by itself.

- The battery pack is exhausted. Replace or charge the battery pack.
- Remove the battery pack and reattach it correctly.

The camcorder turns off without the battery warning indicator appearing on the screen.

- The battery charge has become low or the battery pack is exhausted. Replace or charge the battery pack.

Cannot charge the battery pack.

- Make sure the camcorder is off so charging can start.
- The temperature of the battery pack is outside its operating range (approximately 0 – 40 °C). Remove the battery pack, warm it or let it cool down, as necessary, and try charging it again.
- Charge the battery pack in temperatures between approximately 0 °C and 40 °C.
- The battery pack is faulty. Replace the battery pack.
- The camcorder cannot communicate with the battery pack attached. Battery packs not recommended by Canon for use with this camcorder cannot be charged using this camcorder.
- If you are using a battery pack recommended by Canon for use with this camcorder, there may be a problem with the camcorder or battery pack. Consult a Canon Service Center.

A noise can be heard from the compact power adapter.

- A faint sound can be heard while the compact power adapter is connected to a power outlet. This is not a malfunction.

The battery pack is exhausted extremely quickly even at normal temperatures.

- The battery may have reached the end of its battery life. Buy a new battery pack.

Recording

Pressing **START/STOP** will not start recording.

- You cannot record while the camcorder is writing previous recordings onto the memory (while the ACCESS indicator is on or flashing). Wait until the camcorder has finished.
- The memory is full or it already contains the maximum number of scenes of AVCHD movies (3,999 scenes). Delete some recordings (📖 60, 118) or initialize the memory (📖 41) to free some space.

The point where **START/STOP** was pressed does not match the beginning/end of the recording.

- There is a slight interval between pressing **START/STOP** and the actual start/end of recording. This is not a malfunction.

The camcorder will not focus.

- Autofocus does not work on the subject. Focus manually (📖 104).
- The lens is dirty. Clean the lens with a soft lens-cleaning cloth (📖 208). Never use tissue paper to clean the lens.

When a subject flits across in front of the lens, the image appears slightly bent.

- This is a phenomenon typical of CMOS image sensors. When a subject crosses very quickly in front of the camcorder, the image may seem slightly warped. This is not a malfunction.

Changing the operating mode between recording (●)/record pause (●|||)/playback (▶) takes longer than usual.

- When the memory contains a large number of scenes, some operations may take longer than usual. Save your recordings (📖 129) and initialize the memory (📖 41).

Movies or photos cannot be recorded properly.

- This may occur as movies and photos are recorded/deleted over time. Save your recordings (📖 129) and initialize the memory (📖 41).

Cannot record a photo while recording movies.

- You cannot take photos in  mode, while the digital zoom is activated (📖 49) or while fading in or fading out a scene (📖 101).

After using the camcorder for a long time, it becomes hot.

- The camcorder may become hot after using it continuously for long periods of time; this is not a malfunction. If the camcorder becomes unusually hot or it becomes hot after using it only for a short while, it may indicate a problem with the camcorder. Consult a Canon Service Center.

Cannot create a new story.

- A memory can contain a maximum of 98 user-created stories. Delete some stories from the gallery (📖 63) or select a different memory (📖 39).

Playback

Cannot copy/move scenes in a story.

- The memory is full. Delete some recordings (📖 60, 118) to free some space.

Cannot delete a scene.

- You may not be able to delete scenes recorded or edited using another device and then transferred to a memory card connected to a computer.

Deleting scenes takes longer than usual.

- When the memory contains a large number of scenes, some operations may take longer than usual. Save your recordings (📖 129) and initialize the memory (📖 41).

Cannot capture a video snapshot scene from a movie.

- You cannot capture video snapshot scenes from scenes recorded or edited using another device and then transferred to a memory card connected to the computer. Also, you cannot capture scenes that are from movies converted to standard definition (**HFR38 / HFR37 / HFR36** only) or MP4 movies.
- The memory is full. Delete some recordings (📖 60, 118) to free some space.

When playing back scenes/slideshow with background music, the music track is not played back correctly.

- This can occur when you transfer the music files to a memory card after repeatedly recording and deleting scenes (fragmented memory). Save your recordings (📖 129) and initialize the memory card (📖 41). Then, transfer the music files first and only then transfer the video files.
- Music tracks will not play back correctly if the connection was interrupted while transferring the music files to a memory card. Delete the music tracks and transfer the music files again.
- The transfer rate of the memory card used is too slow. Use a recommended memory card (📖 36).

Cannot divide scenes

- You cannot divide scenes recorded or edited using another device and then transferred to a memory card connected to the computer. Also, you cannot divide scenes that are from movies converted to standard definition (HFR38/HFR37/HFR36 only) or MP4 movies.
- The memory is full. Delete some recordings (📖 60, 118) to free some space.

Cannot mark individual scenes/photos in the index screen with a checkmark ✓

- You cannot select more than 100 scenes/photos individually. Select the [All Scenes] or [All Photos] option instead of [Select].

Indicators and Onscreen Displays

After  lights up in yellow and you turn off the camcorder, it cannot be turned on again.

- The battery charge has become low or the battery pack is exhausted. Replace or charge the battery pack.

 lights up in red.

- Battery pack is exhausted. Replace or charge the battery pack.

 appears on the screen.

- The camcorder cannot communicate with the optional battery pack attached so the remaining battery charge cannot be displayed.

 lights up in red.

- A memory card error occurred. Turn off the camcorder. Remove and reinsert the memory card. Initialize the memory card if the display does not change back to normal.
- The memory card is full. Replace the memory card or delete some recordings (📖 60, 118) to free some space on the memory card.

Even after stopping recording, the ACCESS indicator does not go off.

- The scene is being recorded in the memory. This is not a malfunction.

The red ON/OFF (CHG) indicator flashes rapidly ( one flash at 0.5-second intervals).

- The temperature of the battery pack is outside its operating range (approximately 0 – 40 °C). Remove the battery pack, warm it or let it cool down, as necessary, and try charging it again.
- Charge the battery pack in temperatures between approximately 0 °C and 40 °C.
- The battery pack is damaged. Use a different battery pack.
- Charging has stopped because the compact power adapter or the battery pack is faulty. Consult a Canon Service Center.

 appears on the screen

- The LOCK switch on the Eye-Fi card is set to prevent accidental erasure. Change the position of the LOCK switch.
- An error occurred when trying to access control data on the Eye-Fi card. Turn the camcorder off then on again. If the icon appears often, there might be a problem with the Eye-Fi card. Contact the card manufacturer's customer care.

Picture and Sound

The screen appears too dark.

- The LCD screen was dimmed. Change the  [LCD Backlight] setting to [Normal] or [Bright].

Screen displays turn on and off repeatedly.

- The battery pack is exhausted. Replace or charge the battery pack.
- Remove the battery pack and reattach it correctly.

Abnormal characters appear on the screen and the camcorder does not operate properly.

- Disconnect the power source and reconnect it after a short time. If the problem still persists, remove the battery pack and disconnect all other power sources from the camcorder. Then, reset all the camcorder's settings to default values ( 178).



Video noise appears on screen.

- Keep a distance between the camcorder and devices that emit strong electromagnetic fields (plasma TVs, cellular phones, etc.).



Horizontal bands appear on the screen.

- This is a phenomenon typical of CMOS image sensors when recording under some types of fluorescent, mercury or sodium lamps. This is not a malfunction. To reduce the symptoms, change the  [Flicker Reduction] setting.

Sound is distorted or is recorded at lower levels.

- When recording near loud sounds (such as fireworks, shows or concerts), sound may become distorted or it may not be recorded at the actual levels. Activate the microphone attenuator ( 171) or adjust the audio recording level manually ( 109).

The picture is displayed correctly but there is no sound from the built-in speaker.





- Speaker volume is turned off. Adjust the volume.
- If the HTC-100/S HDMI Cable or optional STV-250N Stereo Video Cable is connected to the camcorder, disconnect it.
- The AV terminal is set to headphone output. Set   [AV/Headphones] to [AV].

Memory Card and Accessories





Cannot insert the memory card.

- The memory card was not facing the correct direction. Turn the memory card over and insert it.

Cannot record on the memory card.

- The memory card is full. Delete some recordings ( 60, 118) to free some space or replace the memory card.
- Initialize the memory card ( 41) when you use it with the camcorder for the first time.
- The LOCK switch on the memory card is set to prevent accidental erasure. Change the position of the LOCK switch.
- A compatible memory card must be used to be able to record movies on a memory card ( 36).
- The folder and file numbers for MP4 movies and photos have reached their maximum value. Set   [File Numbering] to [Reset] and insert a new memory card.

Cannot upload files wirelessly using an Eye-Fi card.

-   [Eye-Fi Communication] is set to [Off] ( appears onscreen). Set it to [Automatic].
- Wireless communication is not available with an Eye-Fi card in recording mode. Set the camcorder to playback mode.
- **HFR38 / HFR37 / HFR36** Wireless communication is not available with an Eye-Fi card when the camcorder has established a wireless connection. Make sure the camcorder has ended the connection.
- Opening the LCD panel may help when the wireless connection is not strong enough.
- During wireless transfer, wireless communication may stop when the wireless signal conditions worsen ( appears onscreen). Perform wireless transfer in a place with good signal conditions.
- Contact the card manufacturer's customer care.

Video noise appears on the TV screen.

- When using the camcorder in a room where a TV is located, keep a distance between the compact power adapter and the power or antenna cables of the TV.



Playback looks fine on the camcorder but there is no image on the TV screen.

- The video input on the TV is not set to the video terminal to which you connected the camcorder. Select the correct video input.

The camcorder is connected using the supplied HDMI cable, but there is no picture or sound from the HDTV.

- Disconnect the supplied HDMI cable and then restore the connection or turn the camcorder off and then on again.

The camcorder is connected using the supplied HDMI cable, but HDMI-CEC does not work (cannot play back using the TV's remote control).

- Disconnect the HDMI cable and turn off the camcorder and the TV. After a short while turn them on again and restore the connection.
-   [Control for HDMI] is set to [Off]. Set it to [On].
- HDMI-CEC is not activated on the connected TV. Activate this function on the TV.
- Even with TV sets compatible with HDMI-CEC the range of functions available differs depending on the type of TV. Refer to the instruction manual of the connected TV.

The computer does not recognize the camcorder even though the camcorder is connected correctly.

- Disconnect the USB cable and turn off the camcorder. After a short while, turn it on again and restore the connection.
- Connect the camcorder to a different USB port on the computer.

Cannot save photos on my computer

- When the memory contains too many photos (Windows – 2,500 photos or more, Macintosh – 1,000 photos or more), you may not be able to transfer photos to a computer. Try using a card reader to transfer the photos on the memory card. **HFR38/HFR37/HFR36** only: To transfer the photos in the built-in memory, copy them to the memory card in advance ( 126).

Refer also to the instruction manual of your wireless router and other devices you will use.

Wireless playback on a DLNA-compatible device is not smooth.

- Playback may not be smooth depending on the wireless router's settings and capability.
- In the [Wi-Fi] menu, set [▶] to [On] (📖 163) to play back the movie in standard definition.
- Remove any objects between the camcorder and wireless access point that may interfere with the wireless signal.
- Move the camcorder closer to the wireless access point.
- Turn off the wireless functions of other wireless devices other than the DLNA-compatible device being used for playback.
- If these do not solve the issue, the cause may be due the device or conditions unique to the surrounding area. Use the supplied HDMI cable to connect the camcorder to the device.

Cannot play back a movie on a DLNA-compatible device in AVCHD.

- Some DLNA-compatible devices may play back movies in standard definition.
- In the [Wi-Fi] menu, set [▶] to [Off] (📖 163).
- Remove any objects between the camcorder and wireless access point that may interfere with the wireless signal.
- Move the camcorder closer to the wireless access point.
- Turn off the wireless functions of other wireless devices other than the DLNA-compatible device being used for playback.
- If these do not solve the issue, the cause may be due the device or conditions unique to the surrounding area. Use the supplied HDMI cable to connect the camcorder to the device.

Cannot connect with the wireless router.

- Check that the wireless router is working correctly.
- The effective communication range between the camcorder and wireless router may vary depending on the strength of the wireless signal. Try using the camcorder closer to the wireless router.
- Cordless phones, microwave ovens, refrigerators and other appliances in the line of sight between the wireless router and the camcorder may interfere with the wireless signal. Try using the camcorder in a location farther away from such appliances.
- Wi-Fi networks with a stealth function that do not broadcast their network name (SSID) will not be detected by the camcorder during the Wi-Fi network setup. Perform the setup manually (📖 151) or turn off the stealth function of the wireless router.

The wireless connection was interrupted while transferring files.

- Incomplete files may remain at the transfer destination. If incomplete files remain at the transfer destination, check the content and make sure they are safe to delete before deleting them.
- Select [New Files] and perform the file transfer again.

List of Messages (in alphabetical order)

HFR38 / HFR37 / HFR36 Refer to *List of Messages for Connecting to an External Hard Drive* (📖 200) for external hard drive related messages. Refer to *List of Messages for Wi-Fi Functions* (📖 200) for Wi-Fi related messages.

Back up recordings regularly

- This message may appear when you turn on the camcorder. In the event of a malfunction, recordings may be lost so back up your recordings regularly.

HFR38 / HFR37 / HFR36 Built-in memory error

- The built-in memory could not be read. Contact a Canon Service Center.

HFR38 / HFR37 / HFR36 Built-in memory is full

- The built-in memory is full ("📷 End" appears on the screen). Delete some recordings (📖 60, 118) to free some space. Alternatively, save your recordings (📖 129) and initialize the built-in memory (📖 41).

HFR38 / HFR37 / HFR36 Built-in memory writing error Attempt to recover the data?

- This message will appear the next time you turn on the camcorder if power supply was accidentally interrupted while the camcorder was writing to the built-in memory. Select [Recover] to try to recover the recordings.



HFR38 / HFR37 / HFR36 Cannot access the built-in memory

- There is a problem with the built-in memory. Contact a Canon Service Center.

Cannot communicate with the battery pack. Continue using this battery pack?

- You attached a battery pack that is not recommended by Canon for use with this camcorder.
- If you are using a battery pack recommended by Canon for use with this camcorder, there may be a problem with the camcorder or battery pack. Consult a Canon Service Center.

HFR38 / HFR37 / HFR36 Cannot convert

- Cannot access the memory card. Check the memory card and make sure it is inserted correctly.
- You inserted a MultiMedia Card (MMC) into the camcorder. Use a recommended memory card (📖 36).
- There was an error creating the file name. Set   [File Numbering] to [Reset] and initialize the memory card (📖 41) or delete all the photos (📖 118) and converted SD movies (📖 60).

Cannot copy

- The total size of the scenes you selected to copy exceeds the available space on the memory card. Delete some recordings on the memory card (📖 60, 118) or reduce the number of scenes to copy.
- The memory card already contains the maximum number of AVCHD scenes (3,999 scenes). Delete some scenes (📖 60) to free some space.
- The gallery already contains the maximum number of stories (98 stories in any one given memory). Delete some stories (📖 63) to free some space.

HFR38 / HFR37 / HFR36 Cannot divide the scene. Initialize only using the camcorder.

- Use the supplied software VideoBrowser to save the scene and divide it on the computer.

Cannot enter standby mode now

- The camcorder cannot enter standby mode if the remaining battery charge is too low. Charge or replace the battery pack (📖 19).

Cannot load canvas

- The canvas file that was saved on the memory is corrupted.
- Canvas data cannot be read from canvas files created using other devices and then transferred to a memory card connected to the computer.

Cannot play back

- There is a problem with the memory. If this message appears often without apparent reason, contact a Canon Service Center.

HFR38 / HFR37 / HFR36 Cannot play back Cannot access the built-in memory

- There is a problem with the built-in memory. Save your recordings (📖 129) and initialize the built-in memory using the [Complete Initialization] option (📖 41). If the problem persists, contact a Canon Service Center.

Cannot play back Check the memory card

- There is a problem with the memory card. Save your recordings (📖 129) and initialize the memory card using the [Complete Initialization] option (📖 41). If the problem persists, use a different memory card.

HFR38 / HFR37 / HFR36 Cannot play the movies in the built-in memory Initialize only using the camcorder

- The camcorder's built-in memory was initialized using a computer. Initialize the built-in memory with this camcorder (📖 41).

Cannot play the movies on this memory card

- Movies cannot be played back from a 64 MB or smaller memory card. Use a recommended memory card (📖 36).

Cannot play the movies on this memory card Initialize only using the camcorder

- The memory card in the camcorder was initialized using a computer. Initialize the memory card with this camcorder (📖 41).

Cannot record

- You cannot capture video snapshot scenes from scenes recorded or edited using another device and then transferred to a memory card connected to the computer.
- There is a problem with the memory. If this message appears often without apparent reason, contact a Canon Service Center.

HFR38 / HFR37 / HFR36 Cannot record Cannot access the built-in memory

- There is a problem with the built-in memory. Save your recordings (📖 129) and initialize the built-in memory using the [Complete Initialization] option (📖 41). If the problem persists, contact a Canon Service Center.

Cannot record Check the memory card

- There is a problem with the memory card. Save your recordings (📖 129) and initialize the memory card using the [Complete Initialization] option (📖 41). If the problem persists, use a different memory card.

HFR38 / HFR37 / HFR36 Cannot record movies in the built-in memory Initialize only using the camcorder

- The camcorder's built-in memory was initialized using a computer. Initialize the built-in memory with this camcorder (📖 41).

Cannot record movies on this memory card

- Movies cannot be recorded on a 64 MB or smaller memory card. Use a recommended memory card (📖 36).

Cannot record movies on this memory card Initialize only using the camcorder

- The memory card in the camcorder was initialized using a computer. Initialize the memory card with this camcorder (📖 41).



Cannot save the canvas

- Cannot save your [Pens and Stamps] drawings on the memory. Save your recordings (📖 129) and initialize the memory (📖 41).

Change the battery pack

- Battery pack is exhausted. Replace or charge the battery pack.





Check the memory card

- Cannot access the memory card. Check the memory card and make sure it is inserted correctly.
- A memory card error occurred. The camcorder cannot record or display the image. Try removing and reinserting the memory card, or use a different memory card.
- You inserted a MultiMedia Card (MMC) into the camcorder. Use a recommended memory card (📖 36).
- If after the message disappears,  appears in red, perform the following: Turn off the camcorder and remove and reinsert the memory card. If  turns back to green you can resume recording/playback. If the problem persists, save your recordings (📖 129) and initialize the memory card (📖 41).

Do not disconnect the power source. Do not disconnect the USB cable unless you first use the computer to safely end the connection.

- When the camcorder is in  mode and is connected to the computer with the supplied USB cable, the camcorder cannot be operated. Disconnecting the USB cable or power source while this message appears may result in permanent loss of the recordings in the camcorder. Use the computer's Safely Remove Hardware function to end the connection and disconnect the USB cable before using the camcorder.

File name error

- The folder and file numbers have reached their maximum value. Set   [File Numbering] to [Reset] and delete all the MP4 movies ( 60) and photos ( 118) on the memory card or initialize it ( 41).

Initialize only using the camcorder

- There is a problem with the file system that prevents accessing the selected memory. Initialize the memory with this camcorder ( 41).

LCD screen has been dimmed Use the [LCD Backlight] setting to change the brightness

- Change the   [LCD Backlight] setting to [Normal] or [Bright].

May not be possible to record movies on this memory card

- You may not be able to record movies on a memory card without a Speed Class rating. Replace the memory card with one rated SD Speed Class 2, 4, 6 or 10.

Mem. Card Number of scenes already at maximum

- The memory card already contains the maximum number of AVCHD scenes (3,999 scenes); no further scenes can be copied onto the memory card. Delete some scenes ( 60) to free some space.

Mem. Card Unable to recognize the data

- The memory card contains scenes recorded using a video configuration that is not supported (NTSC). Play back the recordings in the memory card with the device originally used to record them.

Memory card cover is open

- After inserting a memory card, close the memory card slot cover.

Memory card is full

- The memory card is full. Delete some recordings ( 60, 118) to free some space or replace the memory card.

Memory card is write-protected

- The LOCK switch on the memory card is set to prevent accidental erasure. Change the position of the LOCK switch.

Memory card writing error Attempt to recover the data?

- This message will appear the next time you turn on the camcorder if power supply was accidentally interrupted while the camcorder was writing to the memory. Select [Recover] to try to recover the recordings. If you inserted a memory card that contains scenes recorded using another device, we recommend that you select [No].

Need to recover files from the memory card. Change the position of the LOCK switch on the memory card.

- This message will appear the next time you turn on the camcorder if power supply was accidentally interrupted while the camcorder was writing on the memory card and later the position of the card's LOCK switch was changed to prevent erasure. Change the position of the LOCK switch.

No memory card

- Insert a compatible memory card into the camcorder (☞ 38).
- The memory card may not be inserted correctly. Insert the memory card all the way into the memory card slot until it clicks.

HFR38 / HFR37 / HFR36 Not enough available space

- Delete some recordings on the memory card (☞ 60, 118) or select the [3 Mbps] bit rate for the conversion to SD.

Number of scenes already at maximum

- The maximum number of AVCHD scenes (3,999 scenes) has been reached. Delete some scenes (☞ 60) to free some space.

Number of stories already at maximum

- The gallery already contains the maximum number of stories (98 stories in any one given memory). Delete some stories (☞ 63) or change the recording memory for movies (☞ 39).

Recording was stopped due to insufficient write speed of the memory card

- The data transfer rate was too high for the memory card in use and the recording was stopped. Replace the memory card with one rated SD Speed Class 2, 4, 6 or 10.
- After repeatedly recording, deleting and editing scenes (fragmented memory), it will take longer to write data on the memory and recording may stop. Save your recordings (☞ 129) and initialize the memory (☞ 41).

Scene recorded using another device. Cannot copy the scene.

- Scenes that were not recorded with this camcorder cannot be copied to the memory card.
- Scenes that were edited using the supplied PIXELA's software (HFR38 / HFR37 / HFR36 only) or other software cannot be copied or divided.

Scene recorded using another device. Cannot divide the scene.

- Scenes that were not recorded with this camcorder cannot be divided with this camcorder.
- Scenes that were edited using the supplied PIXELA's software (HFR38 / HFR37 / HFR36 only) or other software cannot be copied or divided.

Scene recorded using another device. Cannot play back the scene.

- Scenes that were not recorded with this camcorder cannot be played back.

Select the desired scene number

- A number of scenes have the same recording date but different file control information. This can occur for example when you edit movies and write the files back to the camcorder. Select a number to display the corresponding group of scenes.

HFR38 / HFR37 / HFR36 Some scenes could not be converted

- Some scenes selected for conversion to SD were recorded using another device and then transferred to a memory card connected to the computer. These scenes were not converted.
- Among the scenes selected for conversion to SD there are scenes recorded with another device using 24p frame rate and then transferred to a memory card connected to the computer. When converting scenes to SD, leave out scenes recorded using another devices.

Some scenes could not be deleted

- Movies that were protected/edited with other devices and then transferred to a memory card connected to the computer, cannot be deleted with this camcorder.

Some scenes were recorded using another device and cannot be copied.

- Scenes that were not recorded with this camcorder cannot be copied to the memory card.

Task in progress. Do not disconnect the power source.

- The camcorder is updating the memory. Wait until the operation ends and do not disconnect the compact power adapter or remove the battery pack.

There are no scenes with the selected rating

- No scenes have been rated yet. Rate the scenes as you like (📖 80).
- The criteria you used to select scenes by rating resulted in no applicable scenes. Change the criteria used to select scenes by rating.

This memory card contains scenes. Delete all scenes to use relay recording.

- Save your movies (📖 129) if necessary, and delete all the movies from the memory card (📖 60).

This photo cannot be displayed

- You may not be able to display photos taken with other devices or image files created or edited on a computer and then transferred to a memory card connected to the computer.

To record video on this memory card, it is recommended to use a recording mode other than MXP or FXP

- Movies may not be recorded correctly on this memory card if the recording mode is set to MXP or FXP mode (📖 91).

Too many photos and MP4 movies. Disconnect the USB cable.

- Disconnect the USB cable. Try using a memory card reader or decrease the number of photos and MP4 movies on the memory card to fewer than 2,500 (Windows), or 1,000 (Mac OS).
- If a dialog box appeared on the computer screen, close it. Disconnect the USB cable, and restore the connection after a short while.

HFR38 / HFR37 / HFR36 Total play time is too long

- When converting scenes from a story, the maximum total playback time of the scenes to be converted is 12 hours. Reduce the number of scenes to be converted to SD.

Unable to recognize the data

- You transferred data to the camcorder recorded using a video configuration that is not supported (NTSC). Play back the recordings with the device originally used to record them.

Unable to recover data

- Could not recover a corrupted file. Save your recordings (📖 129) and initialize the memory using the [Complete Initialization] option (📖 41).

Unsupported gallery data detected. Cannot record or edit. Delete gallery data?

- The gallery data of the movies in the selected memory card is not supported. The movies can be played back but you cannot edit them or record additional scenes to this gallery. Select [Yes] to delete the unsupported gallery data. Note that after doing so, you will not be able to play back the movies with the device originally used to record the unsupported gallery data.

HFR38 / HFR37 / HFR36 List of Messages for Connecting to an External Hard Drive

Error writing to external hard drive

- This message will appear the next time you turn on the camcorder if power supply was accidentally interrupted while the camcorder was writing to the external hard drive. Select [Recover] to try to recover the recordings.

Quickly erases all files and deletes partitions from the external hard drive. Initialize?

- If you initialize the hard drive, all data it contains will be lost, including any partitioned drives. If necessary, back up data and then initialize the hard drive with the camcorder.

The compact power adapter was disconnected. Could not safely remove the external hard drive.

- While the camcorder was connected to an external hard drive, the camcorder's compact power adapter was disconnected and the connection was ended. Check whether data in the hard drive was corrupted.

HFR38 / HFR37 / HFR36 List of Messages for Wi-Fi Functions

An error occurred during FTP communication File transfer was not completed

- Turn off the camcorder and FTP server. After a short while, turn them on again and try to send the data again.

An error occurred while communicating to the computer (Network Utility) File transfer was not completed

- Cordless phones, microwave ovens, refrigerators and other appliances may interfere with the wireless signal. Try using the camcorder in a location farther away from such appliances.
- Turn off the camcorder and wireless router. After a short while, turn them on again and try to send the data again. If the problem persists contact a Canon Service Center.

Cannot connect to FTP server

- Make sure that the camcorder and FTP server have the same IP address configured.
- This message will appear if the encryption key is incorrect when the encryption method is set to [Open]. The encryption key is case sensitive so make sure to enter it correctly.
- The port number is usually 21 so make sure both the camcorder and FTP server are configured with this setting.
- If the Address setting in the FTP server is not configured, set the DNS server address in the camcorder. Also, make sure that the server name for the FTP server is correctly entered.
- Turn on the FTP server.
- A firewall may be blocking the connection. Set the firewall to allow the connection. For users of Windows XP SP2 and later, set Windows Firewall to allow the connection.
- If you are using a wireless gateway router, make sure all of the devices in the network, including the camcorder, are configured with the correct gateway address.
- If the FTP server is configured to accept only one particular IP address, change the setting so that it can accept the camcorder's TCP/IP IP address.
- The maximum number of connections to the FTP server has been exceeded. Reduce the number of connections or increase the maximum number.

Cannot log in to FTP server

- Check that the FTP server's user name and password are correctly configured in the camcorder. They are case sensitive so make sure to enter them correctly.
- Make sure permissions for files on the FTP server are set to allow access, reading and writing.
- Make sure name of the destination folder on the FTP server consists only of ASCII characters.

Cannot transfer files to FTP server

- Turn on the FTP server.
- Make sure permissions for files on the FTP server are set to allow access, reading and writing.
- Make sure permissions for the destination folder on the FTP server are set to allow access.
- Increase the FTP server's available space.

Cannot transfer files to the computer (Network Utility)

- Make sure Network Utility is running properly. If the problem persists turn off the camcorder and computer. After a short while, turn them on again.

Check the Wi-Fi settings.

- Make sure the camcorder and wireless router are correctly configured.

IP address conflict

- Change the camcorder's IP address so that it does not conflict with the IP addresses of other devices connected to the same network.

Multiple access points detected. Try the operation again.

- There are multiple wireless routers (access points) sending out a WPS signal at the same time. Try the operation again later or perform Wi-Fi Protected Setup using the PIN code option.

No access points found

- Cordless phones, microwave ovens, refrigerators and other appliances may interfere with the wireless signal. Try using the camcorder in a location farther away from such appliances.
- Make sure that you use the wireless router's SSID for the camcorder's Wi-Fi settings.
- A connection cannot be established if the wireless router is using MAC address filtering. In the camcorder's [Wi-Fi Setup] screen, use [Check Current Configuration] to check the MAC address and enter it into the wireless router's configuration screen.
- Establish a connection using infrastructure mode.

No computers found currently running Network Utility. Turn on the computer and try searching again.

- Turn on the computer on which you installed the supplied software Network Utility. Then, connect the computer to the Wi-Fi network.
- Install Network Utility if it has not already been installed.

The configured computer (Network Utility) cannot be found

- Turn on the computer on which you installed the supplied software **Network Utility**. Then, connect the computer to the Wi-Fi network.

Transfer speed changed before connecting

- If the encryption method is set to WEP, IEEE 802.11n cannot be used as the protocol for the connection so the connection was established using IEEE 802.11b or IEEE 802.11g. To use IEEE 802.11n, we recommend setting the encryption method to WPA2-PSK AES, WPA-PSK AES, WPA2-PSK TKIP or WPA-PSK TKIP.

Unable to access configuration files

- Turn off the camcorder. After a short while, turn it on again. If the problem persists contact a Canon Service Center.

Unable to complete WPS.

- Turn off the camcorder and wireless router. After a short while, turn them on again and try again. If the problem persists, perform the Wi-Fi network setup manually (📖 151).

Unable to complete WPS. Try the operation again.

- Some wireless routers require pressing and holding the Wi-Fi Protected Setup (WPS) button. For details, refer to the instruction manual of your wireless router.
- Make sure to touch [OK] on the camcorder's screen within 2 minutes of activating the Wi-Fi Protected Setup signal on the wireless router, whether by pressing the button or by entering the PIN code.

Unable to connect

- Cordless phones, microwave ovens, refrigerators and other appliances may interfere with the wireless signal. Try using the camcorder in a location farther away from such appliances.

Unable to obtain an IP address

- If you are not using a DHCP server, configure the camcorder's Wi-Fi settings manually or obtain an IP address using the [Manual] setting.
- Turn on the DHCP server. If it is already on, make sure it is functioning properly.
- Make sure the address range for the DHCP server is sufficient.
- Turn on the DNS server. If it is already on, make sure it is functioning properly.
- Make sure that the DNS server's IP address and the name for that address are correctly configured.
- Set the DNS server's IP address in the camcorder.
- If you are not using a DNS server, set the DNS address to [0.0.0.0].
- If you are using a wireless gateway router, make sure all of the devices in the network, including the camcorder, are configured with the correct gateway address.

Wi-Fi authentication unsuccessful

- Make sure the camcorder and wireless router are using the same encryption method and encryption key.
- If the wireless router is using MAC address filtering, enter the camcorder's MAC address in the wireless router's configuration screen.

Wi-Fi connection terminated

- Cordless phones, microwave ovens, refrigerators and other appliances may interfere with the wireless signal. Try using the camcorder in a location farther away from such appliances.
- The camcorder may not be able to connect to the wireless router if too many devices are accessing the wireless access point.

Wi-Fi error Incorrect authentication method

- Make sure the camcorder and wireless router are correctly configured.
- Make sure the camcorder and wireless router are using the same encryption method and encryption key.
- If the wireless router is using MAC address filtering, enter the camcorder's MAC address in the wireless router's configuration screen.

Wi-Fi error Incorrect encryption key

- The encryption key is case sensitive so make sure to enter it correctly.

Wi-Fi error Incorrect encryption method

- Make sure the camcorder and wireless router are using the same encryption method.
- If the wireless router is using MAC address filtering, enter the camcorder's MAC address in the wireless router's configuration screen.

Wireless communication is not working correctly

- Cordless phones, microwave ovens, refrigerators and other appliances may interfere with the wireless signal. Try using the camcorder in a location farther away from such appliances.
- Turn off the camcorder and wireless router. After a short while, turn them on again and perform the Wi-Fi network setup again. If the problem persists contact a Canon Service Center.

Handling Precautions

Camcorder

Be sure to observe the following precautions to ensure maximum performance.

- **Save your recordings periodically.** Make sure to transfer your recordings to an external device such as a computer or digital video recorder (📖 126) and save them on a regular basis. This will protect your important recordings in case of damage and create more free space on the memory. Canon shall not be liable for any data loss.
- Do not carry the camcorder by the LCD panel. Be careful when closing the LCD panel.
- **Handle the touch screen with care.** Do not apply excessive force and, with the exception of the supplied stylus pen, do not use ballpoint pens or other hard-tipped tools to operate the touch screen. This may damage the touch screen's surface or the pressure-sensitive layer beneath it.
- Do not attach protective film on the touch screen. The touch screen's operation is based on detecting applied pressure, so you may not be able to correctly operate the touch screen with an additional protective layer.
- Do not leave the camcorder in places subject to high temperatures (like the inside of a car parked under direct sunlight), or high humidity.
- Do not use the camcorder near strong electromagnetic fields such as above TVs, near plasma TVs or mobile phones.
- **HFR38 / HFR37 / HFR36** Do not use the camcorder's Wi-Fi functions inside hospitals, medical clinics or onboard aircraft. In addition, do not use them near medical equipment or sensitive electronic devices as it may affect their performance. In the case of pacemakers, keep the camcorder at least 22 cm away from the device.
- **HFR38 / HFR37 / HFR36** The camcorder's Wi-Fi functions may be subject to interference from devices such as cordless phones and microwave ovens. Keeping as much distance as possible from these devices or using the camcorder's Wi-Fi functions at a different time of day may reduce such interference.
- Do not point the lens at strong light sources. Do not leave the camcorder pointed at a bright subject.

- Do not use or store the camcorder in dusty or sandy places. The camcorder is not waterproof – avoid also water, mud or salt. If any of the above should get into the camcorder it may damage the camcorder and/or the lens.
- Be careful of heat generated by lighting equipment.
- Do not disassemble the camcorder. If the camcorder does not function properly, consult qualified service personnel.
- Handle the camcorder with care. Do not subject the camcorder to shocks or vibration as this may cause damage.

- When mounting the camcorder on a tripod, make sure that the tripod's fastening screw is shorter than 5.5 mm. Using other tripods may damage the camcorder.

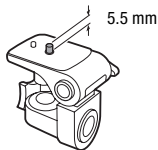

- **When recording movies, try to get a calm, stable picture.** Excessive camcorder movement while shooting and extensive use of fast zooms and panning can result in jittery scenes. In extreme cases, the playback of such scenes may result in visually induced motion sickness. If you experience such a reaction, stop the playback immediately and take a rest break as necessary.
- Do not insert the supplied stylus pen into the mouth. If swallowed, seek medical assistance immediately.
- Handle the supplied stylus pen with extreme care and keep it out of the reach of children. If mishandled, the stylus pen can present a risk of severe eye injury and even blindness.

Long-term storage

If you do not intend to use the camcorder for a long time, store it in a place free of dust, in low humidity, and at temperatures not higher than 30 °C.

Battery Pack

DANGER!

Treat the battery pack with care.

- Keep it away from fire (or it might explode).
 - Do not expose the battery pack to temperature higher than 60 °C. Do not leave it near a heater or inside a car in hot weather.
 - Do not try to disassemble or modify it.
 - Do not drop it or subject it to shocks.
 - Do not get it wet.
- Dirty terminals may cause a poor contact between the battery pack and the camcorder. Wipe the terminals with a soft cloth.

Long-term storage

- Store battery packs in a dry place at temperatures no higher than 30 °C.
- To extend the battery life of the battery pack, discharge it completely before storing it.
- Charge and discharge all your battery packs fully at least once a year.

Remaining battery time for optional battery packs

When you are using an optional battery pack that is compatible with Intelligent System, if the remaining battery time displayed is not correct, charge the battery pack fully. Still, the correct time may not be displayed after a large number of repeated uses, if a fully charged battery pack is left unused, or if a battery pack is used for long periods of time in high temperatures. Use the time shown on the screen as an approximation.

Memory Card

- We recommend backing up the recordings on the memory card onto your computer. Data may be corrupted or lost due to memory card defects or exposure to static electricity. Canon shall not be liable for lost or corrupted data.
- Do not touch or expose the terminals to dust or dirt.
- Do not use memory cards in places subject to strong magnetic fields.

- Do not leave memory cards in places subject to high humidity and high temperature.
- Do not disassemble, bend, drop, or subject memory cards to shocks and do not expose them to water.
- Check the direction before inserting the memory card. Forcing a memory card into the slot if it is not correctly oriented may damage the memory card or the camcorder.
- Do not attach any labels or stickers on the memory card.
- Secure Digital (SD) memory cards have a physical switch to prevent writing on the card so as to avoid the accidental erasure of the card's content. To write-protect the memory card set the switch to the LOCK position.

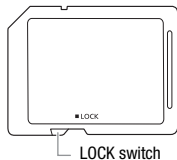

Built-in Rechargeable Lithium Battery

The camcorder has a built-in rechargeable lithium battery to keep the date/time and other settings. The built-in lithium battery is recharged while you use the camcorder; however, it will discharge completely if you do not use the camcorder for about 3 months.

To recharge the built-in lithium battery: Connect the compact power adapter to the camcorder and leave it connected for 24 hours with the camcorder off.

Disposal

When you delete movies or initialize the memory, only the file allocation table is altered and stored data is not physically erased. When you dispose of the camcorder or memory card or give either to another person, initialize the camcorder's built-in memory (**HFR38/HFR37/HFR36** only) or memory card using the [Complete Initialization] option (📖 41). Fill it up with unimportant recordings, and then initialize it again using the same option. This makes recovering the original recordings very difficult.

Maintenance/Others

Cleaning

Camcorder Body

- Use a soft, dry cloth to clean the camcorder body. Never use chemically treated cloths or volatile solvents such as paint thinner.

Lens

- If the lens surface is dirty, autofocus may not work properly.
- Remove any dust or dirt particles using a non-aerosol type blower brush.
- Use a clean, soft lens-cleaning cloth to gently wipe the lens. Never use tissue paper.

LCD Touch Screen

- Clean the LCD touch screen using a clean, soft lens-cleaning cloth.
- Condensation may form on the surface of the screen when the temperature changes suddenly. Wipe it with a soft dry cloth.

Condensation

Moving the camcorder rapidly between hot and cold temperatures may cause condensation (water droplets) to form on its internal surfaces. Stop using the camcorder if condensation is detected. Continued use may damage the camcorder.

Condensation may form in the following cases:

- When the camcorder is moved quickly from cold to warm places
- When the camcorder is left in a humid room
- When a cold room is heated rapidly

To avoid condensation

- Do not expose the camcorder to sudden or extreme changes in temperature.
- Remove the memory card and battery pack. Then, place the camcorder in an airtight plastic bag and let it adjust gradually to temperature changes before removing it from the bag.

When condensation is detected

The camcorder automatically shuts off.

The precise time required for water droplets to evaporate will vary depending on the location and weather conditions. As a general rule, wait for 2 hours before resuming use of the camcorder.

Using the Camcorder Abroad

Power Sources

You can use the compact power adapter to operate the camcorder and to charge battery packs in any country with power supply between 100 and 240 V AC, 50/60 Hz. Consult a Canon Service Center for information on plug adapters for overseas use.

Playback on a TV Screen

You can only play back your recordings on TVs compatible with the PAL system. PAL (or the compatible SECAM system) is used in the following regions/countries:

Europe: All of Europe and Russia. **Americas:** Only in Argentina, Brazil, Uruguay and French territories (French Guiana, Guadeloupe, Martinique, etc.). **Asia:** Most of Asia (except in Japan, the Philippines, South Korea, Taiwan and Myanmar). **Africa:** All of Africa and African islands. **Australia/Oceania:** Australia, New Zealand, Papua New Guinea; most Pacific islands (except for Micronesia, Samoa, Tonga and US territories like Guam and American Samoa).

Accessories (Availability differs from area to area)

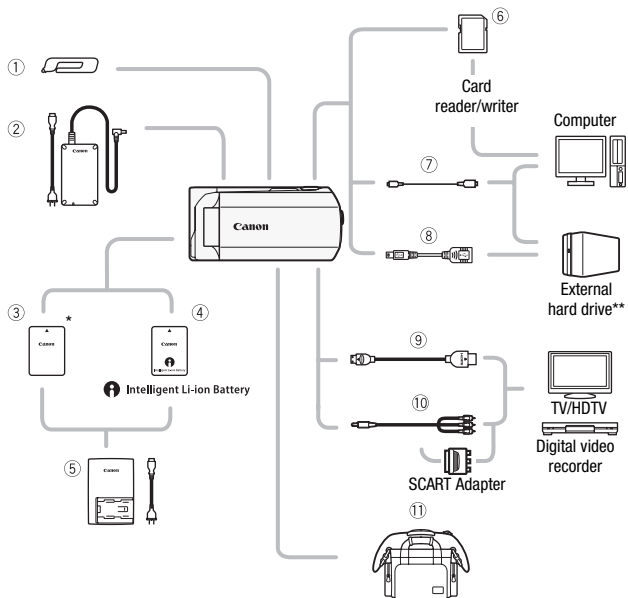

Optional accessories not listed below are described in more detail in the following pages.

- ① Stylus Pen*
- ② CA-110E Compact Power Adapter
- ③ BP-709 Battery Pack*
- ④ Intelligent Li-ion Battery
- ⑤ Memory card
- ⑥ Card reader/writer
- ⑦ IFC-300PCU/S* or IFC-400PCU USB Cable
- ⑧ HTC-100/S* or HTC-100 HDMI Cable
- ⑨ HTC-100/S* or HTC-100 HDMI Cable
- ⑩ STV-250N Stereo Video Cable
- ⑪ SCART Adapter

* Supplied with the camcorder; not available as an optional accessory.

** **HFR38 / HFR37 / HFR36** only.

Optional Accessories

Use of genuine Canon accessories is recommended.

This product is designed to achieve excellent performance when used with genuine Canon accessories. Canon shall not be liable for any damage to this product and/or accidents such as fire, etc., caused by the malfunction of non-genuine Canon accessories (e.g., a leakage and/or explosion of a battery pack). Please note that this warranty does not apply to repairs arising out of the malfunction of non-genuine Canon accessories, although you may request such repairs on a chargeable basis.

④ Battery Packs

When you need extra battery packs, select one of the following models: BP-718 or BP-727.

When you use optional battery packs bearing the Intelligent System mark, the camcorder will communicate with the battery and display the remaining usage time (accurate to 1 minute). You can only use and charge these battery packs with camcorders and chargers compatible with Intelligent System.

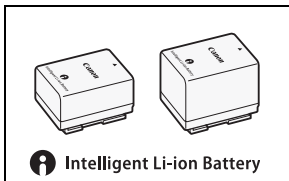

⑤ CG-700 Battery Charger

Use the battery charger to charge the battery packs.

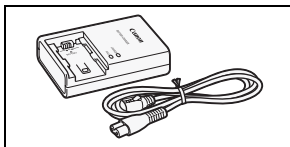

Charging, Recording and Playback Times

The charging times given in the following table are approximate and vary according to charging conditions and initial charge of the battery pack.

Battery pack→	BP-709	BP-718	BP-727
Charging conditions↓			
Using the camcorder	170 min.	310 min.	450 min.
Using the CG-700 Battery Charger	130 min.	220 min.	315 min.

Recording and playback times given in the following tables are approximate and vary according to recording mode and charging, recording or playback conditions. The effective usage time of the battery pack may decrease when recording in cold surroundings, when using the brighter screen settings, etc.

The following recording and playback times are for AVCHD movies. The recording and playback times for MP4 movies are the same as those for SP recording mode.

HFR38 / HFR37 / HFR36 Recording AVCHD movies using the built-in memory

Battery pack	Recording mode	Recording (maximum)	Recording (typical)*	Playback
BP-709	MXP	60 min.	25 min.	80 min.
	FXP	60 min.	30 min.	80 min.
	XP+	60 min.	30 min.	80 min.
	SP	60 min.	30 min.	80 min.
	LP	60 min.	30 min.	85 min.
BP-718	MXP	120 min.	70 min.	180 min.
	FXP	125 min.	70 min.	180 min.
	XP+	125 min.	70 min.	190 min.
	SP	130 min.	70 min.	190 min.
	LP	130 min.	70 min.	190 min.

Battery pack	Recording mode	Recording (maximum)	Recording (typical)*	Playback
BP-727	MPX	185 min.	105 min.	270 min.
	FXP	185 min.	105 min.	275 min.
	XP+	195 min.	110 min.	280 min.
	SP	195 min.	110 min.	285 min.
	LP	195 min.	110 min.	285 min.

Recording AVCHD movies using a memory card

Battery pack	Recording mode	Recording (maximum)	Recording (typical)*	Playback
BP-709	MPX	50 min.	25 min.	75 min.
	FXP	55 min.	25 min.	75 min.
	XP+	60 min.	30 min.	80 min.
	SP	60 min.	30 min.	80 min.
	LP	60 min.	30 min.	80 min.
BP-718	MPX	120 min.	65 min.	175 min.
	FXP	120 min.	65 min.	180 min.
	XP+	125 min.	70 min.	185 min.
	SP	125 min.	70 min.	185 min.
	LP	130 min.	70 min.	190 min.
BP-727	MPX	180 min.	100 min.	265 min.
	FXP	185 min.	105 min.	270 min.
	XP+	195 min.	105 min.	280 min.
	SP	195 min.	105 min.	280 min.
	LP	195 min.	110 min.	280 min.

* Approximate times for recording with repeated operations such as start/stop, zooming, and power on/off.

⑧ **UA-100 USB Adapter**

HFR38 / HFR37 / HFR36 Allows you to connect to the camcorder an external hard drive or similar storage device with a standard-A cable. After doing so, you can save an entire memory onto the device. Check in advance the USB cable supplied with your external hard drive.

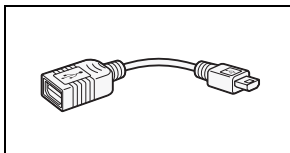

⑪ **SC-2000 Soft Carrying Case**

A handy camcorder bag with padded compartments and plenty of space for accessories.



This mark identifies genuine Canon video accessories. When you use Canon video equipment, we recommend Canon-brand accessories or products bearing the same mark.



Specifications

LEGRIA HF R38 / LEGRIA HF R37 / LEGRIA HF R36 / LEGRIA HF R306

◆ — Values given are approximate figures.

System

• Recording System

Movies: AVCHD Video compression: MPEG-4 AVC/H.264;

Audio compression: Dolby Digital 2ch

MP4 Video compression: MPEG-4 AVC/H.264

Audio compression: MPEG-2 AAC-LC (2ch)

Photos: DCF (Design rule for Camera File system), compatible with Exif* Ver. 2.3

Image compression: JPEG

* This camcorder supports Exif 2.3 (also called "Exif Print"). Exif Print is a standard for enhancing the communication between camcorders and printers. By connecting to an Exif Print-compliant printer, the camcorder's image data at the time of shooting is used and optimized, yielding extremely high quality prints.

• Video Signal Configuration

AVCHD: 1080/50i*

MP4: 720P

* Recordings made with the [PF25] frame rate are converted and recorded on the memory as 50i.

• Recording Media

- **HFR38/HFR37/HFR36** Built-in memory: **HFR38** 32 GB, **HFR37/HFR36** 8 GB

- SD, SDHC (SD High Capacity) or SDXC (SD eXtended Capacity) memory card (not included)

• Maximum Recording Time◆

HFR38 32 GB built-in memory

AVCHD movies:

MPX mode: 2 hr. 55 min. **FXP** mode: 4 hr. 10 min. **XP+** mode: 5 hr. 45 min.

SP mode: 9 hr. 35 min. **LP** mode: 12 hr. 15 min.

MP4 movies:

9 Mbps: 7 hr. 40 min. 4 Mbps: 16 hr. 55 min.

HFR37/HFR36 8 GB built-in memory

AVCHD movies:

MPX mode: 40 min. **FXP** mode: 1 hr. **XP+** mode: 1 hr. 25 min.

SP mode: 2 hr. 20 min. **LP** mode: 3 hr.

MP4 movies:

9 Mbps: 1 hr. 55 min. 4 Mbps: 4 hr. 10 min.

Commercially available 16 GB memory card

AVCHD movies:

MPX mode: 1 hr. 25 min. **FXP** mode: 2 hr. 5 min. **XP+** mode: 2 hr. 50 min.

SP mode: 4 hr. 45 min. **LP** mode: 6 hr. 5 min.

MP4 movies:

9 Mbps: 3 hr. 50 min. 4 Mbps: 8 hr. 25 min.

- **Image Sensor**
1/4.85-type CMOS, 3,280,000 pixels ♦
Effective pixels: 2,070,000 pixels ♦ (1920 x 1080)
When advanced zoom is on:
2176 x 1224 (full wide angle)
1920 x 1080 (midway between full wide angle and full telephoto)
1360 x 765 (full telephoto)
- **LCD Touch Screen:** 7.51 cm (3 inch), wide, TFT color, 230,000 dots ♦, touch operation
- **Microphone:** Stereo electret condenser microphone
- **Lens**
f=2.8-89.6 mm, F/1.8-4.5, 32x optical zoom, 51x advanced zoom
35 mm equivalent: 38.5 – 1,232 mm ♦
33.9 – 1,729 mm ♦ (when advanced zoom is on)
- **Lens Configuration:** 10 elements in 7 groups (1 aspheric element)
- **AF System**
Autofocus (TTL) or Manual focus
- **Minimum Focusing Distance**
1 m; 50 cm with tele macro on at full telephoto; 1 cm at full wide angle
- **White Balance**
Auto white balance, Custom white balance or Preset white balance settings:
Daylight, Tungsten
- **Minimum Illumination**
0.4 lx ([SCN: Low Light] recording program, Shutter speed at 1/2)
4 lx ([Programmed AE] recording program, Auto slow shutter [On], Shutter speed at 1/25)
- **Recommended Illumination:** More than 100 lx
- **Image Stabilization:** Optical-Shift Image Stabilizer
- **Size of Video Recordings**
AVCHD movies:
MXP, FXP mode: 1920 x 1080 pixels; XP+, SP, LP mode: 1440 x 1080 pixels
MP4 movies: 1280 x 720 pixels
- **Size of Photos:** 1920 x 1080 pixels

Terminals

- **AV OUT/Ⓜ Terminal**
∅ 3.5 mm minijack; output only (dual purpose terminal also for headphones stereo output)
Video: 1 V_{p-p} / 75 Ω unbalanced
Audio: -10 dBV (47 kΩ load) / 3 kΩ or less
- **USB Terminal:** mini-AB, Hi-Speed USB; output only
- **HDMI OUT Terminal**
HDMI mini connector; output only; compatible with HDMI-CEC and x.v.Color

Wi-Fi (HFR38/HFR37/HFR36 only)

- **Standard:** Complies with the IEEE 802.11b/g/n protocol
- **Frequency:** 2.4 GHz
- **Supported channels:** 1 - 13
- **Encryption methods:** WEP-64/WEP-128, TKIP/AES

Power/Others

- **Power supply (rated)**
3.6 V DC (battery pack), 5.3 V DC (compact power adapter)
- **Power consumption**♦:
2.6 W (SP mode, AF on)
- **Operating temperature**♦: 0 – 40 °C
- **Dimensions**♦ [W x H x D] (excluding the grip belt)
54 x 55 x 115 mm
- **Weight**♦ (camcorder body only)
250 g

CA-110E Compact Power Adapter

- **Power supply:** 100 – 240 V AC, 50/60 Hz
- **Rated output / consumption:** 5.3 V DC, 1.5 A / 17 VA (100 V) – 23 VA (240 V)
- **Operating temperature**♦: 0 – 40 °C
- **Dimensions**♦: 49 x 27 x 79 mm
- **Weight**♦: 110 g

BP-709 Battery Pack

- **Battery type**
Rechargeable lithium ion battery
- **Rated voltage:** 3.6 V DC
- **Operating temperature**♦: 0 – 40 °C
- **Battery capacity:** 920 mAh (typical); 3.3 Wh / 895 mAh (minimum)
- **Dimensions**♦: 30.3 x 15.6 x 40.1 mm
- **Weight**♦: 23 g

About the music files

The specifications of the music files compatible with the camcorder are as follows.

Audio encoding: Linear PCM

Audio sampling: 48 kHz, 16 bits, 2 channels

Minimum length: 1 second

File type: WAV

The music data is saved in the memory under the following folders.

HFR38 / **HFR37** / **HFR36** In the built-in memory:

\CANON\MY_MUSIC\MUSIC_01.WAV to MUSIC_99.WAV

On the memory card:

\CANON\PRIVATE\MY_MUSIC\MUSIC_01.WAV to
MUSIC_99.WAV

About the image files for the Image Mix function

Image files are saved in the memory under the following folders.

HFR38 / **HFR37** / **HFR36** In the built-in memory:

\CANON\MY_PICT\MIX_01.JPG to MIX_99.JPG

On the memory card:

\CANON\PRIVATE\MY_PICT\MIX_01.JPG to MIX_99.JPG

Weight and dimensions are approximate. Errors and omissions excepted.
The information in this manual is verified as of January 2012. Subject to change without notice.

Index

3D Flip View 57

A

Abroad, using the camcorder 209

Aspect ratio of a connected
TV (TV type) 172

Audio recording level 109

AUTO mode 43

Auto slow shutter 171

Automatic backlight correction . . . 103

AV OUT/ \square terminal . . . 110, 121, 123

B

Background music 82

Battery pack

 Battery information 179, 185

 Charging 19

 Remaining charge indicator . . 185

Beach (recording program) 95

Built-in backup battery 207

C

Camera mode 30

Capturing photos/video snapshot
 scenes from a movie 112

Cinema mode 70

Cinema-look filters 70

Condensation 208

Connections to external
 devices 122

Copying recordings to a memory
 card* 126

D

Data code 66, 172

Date and time 33

Decoration 73

Deleting

 Movies 60

 Photos 118

Dividing scenes 114

E

Edit panel 28, 168

Editing stories 85, 86

Error messages 194

Eye-Fi card 144

F

Face detection 99

Facebook* 158

Faders 101

File numbers 175

Fireworks (recording program) 96

Flicker reduction 171

Frame rate 94

G

Gallery 59, 78

H

HD to SD conversion* 140, 142

HDMI OUT terminal 121, 122

HDMI-CEC 179

Headphones 110

HOME button 26

HOME menu 26

I

Image mix 76

Image stabilizer 97

Index screen selection 58

Initializing the memory 41

Intelligent IS 47

L

Language 34

LCD screen dimmer 178

LCD touch screen 23, 25

Low light (recording program) 96

M

Main Functions panel 27, 166

* **HFR38**/**HFR37**/**HFR36** only.

Maintenance	208
Manual exposure	102
Manual focus	104
Manual mode	89
Markers	171
Memory card	36, 39, 206
Memory save*	134
Microphone attenuator	171

N

Night scene (recording program)	95
Notification sounds	178

O

Onscreen display selection	66
Onscreen icons	181
Other Settings menus	29, 170

P

P (recording program)	94
Playback	
Movies	53, 78
Photos	116
Portrait (recording program)	95
Power saving	47
Powered IS	97
Pre-recording	98

Q

Quick Start	51
-------------	----

R

Rating scenes	80
Recording	
Movies	43, 70, 89
Photos	43, 89
Recording mode	91
Recording programs	94
Recording standard	
(AVCHD/MP4)	30
Recording time	93
Relay recording	40
Resetting all camcorder settings	190

Reviewing recordings	90
----------------------	----

S

Saving recordings	126
Transferring to a computer	129
Using external	
video recorders	138
Selecting the memory*	
for playback	58
for recording	39
Self timer	108
Serial number	18
Slideshow	120
Smart AUTO	45
Snow (recording program)	95
Sports (recording program)	95
Spotlight (recording program)	96
Story Creator	67
Sunset (recording program)	95

T

Tele macro	105
Telephoto	49
Time zone/DST	35
Timeline	64
Touch & Track	100
Touch AE	102
Touch AF	104
Touch screen operations	25
Tripod	205
Troubleshooting	186
Turning off notification sounds	178

U

Uploading movies to video sharing	
Web sites	139
USB terminal	121, 124, 138

V

Video snapshot	72
Volume	55

* **HFR38** / **HFR37** / **HFR36** only.

W

White balance	106
Wide angle	49
Wi-Fi functions*	147
Wind screen	171

Y

YouTube*	158
----------------	-----

Z

Zoom	49
Advanced zoom	49
Zoom speed	49, 170

* **HFR38**/**HFR37**/**HFR36** only.

Canon

Canon Europa N.V.

Bovenkerkerweg 59-61, 1185 XB Amstelveen, The Netherlands
www.canon-europa.com

Canon UK Ltd

CCI Service Centre, Unit 130
Centennial Park, Borehamwood, Hertfordshire, WD6 3SE, United Kingdom
Telephone 0844-369-0100

Canon Australia Pty Ltd

Tel: 13-13-83 (within Australia only)
(61) 02-9805-2555
www.canon.com.au

Canon New Zealand Ltd

Tel: 0800-222-666 (within New Zealand only)
(64) 09-489-0300
www.canon.co.nz

Canon Singapore Pte. Ltd

1 HarbourFront Avenue, #04-01 Keppel Bay Tower, Singapore 098632
Tel: (65) 6799 8888, Fax: (65) 6799 8882

Canon Hongkong Company Ltd

19/F, The Metropolis Tower, 10 Metropolis Drive, Hunghom, Kowloon, Hong Kong
Tel: +852 3191 2333, Fax: +852 2428 3963

Canon Latin America, Inc.

Sales & Enquiries:
703 Waterford Way, Suite 400, Miami, FL 33126 USA

For support concerning the supplied PIXELA's software, please call PIXELA customer support (see the back cover of the Startup Guide for PIXELA's software).