INSTRUCTION MANUAL

EN

GUIDE FOR USING THE DISHWASHER AND THE WASHING PROGRAMS

1. Description of the controls	14
2. Troubleshooting	21

*Thank you for choosing one of our products.
You are advised to read this manual carefully; it contains all the information you need about the right conditions for the proper, safe use of your dishwasher.
The individual sections are laid out to provide you with a step-by-step guide to all your appliance's functions; the texts are easy to understand and are complete with detailed illustrations.
This user-friendly manual will provide answers to all your questions about use of the dishwasher.
For any other information about use and maintenance of the dishwasher, read the enclosed manual carefully.*



USER INSTRUCTIONS: *useful information is provided for the use of the washing programs and all the dishwasher's functions.*



1. Description of the controls

1.1 Upper panel

All the dishwasher controls are grouped on the upper panel.

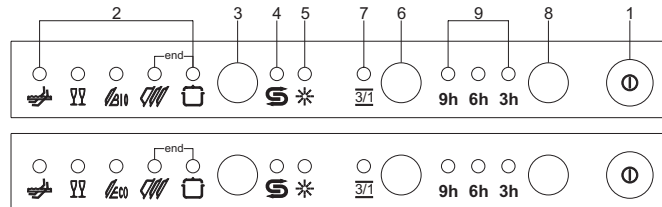

1	ON/OFF BUTTON Pressing this button energises the appliance.
2	SELECTED PROGRAM INDICATOR LIGHTS Illumination of this light denotes the program selected and the occurrence of a fault (troubleshooting).
3	PROGRAM SELECTION BUTTON By pressing this button in sequence it is possible to select the desired program.
4	SALT WARNING LIGHT (certain models only) Illumination of this light signals that salt container is empty.
5	RINSE AID WARNING LIGHT (certain models only) Illumination of this light signals that rinse aid dispenser is empty.
6	3/1 OPTION BUTTON (certain models only) Press this button to activate the option for use of 3/1 products.
7	3/1 OPTION LIGHT (certain models only) Illuminates to indicate that the function is activated.
8	DELAYED START BUTTON (certain models only) Pressing this button in sequence delays the start of the program by 3, 6 or 9 hours.
9	DELAYED START LIGHTS (certain models only) Illuminate to show that start delayed by 3, 6 or 9 hours has been set.

SETTING THE WASHING PROGRAM AND SWITCHING ON

To select the most suitable program for the dishes to be washed refer to the table below, which indicates the most appropriate program according to dish type and degree of soiling.









User instructions

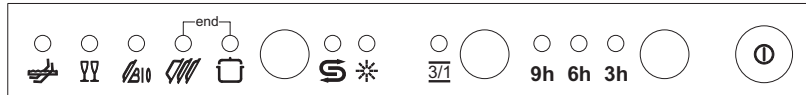

After using the table to identify the most appropriate washing program:

- press the **ON/OFF** button (1) and wait for the **PROGRAM INDICATOR LIGHT (2)** to illuminate;
- keep pressing the **PROGRAM SELECTION** button (3) until the indicator light corresponding to the desired program illuminates;
- close the door; after about **2"** the program will start. While it is in progress, the relative **LIGHT** will flash (indicating that the program is being executed).



PROGRAMME, NUMBER & SYMBOL	LOAD CROCKERY AND CUTLERY	PROGRAM PROGRESS	DURATION	CONSUMPTION		
			MINUTES (2)	WATER LITRES (1)	POWER KWh (2)	
1 	SOAK	Pans and dishes awaiting a further wash	Cold prewash	15'	6	0,03
2 	LIGHT	Wash immediately after use for dishes with light dirt	Wash at 45°C Cold rinse Rinse at 68°C Dry	70'	12	1,00
3 	BIO (*) EN 50242	Wash immediately after use for dishes with normal dirt	Cold prewash Wash at 50°C Cold rinse Rinse at 62°C Dry	180'	**	**
4 	NORMAL	Dishes with normal dirt	Cold prewash Wash at 65°C Cold rinse Rinse at 68°C Dry	90'	17	1,30
5 	INTENSIVE	Very dirty pans and dishes (except delicate items)	Prewash at 45°C Wash at 70°C 2 cold rinses Rinse at 70°C Dry	110'	20	1,60

Only run the soak program with half loads.

The "3/1" option (6) is available for all programs **except the soak program**.

(*) Reference program as per EN 50242 standard.

(**) See energy label.

(1) Average power consumption with the softener set on **level 2**.

(2) The cycle duration and power consumption may vary according to the water and room temperatures, and the type and amount of dishes.



After using the table to identify the most appropriate washing program:

- press the **ON/OFF** button (1) and wait for the **PROGRAM INDICATOR LIGHT (2)** to illuminate;
- keep pressing the **PROGRAM SELECTION** button (3) until the indicator light corresponding to the desired program illuminates;
- close the door; after about **2"** the program will start. While it is in progress, the relative **LIGHT** will flash (indicating that the program is being executed).

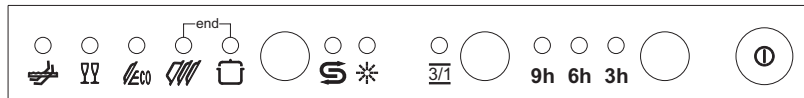

PROGRAMME, NUMBER & SYMBOL	LOAD CROCKERY AND CUTLERY	PROGRAM PROGRESS	DURATION	CONSUMPTION	
			MINUTES (2)	WATER LITRES (1)	POWER KWh (2)
1 SOAK	Pans and dishes awaiting a further wash	Cold prewash	15'	6	0,03
2 LIGHT	Wash immediately after use for dishes with light dirt	Wash at 45°C Cold rinse Rinse at 68°C Dry	70'	12	1,00
3 ECO (*) EN 50242	Wash immediately after use for dishes with normal dirt	Wash at 50°C Cold rinse Rinse at 66°C Dry	180'	**	**
4 NORMAL	Dishes with normal dirt	Cold prewash Wash at 65°C Cold rinse Rinse at 68°C Dry	90'	17	1,30
5 INTENSIVE	Very dirty pans and dishes (except delicate items)	Prewash at 45°C Wash at 70°C 2 cold rinses Rinse at 70°C Dry	110'	20	1,60

Only run the soak program with half loads.

The "3/1" option (6) is available for all programs **except the soak program**.

(*) Reference program as per EN 50242 standard.

(**) See energy label.

(1) Average power consumption with the softener set on **level 2**.

(2) The cycle duration and power consumption may vary according to the water and room temperatures, and the type and amount of dishes.



The washing cycle will not take place if the dishwasher door is left open or not properly closed.

TABLE FOR CERTIFICATION BODIES

Reference standard	EN 50242
Reference program	BIO/ECO
Load	12 place-settings
Type of detergent	B
Amount of detergent	30 g
Rinse aid setting	5/6

1.2 Washing programs



Before starting a washing program make sure that:

- The water supply tap is **open**.
- The **correct amount of detergent** has been added to the **dispenser**.
- The baskets have been **correctly loaded**.
- The spray arms are able to **rotate freely** and without obstruction.
- The dishwasher door is **securely closed**.

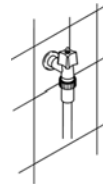

"3/1" OPTION BUTTON

Pressing this button (6) activates the "3/1" option; the relative light comes on to confirm the selection.

This option is specifically for the use of tablet or powder detergents which already contain salt and rinse aid. If you decide to use a product of this kind, press the button to allow the dishwasher to vary the necessary parameters to ensure the best washing results by making full use of the quantities of detergent, salt and rinse aid these special products contain. At the end of the cycle, the appliance automatically presets for the use of conventional products.



CANCELLING THE CURRENT PROGRAM

- To cancel the currently selected program, open the door and hold down the **PROGRAM SELECTION (3)** button for a few seconds until the **indicator lights** for programs **4** and **5** illuminate simultaneously (the word "end" is displayed on the window).

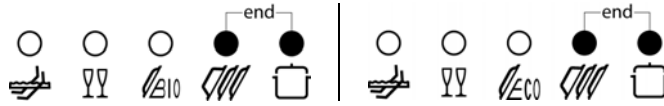

- Close the door.
- After approximately 1 minute the dishwasher will advance to the end of cycle.

CHANGING THE PROGRAM

To change the program in progress, simply open the door and select a new program. When the door is closed the dishwasher will automatically select the new program.

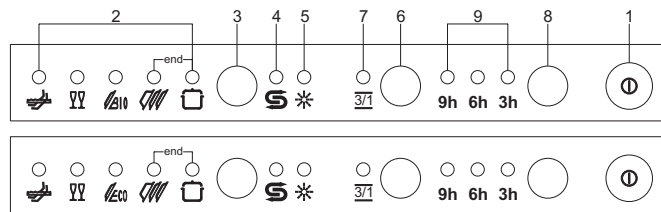

DELAYED START (certain models only)

The start of the program can be delayed by 3, 6 or 9 hours. This allows you to set the dishwasher to work at the times of day most convenient to you.

After setting the program of your choice, press the **DELAYED START** button (**8**) to select the delay you require. The corresponding **DELAYED START** light (**9**) lights up.

If you wish to exit the procedure without setting delayed start, press the button in sequence until all three lights are out.

At the end of the cycle, the procedure is automatically deleted, so if you also require it for the next program you will have to set it again.



ADJUSTING THE WATER SOFTENING SYSTEM

The dishwasher is equipped with an device for the user to adjust the water softening system according to the hardness of the water supply.

According to the machine model, the selector which acts on the adjustment may be located:

- inside the plastic locking ring located on the **right-hand** side, inside the dishwasher;
- inside the water softener, just below the cap.

Both allow for adjustment to **5** settings:

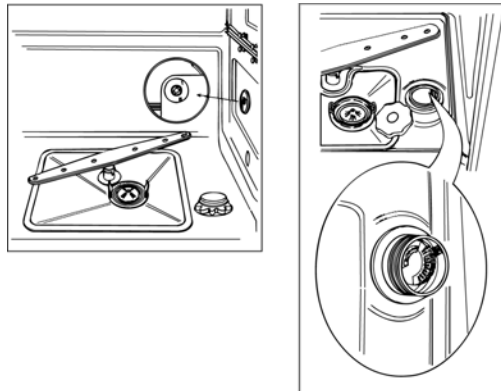

WATER HARDNESS TABLE

WATER HARDNESS		SETTING
German Degrees (°dH)	French Degrees (°dF)	
0 - 4	0 - 7	Setting N. 1 NO SALT
5 - 15	8 - 25	Setting N. 1
16 - 23	26 - 40	Setting N. 2
24 - 31	41 - 60	Setting N. 3
32 - 47	61 - 80	Setting N. 4
48 - 58	81 - 100	Setting N. 5

Contact your local water board for information on the hardness of your water supply.



TO SAVE ON ENERGY! ... AND PROTECT THE ENVIRONMENT

- Always try to run the dishwasher **fully loaded**.
- Do not wash the dishes in running water.
- Use the washing program that is **most appropriate** for each type of load.
- Do not carry out any preliminary rinsing.
- If available, connect the dishwasher to a hot water supply up to 60°C.
- When possible, **disable the drying cycle** and leave the door open at the end of the washing cycle: the residual air and heat will dry the dishes perfectly.

TO CUT DOWN ON DETERGENT CONSUMPTION! ... AND PROTECT THE ENVIRONMENT

The phosphates contained in dishwasher detergents are harmful to the environment. To avoid using excessive amounts of detergent and to save on electricity, observe the following:

- **separate** the more delicate items from dishes that are more resistant to aggressive detergents and high temperatures;
- **do not pour** the detergent directly on the dishes.



If the door has to be opened while washing is in progress, the program will be interrupted. The relative light will keep flashing and a beeper will signal that the cycle has not been completed. You must wait about **1 minute** before closing the door to restart the program. When the door is closed the program will continue from where it was interrupted. This operation should **only be carried out if strictly necessary**, because it might cause problems in execution of the program.

END OF CYCLE

At the end of the washing cycle the dishwasher gives a short acoustic signal and the program indicators nr 4 and 5 start blinking (the word "end" is displayed on the window).

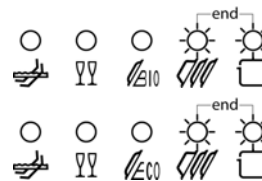

To switch off the dishwasher, open the door and press the **ON/OFF** button (1).

REMOVING THE DISHES

At the end of the washing program, wait at least **20 minutes** before removing the dishes, to allow them to cool down. To prevent any water droplets on the upper basket from falling on the dishes in the lower basket, it is **advisable** to unload the lower basket first, and then the upper basket.



2. Troubleshooting

The dishwasher is capable of signalling a number of faults through the simultaneous illumination of several indicator lights, with the following meanings:

	FAULT					DESCRIPTION
E1						Acquastop failure The anti-flooding system has been activated (for the relevant models only). The system is tripped in case of water leaks. Contact the after-sales service.
E2						Safety level The system which limits the water level inside the dishwasher has been tripped. Interrupt the program and switch of the dishwasher. Switch the dishwasher back on, program it again and start the washing cycle. If the problem persists, contact the after-sales service.
E3						Water heating malfunction II The water is not heated or the heating parameters are not correct Repeat the washing program; if the problem persists, contact the after-sales service.
E4						Water temperature monitoring malfunction Interrupt the program and switch off the dishwasher. Switch the dishwasher back on, program it again and start the washing cycle. If the problem persists, contact the after-sales service.
E5						Water intake malfunction The appliance does not take in water or does not do so correctly. Check that the water connections are correct, the water intake tap is turned on and the filter is not fouled. If the problem persists, contact the after-sales service.



	FAULT					DESCRIPTION
E6						Water pump-out malfunction The appliance does not pump out the water or does not do so correctly. Check that the drain hose is not kinked or crushed and that the siphon and filter are not fouled. If the problem persists, contact the after-sales service.
E7						Turbine flow-regulator (for the relevant models only) The appliance is not able to “measure” the amount of water loaded accurately. Interrupt the program and switch off the dishwasher. Switch the dishwasher back on, program it again and start the washing cycle. If the problem persists, contact the after-sales service.
E8						Alternate washing system malfunction Interrupt the program and switch off the dishwasher. Switch the dishwasher back on, program it again and start the washing cycle. If the problem persists, contact the after-sales service.
E9						Water intake system malfunction Contact the after-sales service.

Light off
 Light on
 Light flashing

If an alarm occurs the appliance interrupts the program in progress and signals a fault.

- Alarms **E1**, **E2**, **E3**, **E4**, **E8** and **E9** interrupt the current program immediately.
- The **E5**, **E6** alarms interrupts the running program once the cause is resolved, it will bring back the execution of the program.
- The alarm **E7** is visualized at the end of the cycle that comes, however, brought to the end since the operation of the dishwasher is not harmed.

To “reset” an alarm is necessary:

- Open and close the door, or turn off and on the machine. At this point is possible to program the dishwasher again.



If the malfunction persists, contact your authorised Service Centre.

**WARNINGS AND RECOMMENDATIONS, GUIDE FOR THE USE OF BASKETS
AND FOR CLEANING DISHWASHERS**

1. Safety and operating instructions _____	28
2. Installation and hook-up _____	31
3. Operating instructions _____	35
4. Cleaning and maintenance _____	47

*Thank you for choosing one of our products.
 You are advised to read this manual carefully; it contains all the information you need about the right conditions for the proper, safe use of your dishwasher.
 The individual sections are laid out to provide you with a step-by-step guide to all your appliance's functions; the texts are easy to understand and are complete with detailed illustrations.
 Following the cleaning instructions provided here will keep your dishwasher's performance at peak levels in the long term.
 This user-friendly manual will provide answers to all your questions about use of the dishwasher.*



INSTALLATION INSTRUCTIONS: these are intended for the **qualified technician** who must carry out the installation, hook-up and testing of the appliance.



USER INSTRUCTIONS: useful advice is provided for the use of baskets, spray arms, containers and filters.

1. Safety and operating instructions

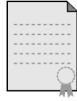

THIS MANUAL FORMS AN INTEGRAL PART OF THE APPLIANCE: IT MUST ALWAYS BE KEPT INTACT TOGETHER WITH THE DISHWASHER. BEFORE USING THE APPLIANCE, CAREFULLY READ ALL THE INSTRUCTIONS CONTAINED IN THIS MANUAL.

INSTALLATION MUST BE PERFORMED BY A QUALIFIED TECHNICIAN, IN COMPLIANCE WITH THE REGULATIONS IN FORCE. THIS APPLIANCE IS INTENDED FOR DOMESTIC USE, AND COMPLIES WITH THE **EEC DIRECTIVES 72/23, 89/336 (INCLUDING 92/31)** CURRENTLY IN FORCE, INCLUDING THE PREVENTION AND ELIMINATION OF RADIO FREQUENCY INTERFERENCE.

THE APPLIANCE IS DESIGNED FOR THE FOLLOWING PURPOSE: **WASHING AND DRYING OF DISHES**; ANY OTHER USE SHALL BE CONSIDERED IMPROPER. **THE MANUFACTURER DECLINES ALL RESPONSIBILITY FOR USES OTHER THAN THOSE DESCRIBED ABOVE.**

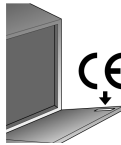

THE NAME PLATE FEATURING THE TECHNICAL DATA, SERIAL NUMBER AND MARKINGS IS VISIBLY POSITIONED ON THE INNER EDGE OF THE DOOR. **THE NAME PLATE ON THE INNER EDGE OF THE DOOR MUST NEVER BE REMOVED.**



DO NOT LEAVE THE DISCARDED PACKAGING MATERIALS UNSUPERVISED WITHIN THE HOME. SEPARATE THE VARIOUS MATERIALS WHICH MAKE UP THE PACKAGING AND TAKE THEM TO THE NEAREST SORTED WASTE COLLECTION CENTRE.

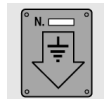

THE APPLIANCE MUST BE PROVIDED WITH AN EARTH CONNECTION IN ACCORDANCE WITH THE ELECTRICAL SAFETY REGULATIONS IN FORCE. **THE MANUFACTURER DECLINES ALL RESPONSIBILITY FOR DAMAGE TO PERSONS OR PROPERTY RESULTING FROM THE FAILURE TO EARTH THE APPLIANCE OR FROM A DEFECTIVE EARTH CONNECTION.**



IF THE APPLIANCE IS INSTALLED ON A CARPETED OR COVERED FLOOR, ENSURE THAT THE OPENINGS ON ITS UNDERSIDE ARE NOT OBSTRUCTED.

ALWAYS SWITCH OFF THE DISHWASHER AFTER EACH USE TO AVOID WASTING ELECTRICITY.



OBSOLETE APPLIANCES MUST BE RENDERED UNUSABLE. CUT OFF THE MAINS POWER CORD AFTER UNPLUGGING IT FROM THE WALL OUTLET, AND MAKE SAFE ANY COMPONENTS WHICH MIGHT BE DANGEROUS FOR CHILDREN (LOCKS, DOORS, ETC.).



THIS APPLIANCE IS MARKED ACCORDING TO THE **EUROPEAN DIRECTIVE 2002/96/EC** ON WASTE ELECTRICAL AND ELECTRONIC EQUIPMENT (**WEEE**). BY ENSURING THIS PRODUCT IS DISPOSED OF CORRECTLY, YOU WILL HELP PREVENT POTENTIAL NEGATIVE CONSEQUENCES FOR THE ENVIRONMENT AND HUMAN HEALTH, WHICH COULD OTHERWISE BE CAUSED BY INAPPROPRIATE WASTE HANDLING OF THIS PRODUCT.



THE SYMBOL  ON THE PRODUCT, OR ON THE DOCUMENTS ACCOMPANYING THE PRODUCT, INDICATES THAT THIS APPLIANCE MAY NOT BE TREATED AS HOUSEHOLD WASTE. INSTEAD IT SHALL BE HANDED OVER TO THE APPLICABLE COLLECTION POINT FOR THE RECYCLING OF ELECTRICAL AND ELECTRONIC EQUIPMENT. DISPOSAL MUST BE CARRIED OUT IN ACCORDANCE WITH LOCAL ENVIRONMENTAL REGULATIONS FOR WASTE DISPOSAL. FOR MORE DETAILED INFORMATION ABOUT TREATMENT, RECOVERY AND RECYCLING OF THIS PRODUCT, PLEASE CONTACT YOUR LOCAL CITY OFFICE, YOUR HOUSEHOLD WASTE DISPOSAL SERVICE OR THE SHOP WHERE YOU PURCHASED THE PRODUCT.

IN THE EVENT OF A FAULT, DISCONNECT THE DISHWASHER FROM THE ELECTRICAL POWER SUPPLY AND SHUT OFF THE WATER TAP.

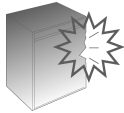

DO NOT USE APPLIANCES WHICH HAVE BEEN DAMAGED DURING TRANSIT! IF IN DOUBT, CONSULT YOUR DEALER. THE APPLIANCE MUST BE INSTALLED AND CONNECTED IN ACCORDANCE WITH THE INSTRUCTIONS PROVIDED BY THE MANUFACTURER OR BY A QUALIFIED TECHNICIAN.



THE APPLIANCE IS INTENDED FOR USE BY ADULTS. DO NOT ALLOW CHILDREN TO COME NEAR OR PLAY WITH THE DISHWASHER. KEEP CHILDREN AWAY FROM DETERGENTS AND FROM THE OPEN DISHWASHER DOOR. THE PACKAGING MATERIALS (PLASTIC BAGS, POLYSTYRENE, METAL BARS, ETC.) MUST NOT BE LEFT WITHIN THE REACH OF CHILDREN.

KEEP CHILDREN AWAY FROM THE OPEN DISHWASHER. THE APPLIANCE MAY CONTAIN RESIDUES OF DETERGENT WHICH CAN CAUSE IRREVERSIBLE DAMAGE TO THE EYES, MOUTH, AND THROAT, AS WELL AS POSSIBLE DEATH BY SUFFOCATION.



DO NOT INTRODUCE SOLVENTS SUCH AS ALCOHOL OR TURPENTINE WHICH MAY CAUSE AN EXPLOSION.

DO NOT LOAD DISHES THAT ARE SOILED WITH ASH, WAX OR PAINTS.

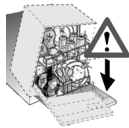

LEANING OR SITTING ON THE DISHWASHER DOOR WHEN OPEN MAY CAUSE THE APPLIANCE TO OVERTURN, PUTING PEOPLE AT RISK. NEVER LEAVE THE DISHWASHER DOOR OPEN; PEOPLE MIGHT TRIP OVER IT.



DO NOT UNDER ANY CIRCUMSTANCES TOUCH THE HEATING ELEMENT IMMEDIATELY AFTER THE END OF A WASHING PROGRAM. OVER TIME, THE DISHWASHER HEATING ELEMENTS MAY CHANGE COLOUR, IN PART OR OVERALL. THIS IS PERFECTLY NORMAL AND DOES NOT IN ANY WAY AFFECT THE OPERATION OF THE APPLIANCE.



DO NOT DRINK THE WATER RESIDUES WHICH MAY BE PRESENT INSIDE THE DISHES OR DISHWASHER AT THE END OF THE WASHING PROGRAM AND BEFORE THE DRYING CYCLE.



KNIVES OR OTHER SHARP-ENDED COOKING UTENSILS MUST BE PLACED IN THE CUTLERY BASKET BLADE-DOWN, OR LAID HORIZONTAL IN THE TOP BASKET. TAKE CARE NOT TO CUT YOURSELF AND ENSURE THAT THEY DO NOT PROJECT FROM THE BASKET.



AQUASTOP MODELS

THE AQUASTOP DEVICE PREVENTS FLOODING IN THE EVENT OF A WATER LEAK. WHEN THE AQUASTOP DEVICE IS TRIPPED, CALL IN A QUALIFIED TECHNICIAN TO IDENTIFY AND REPAIR THE FAULT.

IN MODELS EQUIPPED WITH THE AQUASTOP DEVICE, THERE IS A SOLENOID VALVE INSIDE THE WATER INTAKE HOSE. **DO NOT CUT THE HOSE AND DO NOT ALLOW THE SOLENOID VALVE TO DROP INTO WATER.** IN THE EVENT OF DAMAGE TO THE WATER INTAKE HOSE, DISCONNECT THE APPLIANCE FROM THE ELECTRICAL POWER SUPPLY AND FROM THE WATER SUPPLY.



IMMEDIATELY AFTER INSTALLING THE DISHWASHER, PERFORM A QUICK TEST OF THE APPLIANCE FOLLOWING THE INSTRUCTIONS BELOW. IF THE DISHWASHER FAILS TO OPERATE CORRECTLY, DISCONNECT IT FROM THE ELECTRICAL POWER SUPPLY AND CALL THE NEAREST TECHNICAL SERVICE CENTRE. **DO NOT ATTEMPT TO REPAIR THE APPLIANCE.**



THE DISHWASHER MEETS ALL THE REQUIREMENTS SET OUT BY THE REGULATIONS IN FORCE CONCERNING SAFETY AND ELECTRICAL EQUIPMENT. ANY TECHNICAL CHECKS SHOULD BE CONDUCTED EXCLUSIVELY BY A TRAINED AND AUTHORISED TECHNICIAN: **REPAIRS CARRIED OUT BY UNAUTHORISED PERSONS WILL INVALIDATE THE WARRANTY, AS WELL AS POSING A POTENTIAL HAZARD TO THE USER.**

The manufacturer declines all responsibility for damage to persons or property resulting from failure to observe the above precautions, from tampering with even a single component of the appliance, or from the use of non original spare parts.



2. Installation and hook-up

Remove the polystyrene basket retainers.

Position the appliance in the desired place of installation. The back or sides of the dishwasher may be placed up against walls or other furniture units. If the dishwasher is installed near a heat source, fit the special insulating panel to prevent overheating and malfunction of the appliance. To ensure stability, install integrated or built-under dishwashers only under continuous worktops, and screw them to the adjacent units. To facilitate the installation procedure, the intake and drain hoses can be positioned in any direction; make sure that the hoses are not kinked, crushed or pulled too tightly. Make sure to tighten the locking ring-nut once the pipes have been placed in the direction required. A hole at least 8 cm in diameter is required to allow the power supply cable and pipes to pass.

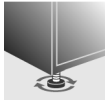

Level the appliance on the floor using its adjustable feet. This operation is essential for ensuring correct operation of the dishwasher.



*Building-in a dishwasher underneath a ceramic hob is **absolutely forbidden**.*

*A dishwasher can be built-in underneath a conventional hob provided there is **no break** in the kitchen worktop, and the dishwasher and hob are **installed and secured correctly**, so that **no hazards are generated**.*

For free-standing models only

- *Installing a hob on top of a free-standing dishwasher is **absolutely forbidden**.*
- *If the appliance is not built-in and is therefore accessible on one side, the door hinge area must be covered for safety reasons (injury hazard). The covering fixtures are available as an accessory from specialist dealers or the After-Sales Service.*
- *To build in the dishwasher, the **special kit** must be purchased from authorised dealers or the After-Sales Service.*



Some models are equipped with only one adjustable foot at the rear, which can be adjusted by turning the screw on the lower front part of the appliance.



2.1 Water supply connection



Preventing the risk of clogging or damage: if the water pipe is new or has not been used for a long time, before connecting to the water supply check that the water is clear and free of impurities, to prevent damage to the appliance. **The dishwasher must always be connected to the water system with new hoses; old or used hoses must never be reused.**

CONNECTING TO THE WATER SUPPLY

Connect the intake hose to a cold water supply with $\frac{3}{4}$ " gas thread, inserting the filter **A** supplied with the dishwasher. **Take care to screw the hose firmly into place with your hands and then complete by tightening about $\frac{1}{4}$ of a turn with pliers.**

In dishwashers equipped with the **ACQUASTOP** device, the filters is already fitted inside the threaded ring.

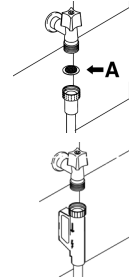

The dishwasher can also be connected to a hot water supply **not exceeding 60°C**. Supplying the appliance with hot water cuts down the washing time by approximately 20 minutes, but slightly reduces its effectiveness. Make the connection to the domestic hot water supply using the same procedure described for connecting to the cold water supply.

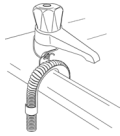

DRAIN CONNECTION

Insert the dishwasher's drain hose into a drain pipe having a diameter of at least **4 cm**, or alternatively, place it inside the kitchen sink using the plastic support provided, taking care not to crush or excessively bend the hose. It is important to prevent the hose from coming loose and falling. For this purpose, the plastic support is equipped with a hole for tying it to the wall or water tap.

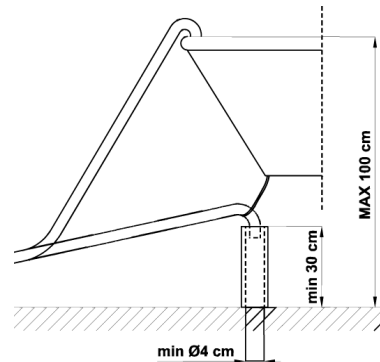

The free end should be positioned at a height of between **30 and 100 cm**, and should never be submerged in water. If a horizontal drain extension hose is used (for a maximum of 3 m) the drain hose can be placed at a maximum height of **85 cm** from the ground.



2.2 Electrical connection and precautions

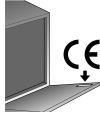

CHECK THAT THE VOLTAGE AND THE FREQUENCY OF THE MAINS MATCH THE RATINGS ON THE NAME PLATE OF THE APPLIANCE POSITIONED ON THE INNER EDGE OF THE DOOR.



THE PLUG ON THE SUPPLY CORD AND THE CORRESPONDING SOCKET OUTLET MUST BE OF THE SAME TYPE AND MEET THE REGULATIONS IN FORCE.

THE PLUG MUST BE ACCESSIBLE AFTER INSTALLATION.

NEVER DISCONNECT THE PLUG BY PULLING ON THE POWER SUPPLY LEAD.

IN THE EVENT OF DAMAGE TO THE SUPPLY CORD, HAVE IT REPLACED BY THE MANUFACTURER OR AN AUTHORIZED TECHNICAL SERVICE CENTRE.



DO NOT USE ADAPTORS OR SHUNT CONNECTIONS IN ORDER TO AVOID THE POSSIBILITY OF OVERHEATING OR BURNING.

IF THE APPLIANCE IS PROVIDED WITH A PLUGLESS SUPPLY CORD:



IT IS NECESSARY TO INSTALL IN THE FIXED WIRING AN ALL-POLE DISCONNECTION DEVICE HAVING A GAP BETWEEN CONTACTS OF AT LEAST **3.5MM**. AFTER INSTALLATION THE DISCONNECTION DEVICE HAS TO BE EASY TO REACH.



THE CONNECTION TO THE MAINS MUST BE CARRIED OUT BY A **QUALIFIED TECHNICIAN** IN ACCORDANCE TO THE SCHEME SHOWN BELOW AND THE REGULATIONS IN FORCE.

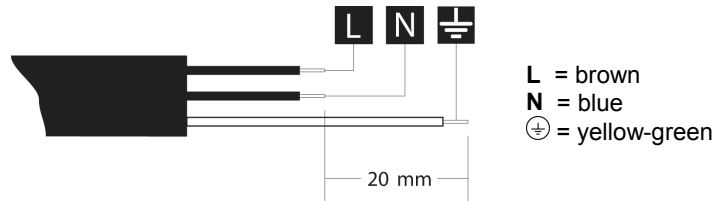

In the event of damage to the supply cord, have it replaced by the manufacturer or an Authorized Technical Service Centre in order to avoid any risk.

**WHEN CLEANING AND MAINTAINING THE APPLIANCE:**

BEFORE CARRYING OUT ANY WORK, ALWAYS UNPLUG THE APPLIANCE FROM THE ELECTRICAL SUPPLY OR SWITCH OFF THE ALL-POLE DISCONNECTION DEVICE.

FOR GREAT BRITAIN ONLY:

THIS APPLIANCE MUST BE EARTHED.

Fuse replacement

If the mains lead of this appliance is fitted with a **BS 1363A 13amp** fused plug, to change a fuse in this type of plug use an **A.S.T.A.** approved fuse to **BS 1362** type and proceed as follows:

1. Remove the fuse cover **A** and fuse **B**.
2. Fit replacement 13A fuse into fuse cover.
3. Refit both into plug.

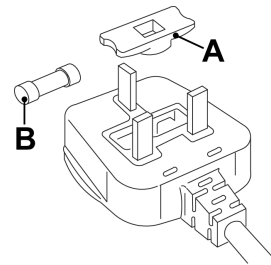

The fuse cover must be refitted when changing a fuse and if the fuse cover is lost the plug must not be used until a correct replacement is fitted.

Correct replacement are identified by the colour insert or the colour embossed in words on the base of the plug.

Replacement fuse covers are available from your local electrical store.



3. Operating instructions

Once the dishwasher has been correctly installed, prepare for use as follows:

- Adjust the water softening system;
- Add the regenerating salt;
- Add the rinse aid and detergent.

3.1 Using the water softening system



The amount of scale contained in the water (water hardness index) can cause whitish staining on the dry dishes, which tend to become dull over time. The dishwasher is equipped with an automatic softening system which uses a special regenerating salt to reduce the hardness of the water.

The dishwasher is factory set for water hardness level **3** (average hardness **41-60°dF – 24-31°dH**).

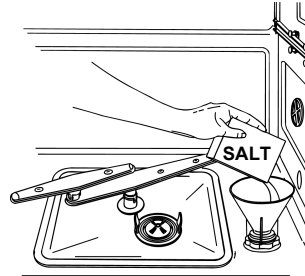

When using water of medium hardness, the regenerating salt container should be refilled after approximately **20 washing cycles**. The salt container can hold approximately **1.7 Kg** of salt in grains. Some models are equipped with an optical no-salt indicator. In these models, the cap of the salt container contains a green float which descends as the salt concentration in the water drops. When the green float can no longer be seen through the transparent cap, the container must be topped up with regenerating salt. The container is situated at the bottom of the dishwasher. After removing the lower basket, unscrew the salt container cap by turning it anticlockwise and pour in the salt using the funnel supplied with the dishwasher. Before replacing the cap, remove any salt residues from around the opening.



- *When using the dishwasher for the first time, in addition to the salt it is also necessary to add **one litre of water** to the container.*
- *Each time the salt container is refilled, make sure that **the cap is securely closed**. The mixture of water and detergent must never penetrate the salt container, as this would compromise the operation of the regeneration system. In the event of this occurring, the warranty will be invalidated.*
- ***Only** use regenerating salt specially formulated for domestic dishwashers. If using salt tablets, **do not fill the container completely**.*



- **Do not use table salt** as it contains insoluble substances which, over time, may damage the water softening system.
- When necessary, refill the regenerating salt container **before starting the washing program**. In this way, the excess saline solution will be immediately removed by the water; the prolonged presence of salt water inside the tank may lead to **corrosion**.



Be careful not to confuse the salt and detergent packages; adding detergent to the salt container will **damage** the water softening system.

3.2 Using the rinse aid and detergent dispensers

The detergent and rinse aid dispensers are situated on the inner part of the door: the **detergent dispenser** is on the left, and the **rinse aid dispenser** is on the right.

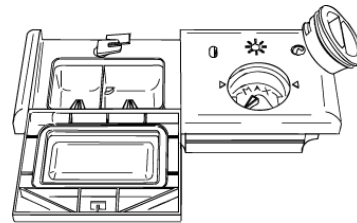

With the exception of the **SOAK** program, before every washing cycle it is necessary to add the required amount of detergent to the **detergent dispenser**. The rinse aid, on the other hand, should only be added as required.



ADDING THE RINSE AID

The rinse aid helps the dishes dry faster and prevents the formation of scale deposits and staining; it is automatically added to the water during the final rinse cycle, from the container situated on the inner side of the door.

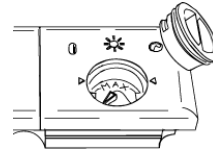

To add rinse aid:

- Open the door.
- Rotate the container cap anticlockwise by $\frac{1}{4}$ of a turn and remove it.
- Add the rinse aid until the container is full (approximately 140 cc). The optical level indicator on the side of the cap should be completely obscured. Refill the rinse aid when the optical level indicator becomes clear again, or when the rinse aid warning light illuminates.
- Replace the cover and turn it in a clockwise direction.
- Use a cloth to remove any spillage of rinse aid which might lead to the formation of excess foam.

ADJUSTING THE RINSE AID DISPENSER SETTING

The dishwasher is factory set for medium water hardness. However it is possible to change the setting by turning the dispenser's selector to the desired position: the amount of rinse aid dispensed is proportional to the selector position.

- To adjust the rinse aid setting, rotate the dispenser cap through a quarter turn in an anticlockwise direction and remove it.
- Then use a screwdriver to rotate the rinse aid selector to the desired position.
- Replace the cap, turning it clockwise.



- *The amount of rinse aid must be **increased** if the washed dishes appear dull or feature circular stains.*
- *If, on the other hand, the dishes are sticky or have white streaks, it is necessary to **reduce** the rinse aid setting.*



ADDING THE DETERGENT

To open the detergent dispenser cap, lightly press the button **P**. Add the detergent and close the cap carefully.

During the washing cycle, the dispenser will be opened automatically.

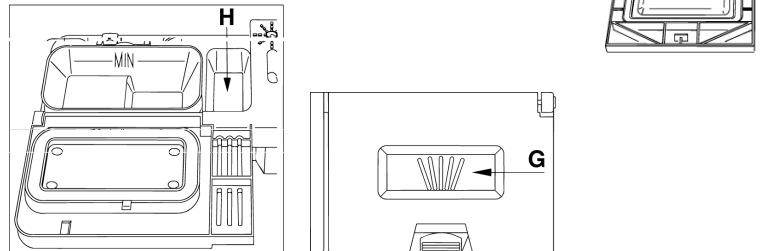

- When a program with hot prewash is selected (see program table), extra detergent must be placed in the cavity **G/H** (depending on models).
- Use **only** detergents specially formulated for dishwashers. For optimal washing results it is important to use a good quality detergent.
- The detergent packs must be sealed and stored in a dry place to prevent the formation of lumps which may negatively affect washing results. Once opened the detergent packs should not be kept for too long, otherwise the detergent loses its effectiveness.
- Do not use detergents formulated for washing dishes by hand, because they produce a great deal of foam and may negatively affect the operation of the dishwasher.
- Add the correct amount of detergent. An insufficient amount of detergent will result in a partial removal of dirt from the dishes, whereas an excessive amount is wasteful and does not improve the washing results.



- The market offers liquid and powder detergents with differing chemical compositions, which may contain **phosphates**, or be phosphate-free but contain **natural enzymes**.
 - Detergents containing **phosphates** are more effective against grease and starch at **temperatures above 60°C**.
 - **Enzyme** detergents, on the other hand, are also effective at lower temperatures (**from 40 to 55°C**) and are more easily biodegradable. With enzyme detergents it is possible to obtain at low temperatures comparable results to those which can only be achieved at **65°C** using traditional detergents.

For the safeguarding of the environment we recommend the use of **phosphate- and chlorine free** detergents.

- **"3/1" Products**

If you wish to use detergents which already contain salt and rinse aid, check whether your dishwasher is fitted with the **"3/1 option button"** on the **"Controls description"** page and then refer to the section which explains how to use this function.

If the button is not provided, we recommend the use of conventional products (separate detergent, salt and rinse aid), because with conventional washing cycles "3/1" products might create problems such as a white deposit, poor drying results and residues left on dishes.



The introduction of detergent into the rinse aid dispenser, even in liquid form, will damage the dishwasher.



3.3 General warnings and recommendations



Before using the dishwasher for the first time, it is advisable to read the following recommendations concerning **dish types** to be washed and their **loading**.

There are generally no constraints on the washing of domestic dishes, but in certain cases it is necessary to take their characteristics into account.

Before loading the dishes into the baskets it is necessary to:

- remove coarse food remains: e.g. bones, fish-bones, etc. which may clog the filter or damage the wash pump.
- soak any pots or pans with burnt-on food remains on the bottom to facilitate removal, then load them into the LOWER BASKET.

Use the "**½ load wash**" option (if available) for washing small amounts of dishes; it saves water and electricity.

When using this function, **only load the basket selected for the ½ load wash**; the other basket must remain empty.

There is no need to pre-wash the dishes under running water before loading them into the baskets since this only wastes water.

Correct loading of the dishes helps ensure optimal washing results.

WARNING!

- Make sure that the dishes are securely in place so that they cannot tip over or obstruct the rotation of the spray arms during the washing cycle.
- Do not place very small objects in the baskets as these could fall and obstruct the spray arms or the wash pump.
- Containers such as cups, bowls, glasses and pots should always be loaded with the opening facing downwards and with any cavities at an angle, to allow the water to drain out.
- Do not stack dishes or place them in such a way that they cover one other.
- Do not place glasses too close together because they may knock against each other and break, or there might be staining at the point where they touch.

MAKE SURE that the items being washed are dishwasher-safe.



Items which are not dishwasher-safe:

- **Wooden dishes, pots or pans:** these may be damaged by the high washing temperatures.
- **Handcrafted items:** these are rarely suitable for washing in a dishwasher. The relatively high water temperatures and the detergents used may damage them.
- **Plastic dishes:** heat resistant plastic dishes must be washed in the upper basket.
- **Dishes and objects in copper, tin, zinc or brass:** these tend to stain.
- **Aluminium dishes:** items made from anodised aluminium may lose their colour.
- **Silverware:** silver items may stain.
- **Glass and crystal:** in general, glass and crystal objects can be washed in the dishwasher. However, certain types of glass and crystal may become dull and lose their clearness after many washings. Therefore, for these items we recommend using the least aggressive program available.
- **Decorated items:** the decorated objects available on the market are generally able to withstand washing in the dishwasher, although the colours may fade after a great many washes. If in doubt as to the fastness of the colours, it is advisable to wash just a few items at a time for approximately one month.



3.4 Using the baskets

The dishwasher has a capacity of **12 place-settings**, including serving dishes.

EN 50242 STANDARD LOADS FOR CERTIFICATION BODIES

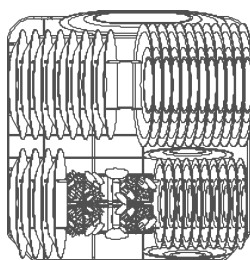

LOWER BASKET

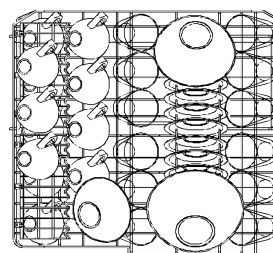

UPPER BASKET

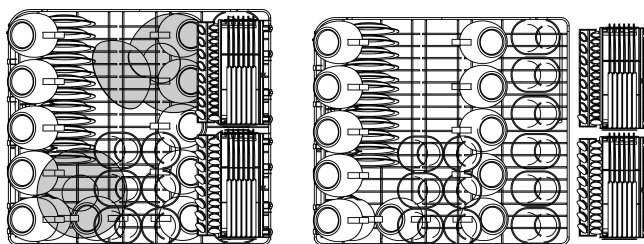

UPPER BASKET
(models with cutlery racks)



*The **upper** basket must be set in the low position.*



LOWER BASKET

The lower basket receives the full force of the lower spray arm, and should therefore be used for the “toughest” items with a heavier degree of soiling.

All types and combinations of loads are permitted, provided that the dishes, pots and pans are arranged with all the soiled surfaces exposed to the water jets coming from the bottom.

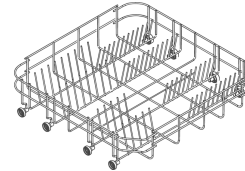

With fixed supports

To make the most of the space inside the basket when loading large items, certain models are equipped with tip-up supports for plates in 2 or 4 sections.

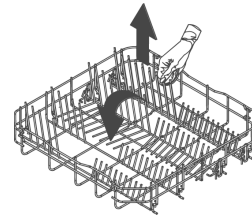

With tip-up supports

LOADING THE LOWER BASKET

Carefully load flat plates, soup plates, dessert and serving dishes, positioning them vertically. Pots, pans and their covers must be loaded upside down. When loading soup plates and dessert bowls, be sure to leave a gap between them.

Loading examples:

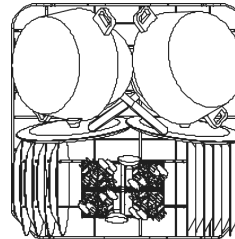
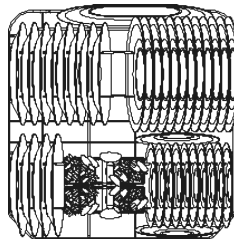

½ LOAD
(certain models only)



CUTLERY BASKET

The cutlery should be arranged in an orderly manner inside the basket, with the handles pointing downwards. Take care during loading to avoid injury from the knife blades. The basket is suitable for all types of cutlery, except those long enough to interfere with the upper spray arm. Ladles, wooden spoons and cooking knives can be placed in the upper basket, **making sure that the knife blades do not protrude from the basket.**

The dishwasher is complete with two cutlery baskets, which means that one of them can be removed, freeing space in the bottom basket, if there is not much cutlery to be washed, or if a ½ load program is being used (on models with this function).

The basket features an **exclusive system of independent sliding tip-up supports**, offering a choice of possible combinations to allow optimum use of the space available.

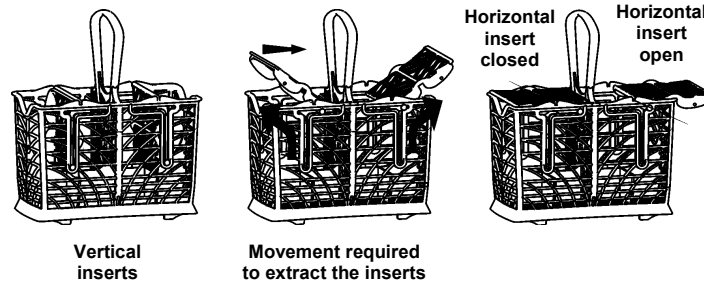

UPPER BASKET

It is recommended to load the upper basket with small- or medium-sized items such as glasses, small plates, tea or coffee cups, shallow bowls and light objects made from heat resistant plastic. If the upper basket is used in the lowermost position, it can also be loaded with serving dishes, provided they are only slightly soiled.

To make full use of the space available, the top basket has two plastic grids that can be lifted to make room for tall glasses such as stem glasses.

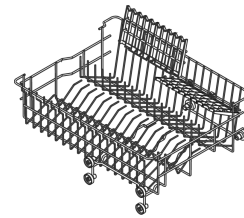



The top basket is fitted (on the left) with two plastic racks which can be raised to make room for tall glasses, such as stem glasses.

On the right there are two cutlery racks designed to take knives and teaspoons; when not in use, they can be left vertical, attached to the basket.

To use the space designed for teaspoons, remove the insert as shown in the illustrations.

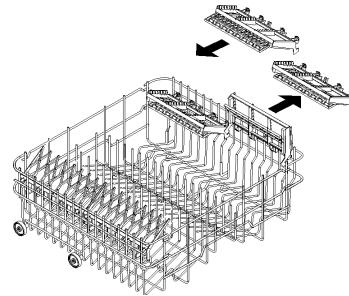

models with cutlery racks

LOADING THE UPPER BASKET

Load plates facing forward; cups, bowls etc. must always be facing downwards. The left-hand side of the basket can be loaded with two layers of cups and glasses. The centre can be filled with plates and side-plates, fitted upright into the supports provided.

Loading examples:

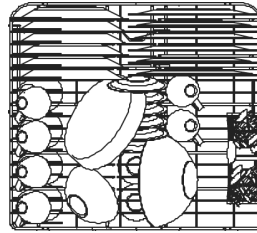
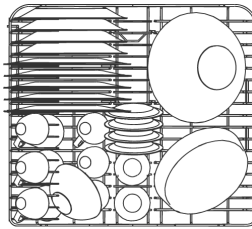

½ LOAD
(certain models only)

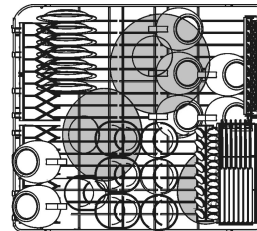
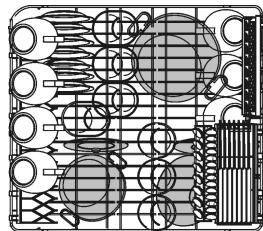

½ LOAD
(models with cutlery racks)



ADJUSTING THE UPPER BASKET

The upper basket can be adjusted in **two positions**, according to the user's needs and according to the height of the dishes in the lower basket. Proceed as follows.

Pull-out version:

- pull out the right-hand basket guide;
- remove the stop, first releasing it as shown in the diagram;
- push the guide to free the wheels;
- fit the upper or lower pair of wheels into the guide, depending on the setting required;
- return the stop to its original position.

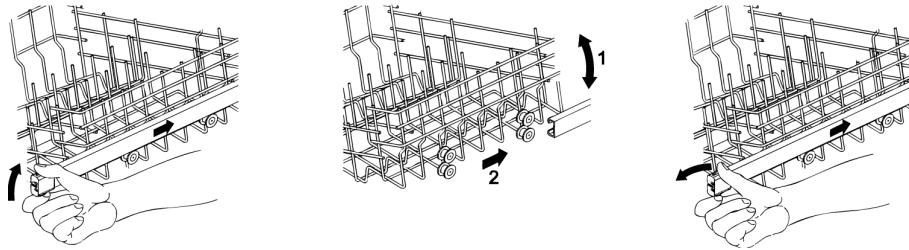

Push-button version:

- pull out the basket to its limit position and pull the right side upwards. At this point it is possible to load larger sized plates into the lower basket.
- To return to the original position, pull out the upper basket again and press the release lever.

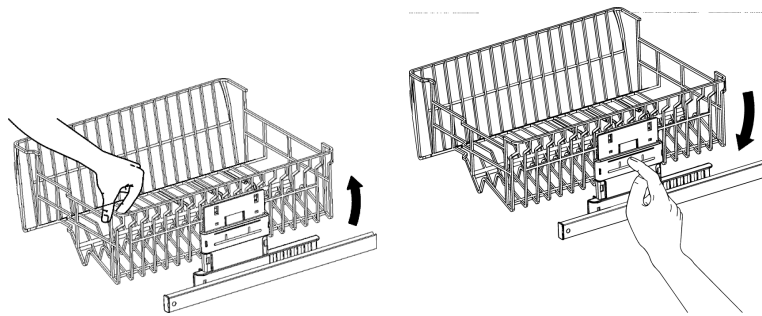



4. Cleaning and maintenance



Before carrying out any work, always disconnect the appliance from the electrical power supply.

4.1 General warnings and recommendations

Avoid the use of acidic or abrasive detergents.

Clean the outer surfaces and door-lining of the dishwasher regularly using a soft cloth moistened with water or with a normal detergent suitable for painted surfaces. Clean the door gaskets with a damp sponge. Periodically (once or twice a year) it is advisable to clean the tank and gaskets, using a soft cloth and water to remove any deposits.

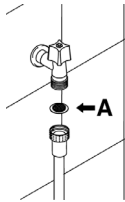

CLEANING THE WATER INTAKE FILTER

The water intake filter **A** located at the outlet of the water supply tap needs to be cleaned periodically.

After having closed the water supply tap, unscrew the end of the water intake hose, remove the filter **A** and clean it delicately under running water. Reassemble filter **A** in its seat and carefully screw the water intake hose back into position.

CLEANING THE SPRAY ARMS

The spray arms can be easily removed for periodic cleaning of the nozzles, to prevent possible clogging. Wash them under running water and carefully replace them in their seats, **checking that their rotary movement is in no way impeded.**

- To remove the **upper** spray arm, unscrew locking ring **R**.
- To remove the **orbital** spray arm assembly, take hold of the longer arm and pull the orbital unit upward. Wash the arms under a jet of running water and return them carefully to their seat. **After reassembly, check that the spray arms turn freely.** Otherwise, check that they have been installed correctly.

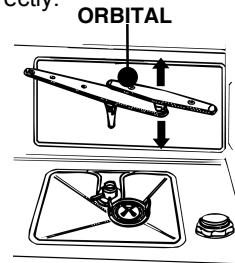
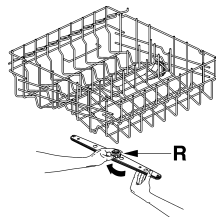



CLEANING THE FILTER UNIT

- It is advisable to periodically inspect the centre filter **C** and, if necessary, to clean it. To remove the filter, grip the tabs, turn them anticlockwise and lift upwards;
- push the centre filter **D** from the underside to remove it from the micro-filter:
- separate the two parts which make up the plastic filter by pressing the body of the filter in the zone shown by the arrows;
- remove the centre filter by lifting it upwards.

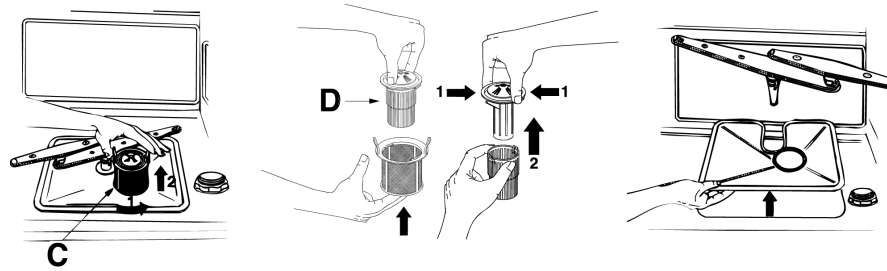

GENERAL WARNINGS AND RECOMMENDATIONS FOR CORRECT MAINTENANCE:

- The filters should be cleaned **under running water** using a stiff brush.
- It is essential to **thoroughly clean the filters** according to the above instructions: the dishwasher cannot function if the filters are clogged.
- **Carefully replace** the filters in their seats, to avoid damaging the wash pump.

PROLONGED DISUSE:

- Run the soak program twice in succession.
- **Unplug** the power cord from the socket.
- **Leave the door slightly open**, in order to prevent the formation of unpleasant odours inside the washing tank.
- **Fill the rinse aid dispenser.**
- **Shut off the water supply tap.**



BEFORE STARTING THE DISHWASHER AFTER PROLONGED DISUSE:

- Check that there are no deposits of sludge or rust inside the water pipe: if there are, allow the water to run from the water supply tap for a few minutes.
- **Plug the power cord** back into the socket.
- **Reconnect the water intake hose and open the tap again.**

TROUBLESHOOTING MINOR PROBLEMS

In some cases it is possible to remedy minor problems by referring to the following instructions:

If the program fails to start, check that:

- the dishwasher is connected to the electrical power supply;
- there is no power failure;
- the water tap is open;
- the dishwasher door is properly closed.

If water remains inside the dishwasher, check that:

- the drain hose is not kinked;
- the drain siphon is not obstructed;
- the dishwasher filters are not clogged.

If the dishes are not being cleaned properly, check that:

- the correct amount of detergent has been added;
- there is regenerating salt inside the special container;
- the dishes are being loaded correctly;
- the selected program is suitable for the dish types and their degree of soiling;
- all the filters are clean and positioned correctly;
- the spray arm nozzles are not obstructed;
- there is no object obstructing the rotation of the spray arms.



If the dishes fail to dry or remain dull, check that:

- there is rinse aid inside the special container;
- the rinse aid dispenser setting is correct;
- the detergent used is of good quality and has not lost its effectiveness (for example, through incorrect storage, with the box left open).

If the dishes show signs of streaking, staining, etc., check that:

- the rinse aid dispenser setting is not too high.

If there are visible traces of rust inside the tank:

- the tank is made of steel, and therefore any rust marks are due to external elements (fragments of rust from the water pipes, pots, cutlery, etc.). Special products are commercially available to remove such marks;
- check that the amount of detergent being used is correct. Certain detergents can be more corrosive than others.
- check that the cap of the salt container is securely closed, and that the water softening setting is correct.



If after following the above troubleshooting instructions the problem persists, call the nearest After-Sales Centre.

WARNING: any operations performed on the appliance by unauthorised persons are not covered by the warranty and shall be paid for by the user.

TECHNICAL DATA

Width	597 ÷ 599 mm
Depth measured flush with the outer edge of the control panel	Free standing: 600 mm Semi-integrated: 590 mm - Fully integrated: 570 mm
Height (depending on models)	Free standing: from 850 mm to 870 mm from 890 mm to 910 mm Semi-integrated and fully integrated: from 820 mm to 870 mm from 860 mm to 910 mm
Capacity	12 Standard place settings
Water supply pressure	min. 0,05 - max. 0,9 MPa (min. 0.5 – max. 9 bar)
Electrical characteristics	See rating plate

ATTENZIONE: montare la porta e regolare la tensione delle molle laterali prima dell'installazione. IMPORTANT: door template, do not destroy. Fit door and adjust hinge tension before installation.
ATTENTION: après montage de la porte, régler la tension des ressorts lateraux avant l'installation. WICHTIG: Tür montieren, Türfedern vor Einbau einstellen.

Allineare al bordo superiore del pannello porta.
Align with the top edge of the door panel.
Aligner au bord supérieur du panneau de la porte.
Mit der Oberkante der Dekorplatte fluchten.
Alinhar com o rebordo superior do painel da porta.
Vyrovnajte s horním okrajem dveřního panelu.
Az ajtópanel felso szélével hozzuk egy vonalba.
Wyrównac do górnej krawędzi panelu drzwiowego.
Pripojit na vrchný okraj dverového panelu

Zet hem op één lijn met de bovenste rand van het durpaneel.
Alinear respecto del borde superior del panel puerta.
Alinhe com a borda superior do painel da porta.
Skal flugte med overkanten af lågepanelet.
Aseta ovipaneelin yläreunan kohdalle.
Sett den øvre kanten i flukt med dørrpanelet.
Placera i linje med dörrpanelens överkant

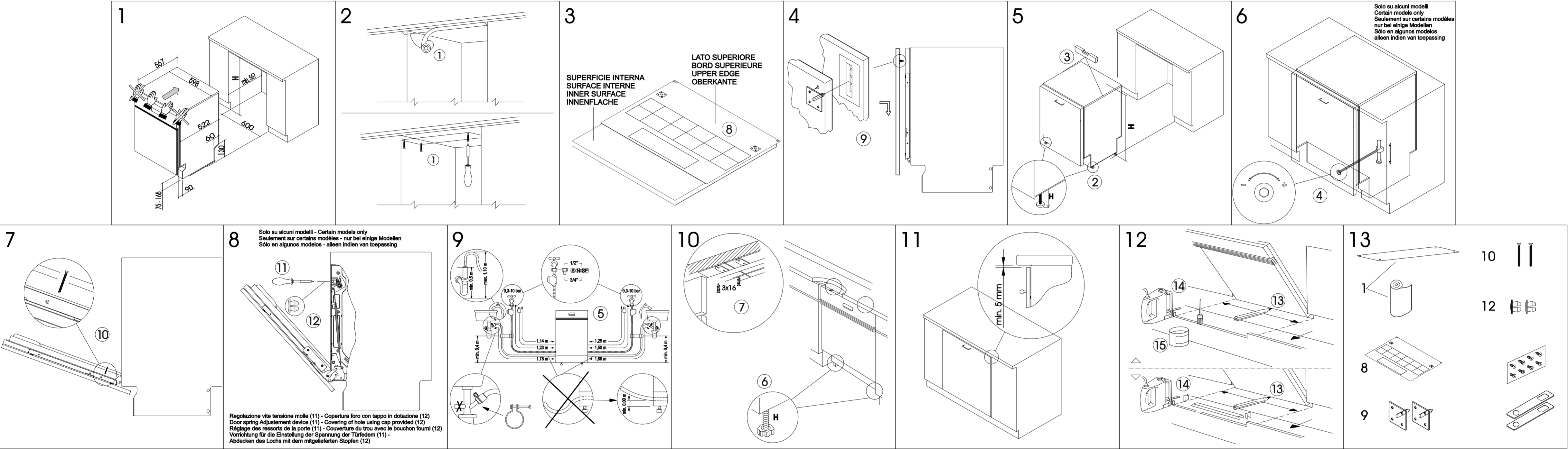
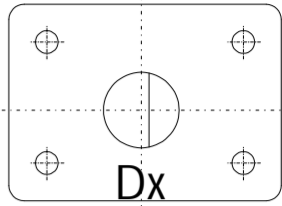
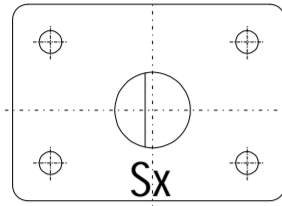

NOTA: Solamente alcuni modelli sono dotati di uno dei dispositivi sotto illustrati. **N.B.:** Only some models are equipped with one of the two devices illustrated below. **REMARQUE:** seul quelques modèles sont munis de l'un de deux dispositifs illustrés ci-dessus.
ANMERKUNG: Nur einige Modelle verfügen über eine der beiden unten dargestellten Einrichtungen. **NOTA BENE:** uitsluitend bepaalde modellen zijn uitgerust met één van de twee onderstaand afgebeelde inrichtingen **NOTA:** Sólo algunos modelos están equipados con uno de los dos dispositivos que se ilustran a continuación.
NOTA: Só alguns modelos estão equipados com ou dos dois dispositivos ilustrados abaixo

IT-Sicurezza contro gli allagamenti
Questo sistema di sicurezza protegge il vostro appartamento da danni dell'acqua. In caso di guasto al tubo di entrata o permeabilità del sistema della macchina, l'entrata dell'acqua viene interrotta.
La scatola della sicurezza anti-allagamento montata sul tubo, contiene parti elettriche. E' pertanto proibito collocare la scatola stessa nell'acqua. Nel caso in cui per una ragione qualsiasi la scatola subisca danni, togliere immediatamente la presa di collegamento dalla rete elettrica.
ES-Aquastop® por septuplicado
El sistema "AQUASTOP" por septuplicado protege su vivienda de forma fiable e de danos por escapes de agua. Se corta inmediatamente el suministro de agua en caso de cualquier fuga en tubos o en componentes del aparato. El cajón de válvulas del tubo aquastop contiene componentes eléctricos. Por este motivo no debe sumergirse en agua. En caso de que el cajón de válvulas estuviera dañado, debe desconectarse de la red eléctrica, desenchufando la clavija.
SLO-AQUASTOP - Zaščita pred poplavo
Ta varnostni sistem varuje vaše stanovanje pred škodo, ki bi jo povzročila voda. V primeru okvare na dovodni cevi ali v primeru puščanja na sistemu pomivalnega stroja, se prekine dovod vode. Ohišje ventila oz. Varnostne naprave, ki je nameščena na cevi, vsebuje električne dele. Zato je ne smete potopiti v vodo. V primeru, da se ta škaltla iz kakršnegakoli razloga poškoduje, nemudoma izklopite aparat iz električnega omrežja.
HR AQUASTOP - Zaštita pred poplavom
Ovaj sigurnosni sistem štiti vaš stan od štete koju može uzrokovati voda. U slučaju kvara na dovodnoj cijevi ili u slučaju propuštanja na sistemu stroja za pranje posuđa, prekida se dovod vode. Kućište ventila, odnosno sigurnosne naprave, namještene na cijevi, sadrži električne djelove. Zato je ne smijete potopiti u vodu. U slučaju da se kutija iz bilo kojeg razloga ošteti, odmah isključite aparat iz električne mreže.

DA-Sikkerhed mod vandlækage
Dette sikkerhedssystem beskytter din lejlighed for vandskader. Tilførslen af vand bliver afbrudt, hvis tilførselslangen er defekt, eller hvis maskinsystemet er utæt.
Sikkerhedsboksen på slangen indeholder elkompnenter.
Boksen må derfor ikke anbringes i vand.
Hvis boksen bliver beskadiget, skal stikket øjeblikkeligt tages ud af stikkontakten.
FI-Aquastop-turvajärjestelmä
Tämä turvajärjestelmä suojaa asuntoasi vesivahingoilta. Jos veden ottoletku tai koneen vesijärjestelmä vuotaa, vedenotto keskeytyy. Aquastop-turvajärjestelmän kotelo on asennettu letkuun ja se sisältää sähköosia.
Älä laita koteloa veteen. Jos kotelo jostain syystä vahingoittuu, kytkte laite heti irti sähköverkosta irrotta alla pistoke pistorasasta.
МК AQUASTOP - Заштита од поплава
Овој заштитен систем го штити вашиот стан од поплава. Во случају на оштетување на доводната цевка или пак ако пропушта систем во машината за миенење садови, се прекинува доводот на вода. Кукиштето на вентилот односно на сигурносната направа која е наместена на цевката, содржи електрични делови и затоа не смеете да ја топите во вода. Ако се случи од било какви причини кукиштето да се оштети, апаратот веднаш исклучете го од електричната мрежа.
FR-Paliers de sécurités pour empêcher les fuites
Le système est doté de sept paliers de sécurité pour éviter les fuites d'eau et protéger ainsi votre logement contre d'éventuels dégâts matériels. Si le tuyau d'arrivée d'eau n'est pas étanche ou si la machine fuit, ce dispositif arrête l'écoulement d'eau. Le boîtier de sécurité qui contrôle l'arrivée d'eau est situé sur le tuyau et contient des parties électriques. Il ne faut donc pas le tremper dans l'eau. S'il est endommagé pour une raison quelconque, débranchez immédiatement l'appareil en retirant la prise.

EN-Aquastop safety device
The AQUASTOP is safety device. The aquastop assures that the fresh water hose need only take the stress of water pressure during the actual timer water is flowing. If the hose should begin to leak during this time, the magnetic valve in the water spout cuts off the flow, and the hose is relieved of pressure. Operating pressure DIN 44995.
The valve casing on the water-stop hose contains electrically controlled components. It is should not, therefore, be submersed in water. If the housing becomes damaged the plug must be removed from the socket.
PT-Segurança contra os alagamentos
Este sistema de segurança protege o seu apartamento contra os danos provocados pela água. A entrada da água é interrompida em caso de anomalia no tubo de entrada ou de permeabilidade do sistema da máquina.
A caixa de segurança anti-alagamento montada no tubo contém partes elétricas. Não deve, por isso, ser mergulhada na água. Se, por algum motivo, a caixa ficar danificada retire imediatamente a ficha da tomada.

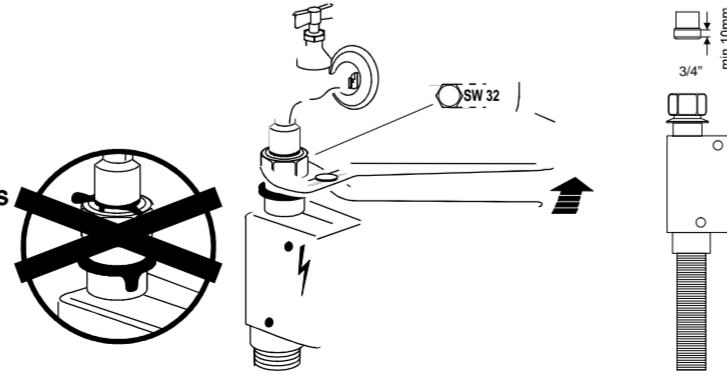

Aquastop
Dieses Wasserschutz-System schützt Ihre Wohnung zuverlässig vor Wasserschaden. Bei undichtem Wasserzulaufschlauch oder undichtem Maschinensystem wird jeglicherweiterer Wasserzulauf unterbunden.
Der Ventilkasten am Wasserstop Schlauch beinhaltet elektrisch gesteuerte Bauteile. Er darf deshalb nicht in Wasser getaucht werden. Sollte das Ventilkastengehäuse beschädigt sein, ist unbedingt der Netzstecker aus zu ziehen. Aquastop-Verlängerung
Im Handel können längere Aquastopschläuche gekauft werden, die von einem Fachmann mit dem bestehenden Aquastopschlauch ausgetauscht werden müssen. Bei einer eigenmächtigen Verlängerung des Wasserzufuhrschlauches trägt der Hersteller keine weitere Verantwortlichkeit.
YU AQUASTOP - Заштита пред поплавом
Овај безбедносни систем ваш стан од штете коју може да узрокује вода. У случају кvara на доводној цеви или у случају прекида се овода воде. Кукиште вентила односно безбедносно направе, монтиране на цеви, садржи електричне делове. Зато несмете да је потапуњате у воду. Ус случају да се кутија из било ког разлога оштети, одмах искључите апарат из електричне мреже.

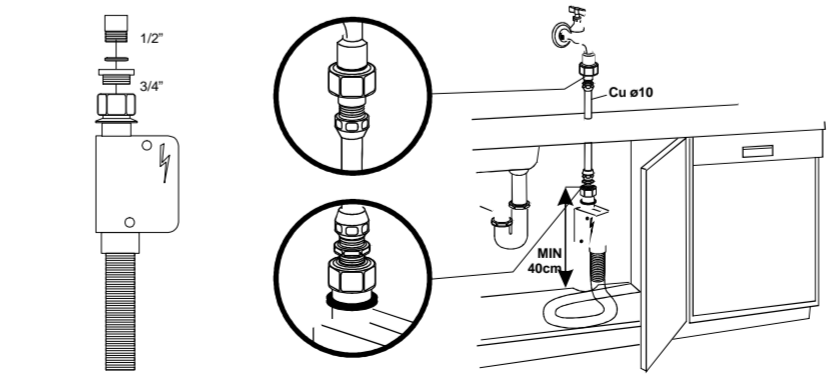

NL-Dit veiligheidsysteem beveiligd uw woning tegen waterschade.
Bij lekkage in de aanvoerslang of in de machine zelf wordt de wateraanvoer stopgezet. Het afsluitmechanisme bevindt zich in een doos op de aanvoerslang en bevat elektrische componenten.
Daarom is het verboden het doosje in water onder te dompelen.
Mocht de doos beschadigen ertonen, dan dient de stekker onmiddellijk uit de contactdoos te worden genomen om aldus de netverbinding uit te schakelen.
NO-Sikring mot oversvømmelse
Dette sikkerhetssystemet beskytter boligen din mot vannskader. Dersom det oppstår en feil på tilførselsrøret eller en lekkasje i maskinen, vil vanntilførselen stenges.
Boksen med sikkerhetssystemet er plassert på slangen og inneholder elektriske deler. Boksen må derfor aldri dyppes i vann. Dersom boksen av en eller annen grunn blir skadet, må støpslet til maskinen snarest trekkes ut av stikkontakten.
SK-Bezpečnost proti zatopeniu
Tento bezpečnostný systém chráni váš byt pred škodami spôsobenými vodou.
V prípade porušenia vstupnej rúry alebo priepustnosti na systéme zariadenia, vstup vody sa pozastaví.
Bezpečnostná skrinka proti zatopeniu namontovaná na rúre obsahuje elektrické súčasti. Jet preto zakázané umiestniť samotnú skrinku do vody. Ak sa skrinka z akchkoľvek dôvodov poškodí, ihneď uskutočnite vypojenie z elektrickej siete.

CS-Systém Aquastop proti vyplavení
Tento bezpečnostní systém chrání váš byt před vyplavením. V případě poruchy přívodní hadice nebo netěsnosti systému spořibeče se přeruší přívod vody.
Těleso bezpečnostního ventilu namontovaného na hadici Aquastop obsahuje elektrické prvky a nesmí se proto namáčet do vody. V případě jakéhokoli poškození tělesa ventilu okamžitě vytáhněte zástrčku z elektrické zásuvky.
SV-Säkerhetssystem mot översvämning
Detta säkerhetssystem skyddar din lägenhet mot vattenskador. Om den ingående slangen går sönder eller om maskinen läcker vatten avbryts vattenintaget.
Lådan med översvämningsskyddet som är monterad på slangen innehåller elektriska komponenter. Därför är det förbjudet att placera lådan i fråga i vatten. Dra omedelbart ut stickkontakten ur eluttag om lådan skadas av någon anledning.
PL-System AQUA STOP
AQUA STOP to system zabezpieczający przed zalaniem. W przypadku awarii węża doprowadzającego wodę lub nieszczelności pralki, dopływ wody jest automatycznie odcinany. Urządzenie zabezpieczające przez zalaniem zamontowane na wężu zawiera części elektryczne i nie może być zanurzane w wodzie. Jeśli z jakiegokolwiek powodu urządzenie zostanie uszkodzone, należy niezwłocznie odłączyć je od zasilania.
HU-Az eláradás ellen védő biztonsági berendezés.
Ez a biztonsági berendezés megvédi a lakást a víz okozta károktól. Ha sérül a bemeneti cső, vagy a gép rendszere áteresztí a vizet, a vízbemenet leáll.
A csőre szerelt eláradás ellen védő biztonsági doboz elektromos alkotórészeket tartalmaz. Emiatt tilos a dobozt víz alá helyezni. Ha bármilyen okból megsérül a doboz, válassza le a csatlakozót az elektromos hálózatról.