

SC-P600 Series

User's Guide

Copyrights and Trademarks

Copyrights and Trademarks

No part of this publication may be reproduced, stored in a retrieval system, or transmitted in any form or by any means, electronic, mechanical, photocopying, recording, or otherwise, without the prior written permission of Seiko Epson Corporation. The information contained herein is designed only for use with this Epson printer. Epson is not responsible for any use of this information as applied to other printers.

Neither Seiko Epson Corporation nor its affiliates shall be liable to the purchaser of this product or third parties for damages, losses, costs, or expenses incurred by the purchaser or third parties as a result of accident, misuse, or abuse of this product or unauthorized modifications, repairs, or alterations to this product, or (excluding the U.S.) failure to strictly comply with Seiko Epson Corporation's operating and maintenance instructions.

Seiko Epson Corporation shall not be liable for any damages or problems arising from the use of any options or any consumable products other than those designated as Original Epson Products or Epson Approved Products by Seiko Epson Corporation.

Seiko Epson Corporation shall not be held liable for any damage resulting from electromagnetic interference that occurs from the use of any interface cables other than those designated as Epson Approved Products by Seiko Epson Corporation.

EPSON, EPSON EXCEED YOUR VISION, EXCEED YOUR VISION, UltraChrome, and their logos are registered trademarks or trademarks of Seiko Epson.

Microsoft®, Windows®, and Windows Vista® are registered trademarks of Microsoft Corporation.

Apple®, Macintosh®, Mac OS®, OS X®, iPad®, iPhone®, iPod touch®, iTunes®, and ColorSync® are trademarks of Apple Inc., registered in the U.S. and other countries.

AirPrint and the AirPrint logo are trademarks of Apple Inc.

Android™ and Google Cloud Print™ are trademarks of Google Inc.

Wi-Fi® and Wi-Fi Alliance® are registered trademarks of the Wi-Fi Alliance. Wi-Fi Direct™ and WPA2™ are trademarks of the Wi-Fi Alliance.

Intel® is a registered trademark of Intel Corporation.

PowerPC® is a registered trademark of International Business Machines Corporation.

Adobe®, Photoshop®, Lightroom®, and Adobe® RGB are registered trademarks of Adobe Systems Incorporated.

General Notice: Other product names used herein are for identification purposes only and may be trademarks of their respective owners. Epson disclaims any and all rights in those marks.

Copyright © 2014 Seiko Epson Corporation. All rights reserved.



Contents

Copyrights and Trademarks

Introduction

Important Safety Instructions.	6
When choosing a place for this product.	6
When setting up this product.	6
When using this product.	7
Using the printer with a wireless connection.	7
When handling the ink cartridges.	7
Using the LCD screen (Touch panel).	7
Meaning of Symbols.	8
Printer Parts.	9
Front section.	9
Inside.	10
Back.	10
Control panel.	11
Home Screen View.	12
Printer Features.	14
Realizing High Resolution.	14
Realizing High Productivity.	15
Superior Ease of Use.	15
Notes on Usage and Storage.	17
Installation space.	17
Notes when using the printer.	17
Notes when not using the printer.	17
Notes on handling ink cartridges.	18
Notes on handling paper.	19
Introducing the Supplied Software.	20
Contents of the Software Disc.	20
Summary of the Printer Driver.	21

Basic Operations

Loading Cut Sheets.	22
Loading Paper into the Auto Sheet Feeder.	22
Loading Fine Art Media.	23
Loading Poster Board.	25
Loading and Removing Roll Paper.	27
Loading Roll Paper.	27
Cutting Roll Paper.	28
Removing Roll Paper.	28
Loading and Removing CDs and DVDs.	29
Loading CDs and DVDs.	29
Removing the CDs and DVDs.	30
Basic Printing Methods(Windows).	31

Basic Printing Methods(Mac OS X).	33
Printable area.	34
The Printed Area for Cut Sheets.	34
The Printed Area for Roll Paper.	34
The Printed Area for CDs and DVDs.	35
Changing the Type of Black Ink.	35
Switching Automatically.	35
Switching Manually.	36
Energy Saving Settings.	37
Canceling Printing.	38

Using the Printer Driver(Windows)

Displaying the Settings Screen.	40
From the Start button.	40
Displaying Help.	41
Click the Help Button to Display.	41
Right-click on the item you want to check.	41
Customizing the Printer Driver.	42
Saving various settings as your Select Settings	42
Saving media settings.	42
Rearranging display items.	43
Summary of the Utility Tab.	44
Uninstalling the printer driver.	46

Using the Printer Driver(Mac OS X)

Displaying the Settings Screen.	47
Displaying Help.	47
Using Epson Printer Utility 4.	47
Starting Epson Printer Utility 4.	47
Epson Printer Utility 4 Functions.	47
Uninstalling the printer driver.	49

Printing Varieties

Auto Correct Color and Print Photos (PhotoEnhance).	50
Correct color and print.	52
Printing Black and White Photos.	55
Borderless printing.	58
Types of Borderless Printing Methods.	58
Supported Media Sizes for Borderless Printing	59
Setting Procedures for Printing.	60

Contents

Enlarged/Reduced Printing. 63
 Fit to Page/Scale to fit paper size. 63
 Fit to Roll Paper Width(Windows only). 64
 Custom Scale Setting. 65
 Multi-Page Printing. 66
 Manual Double-Sided Printing(Windows only)
 68
 Cautions when Performing Double-Sided
 Printing. 68
 Setting Procedures for Printing. 68
 Poster Printing (Enlarge to cover several sheets
 and print - Windows only). 69
 Setting Procedures for Printing. 69
 Joining the output paper together. 71
 User-defined Paper Sizes/Custom Paper Sizes. 73
 Banner printing (on roll paper). 75
 Layout Manager(Windows only). 77
 Setting Procedures for Printing. 78
 Saving and Calling Layout Manager Settings. 79
 Printing from a Smart Device. 80
 Using Epson iPrint. 80
 Using AirPrint. 81

Color Management Printing

About Color Management. 82
 Color Management Print Settings. 82
 Setting profiles. 83
 Setting color management with the applications
 83
 Setting color management with the printer driver
 84
 Color management printing by Host ICM
 (Windows). 84
 Color management printing by ColorSync
 (Mac OS X). 85
 Color management printing by Driver
 ICM(Windows only). 86

Using the Control Panel

Menus. 88
 Using the Menu. 88
 Setting Items for the Network Summary
 Display. 89
 Setting Items for the Setup Menu. 89

Maintenance

Adjusting the Print Head. 94

Checking for clogged nozzles. 94
 Head Cleaning. 95
 Correcting Print Misalignment (Print Head
 Alignment). 95
 Replacing Ink Cartridges. 97
 Ink Cartridge Product Numbers. 97
 How to replace. 97
 Cleaning Inside the Printer. 99

Problem Solver

Messages. 100
 Troubleshooting. 101
 You cannot print (because the printer does not
 work). 101
 The printer sounds like it is printing, but
 nothing prints. 102
 Print Quality/Print Results. 103
 Unable to feed or eject paper.. 105
 Paper from the Auto Sheet Feeder Jams During
 Printing. 106
 Jammed Fine Art Media. 107
 Jammed Poster Board. 108
 Roll paper jam. 109
 The CD/DVD Tray is jammed. 110
 Others. 110

Appendix

Supported Media. 111
 Item descriptions. 111
 Epson Special Media Table. 111
 Usable Commercially Papers. 113
 Transporting the Printer. 115
 Preparing the Printer for Transport. 115
 After Transport. 116
 Specifications Table. 117
 Standards and Approvals. 118

Where To Get Help

Technical Support Web Site. 120
 Contacting Epson Support. 120
 Before Contacting Epson. 120
 Help for Users in North America. 121
 Help for Users in Europe. 121
 Help for Users in Taiwan. 121
 Help for Users in Australia. 122
 Help for Users in Singapore. 122
 Help for Users in Thailand. 123
 Help for Users in Vietnam. 123

Contents

Help for Users in Indonesia.	123
Help for Users in Hong Kong.	124
Help for Users in Malaysia.	124
Help for Users in India.	124
Help for Users in the Philippines.	125

Introduction

Important Safety Instructions

Read all of these instructions before using the printer. Also be sure to follow all warnings and instructions marked on the printer.

When choosing a place for this product

- ❑ Place this product on a flat, stable surface that is larger than this product. This product will not operate properly if it is tilted or at an angle.
- ❑ Avoid places subject to rapid changes in temperature and humidity. Also keep it away from direct sunlight, strong light, or heat sources.
- ❑ Avoid places subject to shocks and vibrations.
- ❑ Keep this product away from dusty areas.
- ❑ Place this product near a wall outlet where the plug can be easily unplugged.
- ❑ When storing or transporting the printer, do not tilt it, stand it on its side, or turn it upside down. Otherwise, ink may leak from the cartridges.

When setting up this product

- ❑ Do not block or cover the openings in this product's cabinet.
- ❑ Do not insert objects through the slots. Take care not to spill liquid on this product.
- ❑ This product's power cord is for use with this product only. Use with other equipment may result in fire or electric shock.
- ❑ Connect all equipment to properly grounded power outlets. Avoid using outlets on the same circuit as copiers or air control systems that regularly switch on and off.

- ❑ Avoid electrical outlets controlled by wall switches or automatic timers.
- ❑ Keep the entire computer system away from potential sources of electromagnetic interference, such as loudspeakers or the base units of cordless telephones.
- ❑ Use only the type of power source indicated on the product's label.
- ❑ Use only the power cord that comes with this product. Use of another cord may result in fire or electric shock.
- ❑ Do not use a damaged or frayed power cord.
- ❑ If you use an extension cord with this product, make sure the total ampere rating of the devices plugged into the extension cord does not exceed the cord's ampere rating. Also, make sure the total ampere rating of all devices plugged into the wall outlet does not exceed the wall outlet's ampere rating.
- ❑ Do not attempt to service this product yourself.
- ❑ Unplug this product and refer servicing to qualified service personnel under the following conditions:

The power cord or plug is damaged; liquid has entered the product; the product has been dropped or the cabinet damaged; the product does not operate normally or exhibits a distinct change in performance.
- ❑ If you plan to use the printer in Germany, observe the following:

To provide adequate short-circuit protection and over-current protection for this printer, the building installation must be protected by a 10 or 16 amp circuit breaker.
- ❑ If damage occurs to the plug, replace the cord set or consult a qualified electrician. If there are fuses in the plug, make sure you replace them with fuses of the correct size and rating.
- ❑ When connecting the printer to a computer or other device with a cable, ensure the correct orientation of the connectors. Each connector has only one correct orientation. Inserting a connector in the wrong orientation may damage both devices connected by the cable.

Introduction

When using this product

- ❑ Do not put your hand inside this product or touch the ink cartridges during printing.
- ❑ Do not move the print heads by hand; otherwise you may damage this product.
- ❑ Always turn the product off using the Power button on the control panel. When this button is pressed, the Power light flashes briefly then goes off. Do not unplug the power cord or turn off the product until the Power light stops flashing.

Using the printer with a wireless connection

- ❑ Do not use this product inside medical facilities or near medical equipment. Radio waves from this product may adversely affect the operation of electrical medical equipment.
- ❑ Keep this product at least 22 cm away from cardiac pacemakers. Radio waves from this product may adversely affect the operation of cardiac pacemakers.
- ❑ Do not use this product near automatically controlled devices such as automatic doors or fire alarms. Radio waves from this product may adversely affect these devices, and could lead to accidents due to malfunction.

When handling the ink cartridges

- ❑ Keep ink cartridges out of the reach of children and do not drink.
- ❑ If ink gets on your skin, wash it off with soap and water. If it gets in your eyes, flush them immediately with water. If discomfort or vision problems remain after a thorough flushing, see a doctor immediately.
- ❑ Shake new ink cartridges four or five times before opening their packages.
- ❑ Do not shake ink cartridges after opening their packages; this can cause leakage.

- ❑ Use the ink cartridge before the date printed on its package.
- ❑ Use up the ink cartridge within six months of opening the package for best results.
- ❑ Do not dismantle the ink cartridges or try to refill them. This could damage the print head.
- ❑ Do not touch the IC chip on the side of the cartridge. This may affect normal operation and printing.
- ❑ The IC chip on this ink cartridge retains a variety of cartridge-related information, such as the ink cartridge status, so that the cartridge may be removed and reinserted freely. However, each time the cartridge is inserted, some ink is consumed because the printer automatically performs a reliability check.
- ❑ If you remove an ink cartridge for later use, protect the ink supply area from dirt and dust, and store it in the same environment as this product. Note that there is a valve in the ink supply port, making covers or plugs unnecessary, but care is needed to prevent the ink from staining items that the cartridge touches. Do not touch the ink supply port or surrounding area.
- ❑ Do not remove or tear the label on the cartridge; this can cause leakage.
- ❑ Install the ink cartridge immediately after you remove it from its package. If you leave a cartridge unpacked for a long time before using it, normal printing may not be possible.
- ❑ Store ink cartridges with their labels facing upward. Do not store cartridges upside down.



Using the LCD screen (Touch panel)

- ❑ The LCD screen may contain a few small bright or dark spots, and because of its features it may have an uneven brightness. These are normal and do not indicate that it is damaged in any way.
- ❑ Only use a dry, soft cloth to clean the LCD screen. Do not use liquid or chemical cleansers.

Introduction

- ❑ If the liquid crystal solution gets on your hands, wash them thoroughly with soap and water. If the liquid crystal solution gets into your eyes, flush them immediately with water. If discomfort or vision problems remain after a thorough flushing, see a doctor immediately.
- ❑ The exterior cover of the LCD screen could break if it receives a heavy impact. Contact your dealer if the panel surface chips or cracks, and do not touch or attempt to remove the broken pieces.
- ❑ Press the LCD screen gently with your finger. Do not press force or operate with your nails.
- ❑ Do not operate by a sharp edge thing such as a ball point pen, sharp pencil, stylus pen and so on.
- ❑ Condensation inside the LCD screen due to abrupt changes in temperature or humidity may cause performance to deteriorate.

Meaning of Symbols

 <p><i>Warning</i></p>	<p>Warnings must be followed to avoid serious bodily injury.</p>
 <p><i>Caution</i></p>	<p>Cautions must be followed to avoid bodily injury.</p>
 <p><i>Important</i></p>	<p>Important must be followed to avoid damage to this product.</p>
<p><i>Note</i></p>	<p>Notes contain useful or additional information on the operation of this product.</p>

Printer Parts

Front section

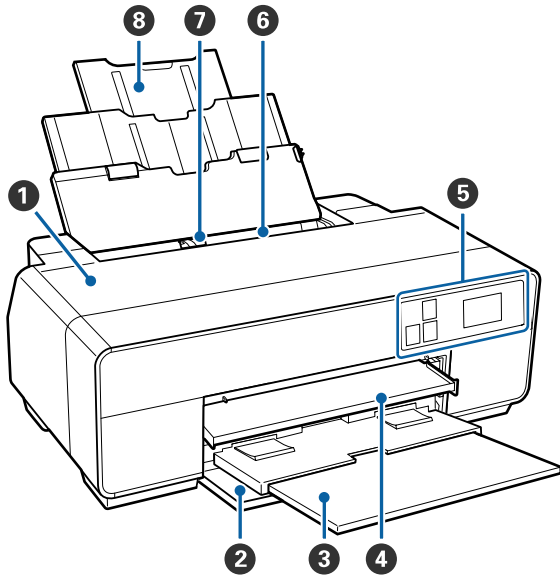

- 1 Printer cover**
Open when replacing ink cartridge, cleaning the inside of the printer, or removing jammed paper. The cover is normally closed when the printer is in use.
- 2 Front cover**
Open before pulling out the front manual feed tray or output trays.
- 3 Output tray**
Ejected paper is collected here. Extend the tray when using the printer.
- 4 Front manual feed tray**
Press the center of the tray and pull it out to load fine art media, poster board, or the CD/DVD tray.
- 5 Control panel**
👉 [“Control panel” on page 11](#)
- 6 Auto sheet feeder**
Automatically feeds paper.
- 7 Edge guide**
Move left and right depending on the size of the paper that you want to load. This prevents paper being fed at a slant.

- 8 Paper support**
Supports paper to prevent it from falling forward or backward.

Introduction

Inside

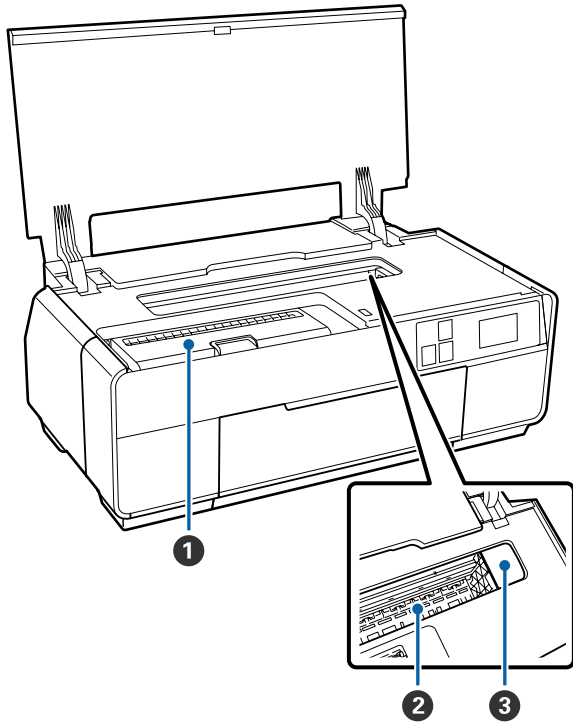

- 1 Cartridge cover**
Open when replacing ink cartridges.

 [“Replacing Ink Cartridges” on page 97](#)
- 2 Ink absorber**
Absorbs ink that bleeds past the edge of the paper during borderless printing.
- 3 Print head**
Fires ink via high density nozzles while moving left and right to print. Do not move the print head by hand.

Back

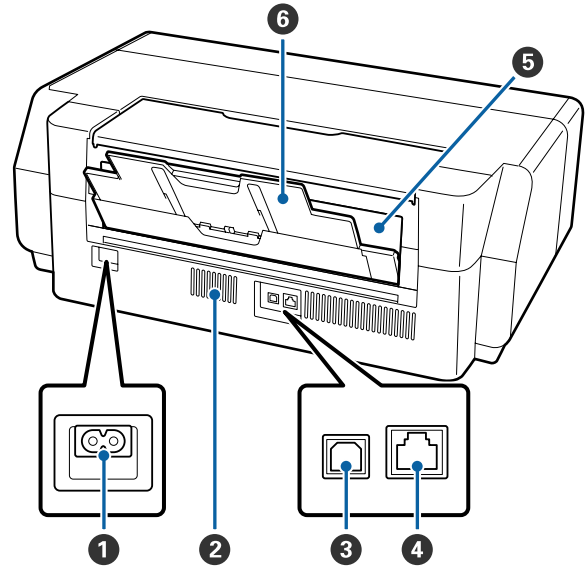

- 1 AC inlet**
Connects the supplied power cable.
- 2 Airflow vents**
Exhausts internal air. Do not cover the vents.
- 3 USB port**
Connects the USB cable.
- 4 LAN port**
Connects the LAN cable.
- 5 Roll paper feeder**
Paper feed slot for roll paper printing.

 [“Loading Roll Paper” on page 27](#)
- 6 Rear support**
Open to use when loading fine art media or roll paper.

 [“Loading Fine Art Media” on page 23](#)

 [“Loading Roll Paper” on page 27](#)

Introduction

Control panel

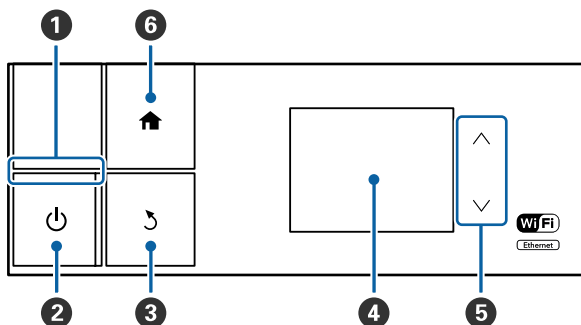

1 **light (power light)**

On : The power is on.

Off : The power is off.

2 **button (power button)**

Turns the power on and off.

3 **button (back button)**

Press to return to the previous screen while the Menu is displayed.

4 **Screen**

Displays the printer's status, menus, error messages, and so on. [“Home Screen View” on page 12](#)

5 **and** **buttons**

Press to select menu items and setting values when a menu is displayed.

6 **button**

Display the home screen.

[“Home Screen View” on page 12](#)

Note:

You can change the angle of the control panel.

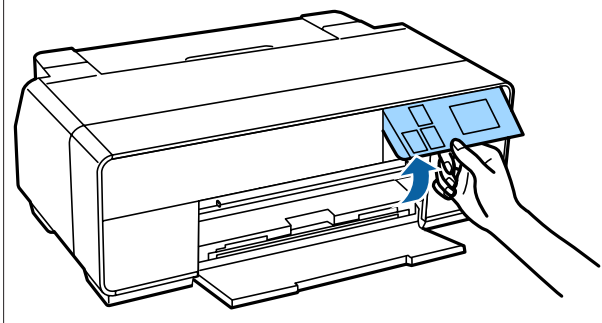

Introduction

Home Screen View

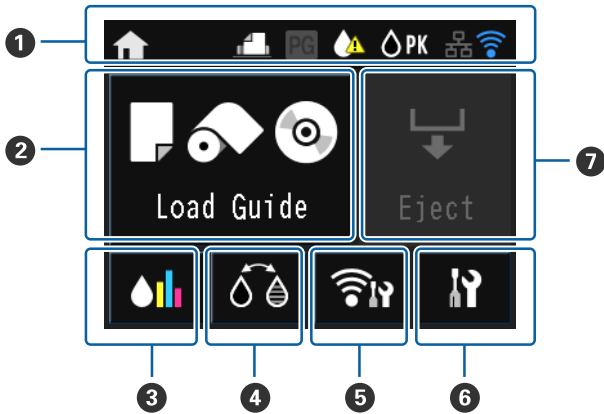

1 The icons indicate the status. Check the meaning of icons in the following table.

	Photo Black ink is selected.
	Matte Black ink is selected.
	The amount of remaining ink is nearing the limit.
	Displays the status of the wired LAN. This is on when connected.
	Indicates that a wireless LAN or wired LAN connection has been established.
 Or 	Displays the connection and radio wave status for the wireless LAN. The more lines that are lit, the stronger the signal status. When all of the lines are off, the wireless LAN is disconnected. When only is on, wireless LAN is searching or cannot be used.
	Connection is established in ad hoc mode.

	Connection is established in Wi-Fi Direct mode.
	Connection is established in AP mode.
	Auto Sheet Feeder is selected in Load Guide .
	Fine Art Media is selected in Load Guide .
	Poster Board is selected in Load Guide .
	CD/DVD is selected in Load Guide .
	Roll Paper is selected in Load Guide .
	Turns on when Thick Paper is set to On .

Press the 2 to 7 icons to display menus such as Settings and Checking

- 2 **Load Guide/Media Setup button**
Load Guide is displayed when paper is not loaded. You can continue by checking the selected **Load Guide** procedure on the screen.

Media Setup is displayed when paper is loaded. You can set the Media Size and Media Type.
- 3 **Ink remaining display button**
 Displays the approximate level of remaining ink and the current status.
 The icon for the ink cartridges changes as shown below.

Introduction



: No error. The level of the indicator changes depending on the amount of ink remaining in the cartridge.



: Ink is low. You need to prepare a new ink cartridge. We recommend replacing the ink cartridge as soon as possible because the ink may be expended while printing.

Note:

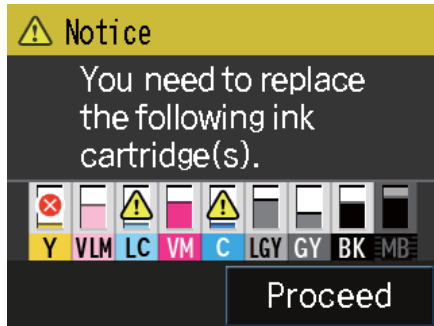

During printing, ink replacement, or when an ink cartridge error has occurred, the level and status of the ink remaining is displayed.

As well as the above, the following icons are displayed.



: The amount of ink remaining is below the limit or an error has occurred. Check the message on the screen, and clear the error.

Ink color codes

Y : Yellow

VLM : Vivid Light Magenta

LC : Light Cyan

VM : Vivid Magenta

C : Cyan

LLK : Light Light Black

LK : Light Black

PK : Photo Black

MK : Matte Black

4 BK Ink Change button

You can change from one type of black ink to another.

[“Changing the Type of Black Ink” on page 35](#)

[“Supported Media” on page 111](#)

5 Network Summary Display button

Displays the status of the printer's connection to the computer. You can also display **Wi-Fi/Network Settings** and so on directly from the **Menu**.

[“Setting Items for the Network Summary Display” on page 89](#)

6 (setup) button

You can perform printer maintenance and adjust printer settings.

[“Menus” on page 88](#)

7 Cut/Eject button

Introduction

You can eject paper that has been loaded.

The following can be performed when roll paper is loaded.

- Move roll paper to the cutting position
- Eject paper after moving the roll paper to the cutting position
- Eject roll paper

Printer Features

This ink jet color printer supports A3+ paper.

The main features of this printer are described below.

Realizing High Resolution

The newly developed Epson UltraChrome HD ink technology provides high definition for professional needs.

Maximum black density

The new ink technology realizes maximum black density (Dmax) which is higher than previous products.

Printing Black and White Photos

Three different densities of black ink bring out delicate tone differences in black-and-white photographs.

The printer driver can be used to create richly shaded black-and-white prints directly from color image data without the use of imaging software.

 [“Printing Black and White Photos” on page 55](#)

Providing two types of black ink to match the paper type

You can choose from Photo Black or Matte Black ink depending on the paper type. Photo Black ink provides a smooth finish to glossy photo papers. Matte Black ink increases black optical density for matte type papers.

This printer allows you to set both photo black ink and matte black ink and switch between them depending on the paper type.

 [“Changing the Type of Black Ink” on page 35](#)

Balanced Color Reproduction Using the Epson LUT Technology

Epson LUT Technology realizes the following conditions while ensuring an excellent balance among all these parameters. This makes possible an overall increase in image quality and consistent color reproduction.

1. Reduces color inconsistencies due to differences in lighting
2. Reproduces fine gradations
3. Reduces graininess

Introduction

4. Increases the gamut for rich color reproduction

5760 × 1440 dpi Maximum Resolution, 2 pl Minimum Ink Dot Size for a precise output

Print beautiful photographs with little graininess.

Long life prints

Pigment inks maintain more beautiful and more vibrant prints over a long period of time since their high water and ozone resistance and high light fastness prevent the inks from being broken down by light and ozone in the air.

Realizing High Productivity

Excellent color stability leads to efficient printing

The color stabilizes in a short time so it can safely be used for pre-press workflow and color editing, increasing work efficiency.

Superior Ease of Use

Adopted a touch panel interface that offers improved operability with an easy-to-see-and-use color screen

The large, bright LCD display provides an intuitive, easy to operate screen design.

The highly legible color screen makes error messages and other information easier to understand. It also provides instructions on loading media such as fine art media.

 [“Home Screen View” on page 12](#)

Equipped for Wireless LANs

The wireless LAN feature that comes standard with the printer allows wireless printing from computers and compatible Wi-Fi devices.

By using a Wi-Fi Direct connection, you can wirelessly connect the printer directly to a computer or a smart device without using an access point.

Note:

You may find print speeds to be insufficient on some wireless networks or when printing at A3 or other extremely large sizes. A physical connection is recommended when consistent print speeds are required.

Printing from a smart device

By using AirPrint or Google cloud print, you can print from iOS or Android smart devices.

Borderless printing function

You can print with no margins for all directions with both auto expand or retain size print settings.  [“Borderless printing” on page 58](#)

Also included is a poster printing function that allows you to join the output paper together when performing borderless printing in order to create large posters and calendars.  [“Poster Printing \(Enlarge to cover several sheets and print - Windows only\)” on page 69](#)

Freely placing print data made by various applications using Layout Manager

This function allows you to place multiple print data made by different applications freely on one sheet to create posters and display articles.

 [“Layout Manager\(Windows only\)” on page 77](#)

Saving energy using Sleep Mode and Power Off Timer

When no print jobs are being handled, or when no operation has been performed for some time, the printer enters sleep mode to reduce power consumption.

Furthermore, if the Power Off Timer function is enabled, the printer can automatically switch off to avoid wasting electricity. This function works if no print jobs are received and no operations are carried out on the control panel while the printer is not in an error status for a specified duration of time.

 [“Energy Saving Settings” on page 37](#)

Support for a Wide Variety of Paper Types

EPSON offers a wide variety of special media for high-quality printing. The printer can also print on poster board, roll paper, and inkjet-compatible CDs and DVDs.

Loading paper automatically displays the setup screen for media type and media size. You can set this display to **On/Off** from **Paper Setup Display** in the Setup menu.

 [“Setting Items for the Setup Menu” on page 89](#)

These paper types can be loaded as described below.

Introduction

❑ Cut sheet

Cut sheets are fed into the printer from the auto sheet feeder.

 [“Loading Paper into the Auto Sheet Feeder” on page 22](#)

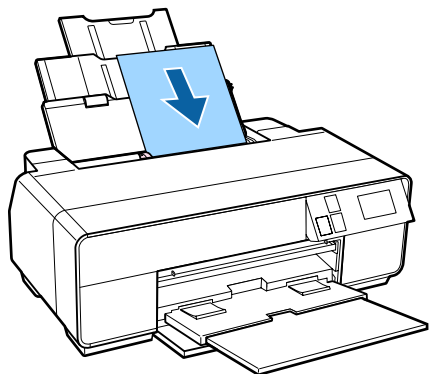

❑ Fine art media

Extend the rear support and load paper from the front manual feed tray.

 [“Loading Fine Art Media” on page 23](#)

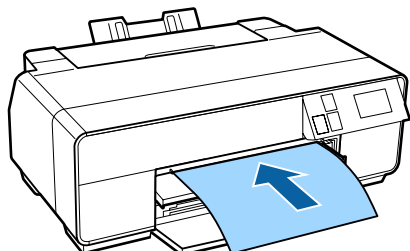

❑ Poster board

Load from the front manual feed tray.

 [“Loading Poster Board” on page 25](#)

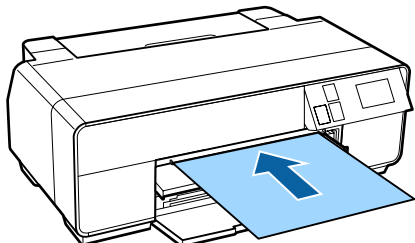

❑ Roll paper

Install the roll paper holder on the back of the printer.

 [“Loading and Removing Roll Paper” on page 27](#)

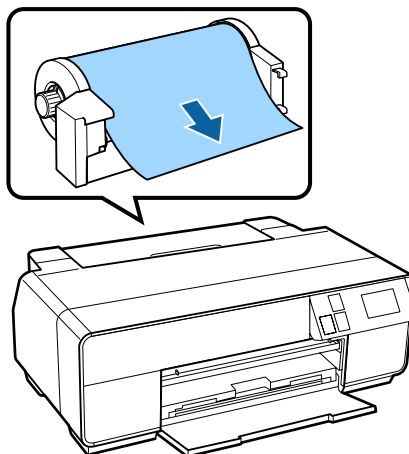

❑ CD/DVD

Use the CD/DVD tray to load CDs and DVDs from the front manual feed tray.

 [“Loading and Removing CDs and DVDs” on page 29](#)

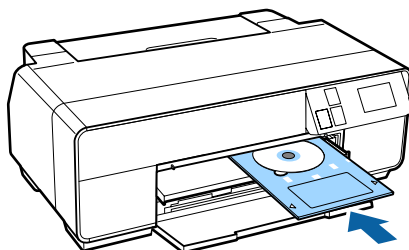

Notes on Usage and Storage

Installation space

Make sure that you secure the following space, clear of any other objects, so that paper ejection and consumable replacement are not obstructed.

See the “Specifications Table” for the external dimensions of the printer.

 “Specifications Table” on page 117

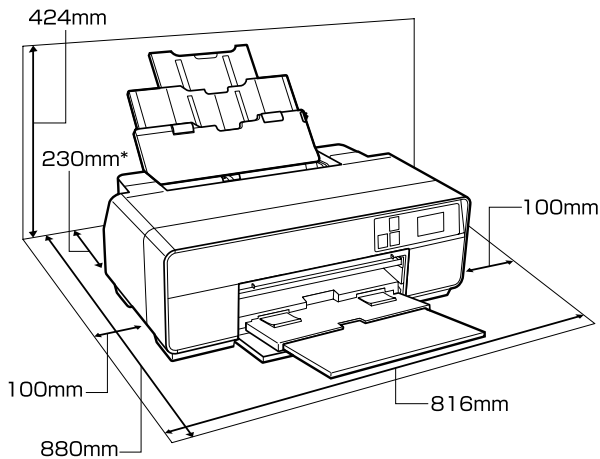

* When printing on poster board, leave a space of at least 320 mm in behind the printer.

Notes when using the printer

Note the following points when using this printer to avoid breakdowns, malfunctions, and print quality decline.

- ❑ When using the printer, observe the operating temperature and humidity range described in the “Specifications Table”.

Even when the conditions above are met, you may not be able to print properly if the environmental conditions are not suitable for the paper. Be sure to use the printer in an environment where the paper's

requirements are met. For more details, see the manual supplied with the paper.

Also, when operating in dry areas, air conditioned environment, or under direct sunlight, maintain the appropriate humidity.

- ❑ Avoid locations in direct contact with air from air conditioners and locations with heat sources. This could dry the nozzles in the print head and cause clogging.
- ❑ Capping may not occur (the print head is not positioned on the right-hand side) if the printer is turned off during a paper jam or when an error occurs. Capping is a function for automatically covering the print head with a cap (lid) to prevent the print head from drying out. In this case, turn on the power and wait a while until capping is performed automatically.
- ❑ When the power is on, do not remove the power plug or cut the power at the breaker. The print head may not be capped properly. In this case, turn on the power and wait a while until capping is performed automatically.

Notes when not using the printer

If you are not using it, note the following points when storing the printer. If it is not stored correctly, you may not be able to print properly the next time it is used.

- ❑ When storing the printer leave the ink cartridges installed and keep the printer level. Do not tilt or invert the printer or stand it on end.
- ❑ If you do not print for a long time, the print head nozzles may become clogged. We recommend that you use the printer periodically to prevent the print head from clogging.
- ❑ If the paper is left in the printer, the roller of the paper presser may leave a mark on the surface of the paper. This can also cause wavy or curled paper resulting in paper feeding problems or the print head could be scratched. Remove any paper when storing.

Introduction

- ❑ Store the printer after confirming that the print head has been capped (the print head is positioned at the far right). If the print head is left uncapped for a long time, the print quality may decline.

Note:

If the print head is not capped, turn the printer on, and then turn it off.

- ❑ Make sure covers are kept closed to avoid dust getting in. If you are not using the printer for a long time, put an anti-static cloth or cover on the printer to prevent dust. The print head nozzles are very small, and they can become clogged easily if fine dust gets on the print head, and you may not be able to print properly.
- ❑ If you have not used the printer for a long time, check the print head for clogging before you start printing. Perform head cleaning if the print head is clogged.

 [“Checking for clogged nozzles” on page 94](#)

Notes on handling ink cartridges

Note the following points when handling ink cartridges to maintain good print quality.

- ❑ As part of the initial ink charging process performed after purchase, some ink is used to fill the print head nozzles to the tips and ready them for printing. As a result, the first ink cartridges installed after purchase will print fewer pages than subsequent cartridges.
- ❑ We recommend storing ink cartridges in a cool, dark place, and using them before the expiry date on the package. Use cartridges within six months of opening.
- ❑ Do not open the bag containing the ink cartridge until you are ready to install it in the printer. Ink cartridges are vacuum packed to maintain quality.
- ❑ If you move ink cartridges from a cold place to a warm place, leave it at room temperature for more than three hours before using the ink cartridge.

- ❑ Make sure you remove the yellow tape before installing. If you install without removing the tape, you may not be able to print properly. Do not remove any other film or labels. Otherwise, ink could leak.

- ❑ Do not touch the IC chip in the ink cartridge. You may not be able to print properly.

 [“Replacing Ink Cartridges” on page 97](#)

- ❑ When loading ink cartridges, be sure all colors are installed. The printer can only be used when all colors are installed.
- ❑ Do not move the print head by hand; otherwise, the printer may be damaged.
- ❑ Do not leave the printer without ink cartridges installed. If the print head (nozzles) dries, you may not be able to print.
- ❑ Because the green IC chip contains the cartridge's own information such as the remaining ink level, you can still reinstall and use the ink cartridge after removing it from the printer. Note, however, that you may not be able to reuse ink cartridges that contained very little ink when they were removed from the printer. Some ink may also be used to ensure reliable operation when the cartridges are reinserted.
- ❑ Cartridges that still contain ink should be stored under the same conditions as the printer, with the nozzles down or to the side to prevent them becoming clogged with dust. Note that the ink supply port has a valve in it so it does not need to be capped.
- ❑ Removed ink cartridges may have ink around the ink supply port, so be careful not to get any ink on the surrounding area.
- ❑ To maintain the quality of the print head, this printer stops printing before ink cartridges are completely expended.
- ❑ Although the ink cartridges may contain recycled materials, this does not effect printer function or performance.
- ❑ Do not dismantle or remodel ink cartridges. You may not be able to print properly.

Introduction

- ❑ All colors of ink are used during head cleaning and other non-printing maintenance operations to ensure that the print heads remain in good condition.
- ❑ Depending on the paper type and print quality settings, colored inks may also be used for high-density blacks in monochrome or grayscale printing.
- ❑ You cannot use the cartridges that came with the printer for replacement.

Notes on handling paper

Note the following points when handling and storing the paper. If the paper is not in good condition, print quality may decline.

Check the manuals supplied with each paper.

Notes on Handling

- ❑ Use Epson special media under normal room conditions (temperature: 15 to 25°C; humidity: 40 to 60%).
- ❑ Do not fold the paper or scratch the surface of the paper.
- ❑ Avoid touching the printable surface of the paper with your bare hands. Moisture and oils from your hands can affect print quality.
- ❑ Paper may be wavy or slack if the temperature and humidity change. Be careful not to scratch or soil the paper, and flatten it before loading it in the printer.
- ❑ Do not wet the paper.
- ❑ Do not throw away the paper packaging as you can use it for storing the paper.
- ❑ Avoid locations that are subject to direct sunlight, excessive heat, or humidity.
- ❑ Keep paper in their original package after opening, and keep them in a flat place.

Notes on handling printed paper

To maintain long lasting, high quality print results, note the following points.

- ❑ Do not rub or scratch the printed surface. If they are rubbed or scratched, the ink may peel off.
- ❑ Do not touch the printed surface; otherwise, the ink may peel off.
- ❑ Make sure the print outs are completely dry before folding or stacking; otherwise, the color may change where they touch (leaves a mark). These marks will disappear if they are separated immediately and dried; however, they will remain if not separated.
- ❑ If you put the print outs in an album before they are completely dry, they may be blurred.
- ❑ Do not use a dryer to dry the print outs.
- ❑ Avoid direct sunlight.
- ❑ Prevent color distortion while displaying or storing the print outs by following the instructions in the paper's manual.
- ❑ To keep your printouts from discoloring, store them in a dark place, away from high temperatures, high humidity, and direct sunlight.

Note:

Typically, print outs and photos fade over time (color distortion) due to the effects of light and various constituents in the air. This also applies to Epson special media. However, with the correct storage method, the degree of color distortion can be minimized.

- ❑ *See the manuals supplied with Epson special media for detailed information on handling the paper after printing.*
- ❑ *The colors of photos, posters, and other printed materials appear different under different lighting conditions (light sources^{*}). The colors of print outs from this printer may also appear different under different light sources.*

** Light sources include sunlight, fluorescent light, incandescent light, and other types.*

Introduction

Introducing the Supplied Software

Contents of the Software Disc

The following Windows only software can be found on the supplied software disc.

See <http://epson.sn> for Mac OS X or if you do not have a disk drive.

You need to install the printer driver to use this printer.

For details on each software see *Network Guide* (PDF) or the online help.

Software Name	Summary
Printer Driver	 "Summary of the Printer Driver" on page 21
Easy Photo Print	Print selected photos quickly and easily. See the application's on-line help for more information.
Epson Print CD	With this software, you can design labels for music, photo, or movie CDs and DVDs and print them directly on the discs. You can also design and print CD and DVD jackets. See the application's on-line help for more information.
EpsonNet Setup	With this software, you can configure various network settings for the printer from your computer.
EpsonNet Print	With this software, you can perform direct TCP/IP printing when the computer and the printer are connected via a network.
EpsonNet Config	With this software, you can configure various network settings for the printer from your computer. This is useful as it allows you to enter the address and name using the keyboard.
EPSON Software Updater	This software connects to the Internet and checks if there are any updates available and installs them.
Adobe ICC profiles	Use as input profiles when required for color management.

Introduction

Summary of the Printer Driver

The main functions of the printer driver are described below.

- ❑ Converts print data received from applications into printable data and sends it to the printer.
- ❑ Allows the user to specify print settings such as the media type and paper size.

Windows

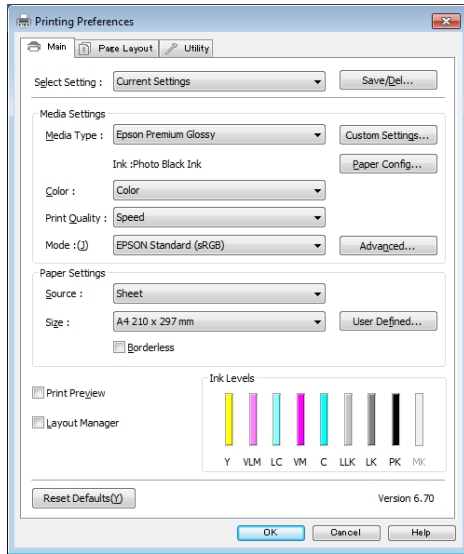

You can save these settings and easily import or export these saved settings.

[“Customizing the Printer Driver” on page 42](#)

Mac OS X

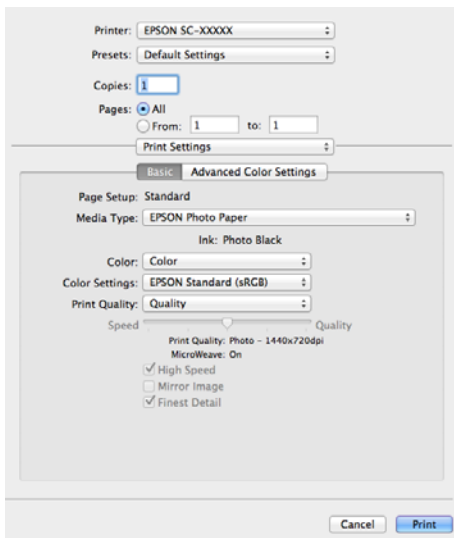

- ❑ Allows the user to execute printer maintenance functions to maintain print quality, and check the printer's status and so on.

Windows

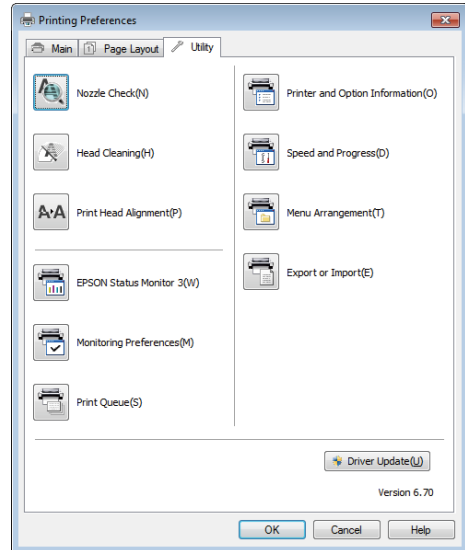

You can easily import or export printer driver settings.

[“Summary of the Utility Tab” on page 44](#)

Mac OS X

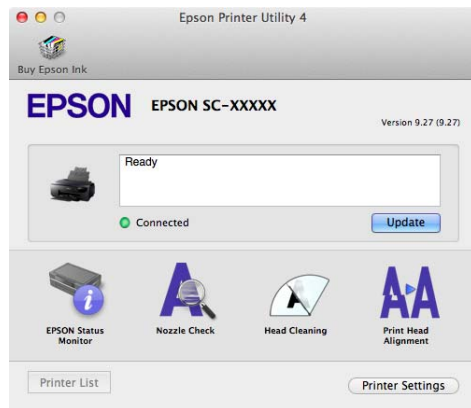

Basic Operations

Loading Cut Sheets

The method for feeding varies depending on the thickness of the paper as shown below.

In addition, available paper sizes vary depending on the feed method and the media type. For paper sizes, see [“Supported Media” on page 111](#).

Auto sheet feeder: 0.08 to 0.3 mm

Front manual feed (fine art media): 0.3 to 0.7 mm

Front manual feed (poster board): 0.7 to 1.3 mm

When **Paper Setup Display** is set to **On** and media is loaded, the setup screen for media type and media size is automatically displayed.

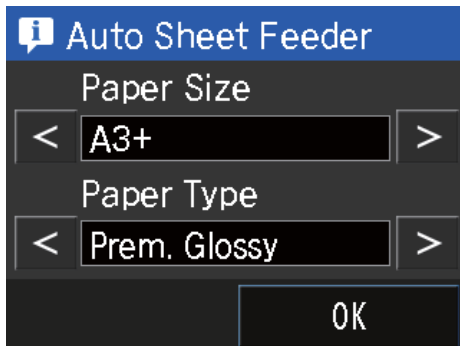

See [“Menus” on page 88](#) for the "Paper Setup Display" settings.



- ❑ *If the paper is wavy or curled, flatten the paper before loading it in the printer, or use new paper. If wavy or curled paper is loaded, this printer may not be able to recognize the paper size, feed the paper, or print correctly.*

We recommend that you return the paper to its original package and store it flat, and take it out of the package just before you use it.

- ❑ *To avoid paper jams, make sure you open the front cover and extend the output tray before printing.*

Loading Paper into the Auto Sheet Feeder

1

Turn on the printer.

Basic Operations

- 2** Open and fully extend the paper support.

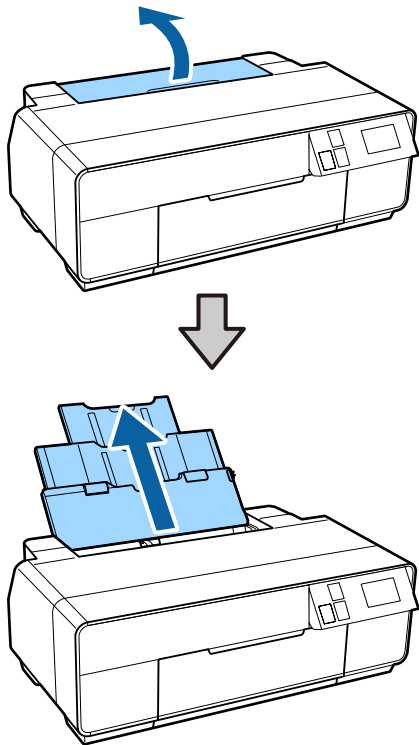

- 3** Open the front cover.

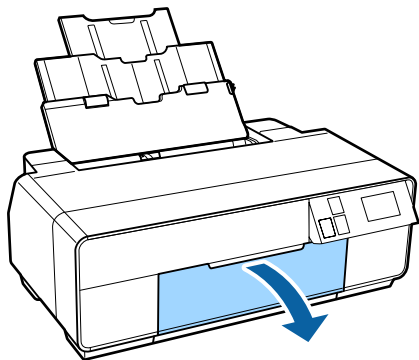

- 4** Fully extend the output tray.

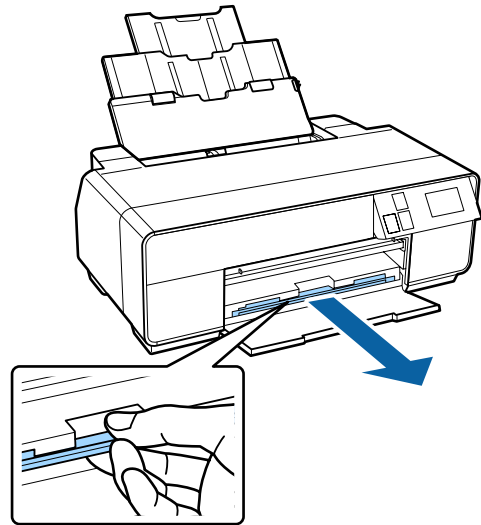

- 5** Load the paper vertically with the printable side face up.

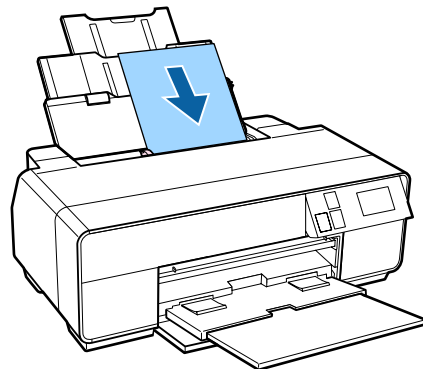

- 6** Grasp and slide the edge guide to fit it to the width of the paper.

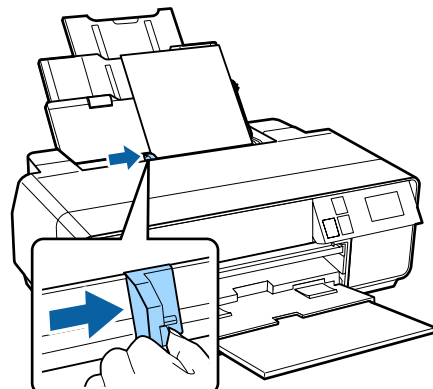

Loading Fine Art Media

Use the front manual feed tray and the rear support to load fine art media.

Basic Operations

You can load fine art media with a thickness of 0.3 to 0.7 mm.

1 Turn on the printer.

2 Open the rear support.

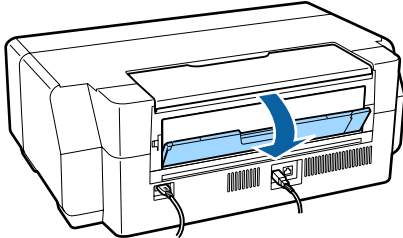

Note:

If the roll paper holder is currently in place at the rear of the printer, remove it before proceeding.

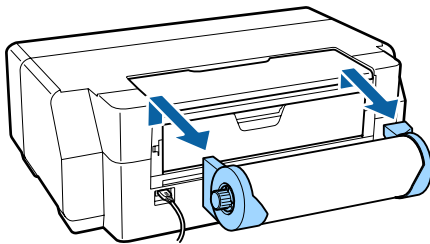

3 Fully extend the rear support.

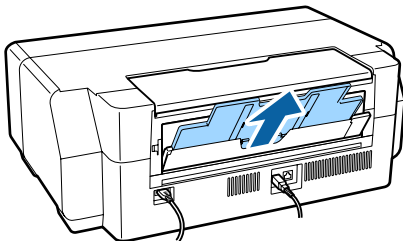

4 Open the front cover.

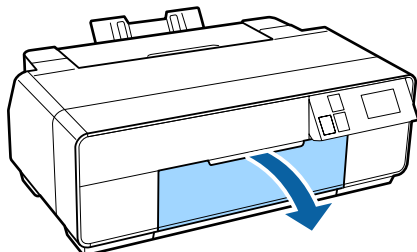

5 Push the center of the front manual feed tray.

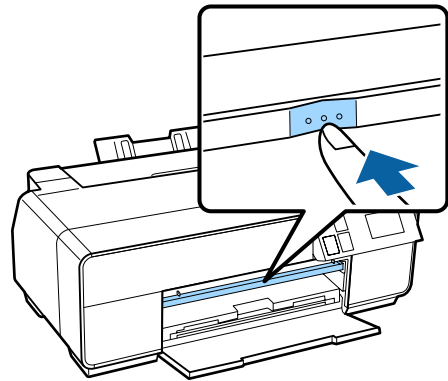

6 Load the paper vertically with the printable side face up.

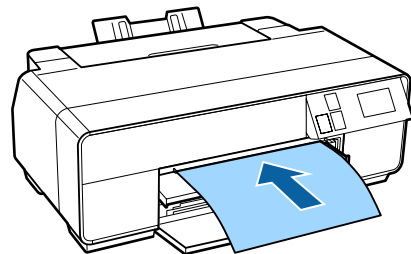

7 Align the right edge of the paper with the right edge of the tray and the trailing edge with the line on the tray.

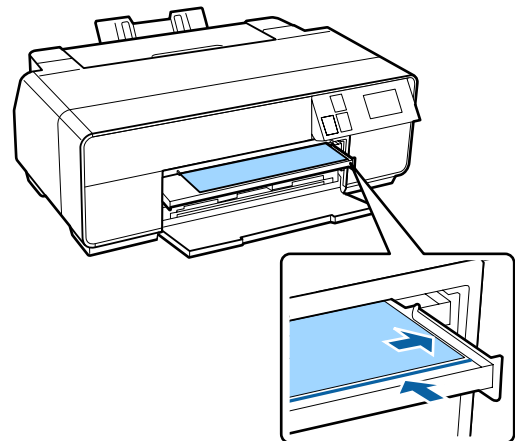

8 Press **Load** on the control panel screen.
The paper will be fed into the printer.

Basic Operations

9 Fully extend the output tray.

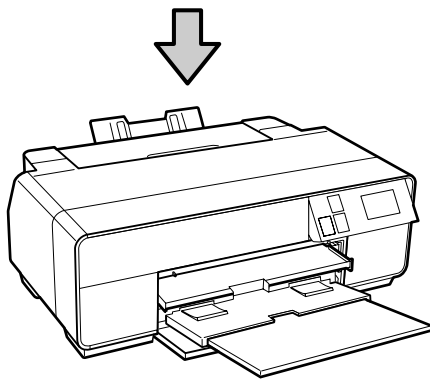
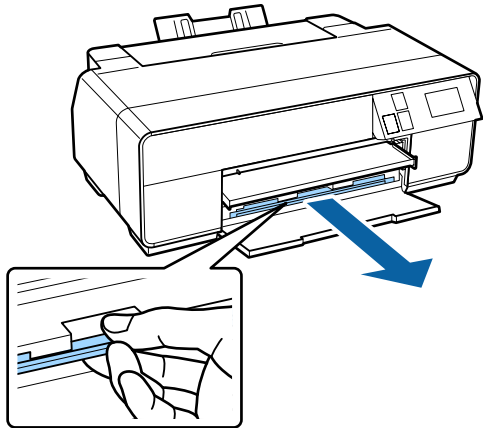

10 With the paper loaded and the printer idle, push the center of the front manual feed tray to close the tray.

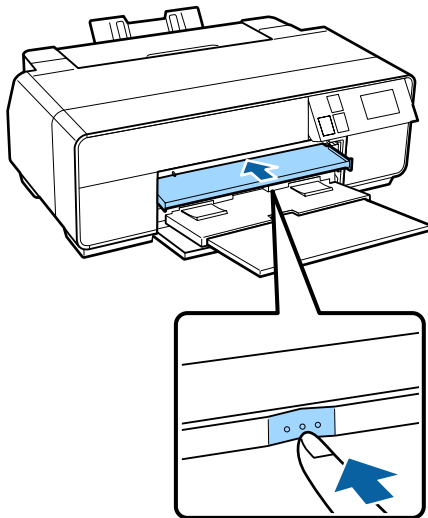

Note:
To eject the paper, press **Eject** on the control panel's Home screen, and then follow the on-screen instructions.

Loading Poster Board

Use the front manual feed tray to load poster board.

You can load poster board with a thickness of 0.7 to 1.3 mm.

Poster board sticks out from the rear of the printer when it is loaded. Leave a space of at least 320 mm between the rear of the printer and the nearest wall.

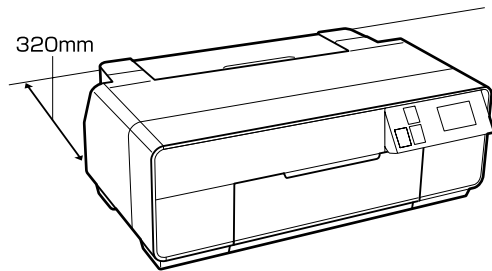

1 Turn on the printer.

! Important:
An error may occur if you perform the following operations during printing.

- Extend the front manual feed tray.
- Load poster board.

2 If the rear support is open, close it.

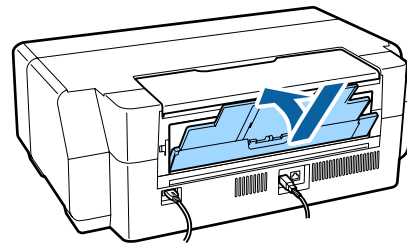

3 Open the front cover.

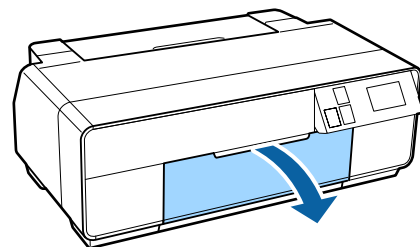

Basic Operations

- 4** Push the center of the front manual feed tray to pop it out.

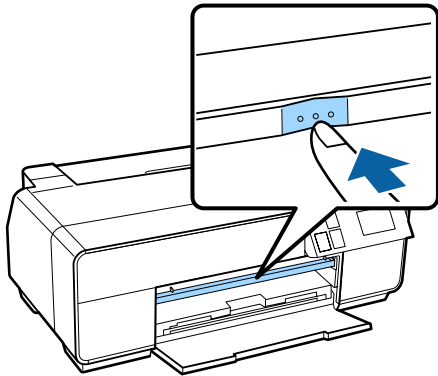

- 5** Load the paper vertically with the printable side face up.

! *Important:*
Inserting paper from the rear may cause a malfunction or error.

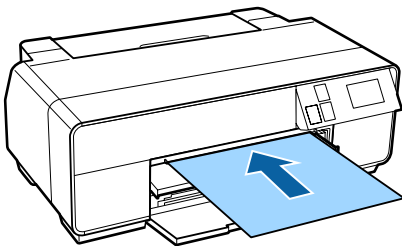

- 6** Align the right edge of the paper with the right edge of the tray and the trailing edge with the line on the tray.

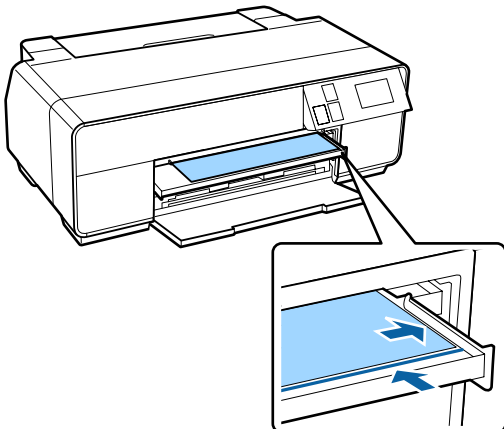

- 7** Press **Poster Board - Load** on the control panel's screen.

The paper will be fed into the printer.

- 8** Fully extend the output tray.

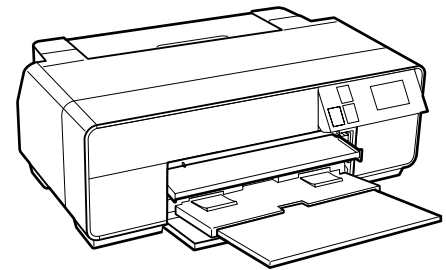
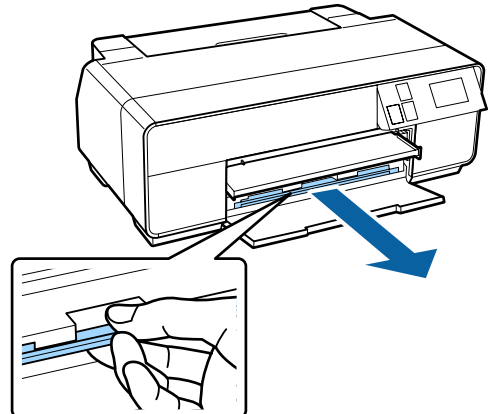

- 9** Once the paper is loaded, make sure that the printer is idle, and then push the center of the front manual feed tray to close it.

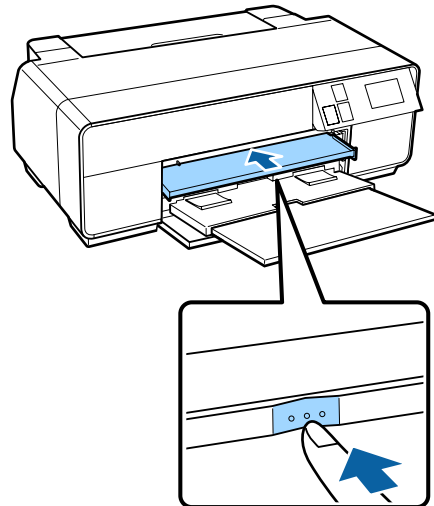

Note:
To eject the paper, press **Eject** on the control panel's Home screen, and then follow the on-screen instructions.

Loading and Removing Roll Paper

Loading Roll Paper

Use the roll paper holder supplied to load roll paper into the rear of the printer. See the following for information on supported roll paper types.

 "Supported Media" on page 111

1 Turn on the printer.

2 Open the front cover.

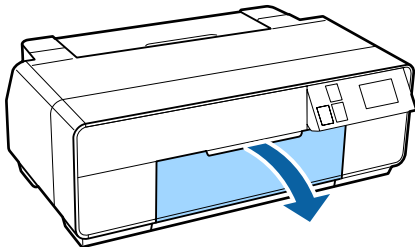

Note:
If the front manual feed tray is open, push the center of the tray to close it.

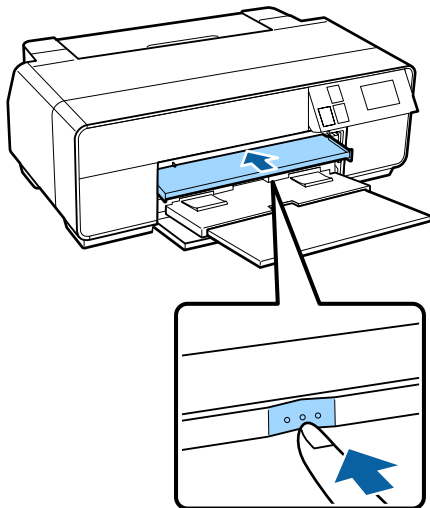

3 Fully extend the output tray.

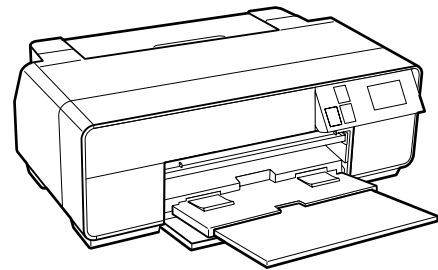
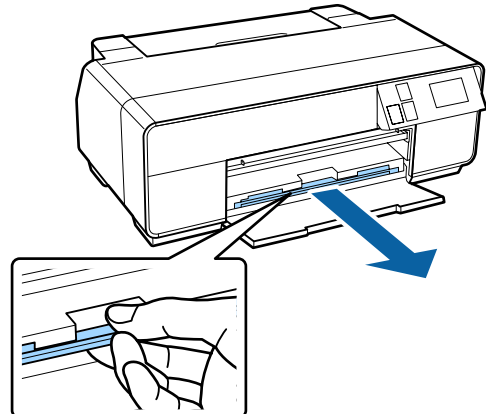

4 After confirming that the end of the roll paper is cut straight across, insert the roll paper holder into the ends of the roll.

If the end of the roll paper is not cut straight across, trim it straight before proceeding.

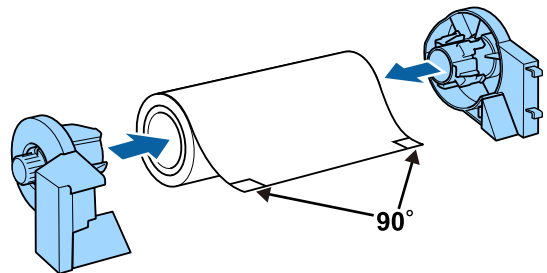

5 Open the rear support.

Only open the support; there is no need to extend it.

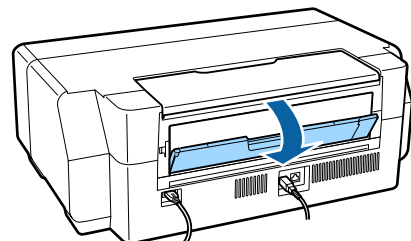

Basic Operations

- 6** Attach the roll paper holder to the rear of the printer.

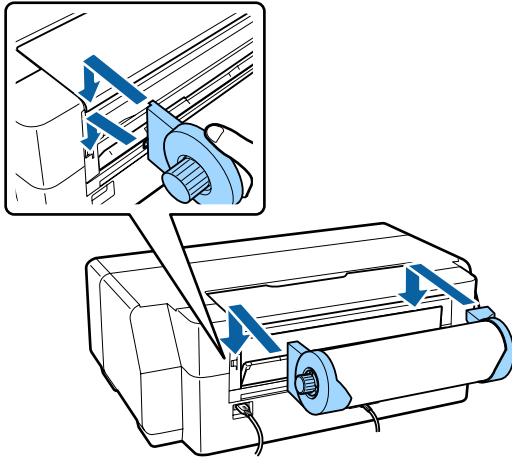

- 7** Feed the roll paper into the roll paper feeder on the rear of the printer until it stops.

After you have held the paper in place for about three seconds, it will be loaded the printer automatically.

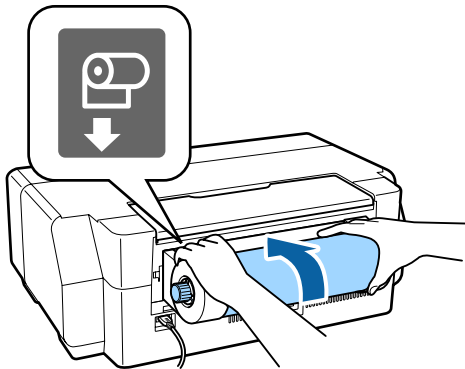

Note:

Open the printer cover and look down into the printer to check that the paper is not being fed at a slant.

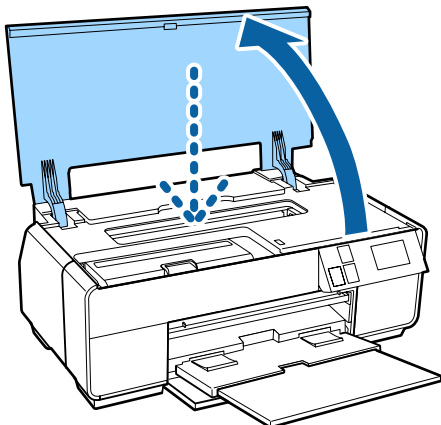

Cutting Roll Paper

Follow the steps below and use scissors and so on to cut the print results from the roll paper when printing is complete.

- 1** Select one of the options on the following screen displayed when printing is complete.

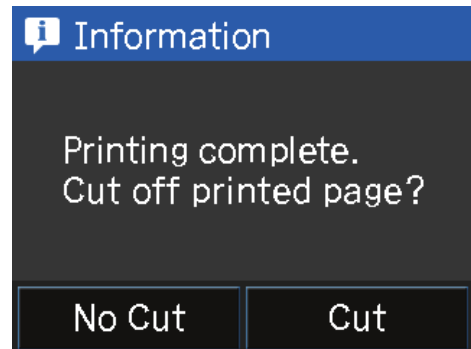

Cut: Feeds roll paper to the cutting position.

No Cut: Press to print without cutting.

- 2** When you press **Cut**, follow the instructions on the control panel's screen.

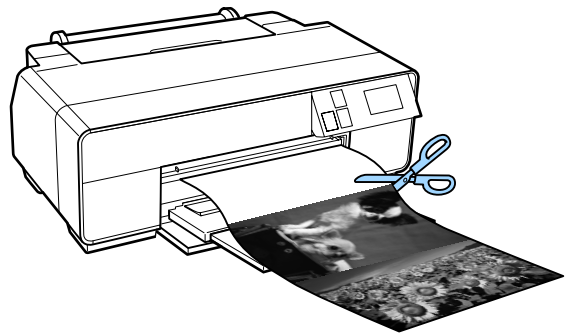

Removing Roll Paper

- 1** Press **Cut/Eject** on the control panel's Home screen.

- 2** Press **Eject**.

The paper will be fed back through the printer.

Basic Operations

- 3** Turn the knobs on the roll paper holder to take up the excess paper.

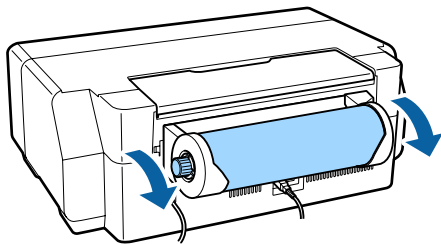

Loading and Removing CDs and DVDs

You can print on 12 cm CDs and DVDs with packaging indicating that the label surface supports printing with inkjet printers.



- ❑ Do not turn the printer on or off while the tray is inserted. This could cause a malfunction.
- ❑ Store the tray flat. Malfunction could result if the tray is curled or deformed.

A special application is required to print CDs and DVDs. Use the supplied Epson Print CD application.

Loading CDs and DVDs

Use the front manual feed tray and the CD/DVD tray.

- 1** Turn on the printer.

! Important:

An error may occur if you perform the following operations during printing.

- ❑ Extend the front manual feed tray.
- ❑ Load poster board.

- 2** If the rear support is open, close it.

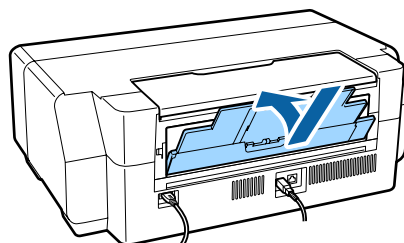

- 3** Open the front cover.

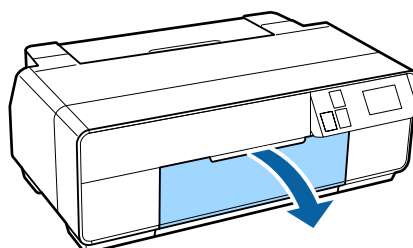

Basic Operations

- 4** Push the center of the front manual feed tray to pop it out.

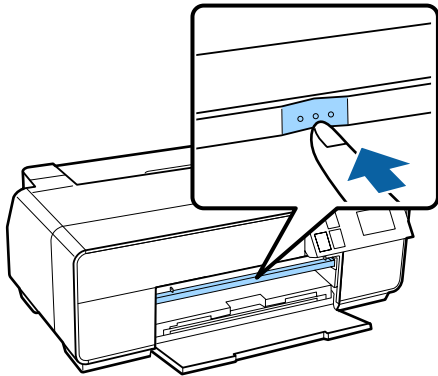

- 5** Place a disc on the supplied CD/DVD tray with the printable side up.

Press the disc down in the center to secure it in place.

! Important:
 Use the CD/DVD tray supplied with the printer. Using a different tray could damage the printer, tray, or disc or cause printer malfunction.

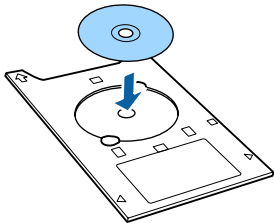

- 6** Insert the CD/DVD tray into the front manual feed tray.

! Important:
 Inserting the CD/DVD tray from the rear may cause a malfunction or error.

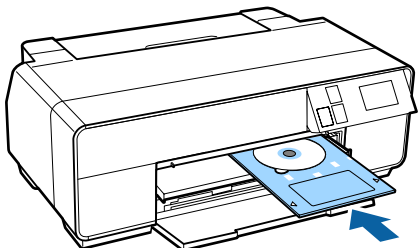

- 7** Align the right edge of the CD/DVD tray with the right edge of the front manual feed tray, and then align the arrows on the CD/DVD tray with the lines on the front manual feed tray.

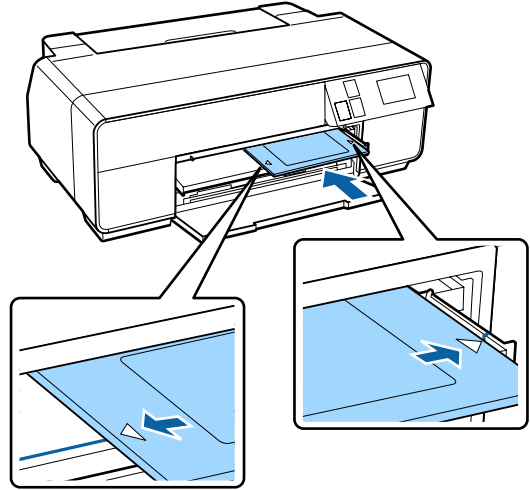

- 8** Press **CD/DVD - Load** on the control panel's screen.

The printer will load the CD/DVD tray and prepare to print.

Removing the CDs and DVDs

Removing after printing is complete

- 1** When the CD/DVD tray is ejected after printing, hold the end of the tray and pull it straight out.

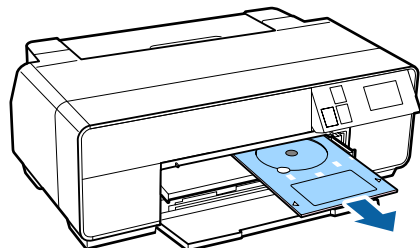

Basic Operations

- 2 Close the front manual feed tray.

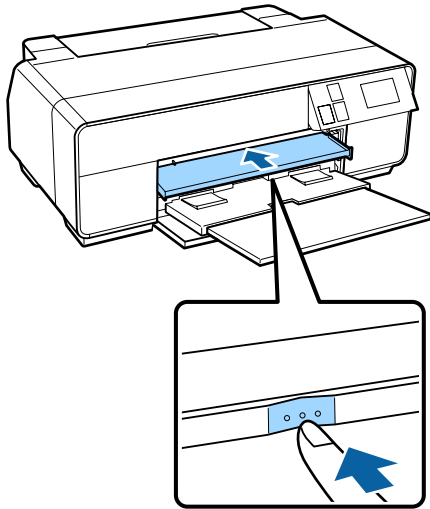

Removing before printing

Follow the steps below to remove the CD/DVD tray without printing.

- 1 Press **Eject** on the control panel's Home screen.
- 2 Follow the on-screen instructions.

Basic Printing Methods (Windows)

You can make print settings such as paper size and paper feed from the connected computer and then print.

- 1 Turn on the printer, and load the paper.
 - 👉 “Loading Cut Sheets” on page 22
 - 👉 “Loading Roll Paper” on page 27
 - 👉 “Loading CDs and DVDs” on page 29
- 2 When you have created the data, click **Print** from the **File** menu.

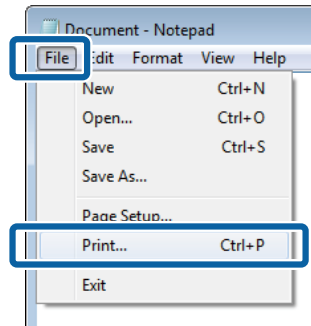

- 3 Make sure your printer is selected, and then click **Preferences** or **Properties** to display the settings screen.

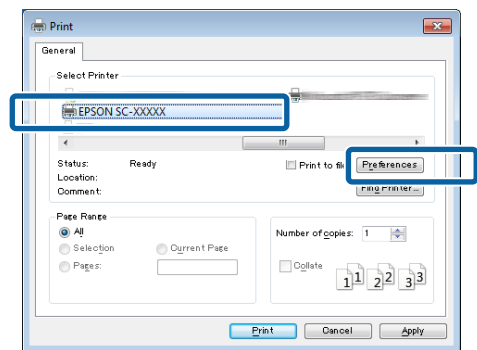

Basic Operations

4 Select the **Media Type**, **Color**, **Print Quality**, **Mode**, and **Source** according to the paper loaded in the printer.

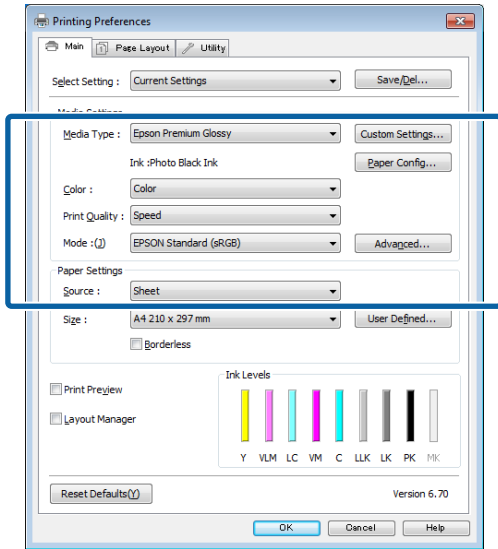

5 Make sure you select the same **Size** as you set in the application.

After making the settings, click **OK**.

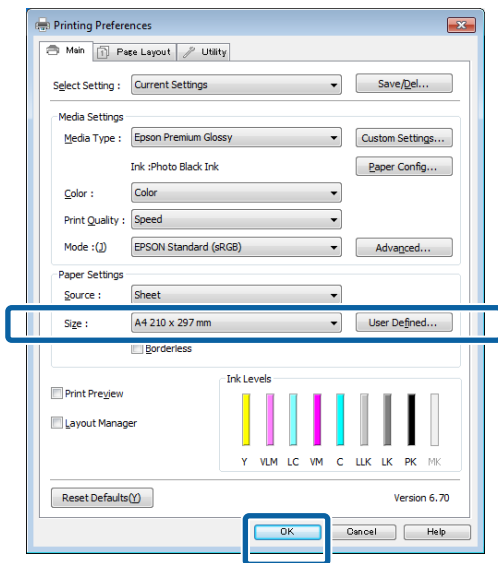

6 When settings are complete, click **Print**.

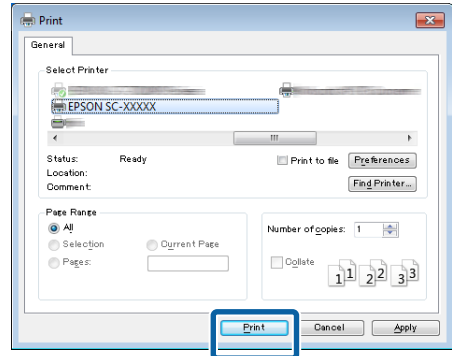

The Progress Bar is displayed, and printing starts.

Screen while printing

The following screen is displayed when you start printing, and the Progress Bar (the computer's processing status) is displayed. On this screen you can check the remaining ink level, product numbers for the ink cartridges, and so on.

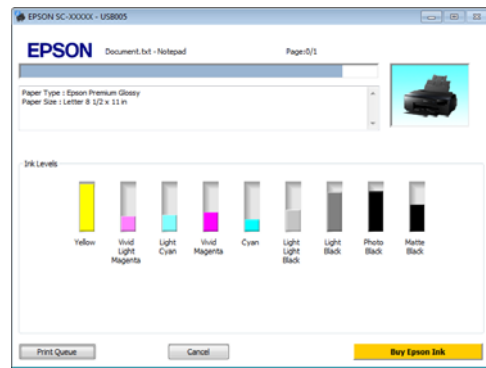

An error message is displayed if an error occurs or an ink cartridge needs replacing while printing.

Click **How to**, to find out how to solve the problem.

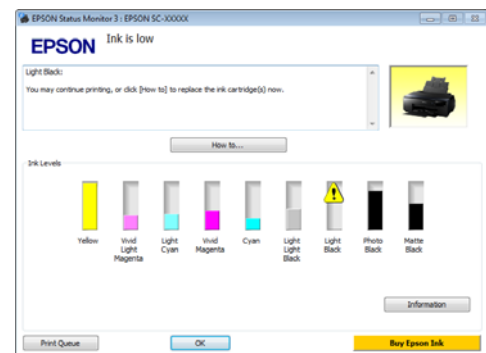

Basic Operations

Basic Printing Methods (Mac OS X)

You can make print settings such as paper size and paper feed from the connected computer and then print.

- 1 Turn on the printer, and load the paper.
 - 🔗 “Loading Cut Sheets” on page 22
 - 🔗 “Loading Roll Paper” on page 27
 - 🔗 “Loading CDs and DVDs” on page 29

2 When you have created the data, from the **File** menu of the application, click **Print** and so on.

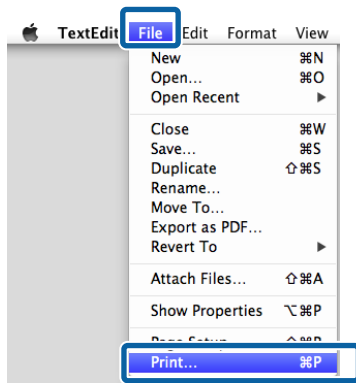

3 Click **Show Details** at the bottom of the screen.

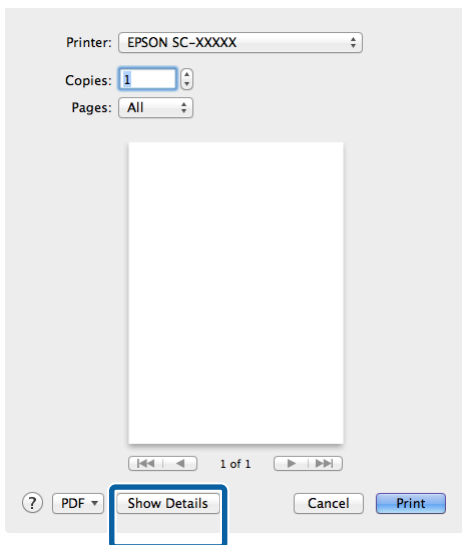

For Mac OS X v10.6.8, click the arrow on the right of the printer name () to make settings on the Page Setup screen.

Note:
If the page setting items are not displayed on the print screen, click **File** menu - **Page Setup** and so on in your application.

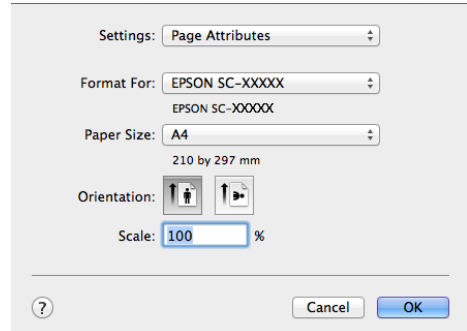

4 Check that this printer is selected, and then set the paper size.

Select the paper size, borderless printing options, and paper source in the **Paper Size** menu.

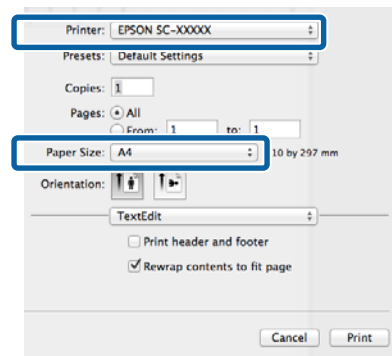

5 Select **Print Settings** from the list, and then set each item.

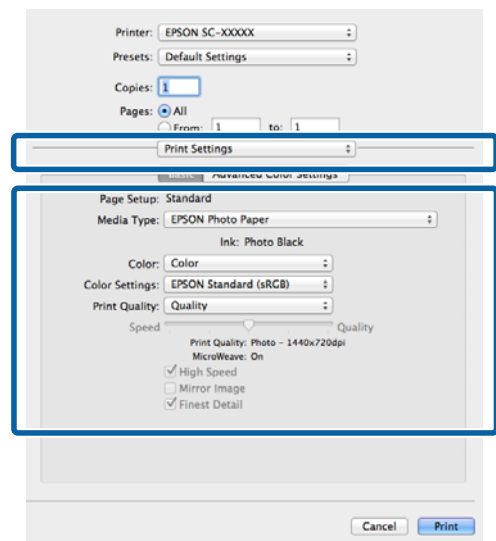

Basic Operations

Set the **Media Type**, **Color**, **Print Quality**, and other settings according to the type of paper loaded in the printer. Normally, you can print correctly just by setting items in the **Print Settings** screen.

6 When settings are complete, click **Print**.

The printer icon is displayed in the Dock while printing. Click the printer icon to display the status. You can check the progress of the current print job and the printer status information. You can also cancel a print job.

Also, if an error occurs while printing, a notification message is displayed.

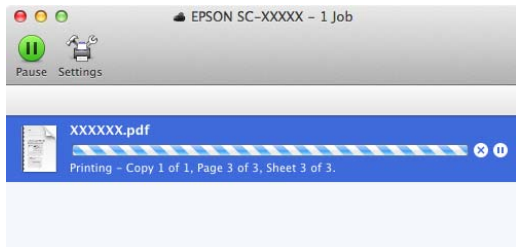

Printable area

The printable area is shown in gray in the illustration below. Note, however, that owing to the design of the printer, print quality will drop in the areas with hatching. The arrow in the illustration indicates the direction of the ejected paper.

! Important:
The width of the margins may vary somewhat depending on how the paper is loaded and its elasticity.

The Printed Area for Cut Sheets

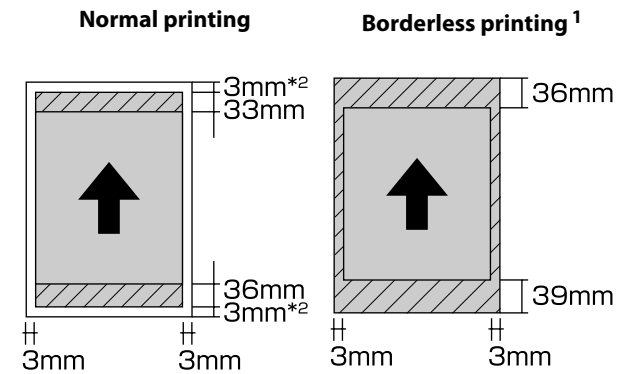

- 1 Borderless printing is not supported with poster board.
- 2 Poster board under A3+ in size is printed with 20 mm margins.

The Printed Area for Roll Paper

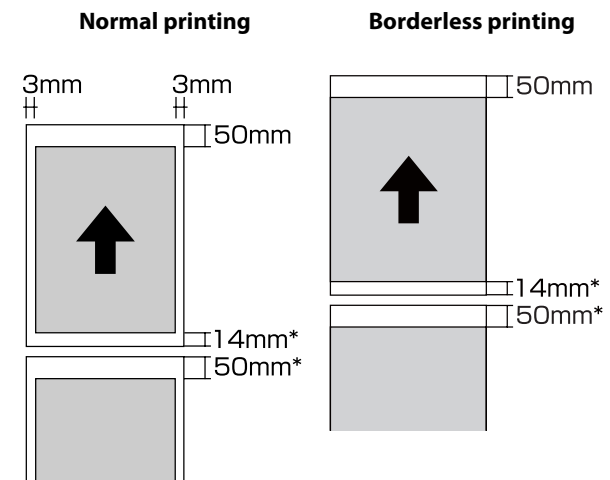

* 0 mm for continuous print jobs.

The Printed Area for CDs and DVDs

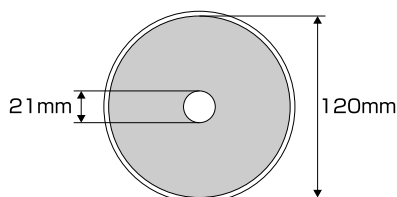

Note:

The supplied EPSON Print CD application supports a minimum internal diameter of 18 mm and a maximum external diameter of 120 mm. When printing on CDs and DVDs, check the dimensions of the discs' printable area before selecting the internal and external diameter.

Changing the Type of Black Ink

This printer allows you to set both photo black ink and matte black ink and switch between them depending on the paper type.

Photo Black ink reduces the grainy feeling of photo papers giving them a smooth, professional finish. Matte Black ink significantly increases black optical density when printing on matte type papers.

See the following section to select a suitable black ink for the media type.

 [“Epson Special Media Table” on page 111](#)

The time needed to switch from one type of black ink to another (from ink replacement until charging is complete) is given below. Note that this process consumes some of the new type of ink.

Do not switch the black ink unless necessary.

Photo Black to Matte Black: Approx. 1.5 mins.

Matte Black to Photo Black: Approx. 3.5 mins.

Note:

If there is not enough ink remaining for the switch, you will need to replace the cartridge. It may be possible to print with ink cartridges that could not be used for a black ink switch.

Switching Automatically

You can switch black inks and print from the printer driver.

Press  on the control panel's Home screen, and then set **System Administration - Printer Settings - BK Ink Auto Change** to **On**.

1

Display the printer driver's Main screen.

 [“Basic Printing Methods\(Windows\)” on page 31](#)

 [“Basic Printing Methods\(Mac OS X\)” on page 33](#)

Basic Operations

2 Select the paper type from the **Media Type** menu.

Depending on the media type you select, black ink is switched automatically during printing.

<Windows>

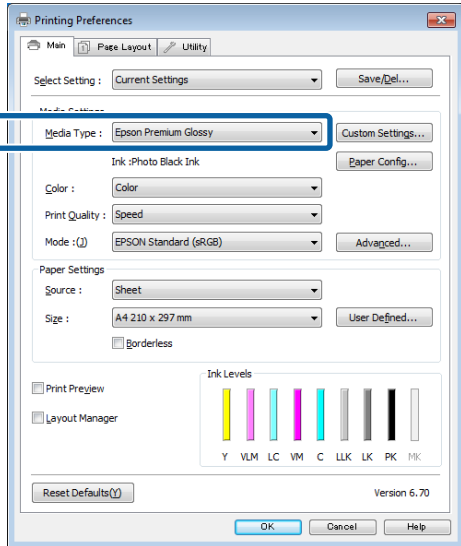

<Mac OS X>

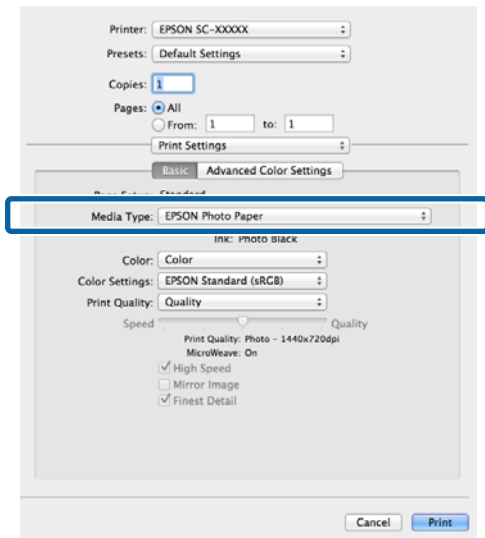

- ❑ The black ink type that can be used for printing varies depending on the media type.
- ❑ You can select the type of black ink from **Ink** when the media type selected supports both photo black and matte black.
 ↗ *“Supported Media” on page 111*
- ❑ If the printer status cannot be acquired, the black ink type may change automatically.

3 Check other settings, and then start printing.

Switching Manually

Change from the control panel.

1 Press the  button to turn on the printer.

2 Press  (switch black ink) on the Home screen.

Follow the on-screen instructions.

Energy Saving Settings

This printer comes equipped with the following two types of power saving settings. You can save power by transitioning into sleep mode or use the Power Off Timer function to automatically turn off the power when the printer has not been used for a certain period of time.

Sleep mode

The printer enters sleep mode when there are no errors, no print jobs being received, and no control panel or other operations performed.

When the printer enters sleep mode, the control panel's screen turns off and the internal motors and other parts switch off to consume less power.

Sleep mode ends and normal operation is restored when a print job is received or any button (excluding the  button) is pressed in the control panel.

You can set the time to switch to sleep mode (**Sleep Timer**) from 1 to 240 minutes. As the manufacturer's setting, the printer will enter sleep mode if no operations are performed for 3 minutes.

Set the time before switching to sleep mode in the Setup menu.

 [“Menus” on page 88](#)

Note:

When the printer enters sleep mode, the control panel's screen goes blank as if the power has been turned off, but the  light remains lit.

Power Off Timer

The printer includes an Power Off Timer function that allows the printer to be turned off automatically if there are no errors, no print jobs being received, and no control panel or other operations being performed for more than the specified amount of time. You can choose the elapsed time before the printer is automatically turned off from **30minutes**, **1h**, **2h**, **4h**, **8h**, and **12h**.

You can make **Power Off Timer** settings from the printer using the Setup menu.  [“Menus” on page 88](#)

The manufacturer's setting varies depending on the area of use.

You can make Power Off Timer settings from the computer using the Utility.

Windows  [“Summary of the Utility Tab” on page 44](#)

Mac OS X  [“Epson Printer Utility 4 Functions” on page 47](#)

About Power Management using Power Off Timer

You can adjust the time before Power Management is applied.

Any increase will affect the printer's energy efficiency.

Please consider the environment before making any change.

Basic Operations

Canceling Printing

There are a few ways to stop printing operations depending on the situation.

When the computer has finished sending data to the printer, you cannot cancel the print job from the computer. Cancel on the printer.

Canceling from the computer (Windows) When the Progress Bar is displayed

Click **Cancel**.

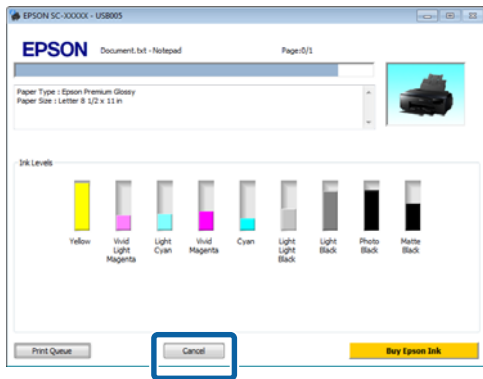

When the Progress Bar is not displayed

1 Click the printer icon on the Taskbar.



2 Select the job you want to cancel, and then select **Cancel** from the **Document** menu.

When you want to cancel all jobs, select **Cancel All Documents** from the **Printer** menu.

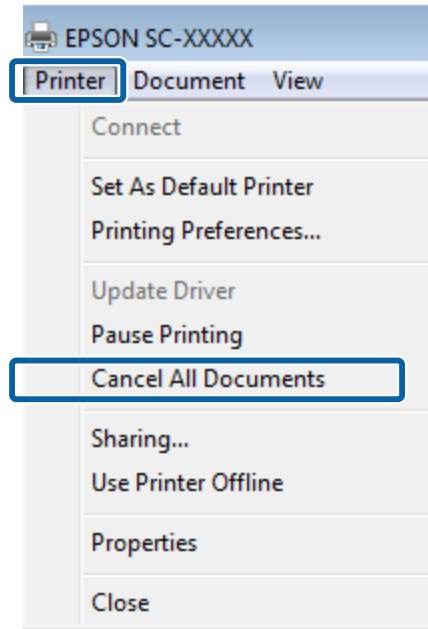

If the job has been sent to the printer, print data is not displayed on the above screen.

Canceling from the computer (Mac OS X)

1 Click the printer icon in the Dock.

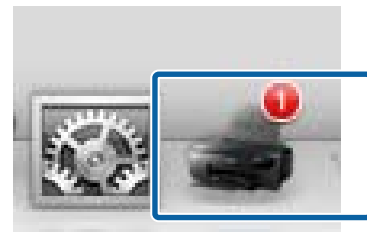

2 Select the job you want to cancel, and then click **Delete**.

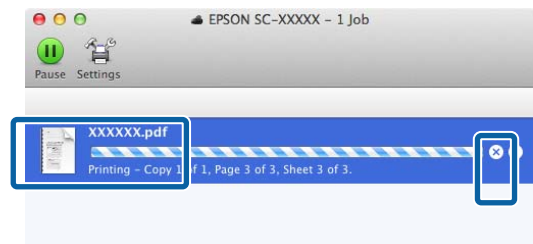

If the job has been sent to the printer, print data is not displayed on the above screen.

Basic Operations

Canceling on the printer

Press **Cancel** on the control panel screen, and then follow the on-screen instructions.

The print job is canceled even in the middle of printing. It may take a while before the printer returns to ready status after canceling a job.

Note:

You cannot delete print jobs which are in the print queue on the computer using the above operation. See "Canceling from the Computer" for information on deleting print jobs from the print queue.

Using the Printer Driver(Windows)

Using the Printer Driver (Windows)

Displaying the Settings Screen

You can access the printer driver in the following ways:

- ❑ From Windows applications

 [“Basic Printing Methods\(Windows\)” on page 31](#)

- ❑ From the Start button

From the Start button

Follow the steps below when specifying common settings among applications or performing printer maintenance, such as Nozzle Check or Head Cleaning.

- 1 Open the **Printers** or **Printers and Faxes** folder.

For Windows 7/Windows 8.1/Windows 8
Click **Start** (or **Settings**), **Control Panel**, and then **View devices and printers** (or **Devices and printers**) from **Hardware and Sound** (or **Hardware**).

For Windows Vista
Click , **Control Panel**, **Hardware and Sound**, and then **Printer**.

- 2 Right-click your printer icon, and click **Printing preferences**.

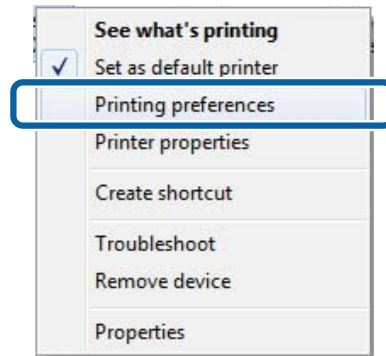

The printer driver setting screen is displayed.

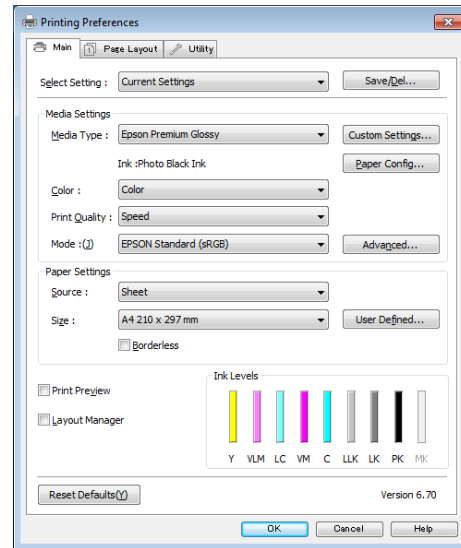

Make the necessary settings. These settings become the default settings of the printer driver.

Using the Printer Driver(Windows)

Displaying Help

You can access the printer driver help in the following ways:

- ❑ Click **Help**
- ❑ Right-click on the item you want to check

Click the Help Button to Display

By displaying help, you can use the contents page or keyword search to read the help.

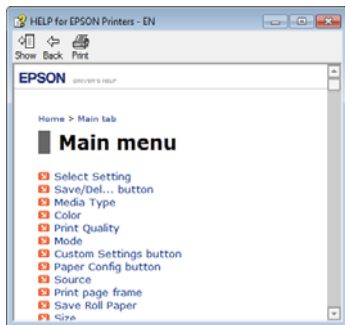
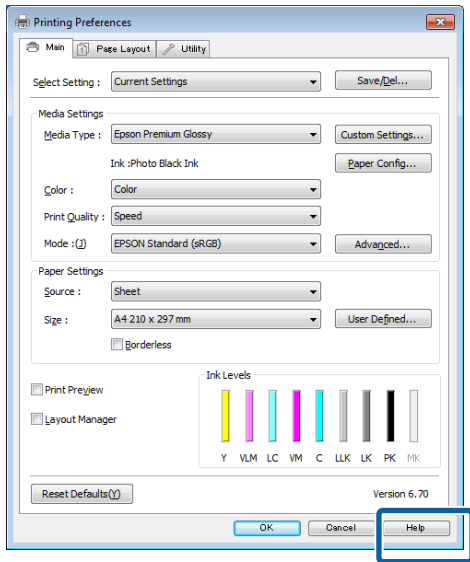

Right-click on the item you want to check

Right-click the item, and then click **Help**.

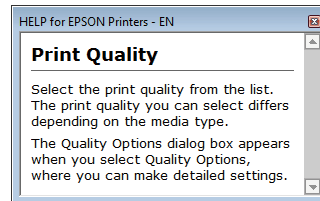
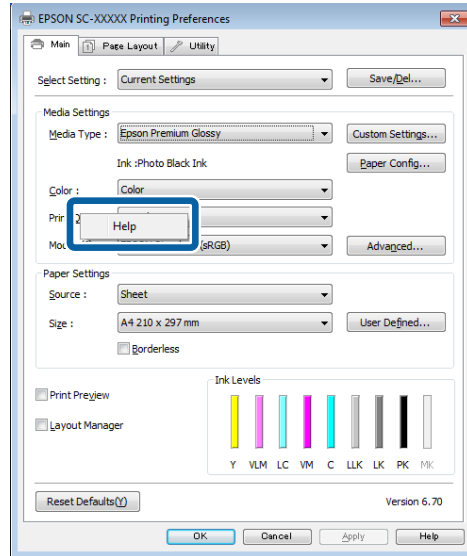

Using the Printer Driver(Windows)

Customizing the Printer Driver

You can save the settings or change the display items as you prefer.

Saving various settings as your Select Settings

You can save all printer driver settings as a Select Setting. Additionally, in Select Setting the recommended settings for a variety of uses are already available.

This allows you to easily load settings that have been stored in Select Settings, and repeatedly print using exactly the same settings.

1 Set each item for the **Main** screen and the **Page Layout** screen that you want to save as your Select Settings.

2 Click **Save/Del** in the **Main** or **Page Layout** tab.

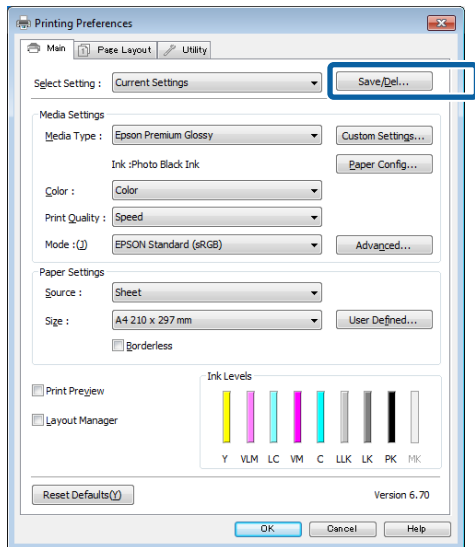

3 Enter any name in the **Name** box, and then click **Save**.

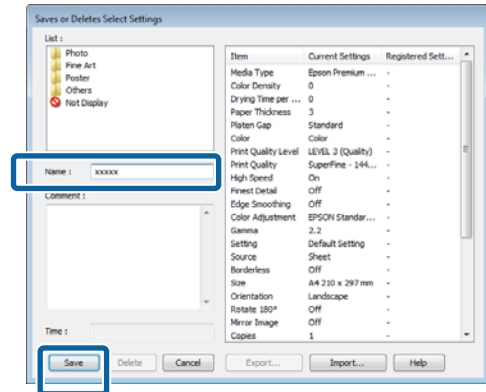

You can save up to 100 settings. You can choose a setting you have registered from the **Select Setting** list box.

Note:

You can save the settings as a file by clicking **Export**. You can share the settings by clicking **Import** to import the saved file on another computer.

Saving media settings

You can save the items of the **Media Settings** on the **Main** screen.

1 Change the **Media Settings** items on the **Main** screen.

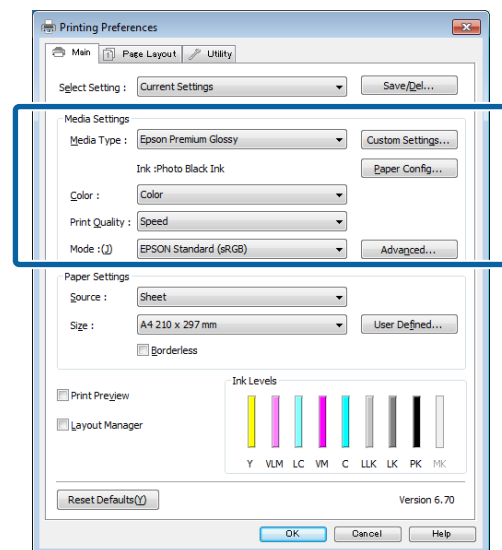

Using the Printer Driver(Windows)

2 Click **Custom Settings**.

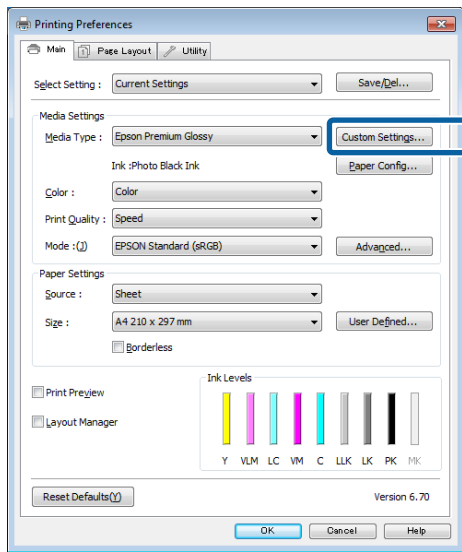

3 Enter any name in the **Name** box, and then click **Save**.

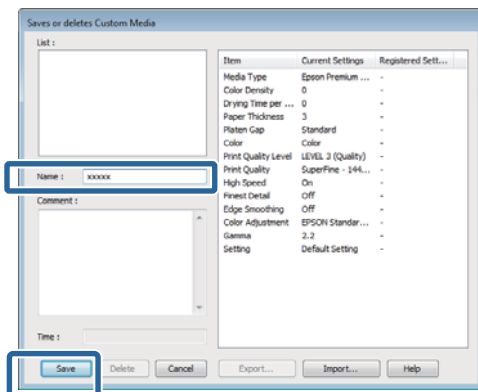

You can save up to 100 settings. You can choose a setting you have registered from the **Media Type** list box.

Note:

You can save the settings as a file by clicking **Export**. You can share the settings by clicking **Import** to import the saved file on another computer.

Rearranging display items

To display frequently used items right away, you can arrange **Select Setting**, **Media Type**, and **Paper Size** as follows.

- Hide unnecessary items.
- Rearrange in an order of most frequent use.

Arrange in groups (folders).

1 Go to the **Utility** tab and click **Menu Arrangement**.

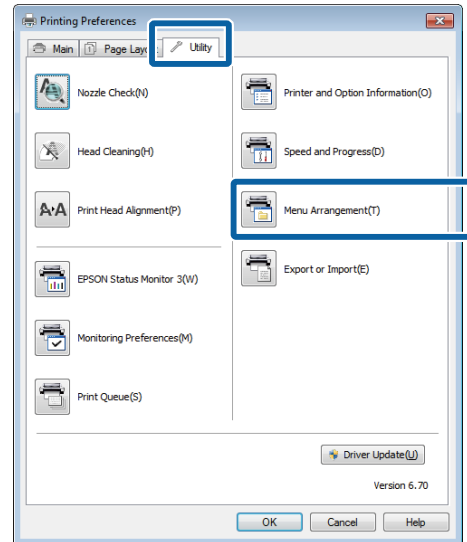

2 Select **Edit Item**.

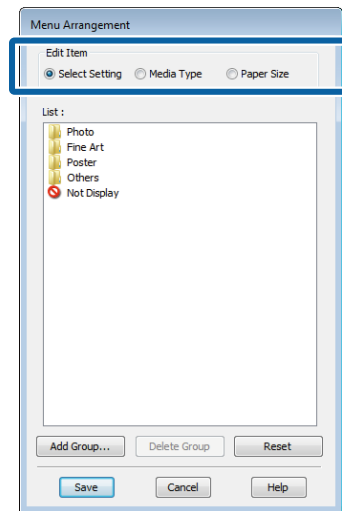

3 Order or group items in the **List** box.

- You can move and order items by dragging and dropping.
- To add a new group (folder), click **Add Group**.
- To delete a group (folder), click **Delete Group**.

Using the Printer Driver(Windows)

- ❑ Drag and drop unnecessary items to Not Display.

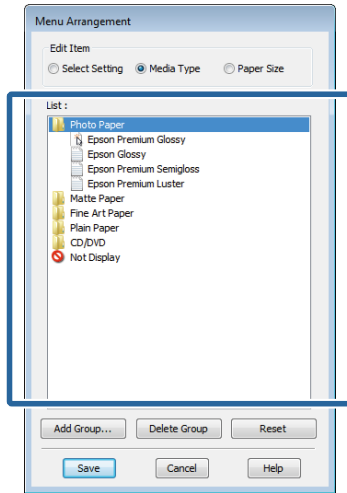

Note:
When **Delete Group** is performed, the group (folder) is deleted, however the items in the deleted group (folder) remain.

- 4 Click **Save**.

Summary of the Utility Tab

You can perform the following maintenance functions from the printer driver's **Utility** tab.

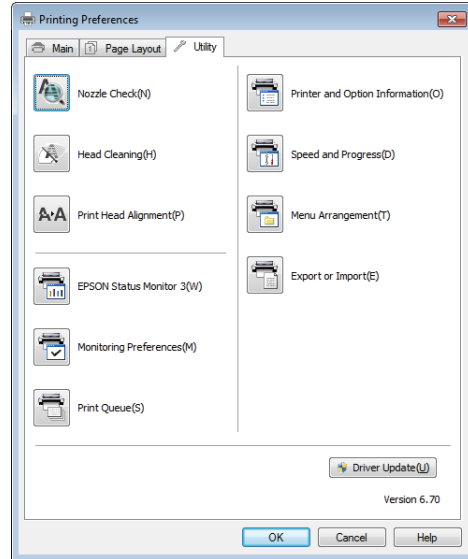

Nozzle Check

This function prints a nozzle check pattern to check whether the print head nozzles are clogged.

If the pattern is blurred or there are gaps, perform head cleaning to clear the clogging.

[“Checking for clogged nozzles” on page 94](#)

Head Cleaning

Perform head cleaning if you notice banding or gaps in the print results. Cleans the surface of the print head to improve the print quality.

[“Head Cleaning” on page 95](#)

Print Head Alignment

If the print results appear grainy or out of focus, perform Print Head Alignment. The Print Head Alignment function corrects print head gaps.

[“Correcting Print Misalignment \(Print Head Alignment\)” on page 95](#)

Using the Printer Driver(Windows)

EPSON Status Monitor 3

You can check the printer's status, such as the remaining ink level and error messages, from the computer's screen.

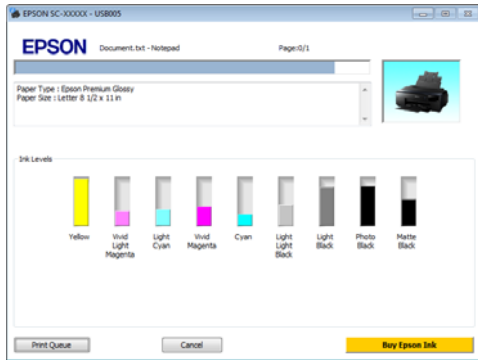

Monitoring Preferences

You can select the error notifications displayed on the EPSON Status Monitor 3 screen, or register a shortcut for the Utility icon to the Taskbar.

Note:

*If you select the **Shortcut Icon on the Monitoring Preferences** screen, the Utility shortcut icon is displayed on the Windows Taskbar.*

By right-clicking the icon, you can display the following menu and perform maintenance functions.

EPSON Status Monitor 3 starts when the printer name is clicked from the displayed menu.

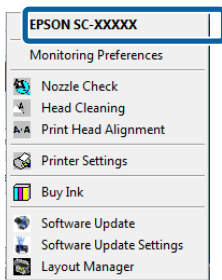

Print Queue

You can display the list of all waiting jobs.

On the Print Queue screen, you can view information on the data waiting to be printed, delete and reprint these jobs.

Printer and Option Information

You can set the time to automatically turn off the printer from Power Off Timer Settings.

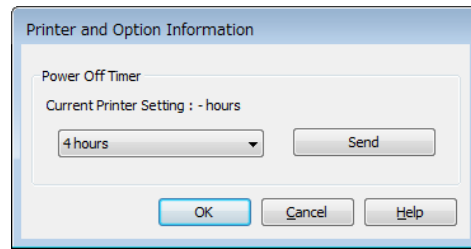

Speed and Progress

You can set various functions for printer driver basic operations.

Menu Arrangement

You can arrange items by, for example, listing **Select Setting**, **Media Type**, and **Paper Size** options by frequency of use.

Export or Import

You can save the printer driver settings to a file or import them from the file. This function is useful when you want to make the same printer driver settings on multiple computers.

Driver Update

Visit the Epson website to check whether there is a driver newer than the currently installed version. If a new version is found, the printer driver will be updated automatically.

Using the Printer Driver(Windows)

Uninstalling the printer driver

Follow the instructions below to uninstall the printer driver.

Important:

- You must log in with an Administrator account.
- In Windows 7/Windows Vista, if an Administrator password or confirmation is requested, enter the password and then continue with the operation.

- 1** Turn off the printer, and unplug the interface cable.
- 2** Go to the **Control Panel** and click **Uninstall a program** from the **Programs** category.

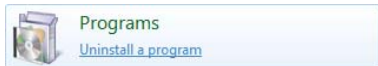

- 3** Select a program to uninstall, and then click **Uninstall/Change** (or **Change/Remove/Add or remove**).

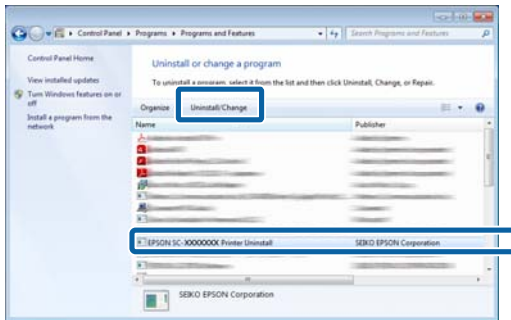

- 4** Select the target printer icon, and then click **OK**.

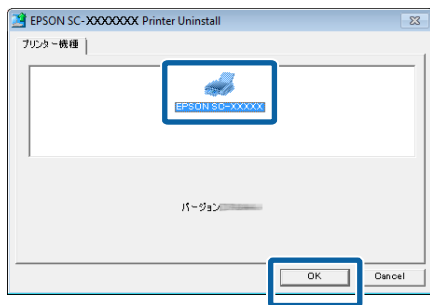

Note:

You can also remove the Epson Network Utility by clicking the **Utility** tab and selecting the **Epson Network Utility**.

Note, however, that the drivers for any other Epson printers you may be using may also access the Epson Network Utility. Do not remove the Epson Network Utility if you are using other Epson printers.

- 5** Follow the on-screen instructions to continue.
When the delete confirmation message appears, click **Yes**.

Restart the computer if you are reinstalling the printer driver.

Using the Printer Driver(Mac OS X)

Using the Printer Driver (Mac OS X)

Displaying the Settings Screen

The display method of the printer driver setting screen may differ depending on the application or the OS version.

 [“Basic Printing Methods\(Mac OS X\)” on page 33](#)

Displaying Help

Click  in the printer driver setting screen to display Help.

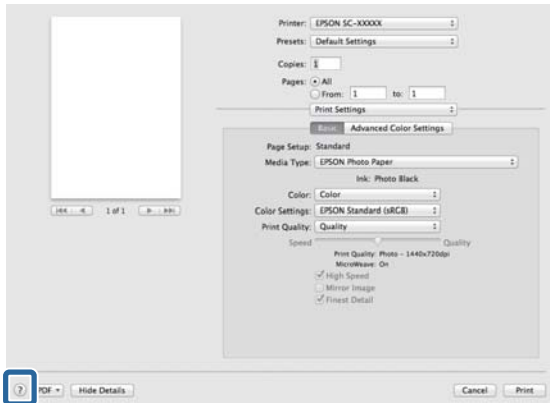

Using Epson Printer Utility 4

You can perform maintenance tasks such as Nozzle Check or Head Cleaning by using Epson Printer Utility 4. This utility is installed automatically when you install the printer driver.

Starting Epson Printer Utility 4

- 1** Click the Apple menu - **System Preferences - Print & Scan** (or **Print & Fax**).
- 2** Select the printer, and then click **Options & Supplies - Utility - Open Printer Utility**.

Epson Printer Utility 4 Functions

You can perform the following maintenance functions from Epson Printer Utility 4.

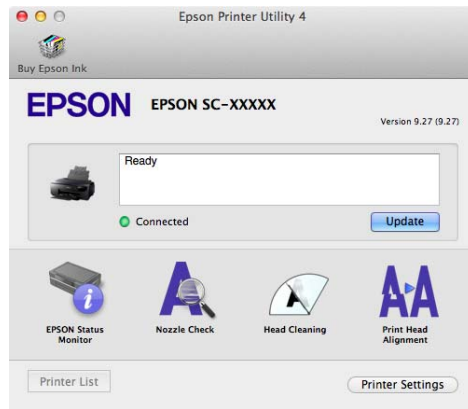

Using the Printer Driver(Mac OS X)

EPSON Status Monitor

You can check the printer's status, such as the remaining ink level and error messages, from the computer's screen.

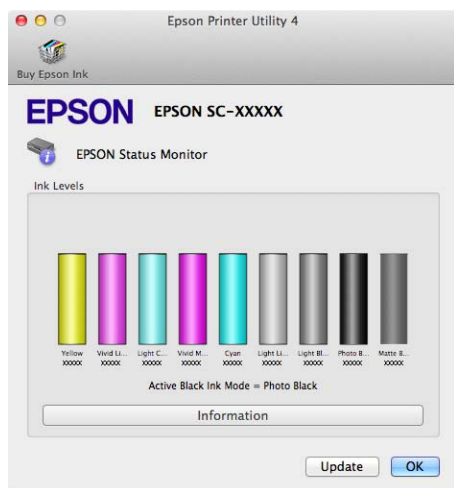

Nozzle Check

This function prints a nozzle check pattern to check whether the print head nozzles are clogged.

If the pattern is blurred or there are gaps, perform head cleaning to clear the clogging.

 [“Checking for clogged nozzles” on page 94](#)

Head Cleaning

Perform head cleaning if you notice banding or gaps in the print results. Cleans the surface of the print head to improve the print quality.

 [“Head Cleaning” on page 95](#)

Print Head Alignment

Perform print head alignment if the print results appear grainy or blurred. The Print Head Alignment function corrects print head gaps.

 [“Correcting Print Misalignment \(Print Head Alignment\)” on page 95](#)

Printer Settings

You can make settings for printer operations.

You can set the time to automatically turn off the printer from Power Off Timer Settings.

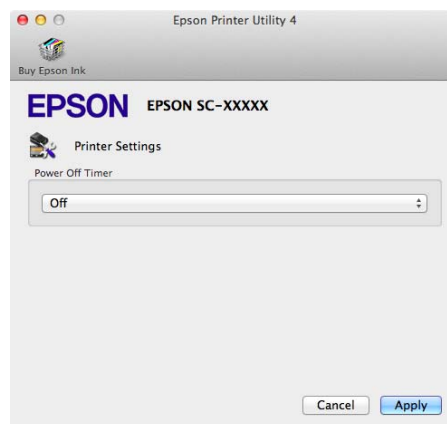

Uninstalling the printer driver

When reinstalling the printer driver or upgrading, remove the target software first.

Use the "Uninstaller" to remove the printer driver.

Acquiring the Uninstaller

You can download the "Uninstaller" from the Epson homepage.

<http://www.epson.com/>

Using the Uninstaller

Follow the steps provided when you acquire the "Uninstaller".

Printing Varieties

Auto Correct Color and Print Photos (PhotoEnhance)

The printer driver for this printer comes with the Epson proprietary function PhotoEnhance that makes the most efficient use of the color reproduction area, corrects image data to improve colors before printing.

By using PhotoEnhance, you can correct photo colors to match the subject types such as people, scenery, or night view. You can print color data in sepia or black and white. Colors are automatically corrected simply by selecting the print mode.

Note:
It is recommended that you use images with a color space of sRGB.

Adjusting Settings in Windows

1 When using applications featuring a color management function, specify how to adjust colors from these applications.

When using applications without a color management function, start from step 2.

Depending on the type of the application, make the settings following the table below.

Application	Color Management Settings
Adobe Photoshop CS3 or later	Printer Manages Colors
Adobe Photoshop Lightroom 1 or later	
Adobe Photoshop Elements 6 or later	
Other applications	No Color Management

Note:
For information on the operating systems supported by each application, visit the distributor's website.

Setting example for Adobe Photoshop CS5

Open the **Print** screen.

Select **Color Management** and then **Document**. Select **Printer Manages Colors** as the **Color Handling** setting, and then click **Print**.

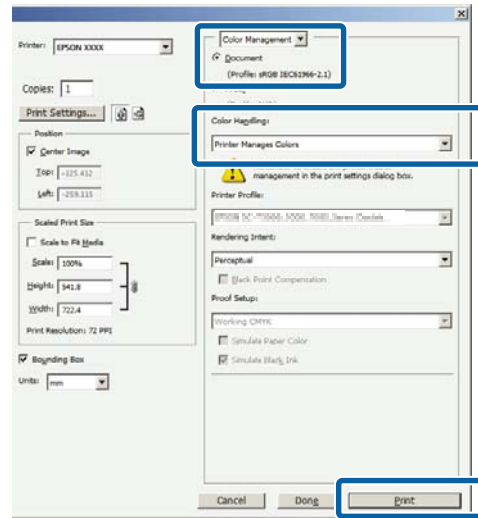

2 Display the **Main** tab in the printer driver, select **PhotoEnhance** for **Mode**, and click **Advanced**.

☞ “Basic Printing Methods(Windows)” on page 31

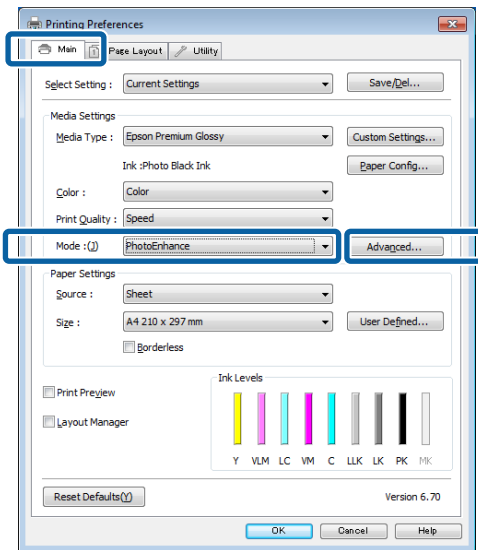

Printing Varieties

- On the **PhotoEnhance** screen, you can set effects to apply to the print data.

See the printer driver help for more details on each item.

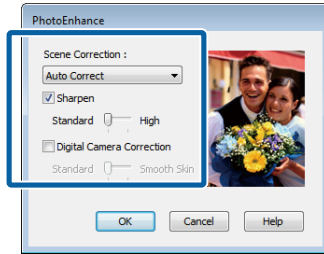

- Check other settings, and then start printing.

Making Settings for Mac OS X

- When using applications featuring a color management function, specify how to adjust colors from these applications.

Depending on the type of the application, make the settings following the table below.

Application	Color Management Settings
Adobe Photoshop CS3 or later	Printer Manages Colors
Adobe Photoshop Lightroom 1 or later	
Adobe Photoshop Elements 6 or later	
Other applications	No Color Management

Setting example for Adobe Photoshop CS5

Open the **Print** screen.

- Select **Color Management** and then **Document**. Select **Printer Manages Colors** as the **Color Handling** setting, and then click **Print**.

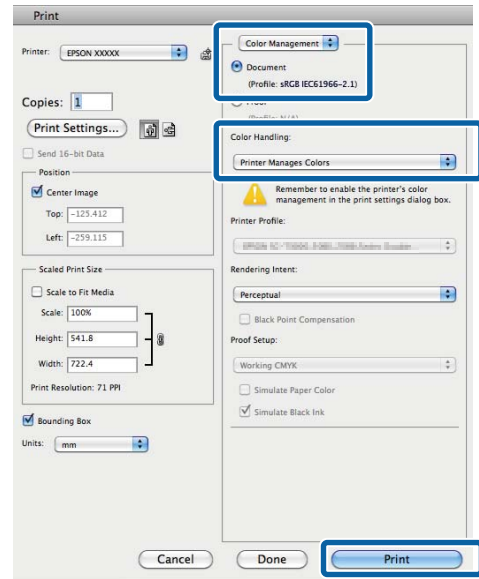

- Display the Print dialog, select **Color Matching**, and click **EPSON Color Controls**.

[“Basic Printing Methods\(Mac OS X\)”](#) on page 33

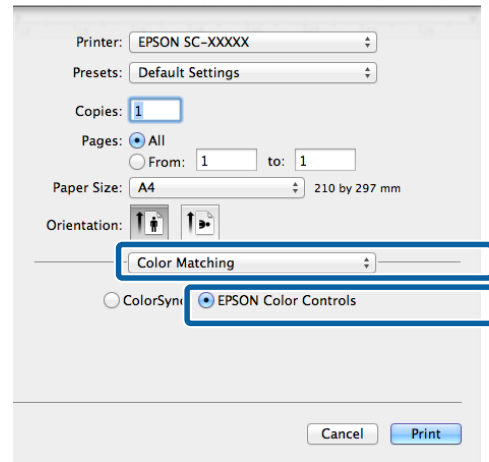

Note:
EPSON Color Controls is unavailable in Adobe Photoshop CS3 or later, Adobe Photoshop Lightroom 1 or later, and Adobe Photoshop Elements 6 or later unless the setting in step 1 is made.

Printing Varieties

3 Select **Print Settings** from the list, select **PhotoEnhance** for **Color Settings**, and click **Advanced Color Settings**.

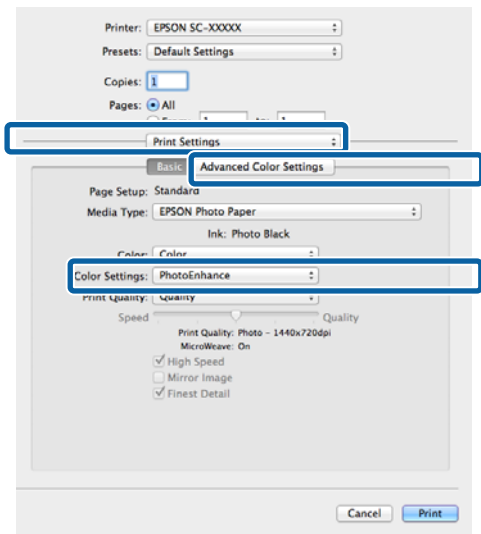

4 Choose the effects that will be applied to the print data in the **Advanced Color Settings** screen.

See the printer driver help for more details on each item.

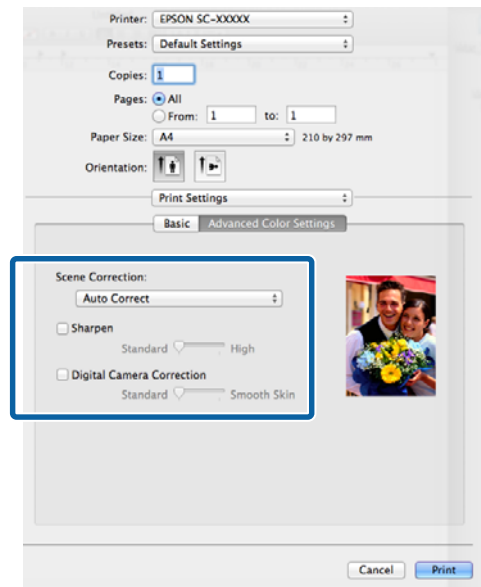

5 Check other settings, and then start printing.

Correct color and print

The printer driver automatically and internally corrects colors to match the color space. You can select from the following color correction modes.

- EPSON Standard (sRGB)
Optimizes the sRGB space and corrects the color.
- Adobe RGB
Adobe RGB Optimizes the sRGB space and corrects the color.

Note that if you click **Advanced** when one of the above color processing options is selected, you can fine-tune Gamma, Brightness, Contrast, Saturation, and color balance for the selected option.

Use this option when the application in use does not have a color correction function.

Adjusting Settings in Windows

1 When using applications featuring a color management function, specify how to adjust colors from these applications.

When using applications without a color management function, start from step 2.

Depending on the type of the application, make the settings following the table below.

Application	Color Management Settings
Adobe Photoshop CS3 or later	Printer Manages Colors
Adobe Photoshop Lightroom 1 or later	
Adobe Photoshop Elements 6 or later	
Other applications	No Color Management

Note:
For information on the operating systems supported by each application, visit the distributor's website.

Setting example for Adobe Photoshop CS5

Printing Varieties

Open the **Print** screen.

Select **Color Management** and then **Document**. Select **Printer Manages Colors** as the **Color Handling** setting, and then click **Print**.

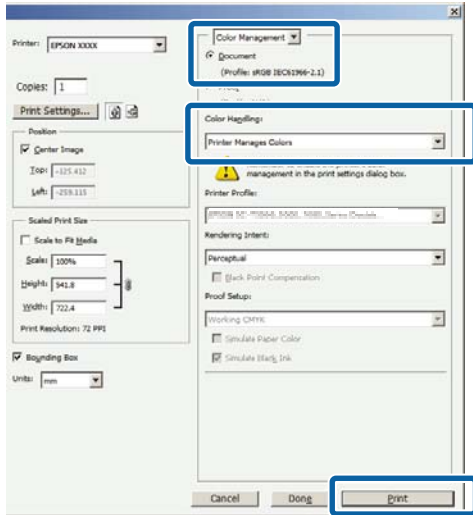

2 When the printer driver's **Main** screen is displayed, select the color correction mode.

➔ “Basic Printing Methods(Windows)” on page 31

To adjust settings manually, click **Advanced** to display **Color Controls**.

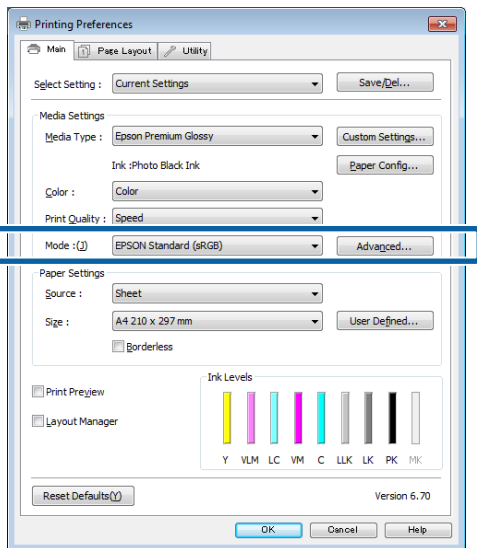

3 If you opted to display the **Color Controls** screen in Step 2, adjust settings as desired.

See the printer driver help for more details on each item.

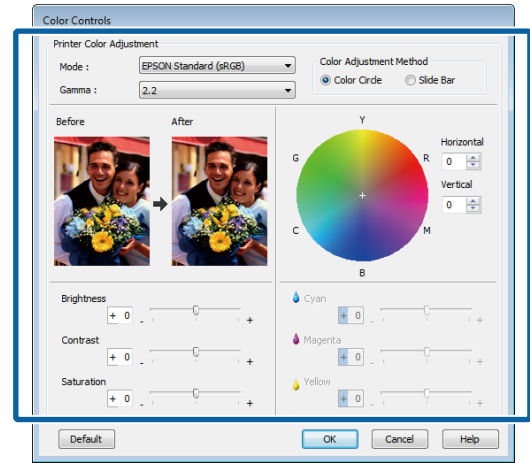

Note:

You can adjust the correction value by checking the sample image on the left side of the screen. You can also use the color circle to fine-tune the color balance.

4 Check other settings, and then start printing.

Making Settings for Mac OS X

1 When using applications featuring a color management function, specify how to adjust colors from these applications.

When using applications without a color management function, start from step 2.

Set color management to **Printer Manages Colors** in the following applications.

- Adobe Photoshop CS3 or later
- Adobe Photoshop Elements 6 or later
- Adobe Photoshop Lightroom 1 or later

In other applications, set **No Color Management**.

Note:

For information on the operating systems supported by each application, visit the distributor's website.

Printing Varieties

Setting example for Adobe Photoshop CS5

Open the **Print** screen.

Select **Color Management** and then **Document**.
 Select **Printer Manages Colors** as the **Color Handling** setting, and then click **Print**.

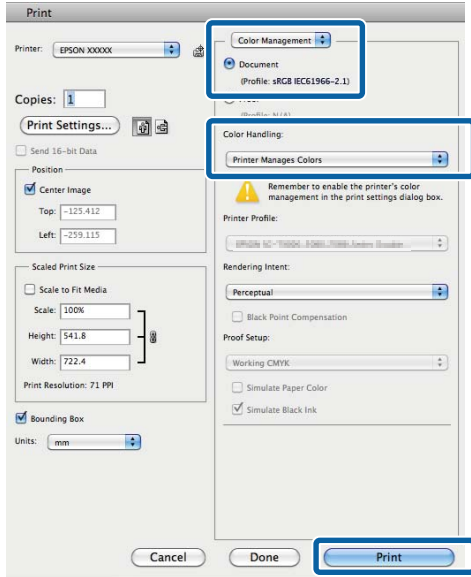

2 Display the Print screen.

[“Basic Printing Methods\(Mac OS X\)” on page 33](#)

3 Select **Color Matching** from the list, and then click **EPSON Color Controls**.

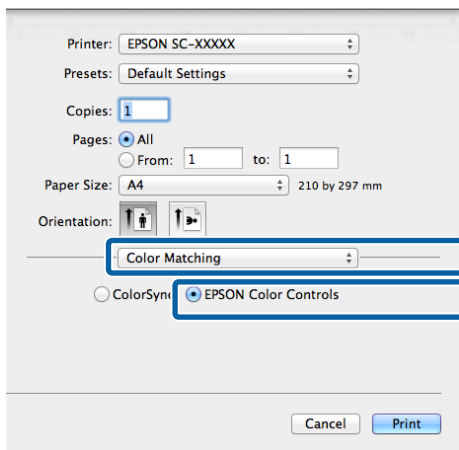

Note:

EPSON Color Controls is unavailable unless the setting in step 1 is made for the following applications.

- Adobe Photoshop CS3 or later
- Adobe Photoshop Lightroom 1 or later
- Adobe Photoshop Elements 6 or later

4

Select **Print Settings** from the list, and then select **EPSON Standard (sRGB)** or **AdobeRGB** under **Color Settings**. When adjusting the parameters manually, click **Advanced Color Settings**.

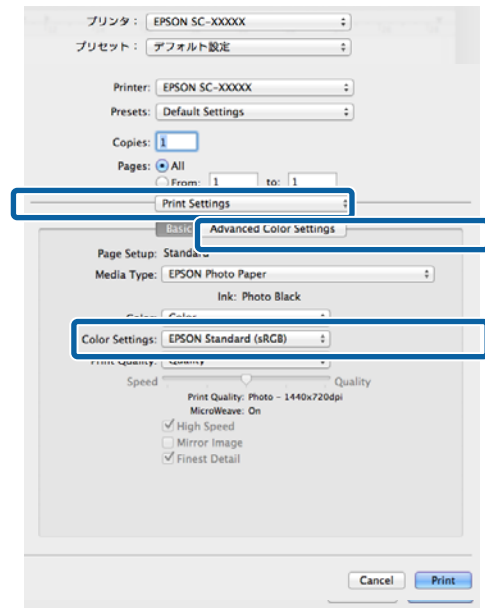

Printing Varieties

- 5 Make the necessary settings.
See the printer driver help for more details on each item.

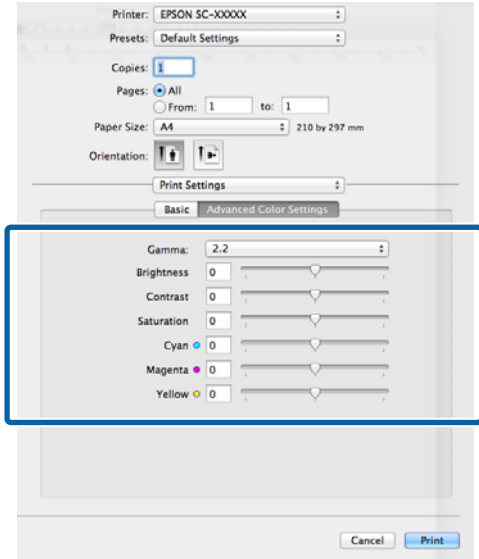

- 6 Check other settings, and then start printing.

Printing Black and White Photos

You can print black and white photos with rich gradation by adjusting the image data color by the printer driver.

The original data is not affected.

You can correct image data when printing without processing the data from applications.

Note:

It is recommended that you use images with a color space of sRGB.

Adjusting Settings in Windows

- 1 When using applications featuring a color management function, specify how to adjust colors from these applications.

When using applications without a color management function, start from step 2.

Depending on the type of the application, make the settings following the table below.

Application	Color Management Settings
Adobe Photoshop CS3 or later Adobe Photoshop Lightroom 1 or later Adobe Photoshop Elements 6 or later	Printer Manages Colors
Other applications	No Color Management

Note:

For information on the operating systems supported by each application, visit the distributor's website.

Setting example for Adobe Photoshop CS5

Open the **Print** screen.

Printing Varieties

Select **Color Management** and then **Document**. Select **Printer Manages Colors** or **No Color Management** as the **Color Handling** setting, and then click **Print**.

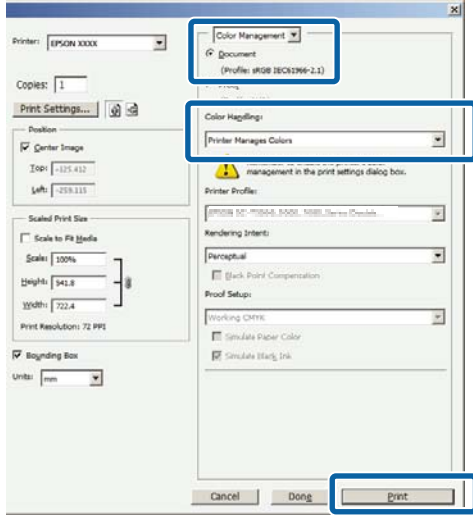

2 Display the printer driver **Main** tab and select **Advanced B&W Photo** as the **Color**.

☞ “Basic Printing Methods(Windows)” on page 31

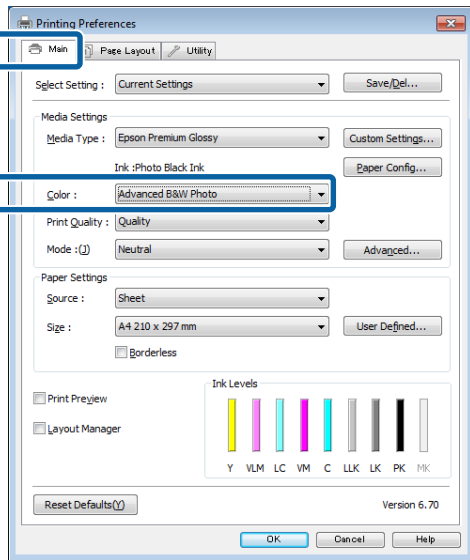

3 Click **Advanced** for **Mode**.

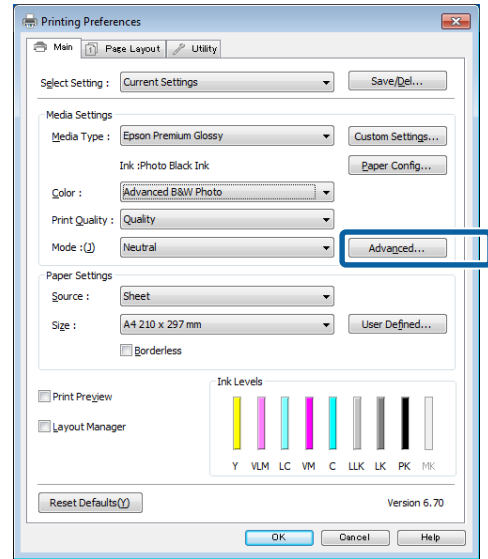

4 Make the necessary settings.

See the printer driver help for more details on each item.

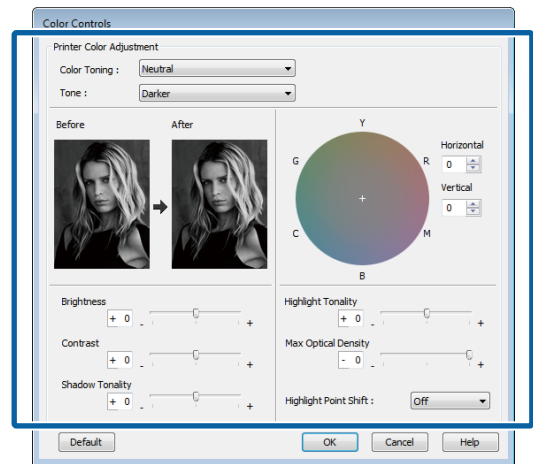

5 Check other settings, and then start printing.

Making Settings for Mac OS X

1 When using applications featuring a color management function, specify how to adjust colors from these applications.

Set color management to **Printer Manages Colors** in the following applications.

- Adobe Photoshop CS3 or later
- Adobe Photoshop Elements 6 or later
- Adobe Photoshop Lightroom 1 or later

Printing Varieties

In other applications, set **No Color Management**.

Note:

For information on the operating systems supported by each application, visit the distributor's website.

Setting example for Adobe Photoshop CS5

Open the **Print** screen.

Select **Color Management** and then **Document**. Select **Printer Manages Colors** as the **Color Handling** setting, and then click **Print**.

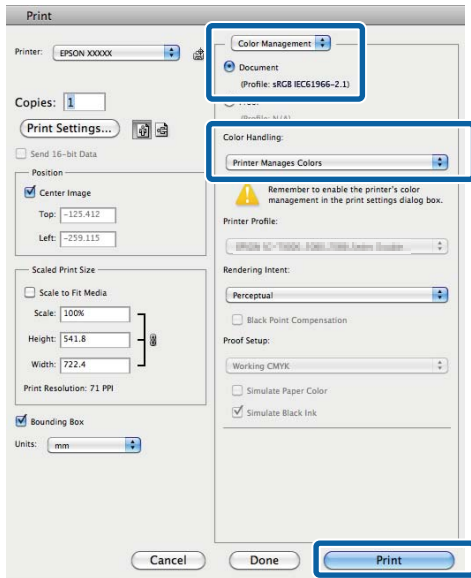

2 Display the Print screen, select **Print Settings** from the list, and then select **Advanced B&W Photo** as the **Color**.

☞ “Basic Printing Methods(Mac OS X)” on page 33

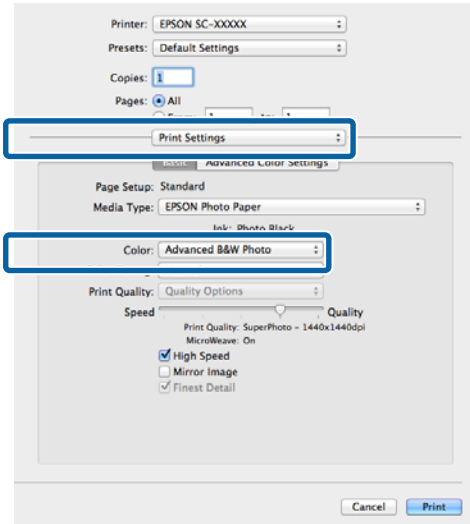

3 Click **Advanced Color Settings**.

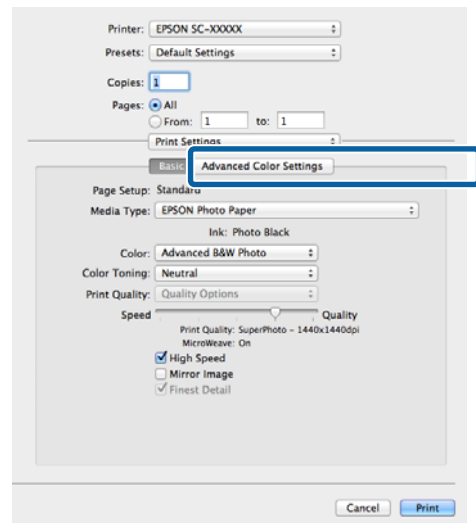

Printing Varieties

4 Make the necessary settings.

See the printer driver help for more details on each item.

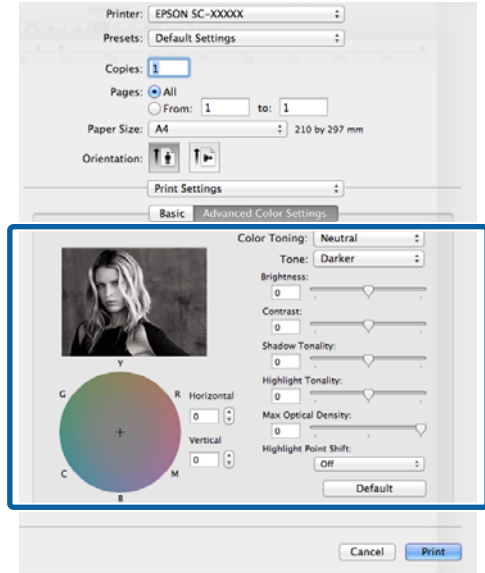

5 Check other settings, and then start printing.

Borderless printing

You can print your data without margins on the paper.

The types of borderless printing you can choose vary as shown below depending on the media type.

Cut sheets: No margins for all edges

Roll paper: No margins for the left and right

When performing left and right borderless printing, margins appear on the top and bottom of the paper.

Values for top and bottom margins  [“Printable area” on page 34](#)

Borderless printing is not available with poster board or CDs and DVDs.

Types of Borderless Printing Methods

Two options are available for borderless printing: Auto Expand and Retain Size.

Choose either option when printing on cut sheets. Settings for roll paper are automatically adjusted as follows.

- Roll paper: Auto Expand
- Roll paper (banner): Retain Size (Windows only)

Auto Expand

The printer driver enlarges the print data to a size slightly larger than the paper size and prints the enlarged image. The sections which are beyond the paper edges are not printed; therefore, resulting in borderless printing.

Use settings such as Page Layout in the applications to set the size of the image data as follows.

- Match the paper size and page setting for the print data.
- If the application has margin settings, set the margins to 0 mm.

Printing Varieties

- Make the image data as large as the paper size.

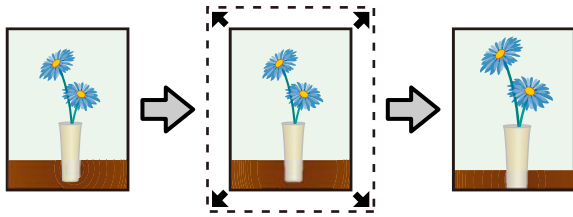

Retain Size

Create the print data larger than the paper size in the applications to produce borderless output. The printer driver does not enlarge the image data. Use settings such as Page Layout in the applications to set the size of the image data as follows.

- Print data is created so that 5 mm (a total of 10 mm) extends in all directions beyond the actual paper size.
- If the application has margin settings, set the margins to 0 mm.
- Make the image data as large as the paper size.
- There is no need to increase the top and bottom sizes for roll paper.

Select this setting if you want to avoid image enlargement by the printer driver.

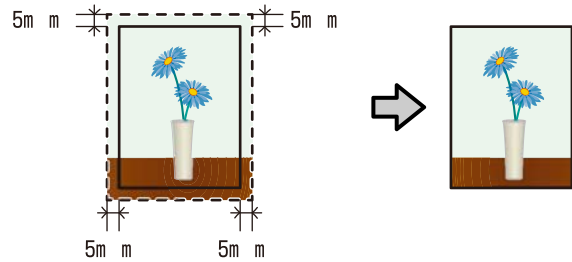

Supported Media Sizes for Borderless Printing

The following media sizes are supported for borderless printing.

Supported paper sizes
A4 (210 × 297 mm)
A3 (297 × 420 mm)
A3+ (329 × 483 mm)
Letter (8½ × 11 in.)
100 × 148 mm
9 × 13 cm (3.5 × 5 in.)
10 × 15 cm (4 × 6 in.)
13 × 18 cm (5 × 7 in.)

Printing Varieties

Supported paper sizes
13 × 20 cm (5 × 8 in.)
16:9 wide (102 × 181 mm)
20 × 25 cm (8 × 10 in.)
254 × 305 mm (10 × 12 in.)
279 × 356 mm (11 × 14 in.)
US B 11 × 17 in.
30 × 30 cm (12 × 12 in.)
A3+ roll paper (329 mm wide)

Depending on the media type, the print quality may decline or borderless printing cannot be selected.

 [“Epson Special Media Table” on page 111](#)

Setting Procedures for Printing

Adjusting Settings in Windows

1 When the printer driver's **Main** screen is displayed, you can configure various settings required for printing such as **Media Type**, **Source**, **Size**.

 [“Basic Printing Methods\(Windows\)” on page 31](#)

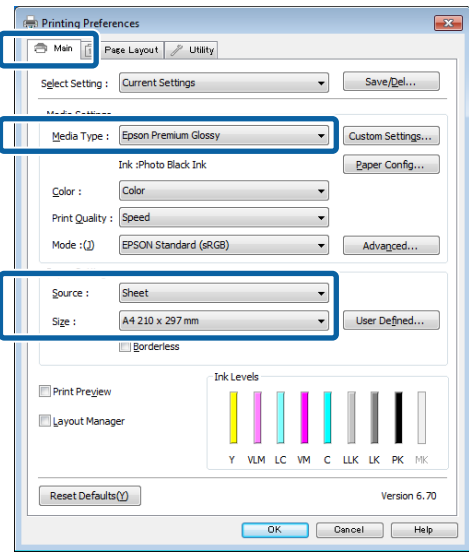

2 Select **Borderless**, and then click **Expansion**.

You can not choose the expansion amount when **Roll Paper** or **Roll Paper (Banner)** is selected for **Source**.

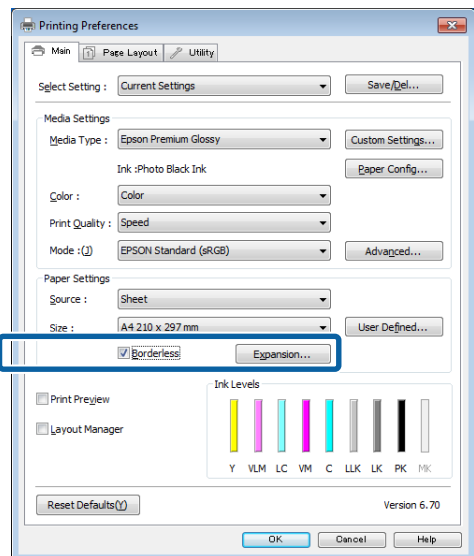

Printing Varieties

3 Select **Auto Expand** or **Retain Size** as the **Method of Enlargement**. If you select **Auto Expand**, set how much of the image goes beyond the edge of the paper as shown below.

Max	<p>Sizes larger than A4: Approximately 3 mm past the top, 4.5 mm past the bottom, and 3.5 mm past the left and right edges A4 or smaller (excluding 100 × 148 mm, 9 × 13 cm/3.5 × 5 in., 10 × 15 cm/4 × 6 in.): Approximately 3 mm past the top, 4 mm past the bottom, and 2.5 mm past the left and right edges 100 × 148 mm, 9 × 13 cm/3.5 × 5 in., 10 × 15 cm/4 × 6 in.: Approximately 1.3 mm past the top, 2.5 mm past the bottom, and 2.5 mm past the left and right edges</p>
Mid	½ of Max
Min	½ of Max

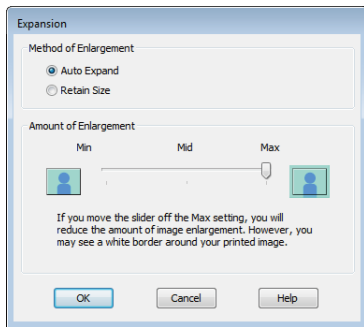

Note:
 Choosing **Mid** or **Min** decreases the image enlargement ratio. Therefore, some margins may appear at the edges of the paper depending on the paper and printing environment.

4 Check other settings, and then start printing.

Making Settings for Mac OS X

1 Open the Print screen and select the paper size from the **Paper Size** option, and then select a borderless printing method.

[“Basic Printing Methods\(Mac OS X\)” on page 33](#)

The selections for borderless printing methods are displayed as shown below.

XXXX (Sheet Feeder - Borderless (Auto Expand))

XXXX (Sheet Feeder - Borderless (Retain Size))

XXXX (Fr.-FineArt(Borderless, Auto Expand))

XXXX (Fr.-FineArt(Borderless, Retain Size))

A3+ (Roll Paper - Borderless)

Where XXXX is the actual paper size, such as A4.

If items on the Page Setup screen are not displayed on the Print screen due to the application being used, display the Page Setup screen and make settings.

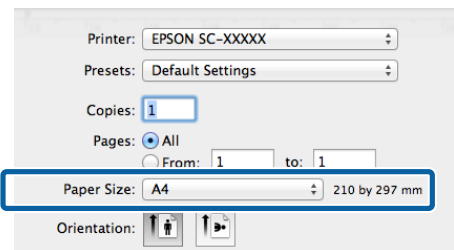

2 If Auto Expand is selected for **Paper Size**, set how much of the image goes beyond the edge of the paper in the **Expansion** screen.

Select **Page Layout Settings** from the list. The following shows how much the image will be larger than the paper edges.

Max	<p>Sizes larger than A4: Approximately 3 mm past the top, 4.5 mm past the bottom, and 3.5 mm past the left and right edges A4 or smaller (excluding 100 × 148 mm, 9 × 13 cm/3.5 × 5 in., 10 × 15 cm/4 × 6 in.): Approximately 3 mm past the top, 4 mm past the bottom, and 2.5 mm past the left and right edges 100 × 148 mm, 9 × 13 cm/3.5 × 5 in., 10 × 15 cm/4 × 6 in.: Approximately 1.3 mm past the top, 2.5 mm past the bottom, and 2.5 mm past the left and right edges</p>
-----	---

Printing Varieties

Mid	½ of Max
Min	½ of Max

4 Check other settings, and then start printing.

You cannot choose the expansion amount when **A3+ (Roll Paper - Borderless)** is selected as the **Paper Size**.

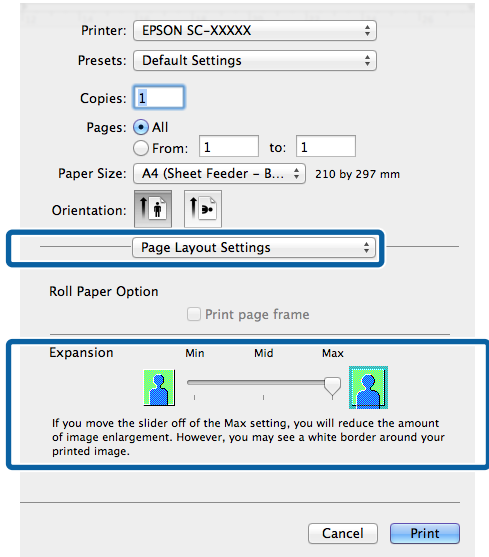

Note:
 Choosing *Mid* or *Min* decreases the image enlargement ratio. Therefore, some margins may appear at the edges of the paper depending on the paper and printing environment.

3 Select **Print Settings** from the list, and then set the **Media Type**.

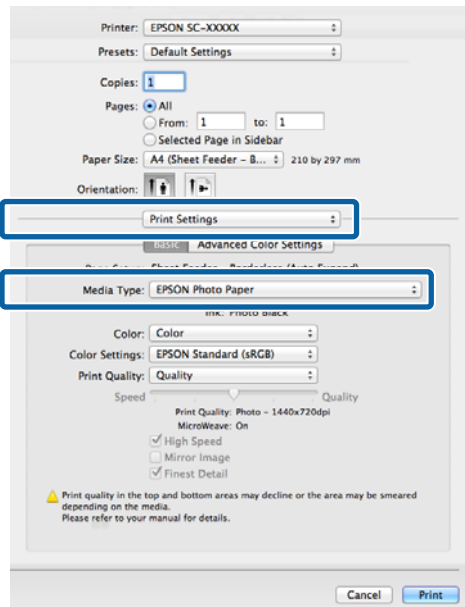

Printing Varieties

Enlarged/Reduced Printing

You can enlarge or reduce the size of your data. There are three setting methods.

Fit to Page printing

Automatically enlarges or reduces the image to fit the paper.

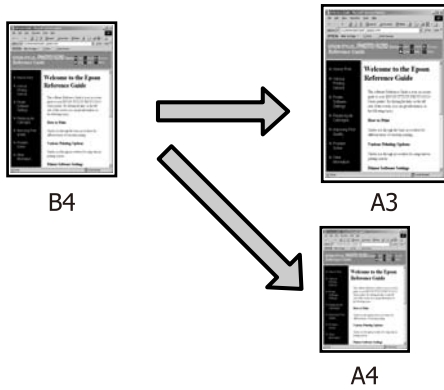

Fit to Roll Paper Width (Windows only)

Automatically enlarges or reduces the image to fit the width of the roll paper.

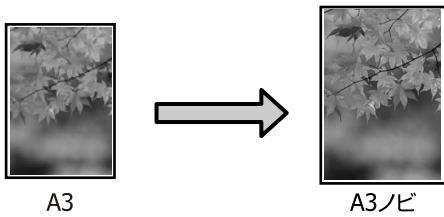

Custom

You can specify the enlargement or reduction ratio. Use this method for a non-standard paper size.

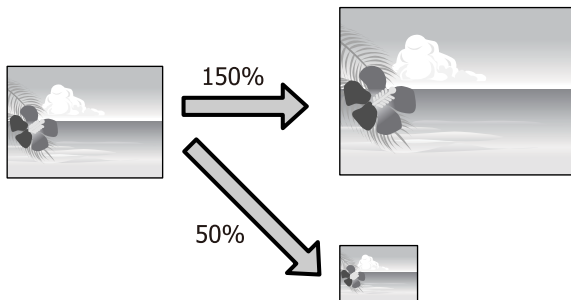

Fit to Page/Scale to fit paper size

Adjusting Settings in Windows

1 When the printer driver's Page Layout screen is displayed, set the same paper size as the data's paper size in Page Size or Paper Size.

“Basic Printing Methods(Windows)” on page 31

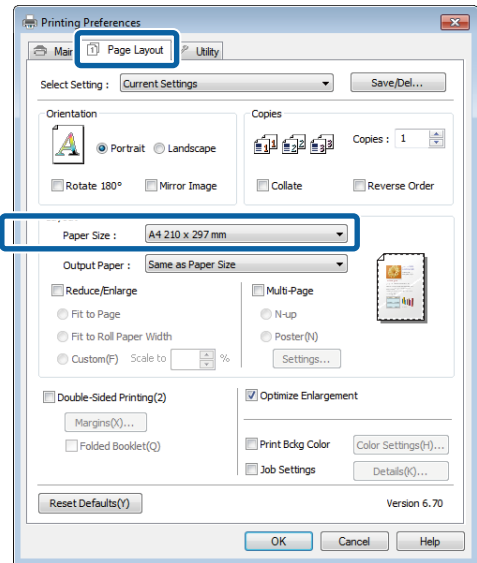

2 Select the size of the paper loaded in the printer from the Output Paper list.

Fit to Page is selected as **Reduce/Enlarge**.

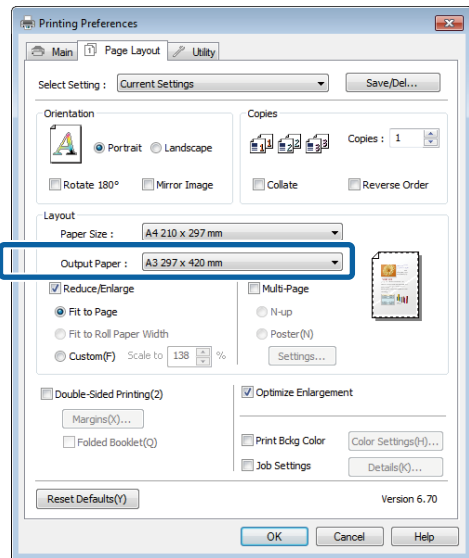

3 Check other settings, and then start printing.

Printing Varieties

Making Settings for Mac OS X

- 1 Open the Print screen, select **Paper Handling** from the list, and then check **Scale to fit paper size**.

 [“Basic Printing Methods\(Mac OS X\)” on page 33](#)

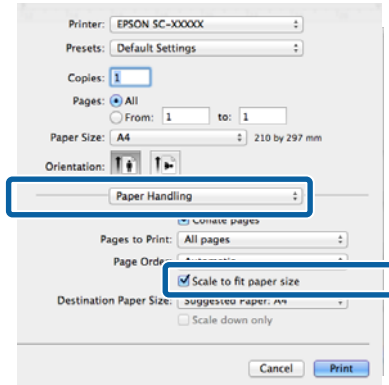

- 2 Select the size of the paper loaded in the printer as the **Destination Paper Size**.

Note:
When performing enlarged printing, clear the **Scale down only** check box.

- 3 Check other settings, and then start printing.

Fit to Roll Paper Width (Windows only)

- 1 Display the printer driver **Main** tab and select **Roll Paper** for **Source**.

 [“Basic Printing Methods\(Windows\)” on page 31](#)

- 2 Display the **Page Layout** tab and choose a **Paper Size** that matches the page size used in the document size.

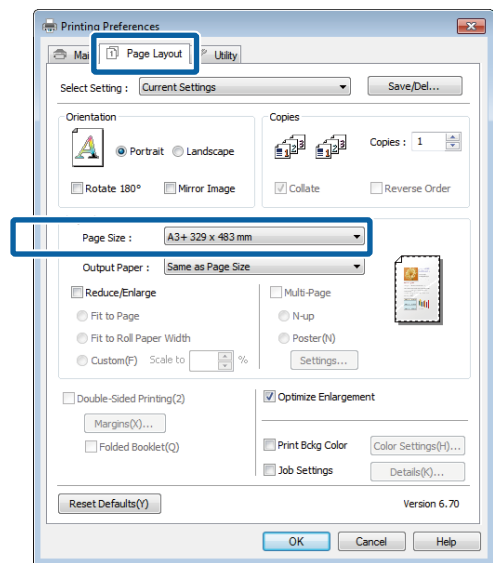

- 3 Select **Reduce/Enlarge** and click **Fit to Roll Paper Width**.

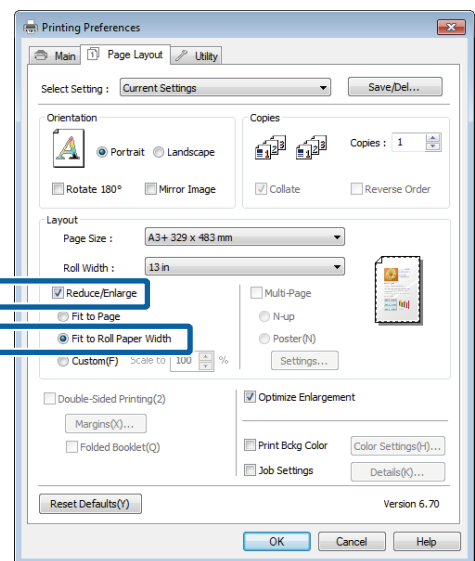

Printing Varieties

- 4 Select the width of the roll paper loaded in the printer from the **Roll Width** list.

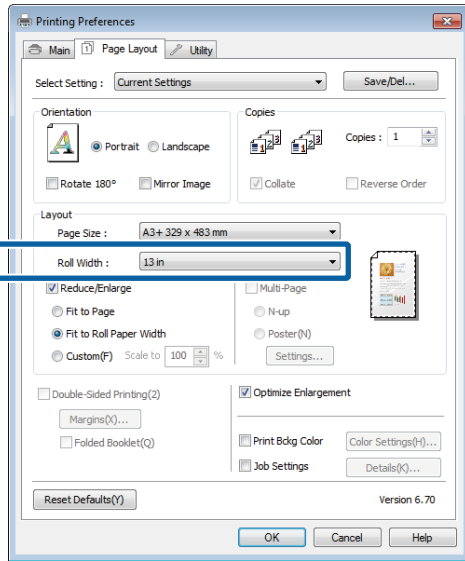

- 5 Check other settings, and then start printing.

Custom Scale Setting

Adjusting Settings in Windows

- 1 When the printer driver's **Page Layout** screen is displayed, set the same paper size as the data's paper size in **Page Size** or **Paper Size**.

[“Basic Printing Methods\(Windows\)” on page 31](#)

- 2 Select the **Output Paper** option that matches the size of paper loaded in the printer.

- 3 Select **Reduce/Enlarge**, click **Custom**, and then set the **Scale to** value.

Enter a value directly or click the arrows to the right of the scale box to set the value.

Select the scale within a range of 10 to 650 %.

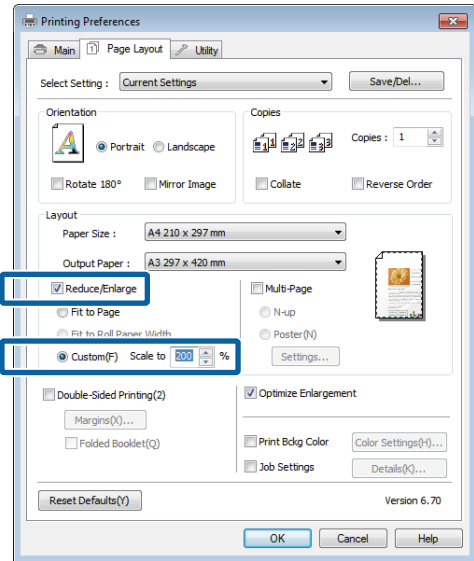

- 4 Check other settings, and then start printing.

Making Settings for Mac OS X

- 1 When the Print screen is displayed, select the size of the paper loaded in the printer from the **Paper Size** list.

If items on the Page Setup screen are not displayed on the Print screen due to the application being used, display the Page Setup screen and make settings.

[“Basic Printing Methods\(Mac OS X\)” on page 33](#)

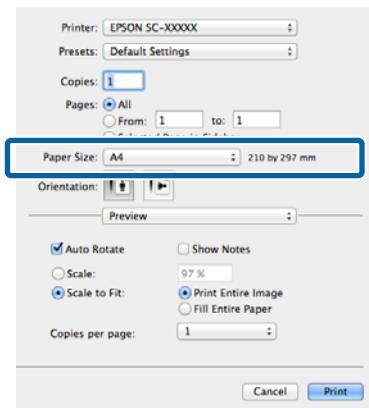

Printing Varieties

2 Enter the scale.

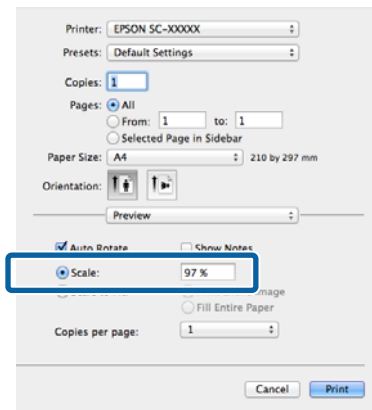

Multi-Page Printing

You can print multiple pages of your document on one sheet of paper.

If you print continuous data prepared at A4 size, it is printed as shown below.

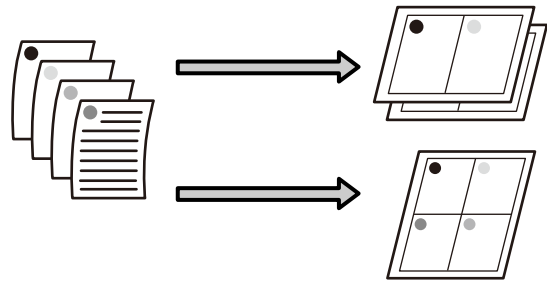

Note:

- ❑ In Windows, you cannot use the Multi-Page printing function when performing borderless printing.
- ❑ In Windows, you can use the reduce/enlarge function (Fit to Page) to print the data on different sizes of paper.

["Enlarged/Reduced Printing" on page 63](#)

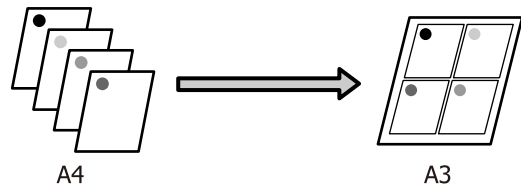

Printing Varieties

Adjusting Settings in Windows

- 1 When the printer driver's **Page Layout** screen is displayed, select the **Multi-Page** check box, select **N-up**, and then click **Settings**.

“Basic Printing Methods(Windows)” on page 31

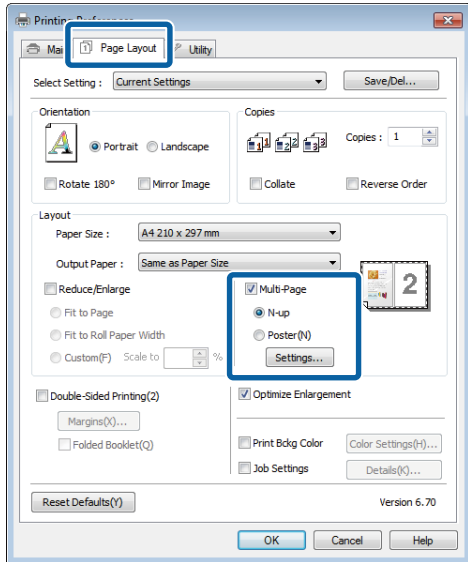

- 2 In the **Print Layout** screen, specify the number of pages per sheet and the page order.

If the **Print page frames** check box is selected, page frames are printed on each page.

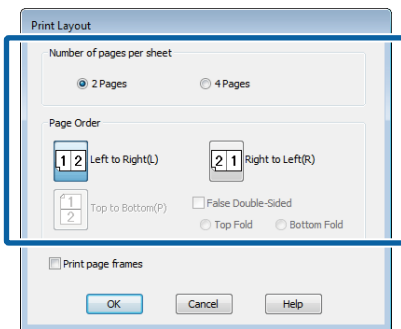

- 3 Check other settings, and then start printing.

Making Settings for Mac OS X

- 1 When the Print screen is displayed, select **Layout** from the list, and then specify the number of pages per sheet and so on.

“Basic Printing Methods(Mac OS X)” on page 33

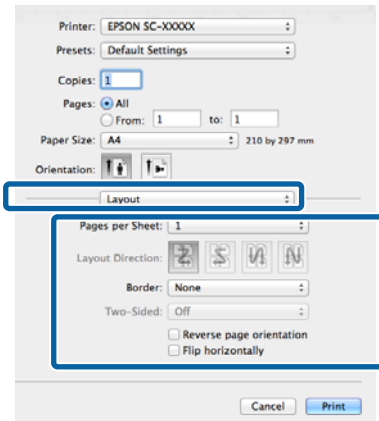

Note:
You can print frames around arranged pages using the **Border** function.

- 2 Check other settings, and then start printing.

Printing Varieties

Manual Double-Sided Printing (Windows only)

You can easily print on both sides of the paper by printing out all even numbered pages and then flipping those pages over and reloading them manually to print the odd numbered pages.

Cautions when Performing Double-Sided Printing

When performing double-sided printing, note the following points.

- Use paper that supports double-sided printing.
- Depending on the paper type and the print data, ink may seep through to the back side of the paper.
- Double-sided printing is supported with the auto sheet feeder only.
- Performing successive double-sided print jobs can soil the inside of the printer with ink. If the printed paper is soiled by ink on the roller, clean the printer.

Note:

You can save even more paper by combining this printing method with printing multiple pages on a single page.

[“Multi-Page Printing” on page 66](#)

Setting Procedures for Printing

- 1** Load paper in the auto sheet feeder.
[“Loading Paper into the Auto Sheet Feeder” on page 22](#)
- 2** When the printer driver's **Page Layout** screen is displayed, select **Double-Sided Printing**.

When **Roll Paper** is selected as the **Source** setting, you cannot select **Double-Sided Printing**. In this case, set the **Source** first from the **Main** screen.

[“Basic Printing Methods\(Windows\)” on page 31](#)

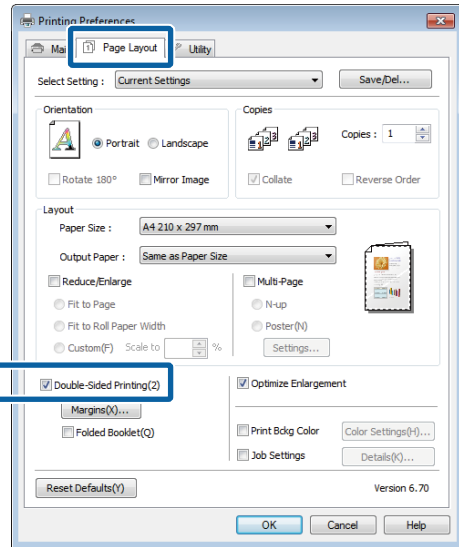

Note:

- You can set the **Binding Edge** and **Binding Margin** by clicking on **Margins**. Depending on the application, the specified binding margin and the actual print result may differ.

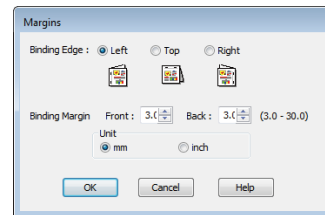

- Select **Folded Booklet** to print out as a booklet. In the example figure shown below, the pages that appear on the inside when the page is folded in two (pages 2, 3, 6, 7, 10, 11) are printed first.

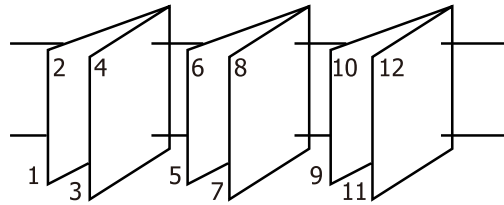

- 3** Check other settings, and then start printing.
- 4** When the odd pages have finished printing and the on-screen guide appears, reload the paper as instructed, and then click **Resume**.

Printing Varieties

Poster Printing (Enlarge to cover several sheets and print - Windows only)

The poster printing function automatically enlarges and divides the print data. You can join the printed sheets to create a large poster or calendar. Poster printing is available up to 16-fold (four sheets by four sheets) of normal printing size. There are two ways to print posters.

Borderless poster printing

This automatically enlarges and divides the print data and prints without margins. You can make a poster just by joining the output paper together. To perform borderless printing, the data is expanded so that it extends slightly over the paper size. Enlarged areas that exceed the paper are not printed. Therefore, the image may misalign at the joins. To join the pages precisely, perform the following poster printing with margins.

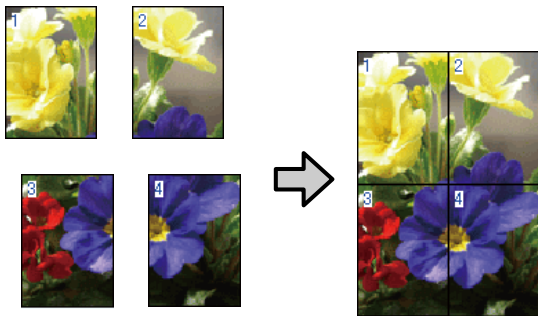

Poster printing with margins

This automatically enlarges and divides the print data and prints with margins. You need to cut the margins and then join the output paper together to make a poster. Although the final size is slightly smaller since you have to cut off the margins, the image joins fit precisely.

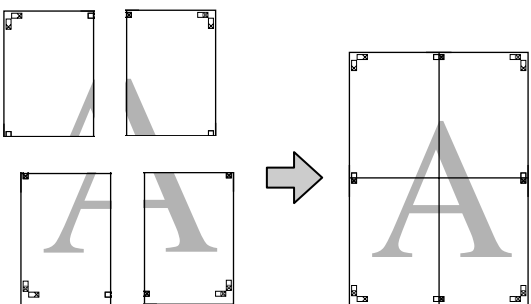

Setting Procedures for Printing

- 1 Prepare the print data using applications.
The printer driver automatically enlarges the image data when printing.
- 2 When the printer driver's **Page Layout** screen is displayed, select the **Multi-Page** check box, select **Poster**, and then click **Settings**.

➤ “Basic Printing Methods(Windows)” on page 31

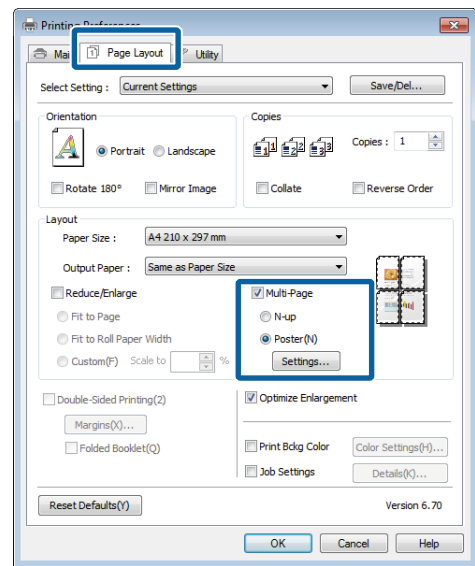

- 3 In the **Poster Settings** screen, select the number of pages you want in the poster.

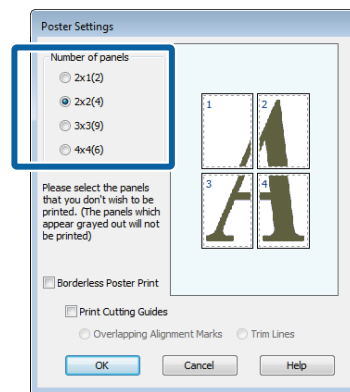

Printing Varieties

4 Select borderless poster printing or poster printing with margins, and then select any pages that you do not want to print.

When borderless is selected:
Select **Borderless Poster Print**.

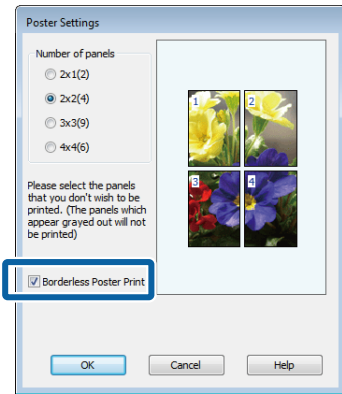

Note:
If **Borderless Poster Print** is grayed out, the selected paper or the size does not support borderless printing.

[Supported Media Sizes for Borderless Printing](#) on page 59

[Epson Special Media Table](#) on page 111

When with margins is selected:
Clear **Borderless Poster Print**.

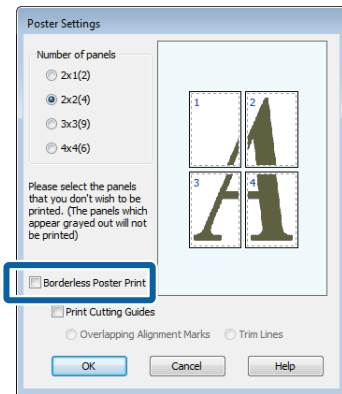

Note:
Regarding the size after joining together:
When **Borderless Poster Print** is cleared and printing with margins is selected, the **Print Cutting Guides** items are displayed.
The finished size is the same whether or not **Trim Lines** is selected. However, if **Overlapping Alignment Marks** is selected, the finished size is smaller with an overlap.

5 Check other settings, and then start printing.

Printing Varieties

Joining the output paper together

The steps for joining the output paper together differ between borderless poster printing and poster printing with margins.

Borderless poster printing

This section describes how to join four printed pages together. Check and match the printed pages, and join them in the order indicated below using an adhesive tape on the back of the sheets.

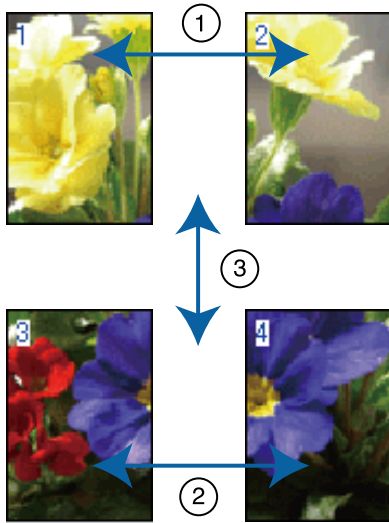

Poster printing with margins

When you select **Overlapping Alignment Marks**, the following marks are printed on the paper. See the procedures below to join the four printed pages together using the alignment marks.

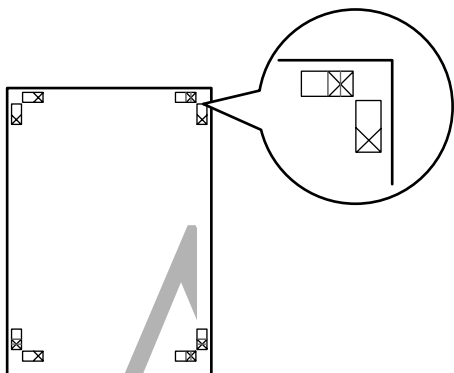

Note:
The alignment marks are black for black-and-white printing.

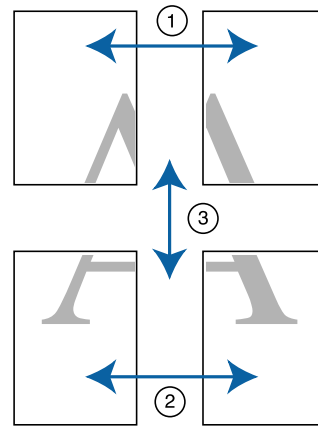

The following describes how to join four printed pages together.

- 1 Cut the upper left sheet along the alignment mark (vertical blue line).

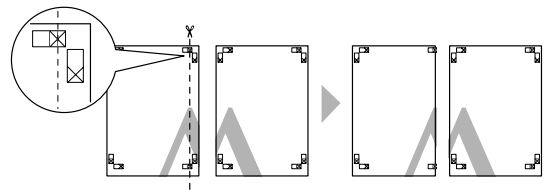

- 2 Lay the upper left sheet on top of upper right sheet. Line up the X marks as shown in the illustration below, and temporarily fasten them using an adhesive tape on the back.

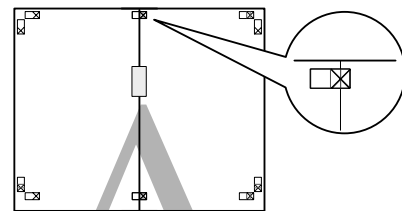

- 3 While two pages are overlapping, cut them along the alignment mark (vertical red line).

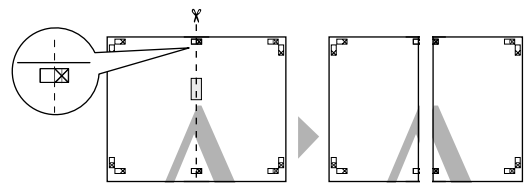

Printing Varieties

- 4** Join the left and right sheets together.
Use an adhesive tape to stick the backs of the sheets together.

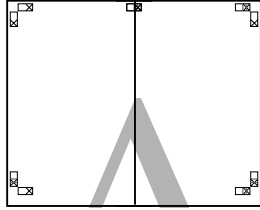

- 5** Repeat steps 1 to 4 for the lower sheets.

- 6** Cut the bottom of the upper sheets along the alignment marks (horizontal blue line).

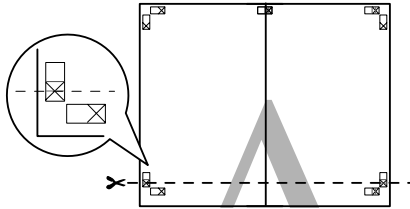

- 7** Lay the upper sheet on top of the lower sheet. Lineup the X marks as shown in the illustration below, and temporarily fasten them using an adhesive tape on the back.

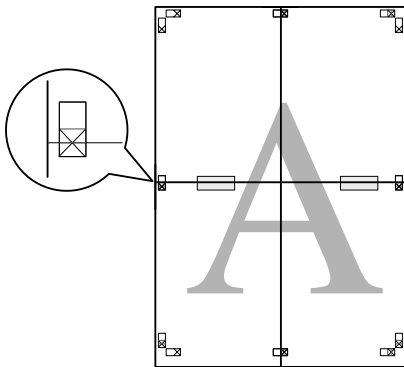

- 8** While two pages are overlapping, cut them along the alignment marks (horizontal red line).

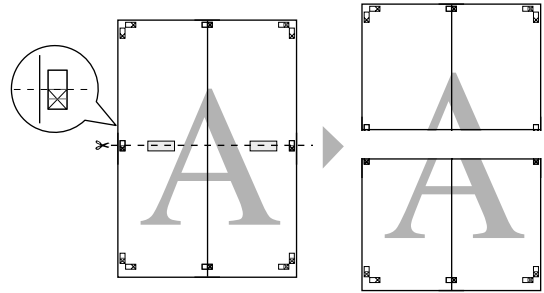

- 9** Join the upper and lower sheets together.

- Use an adhesive tape to stick the backs of the sheets together.

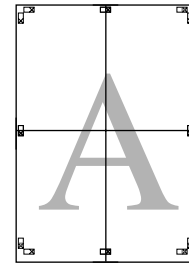

- 10** After joining all of the sheets together, cut the margins along the outer guide lines.

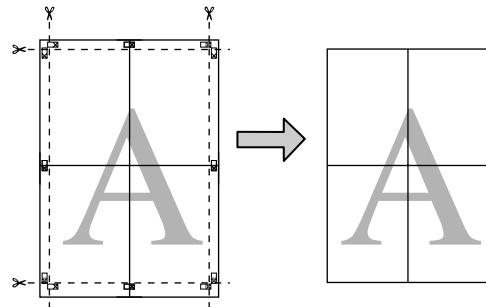

Printing Varieties

User-defined Paper Sizes/ Custom Paper Sizes

You can also print on paper sizes that are not already available in the printer driver. User-defined paper sizes that have created and saved as described below can be selected using the application page setup option. If your application supports creating user defined sizes, follow the steps below to select the same size that was created in the application, and then print.

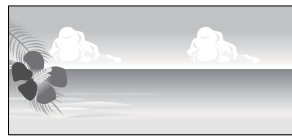

See the following for information on the paper sizes supported by this printer.

[“Usable Commercially Papers” on page 113](#)

In addition, the following paper sizes can be selected for **User Defined Paper Size (Windows)** or **Custom Paper Sizes (Mac OS X)** in the printer driver.

Important:

- Although you can specify a large paper size which cannot be loaded on this printer, it will not be printed properly.
- The available output size is limited depending on the application.

Auto sheet feeder

Width	89.0 to 329.0 mm
Length	89.0 to 3276.7*1 mm

Roll paper*2

Width	329.0 mm
Length	55.0 to 3276.7*1 mm

Front manual feed (poster board)/front manual feed (fine art media)

Width	210.0 to 329.0 mm
-------	-------------------

Length	279.4 to 3276.7*1 mm
--------	----------------------

- 1 The maximum length in Mac OS X is 1117.6 mm.
- 2 The length can be longer than the maximum length specified if the application supports banner printing. However, the actual print size depends on the application, the paper size loaded in the printer, and the computer environment.

Adjusting Settings in Windows

- 1** When the printer driver's **Main** screen is displayed, click **User Defined**.

[“Basic Printing Methods\(Windows\)” on page 31](#)

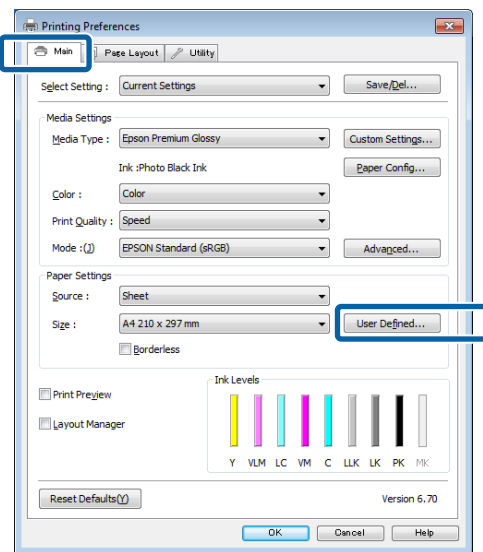

- 2** In the **User Defined Paper Size** screen, set the paper size you want to use, and then click **Save**.

- You can enter up to 24 single-byte characters for the **Paper Size Name**.
- The length and width values for a pre-defined size close to the desired custom size can be displayed by selecting the appropriate option in the **Base Paper Size** menu.

Printing Varieties

- If the length and width ratio is the same as a defined paper size, select the defined paper size from **Fix Aspect Ratio** and select either **Landscape** or **Portrait** for the **Base**. In this case, you can only adjust either the paper width or paper height.

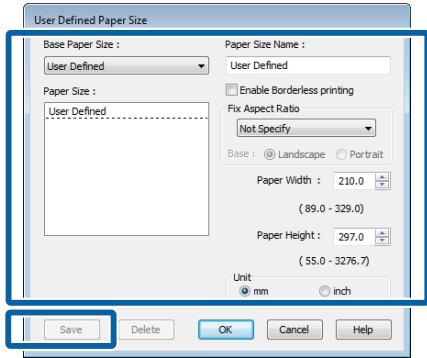

Note:

- To change the paper size you saved, select the paper size name from the list on the left.
- To delete the user-defined size you saved, select the paper size name from the list on the left, and then click **Delete**.
- You can save up to 100 paper sizes.

3 Click **OK**.

You can now select the new paper size from the **Size** menu in the **Main** tab.

You can now print as normal.

Making Settings for Mac OS X

1 When the Print screen is displayed, select **Manage Custom Sizes** from the **Paper Size** list.

If items on the Page Setup screen are not displayed on the Print screen due to the application being used, display the Page Setup screen and make settings.

☞ “Basic Printing Methods(Mac OS X)” on page 33

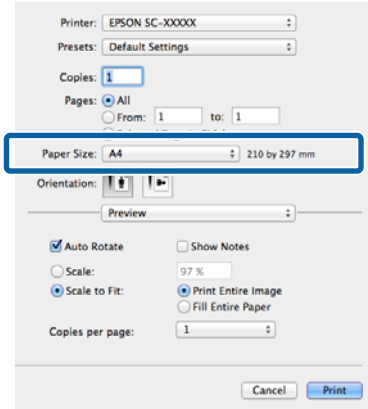

2 Click **+**, and then enter the paper size name.

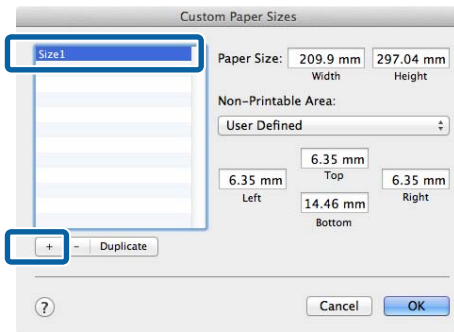

3 Enter the **Width**, **Height** for the **Paper Size**, and enter the margins, and then click **OK**.

You can set the page size and printer margins depending on the printing method.

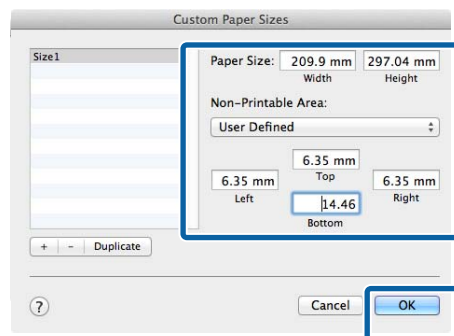

Printing Varieties

Note:

- ❑ To change the contents that you saved, select the paper size name from the list on the left of the **Custom Paper Sizes** screen.
- ❑ To duplicate the user-defined size you saved, select the paper size name from the list on the left of the **Custom Paper Sizes** screen, and then click **Duplicate**.
- ❑ To delete the user-defined size you saved, select the paper size name from the list on the left of the **Custom Paper Sizes** screen, and then click **-**.
- ❑ The custom paper size setting differs depending on the operating system version. See your operating system's documentation for details.

4 Click **OK**.

You can select the paper size you saved from the Paper Size pop-up menu.

5 Open the **Paper Size** menu and select the paper size saved using the **Custom Paper Size** dialog. Select **Print Settings** and choose a paper source in the **Page Layout** menu.

The paper sources available depend on the page size.

You can now print as normal.

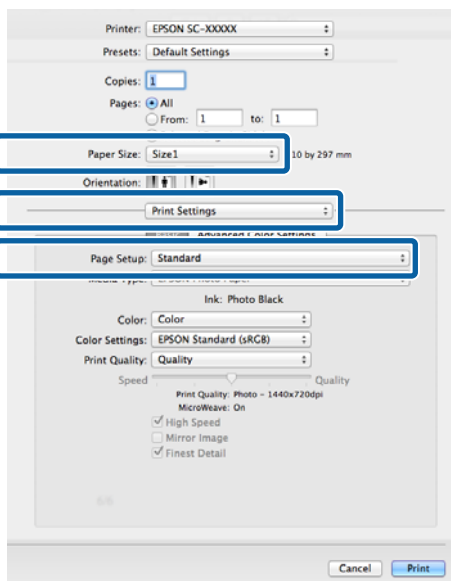

Banner printing (on roll paper)

You can print banners and panoramic pictures if you create and set print data for banner printing in your application.

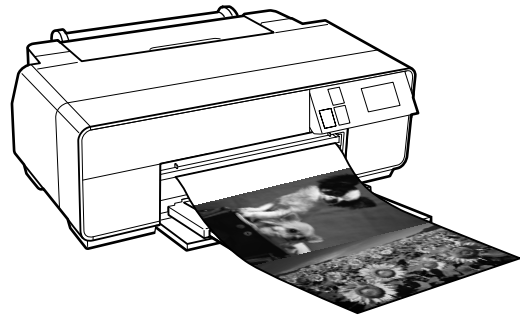

There are two ways to print a banner.

Printer Driver Source	Supported Applications
Roll paper	Document preparation software, image editing software, and so on*1
Roll paper (Banner)*2	Applications that support banner printing

*1 Create print data at a size supported by the given application while maintaining the printing length and width ratio.

*2 Windows only

The following printing sizes are available.

Available Media Sizes	
Width	329.0 mm
Length*	Windows: Max. 3,276.7 mm Mac OS X: Max. 1,117.6 mm

* The paper length can be longer if using applications that support banner printing. However, the actual print size depends on the application, the paper size loaded in the printer, and the computer environment.

Printing Varieties

Adjusting Settings in Windows

1 In the printer driver's **Main** screen, select **Media Type**.

☞ “Basic Printing Methods(Windows)” on page 31

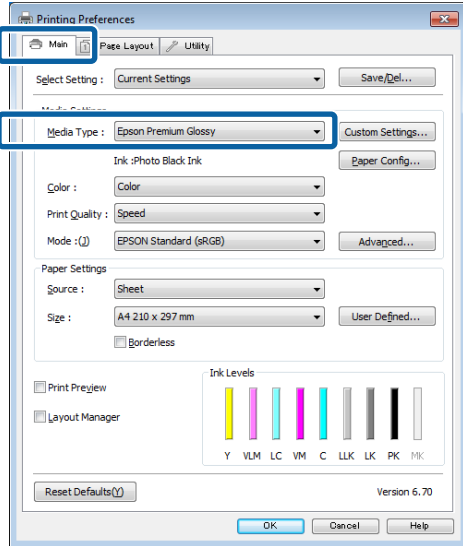

2 Select **Roll Paper** or **Roll Paper (Banner)** from the **Source** list.

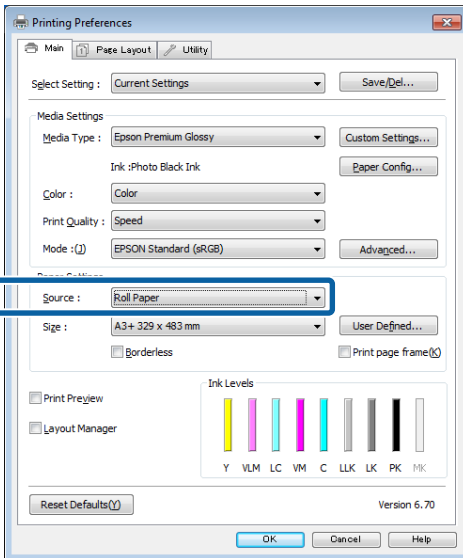

Note:

- ❑ You can only use **Roll Paper (Banner)** for applications that support banner printing.
- ❑ Selecting **Roll Paper (Banner)** sets the top and bottom margins of the paper to 0 mm.

3 Click **User Defined** and match the paper size to the size of the data if necessary.

Note:
If you are using applications that support banner printing, you do not need to set **User Defined Paper Size** if you select **Roll Paper (Banner)** as the **Source**.

4 Make sure the **Optimize Enlargement** check box is selected.

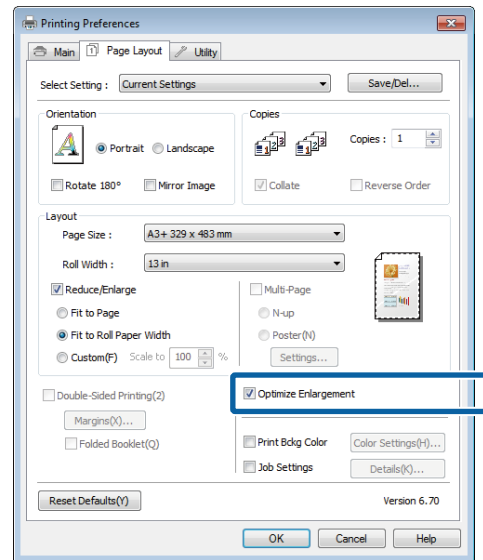

5 Check other settings, and then start printing.

Making Settings for Mac OS X

1 When the Print screen is displayed, select the size of the data created with the application in **Paper Size**.

If items on the Page Setup screen are not displayed on the Print screen due to the application being used, display the Page Setup screen and make settings.

Printing Varieties

☞ “Basic Printing Methods(Mac OS X)” on page 33

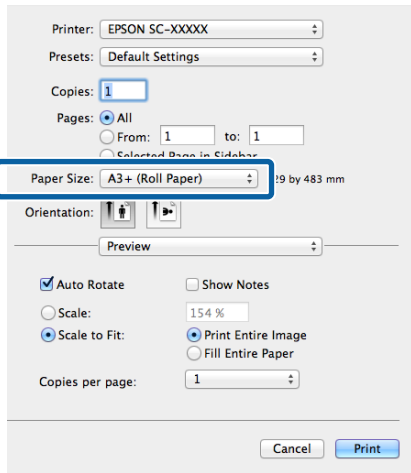

2 Check other settings, and then start printing.

Layout Manager (Windows only)

The Layout Manager function allows you to place multiple pieces of print data created in different applications on the paper freely and print them at once.

You can create a poster or display material by placing multiple pieces of print data where you like. Also, Layout Manager allows you to use paper effectively.

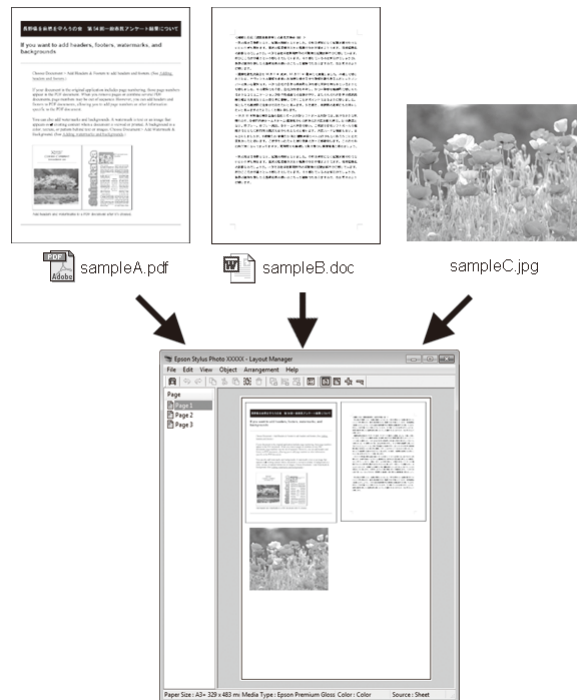

The following is a layout example.

Placing multiple data items

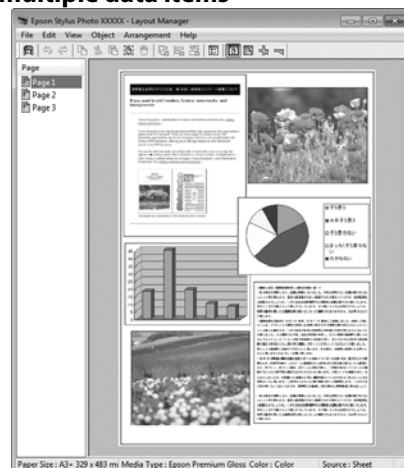

Printing Varieties

Placing the same data

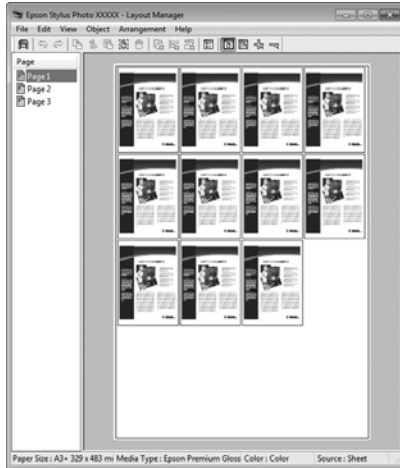

Placing data freely

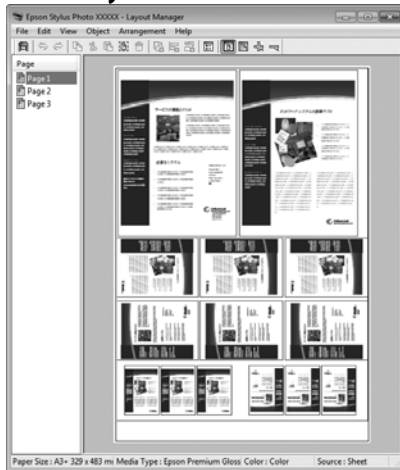

Placing data on roll paper

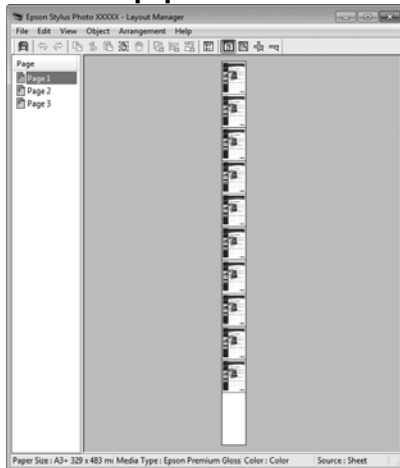

2

Open the file you want to print in your application.

3

Select **Layout Manager** in the **Main** tab of the printer driver and choose an option for **Size** that matches the size of the document created in the application.

“Basic Printing Methods(Windows)” on page 31

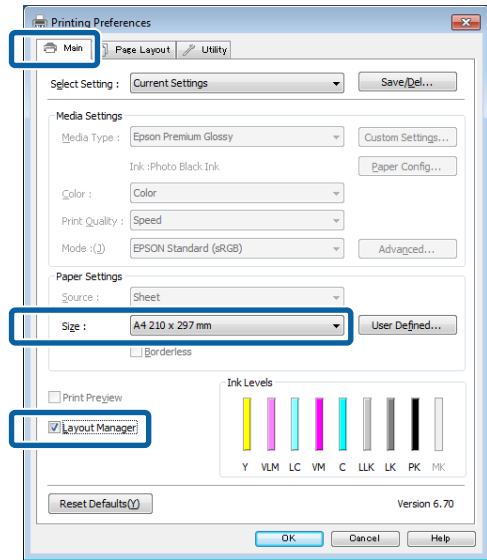

Note:

The option selected for **Size** is the size used in the **Layout Manager**. The actual printing paper size is set in the screen in step 7.

4

Click **OK**. When printing with an application, the **Layout Manager** screen opens.

The print data is not printed, but one page is placed on the paper of the **Layout Manager** screen as one object.

5

Leave the **Layout Manager** screen open and repeat steps 2 to 4 to arrange the next pieces of data.

The objects are added to the **Layout Manager** screen.

Setting Procedures for Printing

1 Check that the printer is connected and ready to print.

Printing Varieties

- 6 Arrange the objects on the **Layout Manager** screen.

You can drag objects to move and resize them, use tool buttons and the **Object** menu to align and rotate objects on the **Layout Manager** screen.

You can resize and replace whole objects in the Preference or Arrangement Settings screens.

See the **Layout Manager** screen help for more details on each function.

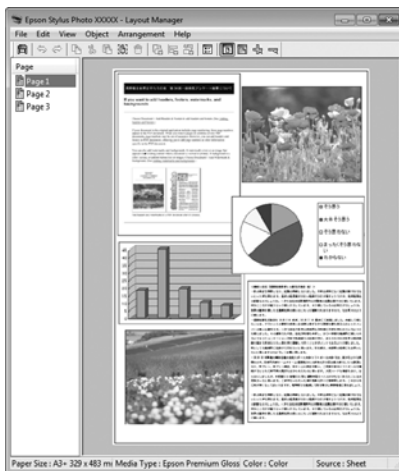

- 7 Click **File - Properties**, and make print settings on the printer driver screen.

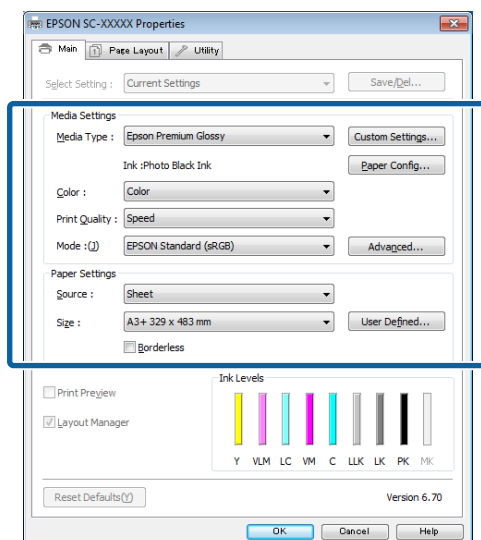

Set **Media Type**, **Source**, **Size**, and so on.

- 8 Click the **File** menu on the **Layout Manager** screen, and then click **Print**.

Printing starts.

Saving and Calling Layout Manager Settings

You can save the **Layout Manager** screen arrangement and setting contents to a file. If you need to close your application in the middle of a job, you can save it to a file and then open it later to continue your work.

Saving

- 1 On the **Layout Manager** screen, click **File** menu and then **Save as**.
- 2 Enter the file name, select the location, and then click **Save**.
- 3 Close the **Layout Manager** screen.

Opening saved files

- 1 Right-click the utility icon () in the Windows taskbar and select **Layout Manager** from the menu that is displayed.

The **Layout Manager** screen is displayed.

If the utility icon does not appear in the Windows taskbar [☞ “Summary of the Utility Tab” on page 44](#)

- 2 On the **Layout Manager** screen, click **File** menu and then **Open**.
- 3 Select the location and open the required file.

Printing Varieties

Printing from a Smart Device

Using Epson iPrint

Epson iPrint is an application that allows you to print photos, Web pages, documents, and so on from smart devices such as smart phones and tablets.



You can install Epson iPrint on your smart device using the following URL or QR code.

<http://iپر.to/d>



Using Epson iPrint

Launch Epson iPrint on your smart device, and then select the item you want to use from the following Home screen.

The following screen may change without notice.

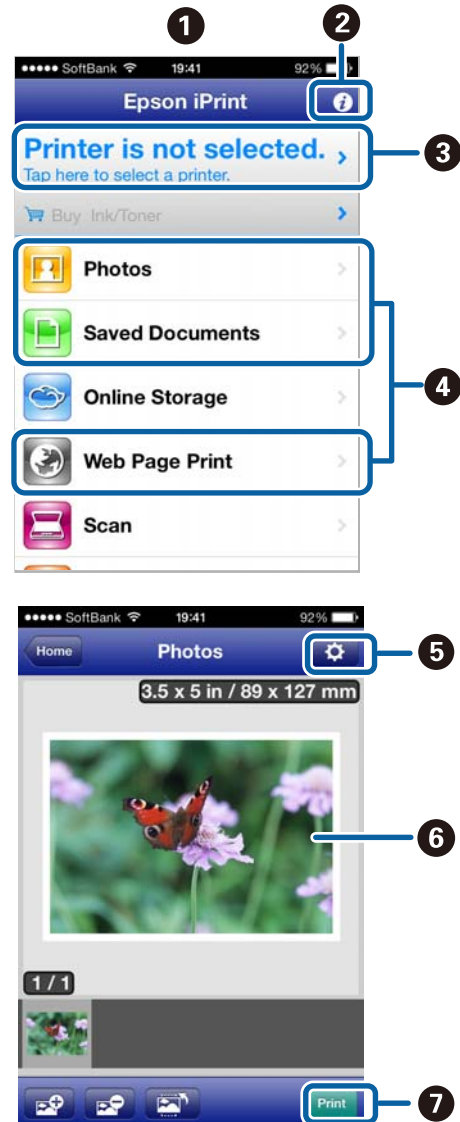

1	Home screen displayed at startup.
2	Displays information pages such as making printer settings and the FAQ.
3	Displays the screen that allows you to select and setup the printer. Once selected, the printer is available the next time the application is launched, without having to select it again.
4	Select the data you want to print such as a photo, a document, or a Web page.
5	The screen where you can make print settings such as the paper size and paper type is displayed.

Printing Varieties

6	The selected photos or documents are displayed.
7	Printing starts.

Note:

When printing from the document menu in iPhone, iPad, or iPod touch, send the document you want to print using the iTunes file sharing function, and then launch Epson iPrint.

Using AirPrint

For iOS devices using the latest iOS, or computers later than Mac OS X v10.7.x, you can print wirelessly using this printer.



Note:

- AirPrint is not available when the control panel's setup menu - **System Administration - Paper Setup Display** is set to **Off**.
- For more detailed information on AirPrint, see the AirPrint page on Apple's homepage.

- 1** Connect the device you want to use to the same wireless LAN as the printer.
- 2** Load paper in the printer.
- 3** Print from the device to the printer.

 ["Loading Cut Sheets" on page 22](#)

Color Management Printing

About Color Management

Even when using the same image data, the original image and the displayed image may look different, and the printed results may look different to the image you see on the display. This occurs due to the difference in characteristics when input devices such as scanners and digital cameras capture colors as electronic data, and when output devices such as display screens and printers reproduce colors from the color data. The color management system is a means to adjust differences in color conversion characteristics among input and output devices. As well as applications for image processing, each operating system is equipped with a color management system, such as ICM for Windows and ColorSync for Mac OS X.

In a color management system, a color definition file called a "Profile" is used to perform color matching between devices. (This file is also called an ICC profile.) The profile of an input device is called an input profile (or source profile), and of an output device, such as a printer, is called a printer profile (or output profile). A profile is prepared for each media type in this printer's driver.

The color conversion areas by the input device and the color reproduction area by the output device differ. As a result, there are color areas that do not match even when performing color matching using a profile. In addition to specifying profiles, the color management system also specifies conversion conditions for areas where color matching failed as "intent". The name and type of intent vary depending on the color management system you are using.

You cannot match the colors on the printed results and display by color management between the input device and the printer. To match both colors, you need to perform color management between the input device and the display as well.

Color Management Print Settings

You can perform color management printing using this printer's printer driver in the following two ways.

Choose the best method according to the application you are using, the operating system environment, the aim of the print out and so on.

Setting color management with the applications

This method is for printing from applications that support color management. All color management processes are carried out by the application's color management system. This method is useful when you want to obtain the same color management print results using a common application among different operating system environments.

 ["Setting color management with the applications" on page 83](#)

Setting color management with the printer driver

The printer driver uses the operating system's color management system and carries out all color management processes. You can make color management settings in the printer driver using the following two methods.

Host ICM (Windows)/ColorSync (Mac OS X)

Set when printing from applications that support color management. This is effective in producing similar print results from different applications under the same operating systems.

 ["Color management printing by Host ICM \(Windows\)" on page 84](#)

 ["Color management printing by ColorSync \(Mac OS X\)" on page 85](#)

Driver ICM (Windows only)

This allows you to perform color management printing from applications that do not support color management.

 ["Color management printing by Driver ICM\(Windows only\)" on page 86](#)

Color Management Printing

Setting profiles

Settings for the input profile, printer profile, and intent (matching method) vary between three types of color management printing since their color management engines are used differently. This is because color management usage differs between the engines. Make settings in the printer driver or application as described in the following table.

	Input profile settings	Printer profile settings	Intent settings
Driver ICM (Windows)	Printer Driver	Printer Driver	Printer Driver
Host ICM (Windows)	Application	Printer Driver	Printer Driver
ColorSync (Mac OS X)	Application	Printer Driver	Application
Application	Application	Application	Application

Printer profiles for each paper type that is needed when performing color management are installed with the printer's printer driver. You can select the profile from the printer driver's settings screen.

See the following for detailed information.

[“Color management printing by Driver ICM\(Windows only\)” on page 86](#)

[“Color management printing by Host ICM \(Windows\)” on page 84](#)

[“Color management printing by ColorSync \(Mac OS X\)” on page 85](#)

[“Setting color management with the applications” on page 83](#)

Setting color management with the applications

Print using applications with a color management function. Make the color management settings in the application and disable the printer driver's color adjustment function.

- 1 Make color management settings in the applications.

Setting example for Adobe Photoshop CS5

Open the **Print** screen.

Select **Color Management** and then **Document**. Select **Photoshop Manages Colors** as the **Color Handling** setting, select the **Printer Profile** and the **Rendering Intent**, and then click **Print**.

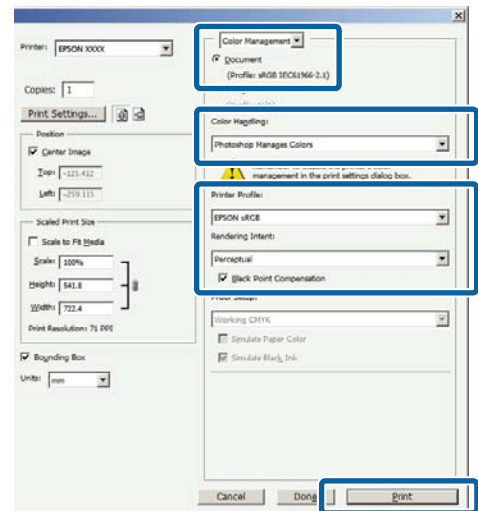

- 2 Display the printer driver's settings screen (Windows) or Print screen (Mac OS X).

Make printer driver settings.

For Windows

[“Basic Printing Methods\(Windows\)” on page 31](#)

For Mac OS X

[“Basic Printing Methods\(Mac OS X\)” on page 33](#)

Color Management Printing

3 Set color management to off.

For Windows

In the **Main** screen, select **Custom** as the **Mode** setting, and select **Off (No Color Adjustment)**.

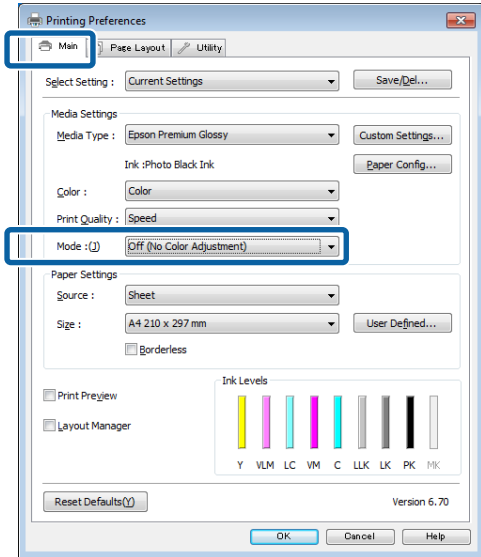

Note:
For Windows 7 and Windows Vista, **Off (No Color Adjustment)** is selected automatically.

For Mac OS X

Select **Print Settings** from the list, and then select **Off (No Color Adjustment)** as the **Color Settings** setting.

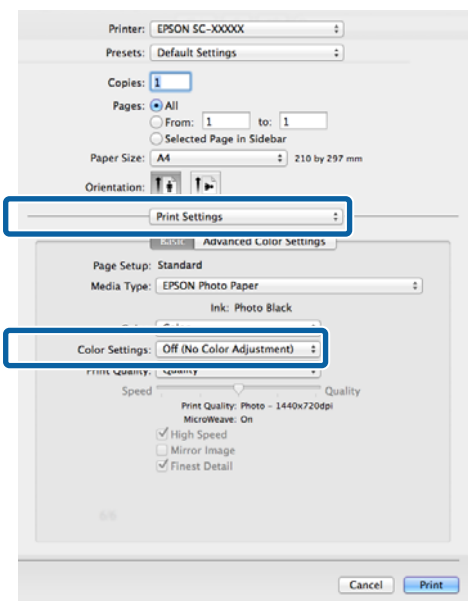

4 Check other settings, and then start printing.

Setting color management with the printer driver

Color management printing by Host ICM (Windows)

Use image data in which an input profile has been embedded. Also, the application must support ICM.

1 Make the settings for color adjustment using the application.

Depending on the type of the application, make the settings following the table below.

Application	Color Management Settings
Adobe Photoshop CS3 or later	Printer Manages Colors
Adobe Photoshop Lightroom 1 or later	
Adobe Photoshop Elements 6 or later	
Other applications	No Color Management

Note:
For information on the operating systems supported by each application, visit the distributor's website.

Color Management Printing

Setting example for Adobe Photoshop CS5

Open the **Print** screen.

Select **Color Management** and then **Document**. Select **Printer Manages Colors** as the **Color Handling** setting, and then click **Print**.

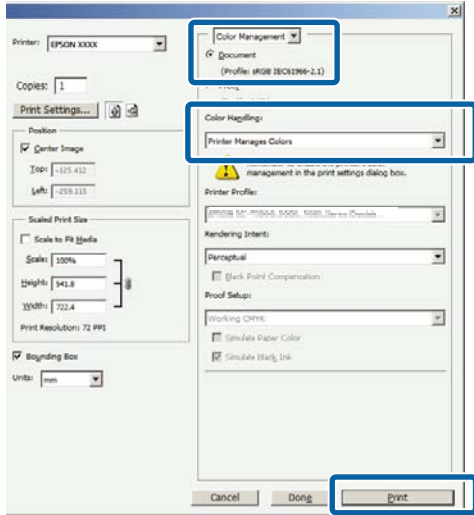

When using applications without a color management function, start from step 2.

- 2 In the printer driver's **Main** screen, select **Custom** as the **Mode**, select **ICM**, and then click **Advanced**.

[“Basic Printing Methods\(Windows\)” on page 31](#)

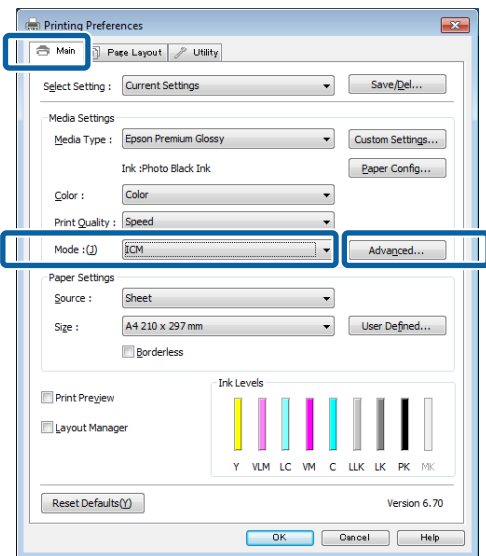

- 3 Select **Host ICM**.

When Epson special media is selected from **Media Type** in the **Main** screen, the printer profile corresponding to the media type is automatically selected and displayed in the **Printer Profile Description** box.

To change the profile, select **Show all profiles** at the bottom.

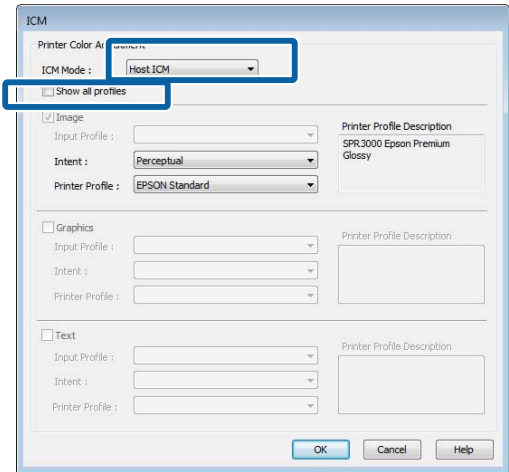

- 4 Check other settings, and then start printing.

Color management printing by ColorSync (Mac OS X)

Use image data in which an input profile has been embedded. Also, the application must support ColorSync.

Note:
Depending on the application, color management printing by **ColorSync** may not be supported.

- 1 Disable the color management functions in the application.

- 2 Display the Print screen.

[“Basic Printing Methods\(Mac OS X\)” on page 33](#)

Color Management Printing

- 3 Select **Color Matching** from the list, and then click **ColorSync**.

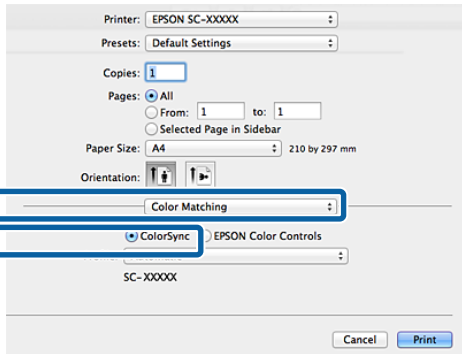

- 4 Check other settings, and then start printing.

Color management printing by Driver ICM (Windows only)

The printer driver uses its own printer profiles to perform color management. You can use the following two color correction methods.

- ❑ Driver ICM (Basic)

Specify one type of profile and intent for processing the entire image data.

- ❑ Driver ICM (Advanced)

The printer driver distinguishes the image data into the **Image**, **Graphics**, and **Text** areas. Specify three types of profiles and intents for processing each area.

When using applications featuring a color management function

Make the settings for color processing using the application before making printer driver settings.

Depending on the type of the application, make the settings following the table below.

Application	Color Management Settings
Adobe Photoshop CS3 or later	Printer Manages Colors
Adobe Photoshop Lightroom 1 or later	
Adobe Photoshop Elements 6 or later	
Other applications	No Color Management

Note:

For information on the operating systems supported by each application, visit the distributor's website.

Setting example for Adobe Photoshop CS5

Open the **Print** screen.

Select **Color Management** and then **Document**. Select **Printer Manages Colors** as the **Color Handling** setting, and then click **Print**.

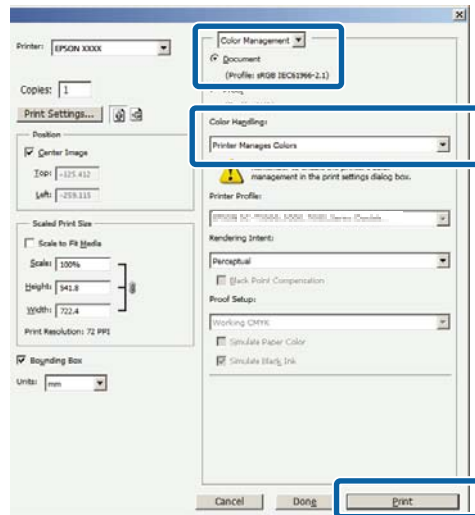

Color Management Printing

- 1 In the printer driver's **Main** screen, select **Custom** as the **Mode**, select **ICM**, and then click **Advanced**.

“Basic Printing Methods(Windows)” on page 31

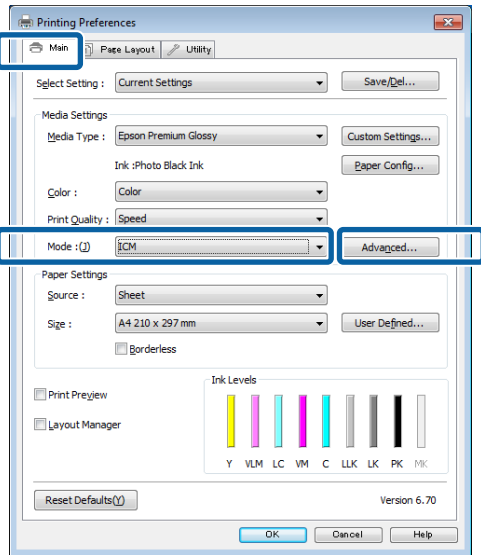

- 2 From **ICM Mode** in the **ICM** screen, select **Driver ICM (Basic)** or **Driver ICM (Advanced)**.

If you select **Driver ICM (Advanced)**, you can specify the profiles and intent for each image such as photos, graphics, and text data.

Intent	Explanation
Absolute Colorimetric	Assigns absolute color gamut coordinates to the original and print data and converts the data. Therefore, color tone adjustment is not performed on any white point (or color temperature) for the original or print data. This feature is used for special purposes such as logo color printing.

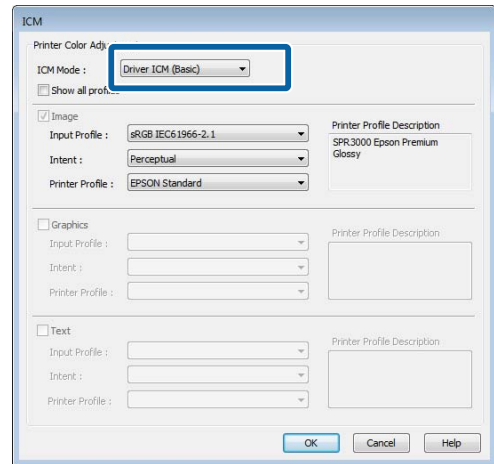

- 3 Check other settings, and then start printing.

Intent	Explanation
Saturation	Keeps the current saturation unchanged and converts the data.
Perceptual	Converts the data so that a more visually natural image is produced. This feature is used when a wider gamut of color is used for image data.
Relative Colorimetric	Converts the data so that a set of color gamut and white point (or color temperature) coordinates in the original data match their corresponding print coordinates. This feature is used for many types of color matching.

Using the Control Panel

Using the Control Panel

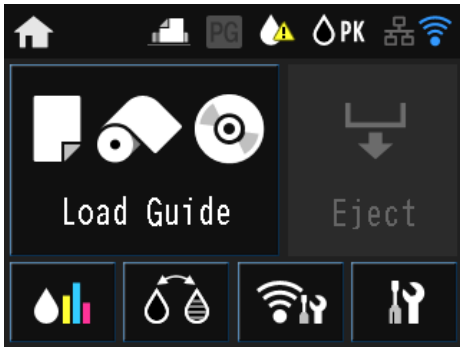

Press the icons to display menus such as Settings and Checking.

[“Home Screen View” on page 12](#)

Menus

Using the Menu

Explanations in this section use the Setup menu as an example.

1 Press the button.

2 Press .

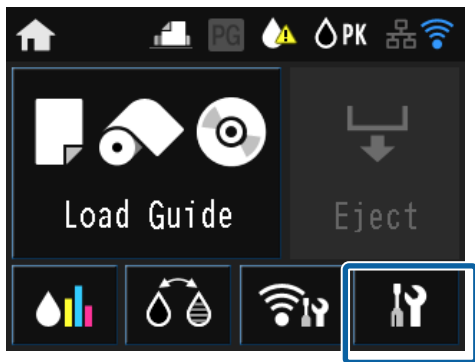

3 Press an item to select it.

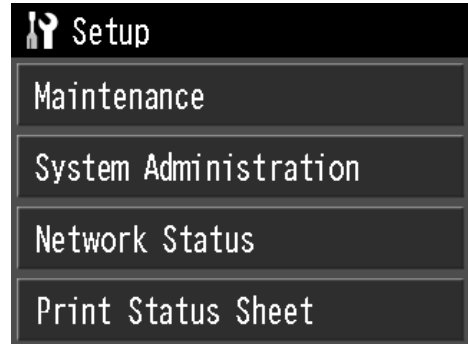

Note:
Depending on the item, press \wedge or \vee to change screens.

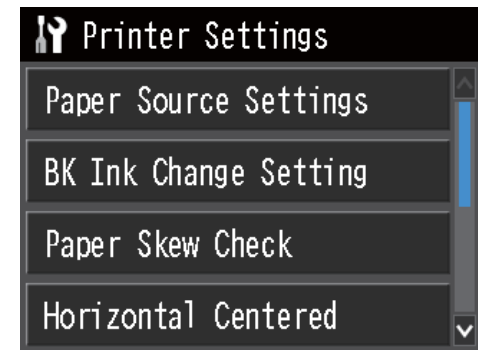

Using the Control Panel

Setting Items for the Network Summary Display

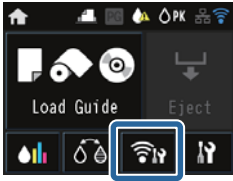

The following items can be set from the network summary display.

Item		Content
Menu	Wi-Fi/Network Settings	See the <i>Network Guide</i> (PDF).
	Wi-Fi Setup	
	Wi-Fi Direct Setup	
Wi-Fi Setup		See the <i>Network Guide</i> (PDF).

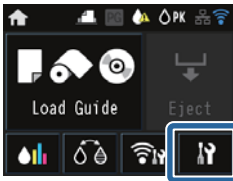

Setting Items for the Setup Menu



The Setup menu contains the following items and parameters.

* indicates the default setting.



Using the Control Panel

Item		Content			
Maintenance	Print Head Nozzle Check	<p>Check whether the print head nozzles are clogged. Visually confirm the printed check pattern, and perform head cleaning if there are any blurred or missing sections.</p> <p> "Checking for clogged nozzles" on page 94</p>			
	Print Head Cleaning	<p>Perform head cleaning if you notice banding or gaps in the print results. Cleans the surface of the print head to improve the print quality.</p>			
	Paper Guide Cleaning	<p>Select this option to pass (feed and eject) a cleaning sheet or plain paper through the printer and clean its inside.</p> <p> "Cleaning Inside the Printer" on page 99</p>			
	Thick Paper	<table border="1"> <tr> <td>On</td> <td rowspan="2"> <p>This option is only available when printing from a smart device.</p> <p>Set this if print results are scuffed or smeared. When this is set to On, print speed may slow down. Only use this if scuffing occurs. When the printer is turned off, this setting returns to Off.</p> </td> </tr> <tr> <td>Off*</td> </tr> </table>	On	<p>This option is only available when printing from a smart device.</p> <p>Set this if print results are scuffed or smeared. When this is set to On, print speed may slow down. Only use this if scuffing occurs. When the printer is turned off, this setting returns to Off.</p>	Off*
	On	<p>This option is only available when printing from a smart device.</p> <p>Set this if print results are scuffed or smeared. When this is set to On, print speed may slow down. Only use this if scuffing occurs. When the printer is turned off, this setting returns to Off.</p>			
Off*					
Print Head Alignment	<p>If print results appear grainy or out of focus, perform Print Head Alignment to correct the print misalignment.</p> <p> "Correcting Print Misalignment (Print Head Alignment)" on page 95</p>				
System Administration		See the next section.			
Network Status	Wi-Fi/Network Status	Check network information.			
	Wi-Fi Direct Status				
	Google Cloud Print Status				
Print Status Sheet	Configuration Status Sheet	Prints an information sheet for the current status and settings.			
	Supply Status Sheet				
	Usage History Sheet				

Using the Control Panel

System Administration

* indicates the default setting.

Item		Parameter		Content
Printer Settings	Paper Source Settings	Paper Setup Display	On*	Automatically displays the media setup screen when paper is loaded.
			Off	When this is Off , AirPrint is unavailable. Also, Error Notice from Paper Source Settings becomes Off .
		Error Notice	On	Set whether or not to display an error if the paper size or type differ from the printer settings.
			Off*	
BK Ink Change Setting	Normal*	Save Ink		Select Save Ink to reduce the amount of ink consumed when switching from one black ink to another. Note, however, that this may result in uneven gloss in areas printed with black ink after the switching.
				Select Normal to ensure adequate print quality after switching black inks.
Printer Settings	Paper Skew Check	On*		This option only takes effect with fine art media and poster board. Select On to display an error in the control panel's screen when the paper is fed in at a slant. On is recommended, as feeding the paper at a slant can cause the paper to jam.
		Off		
	Print Page Line	On*		When this is set to On , a dotted line is printed on the roll paper.
		Off		
	Paper Size Check	On*		Select whether or not (On/Off) to detect the paper width. When this is set to Off , printing may be performed beyond the edges of the paper. If printing is performed beyond the edges of the paper, the inside of the printer will be soiled with ink. We recommend setting this to On .
		Off		
	BK Ink Auto Change	On*		When this is set to On , the black ink is changed automatically using the Media Type selected in the printer driver.  "Changing the Type of Black Ink" on page 35  "Supported Media" on page 111
		Off		

Using the Control Panel

Item		Parameter	Content	
Common Settings	LCD Brightness	1-9 (9*)	You can adjust the brightness of the screen in nine stages.	
	Sound	Button Press	High*	Set whether or not to play a sound and the volume for operation sounds, error sounds, and done sounds.
			Medium	
			Low	
			Off	
		Error Notice	High*	
			Medium	
			Low	
			Off	
		Completion Notice	High*	
			Medium	
			Low	
			Off	
Common Settings	Sleep Timer	1 to 240 mins. (3*)	Set the time to switch to sleep mode (energy saving mode) when the printer is not operated for a continuous period.	
	Power Off Timer	Off, 30minutes, 1h, 2h, 4h, 8h, 12h	Set whether or not to turn off the printer automatically, as well as setting the time until the printer automatically turns off when no printer operations are performed for a continuous period. The default setting varies depending on the area of use.	
	Date/Time Settings	Date/Time	Set the date and time.	
		Time Difference	Set the time difference from Coordinated Universal Time (UTC). Default: Since this is set to ±0:00, it does not normally need to be changed.	
	Language	English, French, Italian, German, Spanish, Portuguese, Dutch, Russian, Simplified Chinese, Traditional Chinese, Korean	Select the language for the screen display. The default setting varies depending on the area of use.	
	Operation Time Out	On*	You are returned to the Home screen if no operations are performed for three minutes on each menu.	
Off				

Using the Control Panel

Item		Parameter	Content
Wi-Fi/Network Settings	Wi-Fi/Network Status	-	Print a network status sheet. View network settings and connection status.
	Wi-Fi Setup	Manual	See the <i>Network Guide</i> (PDF).
		Push Button Setup (WPS)	
		PIN Code Setup (WPS)	
		Wi-Fi Auto Connect	
		Disable Wi-Fi	
		Wi-Fi Direct Setup	
	Connection Check	-	See the <i>Network Guide</i> (PDF).
	Advanced Setup	Printer Name	See the <i>Network Guide</i> (PDF).
		TCP/IP Address	
DNS Server			
Proxy Server			
Wi-Fi Direct			
Google Cloud Print Services	How to	-	Select How to to display an explanation of the function.
	Settings	-	Visit the portal for more information on registering and usage. You can stop/restart service usage and restore content to the default settings from Settings .
Restore Default Settings	Network Settings	-	Restore network settings to the default settings.
	All except Network Settings	-	Restore all control panel settings except network settings to the default settings.
	All Settings	-	Restore all settings to the default settings.

Maintenance

Adjusting the Print Head

You need to adjust the print head if white lines appear in your print outs or if you notice the print quality has declined. You can perform the following printer maintenance functions for maintaining the print head in good condition to ensure the best print quality.

Carry out appropriate maintenance depending on the print results and situation.

Checking for clogged nozzles

Check whether the print head nozzles are clogged. If the nozzles are clogged, print results may include banding or unusual colors. Perform print head cleaning if the nozzles are clogged.

 [“Checking for clogged nozzles” on page 94](#)

Head Cleaning

Perform head cleaning if you notice banding or gaps in the print results. Cleans the surface of the print head to improve the print quality.

 [“Head Cleaning” on page 95](#)

Adjusting the print head position (Print head alignment)

If the print results appear grainy or out of focus, perform Print Head Alignment. The Print Head Alignment function corrects print misalignments.

 [“Correcting Print Misalignment \(Print Head Alignment\)” on page 95](#)

Checking for clogged nozzles

Print a pattern to check if the print head nozzle is clogged. When checking the printed pattern, if you see banding or any gaps in the print out you should perform head cleaning.

From the computer

Explanations in this section use the Windows printer driver as an example.

Use **Epson Printer Utility 4** for Mac OS X.

 [“Epson Printer Utility 4 Functions” on page 47](#)

1 Place A4 plain paper in the auto sheet feeder.

 [“Loading Paper into the Auto Sheet Feeder” on page 22](#)

2 Click **Nozzle Check** from the **Utility** tab in the printer driver's **Properties** (or **Print Settings**) screen.

Follow the on-screen instructions.

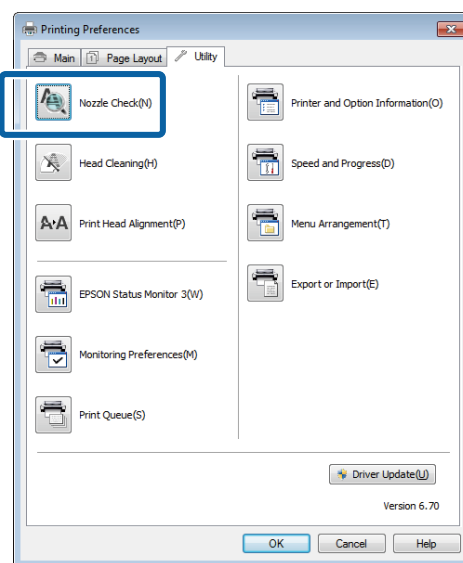

From the printer

1 Press the  button to display the Menu.

2 Press  - **Maintenance - Print Head Nozzle Check**.

3 Place A4 plain paper in the auto sheet feeder and press **Print**.

 [“Loading Paper into the Auto Sheet Feeder” on page 22](#)

4 Check the results.

Review the printed nozzle check pattern while referring to the following section.

Example of clean nozzles

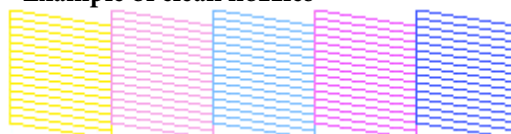

Maintenance

There are no gaps in the nozzle check pattern.

Example of clogged nozzles

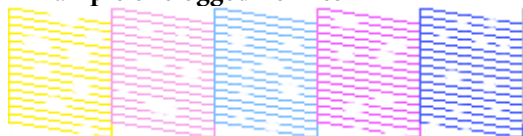

If any segments are missing in the nozzle check pattern, perform head cleaning.

Head Cleaning

Notes on head cleaning

Note the following points when performing head cleaning.

- ❑ Clean the print head only if print quality declines; for example, if the printout is blurry or the color is incorrect or missing.
- ❑ Head cleaning uses ink from all ink cartridges. Even if you are using only black inks for black and white printing, color inks are also consumed.
- ❑ If the nozzles are still clogged after you have performed around four cycles of nozzle checks and head cleaning, turn the printer off, wait for at least six hours, and perform a nozzle check and head cleaning again. Leaving the cartridges undisturbed for a period of time may allow the ink that is causing the clog to dissolve.

If the nozzles are still clogged, contact your dealer or Epson Support.

Performing Head Cleaning

From the computer

Explanations in this section use the Windows printer driver as an example.

Use **Epson Printer Utility 4** for Mac OS X.

[“Using Epson Printer Utility 4” on page 47](#)

1

Click **Head Cleaning** from the **Utility** tab in the printer driver's **Properties** (or **Print Settings**) screen.

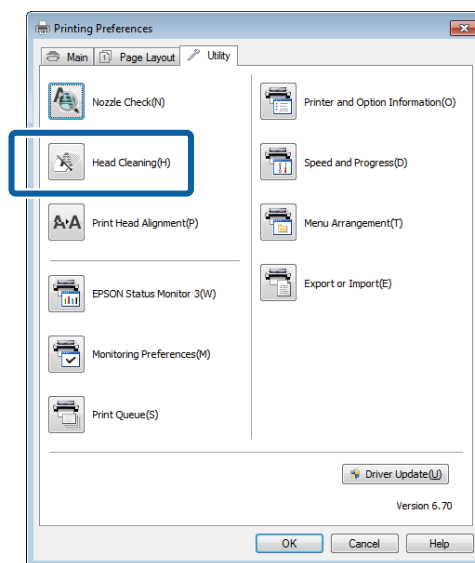

2

Follow the on-screen instructions. Head cleaning may take as long as about five and a half minutes.

From the printer

1

Press the button to display the Menu.

[“Menus” on page 88](#)

2

Press - **Maintenance** - **Print Head Cleaning**.

Further instructions are displayed in the control panel's screen.

Correcting Print Misalignment (Print Head Alignment)

Because there is a small distance between the print head and paper, misalignment may occur due to humidity or temperature, the inertial force of the print head's movements, or by moving the print head bidirectionally. As a result, print results may appear grainy or out of focus. When this happens, perform Print Head Alignment to correct the print misalignment.

From the computer

Explanations in this section use the Windows printer driver as an example.

Use Epson Printer Utility 4 for Mac OS X.

Maintenance

[“Epson Printer Utility 4 Functions” on page 47](#)

- 1 Place several sheets of A4 Photo Quality Inkjet Paper in the auto sheet feeder.

[“Loading Paper into the Auto Sheet Feeder” on page 22](#)

- 2 Click **Print Head Alignment** from the **Utility** tab in the printer driver's **Properties** (or **Print Settings**) screen.

Follow the on-screen instructions.

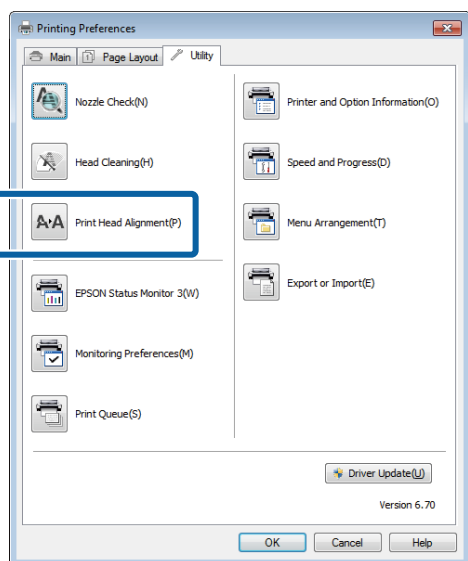

From the printer

- 1 Place several sheets of A4 Photo Quality Inkjet Paper in the auto sheet feeder.

[“Loading Paper into the Auto Sheet Feeder” on page 22](#)

- 2 Press the button to display the Home screen.

- 3 Press - **Maintenance** - **Print Head Alignment**.

[“Menus” on page 88](#)

- 4 Press **Print** to print an adjustment pattern.

- 5 Look at #1 and check for the pattern with the least vertical lines.

In this example, you would choose "4".

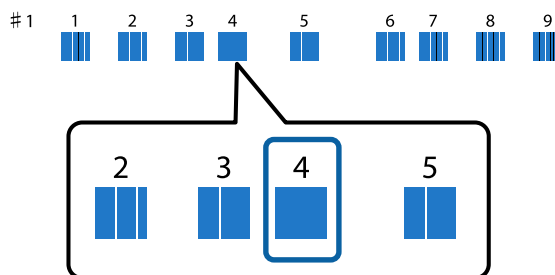

- 6 Check that #1 is displayed on the control panel screen, press the / buttons to select the number you chose in step 4, and then press **Proceed**.

- 7 Select the pattern with the least number of vertical lines for #2 to #9.

- 8 Follow the on-screen instructions to continue.

Maintenance

Replacing Ink Cartridges

Ink Cartridge Product Numbers

The following ink cartridges can be used with this printer. (Current as of June, 2014)

For the latest information, see the Epson Web site.

SC-P600

Ink color	Product number
Photo Black	T7601
Cyan	T7602
Vivid Magenta	T7603
Yellow	T7604
Light Cyan	T7605
Vivid Light Magenta	T7606
Light Black	T7607
Matte Black	T7608
Light Light Black	T7609

SC-P607

Ink color	Product number
Photo Black	T7631
Cyan	T7632
Vivid Magenta	T7633
Yellow	T7634
Light Cyan	T7635
Vivid Light Magenta	T7636
Light Black	T7637
Matte Black	T7638
Light Light Black	T7639

SC-P608

Ink color	Product number
Photo Black	T7611
Cyan	T7612
Vivid Magenta	T7613
Yellow	T7614
Light Cyan	T7615
Vivid Light Magenta	T7616
Light Black	T7617
Matte Black	T7618
Light Light Black	T7619



Important:

Epson recommends the use of genuine Epson ink cartridges. Epson cannot guarantee the quality or reliability of non-genuine ink. The use of non-genuine ink may cause damage that is not covered by Epson's warranties, and under certain circumstances may cause erratic printer behavior.

Information about non-genuine ink levels may not be displayed, and use of non-genuine ink is recorded for possible use in service support.

How to replace

If one of the installed ink cartridges is expended, printing cannot be performed. If an ink low warning is displayed, we recommend replacing the ink cartridge(s) as soon as possible.

If an ink cartridge runs out while printing, you can continue printing after replacing the ink cartridge. However, when replacing ink during a print job, you may see a difference in color depending on the drying conditions.

Supported ink cartridges  ["Ink Cartridge Product Numbers" on page 97](#)

The following procedure uses Yellow ink as an example. You can use the same procedure to replace all ink cartridges.

1

Make sure the printer is on.

Maintenance

- 2** Holding the new cartridge as shown, shake it four or five times and then remove it from the package and peel off the yellow tape only.

You may hear a rattling sound from inside the cartridge when it is shaken.

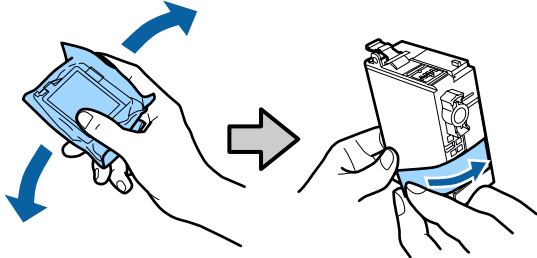

! **Important:**

- Do not touch the area shown in the illustration. You may not be able to print properly.

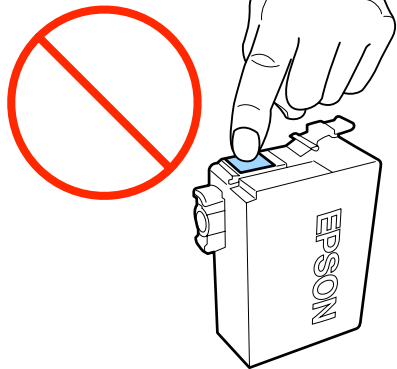

- Do not shake the ink cartridge once it has been removed from the package. Otherwise, ink could leak.

- 3** Open the printer cover.

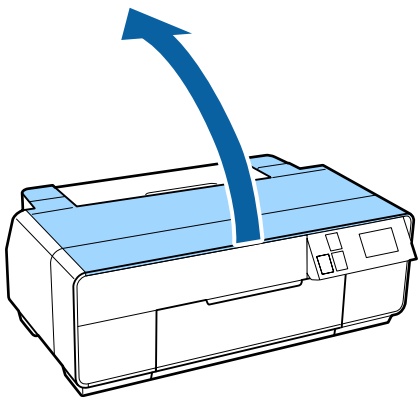

- 4** Open the cartridge cover.

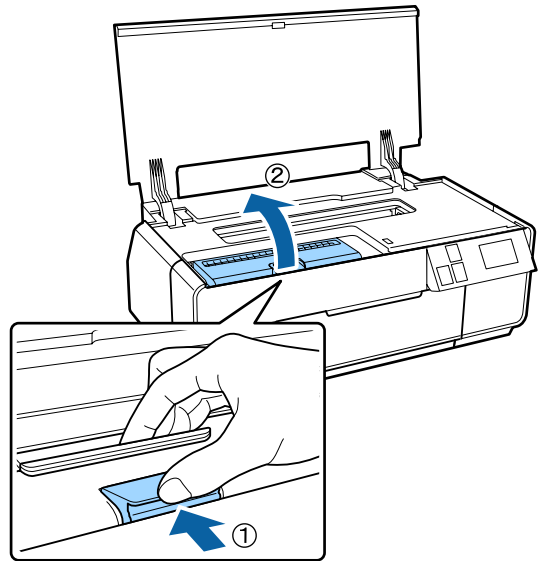

- 5** Remove the ink cartridge that will be replaced.

Hold the cartridge by the hooks and lift it straight up.

If the cartridge does not come out easily, pull harder.

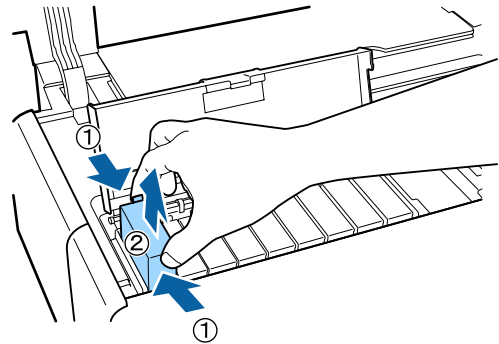

! **Important:**

Removed ink cartridges may have ink around the ink supply port, so be careful not to get any ink on the surrounding area.

Maintenance

- 6** Insert the new ink cartridge.
Push the cartridge in until it clicks into place.

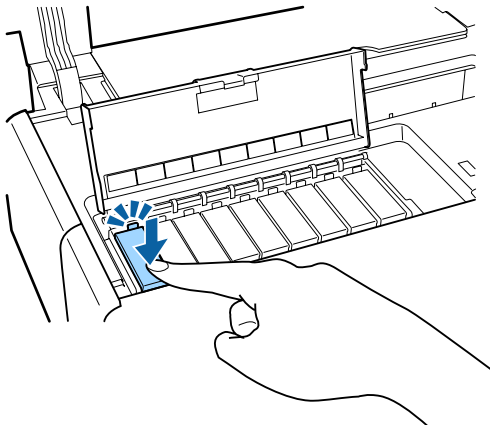

Repeat steps 4 to 6 to replace other ink cartridges.

! **Important:**
Install all ink cartridges. You cannot print if one or more colors of ink cartridge are not inserted.

- 7** Close the cartridge cover.

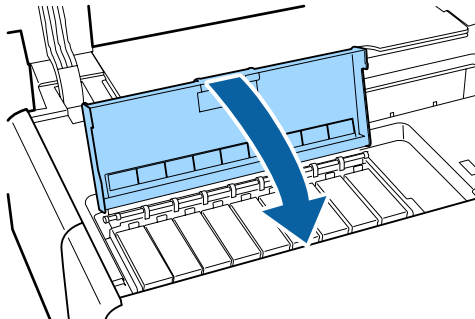

- 8** Close the printer cover.

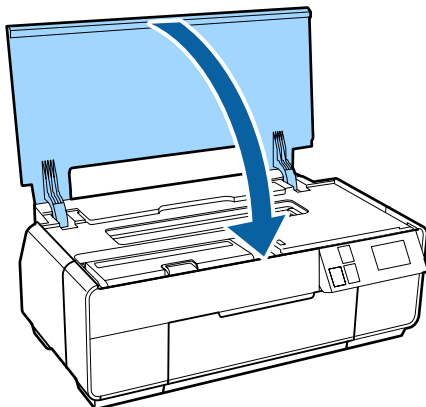

Cleaning Inside the Printer

Clean the rollers by passing (feeding and ejecting) one of the following types of paper through the printer.

Plain Paper

If the print results are scratched or smudged, there may be dirt on the rollers. Pass (feed and eject) plain paper through the printer to remove dirt from the rollers.

Cleaning sheet

If a cleaning sheet is provided with the Epson special media, you can pass (feed and eject) it through the printer to clean the rollers when plain paper fails to produce the desired results.

See the manual supplied with the paper for more information.

- 1** Turn on the printer.
- 2** Insert A3 or A3+ plain paper or a cleaning sheet into the auto sheet feeder.

Plain paper: If the paper is smaller than A3 or A3+, only the area corresponding to the size of the paper will be cleaned.

Cleaning sheet: Remove the protective covering from the cleaning sheet and place the sheet in the auto sheet feeder. Adhesive tape is located beneath the protective covering. Do not touch the adhesive tape or attach it to other objects.

- 3** Press **M** - **Maintenance** - **Paper Guide Cleaning** on the control panel's menu.

 ["Menus" on page 88](#)







Plain paper: Continue feeding and ejecting paper until no ink smudges are detected.

Cleaning sheet: Feed and eject the same cleaning sheet three times.

Problem Solver

Messages

If one of the following messages is displayed in the control panel's screen, refer to the solutions listed here and perform the necessary steps to fix the problem.

Message	What to do
Printer error. Turn power off and then on again. For details, see your documentation.	<p>Turn off the printer, and then turn it back on.</p> <p>If the problem persists, turn off the printer, open the printer cover, and check that there are no paper jams or foreign objects in the printer.</p> <p>Remove any foreign objects you discover and turn on the printer.</p>
Combination of IP address and subnet mask is invalid. See your documentation.	See the <i>Network Guide</i> (PDF).
Close the printer cover. See your documentation for details.	<p>Refer to the appropriate section below.</p> <ul style="list-style-type: none">  "Paper from the Auto Sheet Feeder Jams During Printing" on page 106  "Jammed Fine Art Media" on page 107  "Jammed Poster Board" on page 108  "Roll paper jam" on page 109  "The CD/DVD Tray is jammed" on page 110
Some function may not be available. For details, see your documentation.	<p>When Paper Setup Display is set to Off, AirPrint is not available. Error Notice from Paper Source Settings becomes Off. To use this function, set Paper Setup Display to On.</p> <p> "Menus" on page 88</p>
A printer's ink pad is at the end of its service life. Please contact Epson support.	Contact your dealer or Epson Support any time that "Please contact Epson support" is displayed.
A printer's ink pad is nearing the end of its service life. Please contact Epson support.	

Troubleshooting

You cannot print (because the printer does not work)

The printer does not turn on.

- **Is the power cable plugged into the electrical outlet or the printer?**

Make sure the power cable is securely plugged into the printer.

- **Is there any problem with the electrical outlet?**

Make sure your outlet works by connecting the power cable for another electric product.

- **Press and briefly hold the  button.**

The printer turns off automatically.

- **Is Power Off Timer enabled?**

If you do not want the printer to turn off automatically, set this to **Off**.

 ["Menus" on page 88](#)

Cannot Print

- **Confirm the printer operation.**

Print a nozzle check pattern.

 ["Checking for clogged nozzles" on page 94](#)

If a nozzle check pattern is printed, the printer has not malfunctioned.

Check the following.

 ["Cannot Print from the Printer Driver" on page 101](#)

If the nozzle check pattern is not printed correctly, the printer may require repair.

Contact your dealer or Epson Support.

Cannot Print from the Printer Driver

- **Is the cable plugged in properly?**

Make sure the printer's interface cable is securely plugged into the correct terminal of the computer and the printer. Also, make sure the cable is not broken nor bent. If you have a spare cable, try connecting with the spare cable.

- **Does the interface cable specification match the specifications for the computer?**

Make sure the interface cable specifications match the specifications for the printer and the computer.

 ["Specifications Table" on page 117](#)

- **Is the interface cable connected directly to the computer?**

If you use a printer switching device or extension cable between the printer and the computer, you may not be able to print depending on their combinations. Connect the printer and the computer directly with the interface cable and check if you can print normally.

- **When using a USB hub, is it being used correctly?**

In the USB specification, daisy-chains of up to five USB hubs are possible. However, we recommend that you connect the printer to the first hub connected directly to the computer. Depending on the hub you are using, the operation of the printer may become unstable. If this should occur, plug the USB cable directly into your computer's USB port.

- **Is the USB hub recognized correctly?**

Make sure the USB hub is recognized correctly on the computer. If the USB hub is recognized correctly, unplug all of the USB hubs from the computer's USB port, and then connect the printer's USB interface connector directly to the computer's USB port. Ask the USB hub manufacturer about USB hub operation.

- **Is the printer icon listed in the Devices and Printers, Printers, or Printers and Faxes folder (Windows)?**

If the printer icon is not listed, the printer driver is not installed. Install the printer driver.

Problem Solver

■ Does the printer port setting match the printer connection port? (Windows)

Check the printer port.

Click the **Ports** tab in the printer driver's Properties screen, and check the **Print to the following port(s)**.

- USB: **USB xxx** (x stands for the port number) for the USB connection
- Network: The correct IP address for the network connection

If it is not indicated, the printer driver is not installed correctly. Delete and reinstall the printer driver.

 ["Uninstalling the printer driver" on page 46](#)

■ Is the printer added to the printer list? (Mac OS X)

Click the Apple Menu, the **System Preferences** folder, and then the **Print & Fax** folder.

If the printer name is not displayed, add the printer.

You cannot print under the network environment.

■ Connect the printer directly to the computer using a USB cable, and then try to print.

If you can print via USB, there are some problems on the network environment. See the *Network Guide* (PDF). If you cannot print via USB, see the appropriate section in this User's Guide.

The printer has an error.

■ Check the message in the screen.

 ["Messages" on page 100](#)

The printer stops printing.

■ Is the status of print queue Pause? (Windows)

If you stop printing or the printer stops printing because of an error, the print queue enters a **Pause** status. You cannot print in this status.

Double-click the printer icon in the **Devices and Printers, Printers, or Printers and Faxes** folder; if printing is paused, deselect **Pause Printing** in the **Printer** menu.

■ Is the printing status paused? (Mac OS X)

Display the screen that indicates the printer's status, and check that printing is not paused.

- (1) From the Apple menu, click **Print & Scan** (or **Print & Fax**), and then click **Open Print Queue**.
- (2) Double-click the paused printer.
- (3) Click **Resume Printer**.

Your problem is not listed here.

■ Decide whether the trouble is caused by the printer driver or the application. (Windows)

Perform a test print from the printer driver so that you can check that the connection between the printer and computer is correct and the printer driver settings are correct.

- (1) Make sure that the printer is turned on and in ready status, and load A4 or larger paper.
- (2) Open the **Devices and Printers, Printers and Faxes, or Printers** folder.
- (3) Right-click the target printer icon, and select **Properties**.
- (4) On the **General** tab, click the **Print Test Page** button.

After a while the printer starts to print a test page.

- If the test page is printed correctly, the connection between the printer and computer is correct. Go to the next section.
- If the test page is not printed correctly, check the items above again.

 ["You cannot print \(because the printer does not work\)" on page 101](#)

The "Driver Version" shown on the test page is the version number of the Windows internal driver. This differs from the Epson printer driver version that you installed.

The printer sounds like it is printing, but nothing prints

■ Has the printer been left unused for a long time?

If the printer has not been used for a long time, the nozzles may have dried up and have been clogged. If you have not used the printer for a long time, check the print head for clogging before you start printing. Perform head cleaning if the print head is clogged.

 ["Checking for clogged nozzles" on page 94](#)

Problem Solver

Print Quality/Print Results

Print quality is poor, uneven, too light, or too dark.

■ Are the print head nozzles clogged?

If the nozzles are clogged, specific nozzles do not fire ink and the print quality declines. Check whether the nozzles are clogged.

 ["Checking for clogged nozzles" on page 94](#)

Perform print head cleaning if the nozzles are clogged.

 ["Head Cleaning" on page 95](#)

■ Was Print Head Alignment performed?

With bidirectional printing, the print head prints while moving left and right. If the print head is misaligned, ruled lines may be misaligned accordingly. If vertical ruled lines are misaligned with bidirectional printing, perform Print Head Alignment.

 ["Correcting Print Misalignment \(Print Head Alignment\)" on page 95](#)

■ Are you using a genuine Epson ink cartridge?

This printer is developed for use with Epson ink cartridges. If you use non-Epson ink cartridges, the prints may smear, or the color of the printed image may be changed because the remaining ink level is not correctly detected. Be sure to use the correct ink cartridge.

■ Are you using an old ink cartridge?

The print quality declines when an old ink cartridge is used. Replace the old ink cartridge with a new one. We recommend using the ink cartridge before the expiry date printed on the packaging (within six months of opening the package).

■ Are the Media Type settings correct?

Print quality will be affected if the paper currently loaded in the printer does not match the **Media Type** selected in the printer driver **Main** tab (Windows) or Print screen (Mac OS X). Be sure to match the media type setting with the paper that is loaded in the printer.

■ Did you select a low quality mode (such as Speed) as the Print Quality?

The print quality may decline when you select **Speed** for **Print Quality** or make **Quality Options** settings that assign priority to speed from the printer driver. If you want to improve your print quality, select a setting that assigns priority to quality.

■ Was color management performed?

Perform color management.

 ["Color Management Printing" on page 82](#)

■ Have you compared the printing result with the image on the display monitor?

Since monitors and printers produce colors differently, printed colors will not always match on-screen colors perfectly.

■ Are you printing with PhotoEnhance (auto print quality adjustment)?

PhotoEnhance optimally enhances data that lacks appropriate contrast or saturation for clear results when printing. As a result, colors in images printed with PhotoEnhance may differ from those displayed on screen.

 ["Auto Correct Color and Print Photos \(PhotoEnhance\)" on page 50](#)

■ Did you print a photograph or other color image on plain paper?

The type of paper used for color printing has a large effect on the quality of the results. Choose a paper (including special medias and plain paper) according to your intended purpose.

■ Did you print on the wrong side of the paper?

Special medias have a back (non-printable) side. Place the front (printable) side on top.

The color is not exactly the same as another printer.

■ Colors vary depending on the printer type due to each printer's characteristics.

Because inks, printer drivers, and printer profiles are developed for each printer model, the colors printed by different printer models are not exactly the same.

You can achieve similar colors with the same color adjustment method or the same gamma setting by using the printer driver.

 ["Color Management Printing" on page 82](#)

Problem Solver

The print is not positioned properly on the paper.

- **Have you specified the print area?**
Check the print area in the settings of the application and the printer.

- **Is the paper size setting correct?**
If the **Paper Size** setting in the printer driver and the size of the loaded paper do not match, the print may not be where you want it, or part of it may be cut off. In this case, check the print settings.

- **Is fine art media or poster board skewed?**
If **Off** is selected from **System Administration - Printer Settings - Paper Skew Check** in the Setup menu, printing may be performed outside of the printable area, even if the fine art media and poster board is skewed. Set **System Administration - Printer Settings - Paper Skew Check** to **On** in the Setup menu.
[☞ "Menus" on page 88](#)

Vertical ruled lines are misaligned.

- **Is the print head misaligned? (in bidirectional printing)**
With bidirectional printing, the print head prints while moving left and right. If the print head is misaligned, ruled lines may be misaligned accordingly. If vertical ruled lines are misaligned with bidirectional printing, perform Print Head Alignment.
[☞ "Correcting Print Misalignment \(Print Head Alignment\)" on page 95](#)

The printed surface is scuffed or soiled.

- **Is the paper too thick or too thin?**
Check that the paper specifications are compatible with this printer. For information about the media types and appropriate settings for printing on paper from other manufacturers or when using RIP software, see the manual supplied with the paper, or contact the dealer of the paper or the manufacturer of the RIP.

- **Is the paper creased or folded?**
Do not use old paper or paper with folds in it. Always use new paper.

- **Is the paper wavy or slack?**
Cut sheets become wavy or slack due to changes in temperature or humidity which may result in the printer being unable to recognize the paper size correctly. Flatten the paper before loading it in the printer, or use new paper.

- **Is the Inside of the printer dirty?**
There may be dirt on the rollers. Pass (feed and eject) paper through the printer to clean the rollers.
[☞ "Cleaning Inside the Printer" on page 99](#)

The paper is creased.

- **Are you using the printer at normal room temperature?**
Epson special media should be used at normal room temperature (temperature: 15 to 25°C, humidity: 40 to 60 %). For information about paper such as thin paper from other manufacturers that requires special handling, see the manual supplied with the paper.

- **When using non-Epson special media, have you made the Paper Configuration?**
Before printing on paper other than Epson special-purpose media, adjust settings in the printer driver **Paper Configuration** tab to match the paper. See the printer driver help for more details on the **Paper Configuration** screen.

Too much ink is fired.

- **Are the Media Type settings correct?**
Make sure that the printer driver's **Media Type** settings match the paper that you are using. The amount of ink to be fired is controlled according to the media type. If the settings do not match the paper loaded, too much ink may be fired.

- **Is the Color Density setting correct?**
Lower the density of the ink in the **Paper Configuration** screen from the printer driver. The printer may be firing too much ink for some paper. See the printer driver help for more details on the **Paper Configuration** screen.

- **Did you shake the ink cartridge before installing it in the printer?**
The printer uses pigment inks, which require that the ink inside the cartridge be mixed before the cartridge is installed.
[☞ "Replacing Ink Cartridges" on page 97](#)

Problem Solver

Margins appear in borderless printing.

- **Are the settings for the print data in the application correct?**
Make sure that the paper settings in the application are correct as well as in the printer driver.
[👉 "Borderless printing" on page 58](#)

- **Are the paper settings correct?**
Make sure that the paper settings of the printer match the paper that you are using.

- **Have you changed the amount of enlargement?**
Adjust the amount of enlargement for borderless printing. Margins may appear if you set the amount of enlargement to **Min**.
[👉 "Borderless printing" on page 58](#)

- **Is the paper stored correctly?**
The paper may expand or contract if it is not stored correctly so that margins appear even when borderless is set. See the manual supplied with the paper for more information on the storage method.

- **Are you using paper that supports borderless printing?**
Paper that does not support borderless printing may expand or contract while printing so that margins appear even when borderless is set. We recommend using paper that is designed to support borderless printing.
[👉 "Epson Special Media Table" on page 111](#)

Unable to feed or eject paper.

- **Is the paper loaded in the correct position?**
See the following for the correct paper loading positions.
[👉 "Loading Cut Sheets" on page 22](#)
[👉 "Loading and Removing Roll Paper" on page 27](#)
[👉 "Loading and Removing CDs and DVDs" on page 29](#)
If the paper is loaded correctly, check the condition of the paper that you are using.

- **Is the paper loaded in the correct direction?**
Load cut sheets vertically. If the paper is not loaded in the correct orientation, the printer will not recognize the paper or feed it correctly, resulting in errors.
[👉 "Loading Cut Sheets" on page 22](#)

- **Is the paper creased or folded?**
Do not use old paper or paper with folds in it. Always use new paper.

- **Is the paper damp?**
Do not use paper that is damp. Also, Epson special media should be left in the bag until you intend to use it. If it is left out for a long time, the paper curls up and gets damp so that it does not feed properly.

- **Is the paper wavy or slack?**
Cut sheets become wavy or slack due to changes in temperature or humidity which may result in the printer being unable to recognize the paper size correctly. Flatten the paper before loading it in the printer, or use new paper.

- **Is the paper too thick or too thin?**
Check that the paper specifications are compatible with this printer. For information about the media types and appropriate settings for printing on paper from other manufacturers or when using RIP software, see the manual supplied with the paper, or contact the dealer of the paper or the manufacturer of the RIP.

- **Are you using the printer at normal room temperature?**
Epson special media should be used at normal room temperature (temperature: 15 to 25°C, humidity: 40 to 60 %).

- **Is paper jammed in the printer?**
Open the printer cover of the printer and check that there are no paper jams or foreign objects in the printer. If paper is jammed, see below and clear the jammed paper.

- **The rollers inside the printer may be dirty.**
If a cleaning sheet is provided with the paper, pass (feed and eject) it through the printer to clean the rollers.
[👉 "Cleaning Inside the Printer" on page 99](#)

Problem Solver

- **Did you leave the front manual feed tray open when loading roll paper?**
Close the front manual feed tray, and load roll paper.

- **Fine art media may have been fed on an angle.**
After inserting fine art media, be sure the tail end of the paper is aligned with the line on the front manual feed tray.

 ["Loading Fine Art Media" on page 23](#)

- **Did you remove the transportation lock?**
If you have not already done so, remove the transportation lock holding the front manual feed tray in place.

Failure to remove the transportation lock could cause paper to jam.

Paper from the Auto Sheet Feeder Jams During Printing

Follow the instructions on the control panel's screen, and remove any jammed paper by following the steps below.



Important:

Do not use force. Attempting to forcibly remove jammed paper could damage the printer.

1

Slowly pull the jammed paper from the printer.

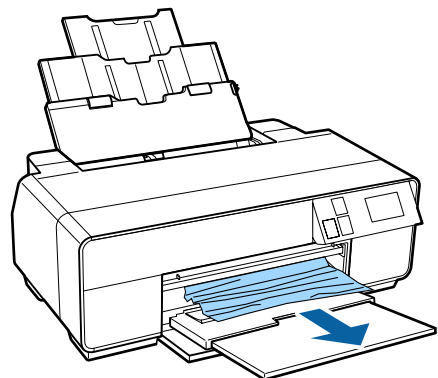
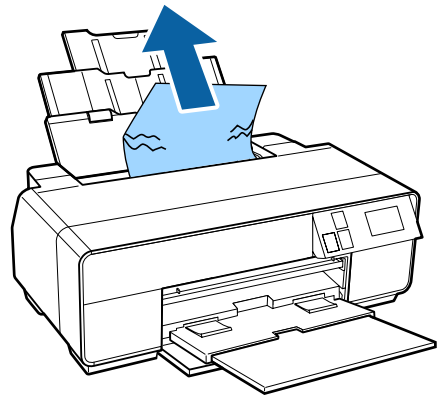

Problem Solver

- 2** Open the printer cover and slowly pull the jammed paper out of the printer.

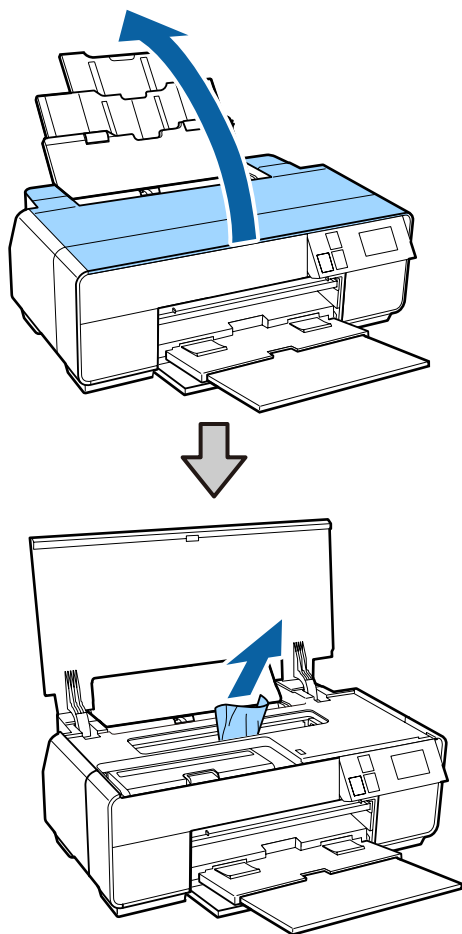

- 3** After removing the paper, close the printer cover and press **Restart**.

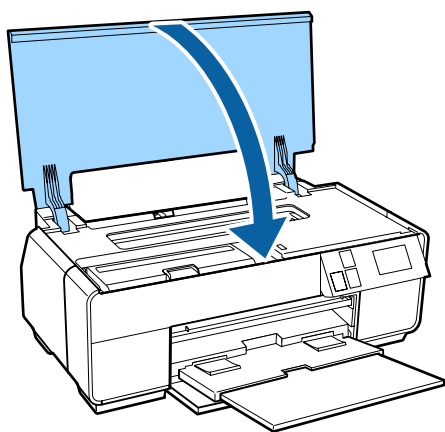

- 4** If an error is still displayed after you have completed Step 3, turn off the printer, and then turn it back on.

- 5** If you are unable to remove the paper, contact your dealer or Epson Support.

Jammed Fine Art Media

Follow the instructions on the control panel's screen, and remove any jammed paper by following the steps below.

- 1** Pull the paper out from the front or back (whichever is easier).

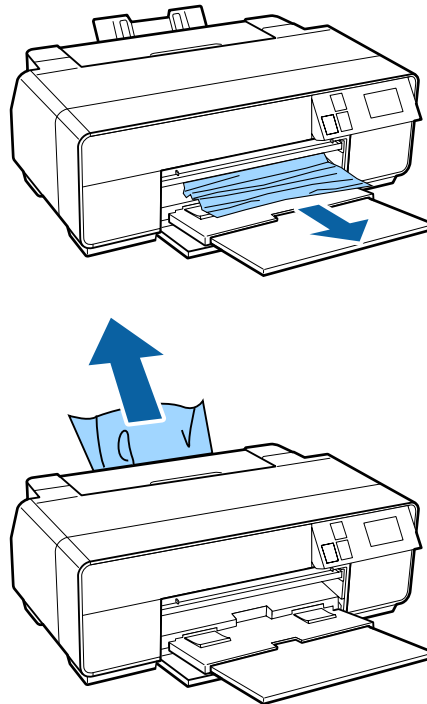

Problem Solver

- 2** Open the printer cover and slowly pull the jammed paper out of the printer.

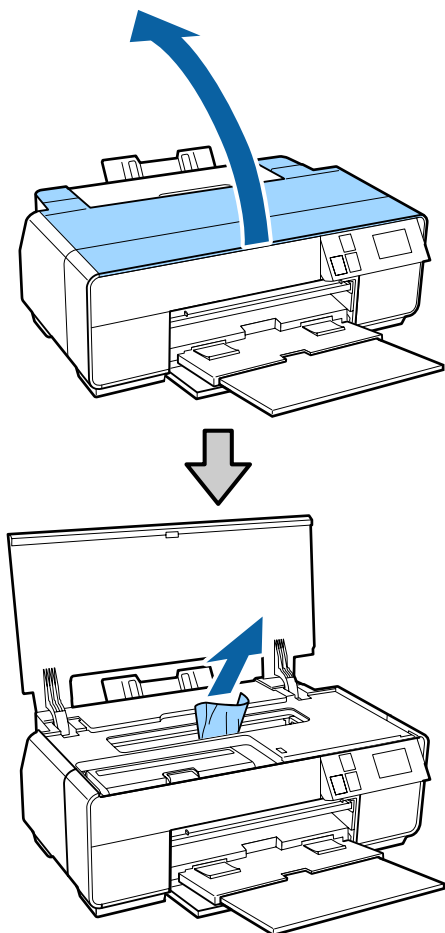

- 3** After removing the paper, close the printer cover and press **Restart**.
- 4** If an error is still displayed after you have completed Step 3, turn off the printer, and then turn it back on.
- 5** If you are unable to remove the paper, contact your dealer or Epson Support.

Jammed Poster Board

Follow the instructions on the control panel's screen, and remove any jammed paper by following the steps below.

- 1** Pull the paper out from the front or back (whichever is easier).

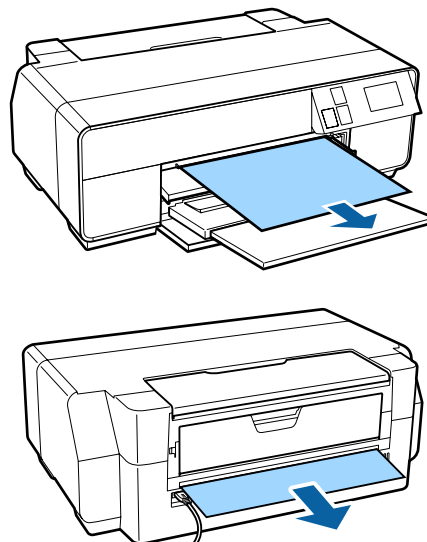

- 2** Open the printer cover and slowly pull the jammed paper out of the printer.

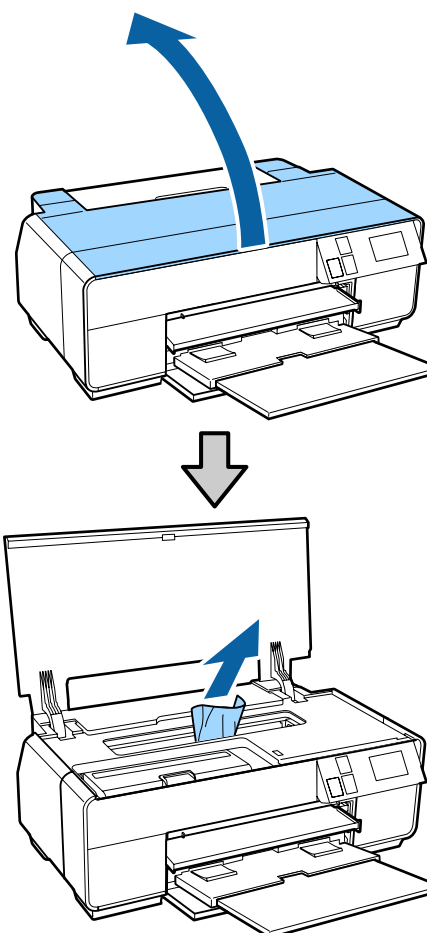

- 3** After removing the paper, close the printer cover and press **Restart**.

Problem Solver

4 If an error is still displayed after you have completed Step 3, turn off the printer, and then turn it back on.

5 If you are unable to remove the paper, contact your dealer or Epson Support.

Roll paper jam

Follow the instructions on the control panel's screen, and remove any jammed paper by following the steps below.

1 Cut the paper close to the roll paper feeder and output tray.

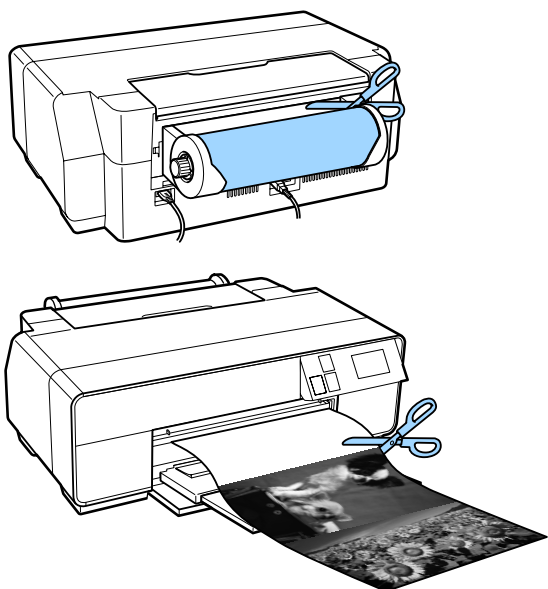

2 Pull the paper out from the front or back (whichever is easier).

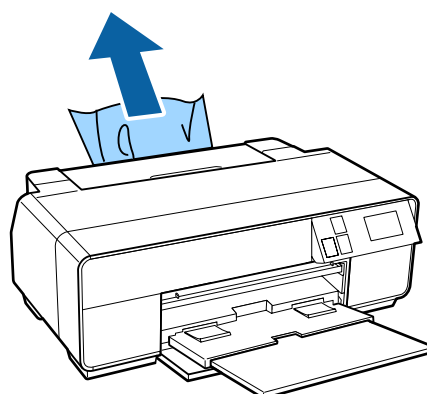
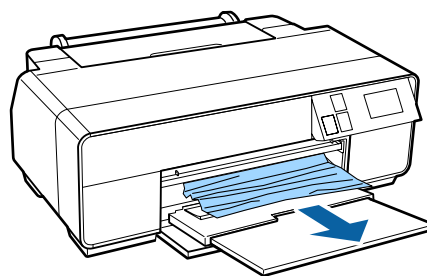

3 Open the printer cover and slowly pull the jammed paper out of the printer.

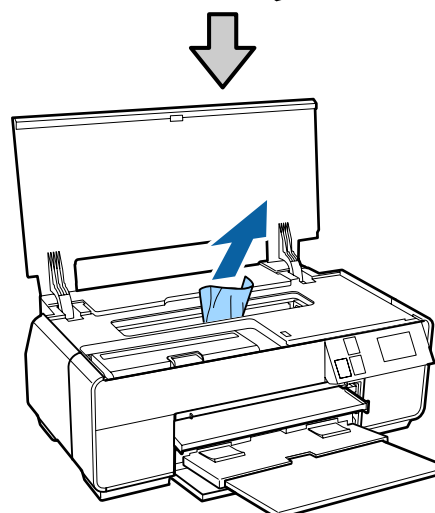
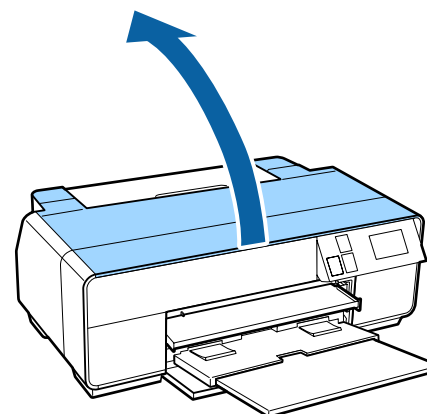

Problem Solver

- 4 After removing the paper, close the printer cover and press **Restart**.
- 5 If an error is still displayed after you have completed Step 4, turn off the printer, and then turn it back on.
- 6 If you are unable to remove the paper, contact your dealer or Epson Support.

The CD/DVD Tray is jammed

Follow the instructions on the control panel's screen, and remove the CD/DVD tray by following the steps below.

- 1 Slowly pull the CD/DVD tray from the front of the printer.

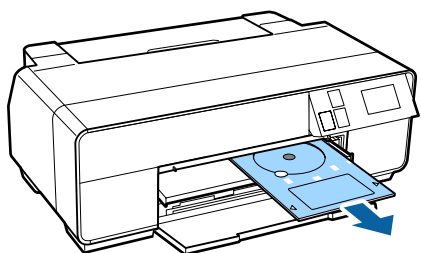

- 2 After removing the tray, press **Restart**.
- 3 If an error is still displayed after you have completed Step 2, turn off the printer, and then turn it back on.
- 4 If you are unable to remove the tray, contact your dealer or Epson Support.

Others

The control panel's screen keeps turning off.

- **Is the printer in sleep mode?**
Sleep mode ends and normal operation is restored when a print job is received or any button (excluding the  button) is pressed in the control panel.

Color ink runs out quickly even when printing in the Black mode or when printing black data.

- **Color ink is consumed during the head cleaning process.**
All nozzles are cleaned during head cleaning, using all colors of ink. (Even when Black mode is selected, the ink for all colors is consumed while cleaning.)
 ["Head Cleaning" on page 95](#)

Appendix

Supported Media

We recommend you use the following Epson special media for high-quality printing results.

Note:

For information about the media types and appropriate settings for printing on paper other than Epson special media or when using raster image processing (RIP) software, see the manual supplied with the paper, or contact the dealer of the paper or the manufacturer of the RIP.

Item descriptions

Name: Describes the media name.

Size: Describes the size for cut sheet media or the width for roll paper.

Capacity: Describes how many sheets can be loaded in the auto sheet feeder. For cut sheets only.

Thickness: Describes the thickness of the media.

Source: Describes the source from which paper is loaded.

Borderless: Describes whether borderless printing is available.

Black ink: Describes the type of black ink that can be used with the loaded media.

ICC Profile: Describes the ICC profile for the media. The file name of the profile is used as the profile name in the printer driver or the application.

Media Type: Describes the media type selected in the printer driver.

Epson Special Media Table

PK: Photo Black/MK: Matte Black

Appendix

Name	Size	Capacity	Source	Borders	Black Ink	ICC Profile	Media Type (Printer Driver)
Premium Glossy Photo Paper	13 x 18 cm (5 x 7 in.)	30	Sheet	✓	PK	SC-P600 Series Premium Glossy.icc	Epson Premium Glossy
	16:9 wide size(102 x 181 mm)	20					
	10 x 15 cm (4 x 6 in.)	30					
	A4	30					
	A3	10					
	A3+	10					
Photo Paper Glossy	13 x 18 cm (5 x 7 in.)	30	Sheet	✓	PK	SC-P600 Series Glossy.icc	Epson Glossy
	10 x 15 cm (4 x 6 in.)	30					
	A4	30					
Premium Semigloss Photo Paper	10 x 15 cm (4 x 6 in.)	30	Sheet	✓	PK	SC-P600 Series Premium Semigloss.icc	Epson Premium Semigloss
	A4	30					
	A3	10					
	A3+	10					
Epson Premium Luster Photo Paper	A4	30	Sheet	✓	PK	SC-P600 Series Epson Premium Luster.icc	Epson Premium Luster
	A3	10					
	A3+	10					
Premium Glossy Photo Paper	329 mm (A3+)	-	Roll Paper	✓	PK	SC-P600 Series Premium Glossy.icc	Epson Premium Glossy
Premium Semigloss Photo Paper	329 mm (A3+)	-	Roll Paper	✓	PK	SC-P600 Series Premium Semigloss.icc	Epson Premium Semigloss
Epson Premium Luster Photo Paper	329 mm (A3+)	-	Roll Paper	✓	PK	SC-P600 Series Epson Premium Luster.icc	Epson Premium Luster
Photo Quality Inkjet Paper	A4	100	Sheet	-	MK	SC-P600 Series Standard.icc	Epson Photo Quality Ink Jet
	A3	50					
	A3+	50					

Appendix

Name	Size	Capacity	Source	Borderless	Black Ink	ICC Profile	Media Type (Printer Driver)
Matte Paper-Heavyweight	A4	30	Sheet	✓	MK	SC-P600 Series Archival Matte.icc	Epson Archival Matte
	A3	10					
	A3+	10					
Archival Matte Paper	A4	30	Sheet	✓	MK	SC-P600 Series Archival Matte.icc	Epson Archival Matte
	A3	10					
	A3+	10					
Bright White Ink Jet Paper	A4	80	Sheet	✓*	PK/MK	SC-P600 Series Standard.icc	Plain paper
Premium Ink Jet Plain Paper	A4	80	Sheet	✓*	PK/MK	SC-P600 Series Standard.icc	Plain paper
Double-Sided Matte Paper	A4	1	Sheet	-	MK	SC-P600 Series Archival Matte.icc	Epson Archival Matte
Watercolor Paper - Radiant White	A3+	1	Front-Fine Art	✓	MK	SC-P600 Series Watercolor Paper - Radiant White.icc	Watercolor Paper - Radiant White
Velvet Fine Art Paper	A3+	1	Front-Fine Art	✓	MK	SC-P600 Series Velvet Fine Art Paper.icc	Velvet Fine Art Paper
UltraSmooth Fine Art Paper	A3+	1	Front-Fine Art	✓	MK	SC-P600 Series Ultra Smooth Fine Art Paper.icc	UltraSmooth Fine Art Paper
Photo Quality Self Adhesive sheets	A4	1	Sheet	-	MK	SC-P600 Series Standard.icc	Epson Photo Quality Ink Jet

*1 You can specify and perform borderless printing; however, margins may appear or the print quality may decline due to the paper expanding or contracting.

In addition, borderless printing may not be available at the selected print quality.

Usable Commercially Papers

This printer supports the following paper specifications for non-Epson media.



Important:

- Do not use paper that is wrinkled, scuffed, torn, or dirty.
- Although plain paper and recycled paper manufactured by other companies can be loaded and fed in the printer as long as they meet the following specifications, Epson cannot guarantee the print quality.
- Although other paper types manufactured by other companies can be loaded in the printer as long as they meet the following specifications, Epson cannot guarantee the paper feeding and print quality.

Appendix

PK: Photo Black/MK: Matte Black

Name	Size	Capacity	Thickness	Source	Borders	Black ink	Media Type (Printer Driver)
Plain paper (cut sheets)	A4, B5, A5, A6, Letter	Up to 12 mm total thickness	0.08 to 0.11 mm (64 to 90 g/m ²)	Auto sheet feeder	-	PK/MK	Plain paper
	A3, B4, Legal	Up to 5mm total thickness					
	Non-standard sizes Width: 89 to 329 mm Length: 127 to 1,117.6 mm						
Roll paper	329 mm (A3+ width)	-	0.08 to 0.11 mm (64 to 90 g/m ²)	Roll paper	✓*1	PK/MK	*1
Thick paper	A4/A3/A3+/Letter/US B 11×17 in	1	0.3 to 0.7 mm	Front manual feed (fine art media)	✓	PK/MK	*1
	A4/A3/A3+/Letter/US B 11×17 in	1	0.7 mm to 1.3 mm	Front manual feed (poster board)	-		
CD/DVD	12 cm	1	-	CD/DVD tray	-	PK/MK	A special application is required to print CDs/DVDs. Use the supplied Epson Print CD application.
Premium surface CD/DVD	12 cm	1	-	CD/DVD tray	-	PK/MK	

*1 See the manual supplied with the paper and adjust settings as appropriate.

Transporting the Printer

Follow the steps below when moving or transporting the printer. To protect the printer from shock and vibration, repack it in the original box using the original packing materials.

! Important:

- ❑ Only hold the required area; otherwise, the printer may be damaged.
- ❑ Move and transport the printer with ink cartridges installed. Do not remove the ink cartridges; otherwise, the nozzles may be clogged and make it impossible to print, or ink may leak.

Preparing the Printer for Transport

As the procedure for transporting the printer requires commercial tape, make sure you prepare easily-removable tape (masking tape and so on) in advance. Some tape may be difficult to remove if it is left in place for an extended period. Remove immediately after transportation is complete.

- 1 Turn off the printer and remove all cables.
- 2 Remove any paper.
- 3 Open the printer cover.

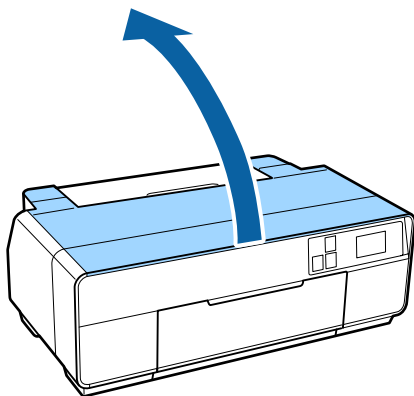

- 4 Fix the print head in place using ordinary tape. When applying the tape, be careful not to touch the internal parts of the printer.

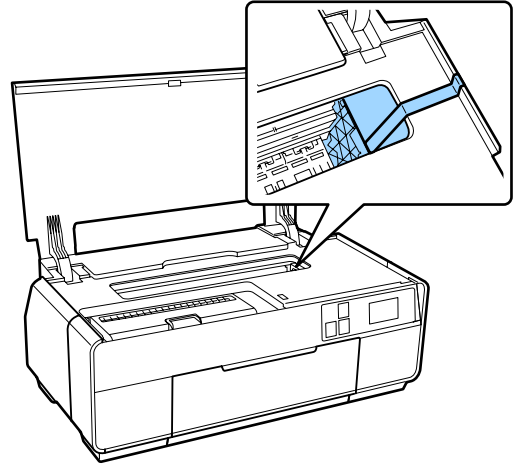

- 5 Close the printer cover.

- 6 Open the front cover.

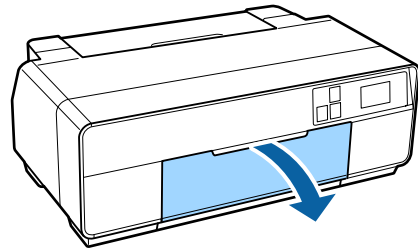

- 7 Attach the transportation lock to the lower right of the front manual feed tray, and secure it with commercially available tape and so on.

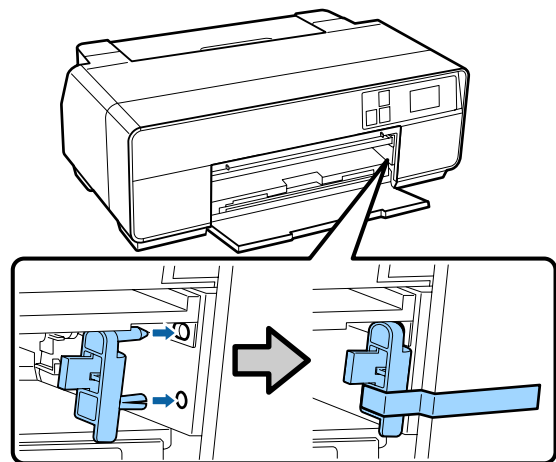

Appendix

- 8** After securing the transportation lock with tape, attach the transportation locks to the top and bottom of the front manual feed tray, and secure them with tape.

Top of the tray

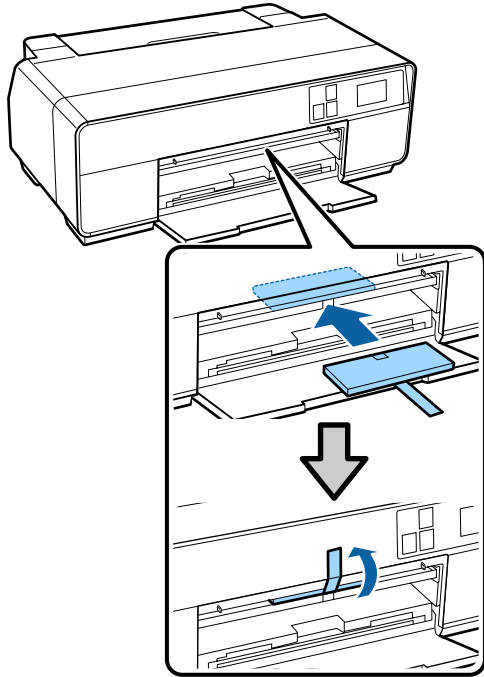

Bottom of the tray

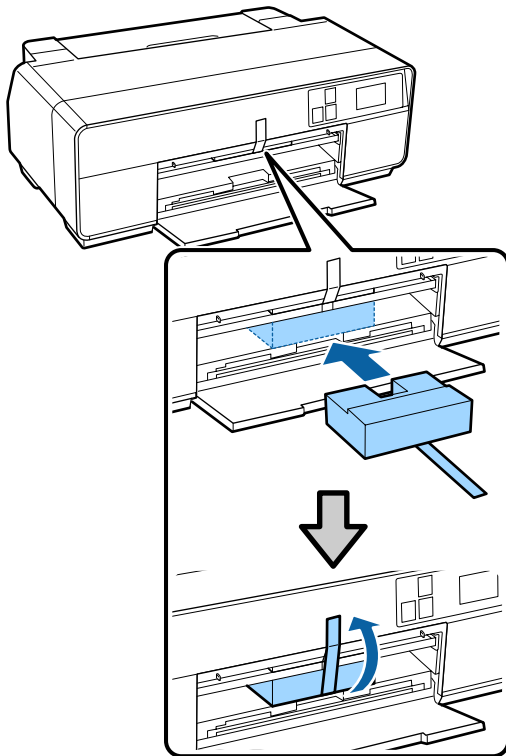

- 9** Close the front cover and secure it with commercially available tape and so on.

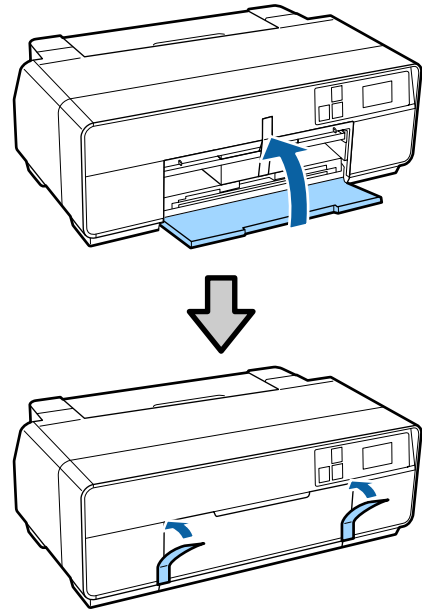

- 10** Keeping the printer flat, pack it in styrofoam or other protective material and place it in the box.

After Transport

Before using the printer for the first time after transport, check that the print head is not clogged.

 [“Checking for clogged nozzles” on page 94](#)

Appendix

Specifications Table

Printer Specifications	
Printing method	On-demand ink jet
Nozzle configuration	Black: 180 nozzles x3 (Photo Black/Matte Black, Light Light Black, Light Black)
	Color: 180 nozzles x5 (Yellow, Light Cyan, Vivid Light Magenta, Vivid Magenta, Cyan)
Resolution (maximum)	5760 x 1440 dpi
Control code	ESC/P raster (undisclosed commands) ESC/P-R
Paper feed method	Friction feed
Temperature	Operating: 10 to 35°C (50 to 95°F) Storage (before unpacking): -20 to 60°C (-4 to 140°F) (within 120 hours at 60°C (140°F), within a month at 40°C (104°F)) Storage (after unpacking): -20 to 40°C (-4 to 104°F) (within a month at 40°C (104°F))
Humidity	Operating: 20 to 80% (without condensation) Storage (before unpacking): 5 to 85% (without condensation) Storage (after unpacking): 5 to 85% (without condensation)

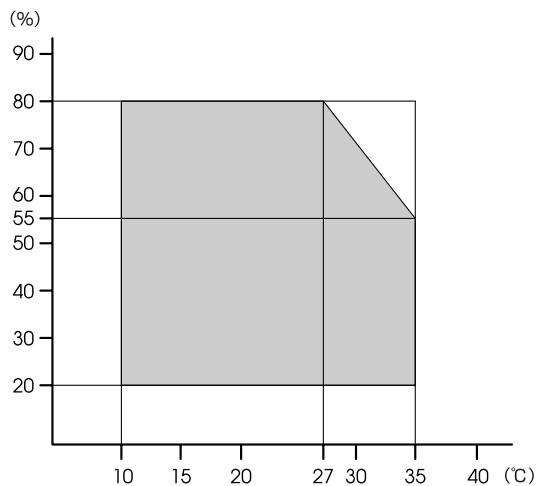

Printer Specifications	
External dimensions	Storage dimensions: (W) 616 x (D) 369 x (H) 228 mm Normal dimensions: (W) 616 x (D) 814 x (H) 424 mm
Weight	Approx. 15.0 kg (without ink cartridges)
Interface	High-Speed USB x 1 (for connection to computers). Ethernet 10BASE-T, 100BASE-TX* IEEE802.11b/g/n

* Use a shielded twisted-pair cable (Category 5 or higher).

Electrical			
		100-120 V Model	220-240 V Model
Input voltage range		AC 90 - 132 V	AC 198 - 264 V
Rated frequency range		50/60 Hz	
Input frequency range		49.5 - 60.5 Hz	
Rated current		0.6 A	0.3 A
Power consumption	Printing	Approx. 20 W (ISO/IEC24712)	Approx. 20 W (ISO/IEC24712)
	Ready mode	Approx. 5.3 W	Approx. 5.3 W
	Sleep mode	Approx. 1.4 W	Approx. 1.4 W
	Power off	Approx. 0.15 W	Approx. 0.3 W

Network		
Wireless LAN	Standard:	IEEE 802.11b/g/n
	Security:	WPA-PSK (TKIP/AES) WPA2 compliant, WEP (64/128bit)
	Frequency Band:	2.4 GHz
	Communication Mode:	Infrastructure mode, Ad hoc*

Appendix

Network		
Wired LAN	Standard:	Ethernet 100BASE-TX/10 BASE-T

*: IEEE802.11n is not supported.

Ink Specifications	
Type	Special ink cartridges
Pigment ink	Black: Photo Black, Matte Black, Light Black, Light Light Black Color: Yellow, Cyan, Light Cyan, Vivid Magenta, Vivid Light Magenta
Use by date	See the date printed on the package and cartridge (at normal temperature)
Print quality guarantee expiry	Six months (after opening the package)
Storage temperature	Uninstalled: -20 to 40°C (within a month at 40°C) Installed: -20 to 40°C (within a month at 40°C)



Important:

- The ink freezes if left at below -15°C for a long time. If the ink does freeze, leave it at room temperature (25°C, no condensation) for at least three hours before use.*
- Do not refill the ink.*

Supported operating systems
Windows Vista/Windows Vista x64 Windows 7/Windows 7 x64 Windows 8/Windows 8 x64 Windows 8.1/Windows 8.1 x64 Mac OS X 10.6.8/10.7.x/10.8.x/10.9.x

Standards and Approvals

U.S. model:

Safety	UL60950-1 CAN/CSA-C22.2 No.60950-1
EMC	FCC Part 15 Subpart B Class B CAN/CSA-CEI/IEC CISPR 22 Class B (CAN ICES-3(B) / NMB-3(B))

This equipment contains the following wireless module.

- Manufacturer: ASKEY Computer Corp.
- Type: WLU6117-D69 (WLU6117-D69 (RoHS))

This product conforms to Part 15 of the FCC Rules and RSS-210 of the IC Rules.

Epson cannot accept responsibility for any failure to satisfy the protection requirements resulting from a non-recommended modification of the product.

To prevent radio interference to the licensed service, this device is intended to be operated indoors and away from windows to provide maximum shielding. Equipment (or its transmit antenna) that is installed outdoors is subject to licensing.

This device complies with part 15 of the FCC Rules. Operation is subject to the following two conditions:(1) This device may not cause harmful interference, and (2) this device must accept any interference received, including interference that may cause undesired operation.

This device complies with Industry Canada licence-exempt RSS standard(s). Operation is subject to the following two conditions:(1) this device may not cause interference, and (2) this device must accept any interference, including interference that may cause undesired operation of the device.

This equipment has been tested and found to comply with the limits for a Class B digital device, pursuant to part 15 of the FCC Rules. These limits are designed to provide reasonable protection against harmful interference in a residential installation. This equipment generates, uses and can radiate radio frequency energy and, if not installed and used in accordance with the instructions, may cause harmful interference to radio communications. However, there is no guarantee that interference will not occur in a particular installation. If this equipment does cause harmful interference to radio or television reception, which can be determined by turning the equipment off and on, the user is encouraged to try to correct the interference by one or more of the following measures:

- Reorient or relocate the receiving antenna.
- Increase the separation between the equipment and receiver.
- Connect the equipment into an outlet on a circuit different from that to which the receiver is connected.

Appendix

- Consult the dealer or an experienced radio/TV technician for help.

European model:

Low Voltage Directive 2006/95/EC	EN60950-1
EMC directive 2004/108/EC	EN55022 Class B EN61000-3-2 EN61000-3-3 EN55024
R&TTE Directive 1999/5/EC	EN300 328 EN301 489-1 EN301 489-17 EN60950-1 EN50566

For European users:

We, Seiko Epson Corporation, hereby declare that this equipment Model B471A is in compliance with the essential requirements and other relevant provisions of Directive 1999/5/EC.

For use only in Ireland, UK, Austria, Germany, Liechtenstein, Switzerland, France, Belgium, Luxemburg, Netherlands, Italy, Portugal, Spain, Denmark, Finland, Norway, Sweden, Iceland, Cyprus, Greece, Slovenia, Bulgaria, Czech, Estonia, Hungary, Latvia, Lithuania, Poland, Romania, Slovakia, Malta, and Croatia.

Only indoor operation is permitted in France. If used outside of own premises, general authorization is required in Italy.

Epson cannot accept responsibility for any failure to satisfy the protection requirements resulting a non-recommended modification of the products.



Where To Get Help

Technical Support Web Site

Epson's Technical Support Web Site provides help with problems that cannot be solved using the troubleshooting information in your product documentation. If you have a Web browser and can connect to the Internet, access the site at:

<http://support.epson.net/>

If you need the latest drivers, FAQs, manuals, or other downloadables, access the site at:

<http://www.epson.com>

Then, select the support section of your local Epson Web site.

Contacting Epson Support

Before Contacting Epson

If your Epson product is not operating properly and you cannot solve the problem using the troubleshooting information in your product documentation, contact Epson support services for assistance. If Epson support for your area is not listed below, contact the dealer where you purchased your product.

Epson support will be able to help you much more quickly if you give them the following information:

- Product serial number
(The serial number label is usually on the back of the product.)
- Product model
- Product software version
(Select **About**, **Version Info**, or similar options in the product software.)
- Brand and model of your computer
- Your computer operating system name and version
- Names and versions of the software applications you normally use with your product

Where To Get Help

Help for Users in North America

Epson provides the technical support services listed below.

Internet Support

Visit Epson's support website at <http://epson.com/support> and select your product for solutions to common problems. You can download drivers and documentation, get FAQs and troubleshooting advice, or e-mail Epson with your questions.

Speak to a Support Representative

Dial:(562) 276-1300 (U.S.), or (905) 709-9475 (Canada), 6 am to 6 pm, Pacific Time, Monday through Friday. Days and hours of support are subject to change without notice. Toll or long distance charges may apply.

Before you call Epson for support, please have the following information ready:

- Product name
- Product serial number
- Proof of purchase (such as a store receipt) and date of purchase
- Computer configuration
- Description of the problem

Note:

For help using any other software on your system, see the documentation for that software for technical support information.

Purchase Supplies and Accessories

You can purchase genuine Epson ink cartridges, ribbon cartridges, paper, and accessories from an Epson authorized reseller. To find the nearest reseller, call 800-GO-EPSON (800-463-7766). Or you can purchase online at <http://www.epsonstore.com> (U.S. sales) or <http://www.epson.ca> (Canadian sales).

Help for Users in Europe

Check your **Pan-European Warranty Document** for information on how to contact Epson support.

Help for Users in Taiwan

Contacts for information, support, and services are:

World Wide Web (<http://www.epson.com.tw>)

Information on product specifications, drivers for download, and products enquiry are available.

Epson HelpDesk (Phone: +0800212873)

Our HelpDesk team can help you with the following over the phone:

- Sales enquiries and product information
- Product usage questions or problems
- Enquiries on repair service and warranty

Repair service center:

Telephone number	Fax number	Address
02-23416969	02-23417070	No.20, Beiping E. Rd., Zhongzheng Dist., Taipei City 100, Taiwan
02-27491234	02-27495955	1F., No.16, Sec. 5, Nanjing E. Rd., Songshan Dist., Taipei City 105, Taiwan
02-32340688	02-32340699	No.1, Ln. 359, Sec. 2, Zhongshan Rd., Zhonghe City, Taipei County 235, Taiwan
039-605007	039-600969	No.342-1, Guangrong Rd., Luodong Township, Yilan County 265, Taiwan
038-312966	038-312977	No.87, Guolian 2nd Rd., Hualien City, Hualien County 970, Taiwan

Where To Get Help

Telephone number	Fax number	Address
03-4393119	03-4396589	5F., No.2, Nandong Rd., Pingzhen City, Taoyuan County 32455, Taiwan (R.O.C.)
03-5325077	03-5320092	1F., No.9, Ln. 379, Sec. 1, Jingguo Rd., North Dist., Hsinchu City 300, Taiwan
04-23011502	04-23011503	3F., No.30, Dahe Rd., West Dist., Taichung City 40341, Taiwan (R.O.C.)
04-23805000	04-23806000	No.530, Sec. 4, Henan Rd., Nantun Dist., Taichung City 408, Taiwan
05-2784222	05-2784555	No.463, Zhongxiao Rd., East Dist., Chiayi City 600, Taiwan
06-2221666	06-2112555	No.141, Gongyuan N. Rd., North Dist., Tainan City 704, Taiwan
07-5520918	07-5540926	1F., No.337, Minghua Rd., Gushan Dist., Kaohsiung City 804, Taiwan
07-3222445	07-3218085	No.51, Shandong St., Sanmin Dist., Kaohsiung City 807, Taiwan
08-7344771	08-7344802	1F., No.113, Shengli Rd., Pingtung City, Pingtung County 900, Taiwan

Help for Users in Australia

Epson Australia wishes to provide you with a high level of customer service. In addition to your product documentation, we provide the following sources for obtaining information:

Your Dealer

Don't forget that your dealer can often help identify and resolve problems. The dealer should always be the first call for advise on problems; they can often solve problems quickly and easily as well as give advise on the next step to take.

Internet URL

<http://www.epson.com.au>

Access the Epson Australia World Wide Web pages. Worth taking your modem here for the occasional surf! The site provides a download area for drivers, Epson contact points, new product information and technical support (e-mail).

Epson Helpdesk

Epson Helpdesk is provided as a final backup to make sure our clients have access to advice. Operators on the Helpdesk can aid you in installing, configuring and operating your Epson product. Our Pre-sales Helpdesk staff can provide literature on new Epson products and advise where the nearest dealer or service agent is located. Many types of queries are answered here.

The Helpdesk numbers are:

Phone: 1300 361 054

Fax: (02) 8899 3789

We encourage you to have all the relevant information on hand when you ring. The more information you prepare, the faster we can help solve the problem. This information includes your Epson product documentation, type of computer, operating system, application programs, and any information you feel is required.

Help for Users in Singapore

Sources of information, support, and services available from Epson Singapore are:

Where To Get Help

World Wide Web

(<http://www.epson.com.sg>)

Information on product specifications, drivers for download, Frequently Asked Questions (FAQ), Sales Enquiries, and Technical Support via e-mail are available.

Epson HelpDesk

(Phone: (65) 6586 3111)

Our HelpDesk team can help you with the following over the phone:

- Sales enquiries and product information
- Product usage questions or problems
- Enquiries on repair service and warranty

Help for Users in Thailand

Contacts for information, support, and services are:

World Wide Web

(<http://www.epson.co.th>)

Information on product specifications, drivers for download, Frequently Asked Questions (FAQ), and e-mail are available.

Epson Hotline

(Phone: (66)2685-9899)

Our Hotline team can help you with the following over the phone:

- Sales enquiries and product information
- Product usage questions or problems
- Enquiries on repair service and warranty

Help for Users in Vietnam

Contacts for information, support, and services are:

Epson Hotline (Phone): 84-8-823-9239

Service Center: 80 Truong Dinh Street,
District 1, Hochiminh City
Vietnam

Help for Users in Indonesia

Contacts for information, support, and services are:

World Wide Web

(<http://www.epson.co.id>)

- Information on product specifications, drivers for download
- Frequently Asked Questions (FAQ), Sales Enquiries, questions through e-mail

Epson Hotline

- Sales enquiries and product information
- Technical support

Phone (62) 21-572 4350

Fax (62) 21-572 4357

Epson Service Center

Jakarta Mangga Dua Mall 3rd floor No 3A/B
Jl. Arteri Mangga Dua,
Jakarta

Phone/fax: (62) 21-62301104

Bandung Lippo Center 8th floor
Jl. Gatot Subroto No.2
Bandung

Phone/fax: (62) 22-7303766

Surabaya Hitech Mall It IIB No. 12
Jl. Kusuma Bangsa 116 – 118
Surabaya

Phone:(62) 31-5355035

Fax: (62)31-5477837

Where To Get Help

Yogyakarta	Hotel Natour Garuda Jl. Malioboro No. 60 Yogyakarta
	Phone: (62) 274-565478
Medan	Wisma HSBC 4th floor Jl. Diponegoro No. 11 Medan
	Phone/fax: (62) 61-4516173
Makassar	MTC Karebosi Lt. III Kav. P7-8 Jl. Ahmad Yani No.49 Makassar
	Phone: (62)411-350147/411-350148

Help for Users in Hong Kong

To obtain technical support as well as other after-sales services, users are welcome to contact Epson Hong Kong Limited.

Internet Home Page

Epson Hong Kong has established a local home page in both Chinese and English on the Internet to provide users with the following information:

- Product information
- Answers to Frequently Asked Questions (FAQs)
- Latest versions of Epson product drivers

Users can access our World Wide Web home page at:

<http://www.epson.com.hk>

Technical Support Hotline

You can also contact our technical staff at the following telephone and fax numbers:

Phone: (852) 2827-8911

Fax: (852) 2827-4383

Help for Users in Malaysia

Contacts for information, support, and services are:

World Wide Web

(<http://www.epson.com.my>)

- Information on product specifications, drivers for download
- Frequently Asked Questions (FAQ), Sales Enquiries, questions through e-mail

Epson Trading (M) Sdn. Bhd.

Head Office.

Phone: 603-56288288

Fax: 603-56288388/399

Epson Helpdesk

- Sales enquiries and product information (Infoline)

Phone: 603-56288222

- Enquiries on repair services & warranty, product usage and technical support (Techline)

Phone: 603-56288333

Help for Users in India

Contacts for information, support, and services are:

World Wide Web

(<http://www.epson.co.in>)

Information on product specifications, drivers for download, and products enquiry are available.

Epson India Head Office - Bangalore

Phone: 080-30515000

Fax: 30515005

Where To Get Help

Epson India Regional Offices:

Location	Telephone number	Fax number
Mumbai	022-28261515 / 16/17	022-28257287
Delhi	011-30615000	011-30615005
Chennai	044-30277500	044-30277575
Kolkata	033-22831589 / 90	033-22831591
Hyderabad	040-66331738/ 39	040-66328633
Cochin	0484-2357950	0484-2357950
Coimbatore	0422-2380002	NA
Pune	020-30286000 / 30286001 /30286002	020-30286000
Ahmedabad	079-26407176 / 77	079-26407347

Helpline

For Service, Product info or to order a cartridge - 18004250011 (9AM - 9PM) - This is a Toll-free number.

For Service (CDMA & Mobile Users) - 3900 1600 (9AM - 6PM) Prefix local STD code

Help for Users in the Philippines

To obtain technical support as well as other after sales services, users are welcome to contact the Epson Philippines Corporation at the telephone and fax numbers and e-mail address below:

Trunk Line: (63-2) 706 2609

Fax: (63-2) 706 2665

Helpdesk Direct Line: (63-2) 706 2625

E-mail: epchelpdesk@epc.epson.com.ph

World Wide Web

(<http://www.epson.com.ph>)

Information on product specifications, drivers for download, Frequently Asked Questions (FAQ), and E-mail Enquiries are available.

Toll-Free No. 1800-1069-EPSON(37766)

Our Hotline team can help you with the following over the phone:

- Sales enquiries and product information
- Product usage questions or problems
- Enquiries on repair service and warranty