

# TOSHIBA

Leading Innovation >>>



**TL96\* Digital  
Series**  
**UL97\* Digital  
Series**



# Contents

## INSTALLING YOUR TV

Safety Precautions .....	4
Installation and important information .....	5
The remote control .....	8
Inserting batteries and effective range .....	8

## CONNECTING YOUR TV

Connecting external equipment .....	9
Connecting an HDMI® device .....	10
To connect an HDMI device .....	10
HDMI's ARC (Audio Return Channel) feature .....	10
REGZA-LINK connection .....	11
Connecting a computer .....	12
To connect a PC to the RGB/PC terminal .....	12
To connect a PC to the HDMI terminal .....	12
Connecting a home network .....	13
To connect the TV to a home network - Wired .....	13
To connect the TV to a home network with an internet connection - Wireless .....	13
Controls and input connections .....	14
Switching on .....	14
Using the menu system .....	14
Using the TV controls and connections .....	14
MENU structure .....	15

## SETTING UP YOUR TV

Startup Application .....	16
Quick Setup .....	16
Ant/Cable/Satellite (if available) .....	19
Satellite Settings .....	20
Auto Tuning .....	22
ATV Manual Tuning .....	23
Tuning .....	23
Skip .....	24
Sorting positions .....	25
DTV Manual Tuning .....	25
Manual Tuning .....	25
Manual Tuning for DVB-C .....	26
Manual Tuning for DVB-S .....	26
DTV Settings .....	26
Channels (Antenna/Cable) .....	26
Channels (Satellite) .....	27
Standby Channel Update .....	27
Location setting .....	27
<b>Analogue</b> switch-off .....	27

## CONTROLS AND FEATURES

General controls .....	28
Quick Menu .....	28
Selecting channels .....	28
The Time Display – <b>analogue</b> only .....	28
Stereo and Bilingual transmissions .....	28

Using 3D functions .....	29
Using the 3D glasses .....	29
Viewing 3D images .....	30
Switching display mode or selecting 3D format .....	30
Setting the auto start mode .....	32
Adjusting 2D to 3D Depth .....	32
Setting the 3D PIN code .....	32
Setting 3D Start Message .....	32
Setting 3D Lock .....	33
Setting 3D Timer Lock .....	33
Setting Enable 3D Timer .....	33
Displaying 3D Important Info .....	33
Switching left and right images .....	33
Sound controls .....	34
Volume controls and sound mute .....	34
Dual .....	34
Balance .....	34
Bass, Treble .....	34
Voice Enhancement .....	34
Dynamic Bass Boost .....	34
Stable Sound® .....	34
Dynamic Range Control .....	34
Audio Level Offset .....	35
TV Speakers On/Off .....	35
Headphone Settings .....	35
Audio Description .....	35
Widescreen viewing .....	36
Picture controls .....	38
Picture Mode .....	38
Picture preferences .....	38
Reset .....	38
ColourMaster .....	38
Base Colour Adjustment .....	39
Colour Temperature .....	39
Auto Brightness Sensor .....	39
Active Backlight Control .....	39
Black/White Level .....	39
MPEG NR – Noise Reduction .....	40
DNR – Digital Noise Reduction .....	40
Active Vision .....	40
Resetting the advanced picture settings .....	40
Automatic Format (Widescreen) .....	40
4:3 Stretch .....	40
Blue Screen .....	40
Picture Position .....	41
Picture still .....	41
Using your home network .....	42
Setting up the Network .....	43
Wireless Setup .....	43
Advanced Network Setup .....	45
DNS Setup .....	46
Network Connection Test .....	46
Using the software keyboard .....	47
Network Device Setup .....	47
External Control Setup .....	47
Device Name Setup .....	48
Using Toshiba Places .....	48
Using YouTube™ .....	49

Using Hybrid TV Standard (if available) .....	49	Using REGZA-LINK .....	69
Using the Media Player .....	50	Enable REGZA-LINK .....	69
Basic operation .....	50	TV Auto Power .....	69
Viewing photo files		Auto Standby .....	69
(on a DLNA CERTIFIED™ Server or USB device) .....	51	REGZA-LINK input source selection .....	69
Viewing movie files		REGZA-LINK one touch play .....	70
(on a DLNA CERTIFIED™ Server or USB device) .....	53	REGZA-LINK system standby .....	70
Playing music files			
(on a DLNA CERTIFIED™ Server or USB device) .....	56		
Other features .....	57	<b>TEXT SERVICES</b>	
Panel Lock .....	57	Text services .....	71
The timers .....	57	Selecting modes .....	71
Programme Timers – <b>digital</b> only .....	57	Text information .....	71
On Timer .....	58	Navigating pages using Auto .....	71
Sleep Timer .....	58	Navigating pages using LIST .....	71
Energy Saving Settings .....	59	Control buttons .....	72
Automatic Power Down .....	59		
No Signal Power Down .....	59	<b>PROBLEM SOLVING</b>	
Digital on-screen information .....	59	<b>Questions and Answers</b> .....	73
Information .....	59		
Using EPG (Electronic Programme Guide) .....	60	<b>INFORMATION</b>	
Using Broadcast Guide .....	60	License Information .....	76
Genre selection/searching .....	61	Information .....	78
Using MediaGuide .....	61	Specifications and accessories .....	84
MediaGuide screen .....	61		
Primary Navigation menu .....	61		
<b>Digital</b> settings – parental control .....	62		
Parental PIN Setup .....	62		
Parental Setup .....	63		
Network Lock .....	63		
<b>Digital</b> settings – Channel Options .....	63		
Selecting favourite channels .....	63		
Favourite Channel List .....	63		
Skip channels .....	64		
Locking channels .....	64		
<b>Digital</b> settings – other settings .....	64		
Subtitles .....	64		
Audio languages .....	64		
Common Interface .....	65		
Software Upgrade and Licences .....	65		
Searching for New Software .....	65		
Network Upgrade .....	65		
Software Licences .....	65		
System Information and Reset TV .....	66		
System Information .....	66		
Reset TV .....	66		
PC Settings .....	66		
Horizontal and Vertical Position .....	66		
Clock Phase .....	66		
Sampling Clock .....	67		
Reset .....	67		
Input selection and AV connections .....	67		
Input selection .....	67		
Labeling video input sources .....	68		
Digital Audio Output .....	68		

## Safety Precautions

This equipment has been designed and manufactured to meet international safety standards but, like any electrical equipment, care must be taken to obtain the best results and for safety to be assured. Please read the points below for your own safety. They are of a general nature, intended to help with all electronic consumer products, and some points may not apply to the goods you have just purchased.

### Air Circulation

Leave more than 10cm clearance around the television to allow adequate ventilation. This will prevent overheating and possible damage to the television. Dusty places should also be avoided.

### Heat Damage

Damage may occur if the television is left in direct sunlight or near a heater. Avoid places subject to extremely high temperatures or humidity. Place in a location where the temperature remains between 5°C min. and 35°C max.

### Mains Supply

The mains supply required for this equipment is 220-240v AC 50/60Hz. Never connect to a DC supply or any other power source. DO ensure that the television is not standing on the mains lead. Use only the supplied lead.

DO NOT cut off the mains plug from this equipment, this incorporates a special Radio Interference Filter, the removal of which will impair its performance. IF IN DOUBT, PLEASE CONSULT A COMPETENT ELECTRICIAN.

### Do

**DO** read the operating instructions before you attempt to use the equipment.

**DO** ensure that all electrical connections (including the mains plug, extension leads and inter-connections between pieces of equipment) are properly made and in accordance with the manufacturers' instructions. Switch off and withdraw the mains plug before making or changing connections.

**DO** consult your dealer if you are ever in doubt about the installation, operation or safety of your equipment.

**WARNING:** To prevent injury, this apparatus must be securely attached to the floor/wall in accordance with the installation instructions. See page 5.

**DO** be careful with glass panels or doors on equipment.

**DO NOT REMOVE ANY FIXED COVERS AS THIS WILL EXPOSE DANGEROUS AND 'LIVE' PARTS.**

**THE MAINS PLUG IS USED AS A DISCONNECTING DEVICE AND THEREFORE SHOULD BE READILY OPERABLE.**

### Do not

**DO NOT** obstruct the ventilation openings of the equipment with items such as newspapers, tablecloths, curtains, etc. Overheating will cause damage and shorten the life of the equipment.

**DO NOT** allow electrical equipment to be exposed to dripping or splashing or objects filled with liquids, such as vases, to be placed on the equipment.

**DO NOT** place hot objects or naked flame sources, such as lighted candles or nightlights on, or close to equipment. High temperatures can melt plastic and lead to fires.



**WARNING:** To prevent the spread of fire, keep candles or other open flames away from this product at all times.

**DO NOT** use makeshift stands and NEVER fix legs with wood screws. To ensure complete safety, always fit the manufacturer's approved stand, bracket or legs with the fixings provided according to the instructions.

**DO NOT** leave equipment switched on when it is unattended, unless it is specifically stated that it is designed for unattended operation or has a standby mode. Switch off by withdrawing the plug, and make sure your family knows how to do this. Special arrangements may need to be made for people with disabilities.

**DO NOT** continue to operate the equipment if you are in any doubt about it working normally, or it is damaged in any way – switch off, withdraw the mains plug and consult your dealer.

**WARNING:** Excessive sound pressure from earphones or headphones can cause hearing loss.

**ABOVE ALL - NEVER let anyone, especially children, push or hit the screen and cabinet back, or push anything into holes, slots or any other openings in the case. These actions will damage screen or internal parts.**

**NEVER guess or take chances with electrical equipment of any kind - it is better to be safe than sorry.**

# Installation and important information

## Where to install

Locate the television away from direct sunlight and strong lights. Soft, indirect lighting is recommended for comfortable viewing. Use curtains or blinds to prevent direct sunlight falling on the screen.

**Place the TV on a stable, level surface that can support the weight of the TV. In order to prevent injury and maintain stability of this apparatus, secure the TV to the level surface using the strap if fitted, or to a wall using a sturdy tie to the P clips provided. Otherwise secure the TV on the level surface using the supplied mounting screw.**

The LCD display panels are manufactured using an extremely high level of precision technology; however, sometimes some parts of the screen may be missing picture elements or have luminous spots. This is not a sign of a malfunction.

Make sure the television is located in a position where it cannot be pushed or hit by objects, as pressure will break or damage the screen. Also, please be certain that small items cannot be inserted into slots or openings in the case.

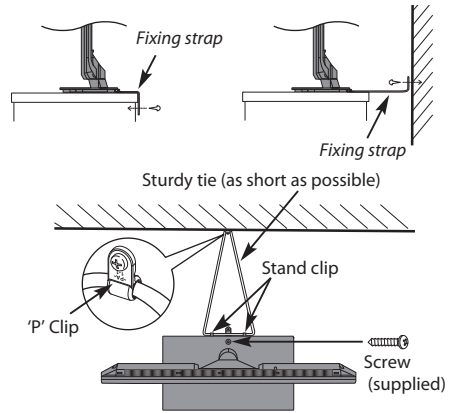

**Stand style is dependent on model**



Avoid using chemicals (such as air refreshers, cleaning agents, etc.) on or near the TV pedestal. Studies indicate that plastics may weaken and crack over time from the combination effects of chemical agents and mechanical stress (such as weight of TV). Failure to follow these instructions could result in serious injury and/or permanent damage to TV and TV pedestal.

## When using a Wall Bracket

Please use a wall bracket appropriate for the size and weight of the LCD TV.

- Two people are required for installation.
- To install a wall-mount from another manufacturer, use the **SPACERS** (supplied).

- 1 Unplug and remove any cables and/or other component connectors from the rear of the TV.
- 2 Carefully lay the front of the unit face down on a flat, cushioned surface such as a quilt or blanket.
- 3 Follow the instructions provided with your wall bracket. Before proceeding, make sure the appropriate bracket(s) are attached to the wall and the back of the TV as described in the instructions provided with the wall bracket.
- 4 Make sure to place the spacers supplied between the bracket and the back of the TV.
- 5 Always use the screws supplied or recommended by the wall mount manufacturer.

## Removing the Pedestal Stand:

- 1 Carefully lay the front of the unit face down on a flat, cushioned surface such as a quilt or blanket. Leave the stand protruding over the edge of the surface.

**NOTE:** Extreme care should always be used when removing the pedestal stand to avoid damage to the LCD panel.

- 2 Remove the four screws.

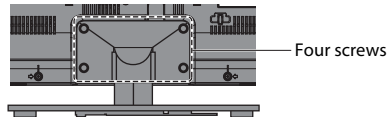

- 3 Once you have removed all four screws holding the pedestal stand in place, remove the pedestal stand from the TV by sliding the pedestal stand away from the TV.

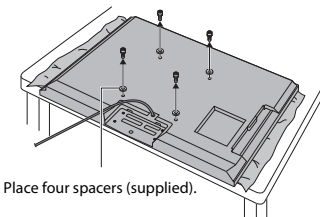

Place four spacers (supplied).

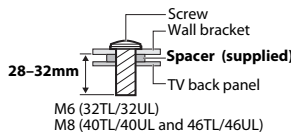

**CAUTION:** The diameter and length of the screws differ depending on wall bracket model. Use of screws other than the screws specified may result in internal damage to the TV set or cause it to fall, etc.

## When using the 3D glasses

### Available 3D glasses : Toshiba FPT-AG02G

UL97 series : Supplied

TL96 series : Not supplied

- **The 3D function has been designed for private use and entertainment in your home environment. Please note that any commercial use of the 3D function could lead to copyright infringement of authors' rights. Toshiba asks you to respect the intellectual property rights of third parties.**

### About handling the 3D glasses

- **Do not leave the 3D glasses or the accessories within the reach of small children.**

Inhaling or swallowing them may cause suffocation or lesions in the stomach wall.

If swallowed, consult a doctor immediately.

- **Do not repair, modify, or disassemble the 3D glasses by yourself.**

Doing so may cause a fire or cause you to become indisposed while viewing 3D images.

Contact the Toshiba Call Center for repair of your 3D glasses.

- **Do not expose the glasses to excessive heat such as sunshine, fire, or the like.**

### About the 3D glasses

- **Do not use the 3D glasses if they are not working properly or broken.**

Continuing to use them in such a state may cause injury, eye strain, or indisposition.

Do not use the 3D glasses if they are broken or have any cracks.

- **Do not stand or walk while wearing 3D glasses.**

You may lose your balance which could result in falls or other accidents.

- **Do not wear the 3D glasses for any purpose other than viewing 3D programming.**

3D glasses do not function as sunglasses.

- **Do not drop, exert pressure on, or step on the 3D glasses.**

Doing so may damage the glass section, which may result in injury.

Exposing the 3D glasses to liquid or excessive heat may damage the liquid crystal shutter function.

- **If your nose or temple turns red, or you feel pain or discomfort, stop using the 3D glasses.**

Such symptoms as above may occur if you keep wearing them for a long time, which may also cause indisposition.

- **Be careful not to pinch your fingers in the hinge of the 3D glasses.**

### Cautions on watching 3D images

- **Some viewers may experience a seizure or blackout when exposed to certain flashing images or lights contained in certain 3D television pictures or video games.**

Anyone who has had a seizure, loss of awareness, or other symptoms linked to an epileptic condition, or has a family history of epilepsy, should contact a health care provider before using the 3D function.

- **Avoid use of the 3D function when under the influence of alcohol.**
- **If you are ill or feel ill, you should refrain from viewing 3D images, and consult your health care provider as may be appropriate.**
- **If you experience any of the following symptoms when viewing 3D video images, stop viewing and contact your health care provider:**

Convulsions, eye or muscle twitching, loss of awareness, altered vision, involuntary movements, disorientation, eye strain, nausea/vomiting, dizziness, headaches.

- **If you feel eye fatigue or other discomfort from viewing 3D video images, remove the 3D glasses and discontinue use until the condition is eliminated.**
- **Viewing in 3D may cause dizziness and/or disorientation for some viewers.**

Therefore, to avoid injury do not place your TV near open stairwells, balconies, or wires.

Also do not sit near objects that could be broken if accidentally hit.

- **When viewing 3D images, always wear 3D glasses.**

Watching 3D images without 3D glasses may cause eye strain.

Use specified 3D glasses.

- **When watching 3D images, do not wear 3D glasses at an angle and do not lie down.**

If you watch while lying down or with the glasses tilted, the 3D effect is lost and it may cause eye strain.

- **It is recommended that the viewer's eyes and 3D glasses are level with the screen.**

- **If you have prescription eye glasses or contact lenses, wear the 3D glasses over them.**

Watching 3D images without appropriate eyewear may cause eye strain.

- **If 3D images often appear in double or if you cannot see the images in 3D, stop viewing.**

Continuous viewing may cause eye strain.

- **Due to the possible impact on vision development, viewers of 3D video images should be age 6 or above.**

Children and teenagers may be more susceptible to health issues associated with viewing in 3D and should be closely supervised to avoid prolonged viewing without rest.

- **Watching TV while sitting too close to the screen for an extended period of time may cause eye strain.**

The ideal viewing distance should be at least three times the screen height.

### If the 3D PIN number has been forgotten:

Use the Master PIN code of 1276, and then change to a number of your choice. Select **3D PIN** from the **Preferences / 3D Setup** menu to enter PIN.

### Notes on handling the 3D glasses' liquid crystal shutter lenses

- Do not put excessive force on the lenses.
- Do not scratch the surface of the lenses with sharp objects.
- Do not drop or bend the 3D glasses.

### Notes on IR communication

- Do not block the IR sensor for 3D glasses on the TV by placing objects in front of it.
- Do not cover the IR sensor on the 3D glasses with stickers or labels.
- Keep the IR sensor on the 3D glasses clean.
- The use of 3D glasses could interfere with other IR communication devices. Other IR communication devices may cause the 3D glasses not to work correctly. Use the TV and 3D glasses in a place where they will not interfere with other devices or products.

### Notes on watching the TV

- 3D effect and image quality may vary depending upon content quality and display device capability/functionality/settings.
- If you use any device, such as a mobile phone or mobile wireless device, near the 3D glasses, the 3D glasses may not work correctly.

- Use the product in the following temperature range; otherwise, the quality of the 3D image or the reliability of the product cannot be guaranteed.
  - 3D glasses: 0°C - 40°C (32°F - 104°F)
  - TV: 0°C - 35°C (32°F - 95°F)
- If you use a fluorescent light, it may flicker depending on the frequency of the light. In this case, reduce the brightness of the fluorescent light, or use another light. (It is not recommended to watch the TV in a dark room, especially for children.)
- Wear the 3D glasses properly, otherwise you may not see the correct 3D image.
- When not viewing 3D images on this unit, take off the 3D glasses; otherwise, it may be difficult to see the display on other products such as PC, digital clock or calculator, etc.

### About the connecting cable

- Use a high-speed and high-quality HDMI cable when you connect a device such as 3D compatible BD player or PC to the TV. When you use a standard HDMI cable, 3D images may not be shown.

## Please take note

The digital reception function of this television is only effective in the countries listed in the "Country" section of the "System Setup" menu. Depending on country/area, some of this television's functions may not be available. Reception of future additional or modified services can not be guaranteed with this television.

If stationary images generated by 4:3 broadcasts, text services, channel identification logos, computer displays, video games, on-screen menus, etc. are left on the television screen for any length of time, they could become conspicuous. It is always advisable to reduce both the brightness and contrast settings.

Very long, continuous use of the 4:3 picture on a 16:9 screen may result in some retention of the image at the 4:3 outlines. This is not a defect of the LCD TV and is not covered under the manufacturer's warranty. Regular use of other size modes (e.g.: Super Live) will prevent permanent retention.

## EXCLUSION CLAUSE

Toshiba shall under no circumstances be liable for loss and/or damage to the product caused by:

- Fire;
- Earthquake;
- Accidental damage;
- Intentional misuse of the product;
- Use of the product in improper conditions;
- Loss and/or damage caused to the product whilst in the possession of a third party;
- Any damage or loss caused as a result of the owner's failure and/or neglect to follow the instructions set out in the owner's manual;
- Any loss or damage caused directly as a result of misuse or malfunction of the product when used simultaneously with associated equipment;

Furthermore, under no circumstances shall Toshiba be liable for any consequential loss and/or damage including but not limited to the following: loss of profit, interruption of business, the loss of recorded data whether caused during normal operation or misuse of the product.

# The remote control

Simple at-a-glance reference of your remote control.

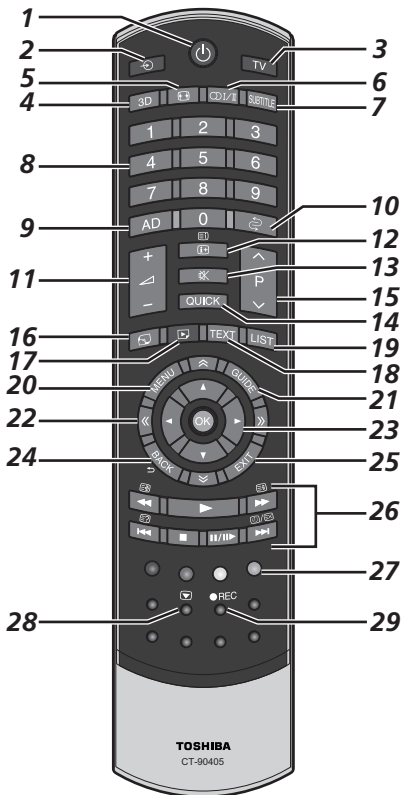

- 1 For On/Standby mode
- 2 To select external input sources
- 3 To select TV Mode (DTV Ant/DTV Cable/DTV Sat/ATV)
- 4 To switch between 2D and 3D modes
- 5 Widescreen viewing
- 6 Stereo/bilingual transmissions
- 7 Digital Subtitles or Analogue TEXT Subtitle pages if available
- 8 Number buttons
- 9 Switch the Audio Description On/Off
- 10 To return to previous channel
- 11 To alter the TV volume
- 12 To display on-screen information  
To access the index page in Text mode
- 13 To mute the TV sound
- 14 To access Quick Menu
- 15 To change programme positions  
To change TEXT pages

- 16 To access the "TOSHIBA PLACES" Top Page  
When network is not connected, an error message will be displayed.
- 17 To access Media Player Menu
- 18 To call up text services
- 19 To access the analogue or digital Channel List
- 20 On-screen Menus
- 21 To display the digital on-screen Programme Guide
- 22 To page up, down, left or right
- 23 When using menus, the arrows move the cursor on the screen up, down, left or right. Press **OK** to confirm your selection
- 24 To return to previous Menu
- 25 To exit menus and applications
- 26 **When in TV mode:**  
 Analogue time display
- When in Text mode:**  
 To reveal concealed text  
 To hold a wanted page  
 To enlarge text display size  
 To select a page while viewing a normal picture
- When using Programme Guide:**  
 -24 hours  
 +24 hours  
 -1 page  
 +1 page
- During Playback:**  
 To PLAY  
 To STOP  
 To PAUSE/STEP  
 To SKIP-BACK  
 To REWIND  
 To FAST FORWARD  
 To SKIP-FORWARD
- 27 **Colour buttons:** Text and interactive service control buttons
- 28 Picture still
- 29 Not available for this TV

## Inserting batteries and effective range

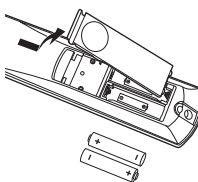

Remove the back cover to reveal the battery compartment and make sure the batteries are inserted the proper way. Suitable battery types for this remote are AA, IEC R6 1.5V.

Do not combine a used, old battery types with a new one or mix battery types. Remove dead batteries immediately to prevent acid from leaking into the battery compartment. Dispose of them in accordance with instructions on page 77 of this manual.

**Warning:** Batteries must not be exposed to excessive heat such as sunshine, fire or the like.

The performance of the remote control will deteriorate beyond a distance of five metres or outside an angle of 30 degrees from the centre of the television. If the operating range becomes reduced, the batteries may need replacing.



## Connecting external equipment

**Before connecting any external equipment, turn off all main power switches. If there is no switch, remove the mains plug from the wall socket.**

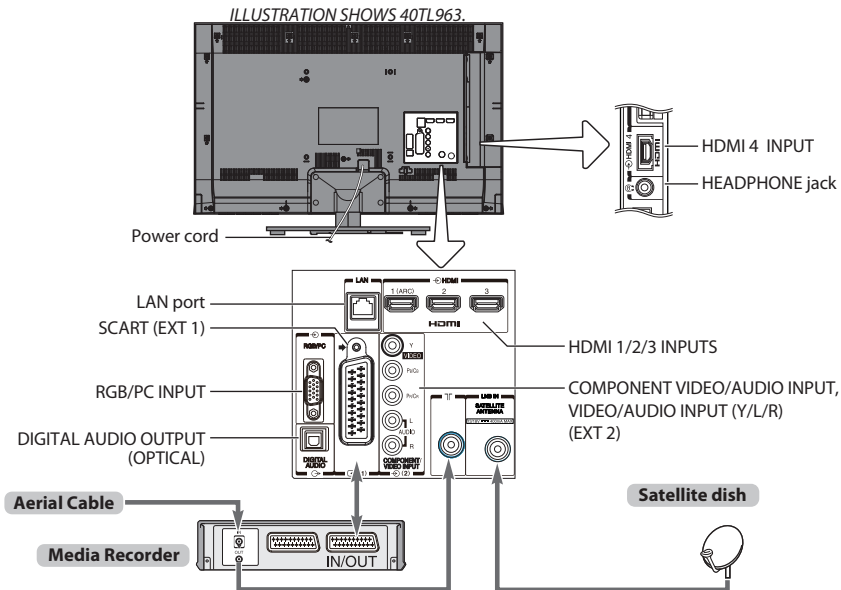

### Aerial cables:.....

Connect the aerial to the socket on the rear of the television. If you use a decoder and/or a media recorder, it is essential that the aerial cable is connected through the decoder and/or through the media recorder to the television.

### Satellite cable: .....

Connect the LNB from the satellite dish to the **SATELLITE ANTENNA** socket on the TV. You can receive TV, radio, interactive TV, and HD TV with clear reception.

### SCART leads:.....

Connect the media recorder **IN/OUT** socket to the television. Connect the decoder **TV** socket to the television.

Before running **Auto Tuning**, put your decoder and media recorder to **Standby**.

The RCA sockets alongside the **COMPONENT VIDEO INPUT** sockets will accept L and R audio signals.

When connecting the VIDEO/AUDIO devices, connect those cables to **Y/L/R** sockets.

The Digital Audio Output socket enables the connection of a suitable surround sound system.

**NOTE: This output is always active.**

HDMI® (High-Definition Multimedia Interface) is for use with a DVD decoder or electrical equipment with digital audio and video output. For acceptable video or PC signal formats through the HDMI terminals, see page 79.

**NOTE:** Although this television is able to connect to HDMI equipment, it is possible that some equipment may not operate correctly.

**LAN** port is used to connect the TV to your home network. This TV can play digital content stored on a DLNA CERTIFIED™ product with server function.

**A wide variety of external equipment can be connected to the back of the television; therefore, the relevant owner's manuals for all additional equipment must be referred to for exact instructions.**

If the television automatically switches over to monitor external equipment, return to normal television by pressing the desired programme position button. To recall external equipment, press **↻** to select between **TV**, **EXT 1**, **EXT 2**, **HDMI 1**, **HDMI 2**, **HDMI 3**, **HDMI 4** or **PC**.

When the external input mode is selected while viewing DTV mode, the SCART socket does not output video/audio signals.

## Connecting an HDMI® device

The HDMI input on your television receives digital audio and uncompressed digital video from an HDMI source device.

This input is designed to accept HDCP (High-Bandwidth Digital-Content Protection) programme material in digital form from EIA/CEA-861-D-compliant consumer electronic devices (such as a set-top box or DVD player with HDMI output). For acceptable video signal formats, see page 79.

**NOTE:** Supported Audio format: Linear PCM, Dolby Digital (AC-3), sampling rate 32/44.1/48kHz.

### To connect an HDMI device

Connect an HDMI cable (type A connector) to the HDMI terminal.

For proper operation, it is recommended that you use an HDMI cable with the HDMI Logo (HDMI™).

- If your HDMI connection is capable of 1080p and/or your television is capable of refresh rates greater than 50Hz, you will need a Category 2 cable. Conventional HDMI/DVI cable may not work properly with this model.
- HDMI cable transfers both video and audio. Separate analogue audio cables are not required (see illustration).

#### the back of your television

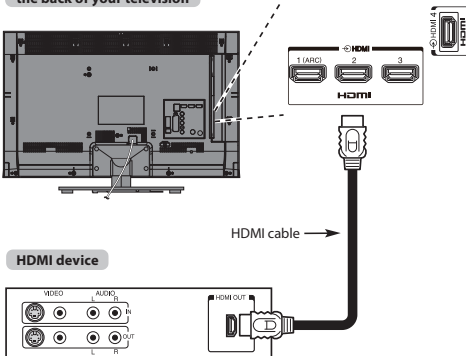

To view the HDMI device video, press the  button to select HDMI 1, HDMI 2, HDMI 3 or HDMI 4 mode.

### HDMI's ARC (Audio Return Channel) feature

This feature enables the audio signal of the TV to be sent to the AV amplifier via the HDMI cable. It will not be necessary to connect a cable from the audio output of the TV to the audio input of the AV amplifier to reproduce the audio received from the tuner of the TV through the AV amplifier.

#### the back of your television

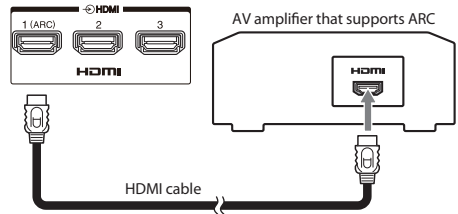

## REGZA-LINK connection

You can control the basic functions of connected audio/video devices using the television's remote control if you connect a REGZA-LINK compatible AV amplifier or playback device. For an explanation of setup and operations, see pages 69–70.

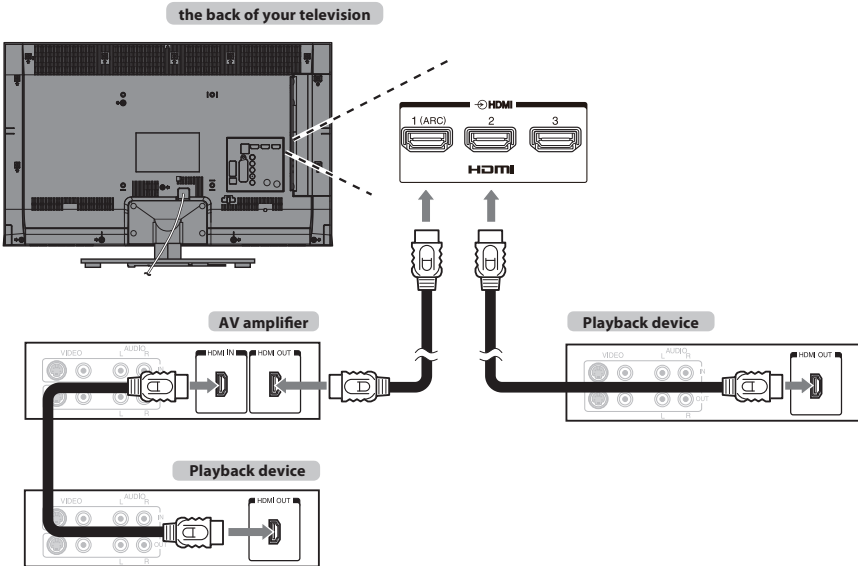

For the setup shown above, you will need three HDMI cables.

### NOTE:

- If several devices are connected, the REGZA-LINK feature may not operate properly.
- For proper operation, it is recommended that you use HDMI cables with the HDMI Logo (  ).
- This function is available when one PC and one AV amplifier are connected separately. However, it may not operate properly if the PC is connected via the AV amplifier.

### Before controlling the device(s):

- After completing the above connections, set the REGZA-LINK Setup menu as you desire (see page 69).
- The connected devices must also be set. For details, see the operation manual for each device.
- The REGZA-LINK feature uses CEC technology as regulated by the HDMI standard.
- This feature is limited to models incorporating Toshiba's REGZA-LINK. However, Toshiba is not liable for those operations. Refer to individual instruction manuals for compatibility information.

## Connecting a computer

With either an RGB/PC or an HDMI connection, you can watch your computer's display on the television.

### To connect a PC to the RGB/PC terminal

When connecting a PC to the RGB/PC terminal on the television, use an analogue RGB (15-pin) computer cable.

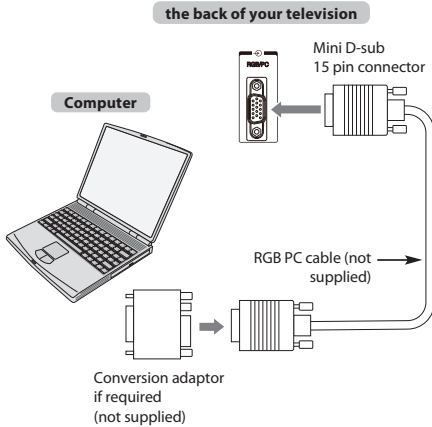

To use a PC, set the monitor output resolution on the PC before connecting it to the television. For acceptable PC signal formats, see page 78.

To display the optimum picture, use the PC setting feature (see page 66).

#### NOTE:

- Some PC models cannot be connected to this television.
- An adaptor is not needed for computers with a compatible mini D-sub15-pin terminal.
- Depending on the DVD's title and the specifications of the PC on which you are playing the DVD-Video, some scenes may be skipped or you may not be able to pause during multi-angle scenes.
- A band may appear at the edges of the screen or parts of the picture may be obscured. This is due to scaling of the picture by the set, it is not a malfunction.
- When PC input mode is selected, some of the television's features will be unavailable e.g. **Colour System** in the **System Setup** menu.
- Some PC models may output unique signals that the television may be unable to detect (see page 78).
- If connecting a certain PC model with a unique PC signal, the PC signal may not be detected correctly.

### To connect a PC to the HDMI terminal

When connecting a PC to the HDMI terminal on the television, use an HDMI-to-DVI adaptor cable.

If connecting a PC with an HDMI terminal, use an HDMI cable (type A connector).

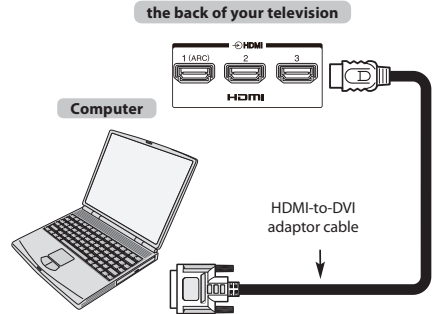

For acceptable PC and video signal formats, see page 79.

#### NOTE:

- The edges of the images may be hidden.
- If connecting a certain PC model with a unique PC signal, the PC signal may not be detected correctly.

## Connecting a home network

The LAN port allows your Toshiba TV to connect to your home network. You can use this revolutionary home entertainment networking system to access photo, video and audio files that are stored on a DLNA CERTIFIED™ server and play/display them on your TV.

### NOTE:

- If you connect to a shared network outside your home, it is advisable to use a router. Always use DLNA CERTIFIED™ products in private network environments. Connect this TV to the same router as other DLNA CERTIFIED™ products (server).
- If you use a hub or switch to connect the TV to your home network, you may not be able to use the automatic setup and will have to manually set up the network address. See page 45.
- If you use a router with built-in DHCP functionality, use the automatic setup. Manual setup may not work.
- If you connect the TV and PC directly, use a crossover LAN cable.

## To connect the TV to a home network - Wired

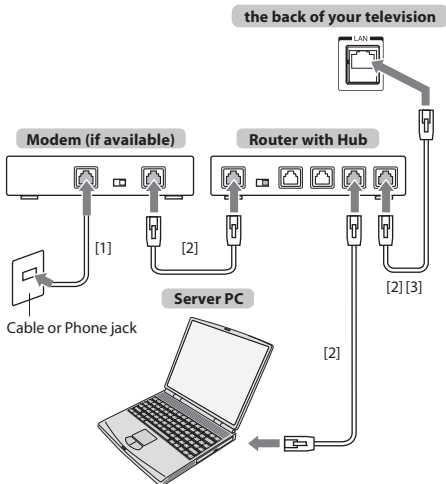

[1] Coaxial or telephone cable (depending on your modem type)

[2] Standard LAN cable

[3] Do NOT connect a phone jack directly to the TV's LAN port.

## To connect the TV to a home network with an internet connection - Wireless

Please refer to "Wireless Setup" section on page 43.

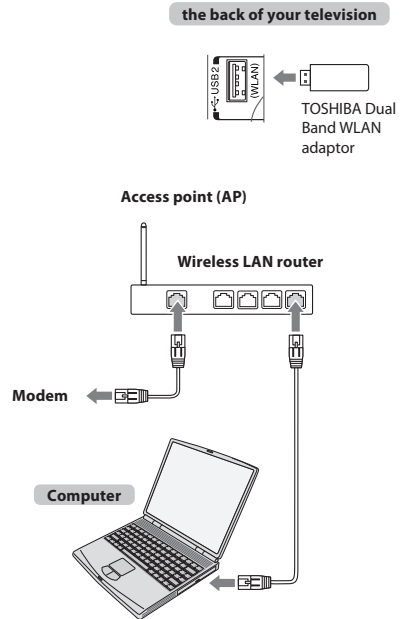

### How to use this Dual Band Wireless LAN Adaptor

- If this device is going to be operated in the frequency range of 5.15 GHz to 5.35 GHz, it is restricted to indoor use.
- If this device is going to be operated for 802.11 b/g/n function in the frequency range of 2.454 GHz to 2.4835 GHz in France, it is restricted to indoor use.
- A general authorization is required for using this device outdoors or in public places in Italy.
- This device is NOT ALLOWED to be used in the geographical area within a radius of 20km from the centre of Ny-Alesund in Norway.

## Controls and input connections

A wide variety of external equipment can be connected to the input sockets on the side of the television. While all the necessary adjustments and controls for the television are made using the remote control, the buttons on the television may be used for some functions.

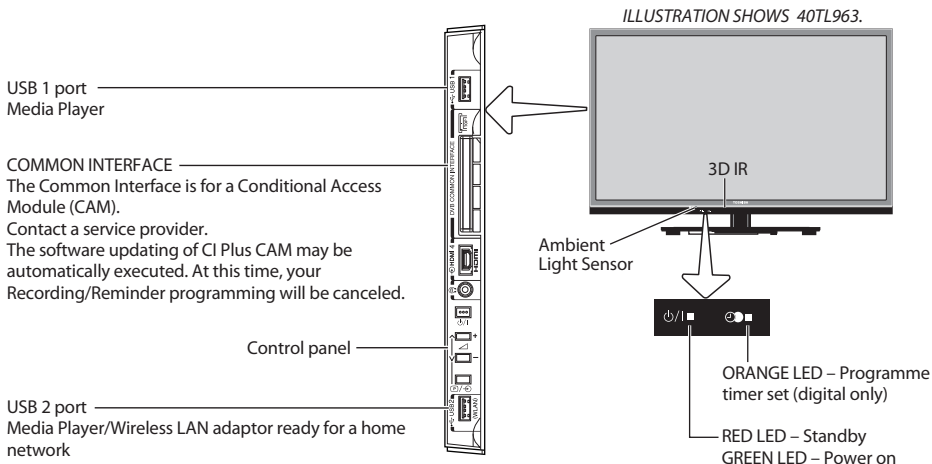

### Switching on

If the RED LED is not lit, check that the mains plug is connected to the power supply and press on the remote control; it may take a few moments. The GREEN LED will be lit.

To put the television into Standby, press on the remote control. To view the television, press again. The picture may take a few seconds to appear.

#### For energy saving:

We recommend that you use the television with the factory settings. The factory settings are for energy saving. Unplugging the mains plug will cut energy use to zero for all televisions. This is recommended when the television is not being used for a long time, e.g. when on holiday. Reducing the brightness of the screen will reduce energy use. Energy efficiency cuts energy consumption and thus saves money by reducing electricity bills.

**NOTE:** Putting the television into standby mode will reduce energy consumption, but will still draw some power.

### Using the menu system

Press **MENU** on the remote control to display the menu.

The menu appears as a list of five topics. As each symbol is selected by pressing or on the remote control, its respective options will appear above.

**NOTE:** The same menu is displayed in DTV (Digital TV) and ATV (Analogue TV) modes; however, where some items are not available in a mode, they will appear grayed out.

To use the option, press and on the remote control to move up and down and press or to select your desired setting.

### Using the TV controls and connections

- To turn on or off the TV, press .
- To alter the volume, press + or - .  
+ and - buttons operate as volume up/down as default.
- To alter the programme position, press / once and press or .
- To select an external input, press and hold / until the **Inputs** window appears, and then press or to select the appropriate input source.

The Media Player feature provides access to photo, movie and music files stored on a USB storage device that is connected via the USB 1 or USB 2 port or on a network device.

**NOTE:** The USB socket has limited functionality and Toshiba can take no responsibility for damage to other connected equipment.

The USB 2 socket has to be used with the "TOSHIBA Dual Band WLAN Adaptor WLM-20U2" in order to access a wireless network.

You must use the TOSHIBA Wireless LAN device to ensure correct operation of this feature. This feature is available only when the "TOSHIBA Dual Band WLAN Adaptor" is used.

*Please always refer to the owner's manual of the equipment to be connected for full details.*

**NOTE:** Interactive video games that involve shooting a "gun" at an on-screen target may not work with this TV.

## MENU structure

To open the main menu (illustration below) , press **MENU** on the remote control.

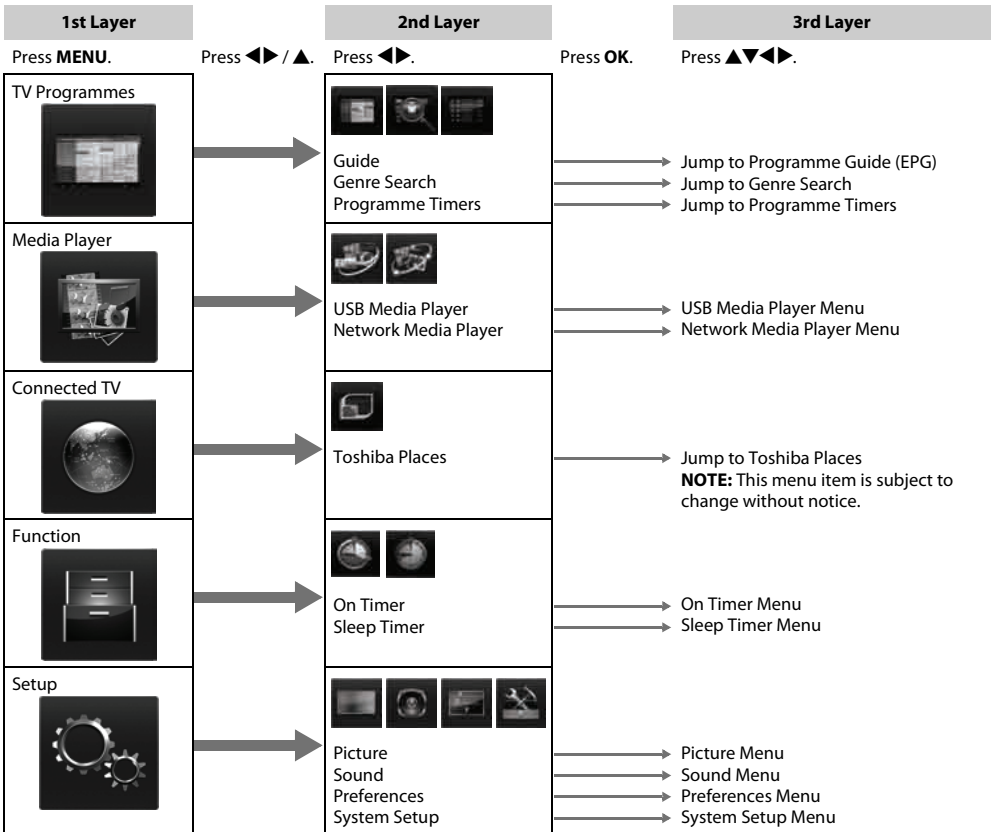
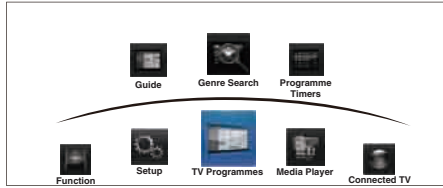

## Startup Application

Before switching on the TV, make sure your decoder/media recorder, if applicable, is in **standby**. To set up the television, use the buttons on the remote control as detailed on page 8.

### Quick Setup

- 1 Press the **OK** button. The **Menu Language** screen will appear. This screen will appear the first time that the television is switched on and each time **Reset TV** is selected.
- 2 Press **▲▼◀▶** to select the menu language and press **OK**.
- 3 Highlight **Country** and press **◀▶** to select. The television is now set to tune the stations for your country.

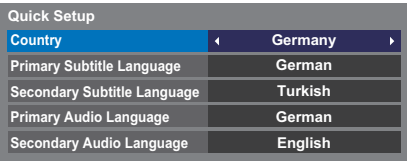

#### NOTE:

- The following display menus will differ slightly according to the country you selected.
- If there is not a country that you want to select in the list, select **Others**.

- 4 Press **OK**, and the **Location** screen will appear.

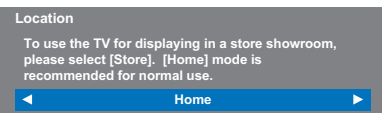

- 5 Press **◀▶** to select **Home** or **Store**. For normal home use, select **Home**.

- 6 Press **OK**, and the **AutoView** screen will appear, press **◀▶** to select **Yes** or **No**.

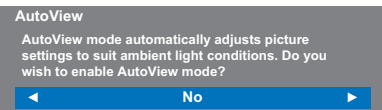

- 7 Press **OK**, and the **Network Setup** screen will appear. Press **◀▶** to select **Yes** or **No**.



- When you select **No**, skip to step 15.

- 8 Press **OK**, and the **Network Type** screen will appear. Press **◀▶** to select **Wired** or **Wireless**.



- When you select **Wired** (LAN cable connection), skip to step 12.
- When you select **Wireless** (USB WLAN adaptor connection), follow step 9.

**NOTE:** If the USB WLAN adaptor is not connected, **Network Type** screen does not display and skip to step 12.

- 9 Press **OK**, and the **Wireless Setup** screen will appear. Press **◀▶** to select the Wireless Setup type.

- **Assisted Setup** - follow step 10. Input the Security Key only.
- **Manual Setup**, skip to step 11. Input the all settings.

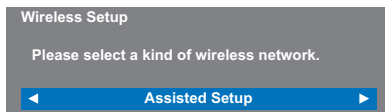

**NOTE:** **EXIT** is available during settings.

- 10 In step 9, when you select **Assisted Setup**:

Press **OK**, and the **Assisted Setup** screen will appear. Press **▲▼** to select the desired AP and press **OK**.

**NOTE:** Check the MAC address on the label of the AP or in the manual, and select your AP.

Press **▲▼** to select **Security Key** and press **OK**. The Software Keyboard window will appear (page 47). Input the Security Key by using the Software Keyboard. To save your setting, press the **BLUE** button.

#### NOTE:

- The Security Key must adhere to these conditions:
  - TKIP/AES: 8-63 ASCII or 64 Hex characters
  - WEP: 5 or 13 ASCII or 10 or 26 Hex characters
- There is only one key ID to set for WEP encryption.

Press **▲▼** to highlight **Done** and press **OK**.

#### NOTE:

- If Network Name is not displayed, see Manual Setup below to set Network Name before pressing **Done**.
- If **BACK** is pressed before **Done** is selected, settings are not saved.

When the message "Wireless configuration is complete." appears on screen, press **OK**. The screen will skip to step 12.



**11** In step 9, when you select **Manual Setup**;

Press **OK**, and the **Manual Setup** screen will appear. Press **▲** or **▼** to select **Network Name** and press **OK**. The Software Keyboard window will appear (page 47). Input the Network Name by using the Software Keyboard. To save your setting, press the **BLUE** button.

Press **▲** or **▼** to select **Authentication** and then press **◀** or **▶** to select **Open System, Shared Key, WPA-PSK** or **WPA2-PSK**.

Press **▲** or **▼** to select **Encryption**, and then press **◀** or **▶** to select **None, WEP, TKIP** or **AES**.

**NOTE:**

- Certain encryption types are only compatible with specific authentication types.
  - When Authentication is Open System, only **WEP** or **None** is compatible.
  - When Authentication is Shared Key, only **WEP** is compatible.
  - When Authentication is WPA-PSK or WPA2-PSK, only **TKIP** or **AES** is compatible.
- When incompatible Authentication/Encryption pairings are detected, a warning message will be displayed, and no connection attempt will be made until the incompatibility is resolved.
- There is only one key ID to set for WEP encryption.

Press **▲** or **▼** to select **Security Key** and press **OK**. Input the Security Key by using the Software Keyboard (page 47). To save your setting, press the **BLUE** button. This item is grayed out when **Encryption** is **None**.

When **Encryption** is **WEP**, **Key ID** setting is available. Press **▲** or **▼** to select **Key ID** and press **◀** or **▶** to select **1** (default), **2**, **3** or **4**.

Press **▲** or **▼** to select **Done** and press **OK**. When the message "Wireless configuration is complete." appears on screen, press **OK**.

**NOTE:** Settings are not saved if **BACK** is pressed before **Done** is selected.

**12** The **Advanced Network Setup** screen will appear.

When the DHCP function of the router connected with this TV is On, you can set **Auto Setup** to **On** or **Off**. (This should usually be set to **On**.) When the DHCP function of the router is Off, set **Auto Setup** to **Off**, and set the IP Address DNS address(es) manually.

Advanced Network Setup

IP Address Setup	
Auto Setup	On
IP Address	XXX . XXX . XXX . XXX
Subnet Mask	255 . 255 . 255 . 0
Default Gateway	0 . 0 . 0 . 0

DNS Setup	
Auto Setup	On
Primary DNS Address	255 . 255 . 255 . 0
Secondary DNS Address	0 . 0 . 0 . 0

MAC Address: 00:11:22:33:44:55

**Next**

You can view the fixed MAC address for the TV and for the Dual Band WLAN Adaptor, if one is installed.

Press **▲** or **▼** to select **Next**.

**13** Press **OK**, and Network Connection Test will start.

A message will appear to indicate if the connection was successful or it could not be completed.

Network connection was completed successfully.

**OK**

**NOTE:** The result of Network Connection Test does not always guarantee the connection. Depending on the situation, YouTube may not be able to be used.

**To cancel the Network Connection Test:**  
Press **BACK** while searching for the Internet connection.

- 14** Press **OK**. If your country supports Network Guide, The **Guide Type** screen will appear.



Press ◀ or ▶ to select **Broadcast Guide** or **MediaGuide**.

**NOTE:** If you select **MediaGuide**, it may take time to access the Guide screen depending on active channel numbers.

- 15** Press **OK**. If the **Ant/Cable/Satellite** screen appears, press ▲ or ▼ to select **Antenna**, **Cable** or **Satellite** and then press **OK** to check (✓).

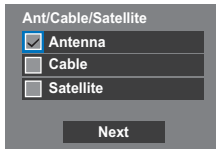

If DVB-C is not supported in your area, **Cable** will not be displayed.

- When you select **Antenna** or **Cable**, follow steps 16 to 19.
- When you select **Satellite**, skip to step 20.
- When you select **Antenna** (or **Cable**) and **Satellite**, the Satellite Settings startup screen will appear automatically after completing the **Antenna** (or **Cable**) scan and pressing **OK**.

- 16** Select **Next** and press **OK**. The **Auto Tuning** start up screen will appear with the option to select between **DTV and ATV**, **DTV** or **ATV** if available. Use ◀ or ▶ to select the appropriate mode.

- 17** Press ▲ or ▼ to highlight **Start Scan**, and then press **OK**.

The television will start to search for available **DTV** and/or **ATV** channels. The progress bar will indicate the scan status.

**You must allow the television to complete the search.**

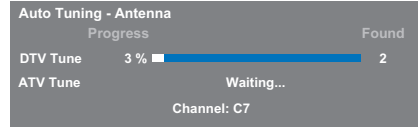

When the search is complete, the television will automatically select channel one.

The **Auto Tuning** screen will display the total number of services found.

- 18** Press ◀ or ▶ to view the **DTV** (digital channel) or **ATV** (analogue channel) lists.

- 19** Use ▲ or ▼ to move through the list to select a channel, and then press **OK** to view.

In **ATV** mode, some areas may receive duplicate stations. There may not be a clear picture or the signal may be weak, so the station order can be changed using **ATV Manual Tuning**.

**REMEMBER:** Press **TV** at any time to select between **ATV** and **DTV** modes.

**NOTE:** The time will be set automatically by transmission but can be advanced or decreased by using **Local Time Setting** in the **DTV Settings** screen.

- 20 Select **Next** and press **OK**. The **Satellite Settings** screen will appear. From this window, you can add the satellites that you wish to tune and configure detailed settings for each one individually. For further information, visit [www.Toshiba-om.net](http://www.Toshiba-om.net).

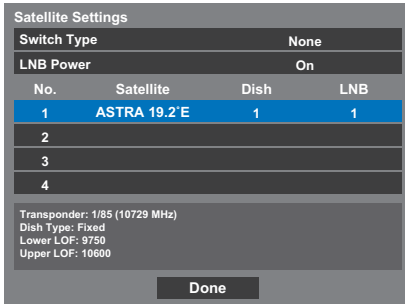

Highlight **Done** and press **OK**.

- 21 If your satellite dish is movable, the following **Positioning** screen will appear.

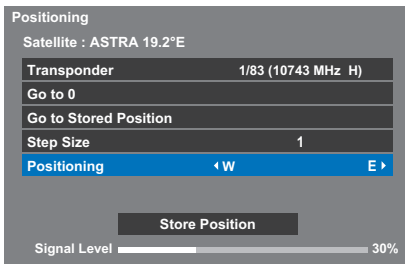

Press **▲** or **▼** to highlight **Positioning**, and then press **◀** or **▶** to find the dish position with the strongest signal level.

Press **▲** or **▼** to highlight **Store Position** and press **OK** to store the dish position. Repeat steps 20 and 21 for the next satellite as necessary.

If your satellite dish is not movable, the **Positioning** screen will not appear.

Adjust the dish position manually for the maximum Signal Level strength.

Highlight **Done** and press **OK**.

- 22 If the reception testing completes successfully, the **Auto Tuning** startup screen will display.

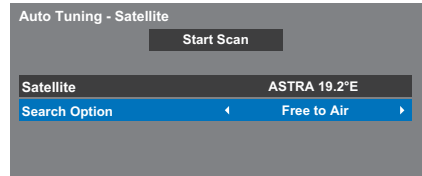

You can select **Search Option** between **Free to Air** and **All**.

- 23 Press **▲** or **▼** to highlight **Start Scan**, and then press **OK**.

The television will start to search for available **DVB-S** channels. The progress bar will indicate the scan status.

When the search is complete, the **Auto Tuning** results screen will display the total number of services found.

- 24 Use **▲** or **▼** to move through the list to select a channel, and then press **OK** to view.

#### PLEASE NOTE

The **Quick Setup** menu can also be accessed at any time from the **Setup/System Setup** menu.

### Ant/Cable/Satellite (if available)

From this menu, you can set the RF input configuration.

- 1 Press **MENU** / **◀▶** to highlight **Setup** icon.
- 2 Press **▲** / **◀▶** to highlight **System Setup** icon and press **OK**.
- 3 Press **▼** to select **Ant/Cable/Satellite** and press **◀** or **▶** to select **Antenna**, **Cable** or **Satellite**.

**NOTE:** When you attempt to change the **Ant/Cable/Satellite** setting, a warning message will appear followed by PIN entry (if PIN has been set) and a prompt for **Auto Tuning**.

- 4** When **Ant/Cable/Satellite** is set to **Cable**, the following setting options will be provided in the **Auto Tuning** screen.

Press **▲** or **▼** to select an item and press **◀** or **▶** to select your desired option.

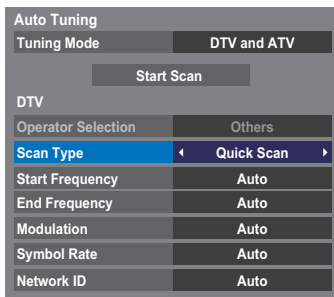

With the exception of **DTV Scan Type** and **DTV Modulation** items, all of the following items will have 2 operating modes. The first is **Auto** where the values for each item are preset by the system. The second is an **Input** mode where you will be able to enter a single value in place of the pre-set value. If no channel is currently tuned and the **Input** state is chosen, a system default value will be shown. However, if a channel is currently tuned when the item is accessed, the value of the current channel will be displayed.

#### Operator Selection:

You can choose the Cable operator depending on the Country you set.

#### DTV Scan Type:

This item determines whether a **Quick Scan** or a **Full Scan** will be executed.

The **Quick Scan** is a simplified version of the **Full Scan** that is designed to complete in less time.

#### DTV Start Frequency:

This sets the frequency from which the scan will begin.

#### DTV End Frequency:

This sets the frequency at which the scan will end.

#### DTV Modulation:

You can choose from five QAM modulation settings.

#### DTV Symbol Rate:

This is the baud rate (KS/s) of the scan.

#### DTV Network ID:

This is the Network ID to be utilized for the scan. This item is grayed out when DTV Scan Type is set to "Full Scan".

## Satellite Settings

From the System Setup menu, you can add the satellites that you wish to tune and configure detailed settings for each one individually.

#### To add a satellite:

- 1 Press **MENU** / **◀▶** to highlight **Setup** icon.
- 2 Press **▲** / **◀▶** to highlight **System Setup** icon and press **OK**.
- 3 Press **▼** to select **Satellite Settings** and press **OK**.

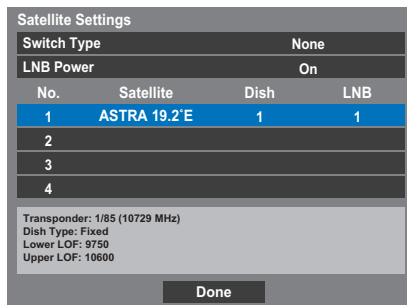

- 4 Press **▼** to highlight a new line to add another satellite and press **OK**.
- 5 Press **▼** until the required satellite is displayed and press **OK**.

#### To delete a satellite:

- 1 In the **Satellite Settings** menu, press **▲** or **▼** to select the satellite you want to delete.
- 2 Press the **RED** button. A confirmation window will appear.
- 3 Press **◀▶** to select **Yes** and press **OK**.

**NOTE:** It is not possible to delete position No.1.

### To edit the satellite settings:

- 1 In the **Satellite Settings** menu, press **▲** to highlight **Switch Type**.
- 2 Press **◀** or **▶** to select **None**, **ToneBurst**, **DiSeqC 2way** or **DiSeqC 4way** as your satellite switch type.
- 3 Press **▼** to highlight **LNB Power** and press **◀** or **▶** to select **On** or **Off**.

### To add a transponder:

- 1 In the **Satellite Settings** menu, press **▲** or **▼** to highlight the line you want to edit and press **OK**.

1	ASTRA 19.2 E	1	1
---	--------------	---	---

- 2 Press the **GREEN** button. The **Transponder Settings** screen will appear.

Transponder Settings				
	Frequency	Polarisation	Symbol Rate	S/S2
1	10743	H	22000	S
2	10773	H	22000	S
3	10788	V	22000	S
4	10817	V	22000	S
5	10832	H	22000	S
6	10847	V	22000	S
7	10861	H	22000	S
8	10876	V	22000	S

- 3 Press **▲** to highlight a new line.

Transponder Settings				
	Frequency	Polarisation	Symbol Rate	S/S2
76	12640	H	22000	S
77	12662	H	22000	S
78	12669	V	22000	S
79	12692	H	22000	S
80	12699	V	22000	S
81	12721	H	22000	S
82	12728	V	22000	S
83				

- 4 Press **OK**.

83	0	H	0	S
----	---	---	---	---

- 5 Edit each parameter as required and press **OK**.

83	1231	H	22000	S2
----	------	---	-------	----

### To delete a transponder:

- 1 In the **Transponder Settings** menu, press **▲** or **▼** to highlight the line you want to delete.
- 2 Press the **RED** button.

### To edit the Transponder Settings:

- 1 In the **Transponder Settings** menu, press **▲** or **▼** to highlight the line you want to edit and press **OK**.
- 2 Press **◀** or **▶** to select **Frequency**, **Polarisation**, **Symbol Rate** or **S/S2**, and set the item using the number buttons if necessary.
- 3 Press **OK** to save your settings.
- 4 Repeat steps 1 through 3 for other lines.
- 5 Press the **BLUE** button to finish editing and return to Satellite Settings.

Press the **GREEN** button to cancel any edits that were made.

Press the **YELLOW** button to reset all transponder settings to their initial default settings.

### To select the Dish Type:

- 1 In the **Satellite Settings** menu, press **▲** or **▼** to select the required satellite line and press **OK**.
- 2 Press **◀** or **▶** to highlight **Dish** and press the **GREEN** button.

Dish Settings	
Dish : 1	
Dish Type	Fixed

- 3 Press **◀** or **▶** to select **Dish Type**. You can select **Movable** or **Fixed** as the Dish Type.

## To select the LNB Settings:

**1** In the **Satellite Settings** menu, press **▲** or **▼** to select the required satellite line and press **OK**.

**2** Press **◀** or **▶** to highlight **LNB** and press the **GREEN** button.

LNB Settings	
LNB : 1	
Lower LOF	9750
Upper LOF	10600

**3** Press **▲** or **▼** to select **Lower LOF** or **Upper LOF** and input the appropriate frequencies.

## Auto Tuning

**NOTE:** As new services are broadcast, it will be necessary to re-tune the television in order to view them.

**Auto Tuning** will completely re-tune the television and can be used to update the channel list. **It is recommended that Auto Tuning is run periodically to ensure that all new services are added.** All current channels and settings, i.e. locked channels, will be lost.

**1** Press **MENU** / **◀** to highlight **Setup** icon.

**2** Press **▲** / **◀▶** to highlight **System Setup** icon and press **OK**.

**3** Press **▲** or **▼** to select **Auto Tuning** and press **OK**.

System Setup	
Menu Language	English
Country	Germany
Ant/Cable/Satellite	
Satellite Settings	
Auto Tuning	
ATV Manual Tuning	
DTV Manual Tuning	
DTV Settings	

## 4 For DTV/ATV Tuning:

Press **◀** or **▶** to select **Yes** and press **OK**.

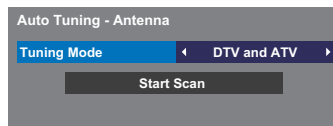

Press **◀** or **▶** to select **DTV and ATV**, **DTV** or **ATV**, if available, then highlight **Start Scan** and press **OK** to continue with the **Auto Tuning**.

**NOTE:** If you have selected "Others" for the **Country** field in the **Setup** menu, and selected a tuning mode other than "DTV", choose the optimum ATV broadcasting system (B/G, I, D/K or L).

The television will start to search for all available DTV and/or ATV services.

**You must allow the television to complete the search.**

When the search is complete, the **Auto Tuning** screen will display the services found.

## For Satellite Tuning:

Press **◀** or **▶** to select **Yes** and press **OK**.

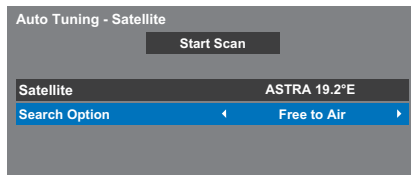

Press **▲** or **▼** to highlight **Satellite** and press **◀** or **▶** to select the desired satellite (**No.1 Sat** ~ **No.4 Sat** or **All**).

You can select **Free to Air** or **All** as the Search Option. Highlight **Start Scan** and press **OK** to continue with the **Auto Tuning**.

When the search is complete, the **Auto Tuning** screen will display the services found.

**5** Press **▲** or **▼** to move through the list to select a channel and press **OK** to view.

# ATV Manual Tuning

## Tuning

The television can be tuned-in manually using **ATV Manual Tuning**. For example, you might use the feature if the television cannot be connected to a media recorder/decoder with a SCART lead or when you want to tune-in a station on another **System**.

Use ◀ and ▶ to move across the screen and select any of the ATV Manual Tuning options. Then use ▲ or ▼ to adjust the settings.

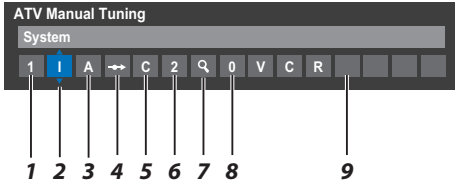

### 1 Position

The number to be pressed on the remote control to tune the channel.

### 2 System

Specific to certain areas.

### 3 Colour System

Factory set to Auto, should only be changed if problems are experienced, i.e. NTSC input from external source.

### 4 Skip

Set Skip to On (↶↷) or Off (↷↶) for the selected channel. See page 24.

### 5 Signal Class

The channel classification.

### 6 Channel

The channel number on which a station is being broadcast.

### 7 Search

Search up and down for a signal.

### 8 Manual Fine Tuning

Only used if interference/weak signal is experienced. See page 73.

### 9 Station

Station identification. Use the ▲ ▼ and ◀ ▶ buttons to enter up to seven characters.

To allocate a position on the television for a decoder and media recorder: turn the decoder on, insert a pre-recorded film in the media recorder, press PLAY and manually tune.

- 1 In the **System Setup** menu, press ▼ to select **ATV Manual Tuning** and press **OK**.

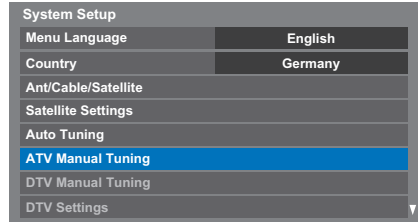

- 2 Use ▲ or ▼ to select the desired position. We suggest **Pos. 0** for a media recorder.

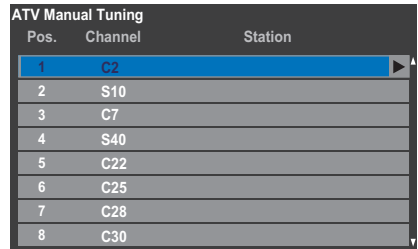

Different **Channel** numbers may be displayed.

- 3 Press **OK** to select. If the channel chosen for the media recorder is set to skip, Skip should be removed before storing.

- 4 Press ▶ to select **System** and press ▲ or ▼ to change if required.

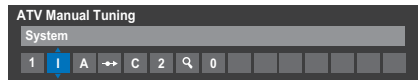

- 5 Then press ▶ to select **Search**.

- 6 Press ▲ or ▼ to begin the search. The search symbol will flash.



- 7** Each signal will show on the television. If it is not your media recorder, press ▲ or ▼ again to restart the search.
- 8** When your media recorder signal is found, press ► to move along to **Station**. Use ▲, ▼, ◀ and ▶ to put in the required characters, e.g. **VCR**.

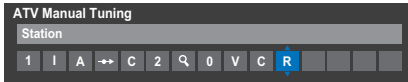

- 9** Press **OK** to save.
- 10** Repeat for each **position** you want to tune.
- 11** Press **EXIT** when you have finished.

**PLEASE NOTE**

This television has direct channel entry if the channel numbers are known. Select the **ATV Manual Tuning** screen in **Step 3**. Enter the **Position number**, the **System**, then **C** for standard (terrestrial) channels or **S** for cable channels and the **Channel** number. Press **OK** to save.

**Skip**

To prevent certain channels from being viewed, positions can be skipped.

- 1** Select **ATV Manual Tuning** from the **System Setup** menu.
- 2** Use ▲ or ▼ to highlight the position to be skipped and press **OK** to select.

Pos.	Channel	Station
1	C2	
2	S10	
3	C7	
4	S40	ABC1
5	C22	ABC1
6	C25	
7	C28	
8	C30	

- 3** Press ► to select **Skip**.
- 4** Use ▲ or ▼ to turn **Skip** on. Press **OK**.

↔ on the screen indicates a skipped position.

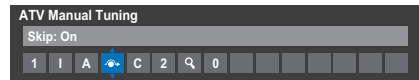

- 5** Press **EXIT** and repeat steps 1 through 4 to set other positions if necessary.

Each position has to be *individually* selected. To turn **Skip** off, repeat the procedure for each position.

Skipped positions **cannot** be selected by **P▲** and **P▼** or by the controls on the television but **can** still be accessed by the number buttons on the remote control.



## Sorting positions

Channels may be moved and saved to the position of your choice.

- 1 Select **ATV Manual Tuning** from the **System Setup** menu.
- 2 With the list of channels showing, use ▲ or ▼ to highlight the channel you want to move and press ►.

ATV Manual Tuning		
Pos.	Channel	Station
2	S10	
3	C7	
4	S40	ABC1
5	C22	ABC1
1	C2	
6	C25	
7	C28	
8	C30	

- 3 Use ▲ or ▼ to move through the list to your preferred position. As you do so, the other channels will move to make room.
- 4 Press ◀ to save your move.  
Repeat as necessary and press **EXIT**.

## DTV Manual Tuning

**NOTE:** This feature varies depending on the **Ant/Cable/Satellite** setting.

### Manual Tuning

*This feature is available for service engineers or can be used for direct channel entry if the multiplex channel is known.*

- 1 Select **DTV Manual Tuning** from the **System Setup** menu and press **OK**.

DTV Manual Tuning - Antenna

Signal Strength WEAK      AVERAGE      STRONG

Quality GOOD

Channel ◀ 67 ▶

Frequency 842.0 MHz

Bandwidth 8 MHz

Start Scan

- 2 Enter the multiplex number using the number buttons or use ◀ or ▶ to adjust the number up or down.
- 3 Highlight **Start Scan** and press **OK**. The television will automatically search for that multiplex.

DTV Manual Tuning - Antenna

0 New Channels - Total 6

New	Pos.	Name	Type
	1	ABC ONE	<input type="text"/>
	2	ABC TWO	<input type="text"/>
	7	ABC THREE	<input type="text"/>
	40	ABC NEWS 24	<input type="text"/>
	51	ABCi	<input type="text"/>

When the multiplex is found, any channels that are not currently in the channel list will be added and the channel information at the top of the screen will be updated.

- 4 Repeat as necessary. Press **EXIT** to finish.

## Manual Tuning for DVB-C

When **Ant/Cable/Satellite** is set to **Cable**, **DTV Manual Tuning** items are as follows:

**Frequency:** Input a specific frequency to be scanned

**Modulation:** Choose from one of five QAM modulation options

**Symbol Rate:** Input a specific baud rate (KS/s) to be used for the manual scan

Highlight **Start Scan** and press **OK**.

## Manual Tuning for DVB-S

When **Ant/Cable/Satellite** is set to **Satellite**, **DTV Manual Tuning** items are as follows:

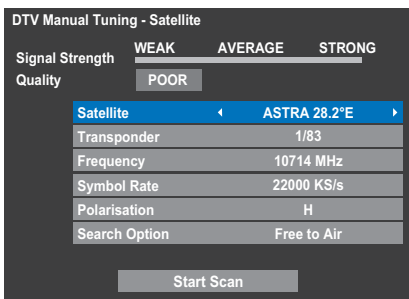

Use **▲** or **▼** to highlight an item (**Satellite**, **Transponder**, **Frequency**, **Symbol Rate**, **Polarisation** or **Search Option**) and press **◀** or **▶** to select the required option.

Highlight **Start Scan** and press **OK**.

## DTV Settings

### Channels (Antenna/Cable)

*The channel order may be changed to suit your personal preference.*

- 1 Select **DTV Settings** from the **System Setup** menu and press **OK**.
- 2 Select **Channels** and press **OK**.

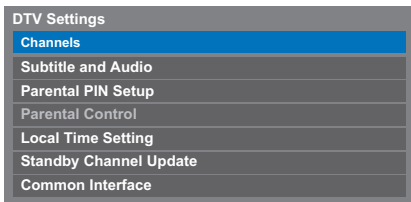

- 3 For your convenience, you can jump to specific places in the list by one of two methods.

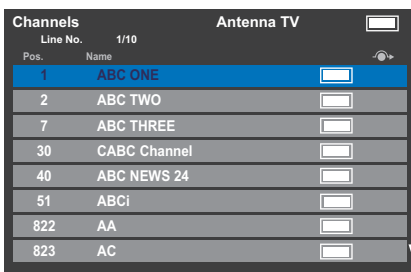

**Line Number Jump** — Use the **number buttons** (0-9) to input the line number you want to select and press **OK**.

It is also possible to change the Position number of a particular channel.

**Renumber** — Press the **RED** button to renumber the highlighted channel. Edit the channel number using the **number buttons** and press **OK**. If the position number you input already exists, a confirmation window will appear.

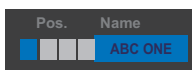

**Move** — Press the **GREEN** button to activate the **Move** feature. Press the **▲** or **▼** buttons to select the channel you wish to move and press **OK** to check. If you wish to move multiple channels at once, select another channel and check in the same way. Repeat as necessary. Once all desired channels have been checked, press the **▲** or **▼** buttons to place the focus at the position to which you wish to move the channels. The channels will be inserted above the highlighted channel. Press the **GREEN** button to execute the move.

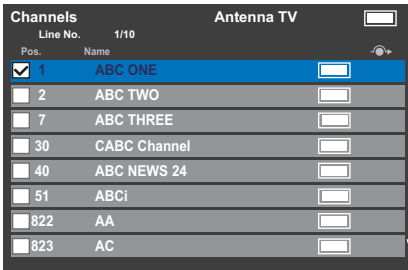

**Position No. Sort** — Press the **YELLOW** button. A confirmation window will appear. Press **◀** or **▶** to select **Yes** and press **OK**.

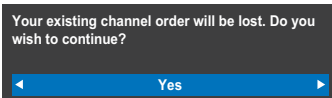

## Channels (Satellite)

- 1 Select **DTV Settings** from the **System Setup** menu and press **OK**.
- 2 Select **Channels** and press **OK**.

The satellite channel list will appear.

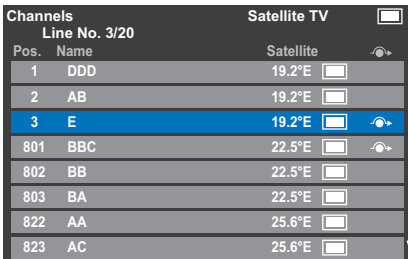

- 3 For your convenience, you can edit and sort your channel list.

**Line Number Jump** — Press the **number buttons** (0-9) to input the line number you want to select and press **OK**.

**Satellite Jump** — Press **◀◀** or **▶▶** to jump to the next channel on a different Satellite.

**Renumber** — Same as Antenna/Cable channels. See page 26.

**Move** — Same as Antenna/Cable channels. See page 27.

**Position No. Sort** — Press the **YELLOW** button. A confirmation window will appear. Press **◀** or **▶** to select **Yes** and press **OK**.

## Standby Channel Update

If the **Standby Channel Update** is set to **On**, when the TV is in standby mode, Digital Tuning is automatically executed.

- 1 Select **DTV Settings** from the **System Setup** menu and press **OK**.
- 2 Press **▼** to select **Standby Channel Update** and press **◀** or **▶** to select **On**.

## Location setting

You can select either **Home** or **Store** mode. **Home** is recommended for normal home use. Select **Store** when using the television for displaying in a shop, etc.

- 1 Select **Location** from the **System Setup** menu.
- 2 Press **◀** or **▶** to select **Home** or **Store**.

## Analogue switch-off

This is a **digital** television which is integrated to allow the use of both **digital** and **analogue** services. However, during the lifetime of this set it is very likely that **analogue** services will be switched off to allow for more new **digital** services.

This 'switch-off' will happen in a number of phases, which will be advertised in your area well in advance. It is recommended that at each phase the television is re-tuned to ensure that existing and new **digital** services can be viewed without disruption.

## General controls

### Quick Menu

**Quick Menu** helps you access some options quickly, such as **Picture Mode**, **Picture Size**, **More Information**, **Sleep Timer** etc.

Press **QUICK** to display the **Quick Menu** and use ▲ or ▼ to select the option.

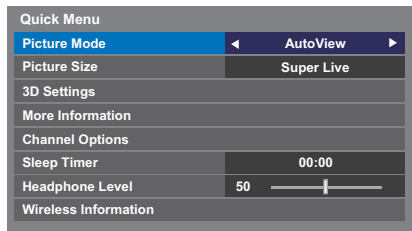

**NOTE:** **Quick Menu** items are different depending on the current mode.

### Quick menu item example

Mode	Quick menu item	Description
When viewing a TV programme or pictures from the external input  Single Window or 3D Single Window	Picture Mode	See page 38.
	Picture Size	See page 36.
	3D Settings	See page 31.
	More Information	See page 60.
	Channel Options	See page 63.
	Sleep Timer	See page 58.
	Headphone Level	See page 35.
	Wireless Information	See page 44.
When using EPG	Genre Colour	See page 61.
USB Media Player (Photo Single View, Slide Show)	Picture	See page 38.
	3D Settings	See page 31.
	Sound	See page 34.
	Interval Time	See page 52.
	Repeat	See page 52.
	Background Music	See page 52.
	Play List	See page 53.
	Sleep Timer	See page 58.
	Headphone Level	See page 35.

### Selecting channels

To select a channel, use the numbered buttons on the remote control.

Channels can also be selected using **P▲** and **P▼**.

To display on-screen information such as channel, input mode or stereo/mono signal, press **[+]**. Press again to cancel.

### The Time Display – analogue only

*The time display facility allows the current (text service) time to be seen on the television screen.*

Press **[D]/[EX]** whilst watching a normal television broadcast to see the time display from the broadcaster. It will remain on screen for about 5 seconds.

**NOTE:** This display may not be available in some cases.

### Stereo and Bilingual transmissions

#### For DTV programmes

For stereo or dual mono broadcasts, press **[D]/[I]** and use ◀ or ▶ to select settings.

Mode Display	Pressing ▶
◌ Stereo	Stereo → Left → Right
● Dual mono	Dual 1 → Dual 2 → Dual
◌ Mono	-
◌ Multichannel	-

For multi-audio track broadcasts, press **[D]/[I]** repeatedly to change the audio language (see “Audio languages” on page 64).

#### For ATV programmes

If stereo or dual language broadcasts are transmitted, the word **Stereo** or **Dual** will appear on the screen each time channels are changed, disappearing after a few seconds. If the broadcast is not in stereo, the word **Mono** will appear.

**Stereo...** Press **[D]/[I]** to select **Stereo** or **Mono**.

**Bilingual...** Bilingual transmissions are rare. If they are transmitted, the word **Dual** will be displayed. Choose the required programme number, and if the word **Dual** appears, press **[D]/[I]** to select **Dual 1**, **Dual 2** or **Mono**.

## Using 3D functions

Before using 3D programming, see and follow “When using the 3D glasses” section on page 6.

### Viewing 3D programming requires the following:

- 3D glasses: Toshiba FPT-AG02G  
UL97 series : Supplied  
TL96 series : Not supplied
- Compatible 3D playback device or 3D source
- 3D capable high quality HDMI cable

## Using the 3D glasses

### Names and functions

#### Lens (liquid-crystal shutter)

A right and left liquid-crystal shutter opens and closes alternately with the images for the left eye and for the right eye alternately projected on the television screen. In this way, 3D images are reproduced.

#### Power switch and power light

Turns on or off the power of 3D glasses with the switch.

- When working, the power light blinks once every 2 seconds.
- When the power is turned off, the power light goes out.

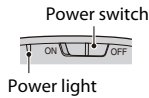

#### Protective films

Peel these off before beginning use.

#### Infrared reception part

Receives the infrared signal for the liquid-crystal shutter control sent from the television.

#### USB terminal

When charging the battery, connect to the TV with the battery charge cable.



### To set the 3D glasses:

- 1 When you use for the first time, peel off the protective films from the lenses.
- 2 Turn the 3D glasses on with the power switch.



**NOTE:** If the infrared data communication between the television and 3D glasses is lost for 5 minutes, the 3D glasses turn off automatically to preserve battery life.

### To charge the battery:

If the 3D glasses are turned on while the battery power is low, the power light will blink 5 times. (If the battery is dead, the power light will not blink or light.)

- 1 Turn the 3D glasses off with the power switch, and connect to the TV with the battery charge cable.

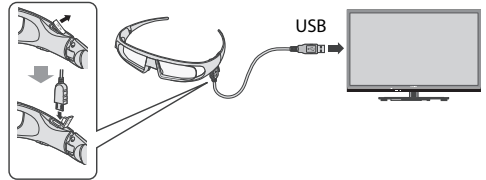

#### NOTE:

- If the 3D glasses are turned on, the battery will not charge.
- When the TV is turned off or in standby mode, the battery will not charge.
- When charging the battery the use of a USB cable other than the battery charge cable supplied is not covered by warranty.

- 2 The power light will Light up.
- 3 When the light goes out, the charging is completed.

#### NOTE:

- It takes approximately two hours to charge the battery.
- If the usage time is extremely short even after the battery has been charged fully, the battery may be worn out. Contact your dealer.

### To check the battery level:

When the 3D glasses are turned on, the behavior of power light is different.

- Charged: Lights up for 2 seconds
- Low charge: Blinks 5 times

**CAUTION:** Danger of explosion if battery is incorrectly disposed of.

## Viewing 3D images

Incoming video signals can either be in 2D or 3D format. A 2D signal can be viewed in either 2D or 3D, and 3D can be viewed in either 2D or 3D. If the TV can detect the fact that a signal is 3D, it can change to 3D mode automatically – see “Setting the auto start mode” (on page 32). Otherwise you can change the viewing mode using the 3D button. Finally, the format of the 3D signal can be either Side by Side (SBS) or Top and Bottom (TB). You may have to choose the correct format if the TV can not detect it automatically – see “Switching display mode or selecting 3D format”.

Moreover, you can change 2D images to 3D images by pressing the 3D button when viewing in 2D.

### NOTE:

- When 3D format signal is not received, display mode is not switched to 3D.
- If appropriate mode and format are not selected, 3D image is not correctly displayed.
- There will be restrictions on the Picture Size settings for 3D Mode and 2D Mode.
- There are individual differences in perception of 3D images.
- When viewing 3D images, wear the 3D Glasses.
- The 2D to 3D conversion function is activated and controlled by you according to your personal preferences.
- The 2D to 3D conversion function is meant for enjoyment of 2D home video, and other 2D content you create, in 3D according to your personal preferences.
- The 2D to 3D conversion function is not intended for use with pre-recorded 2D copyrighted content owned by a third-party unless the copyright owner has given direct or indirect permission, or unless applicable law permits such use.

## Switching display mode or selecting 3D format



There are four modes for watching TV.

Mode	Description
3D	Displays 3D images.
2D	Changes 3D images to 2D.
2D to 3D	Changes 2D images to 3D.
Native	Displays a received signal format as it is.

### 3D format select:

If a right and left images are same in Native mode, select SBS.

If a top and bottom images are same in Native mode, select TB. 3D formats are the following.

3D format	Description
Side by Side (SBS)	Images for the left and right eyes are positioned side-by-side. 
Top and Bottom (TB)	Images for the left and right eyes are positioned at the top and bottom of the screen. 
Frame Packing (FP) *	Image for the left and right eyes for two frames are positioned at the top and bottom of the screen. 

\* This format cannot be selected manually.



















### The 3D button's operation:

The behaviour of 3D when viewing in Native mode is different depending on the input mode.

Depending on the input mode, the screen for selecting 2D or 3D is displayed or the display mode switches between 2D and 3D.

### To switch to 3D mode:

- Set **Preferences / 3D Setup / 3D Auto Start** to **3D**.
- Press **3D** while viewing 2D mode or Native mode.

Input Signal		Trigger of Switching Display Mode		Press 3D button			
		Additional Information	Format	Source Signal	Select 3D	Select 2D to 3D	
3D Format Signal	With 3D Auto Detect Information	FP			*		
			SBS			*	
			TB			*	
	Without 3D Auto Detect Information	SBS			*		
	TB			*			
2D Format Signal					*		

\* Correct 3D image

**To select 3D format from the Quick menu in 3D mode:**

- 1** Press **QUICK** to display the **Quick Menu**.
- 2** Press **▲** or **▼** to select **3D Settings** and press **OK**.
- 3** Press **▲** or **▼** to select **3D Format Select** and press **OK**.
- 4** Press **◀** or **▶** to select **3D (SBS)** or **3D (TB)**.

Trigger of Switching Display Mode				Quick menu	
Input Signal				3D Fomat Select	
Type	Additional Info	Format	Source Signal	SBS	TB
3D Format Signal	With 3D Auto Detect Information	FP			
		SBS			
	TB				
Without 3D Auto Detect Information	SBS				
	TB				
2D Format Signal					

\* Correct 3D image

**To switch to 2D mode:**

- Set **Preferences / 3D Setup / 3D Auto Start** to **2D**.
- Press **3D** while viewing 3D mode or Native mode.

Trigger of Switching Display Mode				Press 3D button
Input Signal				
Type	Additional Info	Format	Source Signal	
3D Format Signal	With 3D Auto Detect Information	FP		*
				*
		SBS		*
	TB		*	
Without 3D Auto Detect Information	SBS			
	TB			
2D Format Signal				*

\* Correct 2D image

**To select 2D format from the Quick menu in 2D mode:**

- 1** Press **QUICK** to display the **Quick Menu**.
- 2** Press **▲** or **▼** to select **3D Settings** and press **OK**.
- 3** Press **▲** or **▼** to select **2D Format Select** and press **OK**.
- 4** Press **◀** or **▶** to select **Native**, **Side by Side (SBS)** or **Top and Bottom (TB)**.

Trigger of Switching Display Mode				Quick menu		
Input Signal				2D Fomat Select		
Type	Additional Info	Format	Source Signal	SBS	TB	Native
3D Format Signal	With 3D Auto Detect Information	FP				
		SBS		*		
	TB			*		
Without 3D Auto Detect Information	SBS			*		
	TB			*		
2D Format Signal						

\* Correct 2D image

**NOTE:** Take off the 3D Glasses in 2D mode.

**To switch to Native mode:**

- Press **3D** while viewing 3D mode.
- Press **3D** while viewing 2D to 3D mode.

**NOTE:** When 3D format signal with 3D Auto Detect Information is received, it is not possible to switch to Native.

- From the **Quick Menu** in 2D mode.

- 1** In the **Quick Menu**, press **▲** or **▼** to select **3D Settings** and press **OK**.
- 2** Press **▲** or **▼** to select **2D Format Select** and press **OK**.
- 3** Press **◀** or **▶** to select **Native**.

**NOTE:** When Frame Packing is input, 2D Format Select will be grayed out.

**To switch to 2D to 3D mode:**

Press **3D** while viewing 2D or Native mode.

**NOTE:** Depending on the input mode, the display mode switches between 2D and 3D.

## Setting the auto start mode

Controls what the TV does when it detects a 3D signal.

- 1 Press **MENU** / ◀▶ to highlight **Setup** icon.
- 2 Press ▲ / ◀▶ to highlight **Preferences** icon and press **OK**.
- 3 Press ▲ or ▼ to select **3D Setup** and press **OK**.

Preferences	
<b>3D Setup</b>	
REGZA-LINK Setup	
Network Setup	
Guide Type	
Network Device Setup	
Teletext	Auto
Network Lock	Off
Panel Lock	Off

- 4 Press ▲ or ▼ to select **3D Auto Start**.
- 5 Press ◀▶ to select **3D**, **2D**, or **Off**.

Option	Description
3D	Displays as 3D mode automatically when 3D format signal is received.
2D	Displays as 2D mode automatically when 3D format signal is received.
Off	Displays a screen that allows you to select 3D or 2D when 3D format signal is received.

## Adjusting 2D to 3D Depth

You can adjust the level of 3D.

### From the Menu:

- 1 In the **Preferences** menu, press ▲ or ▼ to select **3D Setup** and press **OK**.
- 2 Press ▲ or ▼ to select **2D to 3D Depth**.
- 3 Press ◀▶ to select **1**, **2**, **3**, **4**, or **5**.  
The higher the number, the stronger the 3D effect.

### From the Quick Menu:

- 1 Press **QUICK** on the remote to open the **Quick Menu**.
- 2 Press ▲ or ▼ to select **2D to 3D Depth**.
- 3 Press ◀▶ to select **1**, **2**, **3**, **4**, or **5**.  
The higher the number, the stronger the 3D effect.

**NOTE:** Depending on the content, setting the 3D effect to a high level may result in blurring of the image contours and background.

If you experience any abnormal sensation or feel fatigue or nausea when viewing 3D images, stop watching and rest until the symptoms subside. Before viewing again, adjust the 3D effect to a lower number and view at a level at which the symptoms do not occur.

## Setting the 3D PIN code

A 3D PIN code is necessary for using 3D Safety Settings.

### To enter a new PIN code:

- 1 In the **Preferences** menu, press ▲ or ▼ to select **3D Setup** and press **OK**.
- 2 Press ▲ or ▼ to select **3D PIN** and press **OK**.
- 3 Press the number buttons to enter a 4-digit number. Confirm the code.

**NOTE:** PIN code cannot be set to "0000".

### To change or delete your PIN code:

- 1 In the **Preferences** menu, press ▲ or ▼ to select **3D Setup** and press **OK**.
- 2 Press ▲ or ▼ to select **3D PIN** and press **OK**.
- 3 Press the number buttons to enter your 4-digit PIN code.
- 4 Select **Change PIN** or **Delete PIN** and press **OK**.

#### **NOTE:**

- PIN code cannot be set to "0000".
- If PIN is deleted, 3D Safety Settings is grayed out, and the settings are reset to the factory default.

## Setting 3D Start Message

When this feature is set to On, a message is displayed onscreen when a 3D signal is received.

- 1 In the **Preferences** menu, press ▲ or ▼ to select **3D Setup** and press **OK**.
- 2 Press ▲ or ▼ to select **3D Safety Settings** and press **OK**.
- 3 Enter your 4-digit 3D PIN code.
- 4 Press ▲ or ▼ to select **3D Start Message**.
- 5 Press ◀▶ to select **On** or **Off**.



## Setting 3D Lock

When this feature is set to On, you must enter 3D PIN code for changing display mode.

- 1 In the **Preferences** menu, press ▲ or ▼ to select **3D Setup** and press **OK**.
- 2 Press ▲ or ▼ to select **3D Safety Settings** and press **OK**.
- 3 Enter your 4-digit 3D PIN code.
- 4 Press ▲ or ▼ to select **3D Lock**.
- 5 Press ◀ or ▶ to select **On**.

## Setting 3D Timer Lock

When the 3D Timer Lock feature is set to On, neither the PIN input window nor the 3D start message will be shown while the 3D Enable timer is active, even if a switch to 3D Mode occurs. This helps to avoid asking for the 3D Lock PIN and displaying 3D start message every time when switching to 3D.

**NOTE:** This feature cannot be selected until the **3D PIN** is set.

- 1 In the **Preferences** menu, press ▲ or ▼ to select **3D Setup** and press **OK**.
- 2 Press ▲ or ▼ to select **3D Safety Settings** and press **OK**.
- 3 Enter your 4-digit 3D PIN code.
- 4 Press ▲ or ▼ to select **3D Timer Lock**.
- 5 Press ◀ or ▶ to select **On**.

## Setting Enable 3D Timer

This feature helps to remind you not to watch 3D video for extended periods of time. Once a set period of time has passed, a dialogue will be shown asking you if you wish to continue viewing or not.

- 1 In the **Preferences** menu, press ▲ or ▼ to select **3D Setup** and press **OK**.
- 2 Press ▲ or ▼ to select **3D Safety Settings** and press **OK**.
- 3 Enter your 4-digit 3D PIN code.
- 4 Press ▲ or ▼ to select **Enable 3D Timer**.
- 5 Press ◀ or ▶ to select **30, 60, 90, or 120** minutes.
- 6 To cancel the timer, select **Off**.

## Displaying 3D Important Info

- 1 In the **Preferences** menu, press ▲ or ▼ to select **3D Setup** and press **OK**.
- 2 Press ▲ or ▼ to select **3D Important Info** and press **OK**.

## Switching left and right images

The left and right eye shutter timing of the glasses can be swapped. If 3D images look blurred, switch the left and right sides of the 3D image.

- 1 Press **QUICK** on the remote to open the **Quick Menu**.
- 2 Press ▲ or ▼ to select **3D Settings** and press **OK**.
- 3 Press ▲ or ▼ to select **Left and Right Image**.
- 4 Press ◀ or ▶ to select **Swapped**.

## Sound controls

### Volume controls and sound mute

#### Volume

Press  $\triangle$  + or  $\triangleleft$  - to adjust the volume.

#### Sound Mute

Press  $\otimes$  once to turn the sound off and again to cancel.

### Dual

If a programme or film is being broadcast with a soundtrack in more than one language, the **Dual** feature allows selection between them.

- 1 Press **MENU** /  $\triangleleft$  to highlight **Setup** icon.
- 2 Press  $\triangle$  /  $\triangleleft$  to highlight **Sound** icon and press **OK**.
- 3 Press  $\triangle$  or  $\nabla$  to select **Dual** and press  $\triangleleft$  or  $\triangleright$  to choose between **Dual 1** or **Dual 2**.

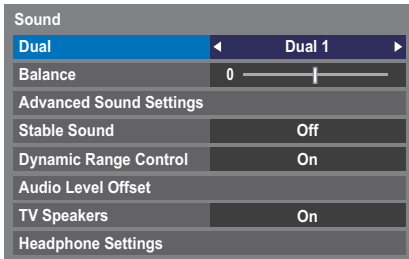

### Balance

- 1 In the **Sound** menu, press  $\triangle$  or  $\nabla$  to select **Balance** and press  $\triangleleft$  or  $\triangleright$  to emphasize left or right speaker balance.

### Bass, Treble

- 1 In the **Sound** menu, press  $\triangle$  or  $\nabla$  to select **Advanced Sound Settings** and press **OK**.
- 2 Press  $\triangle$  or  $\nabla$  to select **Bass** or **Treble**.
- 3 Press  $\triangleleft$  or  $\triangleright$  to change the setting.

### Voice Enhancement

**Voice Enhancement** emphasises the frequency range of the speaker's voice, making it easier to catch what they are saying.

- 1 In the **Advanced Sound Settings** menu, press  $\triangle$  or  $\nabla$  to select **Voice Enhancement**.
- 2 Press  $\triangleleft$  or  $\triangleright$  to select **On** or **Off**.

### Dynamic Bass Boost

**Dynamic Bass Boost** enhances the depth of the sound on the TV speakers. The difference will only be noticeable on sound with strong bass.

- 1 In the **Advanced Sound Settings** menu, press  $\triangle$  or  $\nabla$  to select **Dynamic Bass Boost**.
- 2 Press  $\triangleleft$  or  $\triangleright$  to select the desired bass expansion level (**Low**, **High** or **Off**).

### Stable Sound®

**Stable Sound** reduces the volume level differences between channels. It automatically remains on the same volume level when you change channels.

- 1 In the **Sound** menu, press  $\triangle$  or  $\nabla$  to select **Stable Sound**.
- 2 Press  $\triangleleft$  or  $\triangleright$  to select **On** or **Off**.

### Dynamic Range Control

This feature allows control of audio compression for some digital TV programmes (MPEG-1 and MPEG-2 audio programmes are not supported).

- 1 In the **Sound** menu, press  $\triangle$  or  $\nabla$  to select **Dynamic Range Control**.
- 2 Press  $\triangleleft$  or  $\triangleright$  to select **On** or **Off**.

## Audio Level Offset

Sometimes there can be large changes in volume when switching from a DTV 5.1ch to a DTV 2ch, an ATV channel, or an external input. Using the **Audio Level Offset** feature reduces these volume differences.

- 1 Set the volume level usually used when watching a DTV 5.1ch programme.
- 2 Tune to a channel which is DTV 2ch, ATV or an external input.
- 3 In the **Sound** menu, press ▲ or ▼ to select **Audio Level Offset** and press **OK**.
- 4 Press ▲ or ▼ to select an option, and then press ◀ or ▶ to adjust the volume level.

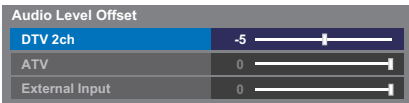

### NOTE:

- The available item changes depending on the current input source. For example, while watching a DTV 2ch programme, only **DTV 2ch** is available and the other two items are grayed out in the menu. This allows you to easily adjust according to each condition.
- When watching a DTV 5.1ch programme, this feature is not available.

## TV Speakers On/Off

This feature allows you to turn the TV speakers off when connecting the audio system.

- 1 In the **Sound** menu, press ▲ or ▼ to select **TV Speakers**.
- 2 Press ◀ or ▶ to select **Off**.

### To turn on the built-in speakers:

Choose **On** in step 2.

## Headphone Settings

This setting is used to set the sound output when headphones are connected.

Speaker Link	Headphone	Speakers
On	Sound is output (◀ ± is available.)	No sound
Off	Sound is output (Headphone level menu is available.)	Sound is output (◀ ± is available.)

- 1 In the **Sound** menu, press ▲ or ▼ to select **Headphone Settings** and press **OK**.
- 2 Press ▲ or ▼ to select **Speaker Link** and press ◀ or ▶ to select **On** or **Off**.
- 3 If you select **Off**, then highlight **Headphone Level** and use ◀ or ▶ to adjust the headphone sound.

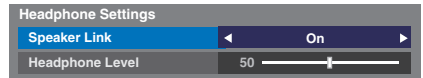

## Audio Description

*Audio Description* is an additional narrative sound track for visually impaired individuals to understand and enjoy the story line more fully. The letters **AD** will be displayed in the channel banner when programmes contain **AD** content.

- 1 In the **Sound** menu, press ▲ or ▼ to select **Audio Description** and press **OK**.
- 2 Press ▲ or ▼ to select **Audio Description** and press ◀ or ▶ to select **On**.

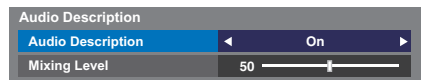

The **AD** button on the Remote can also be used to toggle the **Audio Description** feature between **On** and **Off**.

- 3 To adjust the level of the audio description sound to the main sound, highlight **Mixing Level** and press ◀ or ▶.

# Widescreen viewing

Depending on the type of broadcast being transmitted, programmes can be viewed in a number of formats.

**WIDE**

Use this setting when watching a widescreen DVD, widescreen video tape or a 16:9 broadcast (when available). Due to the range of widescreen formats (16:9, 14:9, 20:9 etc.) black bars may be visible on the top and bottom of the screen.

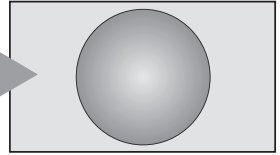

**4:3**

Use this setting to view a true 4:3 broadcast.

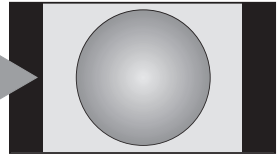

**SUPER LIVE**

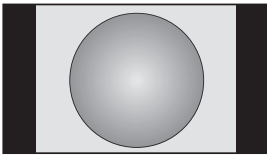

This setting will enlarge a 4:3 image to fit the screen by stretching the image horizontally and vertically, holding better proportions at the centre of the image. Some distortion may occur.

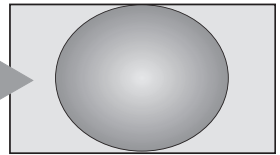

**CINEMA**

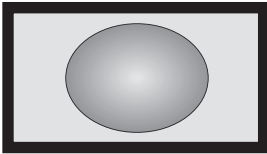

When watching 'all sides panel format' films/video tapes, this setting will eliminate or reduce the black bars at all sides of the screen by zooming in and selecting the image without distortion.

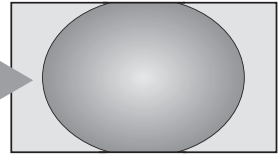

**SUBTITLE**

When subtitles are included on a letterbox format broadcast, this setting will raise the picture to ensure that all the text is displayed.

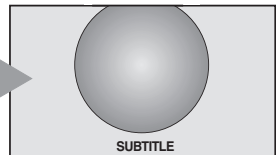

**14:9**

Use this setting when watching a 14:9 broadcast.

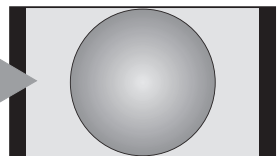

**NATIVE**

This setting will show the picture without overscan, i.e. WYSIWYG.

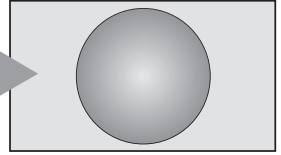
**PC NORMAL**

This setting will show the picture without overscan, i.e. WYSIWYG. This option is only available when watching a PC signal source via HDMI or PC terminal.

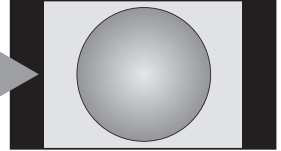
**PC WIDE**

This setting will show the picture without overscan or side panels. This option is only available when watching a PC signal source via HDMI or PC terminal.

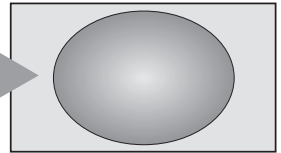
**Dot by Dot**

"Dot by Dot" is a non-scaling display. Depending on the input signal format, the picture is displayed with side panels and/or bars at the top and bottom (e.g. VGA input source).

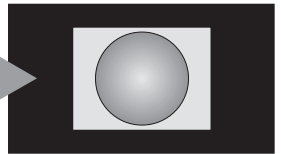

Press the  button on the Remote to display the list of available widescreen formats.

Press the button repeatedly to highlight the required format.

The **Quick Menu** feature can also be used to select **Picture Size**.

AV format

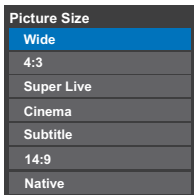

PC format

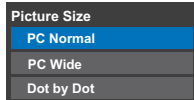

Using the special functions to change the size of the displayed image (i.e. changing the height/width ratio) for the purposes of public display or commercial gain may infringe on copyright laws.

## Picture controls

Most of the picture controls and functions are available in both **digital** and **analogue** modes.  
**PLEASE NOTE:** Features not available will be grayed out.

### Picture Mode

This television offers the choice of personalising the picture style.

**AutoView, Dynamic, Standard, Hollywood 1, Hollywood 2, Store, Game and PC** are preset options and affect many features/settings within the television.

#### NOTE:

- Because the **AutoView** mode automatically adjusts picture settings based on ambient light conditions and input signal content, the **Auto Brightness Sensor** menu is grayed out when it is selected.
- **Store** mode is only available when **Location** is set to **Store**.
- **Game** mode is available in external input mode (other than aerial input). When you select **Game** mode, suitable widescreen formats will be selected.
- **PC** mode is available in RGB/PC input mode or HDMI input mode.

- 1 Press **MENU** / ◀▶ to highlight **Setup** icon.
- 2 Press ▲ / ◀▶ to highlight **Picture** icon and press **OK**.
- 3 Press ▲ or ▼ to select **Picture Mode**.

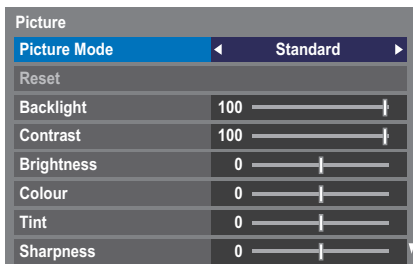

- 4 Press ◀ or ▶ to select the picture mode you prefer and press **OK**.

**NOTE:** The picture mode you select affects the current input only. You can select a different picture mode for each input.

### Picture preferences

You can customize current picture mode settings as desired. For example, while selecting "**Dynamic**", if you change the following items, such as **Backlight, Contrast, Brightness, Colour, Tint, Sharpness** and the **Advanced Picture Settings** items, your new settings are saved for "**Dynamic**" picture mode.

- 1 In the **Picture** menu, press ▲ or ▼ to select either **Backlight, Contrast, Brightness, Colour, Tint** or **Sharpness** and press **OK**.

- 2 Press ◀ or ▶ to adjust the settings.

### Reset

This feature resets all picture settings to the factory settings except **Picture Mode**.

- 1 In the **Picture** menu, press ▲ or ▼ to select **Reset** and press **OK**.
- 2 A confirmation message will appear. Press ◀ or ▶ to select **Yes** and press **OK**.

### ColourMaster

When **ColourMaster** is set to **On**, it allows the 'Base Colour Adjustment' feature to become available.

- 1 In the **Picture** menu, press ▲ or ▼ to select **Advanced Picture Settings** and press **OK**.
- 2 Press ▼ to select **ColourMaster**.

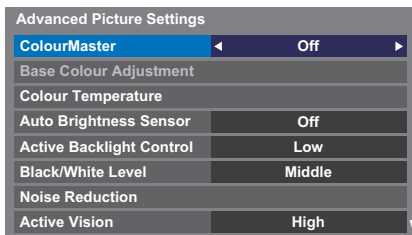

- 3 Press ◀ or ▶ to select **On** or **Off** and press **OK**.

## Base Colour Adjustment

The **Base Colour Adjustment** feature allows the adjustment of individual colours to suit personal preference. This can be useful when using an external source.

- 1 In the **Advanced Picture Settings** menu, press ▲ or ▼ to select **Base Colour Adjustment** and press **OK**.
- 2 Press ▲ or ▼ to select an option and press ► to move to the adjustment window.

Base Colour Adjustment			
	Hue	Saturation	Brightness
<input type="checkbox"/> Red	0	0	0
<input type="checkbox"/> Green	0	0	0
<input type="checkbox"/> Blue	0	0	0
<input type="checkbox"/> Yellow	0	0	0
<input type="checkbox"/> Magenta	0	0	0
<input type="checkbox"/> Cyan	0	0	0
Reset			

- 3 Press ◀ or ▶ to select **Hue**, **Saturation** or **Brightness** and press ▲ or ▼ to adjust the settings as required.

	Hue	Saturation	Brightness
<input type="checkbox"/> Red	0	0	-1

- 4 Press **BACK** to return to the previous menu.  
To return to the factory settings, select **Reset** and press **OK**.

## Colour Temperature

**Colour Temperature** increases the "warmth" or "coolness" of the picture by increasing the red or blue tint.

- 1 In the **Advanced Picture Settings** menu, press ▲ or ▼ to select **Colour Temperature** and press **OK**.
- 2 Press ▲ or ▼ to select **Colour Temperature** and press ◀ or ▶ to select **Cool**, **Natural** or **Warm** to suit your preference.
- 3 Press ▲ or ▼ to select **Red Level**, **Green Level** or **Blue Level** and press ◀ or ▶ to adjust the level.

**NOTE:** To return the adjustments to the factory defaults, select **Reset** and press **OK**.

## Auto Brightness Sensor

When the **Auto Brightness Sensor** is activated, it will automatically optimise the backlighting levels to suit ambient light conditions.

- 1 In the **Advanced Picture Settings** menu, press ▲ or ▼ to select **Auto Brightness Sensor**.
- 2 Press ◀ or ▶ to select **On** or **Off**.

## Active Backlight Control

When the **Active Backlight Control** feature is activated, it will control the backlighting levels depending on various scenes such as picture motion bright scene or dark scene.

- 1 In the **Advanced Picture Settings** menu, press ▲ or ▼ to select **Active Backlight Control**.
- 2 Press ◀ or ▶ to select **High**, **Low** or **Off**.

**High:** To control the backlighting levels depending on various scenes such as motion picture bright scene or dark scene

**Low:** To control the backlighting levels for dark scene

## Black/White Level

**Black/White Level** increases the strength of dark areas of the picture to improve the definition.

- 1 In the **Advanced Picture Settings** menu, press ▲ or ▼ to select **Black/White Level**.
- 2 Press ◀ or ▶ to select **High**, **Middle**, **Low** or **Off**.

## MPEG NR – Noise Reduction

When watching a DVD, the compression may cause some words or picture elements to become distorted or pixelated. Using the **MPEG NR** feature reduces this effect by smoothing out the edges.

- 1 In the **Advanced Picture Settings** menu, press ▲ or ▼ to select **Noise Reduction** and press **OK**.
- 2 Press ▼ to select **MPEG NR**.



- 3 Press ◀ or ▶ to select **High, Middle, Low** or **Off** to suit your preference.

## DNR – Digital Noise Reduction

**DNR** allows you to “soften” the screen representation of a weak signal to reduce the noise effect.

- 1 Select **DNR** from the **Noise Reduction** menu.
- 2 Press ◀ or ▶ to select **Low, Middle, High, Auto** or **Off**. The differences may not always be noticeable (for the best result use lower settings as picture quality can be lost if the setting is too high).

## Active Vision

This feature will reduce picture blur without decreasing image brightness or adding flicker.

- 1 In the **Advanced Picture Settings** menu, press ▲ or ▼ to select **Active Vision**.
- 2 Press ◀ or ▶ to select **High, Middle, Standard** or **Off**.

**NOTE:** When **Picture Mode** is set to **Game**, this feature will be grayed out and automatically set to **Off**.

## Resetting the advanced picture settings

This feature allows you to reset the current **Advanced Picture Settings** to the default values.

- 1 In the **Advanced Picture Settings** menu, press ▲ or ▼ to select **Reset**.
- 2 Press **OK**.

## Automatic Format (Widescreen)

When this television receives a true **Widescreen** picture and **Auto Format** is **On**, it will automatically be displayed in **Widescreen** format irrespective of the television's previous setting.

- 1 Press **MENU** / ◀▶ to highlight **Setup** icon.
- 2 Press ▲ / ◀▶ to highlight **Preferences** icon and press **OK**.
- 3 Press ▲ or ▼ to select **Display Settings** and press **OK**.
- 4 Press ▲ or ▼ to select **Auto Format** and press ◀ or ▶ to select **On** or **Off**.

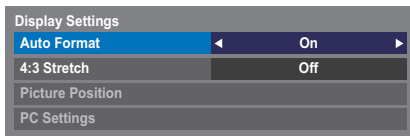

## 4:3 Stretch

When **4:3 Stretch** is activated, the size switching system changes 4:3 programmes into full screen picture.

- 1 In the **Preferences** menu, press ▲ or ▼ to select **Display Settings** and press **OK**.
- 2 Press ▲ or ▼ to select **4:3 Stretch** and press ◀ or ▶ to select **On** or **Off**.

## Blue Screen

When **Blue Screen** is selected, the screen will turn blue and the sound will be muted on analogue channels and external input modes when no signal is received.

**NOTE:** Some external input sounds may not be muted.

- 1 In the **Preferences** menu, press ▲ or ▼ to select **Blue Screen**.
- 2 Press ◀ or ▶ to select **On** or **Off**.



## Picture Position

The picture position may be adjusted to suit personal preference and can be particularly useful for external inputs.

**NOTE:** The **Picture Position** feature cannot be selected in the DTV mode.

- 1 In the **Preferences** menu, press ▲ or ▼ to select **Display Settings** and press **OK**.
- 2 Press ▲ or ▼ to select **Picture Position**.



- 3 Press **OK** to view the options available for the picture format that has been selected.
- 4 Press ▲ or ▼ to select an option and press ◀ or ▶ to adjust the settings.

The options differ depending on the currently selected widescreen format and the input signal.

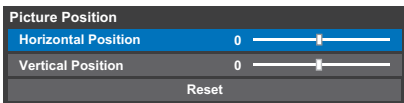

To return to the original factory settings, select **Reset** in the **Picture Position** menu and press **OK**.

## Picture still

This feature is used to hold a still image on the screen.

- 1 Press to hold an image on the screen, and press again to cancel.

## Using your home network

This TV is a DLNA CERTIFIED™ Player. This TV can play digital content stored on a DLNA CERTIFIED™ product with server function.

If you want to use this TV as a DLNA CERTIFIED™ Player, you will have to configure the network on your TV (see page 13).

If you want to use your home network, you will have to configure the network on your TV. (see page 13)

Change the network settings if necessary (see “Setting up the Network” on page 43).

### When using a wireless home network:

#### Wireless Interoperability

The TOSHIBA Dual Band WLAN Adaptor is designed to be interoperable with any wireless LAN product that is based on Direct Sequence Spread Spectrum (DSSS)/Orthogonal Frequency Division Multiplexing (OFDM) radio technology, and is compliant to:

- The IEEE 802.11 Standard on Wireless LANs (Revision a/b/g/n), as defined and approved by the Institute of Electrical and Electronics Engineers.
- The TOSHIBA Dual Band WLAN Adaptor is intended for use with the TL96 and UL97 series LCD TV's and should not be used with any other devices.

Use of the WLAN Adaptor in other USB products may result in damage to the WLAN Adaptor and/or the equipment. Such use will void any warranty that may otherwise apply, and TOSHIBA will have no liability for any damage that may result from such use.

#### CAUTION

Bluetooth™ and Wireless LAN devices operate within the same radio frequency range and may interfere with one another. If you use Bluetooth™ and Wireless LAN devices simultaneously, you may occasionally experience a less than optimal network performance or even lose your network connection.

If you should experience any such problem, immediately turn off either your Bluetooth™ or Wireless LAN device.

Actual performance can vary, including lower wireless network capacity, data throughput rate, range and coverage.

Performance depends on many factors, conditions and variables, including distance from the access point, volume of network traffic, building materials and construction, operating system used, mix of wireless products used, interference and other adverse conditions.

### Wireless LAN and your Health

Wireless LAN products, like other radio devices, emit radio frequency electromagnetic energy. The level of energy emitted by Wireless LAN devices, however, is far less than the electromagnetic energy emitted by wireless devices such as mobile phones.

Because Wireless LAN products operate within the guidelines found in radio frequency safety standards and recommendations, TOSHIBA believes Wireless LAN is safe for use by consumers. These standards and recommendations reflect the consensus of the scientific community and result from deliberations of panels and committees of scientists who continually review and interpret the extensive research literature.

In some situations or environments, the use of Wireless LAN may be restricted by the proprietor of the building or responsible representatives of the organization. Such restrictions may apply in environments where the risk of interference to other devices or services is perceived or identified as harmful.

If you are uncertain of the policy that applies to the use of wireless devices in a specific organization or environment, you are encouraged to ask for authorization to use the Wireless LAN device prior to turning on the equipment.

This Dual Band Wireless LAN Adaptor may be operated in the following countries:

<b>AT</b>	Austria	<b>IS</b>	Iceland
<b>BE</b>	Belgium	<b>LI</b>	Liechtenstein
<b>CH</b>	Switzerland	<b>LT</b>	Lithuania
<b>CY</b>	Cyprus	<b>LU</b>	Luxembourg
<b>CZ</b>	Czech Republic	<b>LV</b>	Latvia
<b>DE</b>	Germany	<b>MT</b>	Malta
<b>DK</b>	Denmark	<b>NL</b>	Netherlands
<b>ES</b>	Spain	<b>NO</b>	Norway
<b>FI</b>	Finland	<b>PL</b>	Poland
<b>FR</b>	France	<b>PT</b>	Portugal
<b>GB</b>	United Kingdom	<b>SE</b>	Sweden
<b>GR</b>	Greece	<b>SI</b>	Slovenia
<b>EE</b>	Estonia	<b>SK</b>	Slovakia
<b>HU</b>	Hungary	<b>BG</b>	Bulgaria
<b>IT</b>	Italy	<b>RO</b>	Romania
<b>IE</b>	Ireland	<b>TR</b>	Turkey

### How to use this Dual Band Wireless LAN Adaptor

- If this device is going to be operated in the frequency range of 5.15 GHz to 5.35 GHz, it is restricted to indoor use.
- If this device is going to be operated for 802.11 b/g/n function in the frequency range of 2.454 GHz to 2.4835 GHz in France, it is restricted to indoor use.
- A general authorization is required for using this device outdoors or in public places in Italy.
- This device is NOT ALLOWED to be used in the geographical area within a radius of 20km from the centre of Ny-Alesund in Norway.

## Setting up the Network

You can select the Network Type.

- 1 Press **MENU** / ◀▶ to highlight **Setup** icon.
- 2 Press ▲/◀▶ to highlight **Preferences** icon and press **OK**.
- 3 Press ▲ or ▼ to select **Network Setup** and press **OK**.

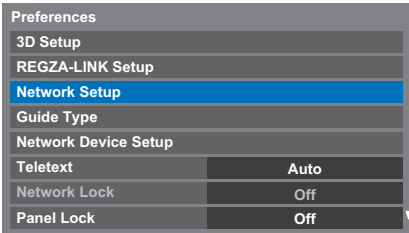

- 4 Press ▲ or ▼ to select **Network Type** and press ◀▶ to select **Wired** or **Wireless**.

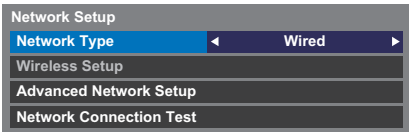

**NOTE:** If the Dual Band WLAN Adaptor is not connected, Wireless cannot be selected.

- 5 If you selected **Wired**, see “Advanced Network Setup” on page 45.

### Wireless Setup

#### NOTE:

- This feature is grayed out when the Dual Band WLAN Adaptor is not connected or Network Type is set to Wired.
- When you insert or remove the wireless LAN adaptor, you must turn off your TV and unplug the power cord, and then plug and turn on again.
- Continued connection of **AP** (Access Point) is not guaranteed. The connection may be disconnected while watching TV.
- Do not remove the Dual Band WLAN Adaptor when **Network Type** is set to **Wireless** or wireless communication is active.

There are 2 methods for Wireless Setup:

#### Assisted setup by using the Wi-Fi Routers notification information.

Network name, Authentication and Encryption are decided based on information sent from the Wi-Fi router. Security key to be set manually.

#### Manual setup

Network name, Authentication, Encryption and Security Key all to be inputted manually.

### Assisted Setup

- 1 In the **Preferences** menu, press ▲ or ▼ to select **Network Setup** and press **OK**.
- 2 Press ▲ or ▼ to select **Network Type** and press ◀▶ to select **Wireless**.
- 3 Press ▲ or ▼ to select **Wireless Setup** and press **OK**.
- 4 Press ▲ or ▼ to select **Assisted Setup** and press **OK**.



- 5 Press ▲ or ▼ to select the desired AP and press **OK**.  
**NOTE:** Check the MAC address on the label of the AP or in the manual, and select your AP.
- 6 Highlight **Security Key** and press **OK**. The Software Keyboard window will appear.
- 7 Input the Security Key by using the Software Keyboard (see page 47). To save your setting, press the **BLUE** button.

#### NOTE:

- The Security Key must adhere to these conditions:
  - TKIP/AES: 8-63 ASCII or 64 Hex characters
  - WEP: 5 or 13 ASCII or 10 or 26 Hex characters
- There is only one key ID to set for WEP encryption.

- 8 Highlight **Done** and press **OK**.

**NOTE:** If **Network Name** is not displayed, see step 4 and 5 in **Manual Setup** below to set **Network Name** before pressing **Done**.

**NOTE:** Settings are not saved if **BACK** is pressed before **Done** is selected.

### Manual Setup

- 1 In the **Preferences** menu, press ▲ or ▼ to select **Network Setup** and press **OK**.
- 2 Press ▲ or ▼ to select **Network Type** and press ◀▶ to select **Wireless**.
- 3 Press ▲ or ▼ to select **Wireless Setup** and press **OK**.
- 4 Press ▲ or ▼ to select **Manual Setup** and press **OK**.
- 5 Press ▲ or ▼ to select **Network Name** and press **OK**. The Software Keyboard window will appear.

**6** Input the Network Name by using the Software Keyboard (see page 47). To save your setting, press the **BLUE** button.

**7** Press **▲** or **▼** to select **Authentication** and press **◀** or **▶** to select **Open System, Shared Key, WPA-PSK** or **WPA2-PSK**.

**8** Press **▲** or **▼** to select **Encryption** and press **◀** or **▶** to select **None, WEP, TKIP** or **AES**.

**NOTE:**

- Certain encryption types are only compatible with specific authentication types.
  - When Authentication is Open System, only WEP or None is compatible.
  - When Authentication is Shared Key, only WEP is compatible.
  - When Authentication is WPA-PSK or WPA2-PSK, only TKIP or AES is compatible.
- When incompatible Authentication/Encryption pairings are detected, a warning message will be displayed, and no connection attempt will be made until the incompatibility is resolved.
- There is only one key ID to set for WEP encryption.

**9** Press **▲** or **▼** to select **Security Key** and press **OK**.

**10** Input the Security Key by using the Software Keyboard (see page 47). To save your setting, press the **BLUE** button.

**NOTE:** This item is grayed out when **Encryption** is **None**.

**11** Highlight **Done** and press **OK**.

**NOTE:** When **Encryption** is **None**, a message will appear. Press **◀** or **▶** to select **Yes** and press **OK**.

**NOTE:** Settings are not saved if **BACK** is pressed before **Done** is selected.

**Wireless Information**

The settings configured in Wireless Setup can be confirmed.

**1** Press **QUICK** to open the **Quick Menu**.

**2** Press **▲** or **▼** to select **Wireless Information** and press **OK**.

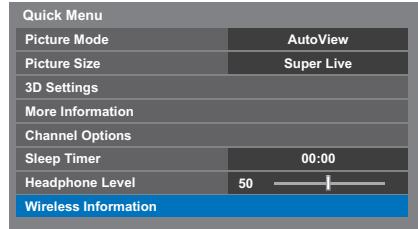

**3** When the **Network Type** is **Wireless**, a Wireless Information window will appear.

**NOTE:** Press the **RED** button to scan for all APs.

Item	Description
Status	<b>Connected</b> is displayed when the TV is connected with the AP. <b>Disconnected</b> is displayed when the TV is not connected with the AP.
Signal	Connection signal strength with AP ( <b>STRONG/MEDIUM/WEAK</b> )
Speed	Link with AP
Mode	Working mode (11a, 11b, 11g, 11n)
Network Name	SSID set
Authentication	Authentication set
Encryption	Encryption set
Security Key	Security Key set
AP MAC Address	The AP's MAC address is displayed when the TV is connected with the AP.
TV MAC Address	The MAC address of the USB (Dual Band WLAN Adaptor) is displayed.
DHCP	<b>Enabled</b> is displayed when using DHCP. <b>Disabled</b> is displayed when not using DHCP.
IP Address	The TV's IP address
Subnet Mask	Value of the Subnet Mask
Default Gateway	Address of the Default GATEWAY
DNS	Address of the DNS

**NOTE:** Even if an AP for IEEE 802.11n is used when **Encryption** is set to **WEP** or **TKIP**, the Speed value might be low. It is recommended that **Encryption** be changed to **AES** (see “Manual Setup” on page 43).

### Notes on wireless LAN environment:

- The function of all IEEE802.11 is not supported.
- The ad-hoc mode is not supported.
- It is recommended to use IEEE 802.11a or IEEE 802.11n on 5 GHz for audio and SD video streaming.
- It is recommended to use IEEE 802.11n on 5 GHz for HD video streaming.
- It is recommended that the encoding rate for streaming video content is 20 Mbps or less.
- It is not recommended to use 2.4 GHz for audio and video streaming.
- Content playback may be interrupted by various surrounding interference.

## Advanced Network Setup

### NOTE:

- When the DHCP function of the router connected with this TV is On, you can set **Auto Setup** to **On** or **Off**. (This should usually be set to **On**.)
- When the DHCP function of the router is Off, set **Auto Setup** to **Off**, and set the IP Address manually.

## IP Address Setup

### Auto Setup:

- 1 In the **Preferences** menu, press ▲ or ▼ to select **Network Setup** and press **OK**.
- 2 Press ▲ or ▼ to select **Advanced Network Setup** and press **OK**.

Network Setup	
Network Type	Wired
Wireless Setup	
Advanced Network Setup	

- 3 Press ▲ or ▼ to select **IP Address Setup** and press **OK**.

Advanced Network Setup	
IP Address Setup	
DNS Setup	
MAC Address	

- 4 Highlight **Auto Setup** and press ◀ or ▶ to select **On**.

IP Address Setup	
Auto Setup	On
IP Address	xxx . xxx . xxx . xxx
Subnet Mask	255 . 255 . 255 . 0
Default Gateway	. . . .

**NOTE:** Other items will be grayed out when **Auto Setup** is set to **On**.

### Manual Setup:

- 1 In the **Preferences** menu, press ▲ or ▼ to select **Network Setup** and press **OK**.
- 2 Press ▲ or ▼ to select **Advanced Network Setup** and press **OK**.
- 3 Press ▲ or ▼ to select **IP Address Setup** and press **OK**.
- 4 Highlight **Auto Setup** and press ◀ or ▶ to select **Off**.

IP Address Setup	
Auto Setup	Off
IP Address	xxx . xxx . xxx . xxx
Subnet Mask	255 . 255 . 255 . 0
Default Gateway	xxx . xxx . xxx . xxx

- 5 Press ▲ or ▼ to select **IP Address**.
- 6 Press ◀ or ▶ to highlight the field you want to change, and then use the number buttons to input the IP address. To save the setting, press **OK**.

**NOTE:** IP address field numbers must be between 0 and 255. After each field number has been set, press **OK** to store the entire address. If the entire IP Address is invalid, a warning message will appear after **OK** is pressed.

- 7 Press ▲ or ▼ to select **Subnet Mask**, and edit in the same way as IP Address.

IP Address Setup	
Auto Setup	Off
IP Address	xxx . xxx . xxx . xxx
Subnet Mask	255 . 255 . 255 . 0
Default Gateway	xxx . xxx . xxx . xxx

- 8 Press ▲ or ▼ to select **Default Gateway**, and edit in the same way as IP Address.

**NOTE:** If you manually set the IP address, you must not use the same IP address for any other device. The IP address you use should be a private address.

## DNS Setup

**NOTE:** When the DHCP function of the router connected to this TV is Off, set Auto Setup to Off, and manually set the DNS address(es). Your internet service provider should have provided these to you.

### Auto setup:

- 1 In the **Preferences** menu, press ▲ or ▼ to select **Network Setup** and press **OK**.
- 2 Press ▲ or ▼ to select **Advanced Network Setup** and press **OK**.
- 3 Press ▲ or ▼ to select **DNS Setup** and press **OK**.
- 4 Press ▲ or ▼ to highlight **Auto Setup** and press ◀ or ▶ to select **On**.

**NOTE:** Other items will be grayed out when **Auto Setup** is set to **On**.

### Manual setup:

- 1 In the **Preferences** menu, press ▲ or ▼ to select **Network Setup** and press **OK**.
- 2 Press ▲ or ▼ to select **Advanced Network Setup** and press **OK**.
- 3 Press ▲ or ▼ to select **DNS Setup** and press **OK**.
- 4 Press ▲ or ▼ to select **Auto Setup** and press ◀ or ▶ to select **Off**.

DNS Setup	
Auto Setup	◀ Off ▶
Primary DNS Address	xxx . xxx . xxx . xxx
Secondary DNS Address	xxx . xxx . xxx . xxx

- 5 Press ▲ or ▼ to select **Primary DNS Address**.
- 6 Press ◀ or ▶ to highlight the field you want to change, and then use the number buttons to input the Primary DNS Address. To save the setting, press **OK**.  
  
**NOTE:** DNS address field numbers must be between 0 and 255. If you input an incompatible number and press **OK**, the field number will reset to the previous value.
- 7 Press ▲ or ▼ to select **Secondary DNS Address**, and edit in the same way as Primary DNS Address.

## MAC Address

You can view the fixed MAC address for the TV and for the Dual Band WLAN Adaptor, if one is installed.

- 1 In the **Preferences** menu, press ▲ or ▼ to select **Network Setup** and press **OK**.
- 2 Press ▲ or ▼ to select **Advanced Network Setup** and press **OK**.
- 3 Press ▲ or ▼ to select **MAC Address** and press **OK**.

## Network Connection Test

*This function checks the Internet connectivity.*

- 1 In the **Preferences** menu, press ▲ or ▼ to select **Network Setup** and press **OK**.
- 2 Press ▲ or ▼ to select **Network Connection Test** and press **OK**.

A message will appear to indicate if the connection was successful or if it could not be completed.

**NOTE:** The result of Network Connection Test does not always guarantee the connection. Depending on the situation, YouTube may not be able to be used.

### To cancel the Network Connection Test:

- 1 Press **BACK** while searching for the Internet connection.

## Using the software keyboard

You can enter text by using the Software Keyboard. The Software Keyboard window will appear when you press **OK** on a field that accepts character input.

### To enter text using the software keyboard:

- 1 Highlight the desired character on the on-screen software keyboard.
- 2 Press **OK**.
- 3 Repeat steps 1 and 2 until you have entered all desired text.
- 4 Press the **BLUE** button to close the software keyboard and return to the previous screen.

**NOTE:** If **BACK** is pressed, changes are not saved and the software keyboard window is closed. The text will remain as it was before starting the keyboard.

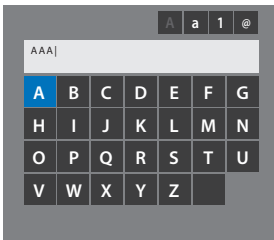

### Input operation on the remote control:

Button	Description
<b>OK</b>	Inputs the selected character.
<b>0-9</b>	Inputs the number directly.
<b>▲▼◀▶</b>	Moves the character highlight.
<b>◀◀▶▶</b>	Moves the cursor.
<b>◀◀</b>	Moves the cursor to the head of a character string.
<b>▶▶</b>	Moves the cursor to the end of a character string.
<b>RED</b>	Deletes 1 character to the left of the cursor.
<b>GREEN</b>	Cycles through upper case, lower case, numbers, and symbols, if available.
<b>BLUE</b>	Saves changes and closes the Software Keyboard window.
<b>BACK</b>	Closes the Software Keyboard window without saving changes.

## Network Device Setup

### External Control Setup

This setup allows you to operate a home network-connected your TV from an external device.

### Media Controller Setup

- 1 In the **Preferences** menu, press **▲** or **▼** to select **Network Device Setup** and press **OK**.

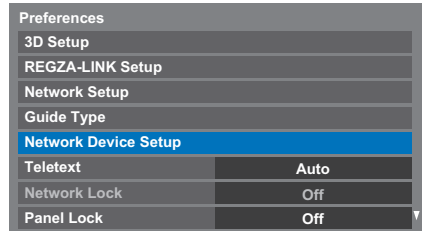

- 2 Press **▲** or **▼** to select **External Control Setup** and press **OK**.
- 3 Press **▲** or **▼** to select an option and press **OK**.

The Software Keyboard window will appear.

**User Name** — Input the User Name (to control the TV from the iPhone etc.) by using the on-screen software keyboard (see page 47). The maximum number of characters is 16.

**Password** — Input the Password (to control the TV from the iPhone etc.) by using the on-screen software keyboard (see page 47). The maximum number of characters is 16.

**NOTE:** Toshiba does not guarantee normal operation with all connected devices.

## Device Name Setup

*The TV's device name can be changed.*

- 1 In the **Preferences** menu, press ▲ or ▼ to select **Network Device Setup** and press **OK**.
  - 2 Press ▲ or ▼ to highlight **Device Name Setup** and press **OK**.
  - 3 Highlight the **Device Name** field and press **OK**. The Software Keyboard window will appear.
  - 4 Input the Device Name by using the software keyboard (see page 47). Press the **BLUE** button.
- NOTE:** The Device Name can be up to 15 characters long.
- 5 Highlight **Done** and press **OK** to save your setting.

## Using Toshiba Places

A new cloud based service, where content (movies, photos, etc.) can be viewed and shared across the web through a simple user interface called "Toshiba Places".

**NOTE:** You need to configure a home network before using this feature (see page 13).

- 1 Press  on the remote control, or press **MENU** / ◀▶ to highlight **Connected TV** icon and press ▲ / ◀▶ to highlight **Toshiba Places** icon and press **OK**.
- 2 Press ▲▼◀▶ to select the desired place and press **OK**.

**NOTE:**



- Some features require an always-on broadband internet connection, firmware update and/or additional bandwidth dedicated to this product. Third party internet services may change or be discontinued or restricted at any time. Toshiba makes no warranties, representations, or assurances about the content, availability or functionality of third-party content or services. Use of third party internet services may require registration by a computer and/or payment of charges and membership. Not all services or content may be available on this product, in your country or with your language. In order to experience the full capabilities of this product, fully compatible devices may be required. For more information, visit <http://www.toshibaplaces.com/about>.
- This service may be forcibly blocked according to the situation of CSP service.



## Using YouTube™

YouTube is a video-sharing service managed by YouTube, LLC.

This TV allows you to view YouTube content.

- 1 Press  on the remote control, or press **MENU** /  to highlight **Connected TV** icon and press **▲** /  to highlight **Toshiba Places** icon and press **OK**.
- 2 Press **▲▼◀▶** to select the **Video Place** icon and press **OK**.
- 3 Press **▲▼◀▶** to select the **YouTube** icon and press **OK**.  
The YouTube top page will appear.

- 4 Press **▲▼◀▶** to select the file you want to view, and press **OK**.

### To close YouTube:

- 1 Press **EXIT**.



#### NOTE:

- This TV may not be able to perform all of the same operations as a computer.
- Depending on the network environment and use case, you may experience difficulty viewing content.
- Though the same volume value, actual volume might be greatly different depending on contents.
- It may take time for the TV to load and begin playing back content.
- Service content and the look and feel of the interface may be changed at any time without prior notice.

## Using Hybrid TV Standard (if available)

Hybrid TV Standard enables the TV to receive HbbTV services. TV services which support this feature often show “press RED” on the screen.

**NOTE:** You need to configure a home network before using this feature (see page 13).

- 1 Press **MENU** /  to highlight **Setup** icon.
- 2 Press **▲** /  to highlight **Preferences** icon and press **OK**.
- 3 Press **▼** to select **Hybrid TV Standard**.
- 4 Press **◀** or **▶** to change from **Disabled** to **Enabled**.

When changing from **Disabled** to **Enabled**, a **Network Connection Test** is performed. If the result is OK, then the setting changes to **Enabled**. If not, the setting remains **Disabled**.

When “**press RED**” is indicated on the screen, press the **RED** button to access HbbTV service site, and then press **▲▼◀▶** to select the desired contents.

#### NOTE:

- This service is not available outside Germany.
- The HbbTV service indication or required key operations may not be possible depending on the service contents. In this case set the **Hybrid TV Standard** setting to **Disabled**.
- Toshiba makes no warranties, representations, or assurances about the content.

## Using the Media Player

This TV allows you to enjoy movie, music and photo files stored on a USB device connected to the USB port.

Moreover, you can also play photos, movies or music files from your PC by connecting the TV to your home network.

### Terminology:

DMP: DLNA CERTIFIED™ Player

DMS: DLNA CERTIFIED™ Server

- DMP: The TV can control and play content from a DMS.
  - A DMS is a device that can function as a server for DMP.

### NOTE:

- Do not insert/remove USB device while in use.
- MENU is not available during playback.

### Media Player Specifications

#### Device

USB device

Interface version: USB2.0 HS

USB Mass Storage Class devices (MSC)

#### NOTE:

- Connectivity is not guaranteed for all devices.
- Incorrect behaviour may occur with a USB hub connection.

File system: FAT16 and FAT32

Maximum memory size: Unlimited

DLNA CERTIFIED™ Server: Your PC (for example)

You must obtain any required permission from copyright owners to download or use copyrighted content. TOSHIBA cannot and does not grant such permission.

## Basic operation

### Using Media Player with USB

When Auto Start is enabled, you will be asked if you want to start the Media Player whenever a USB device is inserted. If Auto Start is disabled (or if you want to connect to a DMS on the network), you must manually start the Media Player from the menu.

#### To change the Auto Start setting:

- 1 Press **MENU** / ◀▶ to highlight **Media Player** icon.
- 2 Press ▲ / ◀▶ to highlight **USB Media Player** and press **OK**.

- 3 Press ▲ or ▼ to select **Media Player setup** and press **OK**.

- 4 Press ▲ or ▼ to select **USB Auto Start** and press ◀ or ▶ to select **On** or **Off**.

#### Auto Start:

- 1 Insert USB device into the USB socket on the left side of the TV. A prompt will appear.
- 2 Press ◀ or ▶ to select **Yes** and press **OK**.
- 3 Press ▲ or ▼ to select **Photo**, **Movie**, or **Music** and press **OK**.
- 4 Select the connected USB device and press **OK**.

**Multi View** will appear.

**NOTE:** If **Auto Start** is set to **Off**, you can start the Media Player manually.

#### Manual Start:

- 1 Insert USB device into the USB socket on the left side of the TV.
- 2 Press **MENU** / ◀▶ to highlight **Media Player** icon.
- 3 Press ▲ / ◀▶ to highlight **USB Media Player** and press **OK**.
- 4 Press ▲ or ▼ to select **Photo**, **Movie** or **Music** and press **OK**.
- 5 Select the connected USB device and press **OK**.

**Multi View** will appear.

#### To select a file in the Multi View:

- 1 Press ▲▼◀▶ to select a file or folder.
- 2 Press **OK** to move to the next layer, or press **BACK** to return to the previous layer.

**NOTE:** You can also return to the previous layer by selecting the icon at the top left of the **Multi View** screen and pressing **OK**.

#### To close the Media Player:

- 1 Press **EXIT**.

## Using the Media Player with a DLNA CERTIFIED™ Server

You need to configure a home network before using this feature (see page 13).

- 1 Press **MENU** / ◀▶ to highlight **Media Player** icon.
- 2 Press ▲/◀▶ to highlight **Network Media Player** and press **OK**.
- 3 Select the server you want to use and press **OK**.

**Multi View** will appear.

### Multi View (DMS)

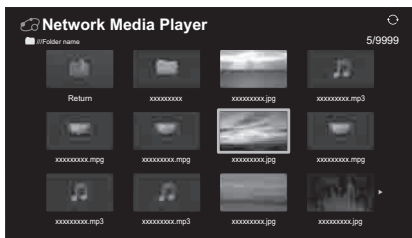

Photo, Movie and Music files and folders are displayed in the **Multi View** (DMS).

Files are displayed according to the type first selected (**Photo**, **Movie** or **Music**).

e.g. If you first selected a Photo file, only Photo files will be displayed.

### To select a file in the Multi View:

- 1 Press ▲▼◀▶ to select a file or folder.
- 2 Press **OK** to move to the next layer, or press **BACK** to return to the previous layer.

**NOTE:** You can also return to the previous layer by selecting the icon at the top left of the **Multi View** screen and pressing **OK**.

### To close the Media Player:

- 1 Press **EXIT**.

## Viewing photo files (on a DLNA CERTIFIED™ Server or USB device)

*There are three types of viewing modes.*

### Multi View (USB Photo)

This view allows you to search for photos in a grid format. The pictures are displayed using thumbnail data in each image file.

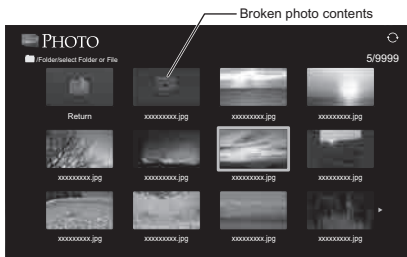

The initial highlighted position will be on the top left thumbnail in the Multi View.

- 1 Press ▲▼◀▶ to move the highlight in one window. If all of the photos will not fit in one screen, when pressing ◀ at the top left thumbnail, the screen will move to the previous page. Conversely, when pressing ▶ at the bottom right thumbnail, the screen will move to the next page.

**P**^ (or ◀◀/▲) **P**^ (or >>/▼) buttons can be used to page up/down the **Multi View** when there are more photos than will fit onto one screen. When the **P**^ (or ◀◀/▲) **P**^ (or >>/▼) buttons are pressed, the highlight shall be on the photo at the top left of **Previous/Next Multi View**.

**NOTE:** The page down function on the last page and page up function on the first page are not available.

- 2 When you select a folder, press **OK** to move to the next layer. Press **BACK** to move back to the previous layer.
- 3 Press **OK** to view the selected photo in Single View mode.

## Single View

In this mode, only files located in the selected directory will be displayed. This view allows you to change the photo content manually. When moving from Multi View to Single View, the currently selected photo will be displayed.

- 1** Press **▶** to view the next photo. Press **◀** to view the previous photo.
- 2** Press **▲** to rotate the image 90° clockwise. Press **▼** to rotate the image 90° counterclockwise.
- 3** Press **[i+]** to display file status information (file number, photo title, resolution etc.).

### NOTE:

- The information may not be correctly displayed depending on the contents or DMS.
- You can not rotate in 3D (2D to 3D) mode.

## Slide Show

This view allows you to watch a slide show of your photos. In this mode, only files located in the selected directory will be played.

- 1** To start slide show, press **OK** in the Single View mode.
- 2** Press **◀** or **▶** to view the previous/next photo.
- 3** Press **[i+]** to display file status information.

**NOTE:** Pressing **▲** or **▼** while in the **Slide Show** mode will stop the slideshow and rotate the photo.

## To set Interval Time and Repeat settings:

- 1** Press **QUICK** to open the **Quick Menu**.
- 2** Press **▲** or **▼** to select either **Interval Time** or **Repeat**.
- 3** Press **◀** or **▶** to adjust the setting and press **OK**.

**NOTE:** When in the DMS and **Multi View** modes, this feature cannot be used.

## To set Background Music (USB only)

- 1** Press **QUICK** to open the **Quick Menu** while in the Slide Show mode.
- 2** Press **▲** or **▼** to select **Background Music** and press **◀** or **▶** to select **On**.

The music file in the same folder as the displayed photo will start playing.

### NOTE:

- When the music file repeat mode is set to **All** (see page 56), all the music files in the same folder as the photo will be played repeatedly.
- To stop music file playback, select **Off** in **Background Music**.

## To zoom in/out photos

During the Single View mode or Slide Show mode, the zoom function can be used.

### RED button (Zoom in)

**USB:** x1 → x2 → x4 → x8 zoom

**DMP:** x1/8 → x1/4 → x1/2 → x1 → x2 → x4 → x8 zoom

### GREEN button (Zoom out)

**USB:** x8 → x4 → x2 → x1 zoom

**DMP:** x8 → x4 → x2 → x1 → x1/2 → x1/4 → x1/8 zoom

**BACK button:** Normal playback

**▲▼◀▶ buttons:** Vertical or Horizontal scrolling

**NOTE:** Using the zoom function while in the **Slide Show** mode will stop the slideshow and zoom in/out the photo.

## Selecting the Playback Mode (USB only)

You can view 3D photos in 3D and you can also view 2D photos in 3D.

Select the playback mode from the Quick Menu or switch playback modes using the **3D** button on the remote control.

The current **Playback Mode** is displayed at the top left of the list mode.

## To select the playback mode from the Quick Menu

- 1** Press **QUICK** to open the **Quick Menu** in Multi View mode.
- 2** Press **▲** or **▼** to select **Playback Mode** and press **OK**.
- 3** Press **▲** or **▼** to select **2D Mode**, **3D Mode 1** or **3D Mode 2**.

### 2D Mode

All photos are displayed in 2D.

### 3D Mode 1

3D photos are displayed in 3D and 2D photos in 2D.

### 3D Mode 2

All photos are displayed in 3D.

2D photos are converted and displayed in 3D, and 3D photos are displayed in 3D.

## To switch playback modes using the remote control

- 1** Press **3D** while in **Single View** mode.

The mode switches between **2D Mode**, **3D Mode 1** and **3D Mode 2** each time **3D** is pressed.

### To select a photo from Play List

While in the **Single View** mode or **Slide Show** mode, you can select a different photo from the **Play List**.

- 1 Press **QUICK** to open the **Quick Menu** from **Single View** mode or **Slide Show** mode.
- 2 Press **▲** or **▼** to select **Play List** and press **OK**.  
The Photo List will appear.
- 3 Press **▲** or **▼** to select a file name.

### To close the Photo Viewer

- 1 Press **EXIT**. The television will return to the last viewed channel or external input.

### File Compatibility

See page 80.

## Viewing movie files (on a DLNA CERTIFIED™ Server or USB device)

You can select movies from a **Multi View** of available files.

### Multi View (USB Movie)



- 1 Press **▲▼◀▶** to select a file or folder. **P^** (or **◀◀/^^**) **Pv** (or **▶▶/v**) buttons can be used to page up/down the **Multi View** when there are more files than will fit onto one screen.

**NOTE:** The page down function on the last page and page up function on the first page are not available.

- 2 When you select a folder, press **OK** to move to the next layer. Press **BACK** to move back to the previous layer.
- 3 With the desired file selected, press **OK** or **▶** (play) to start playback.

**NOTE:**

- On preview screen, if you highlight the file without pressing **OK**, the content is played on a preview screen. When **OK** is pressed, it is played in full screen mode.
- Depending on the file size, it may take some time to start playback.

- 4 Press **■** to stop playback.

**NOTE:**

- If playback finishes before **■** is pressed, the screen will return to the **Multi View**.
- Depending on the file size, it may take some time for playback to begin.

**During playback:**

- Press **IIII** to pause.  
PAUSE may not be available depending on the contents or DMS.
- To resume normal playback, press **▶** (play).
- To play in fast reverse or fast forward directions, press **◀◀** or **▶▶** during playback. Each time you press the **◀◀** or **▶▶**, the playback speed will change.
- To locate a specific file, press **◀◀** or **▶▶** repeatedly.
- Press **(+)** to display the file status information (content number, movie title, progress time etc.).

**NOTE:**

- The information may not be correctly displayed depending on the contents or DMS.
- During playback, you can adjust the **Picture** and **Sound** menu functions from the **Quick Menu**.
- The playback speed (**◀◀/▶▶**) may not change depending on the stream.

**To select subtitle and audio languages (USB only)**

- Press **SUBTITLE** repeatedly to select your preferred subtitle language.
- Press **◻/II** repeatedly to select your preferred audio language.

**NOTE:** This feature is not available depending on the contents.

**To set the repeat mode**

- 1** Press **QUICK** to open the **Quick Menu**.
- 2** Press **◀** or **▶** to select **Off**, **All** or **1**.

Mode	Description
<b>Off</b>	The file is played back only once.
<b>All</b>	Files in the same folder are repeatedly played back.
<b>1</b>	The same file is repeatedly played back.

- 3** Press **BACK**.

**NOTE:** When in the DMS and **Multi View** modes, this feature cannot be used.

**Resume Play (USB only)**

You can resume playback from where it was last stopped.

Press **■** while playing the movie to memorize the stopped position.

On the **Multi View** screen, if you select a movie whose stopped position has been memorized, the message "Resume Play?" will appear. Select **Yes** to resume playback from the last stopped position.

**NOTE:** If you play different content or exit **Media Player**, the memorized stopped position will be deleted.

**To select a movie from Play List**

While playing a movie, you can select a different movie from the **Play List**.

- 1** Press **QUICK** to open the **Quick Menu**.
- 2** Press **▲** or **▼** to select **Play List** and press **OK**.

The Movie List will appear.

- 3** Press **▲** or **▼** to select a file name.

**To close the Movie Viewer**

- 1** Press **EXIT**.

**File Compatibility**

See page 80.

## To register your TV to a DivX® account

This TV allows you to play back files purchased or rented from DivX® Video-On Demand (VOD) services. When you purchase or rent DivX® VOD files on the internet, you will be asked to enter a registration code.

- 1 In the **Media Player Setup** menu, press **▲** or **▼** to display **DivX® VOD** and press **OK**.
- 2 Press **▲** or **▼** to highlight **DivX® VOD Registration** and press **OK**.

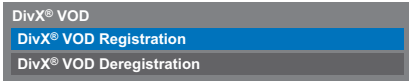

- 3 The **DivX® VOD** window will appear and you will see the registration code. For details on registration, please visit the DivX® website at

<http://vod.divx.com>

- 4 Copy the activation file to a memory device and play it on the TV.

## To deregistration your device

- 1 In step 2 above, highlight **DivX® VOD Deregistration**, and then press **OK**.
- 2 A confirmation message will appear. Select **Yes** and press **OK**.
- 3 The **DivX® VOD** window will appear and you will see the deregistration code. For details on registration, please visit the DivX® website at

<http://vod.divx.com>

**ABOUT DIVX VIDEO:** DivX® is a digital video format created by DivX, LLC, a subsidiary of Rovi Corporation. This is an official DivX Certified® device that plays DivX video. Visit [divx.com](http://divx.com) for more information and software tools to convert your files into DivX videos.

**ABOUT DIVX VIDEO-ON-DEMAND:** This DivX Certified® device must be registered in order to play purchased DivX Video-on-Demand (VOD) movies. To obtain your registration code, locate the DivX VOD section in your device setup menu. Go to [vod.divx.com](http://vod.divx.com) for more information on how to complete your registration.

DivX Certified® to play DivX® video up to HD 1080p, including premium content.

## To playback DivX Plus HD content:

- To play in fast reverse or fast forward directions, press **◀◀** or **▶▶** during playback. Each time you press the **◀◀** or **▶▶**, the playback speed will change.
- This TV generates original chapter point in 10% increments for 10 chapters in total, that are accessible by using the **Number** buttons on the remote control.

During playback, press **▶▶** to skip to the beginning of the next chapter. When **▶▶** is pressed twice in succession, it will repeat two times of above. If **▶▶** is pressed at the last chapter, playback will skip to the beginning of the next content.

Press **◀◀** to skip to the beginning of the current chapter. When **◀◀** is pressed twice in succession, it will skip to the beginning of the previous chapter. If **◀◀** is pressed twice in succession at the first chapter, stop playing the current content and skip to the beginning of the previous content.

The **Number** button is used for direct jump. If the 3 button is pressed, playback will jump to the beginning of 3rd chapter. Even if the playback content has authored chapters, the **Number** button is used to jump directly to Auto Generated Chapter.

If the content has Authored Chapters, **◀◀** / **▶▶** are using for Authored Chapters.

### NOTE:

- Depending on the content data will not be operated.
- The playback speed (**◀◀** / **▶▶**) may not change depending on the stream.

## Using Multi Title and Alternative Timelines Multi Title

DivX Plus HD files may contain up to 100 titles.

You can change the title (It contains same video file) by pressing the **RED** button.

When the **RED** button is pressed, it will display the title change window at the bottom on the screen (same as Subtitle or Audio change window).

The title is changed cyclically each time the **RED** button is pressed. Playback will start from start time of selected title every **▲** or **▼**.

**NOTE:** Depending on the content data will not be operated.

## Playing music files (on a DLNA CERTIFIED™ Server or USB device)

You can listen to music from a **Multi View** of available files.

### Multi View (USB Music)

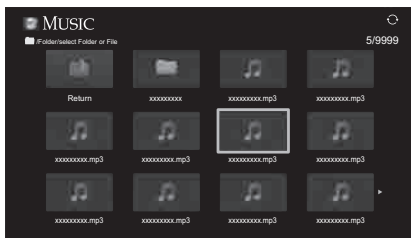

- 1 Press **▲▼◀▶** to select a file or folder. **P^** (or **◀◀ / ^**) **Pv** (or **▶▶ / v**) buttons can be used to page up/down the **Multi View** when there are more files than will fit onto one screen.

**NOTE:** The page down function on the last page and page up function on the first page are not available.

- 2 When you select a folder, press **OK** to move to the next layer. Press **BACK** to move back to the previous layer.
- 3 With the desired file selected, press **OK** or **▶** (play) to start playback.

**NOTE:** If you highlight the file without pressing **OK**, the content is played on a **Multi View**. When **OK** is pressed, it is played in full screen mode.

- 4 Press **■** to stop playback.

**NOTE:**

- Depending on the file size, it may take some time for playback to begin.
- During playback, you can adjust the **Sound** menu functions from the **Quick Menu**.

**During playback:**

- Press **II/III▶** to pause.
- To resume normal playback, press **▶** (play).  
PAUSE may not be available depending on the contents or DMS.
- To play in fast reverse or fast forward directions, press **◀◀** or **▶▶**. Each time you press **◀◀** or **▶▶**, the playback speed will change.

**To set the repeat mode:**

- 1 Press **QUICK** to open the **Quick Menu**.
- 2 Press **▲** or **▼** to select **Repeat**.
- 3 Press **◀** or **▶** to select **Off, All** or **1**.

Mode	Description
<b>Off</b>	Files in the same folder are played back once.
<b>All</b>	Files in the same folder are repeatedly played back.
<b>1</b>	The same file is repeatedly played back.

- 4 Press **BACK**.

**NOTE:** When in the DMS and **Multi View** modes, this feature cannot be used.

**To select a music file from Play List**

While playing a music file, you can select a different music file from the **Play List**.

- 1 Press **QUICK** to open the **Quick Menu**.
- 2 Press **▲** or **▼** to select **Play List** and press **OK**.  
The Music List will appear.
- 3 Press **▲** or **▼** to select a file name

**To display the file status information**

- 1 Press **i+** during playback. The information will be displayed on the bottom of the screen.
- 2 Press **i+** again to remove the information.

**NOTE:** The information may not be correctly displayed depending on the contents or DMS.

**To close the Music Player:**

- 1 Press **EXIT**.

**File Compatibility**

See page 80.



## Other features

### Panel Lock

**Panel Lock** disables the buttons on the television. All buttons on the remote control can still be used.

- 1 Press **MENU** / ◀▶ to highlight **Setup** icon.
- 2 Press ▲ / ◀▶ to highlight **Preferences** icon and press **OK**.
- 3 Press ▲ or ▼ to select **Panel Lock**.
- 4 Press ◀ or ▶ to select **On**.

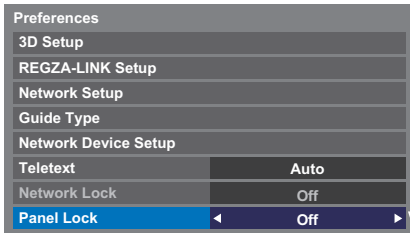

When **Panel Lock** is **On**, a reminder will appear when the buttons on the television are pressed. **If the standby button is pressed, the television will switch off and can only be brought out of standby by using the remote control.**

## The timers

### Programme Timers – digital only

*This feature will set the television to go to a specific channel at a certain time. It can be used to view a particular programme, or by setting the mode to daily or weekly, can be used to view a series of programmes.*

- 1 Press **MENU** / ◀▶ to highlight **TV Programmes** icon.
- 2 Press ▲ / ◀▶ to highlight **Programme Timers** icon and press **OK**.
- 3 Press ▼ if necessary to select an open timer position, then press **OK**. The **Edit Timer** menu will now appear on screen.
- 4 Press ▲ and ▼ to go through the list adding the details of the programme by using the number buttons and ◀ and ▶ to make selections.

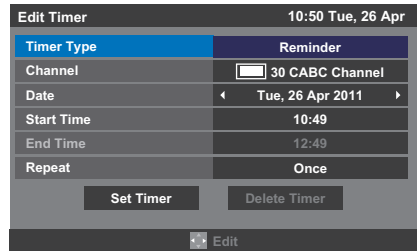

- 5 When all of the details have been entered, highlight **Set Timer** and press **OK** to save the timer.

The **ORANGE** programme timer indicator on the front of the television will be lit (see page 75 for details).

## On Timer

The feature allows you to set the television to turn on automatically to a preset channel at a certain time of day or after a certain length of time.

- 1 Press **MENU** / ◀▶ to highlight **Function** icon.
- 2 Press ▲ / ◀▶ to highlight **On Timer** icon and press **OK**.
- 3 Press ▲ or ▼ to select **Enable On Timer** and press ◀ or ▶ to select **On**.



- 4 Press ▼ to select **Enable DTV Clock**, and then press ◀ or ▶ to select **On** or **Off**.
- 5 Press ▲ or ▼ to go through the list adding the details of the On Timer by using the number buttons and ◀ and ▶ to make selections.

**Power On Time** (only for DTV Clock On mode): Set the time you prefer with the number buttons.

**Repeat** (only for DTV Clock On mode): Select the desired On Timer operation (**Once, Every Day, Mon-Fri, Mon-Sat, Sat-Sun**).

**Input**: Select a video input source (ATV, DTV Ant, EXT 1, EXT 2, HDMI 1, HDMI 2, HDMI 3, HDMI 4 or PC).

**Channel**: Set the channel that will be tuned when the television turns on.

**NOTE**: When an external input is selected in the **Input** field, a channel cannot be selected.

**Volume**: Set the volume that will be applied when the television turns on.

**Time until Power On** (only for DTV Clock Off mode): Set the amount of time from now until the TV turns on using the number buttons (maximum of 12 hours).

- 6 Press ▲ or ▼ to highlight **Done** and press **OK**.

## To cancel the On Timer

- 1 In the **On Timer** menu, select **Enable On Timer**.
- 2 Press ◀ or ▶ to select **Off**.
- 3 Press ▲ or ▼ to highlight **Done** and press **OK**.

## Sleep Timer

The television can be set to turn itself **Off** after a certain length of time.

- 1 Press **MENU** / ◀▶ to highlight **Function** icon.
- 2 Press ▲ / ◀▶ to highlight **Sleep Timer** icon and press **OK**.
- 3 Use the number buttons to set the desired time. For example, to switch the television off in one and a half hours enter 01:30, or press ▶ / ◀ to increase/decrease in steps of 10 minutes. (Maximum time setting is 12 hours)
- 4 Press **EXIT** to finish.
- 5 To cancel the **Sleep Timer**, enter all zeros for the above setting.

## Energy Saving Settings

### Automatic Power Down

The TV will automatically turn itself off (standby) after 4 hours, if you do not operate the TV either from the remote control or the TV control panel.

- 1 Press **MENU** / ◀▶ to highlight **Setup** icon.
- 2 Press ▲/◀▶ to highlight **Preferences** icon and press **OK**.
- 3 Press ▲ or ▼ to select **Energy Saving Settings** and press **OK**.
- 4 Press ▲ or ▼ to select **Automatic Power Down**.
- 5 Press ◀▶ to select **On** or **Off**.

#### NOTE:

- This feature is set to **On** when **Location** is set to **Home**.
- 1 minute before switching to standby, a Warning message will appear.
- When the following features are set, the feature that is set for the nearest time will function.
  - Automatic Power Down
  - Sleep Timer
  - Auto shutdown after 1 hour of inactivity (after power on by On Timer)
  - No signal auto power off (after 15 minute of no signal)

### No Signal Power Down

The TV will automatically turn itself off after 15 minutes when no signal is detected. You can change the setting to Off for the following purposes:

- Low signal strength of analog channel (no signal detection)
- Only Audio L/R is connected to external input to listen to music through the TV speakers.

- 1 In the **Energy Saving Settings** menu, press ▲ or ▼ to select **No Signal Power Down** and press **OK**.
- 2 Press ▲ or ▼ to select the item you want to change and press ◀▶ to select **On** or **Off**.

#### NOTE:

- Default setting is all On.
- A warning message will appear 1 minute before turning off.

## Digital on-screen information

When viewing in **digital** mode, the on-screen information and programme guide provide access to programme details for all available channels.

### Information

- 1 Press **i+**, the information screen will appear giving details of the channel and programme currently being viewed.

#### Display Example

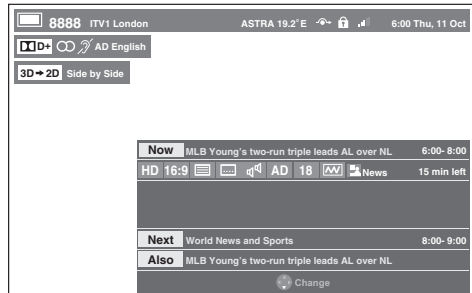

- 2 Press ▲ or ▼ to select the **"Now"**, **"Next"** or **"Also"** information guide.

The selected information content will appear.

### To display More Information

- 1 Press **QUICK** to open the **Quick Menu**.
- 2 Press **▼** to highlight **More Information** and press **OK**.

### On-screen Information icons

	Icon	Description
Service info		Service type (TV, Radio, Text)
		Skip
Audio info		Mono
		Stereo
		Dual mono
		Multichannel
		Dolby Digital
		Dolby Digital+
		When HE-AAC is decoded
		Audio Description
Audio/Subtitle info		For Hard of Hearing
3D info	3D	
	3D→2D	
Event info	HD, SD	Video format (HD, SD)
	16:9, 4:3	Video Aspect
		Teletext
		Subtitle (Single, Multi)
		Audio track (Mono, Multi)
	0, 4 – 18	Parental rating
		Encrypted
Timer info		Reminder

## Using EPG (Electronic Programme Guide)

You can choose the desired EPG system between the **Broadcast Guide** or **MediaGuide** that needs a internet connection.

### Using Broadcast Guide

Make sure you selected **Broadcast Guide** in the **Guide Type** menu of **Initial Setup** (see page 18.) This setup can also be done from the **Setup / System Setup / Quick Setup** menu or **Setup / Preferences / Guide Type** menu any time.

- 1 Select the on-screen Guide by pressing **GUIDE**, and the Guide screen will appear highlighting details of the channel and programme currently being viewed. This may take a few moments to appear.

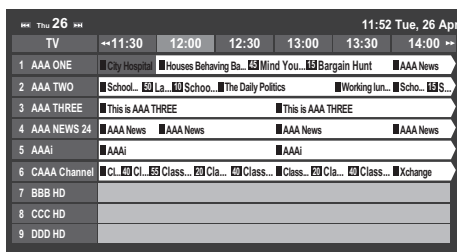

You can switch the time scale to 1.5 or 3 hours by pressing the **GREEN** button.

- 2 Press **◀** or **▶** for information on other programmes scheduled for the channel selected. To highlight the first programme in the genre grid, press the **RED** button.
- 3 For details of other programmes currently available, press **▲** and **▼** to scroll up and down the channel list. As channels are selected, details of the programme currently being broadcast will appear. Press **◀** or **▶** to view information for future programmes.
- 4 For information on a highlighted programme, press **i+**.
- 5 To set the timer for that programme, press the **BLUE** button to bring up the **Programme Timers** menu.
- 6 Press **▶** to advance to the next page, or press **▶** to go back to the previous page.

## Genre selection/searching

From the Guide screen, you can use the genre selection and search features.

- 1 In the Guide screen, press **QUICK**.
- 2 Press **▲** or **▼** to highlight **Genre Colour** in the **Quick Menu** and press **OK**.

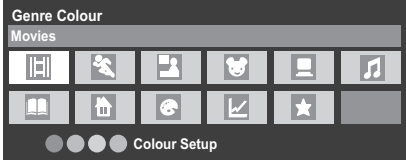

- 3 With the focus on a particular genre, press the desired coloured button to assign. Four colours will be available to set. Press **BACK** to go back to the Guide screen.

## Using MediaGuide

MediaGuide is a service of Rovi Corporation. This service is an integrative media guide through the Internet besides television contents and internet contents.

### NOTE:

- You need to configure a home network before using this feature (see page 13).
- Make sure you selected **MediaGuide** in the **Guide Type** menu of Initial Setup (see page 18.) This setup can also be done from the **Setup / System Setup / Quick Setup** menu any time.

## MediaGuide screen

- 1 Press **GUIDE** on the remote control, or select **Guide** in the **TV Programmes** menu and press **OK**.

The **Listings** menu in the Secondary Navigation will be selected.

Default focus position is the current channel.

### Remote control key operation



This will tune to live TV for the particular show.

If the show is not being aired, you will be directed to the Overview screen with upcoming show times.

## Primary Navigation menu

- 1 In the Secondary Navigation menu, press **◀** to expand the Primary Navigation menu.

### Primary Navigation

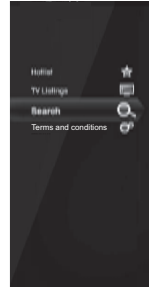

### Hotlist

Press **▲** or **▼** to select **Hotlist** and press **OK**. Shows will be listed. Selecting a movie or show will bring you to the overview page.

### Search

Press **▲** or **▼** to select **Search** and press **OK**.

### Terms and Conditions

Press **▲** or **▼** to select **Terms And Conditions**.

The License Terms and Conditions will be displayed.

### Search screen

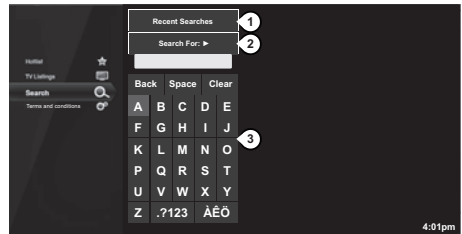

- ① Recent Searches button. Pressing **OK** will take you to the Recent Searches screen.

- ② Search input area displays what you are typing.

Pressing **Search For** will conduct the search and take you to Search Results.

- ③ Search keyboard.

### NOTE:

- Toshiba does not take responsibility for the accuracy of content displayed.
- Service Information may not be displayed or there may be little service information displayed depending on the area or the kind of broadcast.
- The MediaGuide can only be used when your TV is connected to the internet.
- Starting and operation of this service may take time.
- Software update may be needed in order to use this service.
- This service does not support all languages.
- MediaGuide is a service of Rovi Corporation.
- During use of the MediaGuide usage information will be notified to the Rovi server to ensure continued efficient operation of the guide.

- Rovi Corporation and/or its subsidiaries and related affiliates are not in any way liable for the accuracy or availability of the program schedule information or other data in the Rovi Guide system and cannot guarantee service availability in your area. In no event shall Rovi Corporation and/or its related affiliates be liable for any damages in connection with the accuracy or availability of the program schedule information or other data in the Rovi Guide system.
- Third party internet services are not provided by Toshiba, may change or be discontinued at any time and may be subject to internet service provider restrictions. Toshiba makes no warranties, representations, or assurances about the content, availability or functionality of third-party content or services. Use of third party internet services may require the creation of a separate account through a computer with internet access and/or payment of one-time and/or recurring charges and membership. Not all third party services may be available on or compatible with this product. In order to experience the full suggested capabilities of this product, fully-compatible devices may be required.

## Digital settings – parental control

In order to prevent viewing of unsuitable films and programmes, channels and menus can be locked in digital mode. These can then only be accessed with a security code PIN.

### Parental PIN Setup

- 1 Press **MENU** / ◀▶ to highlight **Setup** icon.
- 2 Press ▲ / ◀▶ to highlight **System Setup** icon and press **OK**.
- 3 Press ▲ or ▼ to select **DTV Settings** and press **OK**.

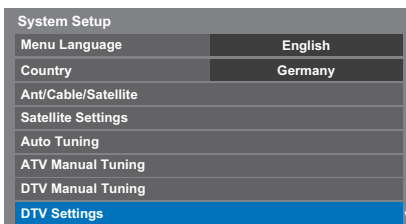

- 4 Press ▲ or ▼ to highlight **Parental PIN Setup** and press **OK**.

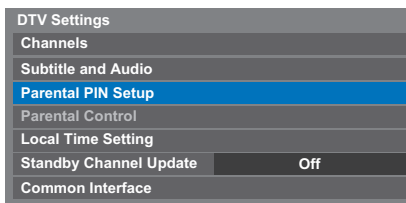

- 5 Using the number buttons enter a four digit number. Once entered you will be prompted to confirm by entering again.



The PIN number is now set.

If the PIN code has been set, when **Auto Tuning** and **Reset TV** are executed, entering the PIN will be necessary. "0000" is not acceptable.

## Parental Setup

The **Parental Control** feature allows you to block programmes according to their rating levels. If a PIN has been set, you will need to enter it before adjusting the level.

- 1 In the **DTV Settings** menu, press **▲** or **▼** to select **Parental Control** and press **OK**.
- 2 Use **◀** or **▶** to choose an option (**None** or an age setting (4-17 or 4-18 depending on the **Country** setting)).



To view blocked programmes, enter the PIN. To reactivate the Parental Control, turn the TV off and then on again.

## Network Lock

You can **use** the Network Lock feature to prevent the Web browser from launching. When this feature is set to **On**, PIN input will be necessary to use network functions.

This feature will be grayed out until a PIN is set.

- 1 Press **MENU** / **◀▶** to highlight **Setup** icon.
- 2 Press **▲** / **◀▶** to highlight **Preferences** icon and press **OK**.
- 3 Press **▲** or **▼** to select **Network Lock**.

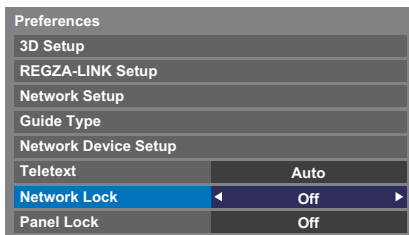

- 4 Press **◀** or **▶** to select **On**.

### To unlock the Network:

- 1 Select **Off** in step 4 above.

## Digital settings – Channel Options

### Selecting favourite channels

From the **Quick Menu / Channel Options** menu, it is possible to create a list of the digital channels that are watched most. Press **LIST** / **◀▶** to select the Favourite Channel list.

- 1 Select a channel you want to add to your favourite list.
- 2 Press **QUICK** to open the **Quick Menu**.
- 3 Press **▼** to select **Channel Options** and press **OK**.
- 4 Press **▶** to select the favourite list (Fav.).

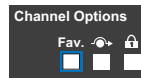

- 5 Press **OK** to select the ones required. A tick will appear in the box as they are selected.
- 6 Repeat steps 1 through 5 for other channels.
- 7 When all favourites have been selected, press **EXIT**.

### Favourite Channel List

- 1 Press **LIST** to display **Channel List**.

Each time you press **◀** or **▶**, **All Channels**, **TV Channels**, **Radio channels**, **Text channels** or **Favourites** is selected in order.

- 2 Press **◀** or **▶** to select **Favourites**. The number of favourites available depends on how many lists have been created.

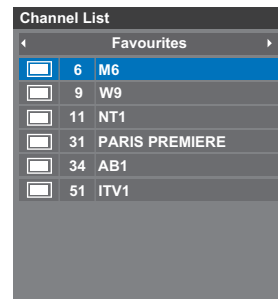

- 3 Press **▲** or **▼** to highlight a channel and press **OK** to watch.

## Skip channels

This feature allows you to set channels that will be skipped when **P** or **P** are used to tune.

- 1 Select the channel you want to skip in your channel list.
- 2 From the **Quick Menu**, press **▼** to select **Channel Options** and press **OK**.
- 3 Press **▶** repeatedly to highlight the skip (👁) box.
- 4 Press **OK** to select. A tick will appear in the box.
- 5 Repeat steps 1 through 4 for other channels.
- 6 Press **EXIT**.

**NOTE:** Skipped channels cannot be selected by **P** or **P** but still be accessed by direct number entry (when tuned a 👁 icon will be displayed in the banner to indicate as a skipped channel).

## Locking channels

**Locking Channels** stops the viewing of **digital** channels, and they can only be accessed by entering the **PIN**.

- 1 Select the channel you want to lock in your channel list.
- 2 From the **Quick Menu**, press **▼** to select **Channel Options** and press **OK**.
- 3 Press **▶** repeatedly to highlight the lock (🔒) box.
- 4 Press **OK** to select. A tick will appear in the box.  
If a PIN has already been set, PIN entry will be required to set the locked channels.
- 5 Repeat steps 1 through 4 for other channels.
- 6 Press **EXIT**.
- 7 From this point on, when any of the channels in the **Locked Channel** list are selected, the PIN must be entered before they can be accessed.

## Digital settings – other settings

### Subtitles

In digital mode, this feature will show subtitles on the screen in the selected language provided they are being broadcast.

- 1 In the **DTV Settings** menu, press **▲** or **▼** to select **Subtitle and Audio** and press **OK**.
- 2 Press **▼** to select **Subtitle Display** and press **◀** or **▶** to select **On** or **Off**.

Subtitle and Audio	
Subtitle Display	◀ Off ▶
Subtitle Type	Normal
Primary Subtitle Language	English
Secondary Subtitle Language	English
Audio Type	Normal
Primary Audio Language	English
Secondary Audio Language	English

- 3 Press **▲** or **▼** to select **Primary Subtitle Language** or **Secondary Subtitle Language** and press **◀** or **▶** to select an option.

The **SUBTITLE** button can be used to select subtitle on or off for the current channel only and to select the subtitle language if more than one subtitle is available.

### Audio languages

This feature allows a programme or film to be viewed with a choice of soundtrack language, provided multiple language tracks are being broadcast.

- 1 In the **Subtitle and Audio** menu, press **▲** or **▼** to select **Audio Type** and press **◀** or **▶** to select **Normal** or **For Hard of Hearing**.
- 2 Press **▲** or **▼** to select **Primary Audio Language** or **Secondary Audio Language** and press **◀** or **▶** to select an option.

If more than one soundtrack is available, use the **◻/◻** button to select between them.



## Common Interface

The *Common Interface Slot*, situated on the side of the television, enables the insertion of a CAM (Conditional Access Module) and card. These are purchased from a service provider and allow additional subscription broadcasts to be viewed. For information, see a service provider.

- 1 Insert the CAM and card into the Common Interface Slot, following the instructions provided with the CAM. A box will appear on screen to confirm that the CAM has been inserted.
- 2 Press **MENU** / ◀▶ to highlight **Setup** icon.
- 3 Press ▲ / ◀▶ to highlight **System Setup** icon and press **OK**.
- 4 Press ▲ or ▼ to select **DTV Settings** and press **OK**.
- 5 Press ▲ or ▼ to select **Common Interface** and press **OK**.
- 6 Details of the CAM should now be available.

### NOTE:

- Software update of a CI Plus CAM may occur automatically if instigated by the broadcaster. This could cause the cancellation of any Reminders/Recordings during this process.
- Some CI or CI+ CAM may not be supported.
- CI+ operation is not guaranteed except for Canal Ready DTT services on suffix FC models.

## Software Upgrade and Licences

### Searching for New Software

If preferred, software upgrades can be searched for manually using **Search for New Software**.

- 1 In the **System Setup** menu, press ▲ or ▼ to select **Software Upgrade** and press **OK**.
- 2 Press ▲ or ▼ to select **Search for New Software**.
- 3 Press **OK**. The television will automatically start searching for a software upgrade, the progress bar will move along the line.



SEARCHING FOR NEW SOFTWARE  
Searching for a new software upgrade for this TV.  
48 %... CH 31

If an upgrade is found, the television will automatically start downloading. If not, a screen will appear stating that an upgrade is unavailable.

### Network Upgrade

*TOSHIBA may offer upgrades for the TV's software in the future. The TV's software is upgraded via the Network.*

#### Before downloading software:

Configure your TV to connect to the Internet.

**NOTE:** While the upgrade is being performed, you will not be able to watch the TV.

- 1 In the **System Setup** menu, press ▲ or ▼ to select **Software Upgrade** and press **OK**.
- 2 Press ▲ or ▼ to select **Network Upgrade** and press **OK**.  
**NOTE:** If the network is not available, a warning message will appear.
- 3 The TV software upgrade will start when download succeeds.

### Software Licences

*The licences for the software used in this television are available for viewing.*

- 1 In the **System Setup** menu, press ▲ or ▼ to select **Software Licences** and press **OK**.

A screen will appear displaying all the licensing information required for the televisions software.

## System Information and Reset TV

### System Information

This feature can be used to check the version of software currently installed. When in DTV mode, it includes additional diagnostic information such as signal strength, signal quality, centre frequency, modulation, etc.

- 1 In the **System Setup** menu, press **▲** or **▼** to select **System Information**.
- 2 Press **OK** to display the **System Information**.

System Information				
TOSHIBA				
2012				
6.8.05.1 Jan 19 2012 - 53. 5. 73. 5				
MBOOT Version : xxxxxxxx				
MFC Version : xxxxxx				
	WEAK	AVERAGE	STRONG	GOOD
CH 25	[Progress Bar]			GOOD
CH 33	[Progress Bar]			GOOD
CH 67	[Progress Bar]			GOOD

- 3 For information about the signal quality of a particular multiplex, press **▲** or **▼** to select that multiplex.
- 4 Press **OK** for a screen showing detailed technical information about the selected multiplex.

### Reset TV

Selecting **Reset TV** will reset all TV settings, including saved channels, to their original factory values.

- 1 In the **System Setup** menu, press **▲** or **▼** to select **Reset TV**.
- 2 Press **OK** to select. A screen will appear warning that all settings will be lost. Press **OK** to continue.

When the set powers back on, the **Quick Setup** screen will appear. Press **OK** to advance the setup and perform an auto tune. (See "Quick Setup" section on page 16.)

## PC Settings

### Horizontal and Vertical Position

Connect the PC (as shown in the 'Connecting a computer' section) and ensure that a picture is showing on the television screen. The picture position may now be adjusted to suit personal preference.

- 1 Press **MENU** / **◀▶** to highlight **Setup** icon.
- 2 Press **▲** / **◀▶** to highlight **Preferences** icon and press **OK**.
- 3 Press **▲** or **▼** to select **Display Settings** and press **OK**.
- 4 Press **▲** or **▼** to select **PC Setting** and press **OK**.

Display Settings	
Auto Format	On
4:3 Stretch	Off
Picture Position	
PC Settings	

- 5 Press **▲** or **▼** to select an option and press **◀▶** to adjust the settings.

PC Settings	
Horizontal Position	0 [Slider]
Vertical Position	0 [Slider]
Clock Phase	0 [Slider]
Sampling Clock	0 [Slider]
Reset	

### Clock Phase

The **Clock Phase** matches the PC signal with the LCD display. Adjusting this can clear horizontal stripes and picture blur.

- 1 In the **Display Settings** menu, press **▲** or **▼** to select **PC Settings** and press **OK**.
- 2 Press **▲** or **▼** to select **Clock Phase**.
- 3 Press **◀▶** to adjust until the picture clears.

## Sampling Clock

Adjusting the **Sampling Clock** alters the number of pulses per scan, this will clear vertical lines on the screen.

- 1 In the **Display Settings** menu, press ▲ or ▼ to select **PC Settings** and press **OK**.
- 2 Press ▲ or ▼ to select **Sampling Clock**.
- 3 Press ◀ or ▶ to adjust until the picture clears.

## Reset

Use **Reset** to return all items to the original factory settings.

- 1 In the **Display Settings** menu, press ▲ or ▼ to select **PC Settings** and press **OK**.
- 2 Press ▲ or ▼ to select **Reset** and press **OK**.

**NOTE: When a PC is connected using HDMI, none of these functions will be available.**

The screen is disrupted momentarily when adjusting PC Settings. This is not a sign of malfunction.

The default settings and adjustment ranges may vary depending on the input signal format.

## Input selection and AV connections

See page 9 for a detailed image showing recommended connections.

Most media recorders and decoders send a signal through the SCART lead to switch the television to the correct *Input* socket.

Alternatively, press the external source selection button  until the picture from connected equipment is shown.



## Input selection



Use the **Input Selection** window if the television does not switch over automatically.

- 1 By pressing  on the remote control or TV, a list will appear on screen showing all inputs and external equipment.

Press  on the remote control

Press and hold  on the TV

Inputs
TV
 1
 2
HDMI 1
HDMI 2
HDMI 3
HDMI 4
PC

Inputs
DTV Ant
DTV Sat
 1
 2
HDMI 1
HDMI 2
HDMI 3
HDMI 4
PC
ATV

HDMI® displays equipment connected to *Input HDMI* on the back or side of the television.

PC displays a computer connected to *Input RGB/PC* on the back of the television.

## Labeling video input sources

These input labels are shown in the input selector. You can label video inputs according to the devices you have connected to the TV.

- 1 Press **MENU** / ◀▶ to highlight **Setup** icon.
- 2 Press ▲/◀▶ to highlight **Preferences** icon and press **OK**.
- 3 Press ▲ or ▼ to select **AV Connection**.

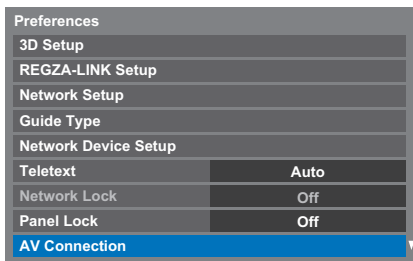

- 4 Press **OK** to display the **AV Connection** menu.
- 5 Press ▲ or ▼ to highlight **Input Labeling** and press **OK**.



- 6 Press ▲ or ▼ to select **Input Labeling** and press **OK**.

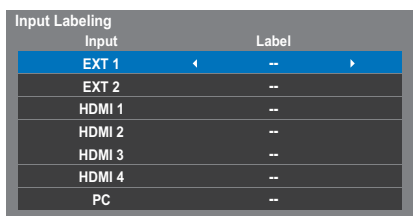

- 7 Press ▲ or ▼ to select the item you want to label, and then press ◀ or ▶ to select --, **Amplifier, Cable, DVD, Game, PC, Recorder** or **Satellite**.
- 8 Repeat step 7 for other video inputs.

## Digital Audio Output

When connecting a surround sound amplifier to the digital audio output (Sony/Philips Digital Interface Format [S/PDIF]), the following options can be selected or adjusted.

- 1 In the **Preferences** menu, press ▲ or ▼ to select **AV Connection** and press **OK**.
- 2 Press ▲ or ▼ to select **Digital Audio Output**.



- 3 Press **OK** to display **Digital Audio Output** menu and press ▲ or ▼ to select an option.

### Audio Format:

Press ◀ or ▶ to select **PCM** or **Auto**.

**PCM:** This mode outputs PCM format to the digital audio output socket.

**Auto:** This mode outputs Dolby Digital (if available) or PCM to the digital audio output socket.

Dolby Digital → Dolby Digital  
 Dolby Digital Plus → Dolby Digital  
 MPEG → PCM  
 HE-AAC → Dolby Digital

### Audio Delay:

Press ◀ or ▶ to select **Auto** or **Manual**.

**Auto:** This mode automatically adjusts the audio timing to meet the video timing.

**NOTE:** The time lag might be large between the image and sound depending on the connected equipment (amplifier etc.). In that case, select **Manual**.

**Manual:** You can manually adjust the audio signal timing to meet the video signal timing.

### Delay Adjustment:

Press ◀ or ▶ to adjust the audio signal timing (0 – 250ms) to meet the video signal timing.

### NOTE:

- This feature is grayed out when **Audio Delay** is in **Auto**.
- A time lag will occur when the video signal or audio signal is changed. Adjust the timing accordingly.
- When adjusting the timing, turn down the volume of the AV equipment used as far as possible. Depending on the equipment, noise etc. may occur when the signal is changed.
- Depending on the connected equipment (amplifier, etc.), adjustment may not be possible.
- When the optical digital output setting (Auto ↔ PCM) is changed, it may be necessary to adjust the timing again.
- Do not use other than for audio output from the AV amplifier, etc. (Malfunction may occur)

## Using REGZA-LINK

This is a new feature that uses CEC technology and allows you to control Toshiba REGZA-LINK compatible devices from the television remote control via HDMI connection (page 11).

When the **Enable REGZA-LINK** item in the **REGZA-LINK Setup** menu is set to **On**, individual functions also set to **On** will be activated.

### Enable REGZA-LINK

- 1 Press **MENU** / ◀▶ to highlight **Setup** icon.
- 2 Press ▲/◀▶ to highlight **Preferences** icon and press **OK**.
- 3 Press ▲ or ▼ to select **REGZA-LINK Setup** and press **OK**.
- 4 Press ▼ to select **Enable REGZA-LINK** and press ◀▶ to select **On**.

REGZA-LINK Setup	
Enable REGZA-LINK	◀ On ▶
TV Auto Power	On
Auto Standby	On

**NOTE:** If you set **Enable REGZA-LINK** to **Off**, all other items will be grayed out.

### TV Auto Power

The **TV Auto Power** setting allows the television to be automatically switched on if a REGZA-LINK device is turned on.

- 1 In the **REGZA-LINK Setup** menu, press ▼ to highlight **TV Auto Power**.
- 2 Press ◀▶ to select **On** or **Off**.

### Auto Standby

When **Auto Standby** is enabled, the television, when switched off, will automatically switch off (standby mode) all connected REGZA-LINK equipment.

- 1 In the **REGZA-LINK Setup** menu, press ▼ to highlight **Auto Standby**.
- 2 Press ◀▶ to select **On** or **Off**.

### REGZA-LINK input source selection

If a REGZA-LINK device with HDMI switching capability (e.g. AV amplifier) is connected to the HDMI input, you can select another REGZA-LINK device that is connected to the master HDMI device on the input source list.

- 1 Press ⏪ and a list will appear on screen showing available input sources.
- 2 Press ▼ to select the desired input source with REGZA-LINK icon.
- 3 Press ▶ and a second selection screen will appear showing all connected REGZA-LINK equipment.

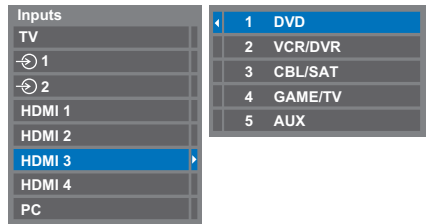

- 4 Press ▲ or ▼ to select the desired input source, and then press **OK**.

#### NOTE:

- These functions depend on the device connected.
- If you select the REGZA-LINK input source from the popup window, some REGZA-LINK devices may automatically turn on.
- When the television is switched on it will take a few minutes for the REGZA-LINK icon to appear in the list. When an HDMI cable is removed, it will take a few minutes for the icon to disappear.
- If the HDMI cable from connected equipment is changed, **Enable REGZA-LINK** in the REGZA-LINK Setup menu may need to be reset to **On**.
- If you change the HDMI lead to a connected device or change an HDMI device setting, reset the **Enable REGZA-LINK** item on the REGZA-LINK Setup menu from **Off** to **On**.

### REGZA-LINK one touch play

When connected equipment is switched on, REGZA-LINK will automatically detect the television through the input selection. If the television is in standby, it will be switched on automatically.

These functions can be enabled or disabled from the REGZA-LINK Setup (see page 69).

**NOTE:**

- Even if the equipment is showing a menu, the television may automatically show the input source.
- This feature depends on the connected equipment and television state.

### REGZA-LINK system standby

If the television is turned off (standby mode), the television will send a message to turn off (standby mode) all of the REGZA-LINK devices connected to the television.

These functions can be enabled or disabled from the REGZA-LINK Setup (see page 69).

**NOTE:** This feature depends on the connected equipment and television state.

## Text services

This television has a multi-page text memory, which takes a few moments to load. It offers two **Modes** of viewing text – **Auto** will display **Fasttext**, if available. **List** will save your four favourite pages.

### Selecting modes

The text character set will be automatically chosen by the language setting in the **Setup** menu.

- 1 Press **MENU** / ◀▶ to highlight **Setup** icon.
- 2 Press ▲/◀▶ to highlight **Preferences** icon and press **OK**.
- 3 Press ▲ or ▼ to select **Teletext**, and then press ◀ or ▶ to select **Auto** or **List**.

Preferences	
3D Setup	
REGZA-LINK Setup	
Network Setup	
Guide Type	
Network Device Setup	
Teletext	◀ Auto ▶
Network Lock	Off
Panel Lock	Off

### Text information

#### The **TEXT** button:

To view text services press **TEXT**. Press again to superimpose the text over a normal broadcast picture and again to return to normal viewing. Channels cannot be changed until text is cancelled.

The first text page shown will be the *initial* page.

Any text page can be accessed by entering the 3 digit page number using the numbered buttons, pressing the coloured buttons or pressing **P**▲ to advance to the next page and **P**▼ to go back to the previous page.

#### Sub-pages

The pages on the screen will dynamically update as sub-pages are received.

If you open a page containing sub-pages, the sub-pages are automatically displayed in sequence. To quit automatic sub-page change, press ◀ or ▶.

Once selected, the sub-page you are viewing will be highlighted and, as the television loads any additional sub-pages, the colour of the numbers will change, indicating that these pages have been loaded.

These sub-pages will remain available to view until another page is chosen or, in normal TV mode, the channel is changed.

### Navigating pages using Auto

If **Fasttext** is available, four coloured titles will appear at the base of the screen.

To access one of the four given subjects, press the relevant coloured button on the remote control.

For further information on your particular text system(s), see the broadcast text index page or consult your local Toshiba dealer.

### Navigating pages using LIST

The four coloured choices at the bottom of the screen are numbers – 100, 101, 102 and 103, which have been programmed into the television's memory. To view these pages, press the relevant coloured buttons.

To change these saved pages, press the relevant coloured button and enter the 3 digit number. This number will change in the top left of the screen and in the coloured highlight.

Press **OK** to save. **Whenever OK is pressed, all four page numbers showing at the bottom will be saved and the previous ones will be lost.**

**NOTE:** The video signal from the external inputs (EXT-1 and EXT-2) is not saved.

If **OK** is not pressed, the selection will be forgotten when the channel is changed.

Other pages may be viewed by entering the 3 digit page number – but DO NOT press **OK** or these pages will be saved.

## Control buttons

Below is a guide to the functions of the remote control text buttons.

### **To display the index/initial page:**

Press  to access the index/initial page. The one displayed is dependant on the broadcaster.



### **TEXT To display a page of text:**

Press **TEXT** to display text. Press again to superimpose text over a normal picture. Press again to return to normal television viewing. Channels cannot be changed until this has been done.

### **To reveal concealed text:**

To discover the solutions on quiz and joke pages press the  button.



### **To hold a wanted page:**

At times it is convenient to hold a page of text. Press  and  will appear in the top left of the screen. The page will be held on screen until the button is pressed again.

### **To enlarge the text display size:**

Press  once to enlarge the top half of the page, press again to enlarge the bottom half of the page. Press again to revert to normal size.

### **To temporarily erase the text screen:**

Press   once to erase the text screen temporarily. To recall the text screen, press the button again.

*To display news flashes:*

Select the news flash page for the chosen text service (see the index page of text service). The news flashes will be displayed as and when they are broadcast.

 **Remember to cancel text before changing channels - press the TEXT button twice.**



## Questions and Answers

Below are the answers to some of the most common queries.

### **Q** Why is there no sound or picture?

**A** Check the television is not in standby mode. Check the mains plug and all mains connections.

### **Q** There is a picture, but why is there little or no colour?

**A** When using an **external** source, for instance, a poor quality video tape, if there is little or no colour, improvements may sometimes be achieved. The colour is factory set to **Auto** to automatically display the best colour system.

To check that you have the best colour:

- 1 With the external source playing, select **Colour System** from the **System Setup** menu.

System Setup	
Menu Language	English
Country	Germany
Colour System	Auto

- 2 With ◀ or ▶ choose between **Auto**, **PAL**, **SECAM**, **NTSC 4.43** or **NTSC 3.58**.

### **Q** Why doesn't the video/DVD being played show on screen?

**A** Make sure the media recorder or DVD player is connected to the television as shown on page 9, and then select the correct input by pressing .

### **Q** Why is there a picture but no sound?

**A** Check all lead connections.  
No sound or unacceptable format sound may be received.  
Check the volume has not been turned down or that sound mute has not been selected.  
Check shared audio settings.

### **Q** What else can cause a poor picture?

**A** Interference or a weak signal. Try a different television station. **Manual Fine Tuning** may help.

- 1 Select the **ATV Manual Tuning** menu. Highlight the station and press **OK**. Then press ▶ to select **Manual Fine Tuning**.

- 2 Using ▲ or ▼ adjust to get the best picture and sound. Press **OK** and then **EXIT**.

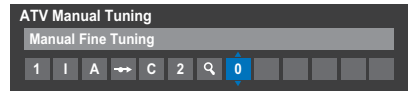

### **Q** Why don't the controls of the television work?

**A** Check that **Panel Lock** is not **ON**.

### **Q** Why doesn't the remote control work?

**A** Check that the batteries aren't dead or inserted incorrectly.

### **Q** Why is the digital channel locked?

**A** The channel has been locked in **Channel Options** (see 'Digital settings – Channel Options' section).

### **Q** Why are some of the digital subscription channels unavailable?

**A** Your subscription needs upgrading. Contact your service provider.

### **Q** Why is the soundtrack in English when a different audio language has been selected?

**A** The programme is currently being broadcast with an English soundtrack only.

### **Q** Why is there incorrect or no sound when in DTV mode?

**A** Press /I to ensure the hard of hearing option has not been selected.

**Q** *What is DVB-T?*

**A** Digital Video Broadcast via an aerial/antenna.

**Q** *What is DVB-C?*

**A** Digital Video Broadcast via a cable connection.

**Q** *How are DTV radio channels selected?*

**A** Select from All Channel List (**LIST** button).

**Q** *What can be done if the PIN number has been forgotten?*

**A** Use the Master PIN code of 1276, then change to a number of your choice. Select **Parental PIN Setup** from the **DTV Settings** menu to enter PIN. Ensure that no-one else can use the Master PIN by removing the Owner's Manual.

**Q** *Why are there vertical stripes on the screen when in PC mode?*

**A** The **Sampling Clock** may need adjustment. Select **PC Settings** from the **Display Settings** menu, highlight **Sampling Clock** and adjust until the lines clear.

**Q** *Why are there horizontal stripes and/or blurred images on the screen when in PC mode?*

**A** The **Clock Phase** may need adjustment. Select **PC Settings** from the **Display Settings** menu, highlight **Clock Phase** and adjust until the picture clears.

**Q** *Why when digital subtitles have been selected are they not showing on screen?*

**A** Subtitles are not currently being transmitted by the broadcaster.

**Q** *Why are there problems with analogue text?*

**A** Good performance of text depends on a good strong broadcast signal. This normally requires a roof or loft aerial. If the text is unreadable or garbled, check the aerial. Go to the *main index* page of the text service and look for the *User Guide*. This will explain the basic operation of text in some detail. If further information is needed on how to use text see the *text section*.

**Q** *Why is a page number visible at the top of the screen but no text?*

**A** Text has been selected but Teletext information is currently unavailable on the current source.

**Q** *Why are the colours wrong when an NTSC source is played?*

**A** Connect the source via a SCART lead and play. Select **Colour System** from the **Setup** menu.

**1** Set the Colour to **Auto** and exit.

**2** Go to the **Picture** menu and adjust the tint.

**Q** *Why don't the devices connected via HDMI operate properly?*

**A** Make sure to use cables with the HDMI logo  (see page 10).  
Some early HDMI equipment may not work properly with the latest HDMI TV products, due to new standard adoption.

**Q** *Why don't the REGZA-LINK devices work?*

**A** When the connected REGZA-LINK device does not work correctly after you have changed the settings of the device, turn off your television and unplug the power cord, and then plug and turn on again. Unplug the HDMI cable of the REGZA-LINK device and lead again.

**Q** *Why is the REGZA-LINK logo still showing when the equipment has been disconnected?*

**A** If the REGZA-LINK device is disconnected, the logo will disappear after approximately one minute.

**Q** *Why don't the networked devices work?*

**A** The LAN cables are not connected properly or at all. Connect all cables (see page 13).  
Make sure your network address is set up correctly (see page 45).

**Q** *Why doesn't the wireless network work?*

**A** Make sure the TOSHIBA Dual Band WLAN Adaptor is used (see page 13).  
Check that the AP is powered on.

**Q** *Why doesn't the Media Player feature operate?*

**A** Make sure that devices are connected correctly. Incorrect behaviour may occur with a USB Hub connection.  
Check your network setup if using DLNA CERTIFIED™ Server.

**Q** *Why are not 3D images displayed?*

**A** Ensure that there is no object blocking the infrared signals in the infrared reception part of television and 3D glasses.  
If the infrared data communication between the television and 3D glasses is lost for 5 minutes, the power of 3D glasses is turned off.

**Q** *What do the LEDs on the front of the television indicate?*

**A** Check the table below.

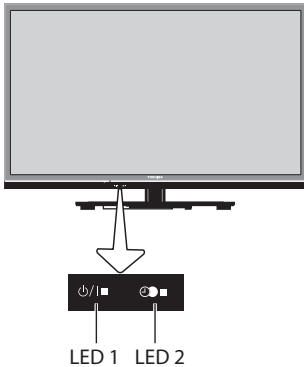

LED indication		Condition
LED-1	LED-2	
Green	Orange	Power ON Programme Timer is set
Green	OFF	Power ON Programme Timer is NOT set
Red	Orange	Power OFF (Standby) Programme Timer is set
Red	OFF	Power OFF (Standby) Programme Timer is NOT set
Orange	Green	For Service SW Upgrade in Progress
Red	OFF	For Service SW Upgrade Failed
Green	OFF	For Service SW Upgrade Successful

**Other problems**

If your TV's problem is not addressed in this Questions and Answers section or the recommended solution has not worked, do one of the following:

- 1 Turn off your TV. After 30 seconds, turn it on.
- 2 Turn off the TV and unplug the power cord. After 1 minute, plug the power cord in and turn on the TV.
- 3 Perform the **Reset TV** function in the **System Setup** menu.

## License Information

- 
 • **DOLBY DIGITAL PLUS PULSE** Manufactured under license from Dolby Laboratories. Dolby and the double-D symbol are trademarks of Dolby Laboratories
- 
 • **HDMI** HDMI, the HDMI logo, and High-Definition Multimedia Interface are trademarks or registered trademarks of HDMI Licensing, LLC.
- YouTube and the YouTube Logo are trademarks of Google Inc.
- This product contains Adobe® Flash® Player software under license from Adobe Systems Incorporated. Copyright © 1995-2009 Adobe Systems Incorporated. All rights reserved. Adobe and Flash are trademarks of Adobe Systems Incorporated.
- 
 • **DIVX+ HD** DivX®, DivX Certified®, DivX Plus® HD and associated logos are trademarks of Rovi Corporation or its subsidiaries and are used under license. Covered by one or more of the following U.S. patents: 7,295,673; 7,460,668; 7,515,710; 7,519,274
- This product contains technology subject to certain intellectual property rights of Microsoft. Use or distribution of this technology outside of this product is prohibited without the appropriate license(s) from Microsoft.
- This product includes technology owned by Microsoft Corporation and can not be used or distributed without a license from Microsoft Licensing, GP.
- Content owners use Windows Media digital rights management technology (WMDRM) to protect their intellectual property, including copyrights. This device uses WMDRM software to access WMDRM-protected content. If the WMDRM software fails to protect the content, content owners may ask Microsoft to revoke the software's ability to use WMDRM to play or copy protected content. Revocation does not affect unprotected content. When you download licenses for protected content, you agree that Microsoft may include a revocation list with the licenses. Content owners may require you to upgrade WMDRM to access their content. If you decline an upgrade, you will not be able to access content that requires the upgrade.
- DLNA™, DLNA CERTIFIED™, DLNA CERTIFIED Logo are trademarks, service marks, or certification marks of the Digital Living Network Alliance.
- 
 • **rovi guide** Rovi and Rovi Guide are trademarks of Rovi Corporation and/or its subsidiaries. The Rovi Guide system is manufactured under license from Rovi Corporation and/or its subsidiaries.
- DVB is a registered trademark of the DVB Project.
- THIS PRODUCT IS LICENSED UNDER THE AVC PATENT PORTFOLIO LICENSE FOR THE PERSONAL AND NONCOMMERCIAL USE OF A CONSUMER TO (i) ENCODE VIDEO IN COMPLIANCE WITH THE AVC STANDARD (AVC VIDEO) AND/OR (ii) DECODE AVC VIDEO THAT WAS ENCODED BY A CONSUMER ENGAGED IN A PERSONAL AND NONCOMMERCIAL ACTIVITY AND/OR WAS OBTAINED FROM A VIDEO PROVIDER LICENSED TO PROVIDE AVC VIDEO. NO LICENSE IS GRANTED OR SHALL BE IMPLIED FOR ANY OTHER USE. ADDITIONAL INFORMATION MAY BE OBTAINED FROM MPEG LA, L.L.C. SEE [HTTP://WWW.MPEGLA.COM](http://www.mpegla.com)
- THIS PRODUCT IS LICENSED UNDER THE MPEG-4 VISUAL PATENT PORTFOLIO LICENSE FOR THE PERSONAL AND NONCOMMERCIAL USE OF A CONSUMER FOR (i) ENCODING VIDEO IN COMPLIANCE WITH THE MPEG-4 VISUAL STANDARD ("MPEG-4 VIDEO") AND/OR (ii) DECODING MPEG-4 VIDEO THAT WAS ENCODED BY A CONSUMER ENGAGED IN A PERSONAL AND NON-COMMERCIAL ACTIVITY AND/OR WAS OBTAINED FROM A VIDEO PROVIDER LICENSED BY MPEG LA TO PROVIDE MPEG-4 VIDEO. NO LICENSE IS GRANTED OR SHALL BE IMPLIED FOR ANY OTHER USE. ADDITIONAL INFORMATION INCLUDING THAT RELATING TO PROMOTIONAL, INTERNAL AND COMMERCIAL USES AND LICENSING MAY BE OBTAINED FROM MPEG LA, L.L.C. SEE [HTTP://WWW.MPEGLA.COM](http://www.mpegla.com)
- MPEG Layer-3 audio coding technology licensed from Fraunhofer IIS and Thomson.
- Hybrid TV Standard is implemented according to ETSI TS 102 796 v1.1.1.

**Cleaning the screen and cabinet...**

Turn off the power, and clean the screen and cabinet with a soft, dry cloth. We recommend that you **do not** use any proprietary polishes or solvents on the screen or cabinet as this may cause damage.

**Disposal...**

The following information is only for EU-member states:

**Disposal of products**

The crossed out wheeled dust bin symbol indicates that products must be collected and disposed of separately from household waste. Integrated batteries and accumulators can be disposed of with the product. They will be separated at the recycling centres.

The black bar indicates that the product was placed on the market after August 13, 2005.

By participating in separate collection of products and batteries, you will help to assure the proper disposal of products and batteries and thus help to prevent potential negative consequences for the environment and human health.

For more detailed information about the collection and recycling programmes available in your country, please contact your local city office or the shop where you purchased the product.

**Disposal of batteries and/or accumulators**

The crossed out wheeled dust bin symbol indicates that batteries and/or accumulators must be collected and disposed of separately from household waste.

If the battery or accumulator contains more than the specified values of lead (Pb), mercury (Hg), and/or cadmium (Cd) defined in the Battery Directive (2006/66/EC), then the chemical symbols for lead (Pb), mercury (Hg) and/or cadmium (Cd) will appear below the crossed out wheeled dust bin symbol.

By participating in separate collection of batteries, you will help to assure the proper disposal of products and batteries and thus help to prevent potential negative consequences for the environment and human health.

For more detailed information about the collection and recycling programmes available in your country, please contact your local city office or the shop where you purchased the product.



## Information

**Before connecting any external equipment, turn off all main power switches. If there is no switch, remove the mains plug from the wall socket.**

### Signal information for Mini D-sub 15 pin connector

Pin No.	Signal name	Pin No.	Signal name	Pin No.	Signal name
1	R	6	Ground	11	NC
2	G	7	Ground	12	DDC Data
3	B	8	Ground	13	H-sync
4	NC*	9	+5V	14	V-sync
5	Ground	10	Ground	15	DDC Clock

\* NC = not connected

### Acceptable PC signals through the PC terminal

The PC input on this TV only accepts signal formats which are compliant with VESA-DMT as shown in the table below. Since some PCs input signals which are different from the resolution and frequency described in the table below, the following phenomenon may occur; incorrect display, false format detection, picture position failure, blur, or judder. In this case, set the monitor output format on your PC to conform to a signal in the table below.

Format	Resolution	V. Frequency	H. Frequency	Pixel Clock Frequency	VESA Standard (DMT)
VGA	640 × 480	59.940Hz	31.469kHz	25.175MHz	●
		72.809Hz	37.861kHz	31.500MHz	●
		75.000Hz	37.500kHz	31.500MHz	●
SVGA	800 × 600	56.250Hz	35.156kHz	36.000MHz	●
		60.317Hz	37.879kHz	40.000MHz	●
		72.188Hz	48.077kHz	50.000MHz	●
		75.000Hz	46.875kHz	49.500MHz	●
XGA	1024 × 768	60.004Hz	48.363kHz	65.000MHz	●
		70.069Hz	56.476kHz	75.000MHz	●
		75.029Hz	60.023kHz	78.750MHz	●
WXGA	1280 × 768	59.995Hz	47.396kHz	68.250MHz	●
		59.870Hz	47.776kHz	79.500MHz	●
		74.893Hz	60.289kHz	102.250MHz	●
	1280 × 800	59.810Hz	49.702kHz	83.500MHz	
	1360 × 768	60.015Hz	47.712kHz	85.500MHz	●
WXGA+	1440 × 900	59.887Hz	55.935kHz	106.50MHz	
SXGA	1280 × 1024	60.020Hz	63.981kHz	108.000MHz	●
		75.025Hz	79.976kHz	135.000MHz	●
1080p	1920 × 1080p	60.000Hz	67.500Hz	148.500MHz	

## Acceptable video or PC signals through the HDMI terminals

The HDMI inputs on this TV only accept VGA, SVGA, XGA, WXGA, and SXGA signal formats which are compliant with VESA as shown in the table below. Since some PCs and HDMI or DVI devices input signals which are different from the resolution and frequency described in the table below, the following phenomenon may occur; incorrect display, false format detection, picture position failure, blur, or judder. In this case, set the monitor output format on your PC, HDMI or DVI device to conform to a signal in the table below.

Format	Resolution	V. Frequency	H. Frequency	Pixel Clock Frequency	VESA Standard
480i	720 × 480i	59.940/60.000Hz	15.734/15.750kHz	27.000/27.027MHz	
576i	720 × 576i	50.000Hz	15.625kHz	27.000MHz	
480p	720 × 480p	59.940/60.000Hz	31.469/31.500kHz	27.000/27.027MHz	
576p	720 × 576p	50.000Hz	31.250kHz	27.000MHz	
1080i	1920 × 1080i	59.940/60.000Hz	33.716/33.750kHz	74.176/74.250MHz	
1080i	1920 × 1080i	50.000Hz	28.125kHz	74.250MHz	
720p	1280 × 720p	59.940/60.000Hz	44.955/45.000kHz	74.176/74.250MHz	
720p	1280 × 720p	50.000Hz	37.500kHz	74.250MHz	
1080p	1920 × 1080p	59.940/60.000Hz	67.433/67.500kHz	148.352/148.500MHz	
1080p	1920 × 1080p	50.000Hz	56.250kHz	148.500MHz	
1080p	1920 × 1080p	24.000Hz	27.000kHz	74.250MHz	
VGA	640 × 480	59.940/60.000Hz	31.469/31.500kHz	25.175/25.200MHz	●
		72.809Hz	37.861kHz	31.500MHz	●
		75.000Hz	37.500kHz	31.500MHz	●
SVGA	800 × 600	56.250Hz	35.156kHz	36.000MHz	●
		60.317Hz	37.879kHz	40.000MHz	●
		72.188Hz	48.077kHz	50.000MHz	●
		75.000Hz	46.875kHz	49.500MHz	●
XGA	1024 × 768	60.004Hz	48.363kHz	65.000MHz	●
		70.069Hz	56.476kHz	75.000MHz	●
		75.029Hz	60.023kHz	78.750MHz	●
WXGA	1280 × 768	59.995Hz	47.396kHz	68.250MHz	●
		59.870Hz	47.776kHz	79.500MHz	●
		74.893Hz	60.289kHz	102.250MHz	●
	1360 × 768	60.015Hz	47.712kHz	85.500MHz	●
SXGA	1280 × 1024	60.020Hz	63.981kHz	108.000MHz	●
		75.025Hz	79.976kHz	135.000MHz	●

Media Player Supported Format

Media Player	Media Format	File Extention	Video codec	Audio codec	USB	DMS	Note
Photo	JPEG	.jpg .jpeg	JPEG	-	yes	yes	<USB> Data compatibility: JPEG Exif ver 2.2 Maximum viewable resolution: -JPEG 15360 × 8640 (Base-line) 1024 × 768 (Progressive) -BMP 9600 × 6400 Maximum number of files: 1000 / folder <DMS> Maximum viewable resolution: 1024 × 768 Maximum number of files: 1000/folder *) Some files may not be played depending on file size.
	MPO	.mpo	MPO	-	yes	no	
	BMP	.bmp	BMP	-	yes	no	
Movie	AVI	.avi	MPEG-2 MPEG-4 part2 H.264 (MPEG-4 AVC) DivX Xvid	MPEG-1/2 Layer2 MPEG-1/2 Layer3 Dolby Digital (AC-3) L-PCM ADPCM MPEG-2/4 LC AAC MPEG-4 HE-AAC	yes	no	<USB> Maximum number of files: 1000 / folder Maximum viewable resolution: -Motion-JPEG:640 × 480 -Other:1920 × 1080 *) Some files may not be played.
	MPEG-2 PS	.mpg .mpeg	MPEG-1 Video MPEG-2 Video	MPEG-1/2 Layer2 MPEG-1/2 Layer3 Dolby Digital (AC-3) L-PCM	yes	yes	
	MPEG-2 TS	.ts .trp .tp	MPEG-2 Video	MPEG-1/2 Layer2 MPEG-1/2 Layer3 Dolby Digital (AC-3) L-PCM	yes	yes	
			H.264(MPEG-4 AVC) VC-1(WMV9)	MPEG-4 LC AAC MPEG-4 HE-AAC		no	
	MPEG-2 VOB	.vob	MPEG-1 Video MPEG-2 Video	MPEG-1/2 Layer2 MPEG-1/2 Layer3 Dolby Digital (AC-3) L-PCM	yes	no	
	MOV	.mov	H.264 (MPEG-4 AVC) MPEG-4 part2	MPEG-1/2 Layer3 MPEG-2/4 LC AAC	yes	no	
	MP4	.mp4 .m4v	H.264 (MPEG-4 AVC) MPEG-4 part12,14	MPEG-4 HE-AAC	yes	no	
	ASF	.asf .wmv	VC-1 (WMV9)	WMA7/8/9 Std WMA9 Pro	yes	no	
	DivX	.divx .div	DivX 3,4,5,6	MPEG-1/2 Layer2 MPEG-1/2 Layer3 Dolby Digital (AC-3) PCM	yes	no	
	Xvid	.xvid	Xvid	ADPCM			



Media Player	Media Format	File Extension	Video codec	Audio codec	USB	DMS	Note
Movie	MKV	.mkv	MPEG-1 Video MPEG-2 Video MPEG-4 part2 H.264 (MPEG-4 AVC)	MPEG-1/2 Layer2 MPEG-1/2 Layer3 Dolby Digital (AC-3) L-PCM MPEG-2/4 LC AAC MPEG-4 HE-AAC	yes	no	
	RealMedia	.rm .rmvb	RealVideo 8,9,10	Dolby Digital (AC-3) MPEG-2/4 LC AAC	yes	no	
	Flash Video (FLV1)	.flv .swf	Sorenson H.263 (FLV1) H.264 (MPEG-4 AVC)	MPEG-1/2 Layer3 MPEG-2/4 LC AAC L-PCM ADPCM	yes	no	
	3GPP	.3gp	MPEG-4 part2 H.264 (MPEG-4 AVC)	MPEG-2/4 LC AAC AMR	yes	no	
	Motion JPEG	.avi .mp4 .mkv	JPEG	L-PCM ADPCM	yes	no	
Music	MP3	.mp3	-	MPEG-1/2 Layer-3	yes	yes	<USB> Maximum number of files: 1000 / folder
	MP4	.m4a	-	MPEG-2/4 LC AAC	yes	no	
	WMA	.wma	-	WMA7/8/9/ Std	yes	no	
			-	WMA9 Pro	yes	no	
	RealAudio	.ra .rm .rmvb	-	Dolby Digital (AC-3) MPEG-2/4 LC AAC	yes	yes	
	WAV	.wav	-	LPCM ADPCM MPEG-1/2 Layer-3 WMA7/8/9/ Std WMA9 Pro	yes	no	
LPCM		-		no	yes		

## 3D Support Format (HDMI)

Resolution	Aspect ratio	V.Frequency	H.Frequency	Pixel Clock Frequency	3D Structure
720 × 480p	16:9	59.940/60.000Hz	31.469/31.500kHz	27.000/27.027MHz	Side by Side (Full)
					Side by Side (Half)
					Top and Bottom
720 × 576p	16:9	50.000Hz	31.250kHz	27.000MHz	Side by Side (Full)
					Side by Side (Half)
					Top and Bottom
1280 × 720p	16:9	59.940/60.000Hz	90.0/89.91kHz	148.352/148.500MHz	Frame Packing
			44.955/45.000kHz	74.176/74.250MHz	Side by Side (Half)
			Top and Bottom		
		50.000Hz	75.000kHz	148.500MHz	Frame Packing
		37.500kHz	74.250MHz	Side by Side (Half)	
		Top and Bottom			
1920 × 1080i	16:9	59.940/60.000Hz	33.716/33.750kHz	74.176/74.250MHz	Side by Side (Half)
		Top and Bottom			
		50.000Hz	28.125kHz	74.250MHz	Side by Side (Half)
Top and Bottom					
1920 × 1080p	16:9	24.000Hz	54.000kHz	148.500MHz	Frame Packing
			27.000kHz	74.250MHz	Side by Side (Half)
		Top and Bottom			
		30.000Hz	67.433/67.500kHz	148.352/148.500MHz	Frame Packing
			33.716/33.750kHz	74.176/74.250MHz	Side by Side (Half)
		Top and Bottom			
		50.000Hz	56.250kHz	148.500MHz	Side by Side (Half)
		Top and Bottom			
59.940/60.000Hz	67.433/67.500kHz	148.352/148.500MHz	Side by Side (Half)		
Top and Bottom					

### 3D Support Format (DTV)

Video Format	Aspect ratio	V.Frequency	3D Structure
480i, 480p	16:9	59.940/60.000Hz	Side by Side (Half)
			Top and Bottom
576i, 576p	16:9	50.000Hz	Side by Side (Half)
			Top and Bottom
720p	16:9	59.940/60.000Hz	Side by Side (Half)
			Top and Bottom
		50.000Hz	Side by Side (Half)
			Top and Bottom
1080i	16:9	59.940/60.000Hz	Side by Side (Half)
			Top and Bottom
		50.000Hz	Side by Side (Half)
			Top and Bottom
1080p	16:9	24.000Hz	Side by Side (Half)
			Top and Bottom
		30.000Hz	Side by Side (Half)
			Top and Bottom
		50.000Hz	Side by Side (Half)
			Top and Bottom
		59.940/60.000Hz	Side by Side (Half)
			Top and Bottom

\* Side by Side (Full) is composed of left and right stereoscopic pictures that each size is equal to 2D.

Side by Side (Full)

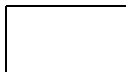

2D Video

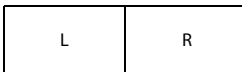

3D Video

Side by Side (Half)

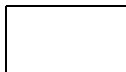

2D Video

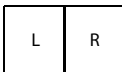

3D Video

# Specifications and accessories

## Receiving systems

DVB-T Broadcast systems/channels		Broadcast systems/channels	
UK	UHF 21-68	PAL-I	UHF UK21-UK69
France	VHF 05-10 (VHF 01-05) UHF 21-69	PAL-B/G	UHF E21-E69 VHF E2-E12, S1-S41
Germany	VHF 05-12 UHF 21-69	SECAM-L	UHF F21-F69 VHF F1-F10, B-Q
Austria	VHF 05-12 UHF 21-69	SECAM-D/K	UHF R21-R69 VHF R1-R12
Switzerland	VHF 05-12 UHF 21-69		
Italy	VHF 05-12 (D,E,F,G,H,H1,H2) UHF 21-69		
Spain	UHF 21-69		
Nederlands	VHF 05-12 UHF 21-69		
Greece	VHF 05-12 UHF 21-69		

## DVB-C Broadcast systems

## DVB-S/DVB-S2 Broadcast systems

**Video Input** PAL, SECAM, NTSC 3.58/4.43

## External connections

EXT 1	Input/Output	21-pin SCART	RGB, A/V input AV out, TV out
EXT 2	Input	RCA jacks RCA jack RCA jacks	Y, P <sub>B</sub> /C <sub>B</sub> , P <sub>R</sub> /C <sub>R</sub> Video (Y is shared) Audio L + R (shared)
HDMI 1/2/3/4	Input	HDMI* compliant HDCP compliant	
PC	Input	Mini D-sub 15-pin Analogue	
Digital Audio Output (S/PDIF)	Optical		
LAN port	RJ-45		
USB 1/USB 2 port	Media Player		
	Interface version: USB 2.0		
	USB class: Mass Storage		
	File system: FAT16 and FAT32		
	Maximum output: 500mA (specified to change the 3D glasses FPT-AG02G)		
USB 2 port	Wireless LAN adaptor ready for a home network, IEEE802.11a/b/g/n compatible		
Headphone socket	3.5mm stereo		
<b>Stereo</b>	A2, Nicam 2 carrier system		
<b>Visible Screen Size</b> (approx.)	32 40 46	80cm 102cm 117cm	
<b>Display</b>	16:9		
<b>Sound output</b> (at 10% distortion)	Main:	10W + 10W	

<b>Power consumption</b> (approx.)	32TL/32UL	98W
	40TL/40UL	122W
	46TL/46UL	145W

<b>Standby power consumption</b> (approx.)	0.3W
---	------

<b>Energy Efficiency Class</b>	32TL/32UL	A
	40TL/40UL	A+
	46TL/46UL	A+

<b>On-mode power consumption*</b> (approx.)	32TL/32UL	44.7W
	40TL/40UL	51.6W
	46TL/46UL	66.3W

<b>Average annual energy consumption**</b> (approx.)	32TL/32UL	65.3kWh/y
	40TL/40UL	75.3kWh/y
	46TL/46UL	96.8kWh/y

\* Tested in accordance with IEC 62087-BD Ed. 2.0:2008 in default settings.

\*\* Operating 4 hours a day and 365 days a year.

<b>Dimensions</b> (approx.)	32TL/32UL	51 cm (H)	74cm (W)	22cm (D)
	40TL/40UL	61 cm (H)	92cm (W)	22cm (D)
	46TL/46UL	69 cm (H)	106cm (W)	24cm (D)

(Height dimension includes foot stand)

<b>Weight</b> (approx.)	32TL/32UL	10.0kg
	40TL/40UL	14.5kg
	46TL/46UL	18.5kg

<b>Operating condition</b>	Temperature 5°C - 35°C (41°F - 94°F) Humidity 20 - 80% (non-condensing)
----------------------------	--

- Supplied accessories**
- Remote control CT-90405
  - 2 batteries (AA, IEC R6 1.5V)
  - Toshiba 3D glasses : FPT-AG02G (for UL97 series)
  - 'P' Clip/Screw (for TV mounting)  
See page 5.
  - 4 spacers for wall mounting

- Optional accessories**
- Toshiba 3D glasses : FPT-AG02G (for TL96 series)
  - TOSHIBA Dual Band WLAN Adaptor WLM-20U2

Specification is subject to change without notice.

© TOSHIBA Television Central Europe Sp. z o.o.

All rights reserved.

Reproduction in whole or part without written permission is strictly prohibited.

**TOSHIBA Television Central Europe Sp. z o.o.**

ul. Pokoju 1, Biskupice Podgórne, 55-040 Kobierzyce, Poland