

# DENON

**NETWORK AUDIO PLAYER**

# DNP-720AE

---

**Owner's Manual**

**Bedienungsanleitung**

**Manuel de l'Utilisateur**

**Manuale delle istruzioni**

**Manual del usuario**

**Gebruiksaanwijzing**

**Bruksanvisning**



## SAFETY PRECAUTIONS



**CAUTION**  
**RISK OF ELECTRIC SHOCK**  
**DO NOT OPEN**



**CAUTION:**  
**TO REDUCE THE RISK OF ELECTRIC SHOCK, DO NOT REMOVE COVER (OR BACK). NO USER-SERVICEABLE PARTS INSIDE. REFER SERVICING TO QUALIFIED SERVICE PERSONNEL.**



The lightning flash with arrowhead symbol, within an equilateral triangle, is intended to alert the user to the presence of uninsulated "dangerous voltage" within the product's enclosure that may be of sufficient magnitude to constitute a risk of electric shock to persons.



The exclamation point within an equilateral triangle is intended to alert the user to the presence of important operating and maintenance (servicing) instructions in the literature accompanying the appliance.

**WARNING:**  
**TO REDUCE THE RISK OF FIRE OR ELECTRIC SHOCK, DO NOT EXPOSE THIS APPLIANCE TO RAIN OR MOISTURE.**

## IMPORTANT SAFETY INSTRUCTIONS

1. Read these instructions.
2. Keep these instructions.
3. Heed all warnings.
4. Follow all instructions.
5. Do not use this apparatus near water.
6. Clean only with dry cloth.
7. Do not block any ventilation openings. Install in accordance with the manufacturer's instructions.
8. Do not install near any heat sources such as radiators, heat registers, stoves, or other apparatus (including amplifiers) that produce heat.
9. Protect the power cord from being walked on or pinched particularly at plugs, convenience receptacles, and the point where they exit from the apparatus.
10. Only use attachments/accessories specified by the manufacturer.
11. Use only with the cart, stand, tripod, bracket, or table specified by the manufacturer, or sold with the apparatus. When a cart is used, use caution when moving the cart/apparatus combination to avoid injury from tip-over.
12. Unplug this apparatus during lightning storms or when unused for long periods of time.
13. Refer all servicing to qualified service personnel. Servicing is required when the apparatus has been damaged in any way, such as power-supply cord or plug is damaged, liquid has been spilled or objects have fallen into the apparatus, the apparatus has been exposed to rain or moisture, does not operate normally, or has been dropped.
14. Batteries shall not be exposed to excessive heat such as sunshine, fire or the like.



**CE 2200**

**R&TTE Directive 1999/5/EC**

This product may be operated in the following countries;

AT	BE	CZ	DK	FI
FR	DE	GR	HU	IE
IT	NL	PL	PT	SK
ES	SE	GB	NO	CH

Indoor use only.

### CAUTION:

To completely disconnect this product from the mains, disconnect the plug from the wall socket outlet.

The mains plug is used to completely interrupt the power supply to the unit and must be within easy access by the user.

### VORSICHT:

Um dieses Gerät vollständig von der Stromversorgung abzutrennen, ziehen Sie bitte den Stecker aus der Wandsteckdose.

Der Netzstecker wird verwendet, um die Stromversorgung zum Gerät völlig zu unterbrechen; er muss für den Benutzer gut und einfach zu erreichen sein.

### PRECAUTION:

Pour déconnecter complètement ce produit du courant secteur, débranchez la prise de la prise murale.

La prise secteur est utilisée pour couper complètement l'alimentation de l'appareil et l'utilisateur doit pouvoir y accéder facilement.

### ATTENZIONE:

Per scollegare completamente questo prodotto dalla rete di alimentazione elettrica, scollegare la spina dalla relativa presa a muro.

La spina di rete viene utilizzata per interrompere completamente l'alimentazione all'unità e deve essere facilmente accessibile all'utente.

### PRECAUCIÓN:

Para desconectar completamente este producto de la alimentación eléctrica, desconecte el enchufe del enchufe de la pared.

El enchufe de la alimentación eléctrica se utiliza para interrumpir por completo el suministro de alimentación eléctrica a la unidad y debe encontrarse en un lugar al que el usuario tenga fácil acceso.

### WAARSCHUWING:

Om de voeding van dit product volledig te onderbreken moet de stekker uit het stopcontact worden getrokken.

De netstekker wordt gebruikt om de stroomtoevoer naar het toestel volledig te onderbreken en moet voor de gebruiker gemakkelijk bereikbaar zijn.

### FÖRSIKTIGHETSMÅTT:

Koppla loss stickproppen från eluttaget för att helt skilja produkten från nätet.

Stickproppen används för att helt bryta strömförsörjningen till apparaten, och den måste vara lättillgänglig för användaren.

□ NOTE ON USE / HINWEISE ZUM GEBRAUCH / OBSERVATIONS RELATIVES A L'UTILISATION / NOTE SULL'USO / NOTAS SOBRE EL USO / ALVORENSTE GEBRUIKEN / OBSERVERA ANGÅENDE ANVÄNDNINGEN

WARNINGS	WARNHINWEISE	AVERTISSEMENTS	AVVERTENZE	ADVERTENCIAS	WAARSCHUWINGEN	VARNINGAR
<ul style="list-style-type: none"> <li>• Avoid high temperatures. Allow for sufficient heat dispersion when installed in a rack.</li> <li>• Handle the power cord carefully. Hold the plug when unplugging the cord.</li> <li>• Keep the unit free from moisture, water, and dust.</li> <li>• Unplug the power cord when not using the unit for long periods of time.</li> <li>• Do not obstruct the ventilation holes.</li> <li>• Do not let foreign objects into the unit.</li> <li>• Do not let insecticides, benzene, and thinner come in contact with the unit.</li> <li>• Never disassemble or modify the unit in any way.</li> <li>• Ventilation should not be impeded by covering the ventilation openings with items, such as newspapers, tablecloths or curtains.</li> <li>• Naked flame sources such as lighted candles should not be placed on the unit.</li> <li>• Observe and follow local regulations regarding battery disposal.</li> <li>• Do not expose the unit to dripping or splashing fluids.</li> <li>• Do not place objects filled with liquids, such as vases, on the unit.</li> <li>• Do not handle the mains cord with wet hands.</li> <li>• When the switch is in the OFF (STANDBY) position, the equipment is not completely switched off from MAINS.</li> <li>• The equipment shall be installed near the power supply so that the power supply is easily accessible.</li> </ul>	<ul style="list-style-type: none"> <li>• Vermeiden Sie hohe Temperaturen. Beachten Sie, dass eine ausreichende Belüftung gewährleistet wird, wenn das Gerät auf ein Regal gestellt wird.</li> <li>• Gehen Sie vorsichtig mit dem Netzkabel um. Halten Sie das Kabel am Stecker, wenn Sie den Stecker herausziehen.</li> <li>• Halten Sie das Gerät von Feuchtigkeit, Wasser und Staub fern.</li> <li>• Wenn das Gerät längere Zeit nicht verwendet werden soll, trennen Sie das Netzkabel vom Netzstecker.</li> <li>• Decken Sie den Lüftungsbereich nicht ab.</li> <li>• Lassen Sie keine fremden Gegenstände in das Gerät kommen.</li> <li>• Lassen Sie das Gerät nicht mit Insektiziden, Benzin oder Verdünnungsmitteln in Berührung kommen.</li> <li>• Versuchen Sie niemals das Gerät auseinander zu nehmen oder zu verändern.</li> <li>• Die Belüftung sollte auf keinen Fall durch das Abdecken der Belüftungsöffnungen durch Gegenstände wie beispielsweise Zeitungen, Tischtücher, Vorhänge o. Ä. behindert werden.</li> <li>• Auf dem Gerät sollten keinerlei direkte Feuerquellen wie beispielsweise angezündete Kerzen aufgestellt werden.</li> <li>• Bitte beachten Sie bei der Entsorgung der Batterien die örtlich geltenden Umweltbestimmungen.</li> <li>• Das Gerät sollte keiner tropfenden oder spritzenden Flüssigkeit ausgesetzt werden.</li> <li>• Auf dem Gerät sollten keine mit Flüssigkeit gefüllten Behälter wie beispielsweise Vasen aufgestellt werden.</li> <li>• Das Netzkabel nicht mit feuchten oder nassen Händen anfassen.</li> <li>• Wenn der Schalter ausgeschaltet ist (OFF (STANDBY)-Position), ist das Gerät nicht vollständig vom Stromnetz (MAINS) abgetrennt.</li> <li>• Das Gerät sollte in der Nähe einer Netzsteckdose aufgestellt werden, damit es leicht an das Stromnetz angeschlossen werden kann.</li> </ul>	<ul style="list-style-type: none"> <li>• Eviter des températures élevées. Tenir compte d'une dispersion de chaleur suffisante lors de l'installation sur une étagère.</li> <li>• Manipuler le cordon d'alimentation avec précaution. Tenir la prise lors du débrancher le cordon.</li> <li>• Protéger l'appareil contre l'humidité, l'eau et la poussière.</li> <li>• Débrancher le cordon d'alimentation lorsque l'appareil n'est pas utilisé pendant de longues périodes.</li> <li>• Ne pas obstruer les trous d'aération.</li> <li>• Ne pas laisser des objets étrangers dans l'appareil.</li> <li>• Ne pas mettre en contact des insecticides, du benzène et un diluant avec l'appareil.</li> <li>• Ne jamais démonter ou modifier l'appareil d'une manière ou d'une autre.</li> <li>• Ne pas recouvrir les orifices de ventilation avec des objets tels que des journaux, nappes ou rideaux. Cela entraverait la ventilation.</li> <li>• Ne jamais placer de flamme nue sur l'appareil, notamment des bougies allumées.</li> <li>• Veillez à respecter les lois en vigueur lorsque vous jetez les piles usagées.</li> <li>• L'appareil ne doit pas être exposé à l'eau ou à l'humidité.</li> <li>• Ne pas poser d'objet contenant du liquide, par exemple un vase, sur l'appareil.</li> <li>• Ne pas manipuler le cordon d'alimentation avec les mains mouillées.</li> <li>• Lorsque l'interrupteur est sur la position OFF (STANDBY), l'appareil n'est pas complètement déconnecté du SECTEUR (MAINS).</li> <li>• L'appareil sera installé près de la source d'alimentation, de sorte que cette dernière soit facilement accessible.</li> </ul>	<ul style="list-style-type: none"> <li>• Evitate di esporre l'unità a temperature elevate. Assicuratevi che vi sia un'adeguata dispersione del calore quando installate l'unità in un mobile per componenti audio.</li> <li>• Maneggiate il cavo di alimentazione con attenzione. Tenete ferma la spina quando scollegate il cavo dalla presa.</li> <li>• Tenete l'unità lontana dall'umidità, dall'acqua e dalla polvere.</li> <li>• Scollegate il cavo di alimentazione quando prevedete di non utilizzare l'unità per un lungo periodo di tempo.</li> <li>• Non coprite i fori di ventilazione.</li> <li>• Non inserite corpi estranei all'interno dell'unità.</li> <li>• Assicuratevi che l'unità non entri in contatto con insetticidi, benzolo o solventi.</li> <li>• Non smontate né modificate l'unità in alcun modo.</li> <li>• Le aperture di ventilazione non devono essere ostruite coprendole con oggetti, quali giornali, tovaglie, tende e così via.</li> <li>• Non posizionate sull'unità fiamme libere, come ad esempio candele accese.</li> <li>• Prestate attenzione agli aspetti legati alla tutela dell'ambiente nello smaltimento delle batterie.</li> <li>• L'apparecchiatura non deve essere esposta a goccioli o spruzzi.</li> <li>• Non posizionate sull'unità alcun oggetto contenente liquidi, come ad esempio i vasi.</li> <li>• Non toccare il cavo di alimentazione con le mani bagnate.</li> <li>• Quando l'interruttore è nella posizione OFF (STANDBY), l'apparecchiatura non è completamente scollegata da MAINS.</li> <li>• L'apparecchio va installato in prossimità della fonte di alimentazione, in modo che quest'ultima sia facilmente accessibile.</li> </ul>	<ul style="list-style-type: none"> <li>• Evite altas temperaturas. Permita la suficiente dispersión del calor cuando está instalado en la consola.</li> <li>• Maneje el cordón de energía con cuidado. Sostenga el enchufe cuando desconecte el cordón de energía.</li> <li>• Mantenga el equipo libre de humedad, agua y polvo.</li> <li>• Desconecte el cordón de energía cuando no utilice el equipo por mucho tiempo.</li> <li>• No obstruya los orificios de ventilación.</li> <li>• No deje objetos extraños dentro del equipo.</li> <li>• No permita el contacto de insecticidas, gasolina y diluyentes con el equipo.</li> <li>• Nunca desarme o modifique el equipo de ninguna manera.</li> <li>• La ventilación no debe quedar obstruida por haberse cubierto las aperturas con objetos como periódicos, manteles o cortinas.</li> <li>• No deberán colocarse sobre el aparato fuentes inflamables sin protección, como velas encendidas.</li> <li>• A la hora de deshacerse de las pilas, respete la normativa para el cuidado del medio ambiente.</li> <li>• No exponer el aparato al goteo o salpicaduras cuando se utilice.</li> <li>• No colocar sobre el aparato objetos llenos de líquido, como jarras.</li> <li>• No maneje el cable de alimentación con las manos mojadas.</li> <li>• Cuando el interruptor está en la posición OFF (STANDBY), el equipo no está completamente desconectado de la alimentación MAINS.</li> <li>• El equipo se instalará cerca de la fuente de alimentación de manera que resulte fácil acceder a ella.</li> </ul>	<ul style="list-style-type: none"> <li>• Vermijd hoge temperaturen. Zorg er bij installatie in een audiorack voor, dat de door het toestel geproduceerde warmte goed kan worden afgevoerd.</li> <li>• Hanteer het netsnoer voorzichtig. Houd het snoer bij de stekker vast wanneer deze moet worden aan- of losgekoppeld.</li> <li>• Laat geen vochtigheid, water of stof in het apparaat binnendringen.</li> <li>• Neem altijd het netsnoer uit het stopcontact wanneer het apparaat gedurende een lange periode niet wordt gebruikt.</li> <li>• De ventilatieopeningen mogen niet worden geblokkeerd.</li> <li>• Laat geen vreemde voorwerpen in dit apparaat vallen.</li> <li>• Voorkom dat insecticiden, benzene of verfvendunners met dit toestel in contact komen.</li> <li>• Dit toestel mag niet gedemonteerd of aangepast worden.</li> <li>• De ventilatie mag niet worden belemmerd door de ventilatieopeningen af te dekken met bijvoorbeeld kranten, een tafelkleed of gordijnen.</li> <li>• Plaats geen open vlammen, bijvoorbeeld een brandende kaars, op het apparaat.</li> <li>• Houd u steeds aan de milieuvoorschriften wanneer u gebruikte batterijen wegdoet.</li> <li>• Stel het apparaat niet bloot aan druppels of spatten.</li> <li>• Plaats geen voorwerpen gevuld met water, bijvoorbeeld een vaas, op het apparaat.</li> <li>• Raak het netsnoer niet met natte handen aan.</li> <li>• Als de schakelaar op OFF (STANDBY) staat, is het apparaat niet volledig losgekoppeld van de netspanning (MAINS).</li> <li>• De apparatuur wordt in de buurt van het stopcontact geïnstalleerd, zodat dit altijd gemakkelijk toegankelijk is.</li> </ul>	<ul style="list-style-type: none"> <li>• Undvik höga temperaturer. Se till att det finns möjlighet till god värmeavledning vid montering i ett rack.</li> <li>• Hantera nätkabeln varsamt. Håll i kabeln när den kopplas från el-uttaget.</li> <li>• Utsätt inte apparaten för fukt, vatten och damm.</li> <li>• Koppla loss nätkabeln om apparaten inte kommer att användas i lång tid.</li> <li>• Täpp inte till ventilationsöppningarna.</li> <li>• Se till att främmande föremål inte tränger in i apparaten.</li> <li>• Se till att inte insektsmedel på spraybruk, bensen och thinner kommer i kontakt med apparatens hölje.</li> <li>• Ta inte isär apparaten och försök inte bygga om den.</li> <li>• Ventilationen bör inte förhindras genom att täcka för ventilationsöppningarna med föremål såsom tidningar, bordsdukar eller gardiner.</li> <li>• Placera inte öppen eld, t.ex. tända ljus, på apparaten.</li> <li>• Tänk på miljöaspekterna när du bortskaffar batterier.</li> <li>• Apparaten får inte utsättas för vätska.</li> <li>• Placera inte föremål fyllda med vätska, t.ex. vaser, på apparaten.</li> <li>• Hantera inte nätsladden med våta händer.</li> <li>• Även om strömbrytaren står i det avstängda läget OFF (STANDBY), så är utrustningen inte helt bortkopplad från det elektriska nätet (MAINS).</li> <li>• Utrustningen ska vara installerad nära strömuttaget så att strömförsörjningen är lätt att tillgå.</li> </ul>

#### • DECLARATION OF CONFORMITY

We declare under our sole responsibility that this product, to which this declaration relates, is in conformity with the following standards:

EN60065, EN55013, EN55020, EN61000-3-2, EN61000-3-3, EN300328, EN301489-01, EN301489-17 and EN50385. Following the provisions of Low Voltage Directive 2006/95/EC and EMC Directive 2004/108/EC, the EC regulation 1275/2008 and its frame work Directive 2009/125/EC for Energy-related Products (ErP).

#### • ÜBEREINSTIMMUNGSERKLÄRUNG

Wir erklären unter unserer Verantwortung, daß dieses Produkt, auf das sich diese Erklärung bezieht, den folgenden Standards entspricht:

EN60065, EN55013, EN55020, EN61000-3-2, EN61000-3-3, EN300328, EN301489-01, EN301489-17 und EN50385. Following the provisions of low voltage directive 2006/95/EC and EMC directive 2004/108/EC, the EC regulation 1275/2008 and its frame work directive 2009/125/EC for energy-related products (ErP).

#### • DECLARATION DE CONFORMITE

Nous déclarons sous notre seule responsabilité que l'appareil, auquel se réfère cette déclaration, est conforme aux standards suivants:

EN60065, EN55013, EN55020, EN61000-3-2, EN61000-3-3, EN300328, EN301489-01, EN301489-17 et EN50385. Selon la directive 2006/95/EC concernant la basse tension et la directive CEM 2004/108/EC, la réglementation européenne 1275/2008 et la directive 2009/125/EC établissant un cadre de travail applicable aux produits liés à l'énergie (ErP).

#### • DICHIARAZIONE DI CONFORMITÀ

Dichiaro con piena responsabilità che questo prodotto, al quale la nostra dichiarazione si riferisce, è conforme alle seguenti normative:

EN60065, EN55013, EN55020, EN61000-3-2, EN61000-3-3, EN300328, EN301489-01, EN301489-17 e EN50385. Facendo seguito alle disposizioni della direttiva sul basso voltaggio 2006/95/EC alla direttiva EMC 2004/108/EC, alla norma EC 1275/2008 e alla relativa legge quadro 2009/125/EC in materia di prodotti alimentati ad energia (ErP). QUESTO PRODOTTO È CONFORME AL D.M. 28/08/95 N. 548

#### • DECLARACIÓN DE CONFORMIDAD

Declaro bajo nuestra exclusiva responsabilidad que este producto al que hace referencia esta declaración, está conforme con los siguientes estándares:

EN60065, EN55013, EN55020, EN61000-3-2, EN61000-3-3, EN300328, EN301489-01, EN301489-17 y EN50385. De acuerdo con la directiva sobre baja tensión 2006/95/CE y la directiva sobre CEM 2004/108/CE, la normativa CE 1275/2008 y su directiva marco 2009/125/EC para productos relacionados con la energía (ErP).

#### • EENVORMIGHEIDSVKLAARING

Wij verklaren uitsluitend op onze verantwoordelijkheid dat dit produkt, waarop deze verklaring betrekking heeft, in overeenstemming is met de volgende normen:

EN60065, EN55013, EN55020, EN61000-3-2, EN61000-3-3, EN300328, EN301489-01, EN301489-17 en EN50385. Volgens de voorziendingen van lage spanningsrichtlijn 2006/95/EC en EMC-richtlijn 2004/108/EC, de EU-richtlijn 1275/2008 en de kaderrichtlijn 2009/125/EC voor energieverbruikende producten (ErP).

#### • ÖVERENSSTÄMMELSESINTYG

Härmed intygas helt på eget ansvar att denna produkt, vilken detta intyg avser, uppfyller följande standarder:

EN60065, EN55013, EN55020, EN61000-3-2, EN61000-3-3, EN300328, EN301489-01, EN301489-17 och EN50385. Uppfyller reglerna i lågspänningsdirektivet 2006/95/EC och EMC-direktivet 2004/108/EC, EU-förordningen 1275/2008 och ramverksdirektivet 2009/125/EC för energirelaterade produkter (ErP).

DENON EUROPE  
Division of D&M Germany GmbH  
An der Kleinbahn 18, Nettetal,  
D-41334 Germany

#### A NOTE ABOUT RECYCLING:

This product's packaging materials are recyclable and can be reused. Please dispose of any materials in accordance with the local recycling regulations.

When discarding the unit, comply with local rules or regulations.

Batteries should never be thrown away or incinerated but disposed of in accordance with the local regulations concerning battery disposal.

This product and the supplied accessories, excluding the batteries, constitute the applicable product according to the WEEE directive.

#### HINWEIS ZUM RECYCLING:

Das Verpackungsmaterial dieses Produktes ist zum Recyceln geeignet und kann wieder verwendet werden. Bitte entsorgen Sie alle Materialien entsprechend der örtlichen Recycling-Vorschriften.

Beachten Sie bei der Entsorgung des Gerätes die örtlichen Vorschriften und Bestimmungen.

Die Batterien dürfen nicht in den Hausmüll geworfen oder verbrannt werden; bitte entsorgen Sie die Batterien gemäß der örtlichen Vorschriften.

Dieses Produkt und das im Lieferumfang enthaltene Zubehör (mit Ausnahme der Batterien!) entsprechen der WEEE-Direktive.

#### UNE REMARQUE CONCERNANT LE RECYCLAGE:

Les matériaux d'emballage de ce produit sont recyclables et peuvent être réutilisés.

Veillez disposer des matériaux conformément aux lois sur le recyclage en vigueur.

Lorsque vous mettez cet appareil au rebut, respectez les lois ou réglementations en vigueur.

Les piles ne doivent jamais être jetées ou incinérées, mais mises au rebut conformément aux lois en vigueur sur la mise au rebut des piles.

Ce produit et les accessoires inclus, à l'exception des piles, sont des produits conformes à la directive DEEE.

#### NOTA RELATIVA AL RICICLAGGIO:

I materiali di imballaggio di questo prodotto sono riutilizzabili e riciclabili. Smaltire i materiali conformemente alle normative locali sul riciclaggio.

Per lo smaltimento dell'unità, osservare le normative o le leggi locali in vigore.

Non gettare le batterie, né incenerirle, ma smaltirle conformemente alla normativa locale sui rifiuti chimici.

Questo prodotto e gli accessori inclusi nell'imballaggio sono applicabili alla direttiva RAEE, ad eccezione delle batterie.

#### ACERCA DEL RECICLAJE:

Los materiales de embalaje de este producto son reciclables y se pueden volver a utilizar. Disponga de estos materiales siguiendo los reglamentos de reciclaje de su localidad.

Cuando se deshaga de la unidad, cumpla con las reglas o reglamentos locales.

Las pilas nunca deberán tirarse ni incinerarse. Deberá disponer de ellas siguiendo los reglamentos de su localidad relacionados con los desperdicios químicos.

Este producto junto con los accesorios empaquetados es el producto aplicable a la directiva RAEE excepto pilas.

#### EEN AANTEKENING MET BETREKKING TOT DE RECYCLING:

Het inpakmateriaal van dit product is recycleerbaar en kan opnieuw gebruikt worden. Er wordt verzocht om zich van elk afvalmateriaal te ontdoen volgens de plaatselijke voorschriften.

Volg voor het wegdoen van de speler de voorschriften voor de verwijdering van wit- en bruingoed op.

Batterijen mogen nooit worden weggegooid of verbrand, maar moeten volgens de plaatselijke voorschriften betreffende chemisch afval worden verwijderd.

Op dit product en de meegeleverde accessoires, m.u.v. de batterijen is de richtlijn voor afgedankte elektrische en elektronische apparaten (WEEE) van toepassing.

#### OBSERVERA ANGÄENDE ÅTERVINNING:

Produktens emballage är återvinningsbart och kan återanvändas. Kassera det enligt lokala återvinningsbestämmelser. När du kasserar enheten ska du göra det i överensstämmelse med lokala regler och bestämmelser.

Batterier får absolut inte kastas i soporna eller brännas. Kassera dem enligt lokala bestämmelser för kemiskt avfall.

Denna apparat och de tillbehör som levereras med den uppfyller gällande WEEE-direktiv, med undantag av batterierna.



Pb

**1. IMPORTANT NOTICE: DO NOT MODIFY THIS PRODUCT**

This product, when installed as indicated in the instructions contained in this manual, meets R&TTE directive requirements. Modification of the product could result in hazardous Radio and EMC radiation.

**2. CAUTION**

- Separation distance of at least 20 cm must be maintained between the antenna of this product and all persons.
- This product and its antenna must not be co-located or operating in conjunction with any other antenna or transmitter.

**1. WICHTIGER HINWEIS: NEHMEN SIE KEINE VERÄNDERUNGEN AN DIESEM PRODUKT VOR**

Wenn dieses Produkt entsprechend dieser Bedienungsanleitung aufgebaut wird, entspricht es den Anforderungen der R&TTE-Richtlinie. Veränderungen am Produkt können zu gefährlicher Funk- und EMV-Strahlung führen.

**2. VORSICHT**

- Zwischen der Antenne dieses Produkts und Personen muss ein Schutzabstand von 20 cm eingehalten werden.
- Dieses Produkt und seine Antenne dürfen nicht neben anderen Antennen oder Sendern aufgestellt oder zusammen mit ihnen verwendet werden.

**1. MISE EN GARDE IMPORTANTE : NE JAMAIS MODIFIER CE PRODUIT**

Si toutes les consignes indiquées dans ce mode ont été respectées pendant son installation, ce produit est conforme aux directives R&TTE. Toute modification du produit risquerait alors de générer des radiations radio et EMC dangereuses.

**2. ATTENTION**

- L'antenne de l'appareil devra être située à une distance de 20 cm au moins des personnes.
- Ce produit ainsi que son antenne ne devront en aucun cas être utilisés à proximité d'une autre antenne ou transmetteur.

**1. AVVERTENZA IMPORTANTE: NON MODIFICARE QUESTO PRODOTTO**

Se installato come indicato nelle istruzioni del presente manuale, questo prodotto soddisfa i requisiti della direttiva R&TTE. Eventuali modifiche apportate al prodotto potrebbero causare pericolose radiazioni radio ed EMC.

**2. ATTENZIONE**

- È necessario mantenere una distanza minima di 20 cm tra l'antenna di questo prodotto e le persone.
- Questo prodotto e la relativa antenna non devono essere posizionati in prossimità di altre antenne o trasmettitori e non devono essere utilizzati congiuntamente a questi ultimi.

**1. NOTA IMPORTANTE: NO MODIFIQUE ESTE PRODUCTO**

Este producto, si es instalado de acuerdo con las instrucciones contenidas en este manual, cumple los requisitos de la directiva R&TTE. La modificación del producto puede producir radiación de Radio y EMC peligrosa.

**2. PRECAUCIÓN**

- Se debe mantener una separación de al menos 20 cm entre la antena del producto y las personas.
- Este producto y su antena no debe instalarse ni utilizarse conjuntamente con otra antena o transmisor.

**1. BELANGRIJKE MEDEDELING: BRENG AAN DIT PRODUCT GEEN AANPASSINGEN AAN**

Dit product, indien geïnstalleerd volgens de aanwijzingen in deze gebruiksaanwijzing, voldoet aan de vereisten van de R&TTE-richtlijn. Aanpassing van dit product kan gevaarlijke radio- en EMC-straling tot gevolg hebben.

**2. LET OP**

- Houd tussen antenne en personen altijd een afstand van tenminste 20 cm aan.
- Dit product en zijn antenne mogen niet in de buurt van een andere antenne of zender worden geplaatst of in combinatie daarmee worden gebruikt.

**1. VIKTIGT: APPARATEN FÅR INTE MODIFIERAS**

Under förutsättning att apparaten installeras enligt anvisningarna i denna bruksanvisning, uppfyller denna kraven i R&TTE-direktivet. Ev. modifiering av apparaten kan resultera i farlig radio- och elektromagnetisk strålning.

**2. FÖRSIKTIGT**

- Se till att det finns ett avstånd på minst 20 cm mellan apparatens antenn och personer i omgivningen.
- Apparaten och dess antenn får inte placeras eller användas i närheten av andra antenner eller sändare.

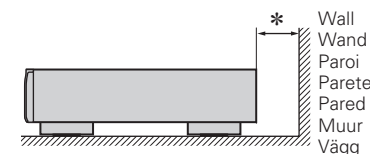
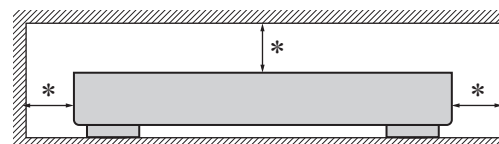
**CAUTIONS ON INSTALLATION****VORSICHTSHINWEISE ZUR AUFSTELLUNG****PRÉCAUTIONS D'INSTALLATION****PRECAUZIONI SULL'INSTALLAZIONE****EMPLAZAMIENTO DE LA INSTALACIÓN****VOORZORGSMAATREGELEN BIJ DE INSTALLATIE****FÖRSIKTIGHET VID INSTALLATIONEN**

\* **For proper heat dispersal, do not install this unit in a confined space, such as a bookcase or similar enclosure.**

- More than 0.1 m is recommended.
- Do not place any other equipment on this unit.

\* **Stellen Sie das Gerät nicht an einem geschlossenen Ort, wie in einem Bücherregal oder einer ähnlichen Einrichtung auf, da dies eine ausreichende Belüftung des Geräts behindern könnte.**

- Empfohlen wird über 0,1 m.
- Keine anderen Gegenstände auf das Gerät stellen.

\* **Pour permettre la dissipation de chaleur requise, n'installez pas cette unité dans un espace confiné tel qu'une bibliothèque ou un endroit similaire.**

- Une distance de plus de 0,1 m est recommandée.
- Ne placez aucun matériel sur cet appareil.

\* **Per una dispersione adeguata del calore, non installare questa apparecchiatura in uno spazio ristretto, come ad esempio una libreria o simili.**

- Si raccomanda una distanza superiore ai 0,1 m.
- Non posizionare alcun altro oggetto o dispositivo su questo dispositivo.

\* **Para la dispersión del calor adecuadamente, no instale este equipo en un lugar confinado tal como una librería o unidad similar.**

- Se recomienda dejar más de 0,1 m alrededor.
- No coloque ningún otro equipo sobre la unidad.

\* **Plaats dit toestel niet in een kleine afgesloten ruimte, zoals een boekenkast e.d., omdat anders de warmte niet op gepaste wijze kan worden afgevoerd.**

- Meer dan 0,1 m is aanbevolen.
- Plaats geen andere apparatuur op het toestel.

\* **För att tillförsäkra god värmeavledning får utrustningen inte installeras i instängda utrymmen, som t.ex. en bokhylla eller liknande.**

- Mer än 0,1 m rekommenderas.
- Placera ingen annan utrustning ovanpå den här enheten.

# Getting started

Thank you for purchasing this DENON product. To ensure proper operation, please read these owner's manual carefully before using the product. After reading them, be sure to keep them for future reference.

## Contents

<b>Getting started</b> .....	1
<b>Accessories</b> .....	2
<b>Main features</b> .....	2
<b>Cautions on handling</b> .....	2
<b>About this manual</b> .....	2
<b>Remote operation</b> .....	3
About the remote control unit .....	3
Denon Remote App .....	3
<b>Connections</b> .....	4
<b>Connecting the amplifier</b> .....	4
Analog connections .....	4
Digital connections .....	4
<b>Connecting an antenna</b> .....	5
<b>Connecting to a home network (LAN)</b> .....	6
Wired LAN .....	6
Wireless LAN .....	6
Required system .....	6
<b>Connecting the power cord</b> .....	7
<b>Basic operations</b> .....	8
<b>Preparations</b> .....	8
Turning the power on .....	8
Turning the power to standby mode .....	8
<b>Operations possible during playback</b> .....	8
Selecting the input source .....	8
Switching the display's brightness .....	8
<b>Network audio playback</b> .....	9
Listening to internet radio .....	9
Playing files stored on a computer .....	10
Listening to Last.fm .....	11
Listening to Napster .....	12
<b>Tuning in radio stations</b> .....	13
Listening to FM/AM broadcasts .....	13
Automatically presetting FM stations (Auto preset) .....	13
Presetting FM/AM stations manually .....	14
Listening to preset stations .....	15
Calling stations registered in Preset List .....	15
Deleting stations registered in Preset List .....	15

<b>Favorite function</b> .....	15
Registering stations or files to the favorites list .....	15
Calling stations or files from the favorites list .....	15
Deleting stations or files from the favorite list .....	15
<b>iPod® playback</b> .....	16
Playing an iPod .....	16
Disconnecting the iPod .....	17
<b>USB memory device playback</b> .....	17
Playing files stored on USB memory devices .....	17
Removing the USB memory device .....	17
Playing repeatedly (Repeat playback) .....	18
Playing random order (Random playback) .....	18
<b>AirPlay function</b> .....	19
Streaming music stored in iPhone or iPod touch directly to the unit .....	19
Playing iTunes music on this unit .....	19
Remote operations .....	19

<b>Advanced operations</b> .....	20
<b>Menu map</b> .....	20
<b>Setting the network [Network]</b> .....	21
Connecting wired LAN .....	21
Connecting wireless LAN .....	22
Last.fm Display .....	23
Party Mode Function .....	24
Other network settings .....	25
Zone Management Function .....	26
Update Notification .....	27
Upgrade Notification .....	27
<b>Setting the others [Other]</b> .....	27
Auto Standby .....	27
Firmware Update .....	28
Add New Feature .....	28
Language .....	29
<b>Tuning in radio stations</b> .....	29
RDS (Radio Data System) .....	29
PTY (Program Type) .....	29
TP (Traffic Program) .....	30
RT (Radio Text) .....	30
<b>Other functions</b> .....	31
Inputting characters .....	31
Last function memory .....	32
Resetting the microprocessor .....	32

<b>Information</b> .....	33
<b>Part names and functions</b> .....	33
Front panel .....	33
Rear panel .....	33
Remote control .....	34
<b>iPod®</b> .....	36
<b>USB memory device</b> .....	36
Important information .....	36
<b>Network audio</b> .....	37
Important information .....	37
<b>Explanation terms</b> .....	38
<b>Troubleshooting</b> .....	39
<b>Specifications</b> .....	43
<b>Index</b> .....	44

## Accessories

Check that the following parts are supplied with the product.

① Network setup guide.....	1
② Owner's manual.....	1
③ Service network list.....	1
④ Power cord.....	1
⑤ Remote control unit (RC-1159).....	1
⑥ R03/AAA batteries.....	2
⑦ Audio cable.....	1
⑧ AM loop antenna.....	1
⑨ FM indoor antenna.....	1
⑩ Rod antenna for wireless LAN.....	1

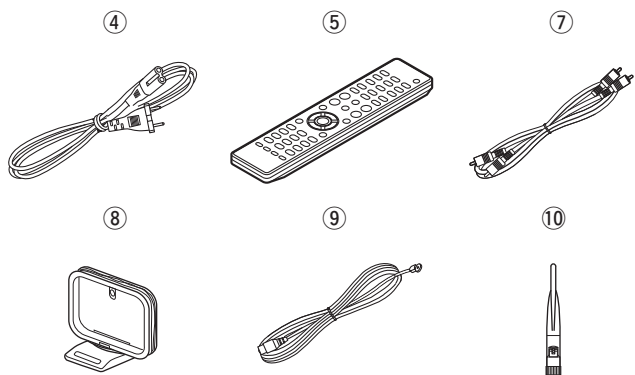

## Main features

**Equipped with the AirPlay® function in addition to network functions such as Internet Radio** (👉 page 19)

**Compatible with “Denon Remote App” for performing basic operations of the unit with an iPhone or iPod touch**

**Equipped with a USB/iPod port that is compatible with playback from iPhone® and iPod®** (👉 page 16)

**Equipped with Wi-Fi capabilities including Wi-Fi Protected Setup (WPS)**

**3 Lines OELD  
(Organic Electroluminescence Display)**

## Cautions on handling

### • Before turning the power switch on

Check once again that all connections are correct and that there are no problems with the connection cables.

• Power is supplied to some of the circuitry even when the unit is set to the standby mode. When going on vacation or leaving home for long periods of time, be sure to unplug the power cord from the power outlet.

### • About condensation

If there is a major difference in temperature between the inside of the unit and its surroundings, condensation may form on parts inside the unit, causing it to fail to operate properly.

If this happens, let the unit sit for an hour or two with the power turned off and wait until there is little difference in temperature before using the unit.

### • Cautions on using mobile phones

Using a mobile phone near this unit may result in noise. If that occurs, move the mobile phone away from the unit when it is in use.

### • Moving the unit

Turn off the power and unplug the power cord from the power outlet. Next, disconnect the cables connected to other system units before moving the unit.

## About this manual

### ☐ Symbols



This symbol indicates a reference page on which related information is described.



This symbol indicates a supplementary information and tips for operations.

**NOTE**

This symbol indicates points to remember operations or function limitations.

### ☐ Illustrations

Note that the illustrations in this manual may differ from the actual unit for explanation purposes.



## Remote operation

### About the remote control unit

#### Inserting the batteries

- Remove the rear cover of the remote control unit.
- Load the two batteries properly as indicated by the marks in the battery compartment.

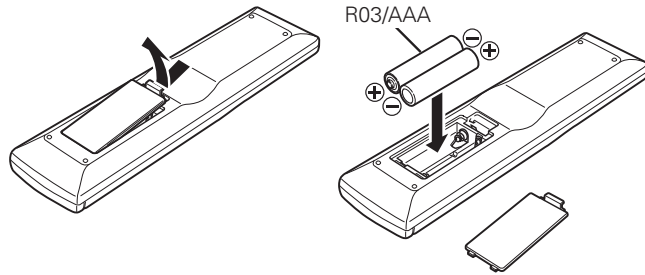

- Put the rear cover back on.

#### NOTE

- Insert the specified batteries in the remote control unit.
- Replace the batteries with new ones if the set does not operate even when the remote control unit is operated close to the unit. (The supplied batteries are only for verifying operation.)
- When inserting the batteries, be sure to do so in the proper direction, following the  $\oplus$  and  $\ominus$  marks in the battery compartment.
- To prevent damage or leakage of battery fluid:
  - Do not use a new battery together with an old one.
  - Do not use two different types of batteries.
  - Do not attempt to charge dry batteries.
  - Do not short-circuit, disassemble, heat or dispose of batteries in flames.
  - Do not keep the battery in a place exposed to direct sunlight or in places with extremely high temperatures, such as near a heater.
- If the battery fluid should leak, carefully wipe the fluid off the inside of the battery compartment and insert new batteries.
- Remove the batteries from the remote control unit if it will not be in use for long periods.
- Used batteries should be disposed of in accordance with the local regulations regarding battery disposal.
- The remote control unit may function improperly if rechargeable batteries are used.

#### Operating range of the remote control

Point the remote control unit at the remote sensor when operating it.

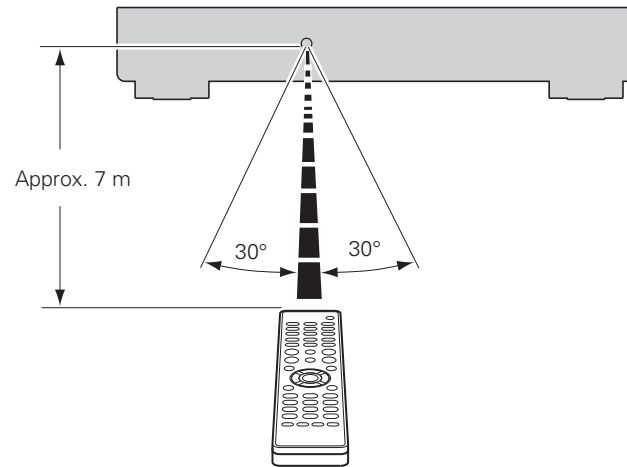

#### NOTE

The set may function improperly or the remote control unit may not operate if the remote control sensor is exposed to direct sunlight, strong artificial light from an inverter type fluorescent lamp or infrared light.

### Denon Remote App

Denon Remote App is a unique application developed for the iPhone and iPod touch. This application enables you to control DENON network devices that are connected to your home network. Install the App onto your iPhone or iPod touch to control this device.



- Bidirectional communication is performed.
- The Denon Remote App can be downloaded for free from the App Store.

# Connections

This section explains how to make connections for all of the supported audio signals.

## NOTE

- Do not plug in the power cord until all connections have been completed.
- When making connections, also refer to the owner's manual of the other components.
- Be sure to connect the left and right channels properly (left with left, right with right).
- Do not bundle power supply cords together with connection cables. Doing so can result in humming or noise.

## Connecting the amplifier

### Analog connections

#### Cables used for connections

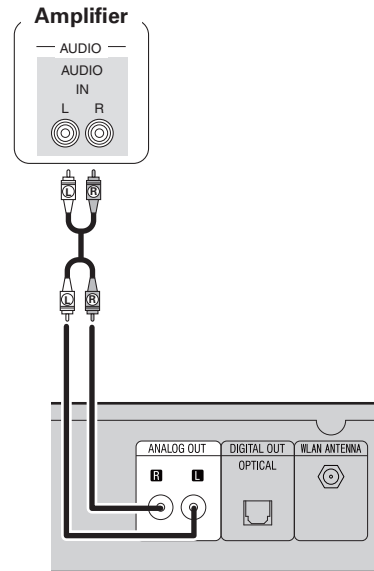
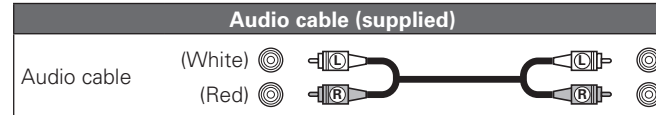

### Digital connections

Connect digital devices such as AV receivers and D/A converters with the unit to enjoy digital audio output from the unit. When connecting, use a commercially available optical cable.

#### Cables used for connections

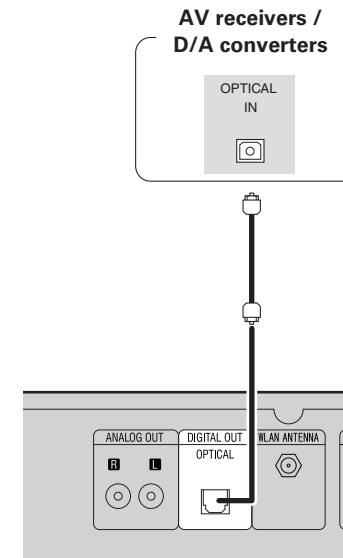
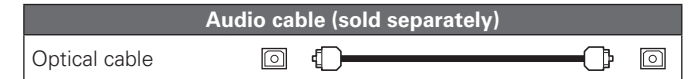

#### When connecting the optical digital output connector with an optical transmission cable (sold separately)

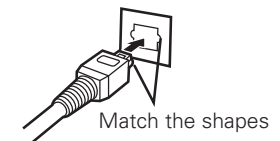

Match the shapes then insert firmly.

# Connecting an antenna

- Connect the FM antenna or AM loop antenna supplied with the unit to enjoy listening to radio broadcasts.
- After connecting the antenna and receiving a broadcast signal (see page 13 "Listening to FM/AM broadcasts"), fix the antenna with tape in a position where the noise level becomes minimal.
- When listening to radio stations, always make analog connections (see page 4 "Analog connections").

Direction of broadcasting station

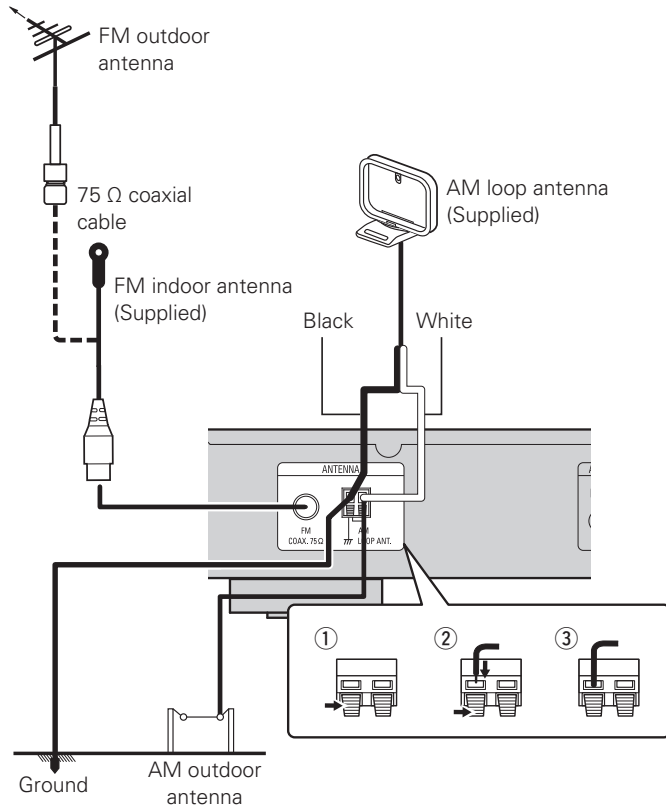

## AM loop antenna assembly

- 1 Put the stand section through the bottom of the loop antenna from the rear and bend it forward.**
- 2 Insert the projecting part into the square hole in the stand.**

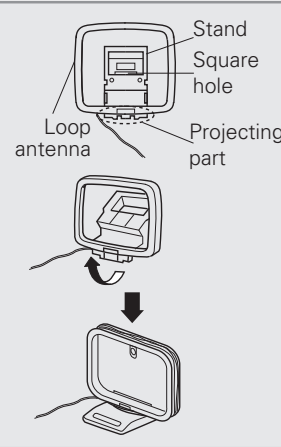

### NOTE

- Do not connect two FM antennas simultaneously.
- Even if an external AM antenna is used, do not disconnect the AM loop antenna.
- Make sure the AM loop antenna lead terminals do not touch metal parts of the panel.
- If the signal has noise interference, connect the ground terminal (GND) to reduce noise.
- If you are unable to receive a good broadcast signal, we recommend installing an outdoor antenna. For details, inquire at the retail store where you purchased the unit.

## Using the AM loop antenna

### Suspending on a wall

Suspend directly on a wall without assembling.

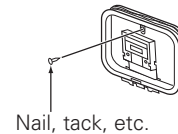

### Standing alone

Use the procedure shown above to assemble.

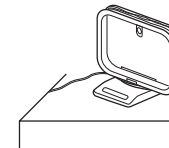

## Connecting to a home network (LAN)

- This unit lets you play via your home network (LAN) music files stored on a computer and music content such as that from Internet radio.
- You can update by downloading the latest firmware from the DENON website.  
For more information, see "Firmware Update" (page 28).
- See "Setting the network [Network]" (page 21) for more information on network setting.

## Wired LAN

### Cables used for connections

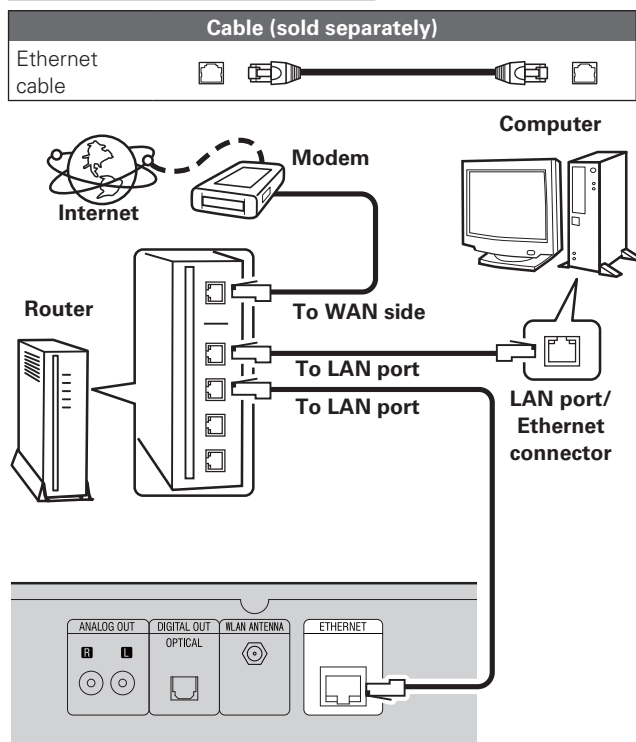

For connections to the Internet, contact an ISP (Internet Service Provider) or a computer shop.

## Wireless LAN

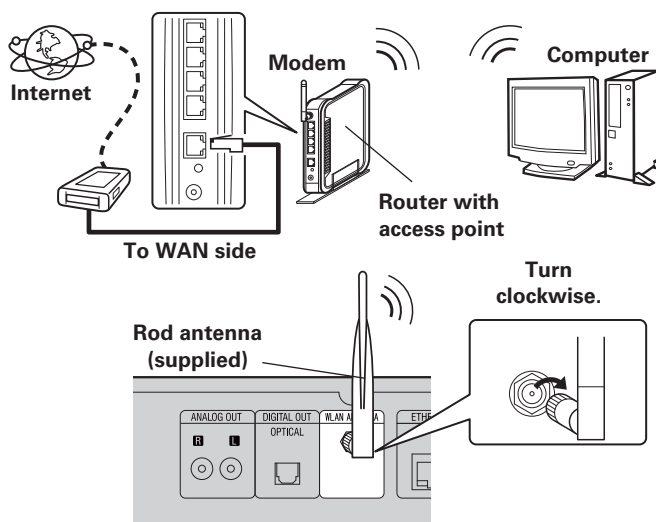

## Required system

### □ Broadband internet connection

#### □ Modem

Device that connects to the broadband circuit and conducts communications on the Internet.

A type that is integrated with a router is also available.

#### □ Router

When using this unit, we recommend you use a router equipped with the following functions:

- Built-in DHCP server  
This function automatically assigns IP addresses on the LAN.

• Built-in 100BASE-TX switch  
When connecting multiple devices, we recommend a switching hub with a speed of 100 Mbps or greater.

- When using with a wireless LAN, prepare a broadband router with built-in access point.

### □ Ethernet cable (CAT-5 or greater recommended)

- Use only a shielded STP or ScTP LAN cable which is available at retailer.
- Some flat type Ethernet cables are easily affected by noise.  
We recommend using a normal type cable.



- If you have an Internet provider contract for a line on which network settings are made manually, make the settings at "Network connecting (when "DHCP" settings are "Off")" (page 21).
- With this unit, it is possible to use the DHCP and Auto IP functions to make the network settings automatically.
- When using this unit with the broadband router's DHCP function enabled, this unit automatically performs the IP address setting and other settings.  
When using this unit connected to a network with no DHCP function, make the settings for the IP address, etc., at "Network connecting (when "DHCP" settings are "Off")" (page 21).
- When setting manually, check the setting contents with the network administrator.

### NOTE

- A contract with an ISP is required to connect to the Internet.
- No additional contract is needed if you already have a broadband connection to the Internet.
- The types of routers that can be used depend on the ISP. Contact an ISP or a computer shop for details.
- DENON assumes no responsibility whatsoever for any communication errors or troubles resulting from customer's network environment or connected devices.
- This unit is not compatible with PPPoE. A PPPoE-compatible router is required if you have a contract for a type of line set by PPPoE.
- Do not connect an ETHERNET connector directly to the LAN port/Ethernet connector on your computer.
- To listen to audio streaming, use a router that supports audio streaming.

## Connecting the power cord

When all of the connections are completed, insert the power plug into the power outlet.

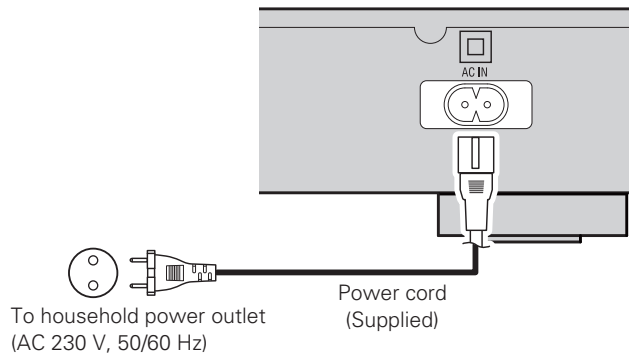

### NOTE

- Only use the supplied power cord.
- Be sure the power cord is unplugged from the power outlet before connecting or disconnecting it to the AC inlet.

# Basic operations



## Symbols used to indicate buttons in this manual

- Button located on both the main unit and the remote control → **BUTTON**
- Button only on the main unit → **<BUTTON>**
- Button only on the remote control → **[BUTTON]**

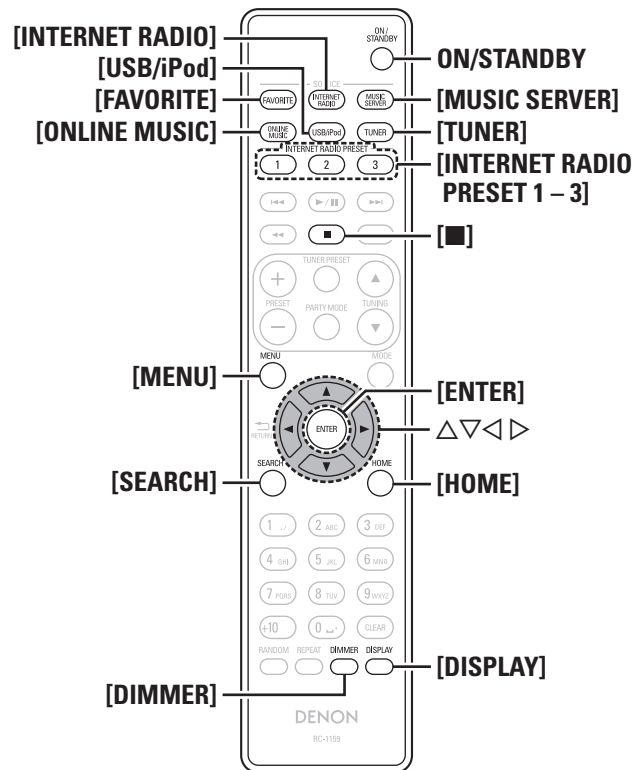
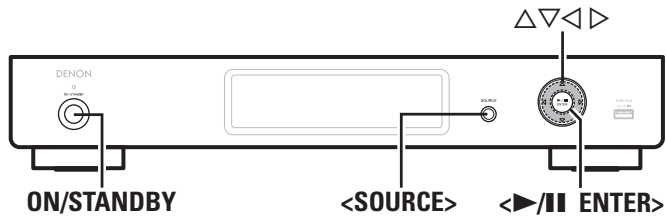

This section provides information on basic operations such as settings and playback procedures. For other operations, see the sections below.

- ❑ **Setting the others [Other]** (page 27)

## Preparations

### Turning the power on

Press **ON/STANDBY**.

The power indicator lights green and the power turns on.



- When you turn on the power of this unit for the first time after purchasing it, the "Network First Setup" menu starts up. For details on "Network First Setup" operations, see the separate "Network setup guide".
- If you cancelled "Network First Setup" menu or changed the network environment, perform "Menu" - "Network" - "Network First Setup".

### Turning the power to standby mode

Press **ON/STANDBY**.

The unit enters standby mode.

- Power indicator
  - Standby .....Red
  - Network standby.....Orange
  - Auto standby.....Off

### NOTE

Power continues to be supplied to some of the circuitry even when the power is in the standby mode. When leaving home for long periods of time, either press **ON/STANDBY** to turn off the power, or unplug the power cord from the power outlet.

- ❑ **Completely turning off the power**

Unplug the power cord from the wall outlet.

### NOTE

The settings made for the various functions may be cleared if the power cord is left unplugged from a power outlet for an extended period of time.

## Operations possible during playback

### Selecting the input source

- ❑ **Selecting the input source using unit operations**

**1** Press **<SOURCE>**.  
The display changes to the input source selection screen.

**2** Press **Δ∇** to select the input source, then press **<ENTER>** or **▷**.  
The input source is switched each time the button is pressed.



With the unit, you can play back music files stored on your iPhone/iPod touch and music from iTunes (page 19 "AirPlay function").

- ❑ **Selecting the input source using the remote control**

Press the input source select button (**[FAVORITE]**, **[INTERNET RADIO]**, **[MUSIC SERVER]**, **[ONLINE MUSIC]**, **[USB/iPod]** or **[TUNER]**).

The desired input source can be selected directly.

### Switching the display's brightness

Press **[DIMMER]**.

- The display brightness is adjusted each time **[DIMMER]** is pressed as shown below.



If you operate the buttons when the display's brightness is set to "Off", the display temporarily lights at "25%" brightness level.

## Network audio playback

Follow this procedure to play Internet radio stations or music files stored on a computer.

- ❑ **About the internet radio function** (🔗 page 37)
- ❑ **Music server** (🔗 page 37)
- ❑ **About Napster** (🔗 page 37)
- ❑ **About Last.fm** (🔗 page 37)

### Listening to internet radio

#### 1 Prepare for playback.

- ① Check the network environment, then turn on this unit's power (🔗 page 8 "Turning the power on").
- ② If settings are required, make the "Setting the network [Network]" (🔗 page 21).

#### 2 Press [INTERNET RADIO] to switch the input source to "Internet Radio".

- For details on selecting the input source using the unit buttons, see "Selecting the input source using unit operations" (🔗 page 8).

#### 3 Press $\Delta/\nabla$ to select the item you want to play, then press [ENTER], $\blacktriangleleft/\blacktriangleright$ or $\blacktriangleright$ .

#### 4 Repeat step 3 until the station list is displayed.

The station list is displayed.

- Any characters that cannot be displayed are replaced with "." (period).

#### 5 Press $\Delta/\nabla$ to select the station, then press [ENTER], $\blacktriangleleft/\blacktriangleright$ or $\blacktriangleright$ .

Playback starts once buffering reaches "100%".



- There are many Internet radio stations on the Internet, and the quality of the programs they broadcast as well as the bit rate of the tracks varies widely. Generally, the higher the bit rate, the higher the sound quality, but depending on the communication lines and server traffic, the music or audio signals being streamed may be interrupted. Inversely, lower bit rates mean a lower sound quality but less tendency for the sound to be interrupted.
- "Server Full" or "Connection Down" is displayed if the station is busy or not broadcasting.

#### ❑ Listening to preset internet radio stations

You can register your favorite radio stations to [INTERNET RADIO PRESET 1 – 3] to call them up easily.

### Registering Internet radio stations to INTERNET RADIO PRESET 1 – 3 buttons

While playing back the internet radio station that you want to register, press and hold one of the [INTERNET RADIO PRESET 1 – 3].

The internet radio station is registered to the button that you held down.

#### NOTE

If the internet radio station is registered to a number that has previously been registered, the previous registration details are deleted.

### Listening to an Internet radio station registered to a INTERNET RADIO PRESET 1 – 3 button

Press one of the registered [INTERNET RADIO PRESET 1 – 3].

Playback starts.

#### ❑ Switching the display

Press [DISPLAY] during Internet radio reception.

The broadcast station information and signal format bit rate are displayed.

#### ❑ Recently played internet radio stations

Recently played internet radio stations can be selected from "Recently Played".

Up to 20 stations stored in "Recently Played".

**1** Press  $\Delta/\nabla$  to select "Recently Played", then press [ENTER],  $\blacktriangleleft/\blacktriangleright$  or  $\blacktriangleright$ .

**2** Press  $\Delta/\nabla$  to select the item you want to play, then press [ENTER],  $\blacktriangleleft/\blacktriangleright$  or  $\blacktriangleright$ .

#### ❑ Searching stations by keyword (Alphabetic strings)

**1** Press  $\Delta/\nabla$  to select "Search by Keyword", then press [ENTER],  $\blacktriangleleft/\blacktriangleright$  or  $\blacktriangleright$ .

**2** Input the characters, then press [ENTER] or  $\blacktriangleleft/\blacktriangleright$ .

- For character input, see page 31.

#### ❑ Registering internet radio stations as your favorites

You can register your favorite broadcast stations in Favorite List (🔗 page 15).

#### ❑ Internet radio operation

Operation buttons	Function
FAVORITE	Registration/call from the Favorite list, deletion from the Favorite list
■	Stop
MENU	Menu
$\Delta/\nabla/\blacktriangleleft/\blacktriangleright$	Cursor operation (Up/Down/Left/Right)
ENTER	Enter
SEARCH	Character search*
HOME	Return to top page

- \* Press [SEARCH], then press [ENTER] to select the first letter you want to search mode.



If the list is not in alphabetical order, you may not be able to perform a character search.

**Symbols used to indicate buttons in this manual**

- Button located on both the main unit and the remote control → **BUTTON**
- Button only on the main unit → **<BUTTON>**
- Button only on the remote control → **[BUTTON]**

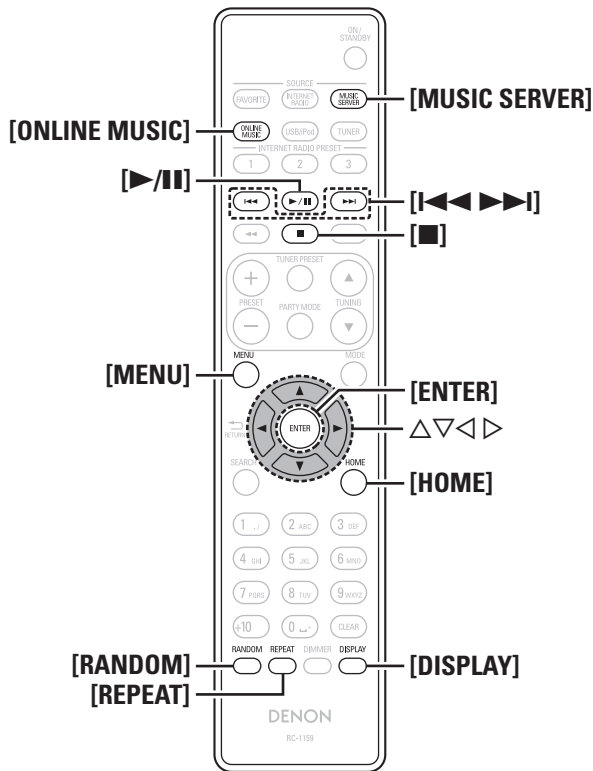
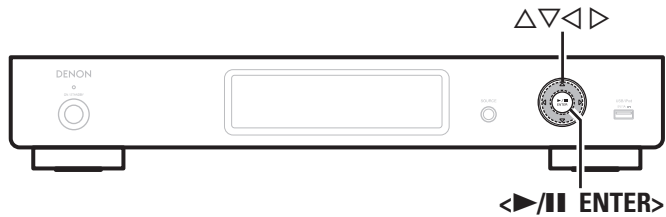

**Playing files stored on a computer**

Use this procedure to play music files or playlists.

- 1 Prepare for playback.**
  - ① Check the network environment, then turn on this unit's power (page 8 "Turning the power on").
  - ② If settings are required, make the "Setting the network [Network]" (page 21).
  - ③ Prepare the computer (page 37 "Music server").
- 2 Press [MUSIC SERVER] to switch the input source to "Music Server".**
  - For details on selecting the input source using the unit buttons, see "Selecting the input source using unit operations" (page 8).
- 3 Press  $\triangle\triangledown$  to select the server including the file to be played, then press [ENTER],  $\triangleleft\triangleright/\parallel$  ENTER or  $\triangleright$ .**
- 4 Press  $\triangle\triangledown$  to select the search item or folder, then press [ENTER],  $\triangleleft\triangleright/\parallel$  ENTER or  $\triangleright$ .**
- 5 Repeat step 4 until the file is displayed.**
- 6 Press  $\triangle\triangledown$  to select the file, then press [ENTER],  $\triangleleft\triangleright/\parallel$  ENTER or  $\triangleright$ .**  
Playback starts once buffering reaches "100%".

**Network audio playback**

- Connections to the required system and specific settings must be made in order to play music files (page 6).
- Before starting, you must launch the computer's server software and set the files as server contents. For details, see the operating instructions of your server software.
- The order in which the tracks/files are displayed depends on the server specifications. If the tracks/ files are not displayed in alphabetical order due to the server specifications, searching by the first letter may not work properly.
- WMA Lossless files can be played when using a server supporting transcoding, such as Windows Media Player Ver. 11 or later.

**Switching the display**

During playback, Press [DISPLAY].

- The display switches each time [DISPLAY] is pressed.

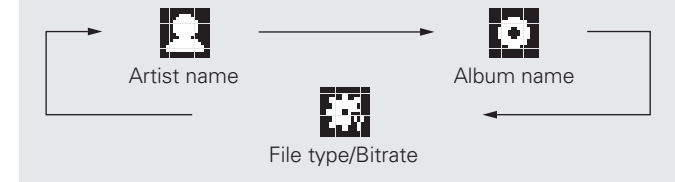

**Music server operation**

Operation buttons	Function
$\triangleleft\triangleright\triangleright\triangleright$	Auto search (cue)
$\triangleright\parallel$	Playback / Pause
■	Stop
<b>MENU</b>	Menu
$\triangle\triangledown\triangleleft\triangleright$	Cursor operation ( $\triangle\triangledown\triangleleft\triangleright$ ) / Auto search (cue, $\triangle\triangledown$ )
<b>ENTER</b>	Enter
<b>HOME</b>	Return to top page
<b>REPEAT</b>	Repeat playback (page 18)
<b>RANDOM</b>	Random playback (page 18)*



\* When playing files stored on a computer using the random play function, when a track has finished playing, the next track is selected at random from all of the tracks on the computer. For this reason, the same track may be played back to back.



## Listening to Last.fm

Last.fm radio is not available in all countries. Please check [www.last.fm/hardware](http://www.last.fm/hardware) for more information. You'll also need a subscription. Get one today at [www.last.fm/subscribe](http://www.last.fm/subscribe).

### 1 Prepare for playback.

- ① Make sure this unit is connected to the Internet, then turn on this unit's power ( page 8 "Turning the power on").
- ② If settings are required, make the "Setting the network [Network]" ( page 21).

### 2 Press [ONLINE MUSIC] to switch the input source to "Last.fm".

- For details on selecting the input source using the unit buttons, see "Selecting the input source using unit operations" ( page 8).
- If you do not have a Last.fm account, press  $\nabla$  to select "I am new to Last.fm". Then press [ENTER],  $\blacktriangleleft$ /|| ENTER or  $\blacktriangleright$ . Create an account in accordance with the instructions on the display.

### 3 If you have a Last.fm account, press $\Delta\nabla$ to select "I have a Last.fm account". Then press [ENTER], $\blacktriangleleft$ /|| ENTER or $\blacktriangleright$ .

### 4 Use $\Delta\nabla\blacktriangleright$ to enter your username and password.

- For character input, see page 31.

### 5 After inputting the username and password, select "login", then press [ENTER] or $\blacktriangleleft$ /|| ENTER.

If the username and password match, the top menu for Last.fm is displayed.

- The types of characters that can be input are as shown below.

- Username**  
**[Lower case characters]** abcdefghijklmnopqrstuvwxyz  
**[Upper case characters]** ABCDEFGHIJKLMNOPQRSTUVWXYZ  
**[Symbols]** \_ -  
**[Numbers]** 0123456789

**Password**  
**[Lower case characters]** abcdefghijklmnopqrstuvwxyz  
**[Upper case characters]** ABCDEFGHIJKLMNOPQRSTUVWXYZ  
**[Symbols]** ! " # \$ % & ' ( ) \* + , - . / : ; < = > ? @ [ \ ] ^ \_ ` { | } ~ (Space)  
**[Numbers]** 0123456789

### 6 Use $\Delta\nabla$ to select menu and then press [ENTER], $\blacktriangleleft$ /|| ENTER or $\blacktriangleright$ .

- Popular Tags** Play popular tags in your area.
- Popular Artists** Play popular artists tags in your area.
- Your Recent Stations** Play your recent stations.
- Your Recommended Radio** Play your recommended radio.
- Your Library** Play your library.
- Your Friend's Radio** Play your friend's radio.
- Your Top Artists** Play your top Artists.
- Search Tag Radio** You can search station by Tag.
- Search Artist Radio** You can search station by Artist.

### 7 Use $\Delta\nabla$ to select a station, and press [ENTER], $\blacktriangleleft$ /|| ENTER, $\blacktriangleright$ or $\blacktriangleright$ /|| to start playback. Playback starts.

### 8 When you press $\blacktriangleright$ during playback, the following menu appears.

- Love this track** Loving tracks improves your Last.fm recommendations, and you can optionally share them on popular social networks.
- Ban this track** If you ban a track, we won't play it again. You can undo this on the Last.fm website.
- Scrobbling** Scrobbling sends the tracks you played to your Last.fm account. You can see charts of the music you've been listening to, get recommendations for new music and events in your area and share your listening tastes with your friends. You can turn this service on or off using this option. The more you scrobble, the better your recommendations will become.

#### NOTE

- The password should be no longer than 90 characters
- Press [HOME] to cancel the input.

#### Switching the display

#### During playback, Press [DISPLAY].

The file type/bit rate, artist name and album name are displayed.

#### Last.fm operation

Operation buttons	Function
$\blacktriangleright$ /	Playback
$\blacktriangleright\blacktriangleright$	Auto search (cue)
$\blacksquare$ (or $\blacktriangleright$ /   ENTER (main unit))	Stop
MENU	Menu
$\Delta\nabla\blacktriangleleft\blacktriangleright$	Cursor operation / Auto search (cue, $\nabla$ )
ENTER	Enter
HOME	Return to top page

**Symbols used to indicate buttons in this manual**

Button located on both the main unit and the remote control → **BUTTON**

Button only on the main unit → **<BUTTON>**

Button only on the remote control → **[BUTTON]**

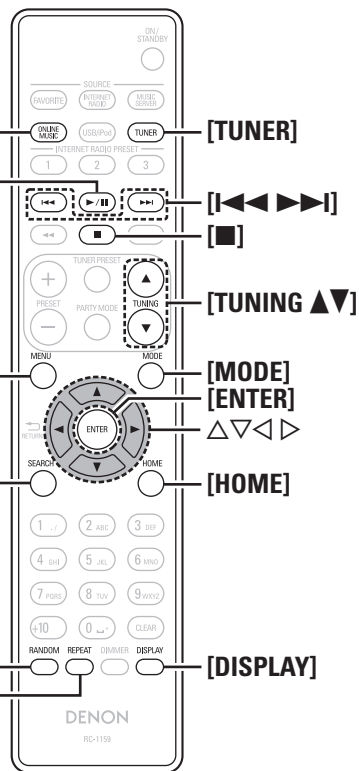
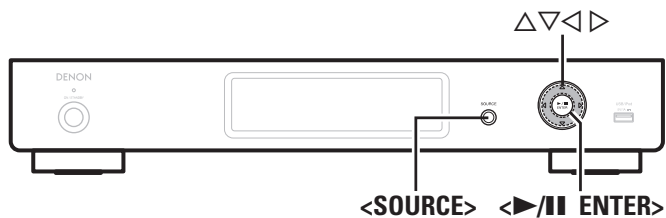

## Listening to Napster

Napster is not available in all countries.

### 1 Prepare for playback.

- ① Check the network environment, then turn on this unit's power (☞ page 8 "Turning the power on").
- ② If settings are required, make the "Setting the network [Network]" (☞ page 21).

### 2 Press [ONLINE MUSIC] to switch the input source to "Napster".

- For details on selecting the input source using the unit buttons, see "Selecting the input source using unit operations" (☞ page 8).

### 3 Use △▽▶ to input "Username" and "Password".

- For character input, see page 31.

### 4 After inputting the "Username" and "Password", select "login", then press [ENTER] or <▶/|| ENTER>.

If the "Username" and "Password" match, the top menu for Napster is displayed.

#### NOTE

- The password should be no longer than 99 characters.
- Press [HOME] to cancel the input.

### Searching from Napster menu

#### 1 Use △▽ to select search item or folder, then press [ENTER], <▶/|| ENTER> or ▶.

#### 2 Repeat step 1 until the track is displayed.

#### 3 Use △▽ to select the track item, then press [ENTER], <▶/|| ENTER> or ▶.

### Entering a character search for the track you want to listen to

#### 1 Press [SEARCH].

- You can search by artist name, album name or track name in menu list.
- You cannot perform search on the playback screen.

#### 2 Use △▽ to select the search item, then press [ENTER] or <▶/|| ENTER>.

The search display appears.

#### 3 Input the characters, then press [ENTER] or <▶/|| ENTER>.

### Registering tracks in my Napster library

#### 1 Press ▶ while the track you wish to register is playing.

"Add to my library?" appears.

#### 2 Press [ENTER], <▶/|| ENTER> or ▶.

The track is entered in the Library.

When you press <, the registration is cancelled and the display returns to the previous page.

### Listening to tracks registered in my Napster library

#### 1 Use △▽ to select "My Napster Library", then press [ENTER], <▶/|| ENTER> or ▶.

#### 2 Use △▽ to select the information or track, then press [ENTER] or <▶/|| ENTER>.

## Network audio playback

## ❑ Switching the display

During playback, Press [DISPLAY].

The file type/bit rate, artist name and album name are displayed.

## ❑ Napster operation

Operation buttons	Function
⏮ ⏪ ⏩ ⏭	Auto search (cue)
▶/⏸	Playback
■	Stop
MENU	Menu
△▽◀▶	Cursor operation / Auto search (cue, △▽)
ENTER	Enter
SEARCH	Search menu
HOME	Return to top page
REPEAT	Repeat playback (👉 page 18)
RANDOM	Random playback (👉 page 18)



## Tuning in radio stations

Connect the antenna beforehand (👉 page 5).

## Listening to FM/AM broadcasts

- 1 Press [TUNER] to select the reception band.  
The reception band is toggled as shown below each time [TUNER] is pressed.

**FM** When listening to an FM broadcast.

**AM** When listening to an AM broadcast.

- The reception band can also be selected by pressing <SOURCE> (👉 page 8).

## 2 Tune in the desired broadcast station.

When a station is received, the 📶 will light.

**Auto tuning** To tune in automatically.

- ① Press [MODE], and "AUTO" lights in the display.
- ② Press [TUNING ▲] or [TUNING ▼] to select the station you want to hear.

**Manual tuning** To tune in manually.

- ① Press [MODE], and "AUTO" goes out in the display.
- ② Press [TUNING ▲] or [TUNING ▼] to select the station you want to hear.



- If the desired station cannot be tuned in with auto tuning, tune it in manually.
- When tuning in stations manually, press and hold [TUNING ▲] or [TUNING ▼] to change frequencies continuously.
- A humming sound may be heard when using a TV nearby while receiving AM programs. If this happens, move the system as far from the TV as possible.

## ❑ To stop auto tuning

Press [TUNING ▲] or [TUNING ▼].

## Automatically presetting FM stations (Auto Preset)

- This unit can be preset with a total of 99, FM broadcast stations.
- Perform this operation when tuned to an FM broadcast station.

**NOTE**

Auto preset is not possible with AM broadcast stations.

- 1 Press [SEARCH].  
"Auto Preset" menu appears.

- 2 Use △▽ to select "Start", then press [ENTER], <▶/⏸ ENTER> or ▶.  
"Searching" appears in the display, and the unit searches for radio stations. When the search is complete, "Complete!!" appears.

## Canceling auto presetting

Press [■].

**NOTE**

- Broadcast stations whose antenna signal are weak cannot be preset automatically. If you wish to preset such stations, tune them in manually.
- If number that was already assigned as a preset is selected, the old preset information is overwritten with the new information.



**Symbols used to indicate buttons in this manual**

- Button located on both the main unit and the remote control → **BUTTON**
- Button only on the main unit → **<BUTTON>**
- Button only on the remote control → **[BUTTON]**

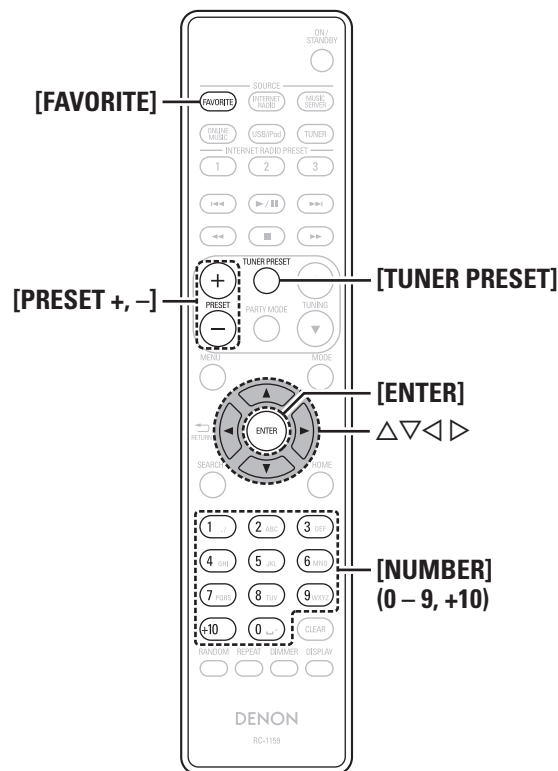
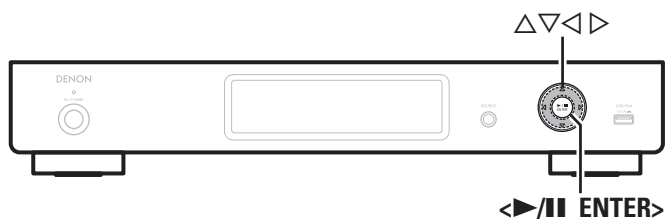

**□ Giving station names to preset channels**

Names of up to 8 characters can be input.

- 1** Tune in the preset channel you want to name.
- 2** Press and hold [TUNER PRESET].  
The display switches to the station name input display.
- 3** Input the station name.  
• For character input, see page 31.
- 4** Press [ENTER] or <▶/|| ENTER>.  
The characters you have input are entered.  
• To give names to other stations, repeat steps 1 to 4.

**Presetting FM/AM stations manually**

A maximum of 8 characters can be input for the station name.

- 1** Tune in the station you want to preset.
- 2** Press [TUNER PRESET].  
“Preset” menu appears.
- 3** Use Δ▽ to select “Add to Preset”, then press [ENTER], <▶/|| ENTER> or ▷.
- 4** Use Δ▽ to select the number to be preset, then press [ENTER] or <▶/|| ENTER>.  
The reception frequency and reception mode are preset and the display switches to the station name input display.
- 5** Input the station name.  
• For character input, see page 31.  
• If you do not want to input a station name, press [ENTER] or <▶/|| ENTER> without inputting anything else.  
• If you make a mistake inputting, re-input the correct station name. Whatever was previously input is overwritten.
- 6** Press [ENTER] or <▶/|| ENTER>.  
The characters you have input are entered.  
• To give names to other stations, repeat steps 1 to 5.

## Listening to preset stations

Use [NUMBER] (0 – 9, +10), [PRESET +, -] or  $\Delta\nabla$  to select the preset number.

## Calling stations registered in Preset List

- 1** Press [TUNER PRESET].  
"Preset" menu appears.
- 2** Use  $\Delta\nabla$  to select "Call Preset", then press [ENTER],  $\langle\rangle$ /|| ENTER or  $\triangleright$ .  
The Preset list appears.
- 3** Use  $\Delta\nabla$  to select the station, and then press [ENTER],  $\langle\rangle$ /|| ENTER or  $\triangleright$ .

## Deleting stations registered in Preset List

- 1** Press [TUNER PRESET].  
"Preset" menu appears.
- 2** Use  $\Delta\nabla$  to select "Delete Preset", then press [ENTER],  $\langle\rangle$ /|| ENTER or  $\triangleright$ .  
The Preset list appears.
- 3** Use  $\Delta\nabla$  to select the station, and then press [ENTER],  $\langle\rangle$ /|| ENTER or  $\triangleright$ .
- 4** When the prompt "Delete?" appears, press [ENTER],  $\langle\rangle$ /|| ENTER or  $\triangleright$ .  
• To cancel the operation, press  $\triangleleft$ .



## Favorite function

This section provides information on the Favorite function.

- The Favorite function allows you to register your favorite broadcast stations and files in Favorite List in advance so that you can call and listen to the stations or files right away, whenever you want.
- The contents that you can register and call are Internet radio station and tuner.
- You can register up to 50 items in Favorite List.
- When the 51st item is registered, the least frequently accessed radio station is replaced by the new item.
- When you select a station from Favorite List, the top of the list is displayed.

## Registering stations or files to the favorites list

- 1** Press [FAVORITE] while the Internet radio station, tuners or file to register is played back.  
"Favorite" menu appears.
- 2** Use  $\Delta\nabla$  to select "Add to Favorite", then press [ENTER],  $\langle\rangle$ /|| ENTER or  $\triangleright$ .  
When the station, server, or tuner is registered, "Add to Favorite" appears.

## Calling stations or files from the favorites list

- 1** Press [FAVORITE].  
"Favorite" menu appears.
- 2** Use  $\Delta\nabla$  to select "Call Favorite", then press [ENTER],  $\langle\rangle$ /|| ENTER or  $\triangleright$ .  
The Favorite list appears.
- 3** Press  $\Delta\nabla$  to select the station or file that you want to call, and press [ENTER],  $\langle\rangle$ /|| ENTER or  $\triangleright$ .  
The respective function starts up and playback starts.

## Deleting stations or files from the favorite list

- 1** Press [FAVORITE].  
"Favorite" menu appears.
- 2** Use  $\Delta\nabla$  to select "Delete Favorite", then press [ENTER],  $\langle\rangle$ /|| ENTER or  $\triangleright$ .  
The Favorite list appears.
- 3** Press  $\Delta\nabla$  to select the station or file that you want to delete, and press [ENTER],  $\langle\rangle$ /|| ENTER or  $\triangleright$ .
- 4** When the prompt "Delete?" appears, press [ENTER],  $\langle\rangle$ /|| ENTER or  $\triangleright$ .  
• To cancel the operation, press  $\triangleleft$ .

**Symbols used to indicate buttons in this manual**

- Button located on both the main unit and the remote control → **BUTTON**
- Button only on the main unit → **<BUTTON>**
- Button only on the remote control → **[BUTTON]**

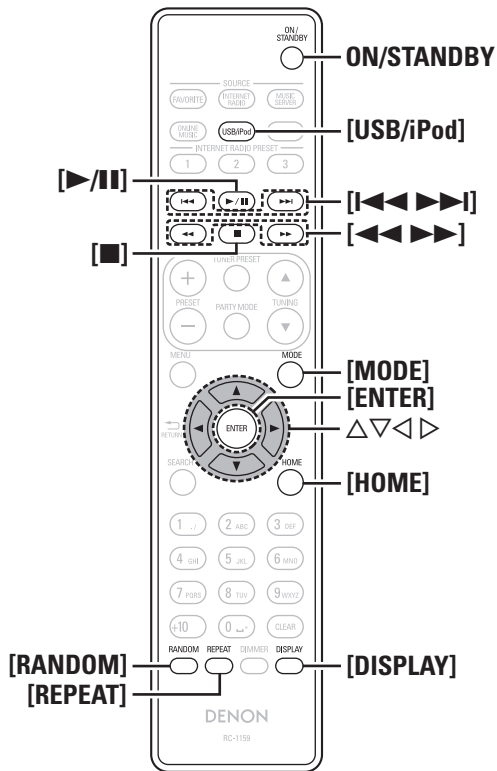
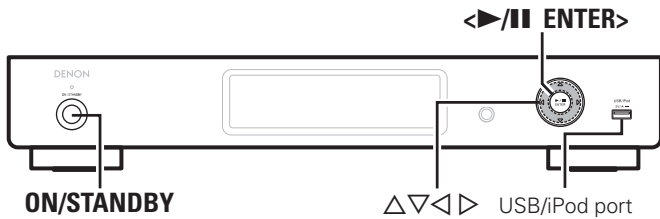

**iPod® playback**

You can use the USB cable provided with the iPod to connect the iPod with the unit's USB/iPod port and enjoy music stored on the iPod. The unit can play back music stored on iPod/iPod touch/iPod classic/iPod nano (the fifth or later generation only).

□ iPod® (☞ page 36)

**Playing an iPod**

**1** Connect the iPod to the USB/iPod port using the USB cable that was supplied with the iPod.

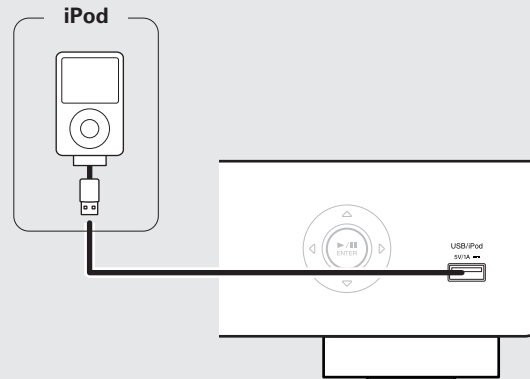

**2** Press **ON/STANDBY** to turn on power to the main unit.

**3** Press **[USB/iPod]** to switch the input source to "USB/iPod".

• For details on selecting the input source using the unit buttons, see "Selecting the input source using unit operations" (☞ page 8).

**4** Press **[MODE]** to select the display mode.

The display mode switches each time **[MODE]** is pressed.

- There are two modes for displaying the contents recorded on the iPod.

- Browse mode** Display iPod information on the display of this unit.
- Remote mode** Display iPod information on the iPod screen.
  - "Remote iPod" is displayed on the display of this unit.

Display mode		Browse mode	Remote mode
Display location		Main unit display	iPod display
Playable files	Audio file	✓	✓
	Video file		✓*
Active buttons	Remote control and main unit	✓	✓
	iPod		✓

\* Only audio is played back.

- The default display mode setting is "Remote mode".

**5** Use **△▽** to select the item, then press **[ENTER]** or **<▶/|| ENTER>** to select the music file to be played.

**6** Press **[▶/||]** or **<▶/|| ENTER>**. Playback starts.

**NOTE**

- 1st generation iPod nano and iPod video do not have remote mode support.
- DENON will accept no responsibility whatsoever for any loss of iPod data.
- Depending on the type of iPod and the software version, some functions may not operate.
- This unit does not support playback on an iPad. Do not connect an iPad to the unit.
- When connecting an iPhone to this unit, keep the iPhone at least 20 cm away from this unit. If the iPhone is kept closer to this unit and a telephone call is received by the iPhone, noise may be output from this device.

## iPod® playback

## Remote control and iPod button relations

Remote control buttons	iPod buttons	Operation on this unit
⏮, ⏭	⏮, ⏭	Play the track from the beginning/Play the next track
▶/⏸	▶/⏸	Play the track / Pause the track
⏪, ⏩ Press and hold	⏮, ⏭ Press and hold	Fast-reverse the track/Fast-forward the track
■	–	Stop the track
MODE	–	Switch between the browse mode and the remote mode
△▽	Click Wheel	Cursor operation (up /down)
◀	MENU	Display the menu or return to the previous menu
ENTER or ▶	Select	Enter the selection or plays the track
HOME	–	Return to top menu (in Browse mode)
REPEAT	–	Switch the repeat function
RANDOM	–	Switch the shuffle function

## Switching the display

During playback, Press [DISPLAY].

- The display switches each time [DISPLAY] is pressed (Browse mode only).



## Disconnecting the iPod

- Press ON/STANDBY to set the standby mode.
- Disconnect the iPod from the USB/iPod port.



## USB memory device playback

You can playback music stored on a USB memory device using this unit.

- USB memory device (☞ page 36)

## Playing files stored on USB memory devices

- Connect the USB memory device to the USB/iPod port.

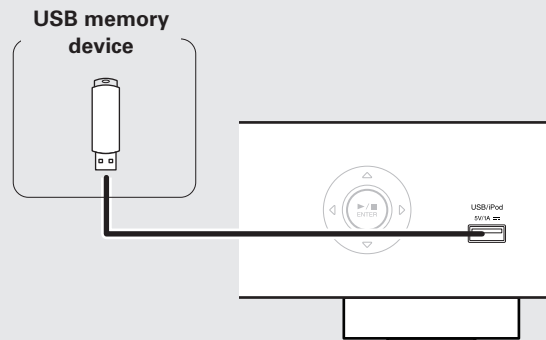

- Press ON/STANDBY to turn on power to the main unit.

- Press [USB/iPod] to switch the input source to "USB/iPod."

- For details on selecting the input source using the unit buttons, see "Selecting the input source using unit operations" (☞ page 8).

- Press △▽ to select the item or folder, then press [ENTER], <▶/⏸ ENTER> or ▶.

- Press △▽ to select the file, then press [ENTER], <▶/⏸ ENTER>, ▶ or [▶/⏸]. Playback starts.



- If the USB memory device is divided into multiple partitions, only the top partition can be selected.
- This unit is compatible with MP3 files conforming to "MPEG-1 Audio Layer-3" standards.
- DENON does not guarantee that all USB memory devices will operate or receive power. When using a portable USB connection type HDD of the kind to which an AC adapter can be connected to supply power, use the AC adapter.

## NOTE

- USB memory devices will not work via a USB hub.
- It is not possible to connect and use a computer via the USB/iPod port of this unit using a USB cable.
- Do not use an extension cable when connecting a USB memory device. This may cause radio interference with other devices.
- Note that DENON will accept no responsibility whatsoever for any problems arising with the data on a USB memory device when using this unit in conjunction with the USB memory device.

## Removing the USB memory device

- Press ON/STANDBY to set the standby mode.

- Check that the communication indicator on the USB memory device is not flashing, then pull out the USB memory device.

## NOTE

Do not remove the USB memory device from the unit when the USB memory communication indicator is flashing. Doing so may damage the USB memory device, or may corrupt the files recorded on the USB memory device.

**Symbols used to indicate buttons in this manual**

- Button located on both the main unit and the remote control → **BUTTON**
- Button only on the main unit → **<BUTTON>**
- Button only on the remote control → **[BUTTON]**

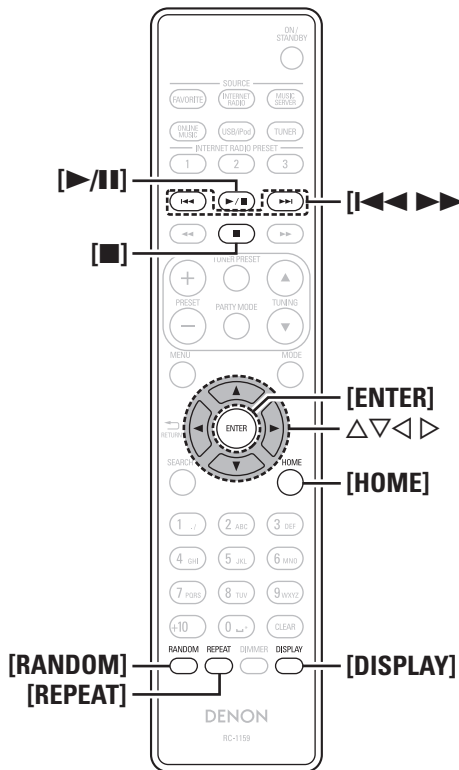
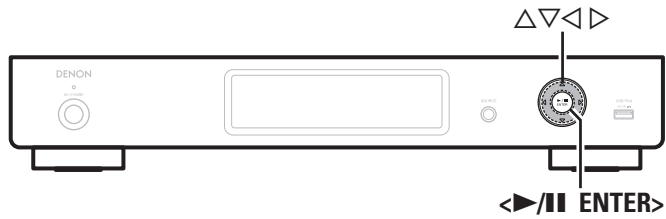

## Playing repeatedly (Repeat playback)

Press **[REPEAT]**.

Repeat playback starts.

- Each time you press **[REPEAT]**, the repeat mode is toggled as shown below.

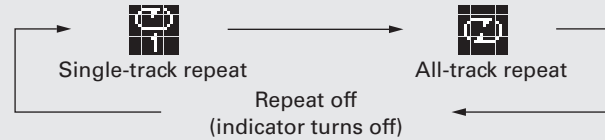

- (Single-track repeat) Only 1 track plays repeatedly.
- (All-track repeat) All tracks within the current playback folder are repeated.
- Repeat off (indicator turns off) Normal playback resumes.

## Playing random order (Random playback)

1 Press **[RANDOM]**.

2 Press **<▶/II ENTER>** or **[▶/II]**.  
The indicator lights in the display, and random playback starts.

### Canceling random playback

Press **[RANDOM]**.  
The indicator on the display turns off.

## USB operation

Operation buttons	Function
	Auto search (cue)
	Playback / Pause
	Stop
	Cursor operation / Auto search (cue, Δ∇)
<b>ENTER</b> or	Enter
	Display the menu or return to the previous menu
<b>HOME</b>	Return to top page
<b>REPEAT</b>	Repeat playback
<b>RANDOM</b>	Random playback*

\* When playing files stored on a USB memory device using the random play function, when a track has finished playing, the next track is selected at random from all of the tracks on the device. For this reason, the same track may be played back to back.

## Switching the display

During playback, Press **[DISPLAY]**.

- The display switches each time **[DISPLAY]** is pressed.

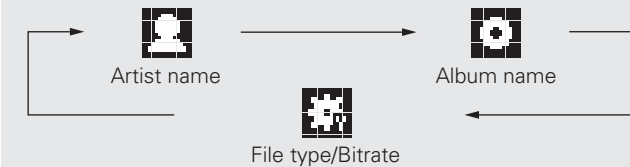



## AirPlay function

Enjoy music from your iTunes library with DENON quality sound anywhere in your home.

Use the Apple Remote app\* for iPhone and iPod touch to control iTunes from any room in your home.

\* Available as a free download from the App Store.

### Streaming music stored in iPhone or iPod touch directly to the unit

If you update your "iPhone/iPod touch" to iOS 4.2.1 or later, you can stream music stored in your "iPhone/iPod touch" directly to this unit.

**1 Start the music mode on the iPhone or iPod touch.**  
 is displayed on the iPhone or iPod touch screen.

**2 Tap the AirPlay icon**   
 Set "Network Standby" to "Network On" for this unit.

#### NOTE

When "Network Standby" is set to "Network On", the unit consumes more standby power.

**3 Select the speaker you want to use.**

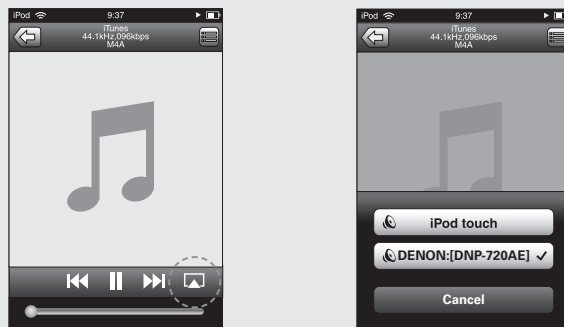

### Playing iTunes music on this unit

**1 Install iTunes 10, or later, on a Mac or PC that is connected to the same network as this unit.**

**2 Turn this unit ON.**  
 Set "Network Standby" to "Network On" for this unit.

#### NOTE

When "Network Standby" is set to "Network On", the unit consumes more standby power.

**3 Launch iTunes and click the AirPlay icon**   
 displayed in the lower right of the window and select this unit from the list.

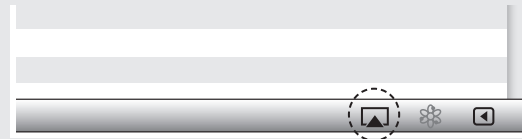

**4 Choose a song and click play in iTunes.**  
 The music will stream to this unit.

#### Multiple speakers

You can easily stream music from iTunes to multiple speakers in your home.

**1 Click the AirPlay icon**   
 and select "Multiple Speakers" from the list.

**2 Check the speakers you want to use.**

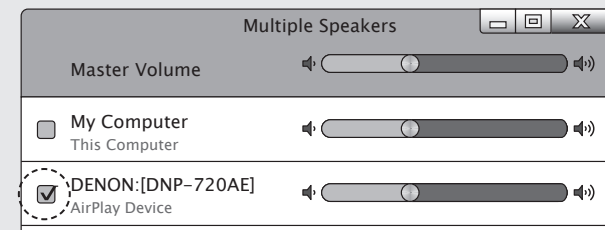

### Remote operations

You can use your DENON remote control to play and pause iTunes, as well as skip to next and previous tracks.

**1 Open Preferences in iTunes, and click "Devices".**

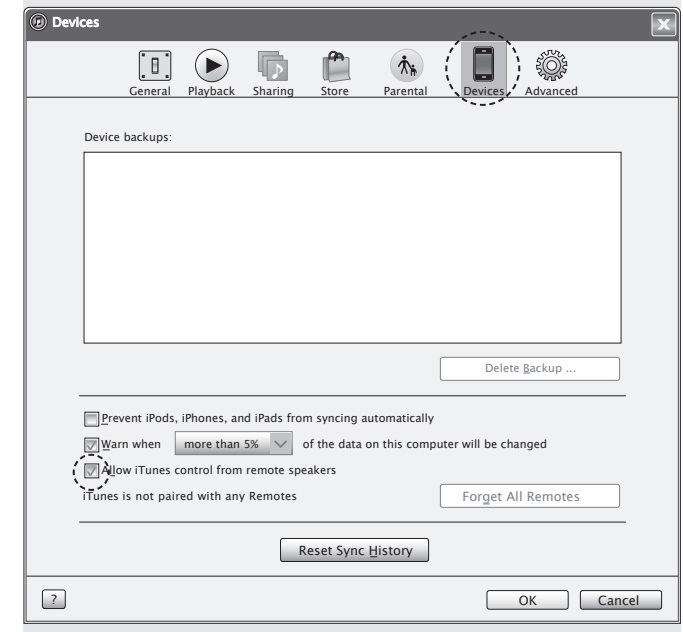

**2 Check "Allow iTunes control from remote speakers".**



- Source input will be switched to "USB/iPod" when AirPlay playback is started.
- You can stop AirPlay playback by pressing the < or choosing other input source.
- To see artist name or album name together, press the **[DISPLAY]**.
- For information about how to use iTunes, also see the Help for iTunes.
- The screen may differ depending on the OS and software versions.

# Advanced operations

## Menu map

Setting items	Detailed items	Description	Page		
<b>Network</b>  [Network] 1/9 ◆ Network First Setup ○:enter ◀:return	<b>Network First Setup</b>	Performs the network settings using a Wizard style window. For details on the operations, see the separate "Network setup guide".	-		
	<b>Connection</b>	<b>(Wired)</b>	Performs the settings for a wired or wireless LAN.	21	
			Performs the settings for a wired LAN.	21	
			<b>DHCP (On) or DHCP (Off)</b>	Performs the DHCP setting.	21
			<b>IP Address*1</b>	Performs the IP address setting.	21
			<b>Subnet Mask*1</b>	Performs the subnet mask setting.	21
			<b>Gateway*1</b>	Performs the gateway setting.	21
		<b>Primary DNS*1</b>	Performs the primary DNS setting.	21	
		<b>Secondary DNS*1</b>	Performs the secondary DNS setting.	21	
		<b>Proxy</b>	Performs the proxy setting.	22	
		<b>Connection</b>	Performs the wired LAN connection.	21	
		<b>(Wireless)</b>	Performs the wireless LAN connection setting.	22	
			<b>Search Access Point</b>	Selects and sets the wireless connections from the access point list.	22
	<b>WPS</b>		Sets the wireless connection using WPS.	23	
	<b>Manual Setting</b>	Sets the wireless connection manually.	23		
	<b>Last.fm Account</b>	Performs the Last.fm account setting again.	11		
	<b>Napster Account</b>	Performs the Napster account setting again.	12		
	<b>Last.fm Display</b>	Disables the display of Last.fm on the menu.	23		
	<b>Party Mode</b>	Performs the party mode function settings.	24		
		<b>Start Party</b>	Party mode starts.	24	
		<b>Stop Party*2</b>	Party mode stops.	24	
		<b>Party Mode Function</b>	Enable/disable the party mode function.	24	
	<b>Other Network</b>	Performs other network settings.	25		
<b>Network Standby</b>		Performs the ON/OFF settings for the network function when in standby mode.	25		
<b>PC Language</b>		Selects the language to be used for displaying the Internet sites.	26		
<b>Friendly Name Edit</b>		Edits a name displayed on the Internet.	26		
<b>Zone Management</b>		Display and control a maximum of 10 devices that are connected to the same network.	26		
<b>Update Notification</b>		Set the Update notification on/off.	27		
<b>Upgrade Notification</b>	Set the Upgrade notification on/off.	27			
<b>Network Info</b>	Displays various information about the network.	-			
<b>Other</b>	<b>Auto Standby</b>	Sets the unit power to standby when the unit is not in use.	27		
	<b>Firmware Update</b>	Updates the firmware.	28		
	<b>Add New Feature</b>	Displays new functions that can be downloaded, and upgrades functions.	28		
	<b>Language</b>	Sets the language.	29		
	 [Other] 1/5 ◆ Auto Standby ○:enter ◀:return				

\*1 Displayed when the "DHCP" setting (page 21) is "Off".

\*2 Displayed when "Party Mode" is performed.

## Symbols used to indicate buttons in this manual

- Button located on both the main unit and the remote control → **BUTTON**  
 Button only on the main unit → **<BUTTON>**  
 Button only on the remote control → **[BUTTON]**

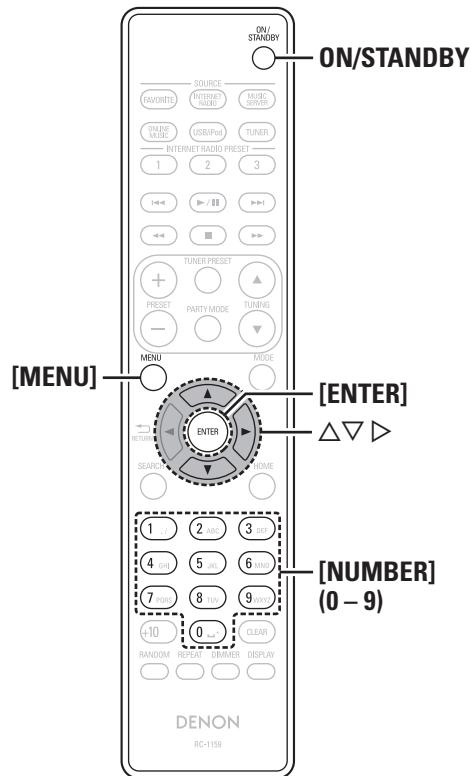
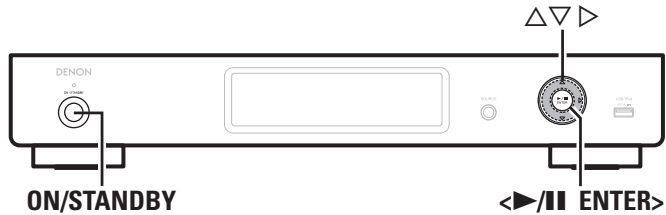

## Setting the network [Network]

- For details on “Network First Setup” operations, see the separate “Network setup guide”.
- If you cancelled “Network First Setup” menu or changed the network environment, perform “Menu” – “Network” – “Network First Setup”.

### Connecting wired LAN

Use this procedure to configure the wired LAN settings.

#### Network connecting (when “DHCP” settings are “On”)

When using this unit with the broadband router’s DHCP function enabled, this unit automatically performs the IP address setting and other settings.

#### 1 Connect the ETHERNET cable (page 6 “Connecting to a home network (LAN)”).

#### 2 Press ON/STANDBY to turn on power to the main unit.

#### 3 Press [MENU].

Turns on the Menu settings mode and the Menu appears on the display (page 20 “Menu map”).

#### 4 Use △▽ to select “Network” – “Connection” – “DHCP (On)”, then press [ENTER], <▶/|| ENTER> or ▷.

“Select DHCP” menu appears.

#### 5 Use △▽ to select “On”, then press [ENTER], <▶/|| ENTER> or ▷.

“Setup Wired” menu appears.

#### 6 Use △▽ to select “Connection”, then press [ENTER], <▶/|| ENTER> or ▷.

“Connecting” is displayed, and the unit starts connecting to the LAN.

- When the connection is made successfully, “Succeeded” appears.
- If the connection cannot be established, “Connection Failed” is displayed. Perform steps 1 – 5 again.



You may need to set the network connection manually, depending on the provider you use. To set the connection manually, use the setting procedure of “Network connecting (when “DHCP” settings are “Off”)”.

#### Network connecting (when “DHCP” settings are “Off”)

This section explains the settings when connecting this unit to a network that does not have a DHCP function.



To configure the settings manually, check the setting details with your network administrator.

#### 1 Perform steps 1 – 4 of the “Network connecting (when “DHCP” settings are “On”)” procedure and select “Off” in step 5.

“Select DHCP” menu appears.

#### 2 Use △▽ to select “IP Address”, then press [ENTER], <▶/|| ENTER> or ▷.

“Input IP Address” menu appears.

#### 3 Use △▽▷ or [NUMBER] (0 – 9) to input the IP address and press [ENTER] or <▶/|| ENTER>.

#### 4 Use △▽▷ or [NUMBER] (0 – 9) to input the address for “Subnet Mask”, “Gateway”, “Primary DNS”, and “Secondary DNS”.

#### 5 Use △▽ to select “Connection”, then press [ENTER], <▶/|| ENTER> or ▷.

“Connecting” is displayed, and the unit starts connecting to the LAN.

- When the connection is made successfully, “Succeeded” appears.
- If the connection cannot be established, “Connection Failed” is displayed. Perform steps 1 – 4 again.

**Symbols used to indicate buttons in this manual**

Button located on both the main unit and the remote control → **BUTTON**

Button only on the main unit → **<BUTTON>**

Button only on the remote control → **[BUTTON]**

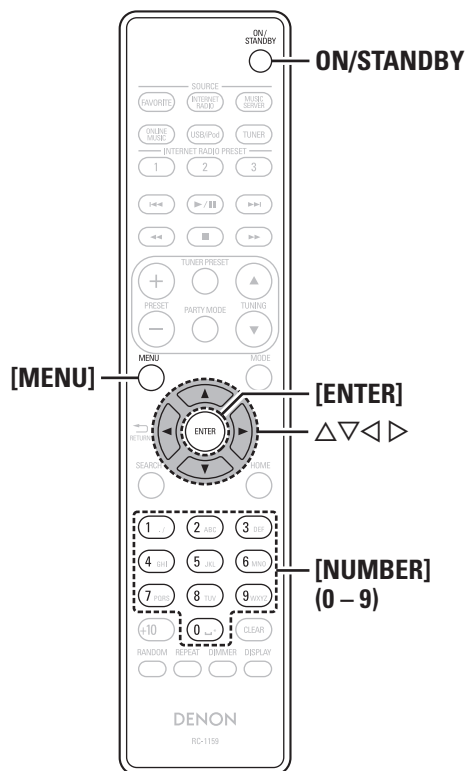
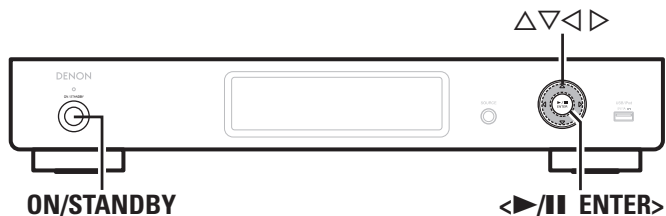

**Proxy settings**

Configure these settings to connect to the internet via a proxy server.

- 1** Press **[MENU]**.  
Turns on the Menu settings mode and the Menu appears on the display (page 20 "Menu map").
- 2** Use **Δ∇** to select "Network" – "Connection" – "Proxy", then press **[ENTER]**, **<▶/|| ENTER>** or **▷**.  
"Setup Proxy" menu appears.
- 3** If "Proxy(On)" appears, go to step 5.  
If "Proxy(Off)" appears, press **[ENTER]**, **<▶/|| ENTER>** or **▷**.  
"Select Proxy" menu appears.
- 4** Use **Δ∇** to select "On", then press **[ENTER]**, **<▶/|| ENTER>** or **▷**.  
"Setup Proxy" menu appears.
- 5** Use **Δ∇** to select "Proxy (Address)" or "Proxy (Name)", then press **[ENTER]**, **<▶/|| ENTER>** or **▷**.  
"Select Type" menu appears.
- 6** Use **Δ∇** to select "Address" or "Name", then press **[ENTER]**, **<▶/|| ENTER>** or **▷**.  
"Setup Proxy" menu appears.
- 7** Use **Δ∇** to select "Address" or "Name", then press **[ENTER]**, **<▶/|| ENTER>** or **▷**.  
"Input Proxy Address" or "Input Proxy Name" menu appears.
- 8** Use **Δ∇▷** or **[NUMBER] (0-9)** to input the address or name, then press **[ENTER]** or **<▶/|| ENTER>**.  
"Setup Proxy" menu appears.
- 9** Use **Δ∇** to select "Port", then press **[ENTER]**, **<▶/|| ENTER>** or **▷**.  
"Input Proxy Port" menu appears.
- 10** Use **Δ∇▷** or **[NUMBER] (0-9)** to input the port, then press **[ENTER]** or **<▶/|| ENTER>**.  
The Proxy settings are completed.

**Connecting wireless LAN**

Use this procedure to configure the wireless LAN settings.

**Search Access Point (Wireless LAN)**

- 1** Fitting a rod antenna (page 6 "Connecting to a home network (LAN)").  
• If a LAN cable is connected, remove it.
  - 2** Press **ON/STANDBY** to turn on power to the main unit.
  - 3** Press **[MENU]**.  
Turns on the menu settings mode and the menu appears on the display (page 20 "Menu map").
  - 4** Use **Δ∇** to select "Network" – "Connection" – "Search Access Point", then press **[ENTER]**, **<▶/|| ENTER>** or **▷**.  
The access point you have set is displayed.
  - 5** Use **Δ∇** to select the access point, and then press **[ENTER]**, **<▶/|| ENTER>** or **▷**.  
• If the access point is not detected automatically, configure it manually (page 23 "Manual Settings").
  - 6** If there is an encryption setting for the access point you selected in step 5, enter same encryption key as used for the access point. (If there is no encryption setting, proceed to step 7.)  
Use **Δ∇◁▷** to input the "Key" (encryption key) and press **[ENTER]**, **<▶/|| ENTER>** or **▷**. Enter the same encryption key as used for the access point.  
• The types of characters that can be input are as shown below.
- [Lower case characters]**  
abcdefghijklmnopqrstuvwxyz

**[Upper case characters]**  
ABCDEFGHIJKLMNOPQRSTUVWXYZ

**[Symbols]** ! " # \$ % & ' ( ) \* + , - . / : ; < = > ? @ [ \ ] ^ \_ ` { | } ~

**[Numbers]** 0 1 2 3 4 5 6 7 8 9 (Space)
- When no security settings have been used in the Internet connection settings, this step is not necessary.

**7** Use  $\nabla$  to select “Connection”, then press [ENTER],  $\blacktriangleleft/\blacksquare$  ENTER or  $\blacktriangleright$ .

“Connecting” is displayed, and the unit starts connecting to the network.

- This unit performs automatic network setup due to the DHCP function.

#### ❑ WPS Settings (Push-button method)

**1** Press [MENU].

Turns on the Menu settings mode and the Menu appears on the display (☞ page 20 “Menu map”).

**2** Use  $\Delta\nabla$  to select “Network” – “Connection” – “WPS” – “Push Button”, then press [ENTER],  $\blacktriangleleft/\blacksquare$  ENTER or  $\blacktriangleright$ .

**3** Use  $\Delta\nabla$  to select “Enter”, then press [ENTER],  $\blacktriangleleft/\blacksquare$  ENTER or  $\blacktriangleright$ .

**4** Press the WPS button on the access point.  
When connection is established with access point, “Succeeded” is displayed.

#### ❑ WPS Settings (PIN code method)

**1** Press [MENU].

Turns on the Menu settings mode and the Menu appears on the display (☞ page 20 “Menu map”).

**2** Use  $\Delta\nabla$  to select “Network” – “Connection” – “WPS” – “PIN code”, then press [ENTER],  $\blacktriangleleft/\blacksquare$  ENTER or  $\blacktriangleright$ .

The access point you have set is displayed.

**3** Use  $\Delta\nabla$  to select the access point whose PIN code you want to display, and press [ENTER],  $\blacktriangleleft/\blacksquare$  ENTER or  $\blacktriangleright$ .

PIN code number is displayed.

**4** Set this PIN code to the register.

When connection is established with access point, “Succeeded” is displayed.

#### ❑ Manual Settings

**1** Press [MENU].

Turns on the Menu settings mode and the Menu appears on the display (☞ page 20 “Menu map”).

**2** Use  $\Delta\nabla$  to select “Network” – “Connection” – “Manual Setting”, then press [ENTER],  $\blacktriangleleft/\blacksquare$  ENTER or  $\blacktriangleright$ .

**3** Use  $\Delta\nabla$  to select “SSID”, then press [ENTER],  $\blacktriangleleft/\blacksquare$  ENTER or  $\blacktriangleright$ .

**4** Use  $\Delta\nabla\blacktriangleleft$  to input the name of the wireless network (SSID), then press [ENTER] or  $\blacktriangleleft/\blacksquare$  ENTER.

- The types of characters that can be input are as shown below.

[Lower case characters]

abcdefghijklmnopqrstuvwxy

[Upper case characters]

ABCDEFGHIJKLMNQRSTUvwxyz

[Symbols] ! " # \$ % & ' ( ) \* + , - . / : ; < = > ? @ [ \ ] ^ \_ ` { | } ~

[Numbers] 0123456789 (Space)

**5** Use  $\Delta\nabla$  to select “Security”, then press [ENTER],  $\blacktriangleleft/\blacksquare$  ENTER or  $\blacktriangleright$ .

**6** Use  $\Delta\nabla$  to select following items, then press [ENTER],  $\blacktriangleleft/\blacksquare$  ENTER or  $\blacktriangleright$ .

- **None** Select if not encrypted. Can also be used even without encryption, through we recommend encryption for improved security.

• **WEP** / **WPA(TKIP)** / **WPA(AES)** / **WPA2(TKIP)** / **WPA2(AES)**

Select the encryption method according to the encryption setting of the access point you are using.

**7** Use  $\Delta\nabla$  to select “Key”, then press [ENTER] or  $\blacktriangleleft/\blacksquare$  ENTER.

Enter the same encryption key as used for the access point.

- When no security settings have been used in the Internet connection settings, this step is not necessary.
- When connecting to a “WEP” encrypted network, set the access point “Default Key” to “1”.

**8** Use  $\Delta\nabla\blacktriangleleft$  to enter the encryption key, and press [ENTER] or  $\blacktriangleleft/\blacksquare$  ENTER.

**9** Use  $\nabla$  to select “Connection” and press [ENTER],  $\blacktriangleleft/\blacksquare$  ENTER or  $\blacktriangleright$ .

“Connecting” is displayed, and the unit starts connecting to the network.

- This unit performs automatic network setup due to the DHCP function.

#### Last.fm Display

Set whether or not to display Last.fm item on the menu.

**1** Press [MENU].

Turns on the Menu settings mode and the Menu appears on the display (☞ page 20 “Menu map”).

**2** Use  $\Delta\nabla$  to select “Network” – “Last.fm Display”, then press [ENTER],  $\blacktriangleleft/\blacksquare$  ENTER or  $\blacktriangleright$ .  
“Last.fm Display” appears.

**3** Use  $\Delta\nabla$  to select “Display” or “Hidden”, then press [ENTER],  $\blacktriangleleft/\blacksquare$  ENTER or  $\blacktriangleright$ .

**Display** Last.fm items will be displayed.

**Hidden** Last.fm items will not be displayed.

**Symbols used to indicate buttons in this manual**

Button located on both the main unit and the remote control → **BUTTON**

Button only on the main unit → **<BUTTON>**

Button only on the remote control → **[BUTTON]**

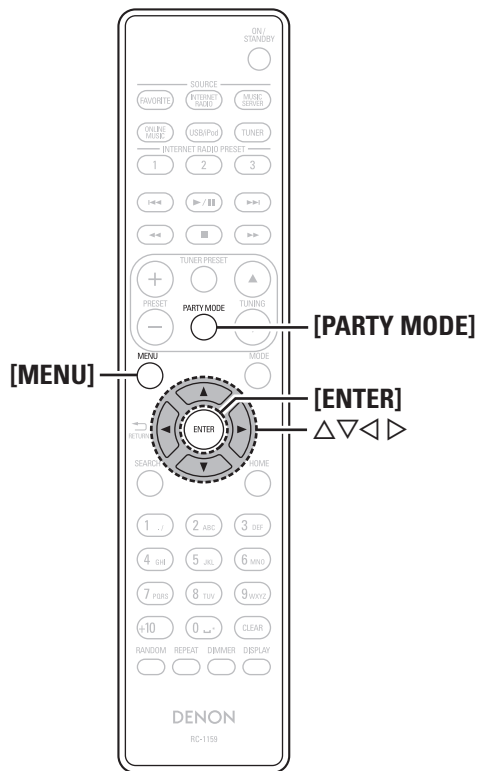
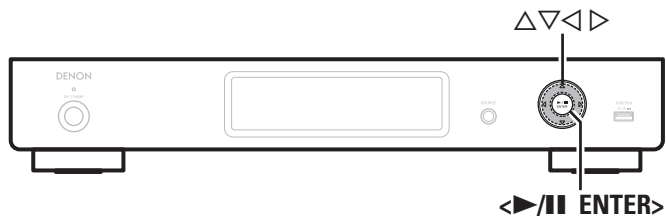

## Party Mode Function

The same network audio (Internet radio, music server or iPod) can be played on multiple products equipped with the Party Mode function and connected in a network.

The party mode consists of one organizer and up to four attendees. When one unit starts the party mode as the organizer, up to four devices on which the party mode function is activated automatically participate in the party as attendees. "Party Mode Function" must be set to "On" ahead of time in order to use the party mode function.

### Setting the Party Mode Function

- 1** Press **[PARTY MODE]**.  
"Party Mode" menu appears.
- 2** Use  $\Delta \nabla$  to select "Party Mode Function", then press **[ENTER]**,  $\blacktriangleleft/\text{II ENTER}$  or  $\blacktriangleright$ .  
"Party Mode Function" menu appears.
- 3** Use  $\Delta \nabla$  to select "On" or "Off", then press **[ENTER]**,  $\blacktriangleleft/\text{II ENTER}$  or  $\blacktriangleright$ .

- On** Enable party mode function.
- Off** Disable party mode function.

### Starting the party mode as the organizer

- 1** Press **[PARTY MODE]**.  
"Party Mode" menu appears.
- 2** Use  $\Delta \nabla$  to select "Start Party", then press **[ENTER]**,  $\blacktriangleleft/\text{II ENTER}$  or  $\blacktriangleright$ .

- The display switches to the input source selection screen.
- If there are other devices on the same network with the party mode function enabled, they are automatically selected as attendees.
- "No Network Connection" is displayed when you are not connected to a network.

- 3** Play the desired station.

### Canceling the party mode

- 1** Press **[PARTY MODE]**.  
"Party Mode" menu appears.
- 2** Use  $\Delta \nabla$  to select "Stop Party", then press **[ENTER]**,  $\blacktriangleleft/\text{II ENTER}$  or  $\blacktriangleright$ .  
"Exit Party Mode?" is displayed on the menu screen.
- 3** Use  $\Delta \nabla$  to select "Yes", then press **[ENTER]**,  $\blacktriangleleft/\text{II ENTER}$  or  $\blacktriangleright$ .  
"Attendee P.Off?" is displayed.
- 4** Use  $\Delta \nabla$  to select "Yes" or "No", then press **[ENTER]**,  $\blacktriangleleft/\text{II ENTER}$  or  $\blacktriangleright$ .

- Yes** The power of the attendees is turned off and the party mode is canceled.
- No** The party mode is canceled without turning off the power of the attendees.

## ❑ Participating in the party mode as an attendee

- When the organizer starts the party mode, up to four attendees are selected automatically. No operation is required.
- When a device becomes an attendee, “Party Mode Attendee” appears on the display. The input source automatically switches to “Music Server” and the same network audio as on the organizer is played.
- If there are fewer than four attendees, a device can join the party mode after it has started. To participate in the party mode, perform the operation described below.

**1** Press [PARTY MODE].  
“Party Mode” menu appears.

**2** Use  $\Delta$ / $\nabla$  to select “Start Party”, then press [ENTER],  $\blacktriangleleft$ /|| ENTER> or  $\blacktriangleright$ .

- “No Network Connection” is displayed when you are not connected to a network.

## Selecting tracks from attendees

When the party mode starts, “Party Mode Attendee” appears on the attendee’s display, after which the organizer’s playback information appears.



Party Mode Display    Attendee Display

**1** Press  $\blacktriangleleft$  to display the organizer’s input source.

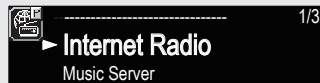

**2** Press  $\Delta$ / $\nabla$  to select the input source, then press [ENTER],  $\blacktriangleleft$ /|| ENTER> or  $\blacktriangleright$ .

**3** Press  $\Delta$ / $\nabla$  to select the item you want to play, then press [ENTER],  $\blacktriangleleft$ /|| ENTER> or  $\blacktriangleright$ .

## Canceling the party mode

**1** Press [PARTY MODE].  
“Party Mode” menu appears.

**2** Use  $\Delta$ / $\nabla$  to select “Stop Party”, then press [ENTER],  $\blacktriangleleft$ /|| ENTER> or  $\blacktriangleright$ .  
“Exit Party Mode?” is displayed.

**3** Use  $\Delta$ / $\nabla$  to select “Yes”, then press [ENTER],  $\blacktriangleleft$ /|| ENTER> or  $\blacktriangleright$ .  
In this case, the other devices remain in the party mode.



- “Last.fm”, “Napster” and “USB” are not available in the Party Mode.
- There can only be one organizer in the network. To form a new party mode, first cancel the current party mode.

## Other network settings

### ❑ Network Standby

Set the network function On/Off during standby.

**1** Press [MENU].

Turns on the Menu settings mode and the Menu appears on the display (see page 20 “Menu map”).

**2** Use  $\Delta$ / $\nabla$  to select “Network” – “Other Network” – “Network Standby”, then press [ENTER],  $\blacktriangleleft$ /|| ENTER> or  $\blacktriangleright$ .  
“Network Standby” menu appears.

**3** Use  $\Delta$ / $\nabla$  to “Network On”, then press [ENTER],  $\blacktriangleleft$ /|| ENTER> or  $\blacktriangleright$ .

- Network On** Network is on during standby. Main unit operable with a network compatible controller. Shortens the time before the network connection is completed.
- When “Network Standby” is set to “Network On”, the power display lights orange.
  - More power is consumed when in standby (Power consumption: 7.5 W).

- Network Off** Suspend network function during standby. It will take slightly longer till the network connection is completed.
- The minimum amount of power is consumed when in standby (Power consumption: 0.2 W).
  - This is the default setting.

**4** Press [MENU].

The display returns to normal.

**Symbols used to indicate buttons in this manual**

- Button located on both the main unit and the remote control → **BUTTON**
- Button only on the main unit → **<BUTTON>**
- Button only on the remote control → **[BUTTON]**

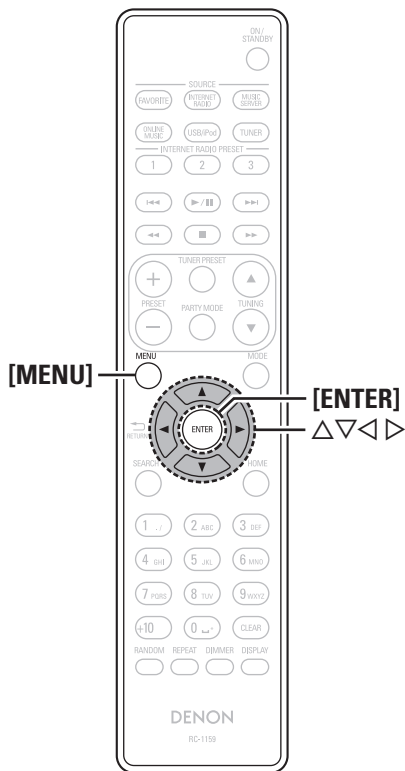
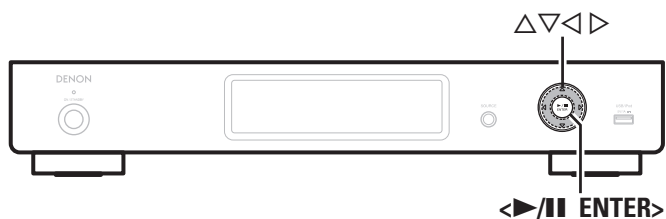

**PC Language**

Selects the language to be used for displaying the Internet sites.

- 1 Press [MENU].**  
Turns on the Menu settings mode and the Menu appears on the display (☞ page 20 "Menu map").
- 2 Use  $\Delta$ / $\nabla$  to select "Network" – "Other Network" – "PC Language", then press [ENTER],  $\blacktriangleleft$ /[ENTER] or  $\blacktriangleright$ .**  
"PC Language" setting menu appears.
- 3 Use  $\Delta$ / $\nabla$  to select computer environment language, then press [ENTER],  $\blacktriangleleft$ /[ENTER] or  $\blacktriangleright$ .**

**Friendly Name Edit**

The Friendly Name is the name of this unit displayed on the network (Maximum 63 characters).

- 1 Press [MENU].**  
Turns on the Menu settings mode and the Menu appears on the display (☞ page 20 "Menu map").
- 2 Use  $\Delta$ / $\nabla$  to select "Network" – "Other Network" – "Friendly Name Edit", then press [ENTER],  $\blacktriangleleft$ /[ENTER] or  $\blacktriangleright$ .**  
"Friendly Name Edit" menu appears.
- 3 Select the friendly name (DENON:[DNP-720AE]), and press [ENTER],  $\blacktriangleleft$ /[ENTER] or  $\blacktriangleright$ .**
- 4 Edit a friendly name.**

• For character input, see page 31.

**Zone Management Function**

The status of devices connected to the same network can be displayed. Additionally, network menu browsers can be used via the network for the connected devices. This is useful when playing back network services of a device located in a separate room.

Only devices compatible with the Zone Management function can be operated. With the Zone Management function, the network menu screen and playback screen of the target device to be controlled are displayed but playback with this unit is not possible. If you also want to play the same music as the other device, use the Party Mode function.

- 1 Press [MENU].**  
Turns on the Menu settings mode and the Menu appears on the display (☞ page 20 "Menu map").
- 2 Press  $\Delta$ / $\nabla$  to select "Network" – "Other Network" – "Zone Management", and then press [ENTER],  $\blacktriangleleft$ /[ENTER] or  $\blacktriangleright$ .**  
• A maximum of 10 DENON devices connected to the same network as this unit can be displayed.
- 3 Press  $\Delta$ / $\nabla$  to select the device, and then press [ENTER],  $\blacktriangleleft$ /[ENTER] or  $\blacktriangleright$ .**
- 4 Press  $\Delta$ / $\nabla$  to select "Device Control", and then press [ENTER],  $\blacktriangleleft$ /[ENTER] or  $\blacktriangleright$ .**  
The network menu of the other device is displayed on this unit's display.
- 5 Press  $\Delta$ / $\nabla$ , [ENTER],  $\blacktriangleleft$ /[ENTER] or  $\blacktriangleright$  to select the desired track.**

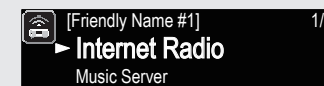

• For information about how to operate, refer to the documentation for each function.



## Update Notification

Displays a notification message on this unit's menu screen when the latest firmware is released with "Firmware Update".

Connect to broadband Internet (🔧 page 6) when using this function.

**1 Press [MENU].**  
Turns on the Menu settings mode and the Menu appears on the display (🔧 page 20 "Menu map").

**2 Use  $\Delta$ / $\nabla$  to select "Network" – "Other Network" – "Update Notification", then press [ENTER],  $\blacktriangleleft$ / $\blacktriangleright$  [ENTER] or  $\blacktriangleright$ .**  
"Update Notification" menu appears.

**3 Use  $\Delta$ / $\nabla$  to "On", then press [ENTER],  $\blacktriangleleft$ / $\blacktriangleright$  [ENTER] or  $\blacktriangleright$ .**

**On** Display update message.

**Off** Do not display update message.



- When you press [ENTER] or  $\blacktriangleleft$ / $\blacktriangleright$  [ENTER] during display of the notification message, the "Check for Update" is displayed. (Refer to page 28 for more information on "Firmware Update".)
- Press  $\blacktriangleleft$  to erase the notification message.

## Upgrade Notification

Display a notification message on this unit's menu screen when downloadable firmware is released with "Add New Feature".

Connect to broadband Internet (🔧 page 6) when using this function.

**1 Press [MENU].**  
Turns on the Menu settings mode and the Menu appears on the display (🔧 page 20 "Menu map").

**2 Use  $\Delta$ / $\nabla$  to select "Network" – "Other Network" – "Upgrade Notification", then press [ENTER],  $\blacktriangleleft$ / $\blacktriangleright$  [ENTER] or  $\blacktriangleright$ .**  
"Upgrade Notification" menu appears.

**3 Use  $\Delta$ / $\nabla$  to "On", then press [ENTER],  $\blacktriangleleft$ / $\blacktriangleright$  [ENTER] or  $\blacktriangleright$ .**

**On** Display upgrade message.

**Off** Do not display upgrade message.



- When you press [ENTER] or  $\blacktriangleleft$ / $\blacktriangleright$  [ENTER] during display of the notification message, the "Add New Feature" is displayed. (Refer to page 28 for more information on "Add New Feature".)
- Press  $\blacktriangleleft$  to erase the notification message.



## Setting the others [Other]

### Auto Standby

With the Auto Standby ON, this unit will automatically enter the standby mode after about 30 continuous minutes of stop mode with no operation.

- The default setting is "Off".

**1 Press [MENU].**  
Turns on the Menu settings mode and the Menu appears on the display (🔧 page 20 "Menu map").

**2 Use  $\Delta$ / $\nabla$  to select "Other" – "Auto Standby", then press [ENTER],  $\blacktriangleleft$ / $\blacktriangleright$  [ENTER] or  $\blacktriangleright$ .**  
"Select Auto Standby" menu appears.

**3 Use  $\Delta$ / $\nabla$  to select "On", then press [ENTER],  $\blacktriangleleft$ / $\blacktriangleright$  [ENTER] or  $\blacktriangleright$ .**  
The setting is entered.

#### NOTE

In the following situations, the Auto standby function does not operate.

- When an iPod or USB memory device is connected to the USB/iPod port on the unit.
- When the input source is "TUNER".
- When the input source being played is "Internet Radio", "Music Server", "Last.fm" or "Napster".

**Symbols used to indicate buttons in this manual**

- Button located on both the main unit and the remote control → **BUTTON**
- Button only on the main unit → **<BUTTON>**
- Button only on the remote control → **[BUTTON]**

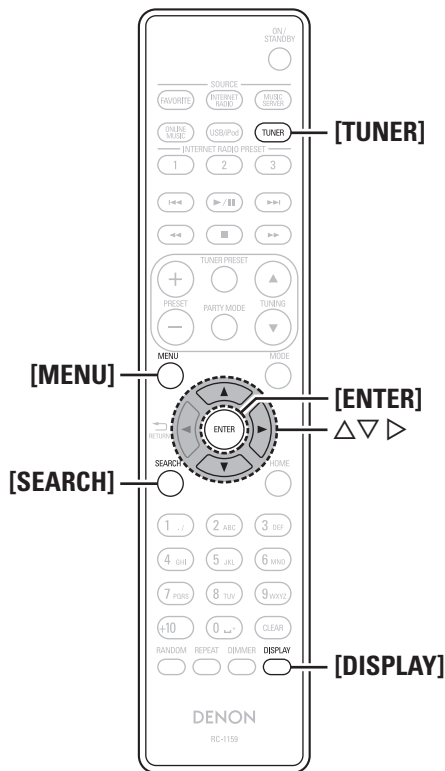
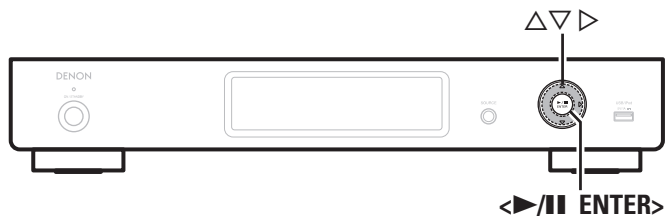

## Firmware Update

- In order to update the firmware, the environment and settings required for connecting to broadband internet are needed (☞ page 6).
- Perform the firmware update operation after at least 2 minutes has elapsed since turning this unit's power ON.

**1 Press [MENU].**  
Turns on the Menu settings mode and the Menu appears on the display (☞ page 20 "Menu map").

**2 Use  $\Delta \nabla$  to select "Other" – "Firmware Update", then press [ENTER],  $\blacktriangleleft$ /|| ENTER or  $\blacktriangleright$ .**

**Check for Update** Check for firmware updates. You can also check approximately how long it will take to complete an update.

**Start** Execute the update process.

- If updating fails, the set automatically retries, but if updating is still not possible, one of the messages shown below is displayed. If the display reads as shown below, check the settings and network environment, then update again.

Display	Description
<b>Updating fail</b>	Updating failed.
<b>Login failed</b>	Failure to log into server.
<b>Server is busy</b>	Server is busy. Wait a while then try again.
<b>Connection fail</b>	Failure in connecting to server.
<b>Download fail</b>	Downloading of the firmware has failed.

## Add New Feature

- In order to add new functions, the environment and settings required for connecting to broadband internet are needed (☞ page 6).
- Perform the add new feature operation after at least 2 minutes has elapsed since turning this unit's power on.

**1 Press [MENU].**  
Turns on the Menu settings mode and the Menu appears on the display (☞ page 20 "Menu map").

**2 Use  $\Delta \nabla$  to select "Other" – "Add New Feature", then press [ENTER],  $\blacktriangleleft$ /|| ENTER or  $\blacktriangleright$ .**

**Start Upgrade** Execute the upgrade process.

- If the upgrade is not successful, an error message identical to those in "Firmware Update" (☞ page 28) will appear on the display. Check the settings and network environment, then update again.

**Upgrade Status** Display a list of the additional functions provided by the upgrade.

**Upgrade ID** The ID number shown on this screen is needed when carrying out the procedure.



See the DENON website for details about updates. When the procedure is complete, "Registered" is displayed and updates can be carried out. If the procedure has not been carried out, "Not Registered" is displayed.

### [Notes concerning use of "Firmware Update" and "Add New Feature"]

- Do not turn off the power until updating or upgrading is completed.
- Even with a broadband connection to the Internet, approximately 20 minutes is required for the updating/upgrading procedure to be completed.
- Once updating/upgrade starts, normal operations on this unit cannot be performed until updating/upgrading is completed.
- Furthermore, updating/upgrading the firmware may reset the backup data for the parameters, etc. set for this unit.
- If the update or upgrade fails, remove and re-insert the power cord. "UPDATE RETRY" appears on the display and update restarts from the point at which update failed. If the error continues despite this, check the network environment.



- Information regarding the “Firmware Update” function and “Add New Feature” will be announced on the DENON web site each time related plans are defined.
- When usable new firmware is released with “Firmware Update” or “Add New Feature”, a notification message is displayed on the menu screen. When you do not want to be notified, set “Update Notification” (☞ page 27) and “Upgrade Notification” (☞ page 27) to “Off”.

## Language

Sets the language for display the menu.

- The factory language setting is “English”.

### 1 Press [MENU].

Turns on the Menu settings mode and the Menu appears on the display (☞ page 20 “Menu map”).

### 2 Use $\Delta$ / $\nabla$ to select “Other” – “Language”, then press [ENTER], $\blacktriangleleft$ /|| ENTER or $\blacktriangleright$ .

English / Deutsch / Français / Italiano / Nederlands

## Tuning in radio stations

### RDS (Radio Data System)

Note that the RDS function only works when receiving RDS compatible stations.

RDS (works only on the FM band) is a broadcasting service which allows a station to send additional information along with the regular radio program signal.

The following four types of RDS information can be received with this unit:

#### RDS Search

Use this function to automatically tune to FM stations that provide the RDS service.

### 1 Press [TUNER] to switch the input source to “TUNER (FM)”.

- For details on selecting the input source using the unit buttons, see “Selecting the input source using unit operations” (☞ page 8).

### 2 Press [SEARCH].

### 3 Use $\Delta$ / $\nabla$ to select “RDS Search”, then press [ENTER], $\blacktriangleleft$ /|| ENTER or $\blacktriangleright$ .

Automatically begin the RDS search operation.

- If no RDS station is found, “No Programme” is displayed.

### Viewing information during reception

Press [DISPLAY] while receiving a RDS to display the information currently being broadcast.

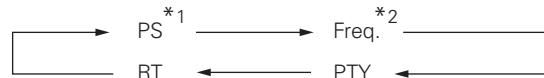

\*1 Program service name

- If a station name is entered, it is displayed.

\*2 Frequency

### PTY (Program Type)

PTY identifies the type of RDS program.

The program types and their displays are as follows:

<b>NEWS</b>	News	<b>WEATHER</b>	Weather
<b>AFFAIRS</b>	Current Affairs	<b>FINANCE</b>	Finance
<b>INFO</b>	Information	<b>CHILDREN</b>	Children's programmes
<b>SPORT</b>	Sports	<b>SOCIAL</b>	Social Affairs
<b>EDUCATE</b>	Education	<b>RELIGION</b>	Religion
<b>DRAMA</b>	Drama	<b>PHONE IN</b>	Phone In
<b>CULTURE</b>	Culture	<b>TRAVEL</b>	Travel
<b>SCIENCE</b>	Science	<b>LEISURE</b>	Leisure
<b>VARIED</b>	Varied	<b>JAZZ</b>	Jazz Music
<b>POP M</b>	Pop Music	<b>COUNTRY</b>	Country Music
<b>ROCK M</b>	Rock Music	<b>NATION M</b>	National Music
<b>EASY M</b>	Easy Listening Music	<b>OLDIES</b>	Oldies Music
<b>LIGHT M</b>	Light Classical	<b>FOLK M</b>	Folk Music
<b>CLASSICS</b>	Serious Classical	<b>DOCUMENT</b>	Documentary
<b>OTHER M</b>	Other Music		

#### PTY Search

Use this function to find RDS stations broadcasting a designated program type (PTY).

For a description of each program type, refer to “PTY (Program Type)”.

### 1 Press [TUNER] to switch the input source to “TUNER (FM)”.

- For details on selecting the input source using the unit buttons, see “Selecting the input source using unit operations” (☞ page 8).

### 2 Press [SEARCH].

### 3 Use $\Delta$ / $\nabla$ to select “PTY Search”, then press [ENTER], $\blacktriangleleft$ /|| ENTER or $\blacktriangleright$ .

### 4 Use $\Delta$ / $\nabla$ to call out the desired program type, then press [ENTER], $\blacktriangleleft$ /|| ENTER or $\blacktriangleright$ .

Automatically begin the PTY search operation.

- If no program of the specified type is found, “No Programme” is displayed.

**Symbols used to indicate buttons in this manual**

- Button located on both the main unit and the remote control → **BUTTON**
- Button only on the main unit → **<BUTTON>**
- Button only on the remote control → **[BUTTON]**

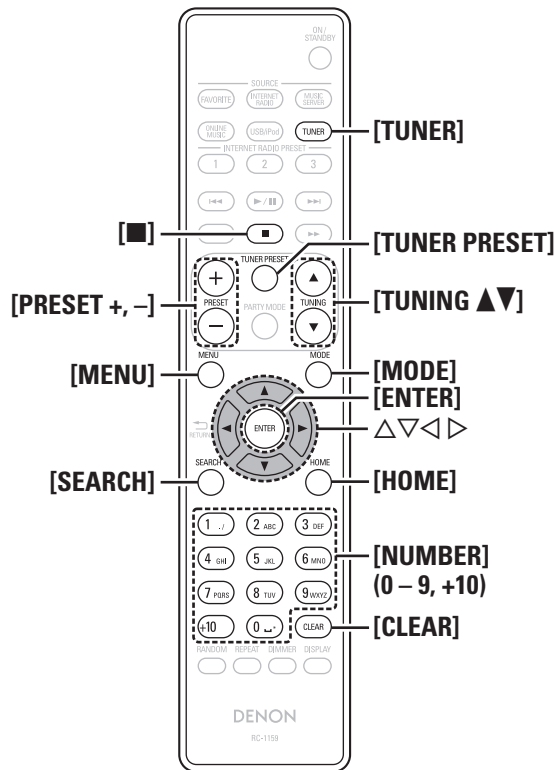
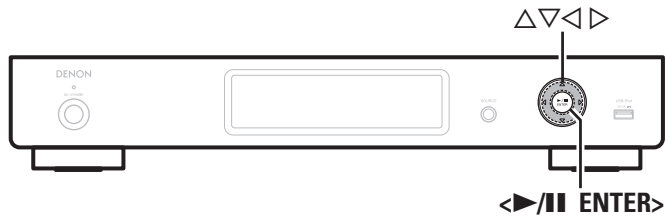

## TP (Traffic Program)

TP identifies programs that carry traffic announcements. This allows you to easily find out the latest traffic conditions in your area before leaving home.

### TP Search

Use this function to find RDS stations broadcasting traffic programs (TP stations).

#### 1 Press [TUNER] to switch the input source to "TUNER (FM)".

- For details on selecting the input source using the unit buttons, see "Selecting the input source using unit operations" (page 8).

#### 2 Press [SEARCH].

#### 3 Use ▲▼ to select "TP Search", then press [ENTER], <ENTER> or ▷.

Automatically begin the TP search operation.

- "No Programme" is displayed when there is no traffic information broadcast station.

## RT (Radio Text)

RT allows RDS stations to send text messages that appear on the display.



- When the RT mode is turned on while an RDS broadcast station not offering an RT service is tuned in, "NO TEXT" is displayed on the display.
- The RT mode cannot be set in the AM band or for FM stations not offering RDS broadcasts.

### NOTE

The operations described below selecting "RDS Search" will not function in areas in which there are no RDS broadcasts.

### Tuner (FM/AM) operation

Operation buttons	Function
PRESET +, -	Preset channel selection
TUNER PRESET	Preset menu
■	Stop
TUNING ▲▼	Tuning (up/down)
MENU	Menu
MODE	Switch search modes
▲▼◀▶	Cursor operation (Up/Down/Left/Right)
ENTER	Enter
SEARCH	RDS search / PTY search / TP search / Auto preset
HOME	Return to top page
0 - 9, +10	Preset channel selection

## Other functions

### Inputting characters

On this unit, the names displayed for "Giving station names to preset channels" (page 14), "Napster Account" (page 12) and "Last.fm Account" (page 11) etc., screens can be changed as desired.

For inputting characters, there are two methods, as shown below.

Method	Operations
<b>Using the number buttons</b>	<ul style="list-style-type: none"> <li>Operating with the remote control unit.</li> <li>Multiple characters are assigned to a button, and each time the button is pressed, a character is switched.</li> </ul>
<b>Using the cursor buttons</b>	<ul style="list-style-type: none"> <li>Operating with the remote control unit or the main unit.</li> <li>Use <math>\Delta</math> <math>\nabla</math> <math>\triangleleft</math> <math>\triangleright</math> and <b>[ENTER]</b> or <b>&lt;▶/   ENTER&gt;</b> to input characters.</li> </ul>

#### □ Display of an input screen

##### [Preset name input]



##### [Account input]



### Using the number buttons

#### 1 Display the screen for inputting characters.

#### 2 Place the cursor at the character to be changed with $\triangleleft$ $\triangleright$ and press **[NUMBER] (0 – 9)** until the desired character is displayed.

• The types of characters that can be input are as shown below.

1 . /	1. @ - _ / : ~	6 MNO	m n o M N O 6
2 ABC	a b c A B C 2	7 PQRS	p q r s P Q R S 7
3 DEF	d e f D E F 3	8 TUV	t u v T U V 8
4 GHI	g h i G H I 4	9 WXYZ	w x y z W X Y Z 9
5 JKL	j k l J K L 5	0 _	0 (Space) ! " # \$ % & ' ( ) * + , ; < = > ? [ \ ] ^ ` {   }

- The input character type can be switched by pressing **[MODE]** while the display name is being changed.
- Press **[CLEAR]** to delete the character.
- For entering the characters assigned to one number button continuously, press  $\triangleright$  to move the cursor to the right after entering a character then enter the next character.
- For entering characters assigned to separate buttons, press the number button continuously. The cursor automatically moves to the next position, and the entered character is registered.

#### 3 Repeat step 2 to change the name then press **[ENTER]** or **<▶/|| ENTER>** to register it.

**Example:** For changing characters from "POPS" to "ROCK"

- ① Place the cursor at "P". ▶ P O P S
- ② Press **[7 PQRS]** seven times. ▶ R O P S  
"P" changes to "R".
- ③ Press  $\triangleright$  twice. ▶ R O P S  
"R" is automatically registered, and the cursor placed "P".
- ④ Press **[2 ABC]** six times. ▶ R O C S  
"P" changes to "C".
- ⑤ Press  $\triangleright$ . ▶ R O C S  
"C" is registered and the cursor placed "S".
- ⑥ Press **[5 JKL]** five times. ▶ R O C K  
"S" changes to "K".
- ⑦ Press **[ENTER]** or **<▶/|| ENTER>** to register the input name.

**Symbols used to indicate buttons in this manual**

- Button located on both the main unit and the remote control → **BUTTON**
- Button only on the main unit → **<BUTTON>**
- Button only on the remote control → **[BUTTON]**

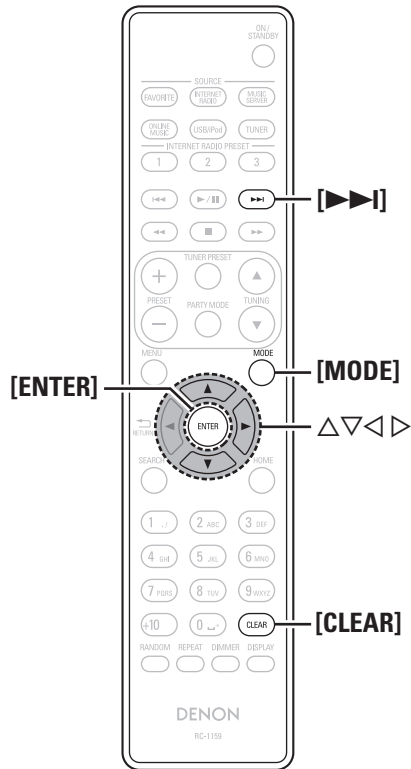
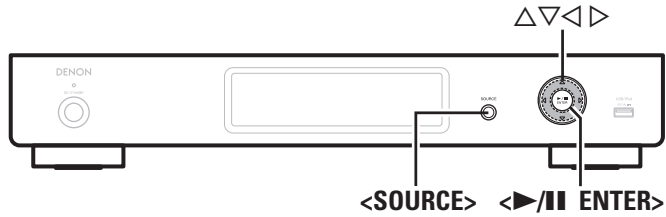

**Using the cursor buttons**

- 1** Display the screen for inputting characters.
- 2** Use ◀ ▶ to set the cursor to the character you want to change.
- 3** Use ▲ ▼ to change the character.
  - The types of characters that can be input are as shown below.
 

**[Lower case characters]**  
abcdefghijklmnopqrstuvwxyz

**[Upper case characters]**  
ABCDEFGHIJKLMNOPQRSTUVWXYZ

**[Symbols]** ! " # \$ % & ' ( ) \* + , - . / : ; < = > ? @ [ \ ] ^ \_ ` { | } ~

**[Numbers]** 0123456789 (Space)

    - The input character type can be switched by pressing [MODE] while the display name is being changed.
    - Press [CLEAR] to delete the character.
    - Press [▶▶] to insert a space.
  - 4** Repeat steps 2 and 3 to change the name then press [ENTER] or <▶/|| ENTER> to register it.

**Last function memory**

This stores the settings as they were immediately before going into the standby mode. When the power is turned back on, the settings are restored to as they were immediately before going into the standby mode.

**Resetting the microprocessor**

Perform this procedure if the display is abnormal or if operations cannot be performed. When the microprocessor is reset, all the settings are reset to their default values.

- 1** Pull the power cord out of the power outlet.
- 2** Plug the power cord into a power outlet while pressing <SOURCE> and <▶/|| ENTER> simultaneously.
- 3** When the power indicator lights green, release the buttons. "Initialized" appears in the display.

If "Initialized" does not display in step 3, start over from step 1.

# Information

## Part names and functions

For buttons not explained here, see the page indicated in parentheses ( ).

### Front panel

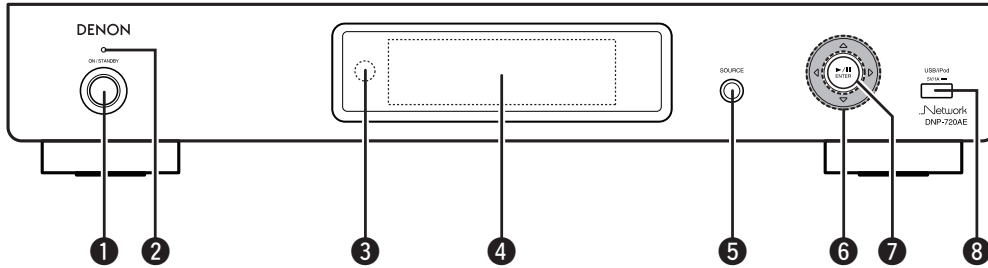

- 1 Power operation button (ON/STANDBY)** ..... (8)  
Turns power to this unit on and off (standby).
- 2 Power indicator** ..... (8)  
The power indicator changes as shown below according to the status of the unit.
  - Power on..... Green
  - Standby..... Red
  - Network standby..... Orange
  - Auto standby..... Off
- 3 Remote control sensor** ..... (3)
- 4 Display**  
Displays play status, settings, etc.
- 5 Input source select button (SOURCE)** ..... (8)  
Selects the input source.
- 6 Cursor button (△▽◀▶)** ..... (8)
- 7 Play/Pause button (▶/||)** ..... (8)  
**ENTER button** ..... (8)
- 8 USB/iPod port** ..... (16, 17)  
Used to connect USB memory devices or iPod.

### Rear panel

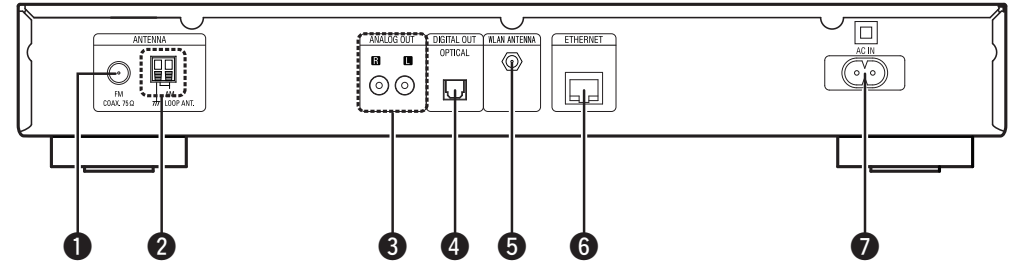

- 1 FM antenna terminal** ..... (5)  
Connect the supplied FM indoor antenna. Connect to an external antenna if reception is poor.
- 2 AM antenna terminal** ..... (5)  
Connect to the supplied AM roop antenna.
- 3 ANALOG OUT connectors** ..... (4)  
Connect a commercially available amp.
- 4 DIGITAL OUT connector** ..... (4)  
Connect a digital device such as a commercially available AV receiver or D/A converter.
- 5 WLAN ANTENNA terminal** ..... (6)  
Connect the supplied wireless LAN rod antenna.
- 6 ETHERNET connector** ..... (6)
- 7 AC inlet (AC IN)** ..... (7)  
Connect the supplied power cord.

## Remote control

This section explains the buttons used to playback each input source.

### Buttons that work with all input sources (USB/iPod, TUNER and network)

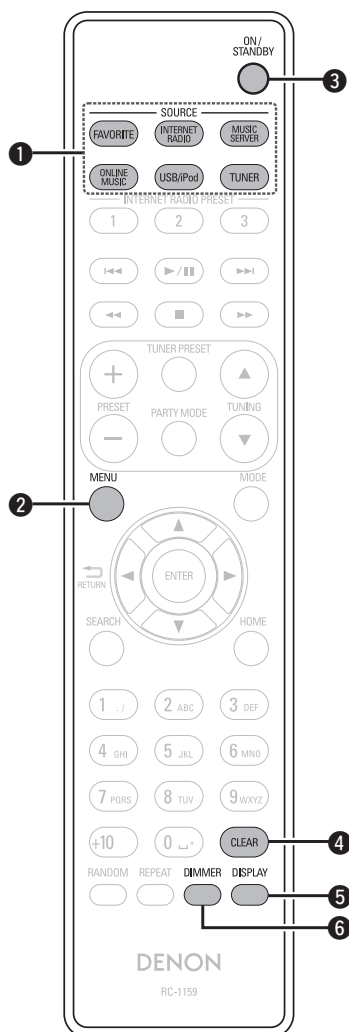

- 1 Input source select button ..... (8)
- 2 MENU button ..... (16)
- 3 ON/STANDBY button ..... (8)
- 4 CLEAR button ..... (31, 32)
- 5 DISPLAY button ..... (9)
- 6 DIMMER button ..... (8)

### Buttons that work when the input source is "Internet Radio", "Music Server", "Last.fm" or "Napster"

"Buttons that work with all input sources (USB/iPod, TUNER and network)" can also be used.

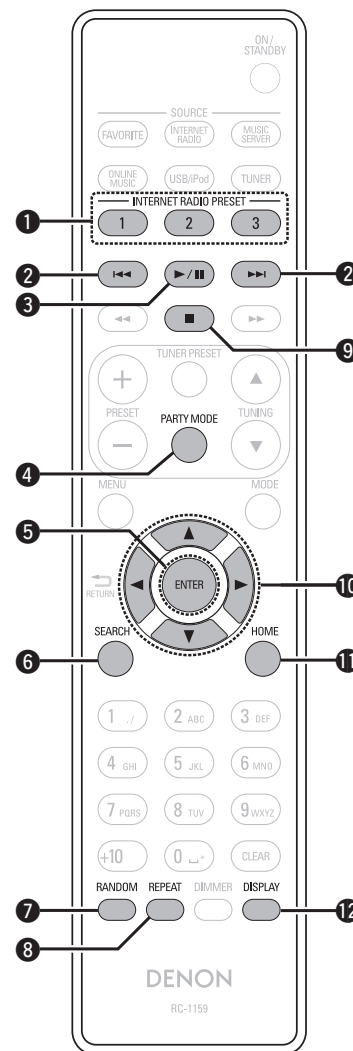

- 1 INTERNET RADIO PRESET buttons ..... (9)
- 2 Reverse-skip/Forward-skip buttons (◀◀, ▶▶) ..... (10)
- 3 Play/Pause button (▶/⏸) ..... (9)
- 4 PARTY MODE button ..... (24)
- 5 ENTER button ..... (9)
- 6 SEARCH button ..... (9)
- 7 RANDOM button ..... (10)
- 8 REPEAT button ..... (10)
- 9 Stop button (■) ..... (9)
- 10 Cursor buttons (▲▼◀▶) ..... (9)
- 11 HOME button ..... (9)
- 12 DISPLAY button ..... (9)



□ Buttons that work when the input source is "TUNER"

"Buttons that work with all input sources (USB/iPod, TUNER and network)" can also be used.

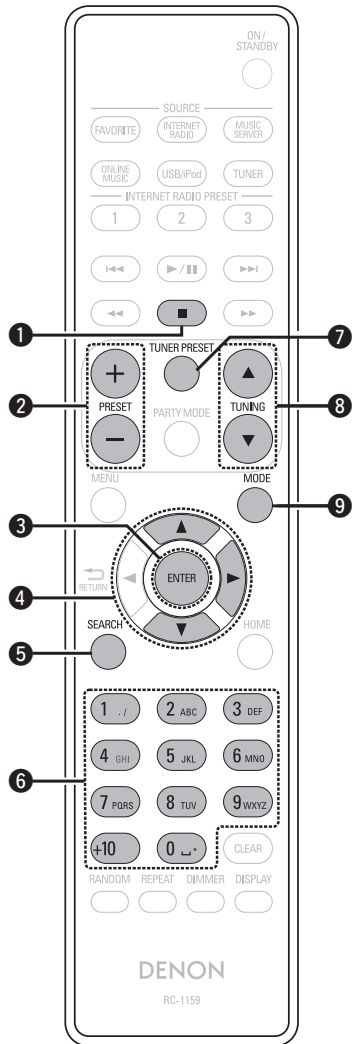

- 1 Stop button (■) ..... (13)
- 2 Preset channel buttons (PRESET +, -) ..... (14)
- 3 ENTER button ..... (13)
- 4 Cursor buttons (Δ∇▷) ..... (13, 14)
- 5 SEARCH button ..... (13)
- 6 Number buttons ..... (14)
- 7 TUNER PRESET button ..... (13)
- 8 Tuning up/Tuning down buttons (TUNING ▲▼) ..... (13)
- 9 MODE button ..... (13)

□ Buttons that work when the input source is "USB/iPod"

"Buttons that work with all input sources (USB/iPod, TUNER and network)" can also be used.

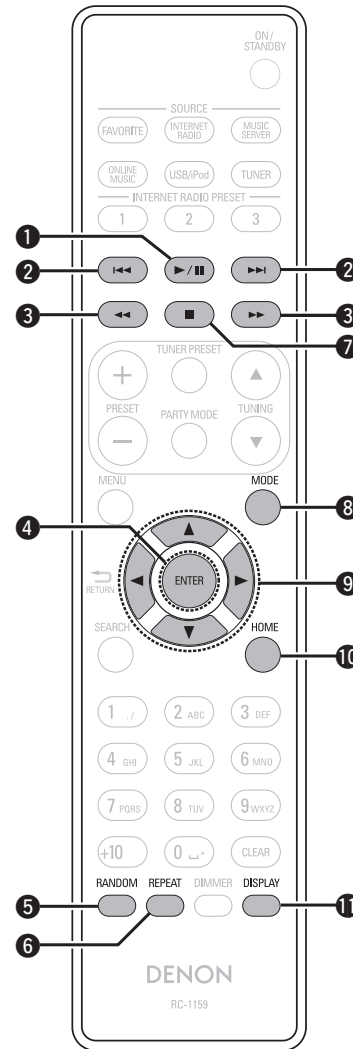

- 1 Play/Pause button (▶/⏸) ..... (16)
- 2 Reverse-skip/Forward-skip buttons (◀◀, ▶▶) ..... (16)
- 3 Fast-reverse/Fast-forward buttons (◀◀, ▶▶) ..... (16)
- 4 ENTER button ..... (16)
- 5 RANDOM button ..... (18)
- 6 REPEAT button ..... (18)
- 7 Stop button (■) ..... (16)
- 8 MODE button ..... (16)
- 9 Cursor buttons (Δ∇◀▷) ..... (16)
- 10 HOME button ..... (16)
- 11 DISPLAY button ..... (18)

iPod®



“Made for iPod” and “Made for iPhone” mean that an electronic accessory has been designed to connect specifically to iPod, or iPhone, respectively, and has been certified by the developer to meet Apple performance standards.

Apple is not responsible for the operation of this device or its compliance with safety and regulatory standards. Please note that the use of this accessory with iPod, or iPhone, may affect wireless performance.

AirPlay, the AirPlay logo, iPhone, iPod, iPod classic, iPod nano, iPod shuffle, and iPod touch are trademarks of Apple Inc., registered in the U.S. and other countries.

- Individual users are permitted to use iPhone, iPod, iPod classic, iPod nano, iPod shuffle, and iPod touch for private copy and playback of non-copyrighted contents and contents whose copy and playback is permitted by law. Copyright infringement is prohibited by law.

## USB memory device

### Important information

A USB memory device can be connected to the USB/iPod port of this unit to play music files stored on the USB memory device.

Also, files stored on an iPod can be played when the iPod is connected directly to the USB/iPod port of this unit. See “USB memory device playback” (page 17).

- Only USB memory devices conforming to mass storage class and MTP (Media Transfer Protocol) standards can be played on this unit.
- This unit is compatible with USB memory devices in “FAT16” or “FAT32” format.



If the number of files stored in a USB memory device exceeds 1,000, the access speed may become slower.

### [Types of files that can be played back by each function]

	USB memory devices *1
<b>WMA</b> (Windows Media Audio)	✓ *2
<b>MP3</b> (MPEG-1 Audio Layer-3)	✓
<b>WAV</b>	✓
<b>MPEG-4 AAC</b>	✓ *3
<b>FLAC</b> (Free Lossless Audio Codec)	✓

\*1 USB

- This unit is compatible with MP3 ID3-Tag (Ver. 2) standard.
- This unit is compatible with WMA META tags.
- WAV format Quantization bit rate: 16 bits.

\*2 Copyright-protected files can be played on certain portable players compatible with MTP.

\*3 Only files that are not protected by copyright can be played on this unit.

Content downloaded from pay sites on the Internet are copyright protected. Also, files encoded in WMA format when ripped from a CD, etc. on a computer may be copyright protected, depending on the computer's settings.

### [Playback file specifications]

	Sampling frequency	Bit rate	Extension
<b>WMA</b> (Windows Media Audio)	32/44.1/48 kHz	48 – 192 kbps	.wma
<b>MP3</b> (MPEG-1 Audio Layer-3)	32/44.1/48 kHz	32 – 320 kbps	.mp3
<b>WAV</b>	32/44.1/48 kHz	–	.wav
<b>MPEG-4 AAC</b>	32/44.1/48 kHz	16 – 320 kbps	.aac/ .m4a/ .mp4
<b>FLAC</b> (Free Lossless Audio Codec)	32/44.1/48/ 88.2/96 kHz	–	.flac

## Network audio

### Important information

#### □ About the internet radio function

- Internet radio refers to radio broadcasts distributed over the Internet.  
Internet radio stations from around the world can be received.
- This unit is equipped with the following Internet radio functions:
  - Stations can be selected by genre and region.
  - Up to 56 Internet radio stations can be preset (ⓘ page 9).
  - Internet radio stations in MP3 and WMA (Windows Media Audio) format can be listened to.
- Your favorite radio stations can be registered by accessing an exclusive DENON Internet radio URL from a Web browser on a computer.
- The function is managed for individual users, so you must provide your MAC or e-mail address.  
Exclusive URL: <http://www.radiodenon.com>
- The radio station database service may be suspended without notice.
- This unit's Internet radio station list is created using a radio station database service (vTuner). This database service provides a list edited and created for this unit.

#### □ Music server

This function lets you play music files and playlists (m3u, wpl) stored on a computer (music server) connected to this unit via a network.

With this unit's network audio playback function, connection to the server is possible using one of the technologies below.

- Windows Media Player Network Sharing Service
- Windows Media DRM10

#### [Types of files that can be played back by each function]

	Internet radio	Music server *1
<b>WMA</b> (Windows Media Audio)	✓	✓
<b>MP3</b> (MPEG-1 Audio Layer-3)	✓	✓
<b>WAV</b>		✓
<b>MPEG-4 AAC</b>		✓*2
<b>FLAC</b> (Free Lossless Audio Codec)		✓

A server or server software compatible with distribution in the corresponding formats is required to play music files via a network.

#### \*1 Music server

- This unit is compatible with MP3 ID3-Tag (Ver. 2) standard.
- This unit is compatible with WMA META tags.
- WAV format Quantization bit rate: 16 bits.

#### \*2 Only files that are not protected by copyright can be played on this unit.

Content downloaded from pay sites on the Internet are copyright protected. Also, files encoded in WMA format when ripped from a CD, etc. on a computer may be copyright protected, depending on the computer's settings.

#### [Playback file specifications]

	Sampling frequency	Bit rate	Extension
<b>WMA</b> (Windows Media Audio)	32/44.1/48 kHz	48 – 192 kbps	.wma
<b>MP3</b> (MPEG-1 Audio Layer-3)	32/44.1/48 kHz	32 – 320 kbps	.mp3
<b>WAV</b>	32/44.1/48 kHz	–	.wav
<b>MPEG-4 AAC</b>	32/44.1/48 kHz	16 – 320 kbps	.aac/ .m4a/ .mp4
<b>FLAC</b> (Free Lossless Audio Codec)	32/44.1/48/ 88.2/96 kHz	–	.flac

#### □ About Napster

Napster is a monthly subscription music distribution service provided by Napster LLC. This service allows users to download and play pieces of music they want to hear on this unit. Before you can use Napster, you will need to visit the Napster website on your PC to create an account and register as a member. For details, access the following site:

[http://www.napster.com/choose/index\\_default.html](http://www.napster.com/choose/index_default.html)

#### □ About Last.fm

Last.fm learns what you love... and it's a great way to discover new music.

Your new DENON Network CD receiver is very clever. You can create a free Last.fm profile when you start using your DENON Network CD receiver and magically keep track of all the songs you hear.

When you sign in at [www.last.fm](http://www.last.fm), you can see your top music charts, view thousands of reviews, biographies and artwork, and get recommendations for local performances you won't want to miss.

With an affordable subscription you can enjoy an endless choice of personalised ad-free radio stations. Check out [www.last.fm/subscribe](http://www.last.fm/subscribe) today for more details.

Your subscription also gives you access to Last.fm radio on a great range of music products, including your DENON Network CD Receiver. This feature is not available in all countries. Visit [www.last.fm/hardware](http://www.last.fm/hardware) to find out more.

# Explanation terms

## A

### AirPlay

AirPlay sends (plays) contents recorded in iTunes or on an iPhone/iPod touch to a compatible device via the network.

### AES (Advanced Encryption Standard)

This is a next generation standard encryption method replacing the current DES and 3DES, and because of its high security it is expected to be applied widely to wireless LANs in the future. It uses the "Rijndael" algorithm developed by two Belgian cryptographers to divide the data into blocks of fixed lengths and encrypt each block. It supports data lengths of 128, 192 and 256 bits and key lengths of 128, 192 and 256 bits as well, offering extremely high encryption security.

## B

### Bit rate

This expresses the read amount per 1 second of video/audio data recorded in a disc. A larger number means higher sound quality, but also means a larger file size.

## D

### DLNA

DLNA and DLNA CERTIFIED are trademarks and/or service marks of Digital Living Network Alliance. Some contents may not be compatible with other DLNA CERTIFIED™ products.

## F

### FLAC

FLAC stands for Free lossless Audio Codec, and is a lossless free audio file format. Lossless means that the audio is compressed without any loss in quality. The FLAC license is as shown below.

Copyright (C) 2000,2001,2002,2003,2004,2005,2006,2007,2008,2009 Josh Coalson

Redistribution and use in source and binary forms, with or without modification, are permitted provided that the following conditions are met:

- Redistributions of source code must retain the above copyright notice, this list of conditions and the following disclaimer.
- Redistributions in binary form must reproduce the above copyright notice, this list of conditions and the following disclaimer in the documentation and/or other materials provided with the distribution.
- Neither the name of the Xiph.org Foundation nor the names of its contributors may be used to endorse or promote products derived from this software without specific prior written permission.

THIS SOFTWARE IS PROVIDED BY THE COPYRIGHT HOLDERS AND CONTRIBUTORS "AS IS" AND ANY EXPRESS OR IMPLIED WARRANTIES, INCLUDING, BUT NOT LIMITED TO, THE IMPLIED WARRANTIES OF MERCHANTABILITY AND FITNESS FOR A PARTICULAR PURPOSE ARE DISCLAIMED. IN NO EVENT SHALL THE FOUNDATION OR CONTRIBUTORS BE LIABLE FOR ANY DIRECT, INDIRECT, INCIDENTAL, SPECIAL, EXEMPLARY, OR CONSEQUENTIAL DAMAGES (INCLUDING, BUT NOT LIMITED TO, PROCUREMENT OF SUBSTITUTE GOODS OR SERVICES; LOSS OF USE, DATA, OR PROFITS; OR BUSINESS INTERRUPTION) HOWEVER CAUSED AND ON ANY THEORY OF LIABILITY, WHETHER IN CONTRACT, STRICT LIABILITY, OR TORT (INCLUDING NEGLIGENCE OR OTHERWISE) ARISING IN ANY WAY OUT OF THE USE OF THIS SOFTWARE, EVEN IF ADVISED OF THE POSSIBILITY OF SUCH DAMAGE.

## I

### IEEE 802.11b

This is one wireless LAN standard set by the 802 working group that establishes LAN technology standards at the IEEE (Institute of Electrical and Electronics Engineers) of the United States. It uses the 2.4 GHz band usable freely without a radio frequency license (ISM band), enabling communications at a maximum speed of 11 Mbps.

- The value indicated above is the maximum theoretical value for the wireless LAN standard, and does not indicate the actual data transfer rate.

### IEEE 802.11g

This is another wireless LAN standard set by the 802 working group that establishes LAN technology standards at the IEEE (Institute of Electrical and Electronics Engineers) of the United States, and is compatible with IEEE 802.11b. It also uses the 2.4 GHz band, but enables communications at a maximum speed of 54 Mbps.

- The value indicated above is the maximum theoretical value for the wireless LAN standard, and does not indicate the actual data transfer rate.

### iTunes

iTunes is the name of the multimedia player provided by Apple Inc. It enables management and playback of multimedia contents including music and movies. iTunes supports many main file formats including AAC, WAV, and MP3.

## M

### MP3 (MPEG Audio Layer-3)

This is an internationally standardized audio data compression scheme, using the "MPEG-1" video compression standard. It compresses the data volume to about one eleventh its original size while maintaining sound quality equivalent to a music CD.

### MPEG (Moving Picture Experts Group), MPEG-2, MPEG-4

These are the names for digital compression format standards used for the encoding of video and audio. Video standards include "MPEG-1 Video", "MPEG-2 Video", "MPEG-4 Visual", "MPEG-4 AVC". Audio standards include "MPEG-1 Audio", "MPEG-2 Audio", "MPEG-4 AAC".

## N

### Network Names

#### (SSID: Security Set Identifier)

When forming wireless LAN networks, groups are formed to prevent interference, data theft, etc. This grouping is done by "SSID" or "Security Set Identifiers". For further security, a WEP key is set and signal transfer is not possible unless the SSID and WEP key match.

## S

### Sampling frequency

Sampling involves taking a reading of a sound wave (analog signal) at regular intervals and expressing the height of the wave at each reading in digitized format (producing a digital signal).

The number of readings taken in one second is called the "sampling frequency". The larger the value, the closer the reproduced sound is to the original.

## T

### TKIP (Temporal Key Integrity Protocol)

This is a network key used for WPA. The encryption algorithm is RC4, the same as for WEP, but the security level is increased by changing the network key used for encryption for each packet.

## V

### vTuner

This is a free online content server for Internet radio. Note that usage fees are included in upgrade costs.

For inquiries about this service, visit the vTuner site below.

vTuner website: <http://www.radiodemon.com>

This product is protected by certain intellectual property rights of Nothing Else Matters Software and BridgeCo. Use or distribution of such technology outside of this product is prohibited without a license from Nothing Else Matters Software and BridgeCo or an authorized subsidiary.

## W

**WEP Key (Network Key)**

This is key information used for encrypting data when conducting data transfer. On this unit, the same WEP key is used for data encryption and decryption, so the same WEP key must be set on both devices in order for communications to be established between them.

**Wi-Fi®**

Wi-Fi Certification assures tested and proven interoperability by the Wi-Fi Alliance, a group certifying interoperability among wireless LAN devices.

**Windows Media DRM**

This is a copyright protection technology developed by Microsoft.

Content providers are using the digital rights management technology for Windows Media contained in this device (WM-DRM) to protect the integrity of their content (Secure Content) so that their intellectual property, including copyright, in such content is not misappropriated. This device uses WM-DRM software to play Secure Content (WM-DRM Software). If the security of the WM-DRM Software in this device has been compromised, owners of Secure Content (Secure Content Owners) may request that Microsoft revoke the WM-DRM Software's right to acquire new licenses to copy, display and/or play Secure Content. Revocation does not alter the WM-DRM Software's ability to play unprotected content.

A list of revoked WM-DRM Software is sent to your device whenever you download a license for Secure Content from the Internet or from a PC. Microsoft may, in conjunction with such license, also download revocation list onto your device on behalf of Secure Content Owners.

**Windows Media Player Ver. 11 or later**

This is a media player distributed free of charge by Microsoft Corporation.

It can be used to play playlists created with Windows Media Player Ver. 11 or later as well as files in such formats as WMA, DRM WMA, MP3 and WAV.

**WMA (Windows Media Audio)**

This is audio compression technology developed by Microsoft Corporation.

WMA data can be encoded using Windows Media® Player Ver.7, 7.1, Windows Media® Player for Windows® XP and Windows Media® Player 9 Series.

To encode WMA files, only use applications authorized by Microsoft Corporation. If you use an unauthorized application, the file may not work properly.

**WPA (Wi-Fi Protected Access)**

This is a security standard established by the Wi-Fi Alliance. In addition to the conventional SSID (network name) and WEP key (network key), it also uses a user identification function and encrypting protocol for stronger security.

**WPA2 (Wi-Fi Protected Access 2)**

This is a new version of the WPA established by the Wi-Fi Alliance, compatible with more secure AES encryption.

**WPA-PSK/WPA2-PSK (Pre-shared Key)**

This is a simple authentication system for mutual authentication when a preset character string matches on the wireless LAN access point and client.

**WPS (Wi-Fi Protected Setup)**

This is a standard drawn up by the Wi-Fi Alliance to ease the task of setting up wireless LAN connections and configuring security. There are two methods: push-button and PIN (Personal Identification Number) code.

# Troubleshooting

If a problem occurs first check the following:

1. Are the connections correct?
2. Is the set being operated as described in the owner's manual?
3. Are the other components operating properly?

If this unit does not operate properly, check the items listed in the table below. If the problem persists, there may be a malfunction.

In this case, disconnect the power immediately and contact your retail outlet.

**[General]**

Symptom	Cause	Countermeasure	Page
Set does not operate properly.	• External noise or interference is causing the set to malfunction.	• Reset the microprocessor.	32
Display not lit and sound not produced when power switched to on.	• Power cord not plugged in securely.	• Check the connections on the set's rear panel and the connection of the power plug to the power outlet.	7
Display lit but sound not produced.	• Wrong input source selected.	• Select the appropriate input source.	8
Display is off.	• The Dimmer setting is set to "Off".	• Set to something other than "Off".	8
Power turns off suddenly and POWER indicator flashes red. (Flashes at 0.25 second intervals)	• Set is damaged.	• Turn off the power and contact a DENON service center.	–
"No Network Connection" is displayed.	• The network is not properly set up.	• Select a source other than the network function. • Perform "Network First Setup."	8 20

**[Tuner]**

Symptom	Cause	Countermeasure	Page
Continuous noise is heard when receiving FM programs.	<ul style="list-style-type: none"> <li>• Antenna cable is not properly connected.</li> </ul>	<ul style="list-style-type: none"> <li>• Connect the antenna cable properly.</li> <li>• Connect an outdoor antenna.</li> </ul>	5 –
Hissing or continuous noise is heard when receiving AM programs.	<ul style="list-style-type: none"> <li>• This may be noise from a TV or interference from a broadcast station.</li> </ul>	<ul style="list-style-type: none"> <li>• Turn off the TV.</li> <li>• Change the position and direction of the AM loop antenna.</li> </ul>	– 5

**[Internet radio/Music server/iPod/USB memory device]**

Symptom	Cause	Countermeasure	Page
When a USB memory device is connected, "USB/iPod" is not displayed.	<ul style="list-style-type: none"> <li>• The set cannot recognize a USB memory device.</li> </ul>	<ul style="list-style-type: none"> <li>• Check the connection.</li> </ul>	17
	<ul style="list-style-type: none"> <li>• A USB memory device not conforming to mass storage class or MTP standards is connected.</li> </ul>	<ul style="list-style-type: none"> <li>• Connect a USB memory device conforming to mass storage class or MTP standards.</li> </ul>	–
	<ul style="list-style-type: none"> <li>• A USB memory device that the set cannot recognize is connected.</li> </ul>	<ul style="list-style-type: none"> <li>• This is not a malfunction. DENON does not guarantee that all USB memory devices will operate or receive power.</li> </ul>	–
	<ul style="list-style-type: none"> <li>• USB memory device is connected via USB hub.</li> </ul>	<ul style="list-style-type: none"> <li>• Connect the USB memory device directly to the USB/iPod port.</li> </ul>	–
iPod cannot be played.	<ul style="list-style-type: none"> <li>• The input source is set to something other than "USB/iPod".</li> </ul>	<ul style="list-style-type: none"> <li>• Switch the input source to "USB/iPod".</li> </ul>	8
	<ul style="list-style-type: none"> <li>• Cable is not properly connected.</li> </ul>	<ul style="list-style-type: none"> <li>• Reconnect.</li> </ul>	16
Files on a USB memory device cannot be played.	<ul style="list-style-type: none"> <li>• USB memory device is in a format other than FAT16 or FAT32.</li> </ul>	<ul style="list-style-type: none"> <li>• Set the format to FAT16 or FAT32. For details, refer to the USB memory device's operating instructions.</li> </ul>	–
	<ul style="list-style-type: none"> <li>• USB memory device is divided into multiple partitions.</li> </ul>	<ul style="list-style-type: none"> <li>• When divided into multiple partitions, only files stored in the top partition can be played.</li> </ul>	–
	<ul style="list-style-type: none"> <li>• Files are stored in a non-compatible format.</li> </ul>	<ul style="list-style-type: none"> <li>• Record the files in a compatible format.</li> </ul>	36
	<ul style="list-style-type: none"> <li>• You are attempting to play a file that is copyright protected.</li> </ul>	<ul style="list-style-type: none"> <li>• Files that are copyright protected cannot be played on this set.</li> </ul>	36

Symptom	Cause	Countermeasure	Page
Internet radio cannot be played.	<ul style="list-style-type: none"> <li>• Ethernet cable is not properly connected or network is disconnected.</li> </ul>	<ul style="list-style-type: none"> <li>• Check the connection status.</li> </ul>	6
	<ul style="list-style-type: none"> <li>• Program is being broadcast in non-compatible format.</li> </ul>	<ul style="list-style-type: none"> <li>• Only Internet radio programs in MP3 and WMA can be played on this set.</li> </ul>	37
	<ul style="list-style-type: none"> <li>• The computer's or router's firewall is activated.</li> </ul>	<ul style="list-style-type: none"> <li>• Check the computer's or router's firewall settings.</li> </ul>	–
	<ul style="list-style-type: none"> <li>• Radio station is not currently broadcasting.</li> <li>• IP address is wrong.</li> </ul>	<ul style="list-style-type: none"> <li>• Choose a radio station that is currently broadcasting.</li> <li>• Check the set's IP address.</li> </ul>	9 20
Files stored on a computer cannot be played.	<ul style="list-style-type: none"> <li>• Files are stored in a non-compatible format.</li> </ul>	<ul style="list-style-type: none"> <li>• Record in a compatible format.</li> </ul>	37
	<ul style="list-style-type: none"> <li>• You are attempting to play a file that is copyright protected.</li> </ul>	<ul style="list-style-type: none"> <li>• Files that are copyright protected cannot be played on this set.</li> </ul>	37
	<ul style="list-style-type: none"> <li>• Set and computer are connected by USB cable.</li> </ul>	<ul style="list-style-type: none"> <li>• The set's USB/iPod port cannot be used for connection to a computer.</li> </ul>	–
Server is not found, or it is not possible to connect to the server.	<ul style="list-style-type: none"> <li>• The computer's or router's firewall is activated.</li> </ul>	<ul style="list-style-type: none"> <li>• Check the computer's or router's firewall settings.</li> </ul>	–
	<ul style="list-style-type: none"> <li>• Computer's power is not turned on.</li> </ul>	<ul style="list-style-type: none"> <li>• Turn on the power.</li> </ul>	–
	<ul style="list-style-type: none"> <li>• Server is not running.</li> </ul>	<ul style="list-style-type: none"> <li>• Launch the server.</li> </ul>	–
	<ul style="list-style-type: none"> <li>• Set's IP address is wrong.</li> </ul>	<ul style="list-style-type: none"> <li>• Check the set's IP address.</li> </ul>	20
Cannot connect to preset or favorite radio stations.	<ul style="list-style-type: none"> <li>• Radio station is not currently broadcasting.</li> </ul>	<ul style="list-style-type: none"> <li>• Wait a while before trying again.</li> </ul>	–
	<ul style="list-style-type: none"> <li>• Radio station is not currently in service.</li> </ul>	<ul style="list-style-type: none"> <li>• It is not possible to connect to radio stations that are no longer in service.</li> </ul>	–
For some radio stations, "Server Full" or "Connection Down" is displayed and station cannot be connected to.	<ul style="list-style-type: none"> <li>• Station is congested or not currently broadcasting.</li> </ul>	<ul style="list-style-type: none"> <li>• Wait a while before trying again.</li> </ul>	–

Symptom	Cause	Countermeasure	Page
Sound is broken during playback.	• Network's signal transfer speed is slow or communications lines or radio station is congested.	• This is not a malfunction. When playing broadcast data with a high bit rate, the sound may be broken, depending on the communications conditions.	–
Sound quality is poor or played sound is noisy.	• File being played has a low bit rate.	• This is not a malfunction.	–

**[Last.fm]**

Symptom	Cause	Countermeasure	Page
Cannot login to Last.fm. ("Subscription required" is displayed.)	• Login authentication error. • If a nonsubscriber user accesses it. Or when the listening limitation exceeds it.	• Enter the correct username and password and retry login. • You need to be a paid Last.fm subscriber to listen to this. Visit <a href="http://www.last.fm/subscribe">www.last.fm/subscribe</a> to upgrade.	–
Cannot play back music. ("Library empty" is displayed.)	• No music data to be played back.	• Visit <a href="http://www.last.fm/download">www.last.fm/download</a> and install the Scrobbler to add the music you've played to your profile and make this feature work.	–
Cannot play back music. ("No more tracks" is displayed.)	• When you played all tunes of the playlist.	• Select another playlist.	–
Cannot access the Last.fm. ("No network Connection" is displayed.)	• Cannot connect to the network.	• Check the network environment.	6
Cannot access the Last.fm. ("Not available in your country" is displayed.)	• You are accessing the network from a country where Last.fm radio is not available.	• Last.fm radio is not available in all countries. Please check <a href="http://www.last.fm/hardware">www.last.fm/hardware</a> for more information.	–

Symptom	Cause	Countermeasure	Page
Cannot login to Last.fm. ("Incorrect user or password" is displayed.)	• Incorrect username or password entered for login authentication.	• Enter the correct username and password and retry login.	–
Cannot create and register an account. ("Try another username" is displayed.)	• The username has already been taken.	• Enter another username to create and register the account.	–



**[Napster]**

Symptom	Cause	Countermeasure	Page
Cannot login to Napster. ("Subscription required" is displayed.)	• Login authentication error. • If a nonsubscriber user accesses it. Or when the listening limitation exceeds it.	• Enter the correct username and password and retry login.	–
Cannot login to Napster. ("Incorrect Username or Password" is displayed.)	• Incorrect username or password entered for login authentication.	• Enter the correct username and password and retry login. • Check if the Username for Napster has been properly entered. Re-enter the Password. (Password is not displayed.) <a href="http://www.napster.com/choose/index_default.html">http://www.napster.com/choose/index_default.html</a>	–

**[Wireless LAN]**

Symptom	Cause	Countermeasure	Page
Cannot connect to network.	<ul style="list-style-type: none"> <li>The settings of the SSID and network key (WEP) are incorrect.</li> <li>The reception is poor and the signals cannot be received.</li> </ul>	<ul style="list-style-type: none"> <li>Match the network settings with this unit settings.</li> </ul>	22, 23
		<ul style="list-style-type: none"> <li>Shorten the distance from the wireless LAN's access point, remove any obstacles and otherwise improve visibility, then try reconnecting. Also install away from microwave ovens and the access points of other networks.</li> </ul>	-
	<ul style="list-style-type: none"> <li>There are multiple networks and the usable channels overlap.</li> <li>The router power is off.</li> </ul>	<ul style="list-style-type: none"> <li>Set the access point's channel settings away from the channels used for other networks. Alternatively, connect using a network cable.</li> <li>Turn on the router power.</li> </ul>	-
Played sound is interrupted or sound cannot be played.	<ul style="list-style-type: none"> <li>There are multiple networks and the usable channels overlap.</li> </ul>	<ul style="list-style-type: none"> <li>Set the access point's channel settings away from the channels used for other networks. Alternatively, connect using a network cable.</li> </ul>	-

**[AirPlay]**

Symptom	Cause	Countermeasure	Page
The AirPlay icon  is not displayed in iTunes or on the iPhone/iPod touch.	<ul style="list-style-type: none"> <li>This unit and the computer or iPhone/iPod touch are not connected to the same network (LAN).</li> <li>iTunes or the iPhone/iPod touch do not have firmware that supports AirPlay installed.</li> </ul>	<ul style="list-style-type: none"> <li>Connect the computer or iPhone/iPod touch to the same network as this unit.</li> </ul>	3
		<ul style="list-style-type: none"> <li>Update to the latest firmware.</li> </ul>	28
No sound.	<ul style="list-style-type: none"> <li>This unit is not selected in the screen that is displayed when iTunes or the iPhone/iPod touch is started.</li> </ul>	<ul style="list-style-type: none"> <li>Start iTunes or switch on the iPhone/iPod touch, click the AirPlay icon  in the displayed screen, and select this unit.</li> </ul>	23

**[Remote control]**

Symptom	Cause	Countermeasure	Page
Set does not work properly when remote control operated.	<ul style="list-style-type: none"> <li>Batteries are worn.</li> <li>You are operating outside of the specified range.</li> <li>Obstacle between main unit and remote control.</li> </ul>	<ul style="list-style-type: none"> <li>Replace with new batteries.</li> </ul>	3
		<ul style="list-style-type: none"> <li>Operate within the specified range.</li> </ul>	3
		<ul style="list-style-type: none"> <li>Remove the obstacle.</li> </ul>	-
	<ul style="list-style-type: none"> <li>The batteries are not inserted in the proper direction, as indicated by the polarity marks in the battery compartment.</li> <li>The set's remote control sensor is exposed to strong light (direct sunlight, fluorescent light, etc.).</li> </ul>	<ul style="list-style-type: none"> <li>Insert the batteries in the proper direction, following the polarity marks in the battery compartment.</li> </ul>	3
		<ul style="list-style-type: none"> <li>Move the set to a place in which the remote control sensor will not be exposed to strong light.</li> </ul>	3



# Specifications

## ❑ Digital audio section

### • Analog output

#### Channels

#### Playable frequency range

#### Playable frequency response

2 channels  
 2 Hz – 96 kHz  
 2 Hz – 48 kHz  
 (Sampling frequency: 96 kHz)  
 2 Hz – 20 kHz  
 (Sampling frequency: 44.1 kHz)  
 110 dB (Audible Range)  
 98 dB (Audible Range)  
 0.003 % (1 kHz, Audible Range)

#### S/N

#### Dynamic Range

#### Harmonic Distortion

### • Output Level

#### Unbalanced

### • Digital output

#### Output level (optical)

2.0 Vrms  
 –21 – –15 dBm

## ❑ Tuner section

### • FM tuner

#### Range of receivable frequencies

#### S/N ratio (mono)

#### Sensitivity (S/N 30 dB)

### • AM tuner

#### Range of receivable frequencies

#### S/N ratio

#### Sensitivity (S/N 20 dB)

87.5 – 108.0 MHz  
 65 dB  
 9 dB $\mu$ V (IHF)

522 – 1611 kHz  
 40 dB  
 55 dB $\mu$ V/m

## ❑ Wireless LAN

### Network type (wireless LAN standards)

Conforming to IEEE 802.11b  
 Conforming to IEEE 802.11g  
 (Conforming to Wi-Fi®)\*  
 DS-SS: 11 / 5.5 / 1 Mbps (Automatic switching)  
 OFDM: 54 / 48 / 36 / 24 / 18 / 12 / 9 / 6 Mbps (Automatic switching)

### Transfer rate

### Security

SSID (Network name)  
 WEP key (network key) (64/128 bits)  
 WPA-PSK (TKIP/AES)  
 WPA2-PSK (TKIP/AES)

### Used frequency range

### No. of channels

2412 MHz – 2472 MHz  
 Conforming to IEEE 802.11b : 13ch (DS-SS) (Of which 1 channel used)  
 Conforming to IEEE 802.11g : 13ch (OFDM) (Of which 1 channel used)

## ❑ Power supply

### Power supply voltage/frequency

AC 230 V, 50/60 Hz

### Power consumption

18 W

### Power consumption in standby mode

0.2 W

### Power consumption in network standby mode

7.5 W

\* Wi-Fi® conformity indicates tested and proven interoperability by the “Wi-Fi Alliance”, a group certifying interoperability among wireless LAN devices.

• For purposes of improvement, specifications and design are subject to change without notice.

# Index

## A

Accessories .....	2
Add New Feature .....	28
AES .....	23, 38
AirPlay .....	19, 38
AM loop antenna .....	5
Auto preset .....	13
Auto Standby .....	27

## B

Bit rate .....	36, 37, 38
Browse mode .....	16

## C

Cable	
Audio cable .....	4
Ethernet cable .....	6
Optical cable .....	4
Characters .....	22, 23, 31, 32
Connection	
Amplifier .....	4
Antenna .....	5
AV receiver .....	4
D/A converter .....	4
Network .....	6
Power cord .....	7

## D

Display's brightness .....	8
DLNA .....	38

## F

Favorite list .....	15
Firmware Update .....	28
FLAC .....	38
FM indoor antenna .....	5
Friendly Name Edit .....	26
Front panel .....	33

## I

IEEE 802.11b .....	38
IEEE 802.11g .....	38
Input source .....	8
Inputting characters .....	31
Internet radio .....	9
iTunes .....	19, 38

## L

Last.fm .....	11
Last.fm Display .....	23

## M

Menu map .....	20
MP3 .....	36, 37, 38
MPEG .....	38
MPEG-4 AAC .....	36
Music server .....	10

## N

Napster .....	12
Network Names (SSID) .....	38
Network Standby .....	25

## P

Party Mode .....	24
PC Language .....	26
Playback	
FM/AM .....	13
Internet radio .....	9
iPod .....	16
Last.fm .....	11
Music server .....	10
Napster .....	12
Network audio .....	9, 37
Random .....	18
Repeat .....	18
USB memory device .....	17, 36
PTY .....	29

## R

RDS .....	29
Rear panel .....	33
Remote control .....	3, 34, 35
Batteries .....	3
Remote mode .....	16
Resetting the microprocessor .....	32
RT .....	30

## S

Sampling frequency .....	36, 37, 38
Setting	
Network .....	21, 22, 23
Other .....	27

## T

TKIP .....	38
TP .....	30

## U

Update Notification .....	27
Upgrade Notification .....	27

## V

vTuner .....	37, 38
--------------	--------

## W

WEP Key .....	23, 39
Wi-Fi .....	39
Windows Media DRM .....	37, 39
Windows Media Player .....	10, 39
WMA .....	36, 37, 39
WPA .....	23, 39
WPA2 .....	23, 39
WPA-PSK/WPA2-PSK .....	23, 39
WPS .....	23, 39

## Z

Zone Management .....	26
-----------------------	----

**Dimensions / Abmessungen / Dimensioni / Dimensioni / Afmetingen / Storlek**

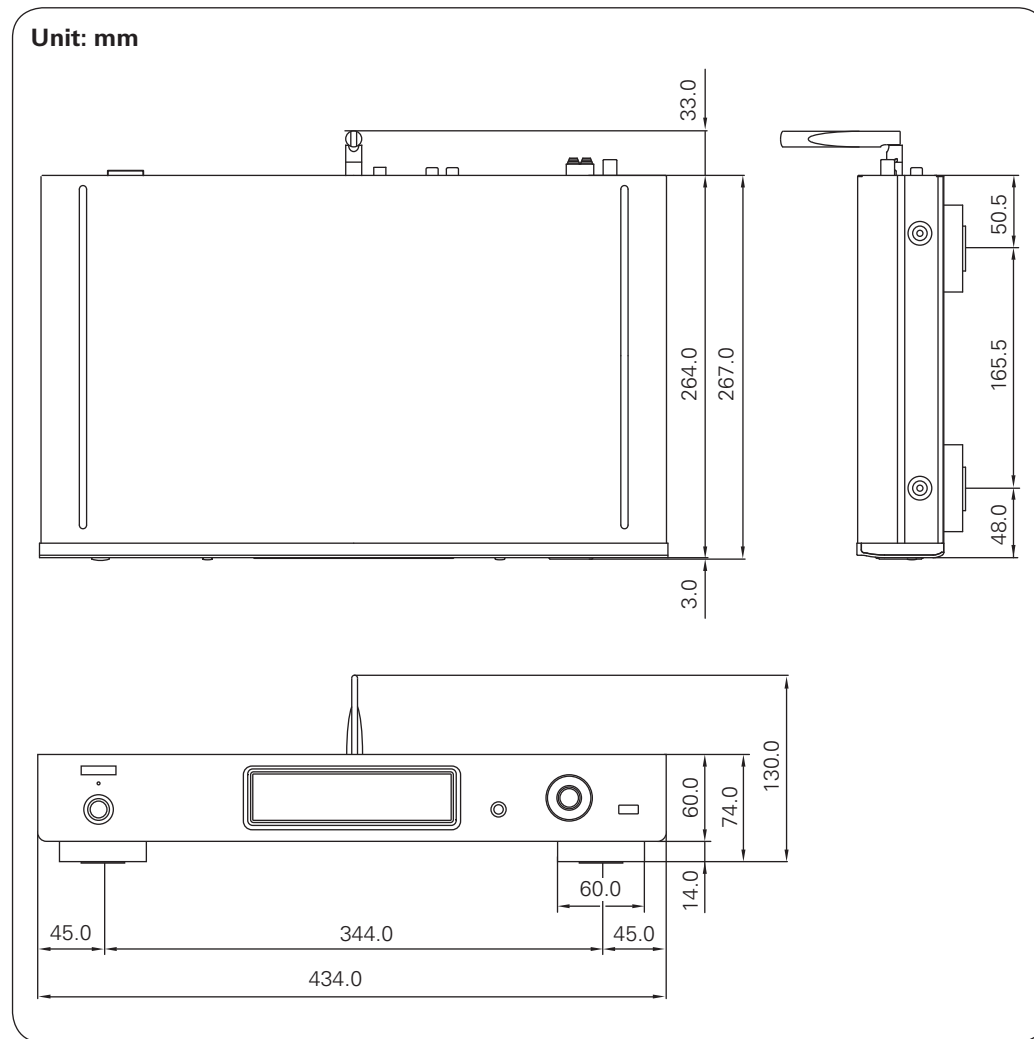

**Weight / Gewicht / Poids / Peso / Peso / Gewicht / Vikt**

2.9 kg

V00

**DENON**  
[www.denon.com](http://www.denon.com)

D&M Holdings Inc.  
Printed in China 5411 10727 00AD