

JBL[®] CHARGE

Quick-Start Guide

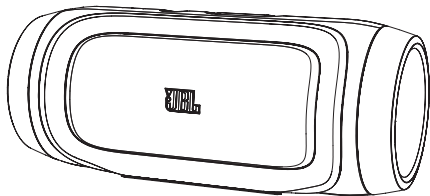



1x

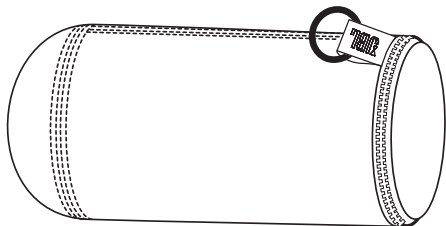

1x

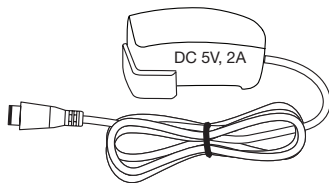

1x



1x

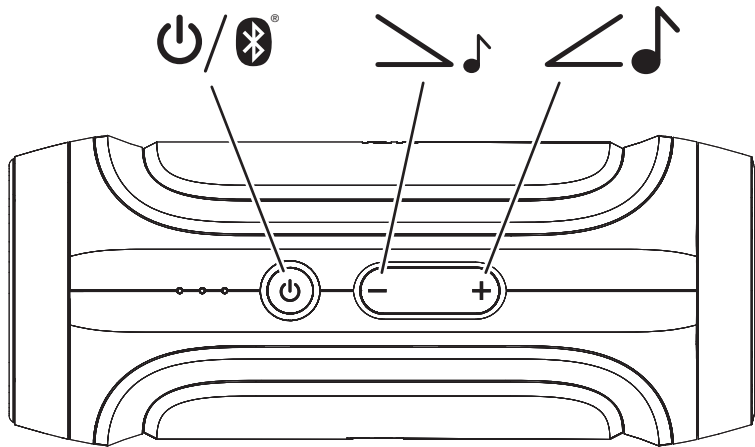

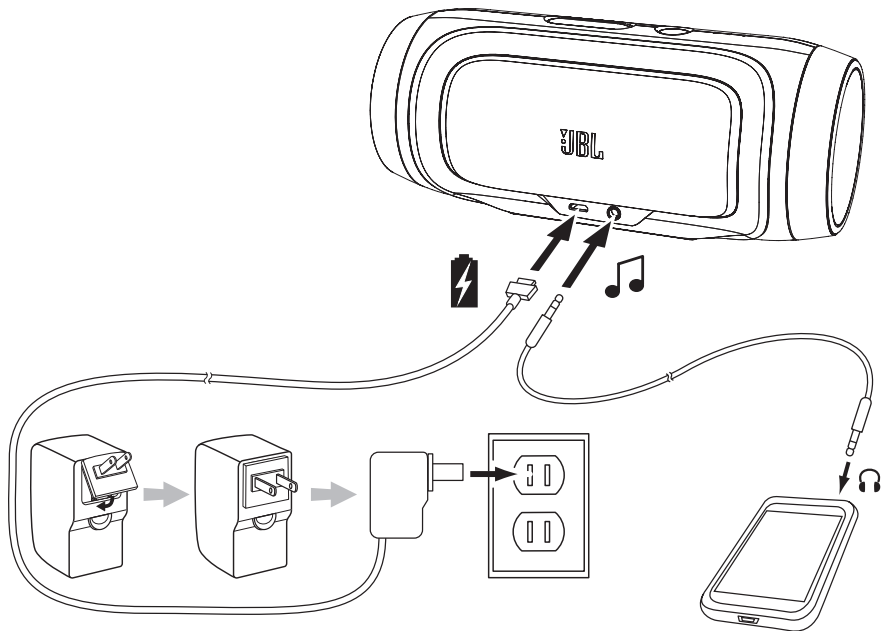

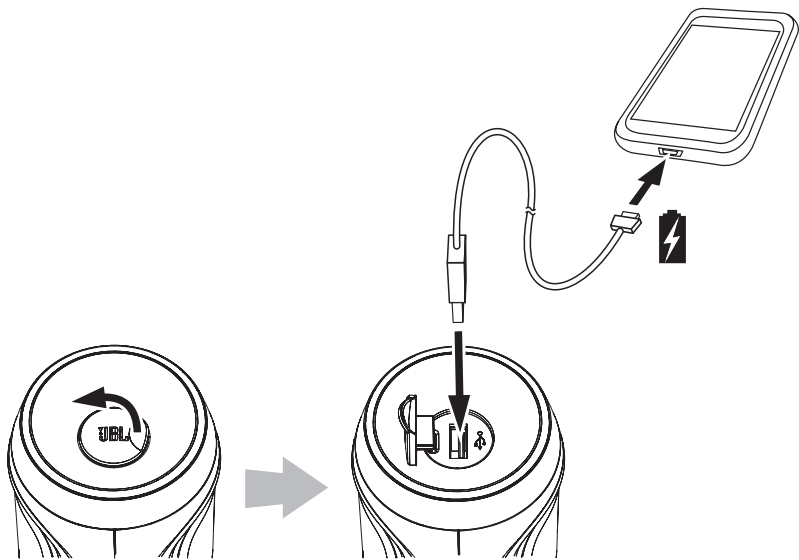



1.



Blue/Red

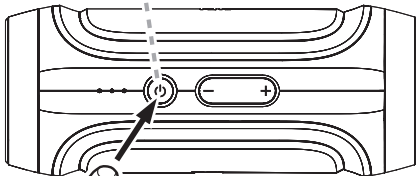

Press and hold for 3 seconds
Enfoncer et maintenir pendant 3 secondes
Premere e tenere premuto per 3 secondi
3 Sekunden lang drücken und halten
Mantener pulsado durante 3 segundos
3 seconden ingedrukt houden
Mantenha pressionado por 3 segundos
Tryk och håll nedtryckt i tre sekunder
Tryk på knappen, og hold den nede i 3 sekunder
Paina ja pidä alhaalla 3 sekuntia
Trykk og hold inne i 3 sekunder
Нажмите и удерживайте в течение 3 секунд
按住 3 秒

3초 동안 누르고 있습니다
3 秒間押しただままにしてください。

2.

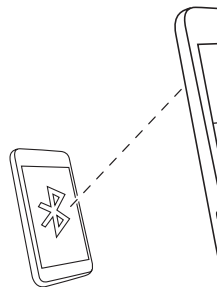

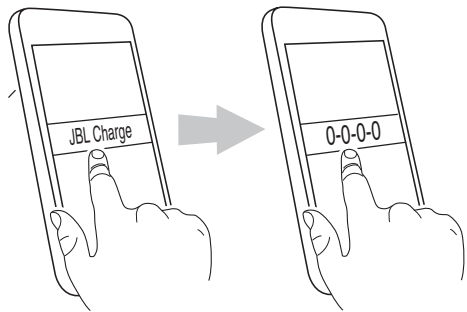

3.

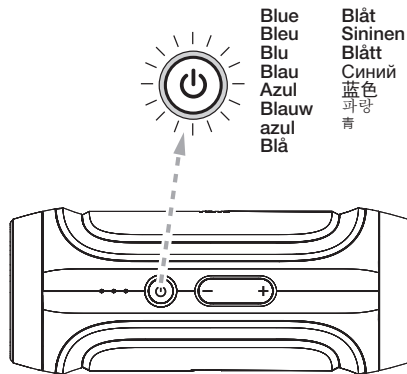

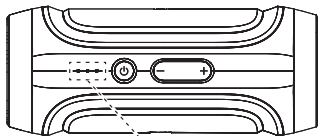

**Battery
needs charging**

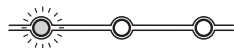

Flashing red

**Battery
level low**

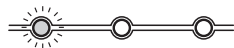

Continuous blue

**Battery
level medium**



Continuous blue

**Battery
level high**



Continuous blue

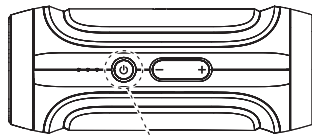

Unit is off



**Unit is on;
no *Bluetooth*[®]
connection**



Flashing blue

**Unit is on;
Bluetooth
pairing**



Flashing blue/red

**Unit is on;
Bluetooth
connection**



Continuous blue

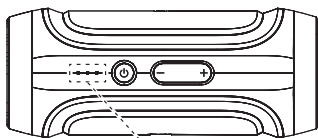

La batterie a
besoin d'être
rechargée

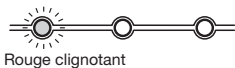

Rouge clignotant

Batterie
faiblement
chargée

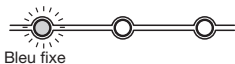

Bleu fixe

Batterie
moyennement
chargée



Bleu fixe

Batterie
pleinement
chargée



Bleu fixe

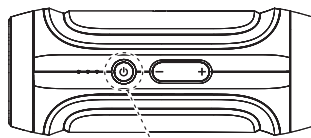

Unité éteinte



Unité allumée;
Bluetooth[®]
déconnecté



Bleu clignotant

Unité allumée;
Bluetooth en
mode appairage



Bleu/rouge clignotants

Unité allumée;
Bluetooth
connecté



Bleu fixe

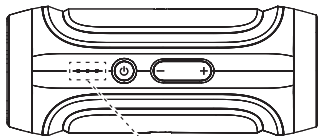

Batteria scarica
Necessaria
ricarica

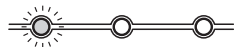

Rosso intermittente

Livello batteria
basso



Blu fisso

Livello batteria
medio



Blu fisso

Livello batteria
alto



Blu fisso

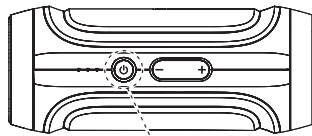

Unità spenta



Unità accesa.
Bluetooth® non
collegato



Blu intermittente

Unità accesa.
Bluetooth in
modalità pairing



Blu/rosso intermittente

Unità accesa.
Bluetooth
collegato



Blu fisso

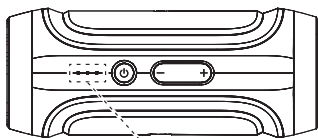

Akku muss
aufgeladen
werden



Rot blinkend

Akku
schwach

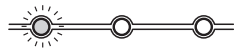

Durchgehend blau

Akkustand
mittel



Durchgehend blau

Akkustand
hoch



Durchgehend blau

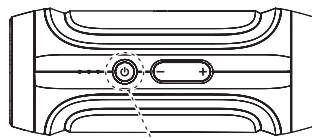

Einheit ist
ausgeschaltet



Einheit ist
eingeschaltet;
Bluetooth[®] nicht
verbunden



Blau blinkend

Einheit ist
eingeschaltet;
Bluetooth im
Kopplungsmodus



Blau/Rot blinkend

Einheit ist
eingeschaltet;
Bluetooth
verbunden



Durchgehend blau

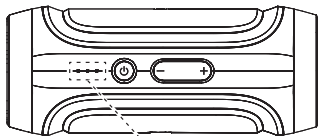

La batería
necesita
recargar

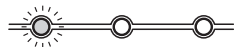

Rojo parpadeante

Nivel de batería
bajo

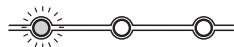

Azul continuo

Nivel de batería
mediano



Azul continuo

Nivel de batería
alto



Azul continuo

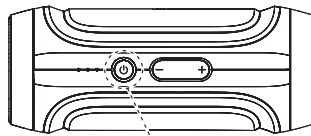

Unidad en apagado



Unidad encendida;
Bluetooth® no
conectado



Azul parpadeante

Unidad encendida;
Bluetooth en modo
de emparejamiento



Azul/Rojo parpadeante

Unidad encendida;
Bluetooth
conectado



Azul continuo

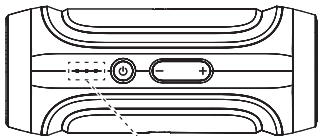

Batterij moet
opgeladen
worden

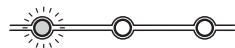

Knipperend rood

Batterijniveau
laag

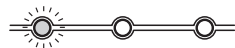

Constant blauw

Batterijniveau
middelmatig



Constant blauw

Batterijniveau
hoog



Constant blauw

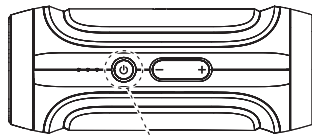

Apparaat is uit



Apparaat is aan;
Bluetooth® niet
verbonden



Knipperend blauw

Apparaat is aan;
Bluetooth in
verbodingsmodus



Knipperend blauw/rood

Apparaat is
aan; *Bluetooth*
verbonden



Constant blauw

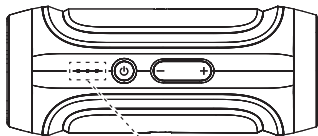

**pilha precisa
carregar**

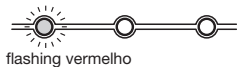

flashing vermelho

**pilha
baixa**

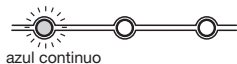

azul contínuo

**pilha a
meio nível**



azul contínuo

**pilha
carregada**



azul contínuo

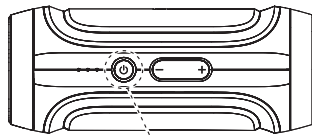

unidade apagada



**unidade no
aceso, *Bluetooth*[®]
desligado**



Flashing azul

**A unidade está
em, *Bluetooth*
emparelhamento**



Flashing azul/vermelho

**unidade
no aceso,
Bluetooth ligado**



azul contínuo

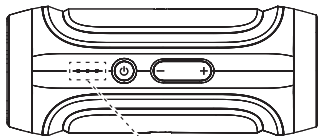

Batteriet
behöver laddas

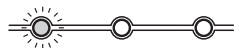

Blinkar röd

Batteri
nästan slut



Fast blå

Batteri
halvfullt



Fast blå

Batteri
laddat



Fast blå

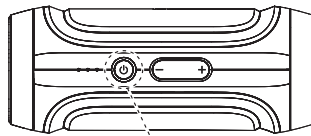

Enheten är avstängd



Enheten är
på; *Bluetooth*® ej
ansluten



Blinkar blå

Enheten är
på; *Bluetooth* i
parningsläge



Blinkar blå/röd

Enheten är
på; *Bluetooth*
ansluten



Fast blå

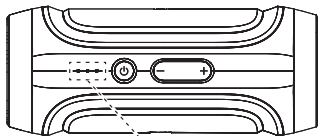

Oplad batteri

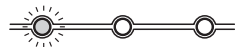

Blinker rødt

Lavt
batteriniveau

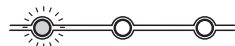

Konstant blåt

Mellem
batteriniveau



Konstant blåt

Højt
batteriniveau



Konstant blåt

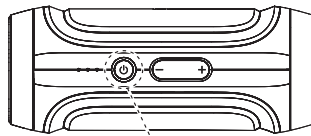

Apparat slukket



Apparat tændt;
Bluetooth® ikke
forbundet



Blinker blåt

Apparat tændt;
Bluetooth søger



Blinker rødt/blåt

Apparat tændt;
Bluetooth
forbundet



Konstant blåt

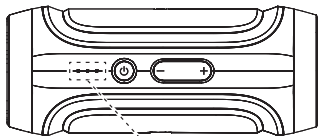

Akku on
ladattava
uudelleen

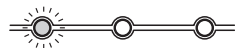

Vilkkuva punainen

Akun
lataustaso
alhainen

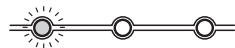

Jatkuva sininen

Akun taso
keskimääräinen



Jatkuva sininen

Akun
lataustaso
korkea



Jatkuva sininen

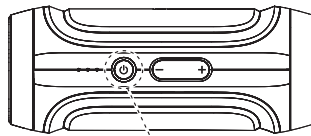

Yksikkö on
poissa päältä



Laitte kytetään
päälle, *Bluetooth*[®]
ei ole kytketty



Vilkkuva sininen

Yksikkö on päällä;
Bluetooth on
pariutumistilassa



Vilkkuva sininen/punainen

Yksikkö on päällä;
Bluetooth on
liitetty



Jatkuva sininen

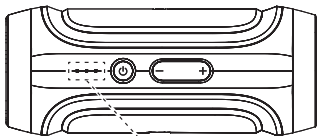

Batteriet må lades

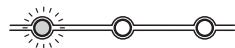

Blinker rødt

Batterinivået er lavt

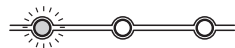

Kontinuerlig blått

Batterinivået er middels



Kontinuerlig blått

Batterinivået er høyt



Kontinuerlig blått

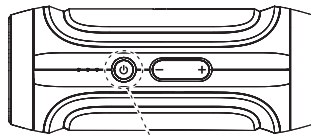

Enheten er av



Enheten er på; *Bluetooth*® ikke tilkoblet



Blinker blått

Enheten er på; *Bluetooth* er i sammenkoblingsmodus



Blinker blått/rødt

Enheten er på; *Bluetooth* er tilkoblet



Kontinuerlig blått

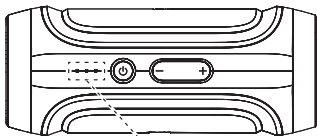

Надо зарядить
батарею



Мигающий красный

Низкий уровень
заряда

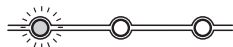

Немигающий синий

Средний
уровень заряда



Немигающий синий

Высокий
уровень заряда



Немигающий синий

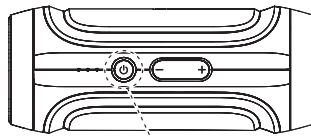

Устройство
отключено



Устройство включено,
Bluetooth® не
подключен



Мигающий синий

Устройство
включено, *Bluetooth*
подключается



Мигающий синий/красный

Устройство
включено, *Bluetooth*
подключен



Немигающий синий

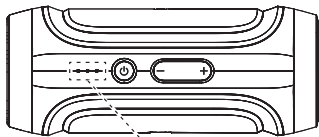

电池需要充电



红色闪烁

电池电量低

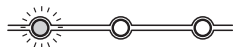

持续蓝色

电池电量中



持续蓝色

电池电量高



持续蓝色

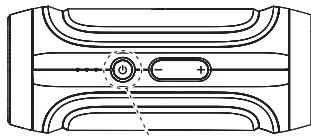

装置关闭



装置开
启; Bluetooth®并
未连接



蓝色闪烁

装置开
启; Bluetooth
处于配对模式



蓝色/红色闪烁

装置开
启; Bluetooth
连接



持续蓝色

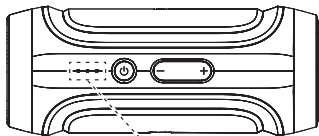

배터리 충전 필요



번쩍이는 빨강

배터리 레벨 낮음



지속적 파랑

배터리 레벨 중간



지속적 파랑

배터리 레벨 높음



지속적 파랑

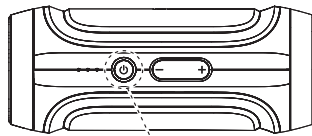

유닛 꺼짐



유닛 꺼짐.
Bluetooth® 연결 안 됨



번쩍이는 파랑

유닛 꺼짐.
Bluetooth 대합 모드



번쩍이는 파랑/
빨강

유닛 꺼짐.
Bluetooth 연결됨



지속적 파랑

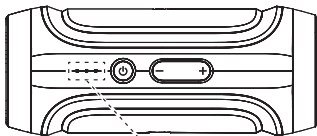

バッテリーを充電してください



赤が点滅

バッテリーレベル 低



青が点灯

バッテリーレベル 中



青が点灯

バッテリーレベル 高



青が点灯

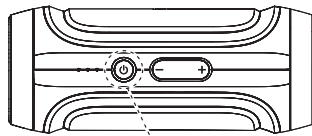

ユニットはオフです。



ユニットはオンです。*Bluetooth*® が接続されていません。



青が点滅

ユニットはオンです。*Bluetooth* がペアリングモードです。



青/赤が点滅

ユニットはオンです。*Bluetooth* が接続されています。



青が点灯

SPECIFICATIONS

Transducers:	2 x 1-1/2" (38mm)
Amplifier power:	2 x 5W
Frequency response:	150Hz – 20kHz
Signal-to-noise ratio:	>80dB
Battery type:	Li-ion rechargeable
<i>Bluetooth</i> transmitter frequency range:	2.402 – 2.480GHz
<i>Bluetooth</i> transmitter power:	0 ~ 4dBm
<i>Bluetooth</i> transmitter modulation:	$\pi/4$ -DQPSK, 8-DPSK
Listening time on battery power:	Up to 12 hours (varies by volume level and audio content)
Battery charge time:	3.5 hours
Dimensions (Dia x H):	2-29/32" x 6-29/32" (74mm x 175mm)

SPÉCIFICATIONS

Transducteurs :	2 x 1-1/2 po (38mm)
Puissance d'amplificateur :	2 x 5W
Courbe de résonance :	150Hz – 20kHz
Rapport signal sur bruit :	>80dB
Type de batterie :	Li-ion rechargeable
Plage de fréquence de l'émetteur <i>Bluetooth</i> :	2.402 – 2.480GHz
Puissance de l'émetteur <i>Bluetooth</i> :	0 ~ 4dBm
Modulation de l'émetteur <i>Bluetooth</i> :	$\pi/4$ -DQPSK, 8-DPSK
Autonomie d'écoute :	Jusqu'à 12 heures (en fonction du niveau du volume et du contenu audio)
Durée de charge :	3.5 heures
Dimensions (Dia x H) :	74mm x 175mm (2-29/32 po x 6-29/32 po)

ESPECIFICACIONES

Transductores:	2 x 1-1/2" (38mm)
Potencia de amplificador:	2 x 5W
Respuesta en frecuencia:	150Hz – 20kHz
Relación señal/ruido:	>80dB
Tipo de pila:	Litio-ion recargable
Rango de frecuencia del transmisor <i>Bluetooth</i> :	2.402 – 2.480GHz
Potencia del transmisor <i>Bluetooth</i> :	0 ~ 4dBm
Modulación del transmisor <i>Bluetooth</i> :	$\pi/4$ -DQPSK, 8-DPSK
Tiempo de escucha a pilas:	Hasta 12 horas (varía con el nivel de volumen y el contenido de audio)
Tiempo de carga de la pila:	3.5 horas
Dimensiones (Diámetro x Altura):	74mm x 175mm (2-29/32" x 6-29/32")

ESPECIFICAÇÕES

Transdutores:	2 x 1-1/2" (38mm)
Potência do amplificador:	2 x 5W
Resposta de frequência:	150Hz – 20kHz
Relação sinal/ruído:	>80dB
Tipo da bateria:	Íon-lítio recarregável
Intervalo de frequência do transmissor <i>Bluetooth</i> :	2.402 – 2.480GHz
Potencia do transmissor <i>Bluetooth</i> :	0 ~ 4dBm
Modulação do transmissor <i>Bluetooth</i> :	$\pi/4$ -DQPSK, 8-DPSK
Tempo de reprodução com energia da bateria:	Até 12 horas (varia com o volume e com o sinal e áudio)
Tempo de carga da bateria:	3.5 horas
Dimensões (Diâm. x A):	74mm x 175mm (2-29/32" x 6-29/32")

SPEZIFIKATIONEN

Wandler:	2 x 38mm
Verstärkerleistung:	2 x 5W
Frequenzgang:	150Hz – 20kHz
Signal-Rausch-Verhältnis:	>80dB
Batterietyp:	Li-ion wiederaufladbare
<i>Bluetooth</i> - Sendefrequenzbereich:	2.402 – 2.480GHz
<i>Bluetooth</i> -Sendeleistung:	0 ~ 4dBm
<i>Bluetooth</i> - Sendemodulation:	$\pi/4$ -DQPSK, 8-DPSK
Hörstunden bei Batteriebetrieb:	Bis zu 12 Stunden (variiert nach Lautstärke und Audio-Inhalten)
Batterieladezeit:	3.5 Stunden
Abmessungen (Durchm. x H):	74mm x 175mm

SPECIFICHE

Trasduttori:	2 x 1-1/2" (38mm)
Potenza amplificatore:	2 x 5W
Risposta in frequenza:	150Hz – 20kHz
Rapporto segnale-rumore:	>80dB
Tipo batteria:	Ioni di litio ricaricabile
Intervallo di frequenza trasmettitore <i>Bluetooth</i> :	2.402 – 2.480GHz
Alimentazione trasmettitore <i>Bluetooth</i> :	0 ~ 4dBm
Modulazione trasmettitore <i>Bluetooth</i> :	$\pi/4$ -DQPSK, 8-DPSK
Tempo di ascolto con batteria:	Fino a 12 ore (varia a seconda del livello del volume e del contenuto audio)
Tempo di ricarica della batteria:	3.5 ore
Dimensioni (diam x A):	74mm x 175mm (2-29/32" x 6-29/32")

仕様

トランスデューサー:	38mm 2個
アンプ出力:	2 x 5W
周波数応答:	150Hz - 20kHz
信号対雑音比 (SN比):	80dB未満
電池タイプ:	リチウムイオン再充電可能な
Bluetooth トランスミッターの周波数帯域:	2.402 - 2.480GHz
Bluetooth トランスミッターの電源:	0 ~ 4dBm
Bluetooth トランスミッターの変調方式:	$\pi/4$ -DQPSK, 8-DPSK
電池使用時の可聴時間:	最大 12 時間まで (音量および音声内容により異なる)
電池充電時間:	3.5時間
寸法 (直径×高さ):	74mm x 175mm (2-29/32インチ x 6-29/32インチ)

사양

트랜스듀서:	38mm 2개
앰프 출력:	2 x 5W
주파수 응답 대역:	150Hz ~ 20kHz
신호대 잡음 비율:	80dB 이상
배터리 타입:	리튬-이온 충전식
Bluetooth 블루투스 송수신기 주파수 대역:	2.402 - 2.480GHz
Bluetooth 블루투스 송수신기 전원:	0 ~ 4dBm
Bluetooth 블루투스 송수신기 변조:	$\pi/4$ -DQPSK, 8-DPSK
배터리 사용시간:	최대 12 시간 (볼륨 레벨 및 오디오 콘텐츠에 따라 다름)
배터리 충전시간:	3.5 시간
규격 (직경 x 높이):	74mm x 175mm (2-29/32" x 6-29/32")

规格

变频器: 2 x 1-1/2" (38mm)

放大器功率: 2 x 5W

频率响应: 150Hz – 20kHz

信噪比: >80dB

电池类型: 锂离子充电

Bluetooth 蓝牙发射频率范围: 2.402 - 2.480GHz

Bluetooth 蓝牙发射功率: 0 ~ 4dBm

Bluetooth 蓝牙发射调制: $\pi/4$ -DQPSK, 8-DPSK

电池电量播放时间: 长达 12 小时 (因音量水平和音频内容而异)

电池充电时间: 3.5小时

尺寸 (直径 x 高): 74mm x 175mm
(2-29/32" x 6-29/32")

規格

變頻器: 2 x 1-1/2" (38mm)

放大器功率: 2 x 5W

頻率響應: 150Hz – 20kHz

信噪比: >80dB

電池類型: 鋰離子充電

Bluetooth 藍牙發射頻率範圍: 2.402 – 2.480GHz

Bluetooth 藍牙發射功率: 0 ~ 4dBm

Bluetooth 藍牙發射調制: $\pi/4$ -DQPSK, 8-DPSK

電池電量播放時間: 長達 5 小時 (因音量水平和音頻內容而異)

電池充電時間: 3.5小時

尺寸 (直徑x高): 74mm x 175mm
(2-29/32" x 6-29/32")

SPECIFICATIES

Omvormers:	2 x 38mm
Versterkervermogen:	2 x 5W
Frequentieweergave:	150Hz – 20kHz
Signaal-ruisverhouding:	>80dB
Type batterij:	Li-ion oplaadbare
<i>Bluetooth</i> zender frequentiebereik:	2.402 – 2.480GHz
Vermogen van de <i>Bluetooth</i> zender:	0 ~ 4dBm
<i>Bluetooth</i> zendermodulatie:	$\pi/4$ -DQPSK, 8-DPSK
Luistertijd voor batterij:	Tot 12 uur (verschilt per volume en audio-inhoud)
Oplaadtijd voor batterij:	3.5 uur
Afmetingen (Diameter x Hoogte):	74mm x 175mm

SPESIFIKASJONER

Omformere:	2 x 1-1/2" (38mm)
Forsterkereffekt:	2 x 5W
Frekvensrespons:	150Hz – 20kHz
Signal-til-støy-forhold:	>80dB
Batteritype:	Li-ion genopladelige
<i>Bluetooth</i> -senders frekvensomrade:	2.402 – 2.480GHz
<i>Bluetooth</i> -senders effekt:	0 ~ 4dBm
<i>Bluetooth</i> -senders effekt:	$\pi/4$ -DQPSK, 8-DPSK
Lyttetid på batteristrøm:	Opptil 12 timer (varierer etter volum og lydinnhold)
Batteriladetid:	3.5 timer
Dimensjoner (D x H):	74mm x 175mm (2-29/32" x 6-29/32")

TEKNISET TIEDOT

Anturit:	2 x 1-1/2" (38mm)
Vahvistinteho:	2 x 5W
Taajuusvaste:	150Hz – 20kHz
Äänentoisto:	>80dB
Paristo:	Li-ion
<i>Bluetooth</i> -lahettimen taajuusalue:	2.402 – 2.480GHz
<i>Bluetooth</i> -lahettimen teho:	0 ~ 4dBm
<i>Bluetooth</i> -lahettimen modulaatio:	$\pi/4$ -DQPSK, 8-DPSK
Kuuntelu aika paristokäytöllä:	Korkeintaan 12 tuntia (vaihtelee äänenvoimakkuuden ja audiosisällön mukaan)
Pariston latausaika:	3.5 tuntia
Mitat (Halk. x K):	74mm x 175mm (2-29/32 tuumaa x 6-29/32 tuumaa)

ТЕХНИЧЕСКИЕ ХАРАКТЕРИСТИКИ

Динамики:	2 x 1-1/2" (38mm)
Мощность усилителя:	2 x 5Вт
Частотная характеристика:	150Гц – 20кГц
Отношение сигнал/шум:	>80дБ
Тип аккумулятора:	Литий-ионный перезаряжаемый
Диапазон частот передатчика <i>Bluetooth</i> :	2.402 – 2.480GHz
Мощность передатчика <i>Bluetooth</i> :	0 ~ 4dBm
Модуляция передатчика <i>Bluetooth</i> :	$\pi/4$ -DQPSK, 8-DPSK
Время звучания от аккумулятора:	До 12 часов (в зависимости от уровня громкости и типа аудио)
Время зарядки аккумулятора:	3.5 часов
Размеры (Диаметр x В):	74mm x 175mm (2-29/32" x 6-29/32")

SPECIFIKATIONER

Omvandlare:	2 x 38mm
Förstärkareffekt:	2 x 5W
Frekvensåtergivning:	150Hz – 20kHz
Signalbrusförhållande:	>80dB
Batterityp:	Litiumjon
<i>Bluetooth</i> -sandarens frekvensområde:	2.402 – 2.480GHz
<i>Bluetooth</i> -sandareffekt:	0 ~ 4dBm
<i>Bluetooth</i> -sandarmodulering:	$\pi/4$ -DQPSK, 8-DPSK
Lyssningstid med batteri:	Upp till fem timmar (beroende på volym och ljudinnehåll)
Batteriladdningstid:	3.5 timmar
Mått (diameter x höjd):	74mm x 175mm

SPECIFIKATIONER

Transducere:	2 x 1-1/2" (38mm)
Forstærkerstrøm:	2 x 5W
Frekvenssvar:	150Hz – 20kHz
Signal-til-støj-forhold:	>80dB
Batteri-type:	Li-ion opladbart
<i>Bluetooth</i> -sender:	2.402 – 2.480GHz
<i>Bluetooth</i> -sendereffekt:	0 ~ 4dBm
<i>Bluetooth</i> -sendermodulation:	$\pi/4$ -DQPSK, 8-DPSK
Lyttetid på batteristrøm:	Op til 12 timer (afhænger af lydstyrkeniveau og lydindhold)
Batteri-opladetid:	3.5 timer
Dimensioner (Dia. x H):	74mm x 175mm (2-29/32 tommer x 6-29/32 tommer)



HARMAN

HARMAN International Industries, Incorporated
8500 Balboa Boulevard, Northridge, CA 91329 USA
www.jbl.com

© 2013 HARMAN International Industries, Incorporated. All rights reserved. JBL is a trademark of HARMAN International Industries, Incorporated, registered in the United States and/or other countries. The *Bluetooth* word mark and logos are registered trademarks owned by Bluetooth SIG, Inc. and any use of such marks by HARMAN International Industries, Incorporated, is under license.

Features, specifications and appearance are subject to change without notice.

Part #: 950-0479-001 Rev. A