

ONKYO®

AV Receiver

TX-NR509

Instruction Manual

Thank you for purchasing an Onkyo AV Receiver. Please read this manual thoroughly before making connections and plugging in the unit. Following the instructions in this manual will enable you to obtain optimum performance and listening enjoyment from your new AV Receiver. Please retain this manual for future reference.

Contents

Introduction2

Connections.....11

Turning On & Basic Operations 19

Advanced Operations39

Controlling Other Components 53

Appendix59



WARNING:

TO REDUCE THE RISK OF FIRE OR ELECTRIC SHOCK, DO NOT EXPOSE THIS APPARATUS TO RAIN OR MOISTURE.

CAUTION:

TO REDUCE THE RISK OF ELECTRIC SHOCK, DO NOT REMOVE COVER (OR BACK). NO USER-SERVICEABLE PARTS INSIDE. REFER SERVICING TO QUALIFIED SERVICE PERSONNEL.



WARNING
RISK OF ELECTRIC SHOCK
DO NOT OPEN

AVIS
RISQUE DE CHOC ELECTRIQUE
NE PAS OUVRIR



The lightning flash with arrowhead symbol, within an equilateral triangle, is intended to alert the user to the presence of uninsulated "dangerous voltage" within the product's enclosure that may be of sufficient magnitude to constitute a risk of electric shock to persons.



The exclamation point within an equilateral triangle is intended to alert the user to the presence of important operating and maintenance (servicing) instructions in the literature accompanying the appliance.

Important Safety Instructions

1. Read these instructions.
2. Keep these instructions.
3. Heed all warnings.
4. Follow all instructions.
5. Do not use this apparatus near water.
6. Clean only with dry cloth.
7. Do not block any ventilation openings. Install in accordance with the manufacturer's instructions.
8. Do not install near any heat sources such as radiators, heat registers, stoves, or other apparatus (including amplifiers) that produce heat.
9. Do not defeat the safety purpose of the polarized or grounding-type plug. A polarized plug has two blades with one wider than the other. A grounding type plug has two blades and a third grounding prong. The wide blade or the third prong are provided for your safety. If the provided plug does not fit into your outlet, consult an electrician for replacement of the obsolete outlet.
10. Protect the power cord from being walked on or pinched particularly at plugs, convenience receptacles, and the point where they exit from the apparatus.
11. Only use attachments/accessories specified by the manufacturer.
12. Use only with the cart, stand, tripod, bracket, or table specified by the manufacturer, or sold with the apparatus. When a cart is used, use caution when moving the cart/apparatus combination to avoid injury from tip-over.

PORTABLE CART WARNING
S3125A
13. Unplug this apparatus during lightning storms or when unused for long periods of time.
14. Refer all servicing to qualified service personnel. Servicing is required when the apparatus has been damaged in any way, such as power-supply cord or plug is damaged, liquid has been spilled or objects have fallen into the apparatus, the apparatus has been exposed to rain or moisture, does not operate normally, or has been dropped.
15. Damage Requiring Service
Unplug the apparatus from the wall outlet and refer servicing to qualified service personnel under the following conditions:
 - A. When the power-supply cord or plug is damaged,
 - B. If liquid has been spilled, or objects have fallen into the apparatus,
 - C. If the apparatus has been exposed to rain or water,
 - D. If the apparatus does not operate normally by following the operating instructions. Adjust only those controls that are covered by the operating instructions as an improper adjustment of other controls may result in damage and will often require extensive work by a qualified technician to restore the apparatus to its normal operation,
 - E. If the apparatus has been dropped or damaged in any way, and
 - F. When the apparatus exhibits a distinct change in performance this indicates a need for service.
16. Object and Liquid Entry
Never push objects of any kind into the apparatus through openings as they may touch dangerous voltage points or short-out parts that could result in a fire or electric shock.
The apparatus shall not be exposed to dripping or splashing and no objects filled with liquids, such as vases shall be placed on the apparatus.
Don't put candles or other burning objects on top of this unit.
17. Batteries
Always consider the environmental issues and follow local regulations when disposing of batteries.
18. If you install the apparatus in a built-in installation, such as a bookcase or rack, ensure that there is adequate ventilation.
Leave 20 cm (8") of free space at the top and sides and 10 cm (4") at the rear. The rear edge of the shelf or board above the apparatus shall be set 10 cm (4") away from the rear panel or wall, creating a flue-like gap for warm air to escape.
The temperature protection operates if the apparatus attain an abnormal high temperature.
The apparatus cannot operate until it has cooled down.

Precautions

1. **Recording Copyright**—Unless it's for personal use only, recording copyrighted material is illegal without the permission of the copyright holder.
2. **AC Fuse**—The AC fuse inside the unit is not user-serviceable. If you cannot turn on the unit, contact your Onkyo dealer.
3. **Care**—Occasionally you should dust the unit all over with a soft cloth. For stubborn stains, use a soft cloth dampened with a weak solution of mild detergent and water. Dry the unit immediately afterwards with a clean cloth. Don't use abrasive cloths, thinners, alcohol, or other chemical solvents, because they may damage the finish or remove the panel lettering.

4. Power

WARNING

BEFORE PLUGGING IN THE UNIT FOR THE FIRST TIME, READ THE FOLLOWING SECTION CAREFULLY.

AC outlet voltages vary from country to country. Make sure that the voltage in your area meets the voltage requirements printed on the unit's rear panel (e.g., AC 230 V, 50 Hz or AC 120 V, 60 Hz).

The power cord plug is used to disconnect this unit from the AC power source. Make sure that the plug is readily operable (easily accessible) at all times.

Pressing the [ON/STANDBY] button to select Standby mode does not fully disconnect from the mains. If you do not intend to use the unit for an extended period, remove the power cord from the AC outlet.

5. Preventing Hearing Loss

Caution

Excessive sound pressure from earphones and headphones can cause hearing loss.

6. Batteries and Heat Exposure

Warning

Batteries (battery pack or batteries installed) shall not be exposed to excessive heat as sunshine, fire or the like.

7. Never Touch this Unit with Wet Hands

—Never handle this unit or its power cord while your hands are wet or damp. If water or any other liquid gets inside this unit, have it checked by your Onkyo dealer.

8. Handling Notes

- If you need to transport this unit, use the original packaging to pack it how it was when you originally bought it.
- Do not leave rubber or plastic items on this unit for a long time, because they may leave marks on the case.
- This unit's top and rear panels may get warm after prolonged use. This is normal.
- If you do not use this unit for a long time, it may not work properly the next time you turn it on, so be sure to use it occasionally.

For U.S. models

FCC Information for User

CAUTION:

The user changes or modifications not expressly approved by the party responsible for compliance could void the user's authority to operate the equipment.

NOTE:

This equipment has been tested and found to comply with the limits for a Class B digital device, pursuant to Part 15 of the FCC Rules. These limits are designed to provide reasonable protection against harmful interference in a residential installation.

This equipment generates, uses and can radiate radio frequency energy and, if not installed and used in accordance with the instructions, may cause harmful interference to radio communications. However, there is no guarantee that interference will not occur in a particular installation. If this equipment does cause harmful interference to radio or television reception, which can be determined by turning the equipment off and on, the user is encouraged to try to correct the interference by one or more of the following measures:

- Reorient or relocate the receiving antenna.
- Increase the separation between the equipment and receiver.
- Connect the equipment into an outlet on a circuit different from that to which the receiver is connected.
- Consult the dealer or an experienced radio/TV technician for help.

For Canadian Models

NOTE: THIS CLASS B DIGITAL APPARATUS COMPLIES WITH CANADIAN ICES-003.

For models having a power cord with a polarized plug:

CAUTION: TO PREVENT ELECTRIC SHOCK, MATCH WIDE BLADE OF PLUG TO WIDE SLOT, FULLY INSERT.

Modèle pour les Canadien

REMARQUE: CET APPAREIL NUMÉRIQUE DE LA CLASSE B EST CONFORME À LA NORME NMB-003 DU CANADA.

Sur les modèles dont la fiche est polarisée:

ATTENTION: POUR ÉVITER LES CHOCS ÉLECTRIQUES, INTRODUIRE LA LAME LA PLUS LARGE DE LA FICHE DANS LA BORNE CORRESPONDANTE DE LA PRISE ET POUSSER JUSQU'AU FOND.

For British models

Replacement and mounting of an AC plug on the power supply cord of this unit should be performed only by qualified service personnel.

IMPORTANT

The wires in the mains lead are coloured in accordance with the following code:

Blue: Neutral

Brown: Live

As the colours of the wires in the mains lead of this apparatus may not correspond with the coloured markings identifying the terminals in your plug, proceed as follows:

The wire which is coloured blue must be connected to the terminal which is marked with the letter N or coloured black.

The wire which is coloured brown must be connected to the terminal which is marked with the letter L or coloured red.

IMPORTANT

The plug is fitted with an appropriate fuse. If the fuse needs to be replaced, the replacement fuse must be approved by ASTA or BSI to BS1362 and have the same ampere rating as that indicated on the plug. Check for the ASTA mark or the BSI mark on the body of the fuse.

If the power cord's plug is not suitable for your socket outlets, cut it off and fit a suitable plug. Fit a suitable fuse in the plug.

For European Models

Declaration of Conformity

We, ONKYO EUROPE ELECTRONICS GmbH
LIEGNITZERSTRASSE 6,
82194 GROEBENZELL,
GERMANY

CE

declare in own responsibility, that the ONKYO product described in this instruction manual is in compliance with the corresponding technical standards such as EN60065, EN55013, EN55020 and EN61000-3-2, -3-3.

GROEBENZELL, GERMANY

K. MIYAGI

ONKYO EUROPE ELECTRONICS GmbH

Supplied Accessories

Make sure you have the following accessories:

Indoor FM antenna (→ page 18)

AM loop antenna (→ page 18)

Power cord (Taiwan models) (→ page 18)

Speaker cable labels (→ page 12)

(Not supplied with the Home Theater System.)

Speaker setup microphone (→ page 28)

Remote controller (RC-801M) and two batteries (AA/R6) (→ page 4)

(Note for China: The battery for the remote controller is not supplied for this unit.)

* In catalogs and on packaging, the letter at the end of the product name indicates the color. Specifications and operations are the same regardless of color.

■ Installing the batteries

Note

- If the remote controller doesn't work reliably, try replacing the batteries.
- Don't mix new and old batteries or different types of batteries.
- If you intend not to use the remote controller for a long time, remove the batteries to prevent damage from leakage or corrosion.
- Remove expired batteries as soon as possible to prevent damage from leakage or corrosion.

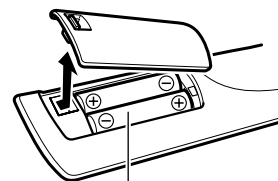

Batteries (AA/R6)

■ Aiming the remote controller

To use the remote controller, point it at the AV receiver's remote control sensor, as shown below.

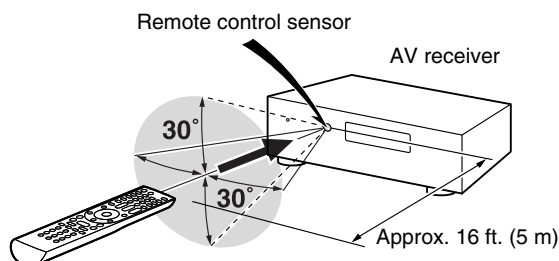

Contents

Introduction

Important Safety Instructions	2
Precautions.....	3
Supplied Accessories.....	4
Features	6
Front & Rear Panels.....	7
Front Panel.....	7
Display.....	8
Rear Panel	9
Remote Controller.....	10
Controlling the AV Receiver	10

Connections

Connecting the AV Receiver.....	11
Connecting Your Speakers	11
About AV Connections	14
Connecting Components with HDMI	15
Connecting Your Components	16
Connecting Onkyo RI Components	17
Connecting a Recording Component	17
Connecting the Antennas	18
Connecting the Power Cord	18

Turning On & Basic Operations

Turning On/Off the AV Receiver	19
Turning On	19
Turning Off	19
Playback.....	20
Playing the Connected Component.....	20
Controlling Contents of USB or Network Devices	20
Understanding Icons on the Display.....	21
Playing an iPod/iPhone via USB	21
Playing a USB Device	22
Listening to Internet Radio	22
Playing Music Files on a Server	24
Remote Playback	24
Listening to AM/FM Radio	25
Using Basic Functions	28
Using the Automatic Speaker Setup	28
Using the Listening Modes	31
Using the Home Menu.....	36
Using the Sleep Timer.....	36
Setting the Display Brightness	36
Displaying Source Information	36
Changing the Input Display	37
Using the Music Optimizer	37
Muting the AV Receiver.....	37
Using Headphones.....	37
Recording	37

Advanced Operations

Advanced Setup	39
On-screen Setup Menus.....	39
Common Procedures in Setup Menu	39
HDMI Input	40
Component (Component Video Input).....	40
Digital Audio (Digital Audio Input).....	40
Sp Config (Speaker Configuration).....	41
Sp Distance (Speaker Distance)	42
Level Cal (Level Calibration)	42
Audio Adjust	43
Source Setup.....	44
Hardware	46
HDMI Setup	48
Network Setup	49
Update	50
Using the Audio Settings	50
Zone 2.....	52
Making Zone 2 Connections	52
Controlling Zone 2 Components.....	52

Controlling Other Components

iPod/iPhone Playback via Onkyo Dock	53
Using the Onkyo Dock.....	53
Controlling Your iPod/iPhone	54
Controlling Other Components.....	56
Preprogrammed Remote Control Codes	56
Entering Remote Control Codes.....	56
Remote Control Codes for	
Onkyo Components Connected via RI	56
Resetting REMOTE MODE Buttons	57
Resetting the Remote Controller	57
Controlling Other Components	57

Appendix

Troubleshooting	59
Network/USB Features.....	64
Firmware Update	66
Connection Tips and Video Signal Path	70
About HDMI.....	71
Using an RIHD-compatible TV, Player, or Recorder.....	72
Specifications	74

To reset the AV receiver to its factory defaults, turn it on and, while holding down VCR/DVR, press **⏻ ON/STANDBY** (→ page 59).

Features

Amplifier

- 80 Watts/Channel @ 8 ohms (FTC)
- 130 Watts/Channel @ 6 ohms (IEC)
- 160 Watts/Channel @ 6 ohms (JEITA)
- Optimum Gain Volume Circuitry
- H.C.P.S. (High Current Power Supply) Massive High Power Transformer

Processing

- HDMI (Audio Return Channel, 3D, DeepColor, x.v.Color*¹, Lip Sync, DTS*²-HD Master Audio, DTS-HD High Resolution Audio, Dolby TrueHD*³, Dolby Digital Plus, DSD and Multi-CH PCM)
- Non-Scaling Configuration
- A-Form Listening Mode Memory
- Direct Mode
- Pure Audio Mode (**European, Australian and Asian models**)
- Music Optimizer*⁴ for Compressed Digital Music files
- 192 kHz/24-bit D/A Converters
- Powerful and Highly Accurate 32-bit Processing DSP

Connections

- 4 HDMI*⁵ Inputs and 1 Output
- Onkyo **RIHD** for System Control
- 4 Digital Inputs (2 Optical/2 Coaxial)
- Component Video Switching (2 Inputs/1 Output)
- Universal Port for the Dock for iPod®/iPhone®*⁶/HD Radio™*⁷ tuner module (**North American models**)/DAB+ tuner module (**European, Australian and Asian models**)
- Banana Plug-Compatible Speaker Posts*⁸
- Internet Radio Connectivity (SIRIUS Internet Radio/vTuner/Last.fm/Pandora/Rhapsody/Slacker/Mediafly/Napster)
* Services available may vary depending on the region.
- Network Capability for Streaming Audio Files*¹⁰
- Front-Panel USB Input for Memory Devices and iPod®/iPhone®*⁶ models

Miscellaneous

- 40 FM/AM Presets
- Audyssey 2EQ*⁹ to correct room acoustic problems
- Audyssey Dynamic EQ*⁹ for loudness correction
- Audyssey Dynamic Volume*⁹ to maintain optimal listening level and dynamic range
- Crossover Adjustment (40/50/60/70/80/90/100/120/150/200 Hz)
- A/V Sync Control Function (up to 400 ms)
- Auto Standby Function
- On-Screen Display via HDMI
- Preprogrammed **RI**-Compatible Remote

*¹ “x.v.Color” is a trademark of Sony Corporation.

*²  **DTS-HD Master Audio**

Manufactured under license under U.S. Patent #'s: 5,451,942; 5,956,674; 5,974,380; 5,978,762; 6,226,616; 6,487,535; 7,212,872; 7,333,929; 7,392,195; 7,272,567 & other U.S. and worldwide patents issued & pending. DTS and the Symbol are registered trademarks, & DTS-HD, DTS-HD Master Audio, and the DTS logos are trademarks of DTS, Inc. Product includes software.

© DTS, Inc. All Rights Reserved.

*³  **DOLBY TRUEHD**

Manufactured under license from Dolby Laboratories. Dolby, Pro Logic and the double-D symbol are trademarks of Dolby Laboratories.

*⁴ Music Optimizer™ is a trademark of Onkyo Corporation.

*⁵  **HDMI**
HIGH-DEFINITION MULTIMEDIA INTERFACE

“HDMI, the HDMI Logo, and High-Definition Multimedia Interface are trademarks or registered trademarks of HDMI Licensing LLC in the United States and other countries.”

*⁶



iPhone, iPod, iPod classic, iPod nano, iPod shuffle, and iPod touch are trademarks of Apple Inc., registered in the U.S. and other countries.

“Made for iPod” and “Made for iPhone” mean that an electronic accessory has been designed to connect specifically to iPod or iPhone, respectively, and has been certified by the developer to meet Apple performance standards. Apple is not responsible for the operation of this device or its compliance with safety and regulatory standards.

Please note that the use of this accessory with iPod or iPhone may affect wireless performance.

*⁷  **HD Radio**
READY

The HD Radio Ready logo is a proprietary trademark of iBiquity Digital Corp.

To receive HD Radio broadcasts, you must install an Onkyo UP-HT1 HD Radio tuner module (sold separately).

*⁸ In Europe, using banana plugs to connect speakers to an audio amplifier is prohibited.

*⁹  **AUDYSSEY**
2EQ
DYNAMIC VOLUME

Manufactured under license from Audyssey Laboratories™, Inc. U.S. and foreign patents pending. Audyssey 2EQ®, Audyssey Dynamic EQ® and Audyssey Dynamic Volume® are registered trademarks of Audyssey Laboratories, Inc.

*¹⁰ “DLNA®, the DLNA Logo and DLNA CERTIFIED™ are trademarks, service marks, or certification marks of the Digital Living Network Alliance.”

*¹⁰ Windows and the Windows logo are trademarks of the Microsoft group of companies.

Front & Rear Panels

Front Panel

(North American and Taiwan models)

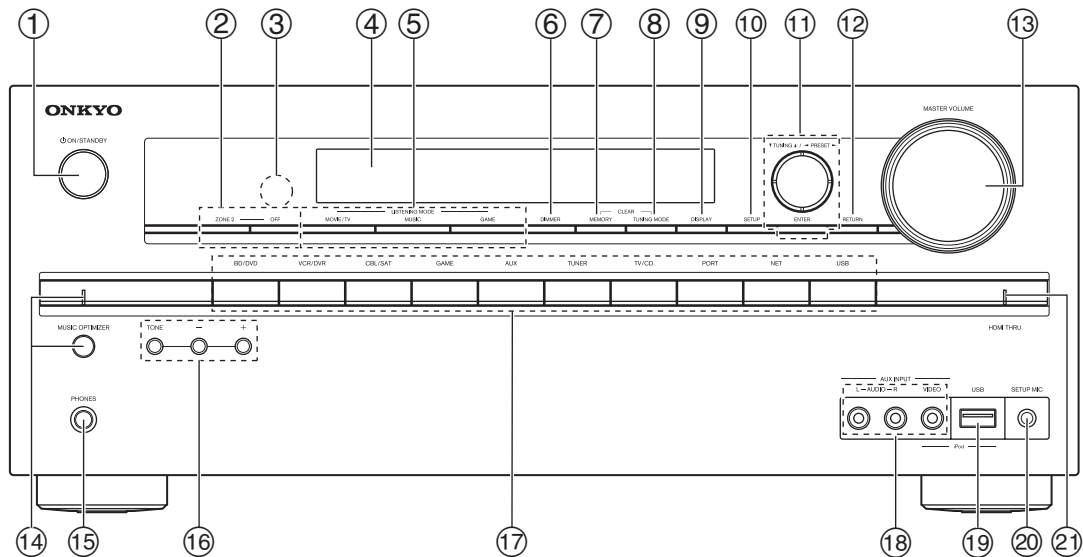

(European, Australian and Asian models)

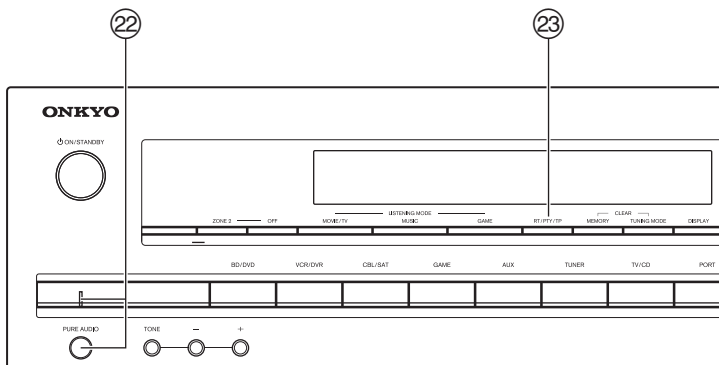

The page numbers in parentheses show where you can find the main explanation for each item.

- | | |
|---|--|
| ① ON/STANDBY button (19) | ⑭ MUSIC OPTIMIZER button and indicator (North American and Taiwan models) (37, 51) |
| ② ZONE 2, OFF buttons (52) | ⑮ PHONES jack (37) |
| ③ Remote control sensor (4) | ⑯ TONE and Tone Level buttons (50) |
| ④ Display (8) | ⑰ Input selector buttons (20) |
| ⑤ LISTENING MODE buttons (31) | ⑱ AUX INPUT AUDIO/VIDEO jacks (16) |
| ⑥ DIMMER button (North American and Taiwan models) (36) | ⑲ USB port (16) |
| ⑦ MEMORY button (26) | ⑳ SETUP MIC jack (28) |
| ⑧ TUNING MODE button (25) | ㉑ HDMI THRU indicator (48) |
| ⑨ DISPLAY button (36) | ㉒ PURE AUDIO button and indicator (European, Australian and Asian models) (31) |
| ⑩ SETUP button (39) | ㉓ RT/PTY/TP button (European, Australian and Asian models) (27) |
| ⑪ TUNING, PRESET (25), arrow and ENTER buttons | |
| ⑫ RETURN button | |
| ⑬ MASTER VOLUME control (20) | |

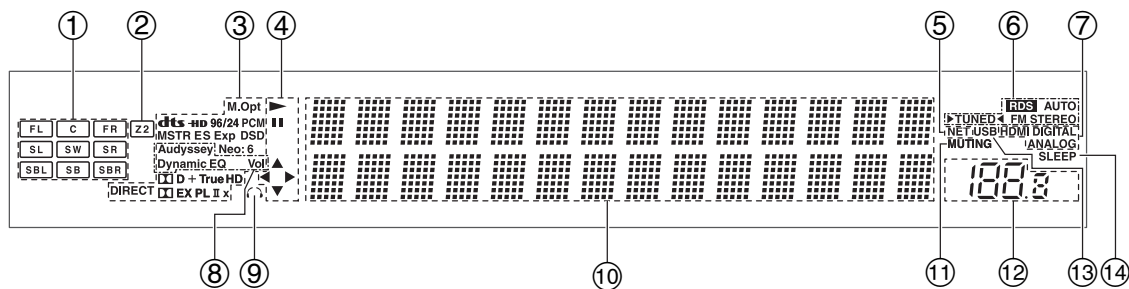

For detailed information, see the pages in parentheses.

- ① **Speaker/channel indicators**
- ② **Z2 (Zone 2) indicator (52)**
- ③ **Listening mode and format indicators (31, 51)**
- ④ **►, ▮ and cursor indicators (21)**
- ⑤ **NET indicator (22, 49)**
- ⑥ **Tuning indicators**
RDS indicator (excluding North American and Taiwan models) (26)
AUTO indicator (25)
TUNED indicator (25)
FM STEREO indicator (25)
- ⑦ **Audio input indicators**
- ⑧ **Audyssey indicator (28, 44)**
Dynamic EQ indicator (44)
Dynamic Vol indicator (45)
- ⑨ **Headphone indicator (37)**
- ⑩ **Message area**
- ⑪ **MUTING indicator (37)**
- ⑫ **Volume level (20)**
- ⑬ **USB indicator (21, 22)**
- ⑭ **SLEEP indicator (36, 47)**

Rear Panel

(North American, European, Australian and Asian models)

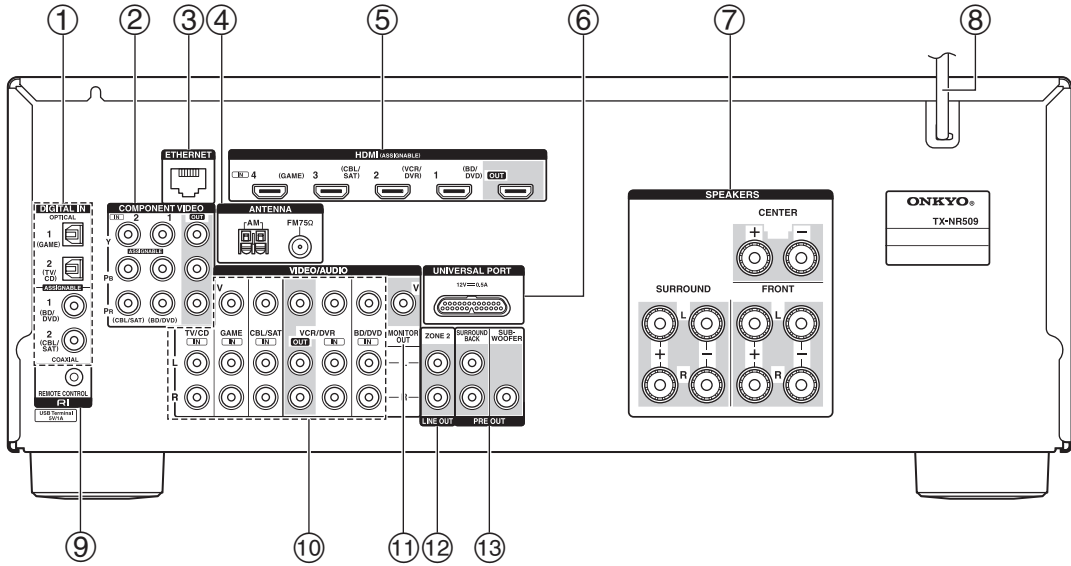

(Taiwan models)

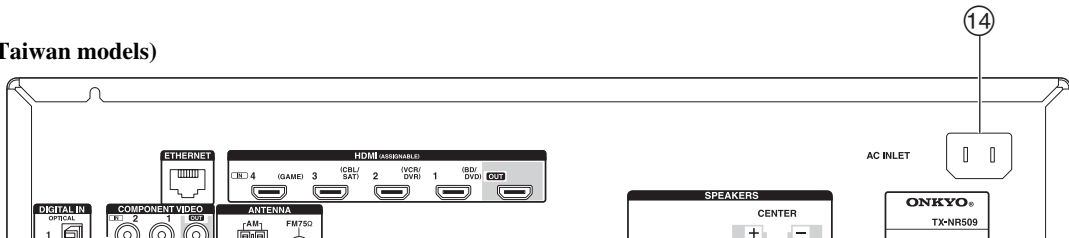

- ① **DIGITAL IN COAXIAL and OPTICAL jacks**
- ② **COMPONENT VIDEO IN and OUT jacks**
- ③ **ETHERNET port**
- ④ **FM ANTENNA jack and AM ANTENNA terminal**
- ⑤ **HDMI IN and OUT jacks**
- ⑥ **UNIVERSAL PORT jack**
- ⑦ **SPEAKERS terminals (CENTER, FRONT, SURROUND)**
- ⑧ **Power cord (North American, European, Australian and Asian models)**
- ⑨ **RI REMOTE CONTROL jack**
- ⑩ **Composite video and analog audio jacks (BD/DVD IN, VCR/DVR IN and OUT, CBL/SAT IN, GAME IN, TV/CD IN)**
- ⑪ **MONITOR OUT V jack**
- ⑫ **ZONE 2 LINE OUT jacks**
- ⑬ **PRE OUT jacks (SURROUND BACK and SUBWOOFER)**
- ⑭ **AC INLET (Taiwan models)**

See "Connecting the AV Receiver" for connection
 (→ pages 11 to 18).

Remote Controller

Controlling the AV Receiver

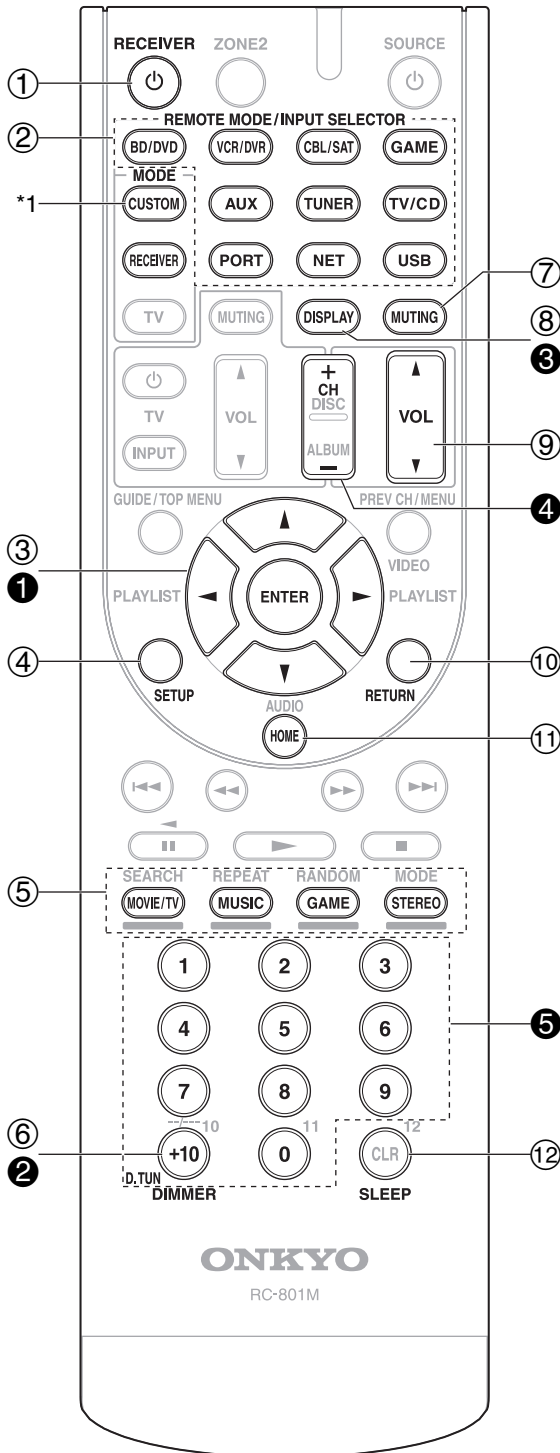

To control the AV receiver, you need to select Receiver mode by pressing **RECEIVER**.

You can also control Onkyo Blu-ray Disc/DVD player, CD player and other components to control with the remote controller.

See “Entering Remote Control Codes” for more details (→ page 56).

For detailed information, see the pages in parentheses.

- ① **RECEIVER** button (19)
- ② **REMOTE MODE/INPUT SELECTOR** buttons (20)
- ③ Arrow **▲/▼/◀/▶** and **ENTER** buttons
- ④ **SETUP** button (39)
- ⑤ **LISTENING MODE** buttons (31)
- ⑥ **DIMMER** button (36)
- ⑦ **MUTING** button (37)
- ⑧ **DISPLAY** button (36)
- ⑨ **VOL ▲/▼** button (20)
- ⑩ **RETURN** button
- ⑪ **HOME** button (36, 50)
- ⑫ **SLEEP** button (36)

■ Controlling the tuner

To control the AV receiver’s tuner, press **TUNER** (or **RECEIVER**).

You can select AM or FM by pressing **TUNER** repeatedly.

- ① Arrow **▲/▼** buttons (25)
- ② **D.TUN** button (26)
- ③ **DISPLAY** button
- ④ **CH +/-** button (26)
- ⑤ **Number** buttons (26)

*1 To control component, you must first enter remote control code.

See “Entering Remote Control Codes” for more details (→ page 56).

Connecting the AV Receiver

Connecting Your Speakers

Connecting the Speaker Cables

The following illustration shows which speaker should be connected to each pair of terminals. If you're using only one surround back speaker, connect it to the **SURROUND BACK L PRE OUT** jack.

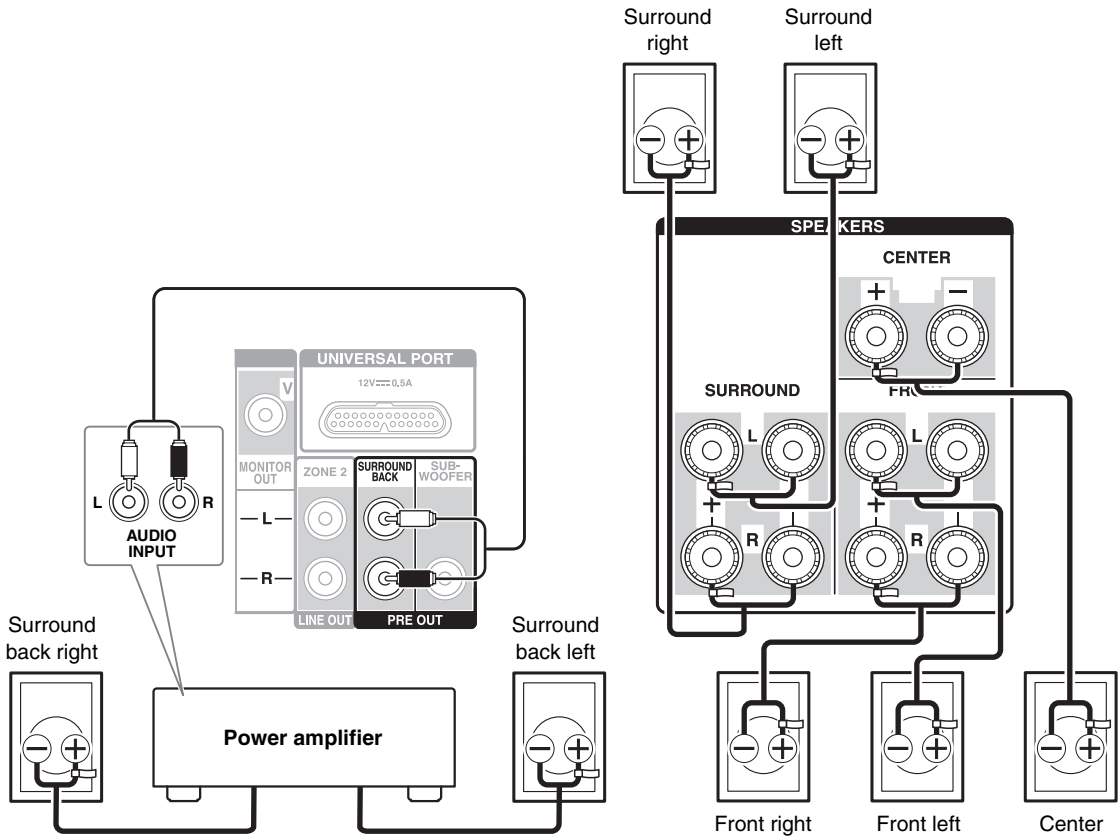

Connect your Power amplifier's analog audio input jacks to the AV receiver's **SURROUND BACK L/R PRE OUT** jacks with audio cables.

■ Screw-type speaker terminals

Strip 1/2" to 5/8" (12 to 15 mm) of insulation from the ends of the speaker cables, and twist the bare wires tightly, as shown.

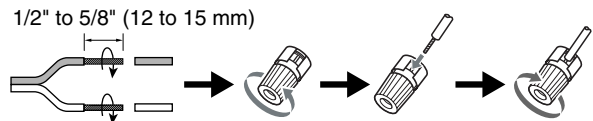

■ Banana Plugs (North American models)

- If you are using banana plugs, tighten the speaker terminal before inserting the banana plug.
- Do not insert the speaker code directly into the center hole of the speaker terminal.

Speaker Configuration

The following table indicates the channels you should use depending on the number of speakers that you have.

No matter how many speakers you use, a powered subwoofer is recommended for a really powerful and solid bass.

To get the best from your surround sound system, you need to set the speaker settings automatically (→ **page 28**) or manually (→ **page 41**).

Number of channels	2	3	4	5	6	7
Front speakers	✓	✓	✓	✓	✓	✓
Center speaker		✓		✓	✓	✓
Surround speakers			✓	✓	✓	✓
Surround back speaker*1					✓	
Surround back speakers						✓

*1 If you're using only one surround back speaker, connect it to the **SURROUND BACK L PRE OUT** jack.

Attaching the Speaker Cable Labels

The speaker terminals (and preout jacks) are color-coded for identification purpose.

Speaker	Color
Front left	White
Front right	Red
Center	Green
Surround left	Blue
Surround right	Gray
Surround back left	Brown
Surround back right	Tan

The supplied speaker cable labels are also color-coded and you should attach them to the positive (+) side of each speaker cable in accordance with the table above. Then all you need to do is to match the color of each label to the corresponding speaker terminal.



Note

- With the Home Theater System, speaker cable labels are not supplied.

Speaker Connection Precautions

Read the following before connecting your speakers:

- You can connect speakers with an impedance of between 6 and 16 ohms. If you use speakers with a lower impedance, and use the amplifier at high volume levels for a long period of time, the built-in amp protection circuit may be activated.
- Disconnect the power cord from the wall outlet before making any connections.
- Read the instructions supplied with your speakers.
- Pay close attention to speaker wiring polarity. In other words, connect positive (+) terminals only to positive (+) terminals, and negative (-) terminals only to negative (-) terminals. If you get them the wrong way around, the sound will be out of phase and will sound unnatural.
- Unnecessarily long, or very thin speaker cables may affect the sound quality and should be avoided.
- Be careful not to short the positive and negative wires. Doing so may damage the AV receiver.
- Make sure the metal core of the wire does not have contact with the AV receiver's rear panel. Doing so may damage the AV receiver.

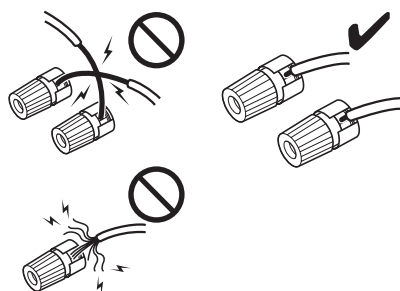

- Don't connect more than one cable to each speaker terminal. Doing so may damage the AV receiver.
- Don't connect one speaker to several terminals.

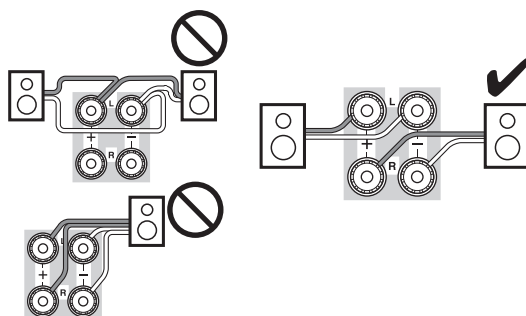

Using a Powered Subwoofer

To find the best position for your subwoofer, while playing a movie or some music with good bass, experiment by placing your subwoofer at various positions within the room, and choose the one that provides the most satisfying results.

Tip

- If your subwoofer is unpowered and you're using an external amplifier, connect the subwoofer pre out jack to an input on the amplifier.

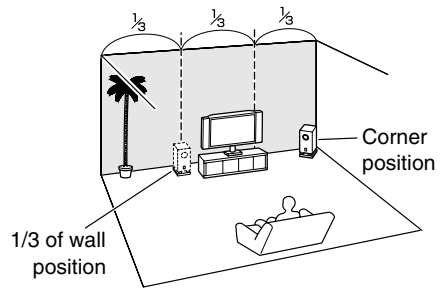
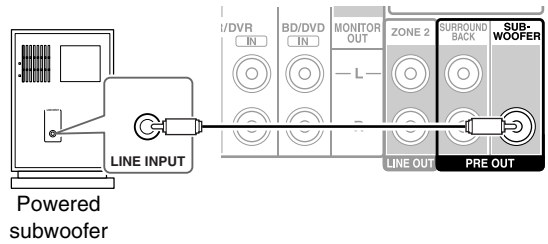



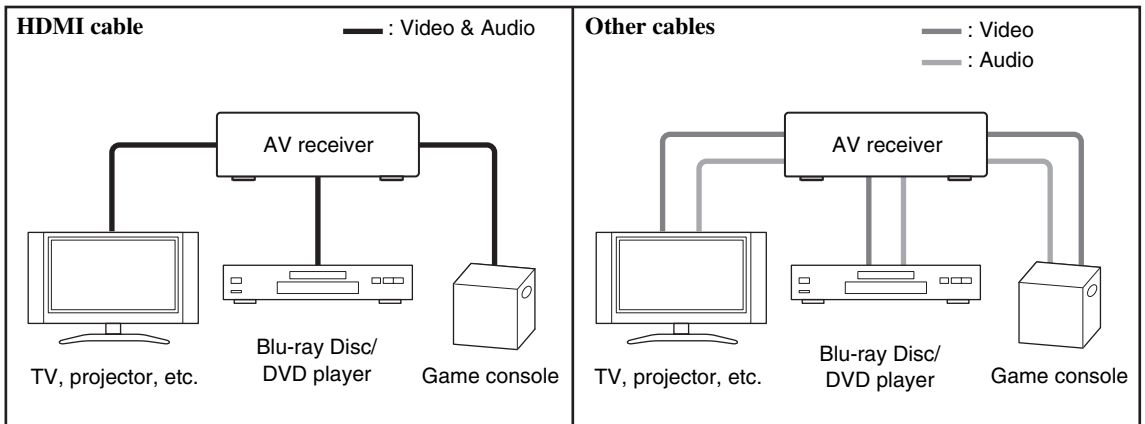

Connecting AV components

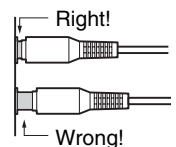

- Before making any AV connections, read the manuals supplied with your AV components.
- Don't connect the power cord until you've completed and double-checked all AV connections.
- Push plugs in all the way to make good connections (loose connections can cause noise or malfunctions).
- To prevent interference, keep audio and video cables away from power cords and speaker cables.

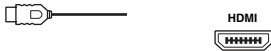
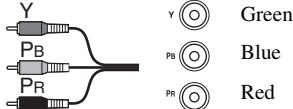
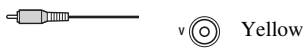

AV Cables and Jacks

Signal	Cable	Jack	Description
Video and Audio	HDMI		HDMI connections can carry digital video and audio.
Video	Component video	 <ul style="list-style-type: none"> Y Green PB Blue PR Red 	Component video separates the luminance (Y) and color difference signals (PB, PR), providing the best picture quality (some TV manufacturers label their component video sockets slightly differently).
	Composite video	 <ul style="list-style-type: none"> v Yellow 	Composite video is commonly used on TVs, VCRs, and other video equipment.
Audio	Optical digital audio	 <ul style="list-style-type: none"> OPTICAL 	Optical digital connections allow you to enjoy digital sound such as PCM*, Dolby Digital or DTS. The audio quality is the same as coaxial.
	Coaxial digital audio	 <ul style="list-style-type: none"> COAXIAL Orange 	Coaxial digital connections allow you to enjoy digital sound such as PCM*, Dolby Digital or DTS. The audio quality is the same as optical.
	Analog audio (RCA)	 <ul style="list-style-type: none"> L White R Red 	Analog audio connections (RCA) carry analog audio.

* Available sampling rate for PCM input signal is 32/44.1/48/88.2/96 kHz. In case of an HDMI connection, 176.4/192 kHz is also available.

Note

- The AV receiver does not support SCART plugs.
- The AV receiver's optical digital jacks have shutter-type covers that open when an optical plug is inserted and close when it's removed. Push plugs in all the way.

Caution

- To prevent shutter damage, hold the optical plug straight when inserting and removing.

Connecting Components with HDMI

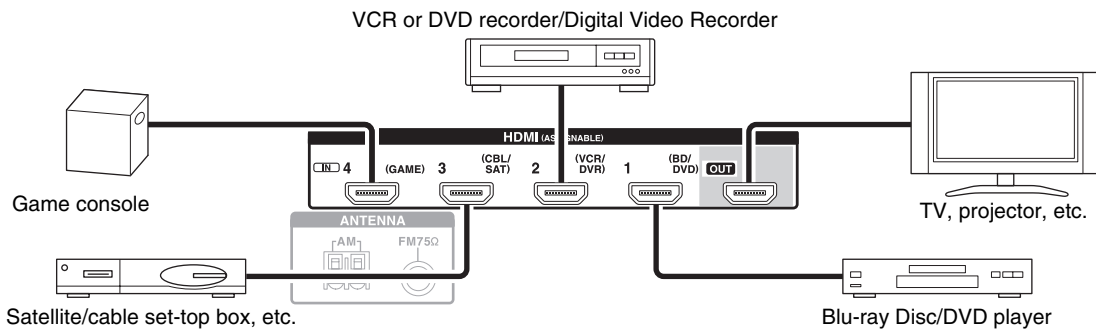

Connect your components to the appropriate jacks. The default input assignments are shown below.

✓: Assignment can be changed (→ [page 40](#)).

Jack	Components	Assignable	
Input	HDMI IN1	Blu-ray Disc/DVD player	✓
	HDMI IN2	VCR or DVD recorder/Digital Video Recorder	✓
	HDMI IN3	Satellite/cable set-top box, etc.	✓
	HDMI IN4	Game console	✓
Output	HDMI OUT	TV, projector, etc.	

See also:

- “Connection Tips and Video Signal Path” (→ [page 70](#)).
- “About HDMI” (→ [page 71](#))
- “Using an RIHD-compatible TV, Player, or Recorder” (→ [page 72](#)).

■ Audio return channel (ARC) function

Audio return channel (ARC) function enables an HDMI capable TV to send the audio stream to the **HDMI OUT** of the AV receiver.

- To use the ARC function, you must select the **TV/CD** input selector, your TV must be ARC capable and “**HDMI Ctrl (RIHD)**” must be set to “**On**” (→ [page 48](#)).

Tip

- To listen to audio received by the **HDMI IN** jacks through your TV’s speakers:
 - Set the “**HDMI Ctrl (RIHD)**” setting to “**On**” (→ [page 48](#)) for an **RIHD**-compatible TV.
 - Set the “**Audio TV Out**” setting to “**On**” (→ [page 48](#)) when the TV is not compatible with **RIHD**, or the “**HDMI Ctrl (RIHD)**” setting to “**Off**”.
 - Set your Blu-ray Disc/DVD player’s HDMI audio output setting to PCM.
 - To listen to TV audio through the AV receiver, see “Connecting Your Components” (→ [page 16](#)).

Note

- When listening to an HDMI component through the AV receiver, set the HDMI component so that its video can be seen on the TV screen (on the TV, select the input of the HDMI component connected to the AV receiver). If the TV power is off or the TV is set to another input source, this may result in no sound from the AV receiver or the sound may be cut off.
- When the “**Audio TV Out**” setting is set to “**On**” (→ [page 48](#)) to hear from your TV’s speakers, by controlling the AV receiver’s volume, the sound will be output from the AV receiver’s speakers, too. When the “**HDMI Ctrl (RIHD)**” setting is set to “**On**” (→ [page 48](#)) to hear from speakers of **RIHD**-compatible TV, by controlling the AV receiver’s volume, the AV receiver’s speakers will produce sound while the TV’s speakers are muted. To stop the AV receiver’s speakers producing sound, change the settings, change your TV’s settings, or turn down the AV receiver’s volume.

Connecting Your Components

The on-screen setup menus appear only on a TV that is connected to the **HDMI OUT**. If your TV is connected to the **MONITOR OUT V** or the **COMPONENT VIDEO OUT**, use the AV receiver's display when changing settings.

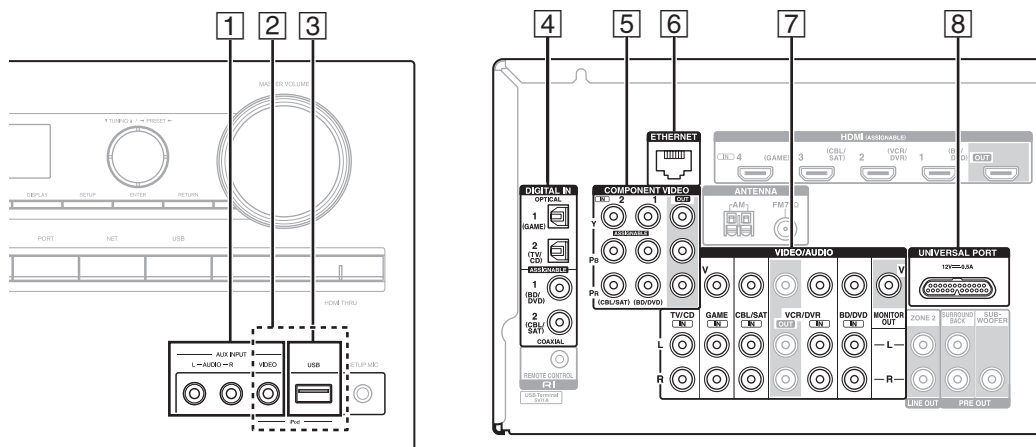

Connect your components to the appropriate jacks. The default input assignments are shown below. See “Connection Tips and Video Signal Path” for more information (→ [page 70](#)).

✓: Assignment can be changed (→ [page 40](#)).

No.	Jack/Port	Components	Assignable
①	AUX INPUT	VIDEO	Camcorder, etc
		AUDIO L/R	
②	USB, AUX INPUT VIDEO*1	iPod/iPhone (video playback)	
③	USB*2	iPod/iPhone, MP3 player, USB flash drive	
④	DIGITAL IN	OPTICAL	1 (GAME) Game console ✓ 2 (TV/CD) TV, CD player ✓
		COAXIAL	1 (BD/DVD) Blu-ray Disc/DVD player ✓ 2 (CBL/SAT) Satellite/cable set-top box, RI dock, etc. ✓
	COMPONENT VIDEO	IN 1 (BD/DVD)	Blu-ray Disc/DVD player, RI dock ✓
		IN 2 (CBL/SAT)	Satellite/cable set-top box, RI dock, etc. ✓
	MONITOR OUT	TV, projector, etc.	
⑥	ETHERNET	Router	
⑦	MONITOR OUT	TV, projector, etc.	
	BD/DVD IN	Blu-ray Disc/DVD player	
	VCR/DVR IN	VCR or DVD recorder/digital video recorder, RI dock	
	CBL/SAT IN	Satellite/cable set-top box, etc.	
	GAME IN	Game console, RI dock	
	TV/CD IN	TV, CD player, cassette tape deck, MD, CD-R, Turntable*3, RI dock	
⑧	UNIVERSAL PORT	Universal port option dock (UP-A1 etc.)	

Note

- *1 When **USB** input is selected, you can input video signals from the **AUX INPUT VIDEO** jack. Video signals input from **AUX INPUT VIDEO** will be output from the **MONITOR OUT** jack.
- *2 Do not connect the AV receiver's **USB** port to a USB port on your computer. Music on your computer cannot be played through the AV receiver in this way.
- *3 Connect a turntable (MM) that has a phono preamp built-in. If your turntable (MM) doesn't have it, you'll need a commercially available phono preamp.
If your turntable has a moving coil (MC) type cartridge, you'll need a commercially available MC head amp or MC transformer as well as a phono preamp. See your turntable's manual for details.
- With connection ⑦, you can listen and record audio from the external components while you are in Zone 2. You can listen and record audio from the external components in the main room; you can listen to the audio in Zone 2 as well.
- With connection ④, you can enjoy Dolby Digital and DTS. (To record or listen in Zone 2 as well, use ④ and ⑦.)

- If your Blu-ray Disc/DVD player has both the main stereo and multichannel outputs, be sure to connect the main stereo output using connection 7.

■ How to record a video source

See “Recording” to make a connection for video recording (→ page 37).

Connecting Onkyo RI Components

- 1 Make sure that each Onkyo component is connected with an analog audio cable (connection 7 in the hookup examples) (→ page 16).
- 2 Make the RI connection (see the illustration).
- 3 If you're using an RI Dock, or cassette tape deck, change the Input Display (→ page 37).

With RI (Remote Interactive), you can use the following special functions:

■ System On/Auto Power On

When you start playback on a component connected via RI, while the AV receiver is on Standby, the AV receiver will automatically turn on and select that component as the input source.

■ Direct Change

When playback is started on a component connected via RI, the AV receiver automatically selects that component as the input source.

■ Remote Control

You can use the AV receiver's remote controller to control your other RI-capable Onkyo components, pointing the remote controller at the AV receiver's remote control sensor instead of the component. You must enter the appropriate remote control code first (→ page 56).

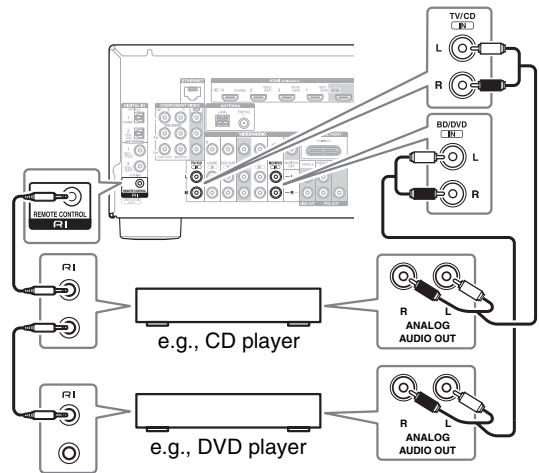

Note

- Use only RI cables for RI connections. RI cables are supplied with Onkyo players (DVD, CD, etc.).
- Some components have two RI jacks. You can connect either one to the AV receiver. The other jack is for connecting additional RI-capable components.
- Connect only Onkyo components to RI jacks. Connecting other manufacturer's components may cause a malfunction.
- Some components may not support all RI functions. Refer to the manuals supplied with your Onkyo components.
- While Zone 2 is on, the System On/Auto Power On and Direct Change RI functions do not work.

Connecting a Recording Component

See “Recording” on the recording (→ page 37).

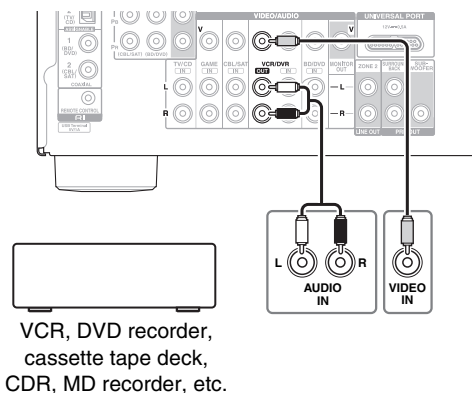

VCR, DVD recorder, cassette tape deck, CDR, MD recorder, etc.

Note

- The AV receiver must be turned on for recording. Recording is not possible while it's in Standby mode.
- If you want to record directly from your TV or playback VCR to the recording VCR without going through the AV receiver, connect the TV/VCR's audio and video outputs directly to the recording VCR's audio and video inputs. See the manuals supplied with your TV and VCR for details.
- Video signals connected to composite video inputs can be recorded only via composite video outputs. If your TV/VCR is connected to a composite video input, the recording VCR must be connected to a composite video output.
- The surround sound and DSP listening modes cannot be recorded.
- Copy-protected Blu-ray discs and DVDs cannot be recorded.
- Sources connected to a digital input cannot be recorded. Only analog inputs can be recorded.
- DTS signals will be recorded as noise, so don't attempt analog recording of DTS CDs or LDs.
- (European, Australian and Asian models) While the listening mode is set to Pure Audio, no image is provided because the power is turned off for the video circuit. If you want to make recordings, select other listening mode.

Connecting the Antennas

This section explains how to connect the supplied indoor FM antenna and AM loop antenna.

The AV receiver won't pick up any radio signals without any antenna connected, so you must connect the antenna to use the tuner.

Caution

- Be careful not to injure yourself when using thumbtacks.

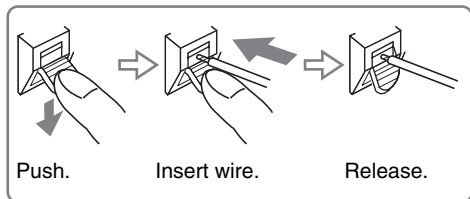

North American and Taiwan models

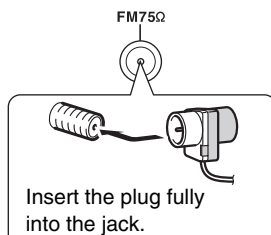

European, Australian and Asian models

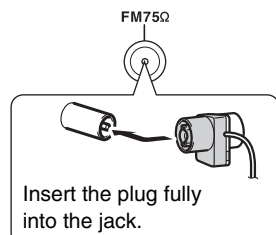

Assembling the AM loop antenna

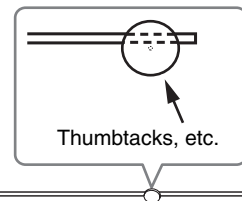
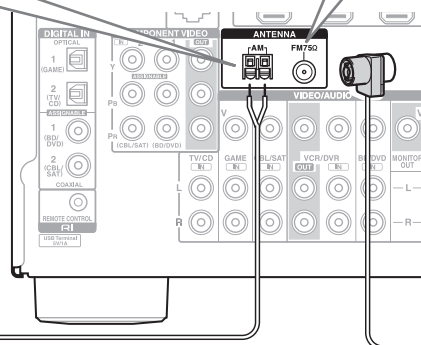
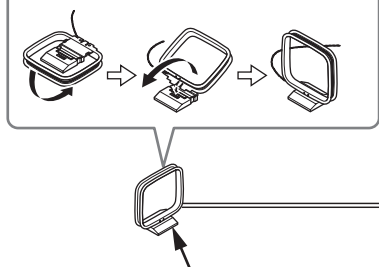

Indoor FM antenna (supplied)

Note

- Once your AV receiver is ready for use, you'll need to tune into a radio station and position the antenna to achieve the best possible reception.
- Keep the AM loop antenna as far away as possible from your AV receiver, TV, speaker cables, and power cords.

Tip

- If you cannot achieve good reception with the supplied indoor FM antenna, try a commercially available outdoor FM antenna instead.
- If you cannot achieve good reception with the supplied indoor AM loop antenna, try using it with a commercially available outdoor AM antenna.

Connecting the Power Cord

1 (Taiwan models)

Connect the supplied power cord to the AV receiver's **AC INLET**.

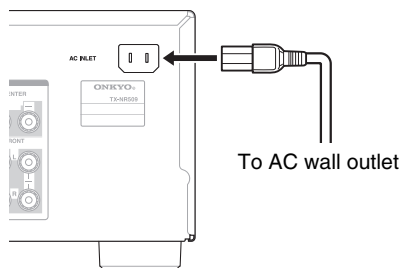

Note

- Before connecting the power cord, connect all of your speakers and AV components.
- Turning on the AV receiver may cause a momentary power surge that might interfere with other electrical equipment on the same circuit. If this is a problem, plug the AV receiver into a different branch circuit.
- Do not use a power cord other than the one supplied with the AV receiver. The supplied power cord is designed exclusively for use with the AV receiver and should not be used with any other equipment.
- Never disconnect the power cord from the AV receiver while the other end is still plugged into a wall outlet. Doing so may cause an electric shock. Always disconnect the power cord from the wall outlet first, and then the AV receiver.

2 Plug the power cord into an AC wall outlet.

Turning On/Off the AV Receiver

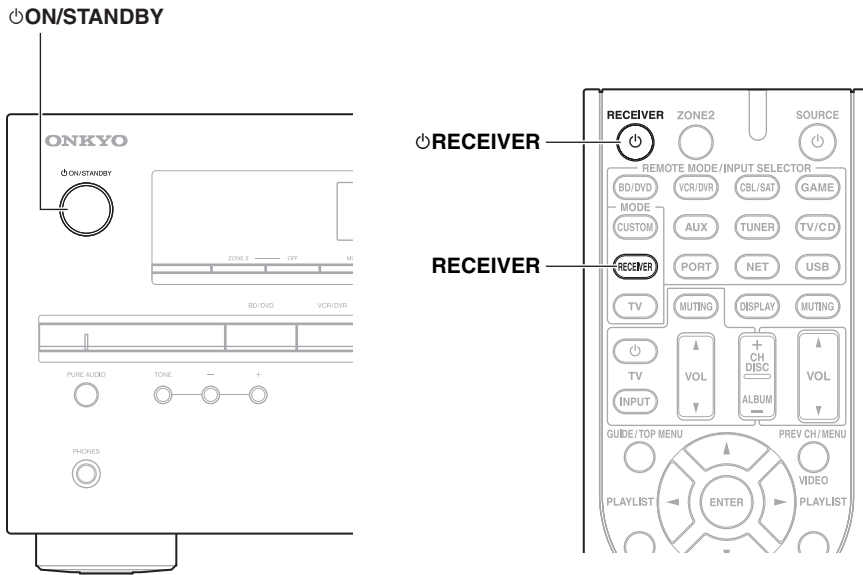

Turning On

1 Press **ON/STANDBY** on the front panel.

or

Press **RECEIVER** followed by **RECEIVER** on the remote controller.

The AV receiver comes on, the display lights.

Turning Off

1 Press **ON/STANDBY** on the front panel.

or

Press **RECEIVER** followed by **RECEIVER** on the remote controller.

The AV receiver will enter standby mode. To prevent any loud surprises when you turn on the AV receiver, always turn down the volume before you turn it off.

Tip

- For details on power management settings, see “Auto Standby” (→ [page 47](#)).

Playback

The on-screen menus appear only on a TV that is connected to the **HDMI OUT**. If your TV is connected to the **MONITOR OUT V** or the **COMPONENT VIDEO OUT**, use the AV receiver's display when changing settings.

This section describes the procedure for using the remote controller, unless otherwise specified.

Playing the Connected Component

■ Operating with the remote controller

- 1** Press **RECEIVER** followed by **INPUT SELECTOR**.
- 2** Start playback on the source component.
See also:
 - “Playing an iPod/iPhone via USB” (→ page 21)
 - “Playing a USB Device” (→ page 22)
 - “Listening to Internet Radio” (→ page 22)
 - “Playing Music Files on a Server” (→ page 24)
 - “Remote Playback” (→ page 24)
 - “Listening to AM/FM Radio” (→ page 25)
 - “iPod/iPhone Playback via Onkyo Dock” (→ page 53)
 - “Controlling Other Components” (→ page 56)
- 3** To adjust the volume, use **VOL ▲/▼**.
- 4** Select a listening mode and enjoy!
See also:
 - “Using the Listening Modes” (→ page 31)
 - “Audyssey” (→ page 44)

■ Operating on the AV receiver

- 1** Use the input selector buttons to select the input source.
- 2** Start playback on the source component.
- 3** To adjust the volume, use the **MASTER VOLUME** control.
- 4** Select a listening mode and enjoy!

Controlling Contents of USB or Network Devices

See “Controlling Other Components” about the operation of other components (→ page 56).

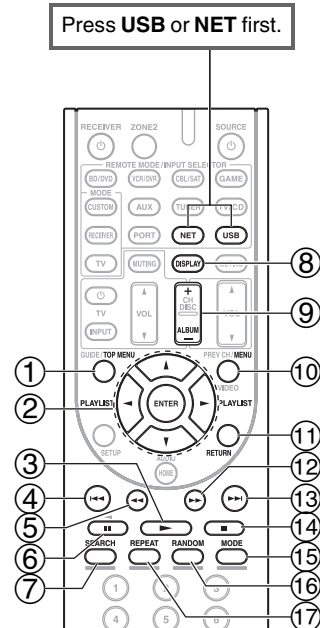

①	TOP MENU This button displays the top menu for each media or service.
②	▲/▼ and ENTER These buttons navigate through the menus. ◀/▶ This button cycles through pages. PLAYLIST ◀/▶ In Standard Mode (iPod/iPhone), this button selects playlists.
③	▶ This button starts playback.
④	⏮ This button selects the beginning of the current song. Pressing this button twice selects the previous song.
⑤	⏪ This button fast-reverses the current song.
⑥	⏸ This button pauses playback.
⑦	SEARCH You can toggle between the playback screen and the list screen during playback.
⑧	DISPLAY This button switches between song informations.
⑨	ALBUM +/- In Standard Mode (iPod/iPhone), this button selects albums.











⑩	MENU This button returns to top menu of the Internet Radio Services.
⑪	RETURN This button returns to the previous menu.
⑫	▶▶ This button fast-forwards the current song.
⑬	▶▶▶ This button selects the next song.
⑭	■ This button stops playback.
⑮	MODE You can switch between Standard Mode and Extended Mode during iPod/iPhone playback.
⑯	RANDOM This button performs random playback. All of the songs in the current folder will be played in random order. When all of the songs in the folder have been played once, they'll all be played again in a different random order. To cancel random playback, press this button again.
⑰	REPEAT Press this button repeatedly to cycle through the repeat modes. To cancel repeat playback, press REPEAT repeatedly until you select Off.



Note

- The buttons you can use will differ depending on the devices and media used for playback.

Understanding Icons on the Display

This section describes icons that appear on the display during media playback.

Displayed Icons	
Icon	Description
	Folder
	Track
	Playback
	Pause
	Fast Forward
	Fast Reverse
	Artist
	Album
	Repeat One Track
	Repeat Folder (USB Device)
	Repeat

Displayed Icons	
Icon	Description
	Shuffle
	Shuffle Album (iPod/iPhone)

Playing an iPod/iPhone via USB

This section explains how to play music files on the iPod/iPhone.

Compatible iPod/iPhone models

Made for:

iPod touch (1st, 2nd, 3rd and 4th generation), iPod classic, iPod with video, iPod nano (1st, 2nd, 3rd, 4th, 5th and 6th generation), iPhone 4, iPhone 3GS, iPhone 3G, iPhone

- 1 Press **USB** to select the “USB” input.
- 2 Connect the USB cable that comes with the iPod/iPhone to the USB port on the front of the AV receiver.
While reading the contents of your iPod/iPhone, the message “Connecting...” appears on the display. The **USB** indicator lights (→ page 8). It will flash if the AV receiver cannot read the iPod/iPhone.
- 3 Press **MODE** to switch to Extended Mode.
A list of your iPod/iPhone model’s contents appears. Use ▲/▼ to open a folder.

Tip

- With the default settings, the iPod/iPhone is operated in Standard Mode.
- Pressing **MODE** again switches back to Standard Mode.
- When you disconnect the iPod/iPhone, the AV receiver stores the mode. This means that if you disconnect when in Extended Mode, the AV receiver will start in Extended Mode the next time you connect the iPod/iPhone.
- You can also use the ▲/▼, **ENTER** and **TUNING MODE** buttons on the front panel. **TUNING MODE** allows you to switch modes.
- When connecting your iPod/iPhone with a USB cable, we recommend you use an official USB cable from Apple Inc.

- 4 Use ▲/▼ to select a music file, and press **ENTER** or ▶ to start playback.

Note

- Do not disconnect the USB device or USB cable that comes with iPod/iPhone to the **USB** port at the front of the AV receiver, while the message “Connecting...” appears on the display.

Standard Mode control

The content information is not displayed on-screen, but can be operated using the iPod/iPhone or the remote controller (**USB**).

Note

- The following iPod models are not supported in Standard Mode. These iPod models can only be controlled in Extended Mode.
 - iPod with video
 - iPod nano (1st generation)

Extended Mode control

The content information is displayed (lists are displayed) on-screen, and you can control the content while looking at the screen.

Top screen list:

Playlists, Artists, Albums, Genres, Songs, Composers, Shuffle Songs, Now Playing

Playing a USB Device

This section explains how to play music files from a USB device (e.g., USB flash drives and MP3 players).

See also:

- “Network/USB Features” (→ **page 64**).

- 1 Press **USB** to select the “USB” input.**
- 2 Plug your USB device into the AV receiver’s USB port.**
The **USB** indicator lights (→ **page 8**). It will flash if the AV receiver cannot read the USB device.
- 3 Press **ENTER**.**
A list of the device’s contents appears. To open a folder, use **▲/▼** to select it, and then press **ENTER**.
- 4 Use **▲/▼** to select a music file, and press **ENTER** or **▶** to start playback.**

Note

- If the media you connect is not supported, the message “**No Storage**” will appear on the display.
- If you connect a USB hard disk drive to the AV receiver’s **USB** port, we recommend that you use its AC adapter to power it.
- The AV receiver supports USB MP3 players that support the USB Mass Storage Class standard, which allows USB devices to be connected to computers without the need for special drivers or software. Note that not all USB MP3 players support the USB Mass Storage Class standard. Refer to your USB MP3 player’s instruction manual for details.
- Protected WMA music files on an MP3 player cannot be played.
- Onkyo accepts no responsibility whatsoever for the loss or damage to data stored on a USB device when that device is used with the AV receiver. We recommend that you back up your important music files beforehand.
- MP3 players containing music files that are managed with special music software are not supported.
- Operation is not guaranteed for all USB devices, which includes the ability to power them.
- Do not connect your USB device via a USB hub. The USB device must be connected directly to the AV receiver’s **USB** port.
- If the USB device contains a lot of data, the AV receiver may take a while to read it.
- USB devices with security functions cannot be played.
- Do not disconnect the USB device or USB cable that comes with iPod/iPhone to the **USB** port at the front of the AV receiver, while the message “**Connecting...**” appears on the display.

Listening to Internet Radio

You need to connect the AV receiver to your home network (→ **page 64**).

You can select Internet radio stations by connecting to the AV receiver from your computer and selecting stations in your web browser.

Internet radio URLs in the following formats are supported: PLS, M3U, and podcast (RSS). However, depending on the type of data or audio format used by the Internet radio station, you may not be able to listen to some stations.

Note

- Services available may vary depending on the region. See the separate instructions for more information.

Listening to vTuner Internet Radio

This unit includes the full vTuner Internet Radio Service at no additional charge. Once you have connected your unit to the Internet you can select vTuner Internet Radio to search for and play Internet radio stations and podcasts at any time. To enhance your Internet radio experience, the <http://onkyo.vtuner.com/portal> is available to you as an easy way to browse to find stations, set up/organize your favorites, add your own stations, get help, etc. After the first time you try vTuner Internet Radio on your unit you can use the MAC Address of your unit to create a member login account (email address and password) on the <http://onkyo.vtuner.com/portal>. To verify your MAC Address, please see “Network Setup” (→ **page 49**).

- 1 Press **NET**.**
The “**NET**” screen appears, and the **NET** indicator lights (→ **page 8**). If it flashes, verify that the Ethernet cable is firmly connected to the AV receiver.
- 2 Use **▲/▼** to select “vTuner Internet Radio” and then press **ENTER**.**

3 Use ▲/▼ to select a program and then press ENTER.

Playback starts.

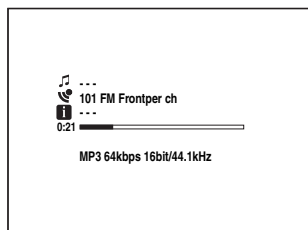

Press **MENU** to enable selection from the following menu items.

▶ Stations like this:

Stations like the one currently being played back are displayed.

▶ Add this station to My Favorites:

Adds a station to My Favorites list.

Press **TOP MENU** to go to the top menu of the Internet Radio services.

Tip

- By pressing **SEARCH**, you can toggle between the playback screen and the radio list screen.

Listening to Other Internet Radio

To listen to other internet radio stations, insert the following step after step 1 in the “Listening to vTuner Internet Radio”.

1 On your computer, start your web browser and enter the AV receiver’s IP address in the browser’s Internet address (URL) field.

The browser connects to the AV receiver (WEB Setup Menu).

Note

- The AV receiver’s IP address is shown on “**IP Address**” (→ page 49).
- If you’re using DHCP, your router may not always allocate the same IP address to the AV receiver, so if you find that you can’t connect to the AV receiver, recheck the AV receiver’s IP address on the “**Network Setup**” screen.

2 Click on the “My Favorites” tab.

3 Enter the preset name and Internet address (URL).

4 Click “Save” to save the Internet radio station.

5 The Internet radio station is then added to the “My Favorites”.

Registering Presets^{*1}

You can add the currently playing song or station to the “**My Favorites**”. You can preset up to 40 Internet radio stations.

Once you’ve added a station to the list, simply select it in the “**My Favorites**” menu, and then press **ENTER** to start playback.

^{*1} From the search results you can preset the stations and songs but cannot listen to them directly.

■ Top menu of Internet Radio

▶ Create new station:

Add a favorite station or Internet radio to the presets.

▶ Rename this station:

You can rename the preset.

▶ Delete from My Favorites:

This will delete the preset.

1 Press **MENU** with the station selected or while a song is playing.

2 Use ▲/▼ to select “Add this station to my favorites”, and press ENTER.

Playing Music Files on a Server

You need to connect the AV receiver to your home network (→ [page 64](#)).

This section explains how to play music files on a computer or media server through the AV receiver (Server Playback).

1 Start your computer or media server.

2 Press NET.

The “NET” screen appears. The NET indicator lights (→ [page 8](#)). If it flashes, confirm the network connection.

3 Use ▲/▼ to select “DLNA”, and press ENTER.

Tip

- To go back to the previous screen, press RETURN.

4 Use ▲/▼ to select a server, and then press ENTER.

The menu is displayed according to the server functions.

Note

- The search function does not work with media servers which do not support this function.
- Photos and movies stored on a media server cannot be accessed from the AV receiver.
- Depending on the sharing settings in the media server, the AV receiver may not be able to access the content. See the instruction manual of the media server.

5 Use ▲/▼ to select an item, and then press ENTER or ► to start playback.

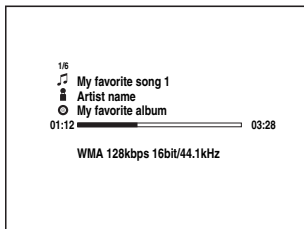

Note

- Depending on the media server, ◀◀/▶▶/|| may not work.
- If the message “No Item.” appears, this means that no information can be retrieved from the server. In this case, check your server, network, and AV receiver connections.

Windows Media Player 11 Setup

This section explains how to configure Windows Media Player 11 so that the AV receiver can play the music files stored on your computer.

1 Start Windows Media Player 11.

2 On the “Library” menu, select “Media Sharing”.

The “Media Sharing” dialog box appears.

3 Select the “Share my media” check box, and then click “OK”.

4 Select the AV receiver in the list, and then click “Allow”.

5 Click “OK” to close the dialog box.

This completes the Windows Media Player 11 configuration.

You can now play the music files in your Windows Media Player 11 library through the AV receiver (→ [page 24](#)).

Tip

- Windows Media Player 11 can be downloaded for free from the Microsoft web site.

Remote Playback

You need to connect the AV receiver to your home network (→ [page 64](#)).

Remote Playback means you can play the music files stored on a media server or personal computer with the AV receiver by operating the controller device in the home network.

Windows Media Player 12 Setup

This section explains how to configure Windows Media Player 12 so that the AV receiver can play the music files stored on your personal computer.

1 Start Windows Media Player 12.

2 On the “Stream” menu, select “Turn on media streaming”.

A dialog box appears.

3 Move your cursor and click on “Turn on media streaming”.

A list of media server appears. Wording may vary slightly depending on the network location.

4 Select the product in the list, and then click “Allowed”.

5 Click “OK” to close the dialog box.

This completes the Windows Media Player 12 configuration.

You can now play the music files in your Windows Media Player 12 library.

Using Remote Playback

1 Start Windows Media Player 12.

To enable remote playback, you must first configure Windows Media Player 12.

2 Press NET.

The “NET” screen appears. The NET indicator lights (→ [page 8](#)). If it flashes, verify the network connection.

- Use **▲/▼** to select “DLNA”, and press **ENTER**.
A list of media server appears.

Note

- Remote playback cannot be used while the music files of another media server are being played. You must stop their playback first.

- On **Windows Media Player 12**, right-click on music file.

Right-click menu appears. For selecting another media server, select media server from “Other Libraries” menu on Windows Media Player 12.

- Select the **AV receiver from right-click menu**.

“Play to” window appears and playback on the product starts. Operations during remote playback can be made from “Play to” window of Windows 7 on your personal computer. During remote playback, operations (such as Playback, Pause, Fast Forward, Fast Rewind, Previous, Next, Repeat, Random) cannot be made.

- Adjusting the Volume**

You can adjust the volume by adjusting the volume bar in the “Remote playback” window. The default maximum volume level is 82 (0dB). If you wish to change this, enter the value from the Web Setup in your browser.

The volume value of the remote window and the volume value of the AV receiver may not always match.

Adjustments you make to the volume in the AV receiver will not be reflected in the “Remote playback” window.

Listening to AM/FM Radio

This section describes the procedure of using the buttons on the front panel, unless otherwise specified.

Using the Tuner

With the built-in tuner you can enjoy AM and FM radio stations. You can store your favorite stations as presets for quick selection.

You can also change the frequency steps (→ **page 47**).

- Press **TUNER** to select either “AM” or “FM”.

In this example, FM has been selected.

Each time you press **TUNER**, the radio band changes between AM and FM.

Band	Frequency
FM	87.5 MHz

(Actual display depends on the country.)

Tuning into Radio Stations

Auto tuning mode

- Press **TUNING MODE** so that the **AUTO** indicator lights on the display.

- Press **TUNING ▲/▼**.

Searching stops when a station is found.

When tuned into a station, the **TUNED** indicator lights. When tuned into a stereo FM station, the **FM STEREO** indicator lights on the display, as shown.

The diagram shows a digital display with the text "FM 87.5 MHz" on the left. Above the display, there are two indicators: "▶ TUNED ◀" and "AUTO". Below the display, there are two indicators: "FM STEREO" and "FM STEREO".

Tip

- Tuning into weak FM stereo stations**

If the signal from a stereo FM station is weak, it may be impossible to get good reception. In this case, switch to manual tuning mode and listen to the station in mono.

■ Manual tuning mode

In manual tuning mode, FM stations will be in mono.

- 1 Press TUNING MODE so that the AUTO indicator goes off on the display.**
- 2 Press and hold TUNING ▲/▼.**
The frequency stops changing when you release the button.
Press the buttons repeatedly to change the frequency one step at a time.

■ Tuning into stations by frequency

You can tune into AM and FM stations directly by entering the appropriate frequency.

- 1 On the remote controller, press TUNER repeatedly to select “AM” or “FM”, followed by D.TUN.**

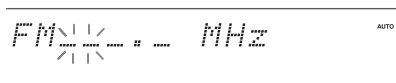

(Actual display depends on the country.)

- 2 Within 8 seconds, use the number buttons to enter the frequency of the radio station.**

For example, to tune to 87.5 (FM), press **8, 7, 5**.

If you have entered the wrong number, you can retry after 8 seconds.

Presetting AM/FM Stations

You can store a combination of up to 40 of your favorite AM/FM radio stations as presets.

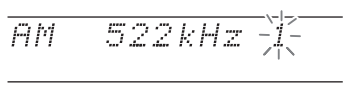
- 1 Tune into the AM/FM station that you want to store as a preset.**
See the previous section.
 - 2 Press MEMORY.**
The preset number flashes.
- 
- (Actual display depends on the country.)
- 3 While the preset number is flashing (about 8 seconds), use PRESET ◀/▶ to select a preset from 1 through 40.**
 - 4 Press MEMORY again to store the station or channel.**
The station or channel is stored and the preset number stops flashing.
Repeat this procedure for all of your favorite AM/FM radio stations.

■ Selecting Presets

- 1 To select a preset, use PRESET ◀/▶ on the AV receiver, or the remote controller’s CH +/-.**

Tip

- You can also use the remote controller’s number buttons to select a preset directly.

■ Deleting Presets

- 1 Select the preset that you want to delete.**
See the previous section.
- 2 While holding down MEMORY, press TUNING MODE.**
The preset is deleted and its number disappears from the display.

Using RDS (excluding North American and Taiwan models)

RDS works only in areas where RDS broadcasts are available.

When tuned into an RDS station, the **RDS** indicator lights. When the station is broadcasting text information, the text can be displayed.

■ What is RDS?

RDS stands for Radio Data System and is a method of transmitting data in FM radio signals. It was developed by the European Broadcasting Union (EBU) and is available in most European countries. Many FM stations use it these days. In addition to displaying text information, RDS can also help you find radio stations by type (e.g., news, sport, rock, etc.).

The AV receiver supports four types of RDS information:

PS (Program Service)

When tuned to an RDS station that’s broadcasting PS information, the station’s name will be displayed. Pressing **DISPLAY** will display the frequency for 3 seconds.

RT (Radio Text)

When tuned to an RDS station that’s broadcasting text information, the text will be shown on the display as described in the next section.

PTY (Program Type)

This allows you to search for RDS radio stations by type (→ **page 27**).

TP (Traffic Program)

This allows you to search for RDS radio stations that broadcast traffic information (→ **page 27**).

Note

- In some cases, the text characters displayed on the AV receiver may not be identical to those broadcast by the radio station. Also, unexpected characters may be displayed when unsupported characters are received. This is not a malfunction.
- If the signal from an RDS station is weak, RDS data may be displayed intermittently or not at all.

■ Displaying Radio Text (RT)

1 Press RT/PTY/TP once.

The RT information scrolls across the display.

Note

- The message “**Waiting**” may appear while the AV receiver waits for the RT information.
- If the message “**No Text Data**” appears on the display, no RT information is available.

■ Finding Stations by Type (PTY)

You can search for radio stations by type.

1 Press RT/PTY/TP twice.

The current program type appears on the display.

2 Use PRESET ◀/▶ to select the type of program you want.

See the table shown later in this chapter.

3 To start the search, press ENTER.

The AV receiver searches until it finds a station of the type you specified, at which point it stops briefly before continuing with the search.

4 When a station you want to listen to is found, press ENTER.

If no stations are found, the message “**Not Found**” appears.

■ Listening to Traffic News (TP)

You can search for stations that broadcast traffic news.

1 Press RT/PTY/TP three times.

If the current radio station is broadcasting TP (Traffic Program), “[TP]” will appear on the display, and traffic news will be heard as and when it’s broadcast. If “TP” without square brackets appears, this means that the station is not broadcasting TP.

2 To locate a station that is broadcasting TP, press ENTER.

The AV receiver searches until it finds a station that’s broadcasting TP.

If no stations are found, the message “**Not Found**” appears.

RDS program types (PTY)

Type	Display
None	None
News reports	News
Current affairs	Affairs
Information	Info
Sport	Sport
Education	Educate
Drama	Drama
Culture	Culture
Science and technology	Science
Varied	Varied
Pop music	Pop M
Rock music	Rock M
Middle of the road music	Easy M
Light classics	Light M
Serious classics	Classics
Other music	Other M
Weather	Weather
Finance	Finance
Children’s programmes	Children
Social affairs	Social
Religion	Religion
Phone in	Phone In
Travel	Travel
Leisure	Leisure
Jazz music	Jazz
Country music	Country
National music	Nation M
Oldies music	Oldies
Folk music	Folk M
Documentary	Document
Alarm test	TEST
Alarm	Alarm!

Using Basic Functions

Using the Automatic Speaker Setup

With the supplied calibrated microphone, Audyssey 2EQ® automatically determines the number of speakers connected, their size for purposes of bass management, optimum crossover frequencies to the subwoofer (if present), and distances from the primary listening position.

Audyssey 2EQ then removes the distortion caused by room acoustics by capturing room acoustical problems over the listening area in both the frequency and time domain. The result is clear, well-balanced sound for everyone. Audyssey 2EQ can be used with

Audyssey Dynamic EQ® and Audyssey Dynamic Volume® (→ page 44, 45).

Before using this function, connect and position all of your speakers.

Audyssey 2EQ offers two ways of measuring: the “Audyssey Quick Start” and “Audyssey 2EQ Full Calibration”.

- “Audyssey Quick Start” uses the measurement from one position to perform the speaker setting only.
- “Audyssey 2EQ Full Calibration” uses the measurement from three positions to correct room response in addition to the speaker setting.

Each way of measurement take 2 and 10 minutes, respectively.

Total measurement time varies depending on the number of speakers.

Measurement procedure

To create a listening environment in your home theater that all listeners will enjoy, Audyssey 2EQ takes measurements at up to 3 positions within the listening area. Position the microphone at ear height of a seated listener with the microphone tip pointed directly at the ceiling using a tripod. Do not hold the microphone in your hand during measurements as this will produce inaccurate results.

① First measurement position

Also referred to as the Main Listening Position, this refers to the most central position where one would normally sit within the listening environment.

Audyssey 2EQ uses the measurements from this position to calculate speaker distance, level, polarity, and the optimum crossover value for the subwoofer.

② Second measurement position

The right side of the listening area.

③ Third measurement position

The left side of the listening area.

The distances from position ① to ② and ① to ③ must be at least 1 meter (3.3 ft.).

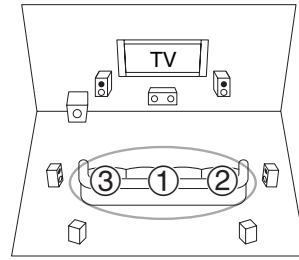

○ : Listening area ① to ③ : Listening position

Note

- Make the room as quiet as possible. Background noise and Radio Frequency Interference (RFI) can disrupt the room measurements. Close windows, televisions, radios, air conditioners, fluorescent lights, home appliances, light dimmers, or other devices. Silence the cell phone (even if it is not in use) or place it away from all audio electronics.
- The microphone picks up test tones played through each speaker as Audyssey 2EQ Room Correction and Speaker Setup runs.
- Audyssey 2EQ Room Correction and Speaker Setup cannot be performed while a pair of headphones is connected.

- 1 Turn on the AV receiver and the connected TV.**
On the TV, select the input to which the AV receiver is connected.
- 2 Set the speaker setup microphone at the Main Listening Position ①, and connect it to the SETUP MIC jack.**

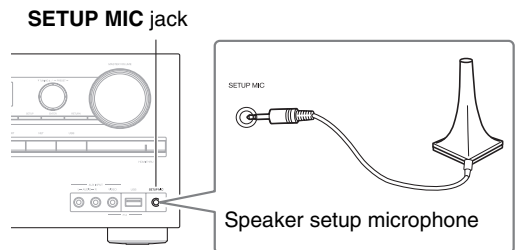

When an optional unit is connected to the **UNIVERSAL PORT** jack on the AV receiver, the speaker setting menu may appear on screen.

Note

- The on-screen setup menus appear only on a TV that is connected to the **HDMI OUT**. If your TV is connected to the **MONITOR OUT V** or the **COMPONENT VIDEO OUT**, use the AV receiver's display when changing settings.

- 3 Use ▲/▼ to select “Audyssey Quick Start” or “Audyssey 2EQ Full Calibration”.**

4 Press ENTER.

Audyssey 2EQ® Room Correction and Speaker Setup starts.

Test tones are played through each speaker as Audyssey 2EQ Room Correction and Speaker Setup runs. This process takes a few minutes. Please **refrain from talking** during measurements and **do not stand** between speakers and the microphone.

Do not disconnect the speaker setup microphone during Audyssey 2EQ Room Correction and Speaker Setup, unless you want to cancel the setup.

If you select “**Audyssey Quick Start**”, you will go to step 7.

5 Place the setup microphone at the next position, and then press ENTER.

Audyssey 2EQ performs more measurements. This takes a few minutes.

6 When prompted, place the setup microphone at the next position, and repeat step 5.

7 Use ▲/▼ to select an option, and then press ENTER.

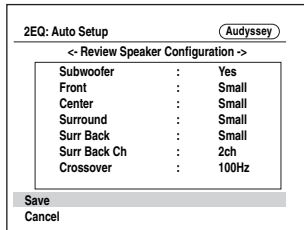

The options are:

► Save:

Save the calculated settings and exit Audyssey 2EQ Room Correction and Speaker Setup.

► Cancel:

Cancel Audyssey 2EQ Room Correction and Speaker Setup.

Note

- You can view the calculated settings for the speaker configuration, speaker distances, and speaker levels by using ◀/▶.

8 Use ▲/▼ to select a target, and use ◀/▶ to change the setting.

After the results of Audyssey 2EQ have been saved, the menu will display the “Audyssey” (→ **page 44**), “Dynamic EQ” (→ **page 44**), “Dynamic Volume” (→ **page 45**) settings.

Note

- When “**Audyssey Quick Start**” has been used for measurement, “**Audyssey**” cannot be selected.
- These settings are applied to all input selectors.

9 Press ENTER.

10 Disconnect the speaker setup microphone.

Note

- You can cancel Audyssey 2EQ Room Correction and Speaker Setup at any point in this procedure simply by disconnecting the setup microphone.
- Do not connect or disconnect any speakers during Audyssey 2EQ Room Correction and Speaker Setup.
- If the AV receiver is muted, it will be unmuted automatically when Audyssey 2EQ Room Correction and Speaker Setup starts.
- Changes to the room after Audyssey 2EQ Room Correction and Speaker Setup require you run Audyssey 2EQ Room Correction and Speaker Setup again, as room EQ characteristics may have changed.

Error Messages

While Audyssey 2EQ® Room Correction and Speaker Setup is in progress, one of the error messages below may appear.

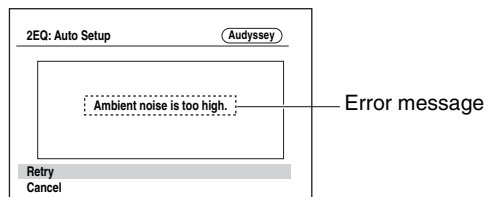

The options are:

► Retry:

Try again.

► Cancel:

Cancel Audyssey 2EQ Room Correction and Speaker Setup.

• Ambient noise is too high.

The background noise is too loud. Remove the source of the noise and try again.

• Speaker matching error!

The number of speakers detected was different from that of the first measurement. Check the speaker connection.

• Writing Error!

This message appears if saving fails. Try saving again. If this message appears after 2 or 3 attempts, contact your Onkyo dealer.

• Speaker Detect Error

This message appears if a speaker is not detected. “No” means that no speaker was detected.

Tip

- See “Speaker Configuration” for appropriate settings (→ **page 12**).

Changing the Speaker Setup Manually

You can manually make changes to the settings found during Audyssey 2EQ Room Correction and Speaker Setup.

See also:

- “Sp Config (Speaker Configuration)” (→ **page 41**)
- “Sp Distance (Speaker Distance)” (→ **page 42**)
- “Level Cal (Level Calibration)” (→ **page 42**)

Using a Powered Subwoofer

If you're using a powered subwoofer and it outputs very low-frequency sound at a low volume level, it may not be detected by Audyssey 2EQ® Room Correction and Speaker Setup.

If the “**Subwoofer**” appears on the “**Review Speaker Configuration**” screen as “**No**”, increase the subwoofer's volume to the half-way point, set it to its highest crossover frequency, and then try running Audyssey 2EQ Room Correction and Speaker Setup again. Note that if the volume is set too high and the sound distorts, detection issues may occur, so use an appropriate volume level. If the subwoofer has a low-pass filter switch, set it to Off or Direct. Refer to your subwoofer's instruction manual for details.

Selecting Listening Modes

See “About Listening Modes” for detailed information about the listening modes (→ page 32).

■ Listening Mode Buttons

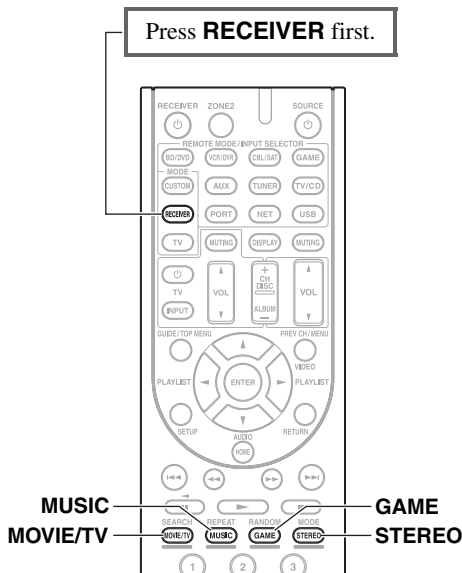

MOVIE/TV button

This button selects the listening modes intended for use with movies and TV.

MUSIC button

This button selects the listening modes intended for use with music.

GAME button

This button selects the listening modes intended for use with video games.

STEREO button

This button selects the Stereo listening mode and All Channel Stereo listening mode.

(North American and Taiwan models)

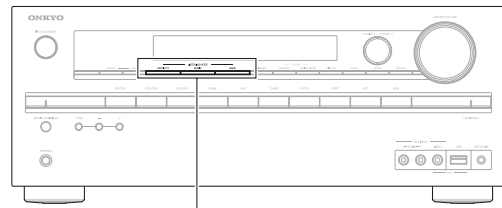

MOVIE/TV, MUSIC, GAME

(European, Australian and Asian models)

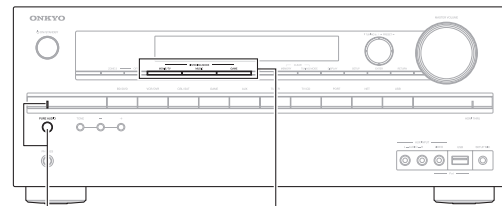

PURE AUDIO MOVIE/TV, MUSIC, GAME

PURE AUDIO button and indicator

(European, Australian and Asian models)

This button selects the Pure Audio listening mode.

When this mode is selected, the AV receiver’s display and video circuitry are turned off. The indicator lights when this mode is selected. Pressing this button again will select the previous listening mode.

- The Dolby Digital and DTS listening modes can only be selected if your Blu-ray Disc/DVD player is connected to the AV receiver with a digital audio connection (coaxial, optical, or HDMI).
- The listening modes you can select depends on the format of the input signal. To check the format, see “Displaying Source Information” (→ page 36).
- While a pair of headphones is connected, you can select the following listening modes: Pure Audio (European, Australian and Asian models), Mono, Direct, and Stereo.

About Listening Modes

The AV receiver's listening modes can transform your listening room into a movie theater or concert hall, with high fidelity and stunning surround sound.

■ Explanatory Notes

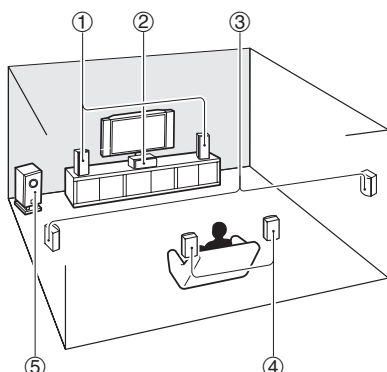

- ① Front speakers
- ② Center speaker
- ③ Surround speakers
- ④ Surround back speakers
- ⑤ Subwoofer

Input Source

The following audio formats are supported by the listening modes.

MONO	This is mono (monophonic) sound.
STEREO	This is stereo (stereophonic) sound. Two independent audio signal channels are reproduced through two speakers.
5.1ch	This is 5.1-channel surround sound. This surround system has five main channels of sound and a sixth subwoofer channel (called the point-one channel).
7.1ch	This is 7.1-channel surround sound. This is a further sound enhancement to 5.1 channel sound with two additional speakers that provide greater sound envelopment and more accurate positioning of sounds.
DTS-ES	This is DTS-ES surround sound. This surround system can produce a discrete or a matrix-encoded sixth channel from existing DTS 5.1 encoded material.
Dolby Digital EX	This is Dolby Digital EX surround sound. This provides a center back surround channel from 5.1-channel sources.

Speaker Layout

The illustration shows which speakers are activated in each channel. See "Sp Config (Speaker Configuration)" for the speaker setup (→ [page 41](#)).

2.1	3.1	5.1	7.1

■ Onkyo-Original DSP Listening Modes

Listening Mode	Description	Input Source	Speaker Layout	
Orchestra <i>Orchestra</i>	Suitable for classical or operatic music, this mode emphasizes the surround channels in order to widen the stereo image, and simulates the natural reverberation of a large hall.	MONO STEREO 5.1ch 7.1ch DTS-ES DDEX	5.1 7.1	
Unplugged <i>Unplugged</i>	Suitable for acoustic instruments, vocals and jazz, this mode emphasizes the front stereo image, giving the impression of being right in front of the stage.			
Studio-Mix <i>Studio-Mix</i>	Suitable for rock or pop music, listening to music in this mode creates a lively sound field with a powerful acoustic image, like being at a club or rock concert.			
TV Logic <i>TV Logic</i>	This mode adds realistic acoustics to TV shows produced in a TV studio, surround effects to the entire sound, and clarity to voices.			
Game-RPG <i>Game-RPG</i>	In this mode, the sound has a dramatic feel with a similar atmosphere to Orchestra mode.			
Game-Action <i>Game-Action</i>	In this mode, sound localization is distinct with emphasis on bass.			
Game-Rock <i>Game-Rock</i>	In this mode, sound pressure is emphasized to heighten live feel.			
Game-Sports <i>Game-Sports</i>	In this mode, reverberation is increased and sound localization decreased slightly.			
All Ch Stereo <i>All Ch Stereo</i>	Ideal for background music, this mode fills the entire listening area with stereo sound from the front, surround, and surround back speakers.			3.1 5.1 7.1
Full Mono <i>Full Mono</i>	In this mode, all speakers output the same sound in mono, so the sound you hear is the same regardless of where you are within the listening room.			
T-D (Theater-Dimensional) <i>T-D</i>	With this mode you can enjoy a virtual surround sound even with only two or three speakers. This works by controlling how sounds reach the listener's left and right ears. Good results may not be possible if there's too much reverb, so we recommend that you use this mode in an environment with little or no natural reverb.	2.1 3.1 5.1 7.1		

■ Listening Modes

Listening Mode	Description	Input Source	Speaker Layout		
Pure Audio *1*2 <i>Pure Audio</i>	In this mode, the display and video circuitry are turned off, minimizing possible noise sources for the ultimate in high-fidelity audio reproduction. A/V Sync does not have effect on the analog audio. (As the video circuitry is turned off, only video signals input through HDMI IN can be output from HDMI OUT.)	MONO STEREO 5.1ch 7.1ch DTS-ES DDEX	2.1 3.1 5.1 7.1		
Direct <i>Direct</i>	In this mode, audio from the input source is output without surround-sound processing. The speaker configuration (presence of speakers) and speaker distance settings are enabled, but much of the processing set via Home menu is disabled. A/V Sync does not have effect on the analog audio. See "Advanced Setup" for more details (→ page 39).				
Stereo <i>Stereo</i>	Sound is output from the front left and right speakers and subwoofer.				
Mono <i>Mono</i>	Use this mode when watching an old movie with a mono soundtrack, or use it with the foreign language soundtracks recorded in the left and right channels of some movies. It can also be used with DVDs or other sources containing multiplexed audio, such as karaoke DVDs.				
Multichannel <i>Multich</i>	This mode is for use with PCM multichannel sources.			5.1ch 7.1ch	3.1 5.1 7.1

Listening Mode	Description	Input Source	Speaker Layout
Dolby Pro Logic IIx Dolby Pro Logic II <i>PLII Movie</i> <i>PLII Music</i> <i>PLII Game</i> <i>PLIIx Movie</i> <i>PLIIx Music</i> <i>PLIIx Game</i>	<p>Dolby Pro Logic IIx expands any 2-channel source for 7.1-channel playback. It provides a very natural and seamless surround-sound experience that fully envelops the listener. As well as music and movies, video games can also benefit from the dramatic spatial effects and vivid imaging. If you're not using any surround back speakers, Dolby Pro Logic II will be used instead of Dolby Pro Logic Ix.</p> <ul style="list-style-type: none"> • Dolby PLIIx Movie Use this mode with any stereo or Dolby Surround (Pro Logic) movie (e.g., TV, DVD, VHS). • Dolby PLIIx Music Use this mode with any stereo or Dolby Surround (Pro Logic) music source (e.g., CD, radio, cassette, TV, VHS, DVD). • Dolby PLIIx Game Use this mode with video games, especially those that bear the Dolby Pro Logic II logo. 	STEREO	3.1 5.1 7.1
Dolby EX <i>Dolby EX</i> <i>Dolby D EX</i>	<p>These modes expand 5.1-channel sources for 6.1/7.1-channel playback. They're especially suited to Dolby EX soundtracks that include a matrix-encoded surround back channel. The additional channel adds an extra dimension and provides an enveloping surround sound experience, perfect for rotating and fly-by sound effects.</p>	5.1ch Dolby EX	7.1
Dolby Digital <i>Dolby D</i>	<p>In this mode, audio from the input source is output without surround-sound processing. The speaker configuration (presence of speakers), crossover frequency, speaker distance, A/V Sync and much of the processing set via Home menu are enabled. See "Advanced Setup" for more details (→ page 39).</p>	5.1ch	3.1 5.1 7.1
Dolby Digital Plus ³ <i>Dolby D +</i>		5.1ch 7.1ch	3.1 5.1 7.1
Dolby TrueHD <i>Dolby TrueHD</i>		5.1ch 7.1ch	3.1 5.1 7.1
DTS <i>DTS</i>		5.1ch	3.1 5.1 7.1
DTS-HD High Resolution Audio <i>DTS-HD HR</i>		5.1ch 7.1ch	3.1 5.1 7.1
DTS-HD Master Audio <i>DTS-HD MSTR</i>			
DTS Express <i>DTS Express</i>		5.1ch	3.1 5.1 7.1
DSD ⁴ <i>DSD</i>			
DTS 96/24 <i>DTS 96/24</i>	<p>This mode is for use with DTS 96/24 sources. This is high-resolution DTS with a 96 kHz sampling rate and 24-bit resolution, providing superior fidelity. Use it with DVDs that bear the DTS 96/24 logo.</p>	5.1ch	3.1 5.1 7.1
DTS-ES Discrete ⁵ <i>ES Discrete</i>	<p>This mode is for use with DTS-ES Discrete soundtracks, which use a discrete surround back channel for true 6.1/7.1-channel playback. The seven totally separate audio channels provide better spatial imaging and 360-degree sound localization, perfect for sounds that pan across the surround channels. Use it with DVDs that bear the DTS-ES logo, especially those with a DTS-ES Discrete soundtrack.</p>	DTS-ES	7.1
DTS-ES Matrix ⁵ <i>ES Matrix</i>	<p>This mode is for use with DTS-ES Matrix soundtracks, which use a matrix-encoded back-channel for 6.1/7.1-channel playback. Use it with DVDs that bear the DTS-ES logo, especially those with a DTS-ES Matrix soundtrack.</p>		

Listening Mode	Description	Input Source	Speaker Layout
Neo:6 <i>Neo:6</i> <i>Neo:6 Cinema</i> <i>Neo:6 Music</i>	This mode expands any 2-channel source for up to 7.1-channel playback. It uses seven full-bandwidth channels of matrix decoding for matrix-encoded material, providing a very natural and seamless surround sound experience that fully envelops the listener. <ul style="list-style-type: none"> • Neo:6 Cinema Use this mode with any stereo movie (e.g., TV, DVD, VHS). • Neo:6 Music Use this mode with any stereo music source (e.g., CD, radio, cassette, TV, VHS, DVD). 	STEREO	3.1 5.1 7.1
	This mode uses Neo:6 to expand 5.1-channel sources for 6.1/7.1-channel playback.	5.1ch	7.1

Note

- *1 **(North American and Taiwan models)** This listening mode is not available.
- *2 Pure Audio cannot be selected when Zone 2 is active.
Besides, if you activate Zone 2 while Pure Audio is selected, the listening mode will automatically switch to Direct.
- *3 For the Blu-ray Discs, Dolby Digital is used in a 3.1/5.1-channel speaker system.
- *4 AV receiver can input the DSD signal from HDMI IN. Depending on the player, setting the output on the player side to PCM might bring better sound.
- *5 DTS is used if there are no surround back speakers.
- The listening modes cannot be selected with some source formats.

Using the Home Menu

The Home menu provides you quick access to frequently used menus without having to go through the long standard menu. This menu enables you to change settings and view the current information.

The Home menus appear only on a TV that is connected to the HDMI OUT. If your TV is connected to the MONITOR OUT V or the COMPONENT VIDEO OUT, use the AV receiver's display when changing settings.

1 Press RECEIVER followed by HOME.

The Home menu will be superimposed on the TV screen.

2 Use ▲/▼ and ENTER to make the desired selection.

■ Input*1

▶ You can select the input source while viewing the following information: the name of input selectors and input assignments.

Press **ENTER** to display the current input source, followed by **▲/▼** to select the desired input source. Pressing **ENTER** again switches to the selected input source.

■ Audio

▶ You can change the following settings: “Bass”, “Treble”, “Subwoofer Level”, “Center Level”, “Audyssey”, “Dynamic EQ”, “Dynamic Volume”, “Late Night”, “Music Optimizer”, and “Cinema Filter”.

See also:

- “Audyssey” (→ page 44)
- “Using the Audio Settings” (→ page 50)

■ Info*2

▶ You can view the information of the following items: “Input” and “Output”.

■ Listening Mode

▶ You can select the listening modes that are grouped in the following categories: “MOVIE/TV”, “MUSIC”, “GAME”.

Use **▲/▼** to select the category and **◀/▶** to select the listening mode. Press **ENTER** to switch to the selected listening mode.

Note

*1 For the **PORT** input selector, the name of Universal Port Option Dock will be displayed.

*2 Depending on the input source and listening mode, not all channels shown here output the sound.

Using the Sleep Timer

With the sleep timer, you can set the AV receiver to turn off automatically after a specified period.

1 Press RECEIVER followed by SLEEP repeatedly to select the required sleep time.

The sleep time can be set from 90 to 10 minutes in 10 minute steps.

The **SLEEP** indicator lights on the display when the sleep timer has been set. The specified sleep time appears on the display for about 5 seconds, then the previous display reappears.

Tip

- If you need to cancel the sleep timer, press **SLEEP** repeatedly until the **SLEEP** indicator goes off.
- To check the time remaining until the AV receiver sleeps, press **SLEEP**. Note that if you press again on **SLEEP** as the time being displayed is equal or inferior to 10 minutes, the sleep timer will go off.

Setting the Display Brightness

You can adjust the brightness of the AV receiver's display.

1 Press RECEIVER followed by DIMMER repeatedly to select: dim, dimmer, or normal brightness.

Tip

- (North American and Taiwan models) Alternatively, you can use the AV receiver's **DIMMER**.

Displaying Source Information

You can display various information about the current input source as follows (Components connected to the **UNIVERSAL PORT** jack are excluded).

1 Press RECEIVER followed by DISPLAY repeatedly to cycle through the available information.

The following information can be typically displayed.

Input source	—	Blu-ray
Listening mode	—	Stereo
		↓ ↑
Signal format*1	—	DTS-HDMSTR 5.1
Sampling frequency	—	fs: 96 kHz

Tip

- Alternatively, you can use the AV receiver's **DISPLAY**.

*1 If the input signal is analog, “Analog” is displayed. If the input signal is PCM, the sampling frequency is displayed. If the input signal is digital but not PCM, the signal format is displayed. Information is displayed for about three seconds, then the previously displayed information reappears.

Changing the Input Display

When you connect an **RI**-capable Onkyo component, you must configure the input display so that **RI** can work properly.

This setting can be done only from the front panel.

1 Press **TV/CD**, **GAME** or **VCR/DVR**.

“**TV/CD**”, “**GAME**” or “**VCR/DVR**” appears on the display.

2 Press and hold down the same button (about 3 seconds) to change the input display.

Repeat this step to select the desired input display.

■ **TV/CD:**

TV/CD → DOCK
↑ TAPE ←

■ **GAME:**

GAME ↔ DOCK

■ **VCR/DVR:**

VCR/DVR ↔ DOCK

Note

- **DOCK** cannot be selected for multiple input selectors at the same time.
- Enter the appropriate remote control code before using the remote controller for the first time (→ [page 56](#)).

Using the Music Optimizer

The Music Optimizer function enhances the sound quality of compressed music files.

1 (North American and Taiwan models) Press **MUSIC OPTIMIZER** on the front panel.

The **M.Opt** indicator lights on the display.

The **MUSIC OPTIMIZER** indicator lights on the front panel.

Tip

- Alternatively, you can use the remote controller’s **HOME** and arrow buttons.
- See “Music Optimizer” for more details (→ [page 51](#)).

Muting the AV Receiver

You can temporarily mute the output of the AV receiver.

1 Press **RECEIVER** followed by **MUTING**.

The output is muted and the **MUTING** indicator flashes on the display.

Tip

- To unmute, press **MUTING** again or adjust the volume.
- Muting is automatically cancelled when the AV receiver is set to Standby.

Using Headphones

1 Connect a pair of stereo headphones with a standard plug (1/4 inch or 6.3 mm) to the **PHONES** jack.

Note

- Always turn down the volume before connecting your headphones.
- While the headphones plug is inserted in the **PHONES** jack, the speakers are turned off.
- When you connect a pair of headphones, the listening mode is set to Stereo, unless it’s already set to Stereo, Mono, Direct, or Pure Audio (**European, Australian and Asian models**).

Recording

This section explains how to record the selected input source to a component with recording capability, and how to record audio and video from different sources.

AV Recording

Audio sources can be recorded to a recorder (e.g., cassette tape deck, CDR, MD recorder). Video sources can be recorded to a video recorder (e.g., VCR, DVD recorder).

1 Use the input selector buttons to select the source that you want to record.

You can watch the source while recording. The AV receiver’s **MASTER VOLUME** control has no effect on recording.

2 On your recorder, start recording.

3 On the source component, start playback.

If you select another input source during recording, that input source will be recorded.

Recording Separate AV Sources

Here you can record audio and video from completely separate sources, allowing you to overdub audio onto your video recordings. This function takes advantage of the fact that when an audio-only input source (TV/CD) is selected, the video input source remains unchanged.

In the following example, audio from the CD player connected to the **TV/CD IN** and video from the camcorder connected to the **AUX INPUT VIDEO** jack are recorded by the VCR connected to the **VCR/DVR OUT** jacks.

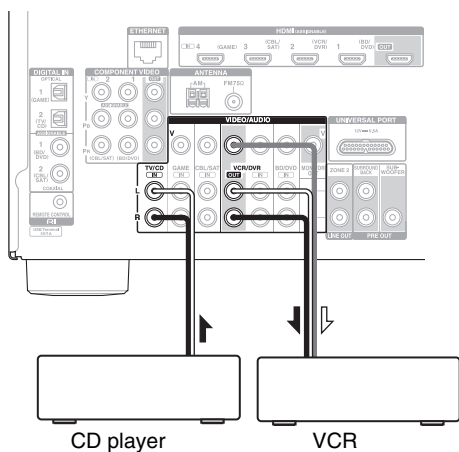
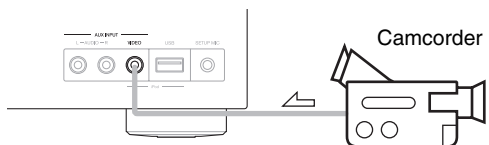

↘ : Video signal
↙ : Audio signal

- 1 Prepare the camcorder and CD player for playback.**
- 2 Prepare the VCR for recording.**
- 3 Press AUX input selector.**
- 4 Press TV/CD input selector.**
This selects the CD player as the audio source, but leaves the camcorder as the video source.
- 5 Start recording on the VCR and start playback on the camcorder and CD player.**
The video from the camcorder and the audio from the CD player are recorded by the VCR.

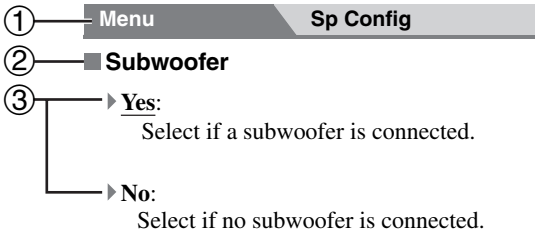

- ① Menu selection
- ② Setting target
- ③ Setting options (default setting underlined)

HDMI Input

Menu HDMI Input

If you connect a video component to an HDMI input, you must assign that input to an input selector. For example, if you connect your Blu-ray Disc/DVD player to **HDMI IN 2**, you must assign “**HDMI2**” to the “**BD/DVD**” input selector.

Here are the default assignments.

Input selector	Default assignment
BD/DVD	HDMI1
VCR/DVR	HDMI2
CBL/SAT	HDMI3
GAME	HDMI4
AUX	-----
TV/CD	-----
PORT	-----

■ BD/DVD, VCR/DVR, CBL/SAT, GAME, AUX, TV/CD, PORT

▶ HDMI1, HDMI2, HDMI3, HDMI4:

Select the corresponding HDMI input, to which the component has been connected.

▶ -----:

Select if you're not using the **HDMI OUT**.

Each HDMI input cannot be assigned to two input selectors or more. When **HDMI1 - HDMI4** have already been assigned, you must set first any unused input selectors to “-----”, or you will be unable to assign **HDMI1 - HDMI4** to other input selectors.

Note

- When an **HDMI IN** is assigned to an input selector as explained here, the digital audio input for that input selector is automatically set to the same **HDMI IN**.
- Do not assign the component connected with the HDMI input to **TV/CD** selector when you set the “**HDMI Ctrl (RIHD)**” setting to “**On**” (→ **page 48**). Otherwise, appropriate CEC (Consumer Electronics Control) operation will not be guaranteed.
- If you connect a component (such as UP-A1 Dock that seated iPod) to **UNIVERSAL PORT** jack, you cannot assign any input to **PORT** selector.

Component (Component Video Input)

Menu Component

If you connect a video component to a component video input, you must assign that input to an input selector. For example, if you connect your Blu-ray Disc/DVD player to **COMPONENT VIDEO IN 2**, you must assign “**IN2**” to the “**BD/DVD**” input selector.

Here are the default assignments.

Input selector	Default assignment
BD/DVD	IN1
VCR/DVR	-----
CBL/SAT	IN2
GAME	-----
AUX	-----
TV/CD	-----
PORT	-----

■ BD/DVD, VCR/DVR, CBL/SAT, GAME, AUX, TV/CD, PORT

▶ IN1, IN2:

Select the corresponding video input, to which the video component has been connected.

▶ -----:

Select if you're not using the **COMPONENT VIDEO OUT**.

Note

- If you connect a component (such as UP-A1 Dock that seated iPod) to the **UNIVERSAL PORT** jack, you cannot assign any input to **PORT** selector.

Digital Audio (Digital Audio Input)

Menu Digital Audio

If you connect a component to a digital audio input, you must assign that input to an input selector. For example, if you connect your CD player to the **OPTICAL IN 1**, you must assign “**OPTICAL1**” to the “**TV/CD**” input selector.

Here are the default assignments.

Input selector	Default assignment
BD/DVD	COAXIAL1
VCR/DVR	-----
CBL/SAT	COAXIAL2
GAME	OPTICAL1
AUX	-----
TV/CD	OPTICAL2
PORT	-----

■ BD/DVD, VCR/DVR, CBL/SAT, GAME, AUX, TV/CD, PORT

▶ COAXIAL1, COAXIAL2, OPTICAL1, OPTICAL2:

Select the corresponding digital audio input, to which the component has been connected.

▶-----:

Select if the component is connected to an analog audio input.

Note

- When an **HDMI IN** is assigned to an input selector in “HDMI Input” (→ **page 40**), this input assignment is automatically set to the same **HDMI IN**. And in addition to the usual inputs (e.g., **COAXIAL1**, **COAXIAL2**, etc.), you can also select HDMI inputs.
- Available sampling rate for PCM signals from a digital input (optical and coaxial) is 32/44.1/48/88.2/96 kHz/16, 20, 24 bit.
- If you connect a component (such as UP-A1 Dock that seated iPod) to the **UNIVERSAL PORT** jack, you cannot assign any input to **PORT** selector.

Sp Config (Speaker Configuration)

Menu

Sp Config

Some of the settings in this section are set automatically by Audyssey 2EQ® Room Correction and Speaker Setup (→ **page 28**).

Here you can check the settings made by Audyssey 2EQ Room Correction and Speaker Setup, or set them manually, which is useful if you change one of the connected speakers after using Audyssey 2EQ Room Correction and Speaker Setup.

This section explains how to specify which speakers are connected and their sizes.

For speakers with a cone diameter larger than 6-1/2 inches (16 cm), specify **Large** (full band). For those with a smaller diameter, specify **Small** (default crossover 100Hz).

The crossover frequency can be changed in “Crossover (Crossover Frequency)” (→ **page 41**).

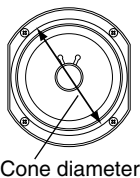

Note

- These settings are not available in either of the following cases:
 - a pair of headphones is connected.
 - the “**Audio TV Out**” setting is set to “**On**” (→ **page 48**).
 - “**HDMI Ctrl (RIHD)**” is set to “**On**” (→ **page 48**) and you’re listening through your TV speakers.

■ Subwoofer

▶ **Yes:**

Select if a subwoofer is connected.

▶ **No:**

Select if no subwoofer is connected.

■ Front

▶ **Small:**

Select based on the cone diameter.

▶ **Large:**

Note

- If the “**Subwoofer**” setting is set to “**No**”, this setting is fixed at “**Large**” and does not appear.

■ Center*1, Surround*1, Surround Back*1*2*3*4

▶ **Small:**

Select based on the cone diameter.

▶ **Large:**

Select if no speaker is connected.

▶ **None:**

Select if no speaker is connected.

Note

- *1 If the “**Front**” setting is set to “**Small**”, the “**Large**” option cannot be selected.
- *2 If the “**Surround**” setting is set to “**None**”, this setting cannot be selected.
- *3 If the “**Surround**” setting is set to “**Small**”, the “**Large**” option cannot be selected.
- *4 For “**Surround Back**”, the default is “**None**”.

■ Surround Back Ch

▶ **1ch:**

Select if only one surround back speaker is connected.

▶ **2ch:**

Select if two (left and right) surround back speakers are connected.

Note

- If the “**Surround Back**” setting is set to “**None**”, this setting cannot be selected.

■ Crossover (Crossover Frequency)

This setting is advantageous for the speakers that you specified as “**Small**” in “Sp Config (Speaker Configuration)” (→ **page 41**). To get the best bass performance from your speaker system, you need to set the crossover frequency according to the size and frequency response of your speakers.

▶ **40Hz, 50Hz, 60Hz, 70Hz, 80Hz, 90Hz, 100Hz, 120Hz, 150Hz, 200Hz**

Use the diameter of the smallest speaker in your system when choosing the crossover frequency.

Speaker cone diameter	Crossover frequency
Over 8 in. (20 cm)	40/50/60 Hz*
6-1/2 to 8 in. (16 to 20 cm)	70/80/90 Hz*
5-1/4 to 6-1/2 in. (13 to 16 cm)	100 Hz
3-1/2 to 5-1/4 in. (9 to 13 cm)	120 Hz
Under 3-1/2 in. (9 cm)	150/200 Hz*

* Choose the setting matching your speaker.

Note

- For a more accurate setting, look up the frequency response in the manuals supplied with your speakers and set accordingly.
- Choose a higher crossover frequency if you want more sound from your subwoofer.

■ Double Bass

This setting is **not** set automatically by Audyssey 2EQ Room Correction and Speaker Setup (→ **page 28**).

▶ **On**

▶ **Off**

Turn this setting on to boost bass output by feeding bass sounds from the front left, right, and center channels to the subwoofer.

Note

- This function can be set only if the “**Subwoofer**” setting is set to “**Yes**”, and the “**Front**” setting is set to “**Large**” (→ **page 41**).

When an optional unit is connected to the **UNIVERSAL PORT** jack on the AV receiver, the speaker setting menu may appear on screen.

■ Wireless SB (Surround Back)

▶ **Yes:**

The audio is output from the speakers connected to the wireless unit.

▶ **No:**

The audio is not output from the speakers connected to the wireless unit.

When the wireless unit is connected to the **UNIVERSAL PORT** jack on the AV receiver, you can select if you wish to output the audio of surround back channel from the speakers connected to the wireless unit.

Note

- If the “**Surround Back**” setting is set to “**None**” (→ **page 41**), this setting cannot be selected.

■ Wireless SW (Subwoofer)

▶ **Yes:**

The audio is output from the subwoofer connected to the wireless unit.

▶ **No:**

The audio is not output from the subwoofer connected to the wireless unit.

When the wireless unit is connected to the **UNIVERSAL PORT** jack on the AV receiver, you can select if you wish to output the audio from the subwoofer connected to the wireless unit.

Note

- If the “**Subwoofer**” setting is set to “**No**” (→ **page 41**), this setting cannot be selected.

Sp Distance (Speaker Distance)

Menu Sp Distance

This setting is set automatically by Audyssey 2EQ® Room Correction and Speaker Setup (→ **page 28**).

Here you can specify the distance from each speaker to the listening position so that the sound from each speaker arrives at the listener’s ears as the sound designer intended.

■ Unit

▶ **feet:**

Distances can be set in feet. Range: **1ft** to **30ft** in 1 foot steps.

▶ **meters:**

Distances can be set in meters. Range: **0.3m** to **9.0m** in 0.3 meter steps.

(The default setting varies from country to country.)

■ Left, Center, Right, Surround Right, Surr Back Right, Surr Back Left, Surround Left, Subwoofer

- ▶ Specify the distance from each speaker to your listening position.

Note

- These settings are not available in either of the following cases:
 - a pair of headphones is connected.
 - the “**Audio TV Out**” setting is set to “**On**” (→ **page 48**).
 - “**HDMI Ctrl (RIHD)**” is set to “**On**” (→ **page 48**) and you’re listening through your TV speakers.
- Speakers that you set to “**No**” or “**None**” in the “Sp Config (Speaker Configuration)” (→ **page 41**) cannot be selected.

Level Cal (Level Calibration)

Menu Level Cal

This setting is set automatically by Audyssey 2EQ Room Correction and Speaker Setup (→ **page 28**).

Here you can adjust the level of each speaker with the built-in test tone so that the volume of each speaker is the same at the listening position.

■ Left, Center*¹, Right, Surround Right, Surr Back Right, Surr Back Left, Surround Left

- ▶ **-12 dB** to **0 dB** to **+12 dB** in 1 dB steps.

■ Subwoofer*¹

- ▶ **-15 dB** to **0 dB** to **+12 dB** in 1 dB steps.

Note

- These settings cannot be calibrated in either of the following cases:
 - a pair of headphones is connected.
 - the “**Audio TV Out**” setting is set to “**On**” (→ **page 48**).
 - “**HDMI Ctrl (RIHD)**” is set to “**On**” (→ **page 48**) and you’re listening through your TV speakers.
 - the AV receiver is muted.
- Speakers that you set to “**No**” or “**None**” in “Sp Config (Speaker Configuration)” (→ **page 41**) cannot be selected.
- *¹ For the center speaker and subwoofer, the level settings made by using Home menu are saved here as the default settings.

Tip

- If you’re using a handheld sound level meter, adjust the level of each speaker so that it reads 75 dB SPL at the listening position, measured with C-weighting and slow reading.

With the Audio Adjust functions and settings, you can adjust the sound and listening modes as you like.

Multiplex/Mono

■ Multiplex

Input Ch (Mux)

▶ Main

▶ Sub

▶ Main/Sub

This setting determines which channel of a stereo multiplex source is output. Use it to select audio channels or languages with multiplex sources, multilingual TV broadcasts, and so on.

■ Mono

Input Ch (Mono)

▶ Left+Right

▶ Left

▶ Right

This setting specifies the channel to be used for playing any 2-channel digital source such as Dolby Digital, or 2-channel analog/PCM source in the Mono listening mode.

Dolby

■ PLIIx Music (2ch Input)

These settings only apply to 2-channel stereo sources. If you're not using any surround back speakers, these settings apply to Dolby Pro Logic II, not Dolby Pro Logic IIX.

Panorama

▶ On

▶ Off

Turn this setting on to broaden the width of the front stereo image when using the Dolby Pro Logic IIX Music listening mode.

Dimension

▶ -3 to 0 to +3

With this setting, you can move the sound field forward or backward when using the Dolby Pro Logic IIX Music listening mode. Higher settings move the sound field backward. Lower settings move it forward.

If the stereo image feels too wide, or there's too much surround sound, move the sound field forward to improve the balance. Conversely, if the stereo image feels like it's in mono, or there's not enough surround sound, move it backward.

Center Width

▶ 0 to 3 to 7

With this setting, you can adjust the width of the sound from the center speaker when using the Dolby Pro Logic IIX Music listening mode. Normally, if you're using a center speaker, the center channel sound is output only from the center speaker. (If you're not using a center speaker, the center channel sound will be distributed to the front left and right speakers to create a phantom center). This setting controls the front left, right, and center mix, allowing you to adjust the weight of the center channel sound.

■ Dolby EX

▶ Auto:

If the source signal contains a Dolby EX flag, the Dolby EX listening mode is used.

▶ Manual:

You can select any available listening mode.

This setting determines how Dolby EX encoded signals are handled. This setting is unavailable if no surround back speakers are connected. This setting is effective with Dolby Digital, Dolby Digital Plus and Dolby TrueHD only.

Note

- If the "Surround Back" Setting is set to "None" (→ page 41), this setting cannot be selected.

DTS

■ Neo:6 Music

Center Image

▶ 0 to 2 to 5

The DTS Neo:6 Music listening mode creates 6-channel surround sound from 2-channel stereo sources. With this setting, you can specify by how much the front left and right channel output is attenuated in order to create the center channel.

Changing the value from "0" to "5" will spread the sound of the center channel to left and right (outwards).

Theater-Dimensional

■ Listening Angle

▶ **Wide:**

Select if the listening angle is 40 degrees.

▶ **Narrow:**

Select if the listening angle is 20 degrees.

With this setting, you can optimize the Theater-Dimensional listening mode by specifying the angle of the front left and right speakers relative to the listening position. Ideally, the front left and right speakers should be equidistant from the listening position and at an angle close to one of the two available settings.

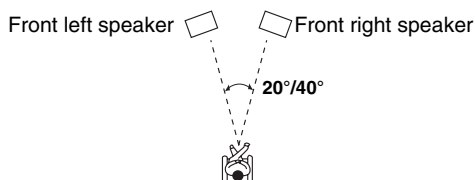

Source Setup

Menu

Source Setup

Preparation

Press the input selector buttons to select an input source.

Audyssey

The tone for each speaker is set automatically by Audyssey 2EQ® Room Correction and Speaker Setup. To enable the following settings, you must first perform the Room Correction and Speaker Setup (→ **page 28**).

■ Audyssey

▶ **Off**

▶ **Movie:**

Select this setting for movie material.

The **Audyssey** indicator will light (→ **page 8**).

▶ **Music:**

Select this setting for music material.

The **Audyssey** indicator will light (→ **page 8**).

Note

- When “**Audyssey Quick Start**” has been used for measurement, the “**Audyssey**” cannot be selected.
- Audyssey equalizing does not work for DSD sources.
- These technologies cannot be used when:
 - a pair of headphones is connected, or
 - either Pure Audio (European, Australian and Asian) or Direct listening mode is selected.

■ Dynamic EQ

▶ **Off**

▶ **On:**

Audyssey Dynamic EQ® becomes active.

The **Dynamic EQ** indicator will light (→ **page 8**).

With Audyssey Dynamic EQ, you can enjoy great sound even when listening at low volume levels.

Audyssey Dynamic EQ solves the problem of deteriorating sound quality as volume is decreased by taking into account human perception and room acoustics. It does so by selecting the correct frequency response and surround volume levels moment-by-moment so that the content sounds the way it was created at any volume level — not just at reference level.

Note

- These technologies cannot be used when:
 - a pair of headphones is connected, or
 - either Pure Audio (European, Australian and Asian) or Direct listening mode is selected.

■ Reference Level

Audyssey Dynamic EQ Reference Level Offset

▶ **0 dB:**

It should be used when listening to movies.

▶ **5 dB:**

Select this setting for content that has a very wide dynamic range, such as classical music.

▶ **10 dB:**

Select this setting for jazz or other music that has a wider dynamic range. This setting should also be selected for TV content as that is usually mixed at 10 dB below film reference.

▶ **15 dB:**

Select this setting for pop/rock music or other program material that is mixed at very high listening levels and has a compressed dynamic range.

Movies are mixed in rooms calibrated for film reference. To achieve the same reference level in a home theater system each speaker level must be adjusted so that –30 dBFS band-limited (500 Hz to 2000 Hz) pink noise produces 75 dB sound pressure level at the listening position. A home theater system automatically calibrated by Audyssey 2EQ will play at reference level when the master volume control is set to the 0 dB position. At that level you can hear the mix as the mixers heard it.

Audyssey Dynamic EQ is referenced to the standard film mix level. It makes adjustments to maintain the reference response and surround envelopment when the volume is turned down from 0 dB. However, film reference level is not always used in music or other non-film content. The Dynamic EQ Reference Level Offset provides three offsets from the film level reference (5 dB, 10 dB, and 15 dB) that can be selected when the mix level of the content is not within the standard.

Note

- If “**Dynamic EQ**” setting is set to “**Off**”, these technologies cannot be used.

■ Dynamic Volume

▶ Off

▶ Light:

Light Compression Mode becomes active.

▶ Medium:

Medium Compression Mode becomes active.

▶ Heavy:

Heavy Compression Mode becomes active. This setting affects volume the most. It quiets the loud parts, such as explosions, and boosts the quiet parts so they can be heard.

Note

- If you make Dynamic Volume active, “**Dynamic EQ**” is set to “**On**”. The **Dynamic Vol** indicator will light (→ **page 8**).
- When “**Dynamic EQ**” is set to “**Off**”, **Dynamic Volume**” become “**Off**” automatically.
- These technologies cannot be used when:
 - a pair of headphones is connected, or
 - either Pure Audio (European, Australian and Asian) or Direct listening mode is selected.

About Audyssey Dynamic EQ®

Audyssey Dynamic EQ solves the problem of deteriorating sound quality as volume is decreased by taking into account human perception and room acoustics. Dynamic EQ selects the correct frequency response and surround levels moment-by-moment at any user-selected volume setting. The result is bass response, tonal balance, and surround impression that remain constant despite changes in volume. Dynamic EQ combines information from incoming source levels with actual output sound levels in the room, a prerequisite for delivering a loudness correction solution. Audyssey Dynamic EQ works well by itself. However, if Audyssey 2EQ® is on, the two technologies work in tandem to provide well-balanced sound for every listener at any volume level.

About Audyssey Dynamic Volume®

Audyssey Dynamic Volume solves the problem of large variations in volume level between television programs, commercials, and between the soft and loud passages of movies. Dynamic Volume looks at the preferred volume setting by the user and then monitors how the volume of program material is being perceived by listeners in real time to decide whether an adjustment is needed. Whenever necessary, Dynamic Volume makes the necessary rapid or gradual adjustments to maintain the desired playback volume level while optimizing the dynamic range. Audyssey Dynamic Volume works fine by itself, but can also be used with Audyssey Dynamic EQ. When both are on, Audyssey Dynamic EQ adjusts the perceived bass response, tonal balance, surround impression, and dialog clarity whether watching movies, flipping between television channels, or changing from stereo to surround sound content, when Dynamic Volume adjusts the volume.

A/V Sync

■ A/V Sync

- ▶ **0 ms** to **400 ms** in 10 ms steps

When using progressive scanning on your Blu-ray Disc/DVD player, you may find that the picture and sound are out of sync. With this setting, you can correct this by delaying the audio signals.

To view the TV picture while setting the delay, press **ENTER**.

To return to the previous screen, press **RETURN**.

The range of values you can adjust will depend on whether your TV or display supports HDMI Lip Sync and if the “**LipSync**” setting is set to “**On**” or not (→ **page 49**)

Note

- A/V Sync is disabled when the Pure Audio (**European, Australian and Asian models**) or Direct listening mode is used with an analog input source.

Preset Name For Input Selector

■ Name

- ▶ **- - -**, **Blu-ray**, **DVD**, **HD DVD**, **VCR**, **DVR**, **Tivo**, **CableSTB**, **SAT STB**, **PS3**, **Wii**, **Xbox**, **PC**, **TV**, **CD**, **TAPE**, **iPod**:

To reset to the default, select “**- - -**”.

You can enter a preset name for each individual input selector for easy identification. When entered, the preset name will appear on the display.

Note

- You can't assign the same preset name to multiple input selectors.
- This menu cannot be used for the **TUNER**, **NET** or **USB** input selector.

Audio Selector

■ Audio Selector

▶ ARC:

The audio signal from your TV tuner can be sent digitally to the **HDMI OUT** of the AV receiver.*1 With this selection, the TV's audio can be automatically selected as a priority among other assignments.

▶ HDMI:

This can be selected when **HDMI IN** has been assigned as an input source. If both HDMI (**HDMI IN**) and digital audio inputs (**COAXIAL IN** or **OPTICAL IN**) have been assigned, HDMI input is automatically selected as a priority.

▶ COAXIAL:

This can be selected when **COAXIAL IN** has been assigned as an input source. If both coaxial and HDMI inputs have been assigned, coaxial input is automatically selected as a priority.

▶ OPTICAL:

This can be selected when **OPTICAL IN** has been assigned as an input source. If both optical and HDMI inputs have been assigned, optical input is automatically selected as a priority.

▶ Analog:

The AV receiver always outputs analog signals.

You can set priorities of audio output when there are both digital and analog inputs.

Note

- The setting is stored individually for each input selector.
- This setting can be made only for the input source that is assigned as **HDMI IN**, **COAXIAL IN**, or **OPTICAL IN**. If both HDMI (**HDMI IN**) and digital audio inputs (**COAXIAL IN** or **OPTICAL IN**) are assigned, HDMI input will be selected as a priority by setting to "ARC" (→ page 48). To select the digital audio input, see "Digital Audio (Digital Audio Input)" (→ page 40).

*1 You can select "ARC" if you select the **TV/CD** input selector. But you cannot select it if you've selected "Off" in the "Audio Return Ch" setting (→ page 48).

Setting the Incoming Digital Signal (Fixed Mode)

■ Fixed Mode

▶ Off:

The format is detected automatically. If no digital input signal is present, the corresponding analog input is used instead.

▶ PCM:

Only 2-channel PCM format input signals will be heard. If the input signal is not PCM, the **PCM** indicator will flash and noise may occur.

▶ DTS:

Only DTS (but not DTS-HD) format input signals will be heard. If the input signal is not DTS, the **DTS** indicator will flash and there will be no sound.

When "**HDMI**", "**COAXIAL**" or "**OPTICAL**" is selected in the "Audio Selector" setting, you can then specify the signal type in "Fixed Mode".

Normally, the AV receiver detects the signal format automatically. However, if you experience either of the following issues when playing PCM or DTS material, you can manually set the signal format to PCM or DTS.

- If the beginnings of tracks from a PCM source are cut off, try setting the format to PCM.
- If noise is produced when fast forwarding or reversing a DTS CD, try setting the format to DTS.

Note

- The setting will be reset to "Off" when you change the setting in "Audio Selector" (→ page 46).

Hardware

Menu

Hardware

OSD

■ Volume OSD

▶ On

▶ Off

You can select if you wish to display the volume level on-screen, when it is adjusted.

Remote Control

■ Remote ID

▶ 1, 2, or 3

When several Onkyo components are used in the same room, their remote ID codes may overlap. To differentiate the AV receiver from other components, you can change its remote ID from "1", to "2" or "3".

Note

- If you do change the AV receiver's remote ID, be sure to change the remote controller to the same ID (see below), otherwise, you won't be able to control it with the remote controller.

Changing the remote controller's ID

- 1** While holding down **RECEIVER**, press and hold down **SETUP** until the remote indicator lights (about 3 seconds) (→ page 39).
- 2** Use the number buttons to enter ID 1, 2, or 3. The remote indicator flashes twice.

Tuner

■ AM/FM Freq Step (North American and Taiwan models)

▶ 10kHz/200kHz:

▶ 9kHz/50kHz:

Select the frequency step according to your area.

■ AM Freq Step (European, Australian and Asian models)

▶ 10kHz:

▶ 9kHz:

Select the frequency step according to your area.

For AM/FM tuning to work properly, you must specify the AM/FM frequency step used in your area. Note that when this setting is changed, all radio presets will be deleted.

Auto Standby

■ Auto Standby

▶ Off

▶ On

When “**Auto Standby**” is set to “**On**”, AV receiver will automatically enter Standby mode if there is no operation for 30 minutes with no audio and no video signal input.

“**Auto Standby**” will appear on the display and OSD 30 seconds before the Auto Standby comes on.

Default setting: **On (European, Australian and Asian models)**, **Off (North American and Taiwan models)**

Note

- With some sources, the Auto Standby function may activate itself during playback.
- The Auto Standby function does not work when Zone 2 is on.

UP-A1

■ UP-A1 ChargeMode

▶ Auto:

Power feeding is interrupted when your iPod/iPhone is fully charged.

▶ On:

Power feeding continues even if your iPod/iPhone is fully charged.

▶ Off:

Your iPod/iPhone is not charged.

You can specify how the power is fed to your iPod/iPhone when the AV receiver is in Standby Mode.

Note

- This setting cannot be selected when:
 - the UP-A1 Dock with docked iPod/iPhone is not connected to the AV receiver, or
 - the docked iPod/iPhone model is not supported.
- When the “**UP-A1 ChargeMode**” setting is set to “**On**”, or to “**Auto**” with your iPod/iPhone recharging, the **SLEEP** indicator is dimly lit in standby mode. In such conditions, the power consumption of the AV receiver slightly increases.

■ HDMI Ctrl (RIHD)

- ▶ **Off**
- ▶ **On**

Turn this setting on to allow **RIHD**-compatible components connected via HDMI to be controlled by the AV receiver (→ **page 72**).

Note

- When the setting is set to “**On**” and the menu is closed, the names of connected **RIHD**-compatible components and “**RIHD On**” are displayed on the AV receiver. “**Search...**” → “**(name)**” → “**RIHD On**”
When the AV receiver cannot receive the name of the component, it is displayed as “**Player***” or “**Recorder***”, etc (“*” shows up and indicates the number of components, when two or more are received).
- When an **RIHD**-compatible component is connected to the AV receiver via an HDMI cable, the name of the connected component is displayed on the AV receiver display. For example, while you are watching TV broadcasting, if you operate a Blu-ray Disc/DVD player (being powered on) with the remote control of the AV receiver, the name of the Blu-ray Disc/DVD player will be displayed on the AV receiver.
- Set it to “**Off**” when a connected piece of equipment is not compatible or it is unclear whether the equipment is compatible or not.
- If operation is not normal when set to “**On**”, change the setting to “**Off**”.
- Refer to the connected component’s instruction manual for details.
- When “**HDMI Ctrl (RIHD)**” setting is set to “**On**”, the power consumption on standby mode slightly increases. (Depending on the TV status, the AV receiver will enter standby mode as usual.)

■ HDMI Through

- ▶ **Off**
- ▶ **Auto:**

Detects the signal and automatically selects the input source.

- ▶ **BD/DVD, VCR/DVR, CBL/SAT, GAME, AUX, TV/CD, PORT:**

Selects the input source for which the HDMI Through function is enabled.

- ▶ **Last:**

The HDMI Through function is activated on the input source selected at the time of setting the AV receiver to Standby mode.

When enabling the HDMI Through function, regardless of whether the AV receiver is On or in Standby, both audio and video stream from an HDMI input will be output to the TV or other components via HDMI connection. The **HDMI THRU** and **HDMI** indicators light when enabled.

This setting is set to “**Auto**” automatically when the above “**HDMI Ctrl (RIHD)**” is set to “**On**”.

Note

- Only the input source assigned to the **HDMI IN** via “**HDMI Input**” is enabled (→ **page 40**).
- The power consumption during standby mode will increase during the HDMI through function; however in the following cases, the power consumption can be saved:
 - The TV is in standby mode.
 - You are watching a TV program.
- Refer to the connected component’s instruction manual for details.
- Depending on the connected component, the correct input source may not be selected with the setting set to “**Auto**”.
- This setting is set to “**Off**” automatically when the “**HDMI Ctrl (RIHD)**” setting is set to “**Off**”.

■ Audio TV Out

- ▶ **Off**
- ▶ **On**

This preference determines whether the incoming audio signal is output from the HDMI output. You may want to turn this preference on if your TV is connected to the HDMI output and you want to listen to the audio from a connected component through your TV’s speakers. Normally, this should be set to “**Off**”.

Note

- Listening mode cannot be changed when this setting is set to “**On**” and the input source is not HDMI.
- If “**On**” is selected and the audio can be output from the TV, the AV receiver will output no sound through its speakers. In this case, “**TV Speaker**” appears on the display by pressing **DISPLAY**.
- When “**HDMI Ctrl (RIHD)**” is set to “**On**”, this setting is fixed to “**Auto**”.
- With some TVs and input signals, no sound may be output even when this setting is set to “**On**”.
- When the “**Audio TV Out**” setting is set to “**On**”, or “**HDMI Ctrl (RIHD)**” is set to “**On**” and you’re listening through your TV’s speakers (→ **page 15**), if you turn up the AV receiver’s volume control, the sound will be output by the AV receiver’s front left and right speakers. To stop the AV receiver’s speakers producing sound, change the settings, change your TV’s settings, or turn down the AV receiver’s volume.

■ Audio Return Ch (ARC)

- ▶ **Off**
- ▶ **Auto:**

The audio signal from your TV tuner can be sent to the **HDMI OUT** of the AV receiver.

The audio return channel (ARC) function allows an ARC capable TV to send the audio stream to the **HDMI OUT** of the AV receiver. To use this function, you must select the **TV/CD** input selector and your TV must be ARC capable.

Note

- If you set “**Audio Return Ch**” to “**Auto**”, the “**Audio Selector**” settings of the **TV/CD** input selector will be automatically switched to “**ARC**” (→ **page 46**).
- The “**Audio Return Ch**” setting can be set only when the above “**HDMI Ctrl (RIHD)**” setting is set to “**On**”.
- This setting is set to “**Auto**” automatically when the above “**HDMI Ctrl (RIHD)**” is set to “**On**” for the first time.

■ LipSync

- ▶ **Off**
- ▶ **On**

This function allows the AV receiver to automatically correct any delay between the video and the audio, based on the data from the connected monitor.

Note

- This function works only if your HDMI-compatible TV supports HDMI Lip Sync.

After changing the settings of the “**HDMI Ctrl (RIHD)**”, “**HDMI Through**” or “**Audio Return Ch**”, turn off the power of all connected pieces of equipment and then turn them on again. Refer to the instructions for all connected pieces of equipment.

Network Setup

Menu

Network Setup

After modifying the network settings, you must confirm the changes by executing “**Save**”.

This section explains how to configure the AV receiver’s network settings manually.

If your router’s DHCP server is enabled, you don’t need to change any of these settings, as the AV receiver is set to use DHCP to configure itself automatically by default (i.e., DHCP is set to “**Enable**”). If, however, your router’s DHCP server is disabled (you’re for example using static IP), you’ll need to configure these settings yourself, in which case, a knowledge of Ethernet networking is essential.

What’s DHCP?

DHCP (Dynamic Host Configuration Protocol) is used by routers, computers, the AV receiver, and other devices to automatically configure themselves on a network.

What’s DNS?

The DNS (Domain Name System) translates domain names into IP addresses. For example, when you enter a domain name such as *www.onkyousa.com* in your Web browser, before accessing the site, your browser uses DNS to translate this into an IP address, in this case 63.148.251.142.

■ MAC Address

This is the AV receiver’s MAC (Media Access Control) address. This address cannot be changed.

■ DHCP

- ▶ **Enable**
- ▶ **Disable**

This setting determines whether or not the AV receiver uses DHCP to automatically configure its IP Address, Subnet Mask, Gateway, and DNS Server settings.

Note

- If you select “**Disable**”, you must configure the “**IP Address**”, “**Subnet Mask**”, “**Gateway**”, and “**DNS Server**” settings yourself.

■ IP Address

- ▶ Class A:
“**10.0.0.0**” to “**10.255.255.255**”
- ▶ Class B:
“**172.16.0.0**” to “**172.31.255.255**”
- ▶ Class C:
“**192.168.0.0**” to “**192.168.255.255**”

Enter a static IP address provided by your ISP. Most routers use Class C IP addresses.

■ Subnet Mask

Enter the subnet mask address provided by your ISP (typically **255.255.255.0**).

■ Gateway

Enter the gateway address provided by your ISP.

■ DNS Server

Enter a DNS server address provided by your ISP.

■ Proxy URL

To use a Web proxy, enter its URL here.

■ Proxy Port

If you’re using a Web proxy, enter a proxy port number here.

■ Network Control

- ▶ **Enable**
- ▶ **Disable**

This setting enables or disables control over the network.

Note

- When set to “**Enable**”, the **NET** indicator is dimly-lit and the power consumption slightly increases in standby mode.

■ Control Port

- ▶ “**49152**” to “**65535**”

This is the network port used for control over the network.

Note

- When the “**Network Control**” setting is set to “**Disable**”, this setting is cannot be selected.

See “Firmware Update” for the update procedure (→ **page 66**).

Note

- Perform the firmware update only when such an announcement is posted on the Onkyo web site. Visit the Onkyo web site for the latest information.
- It takes about 30 minutes to complete the firmware update.

Version

Displays the current version of the firmware.

Receiver▶ **via NET:**

Performs the firmware update via Internet. Check the network connection before updating.

▶ **via USB:**

Performs the firmware update from a USB device.

These settings allow you to update the AV receiver’s firmware. Do not shutdown the power of the AV receiver while updating.

Universal Port▶ **via NET:**

Performs the firmware update via Internet. Check the network connection before updating.

▶ **via USB:**

Performs the firmware update from a USB device.

You can update the Onkyo dock’s firmware. Do not shutdown the power of the AV receiver while update.

Note

- This update shall not be performed when no dock is connected to **UNIVERSAL PORT** jack.

You can change various audio settings from the Home menu (→ **page 36**).

1 Press **RECEIVER** followed by **HOME**.

2 Use **▲/▼** and **ENTER** to select “Audio”, and then use **▲/▼/◀/▶** to make the desired selection.

Note

- These settings are not available in either of the following cases:
 - a pair of headphones is connected.
 - the “**Audio TV Out**” setting is set to “**On**” (→ **page 48**).
 - “**HDMI Ctrl (RIHD)**” is set to “**On**” (→ **page 48**) and you’re listening through your TV speakers.

Tone Control**Bass**

▶ **–10 dB to 0 dB to +10 dB** in 2 dB steps

You can boost or cut low-frequency sounds output from the front speakers.

Treble

▶ **–10 dB to 0 dB to +10 dB** in 2 dB steps

You can boost or cut high-frequency sounds output from the front speakers.

You can adjust the bass and treble for the front speakers, except when Direct or Pure Audio (**European, Australian and Asian models**) listening mode is selected.

Operating on the AV receiver

1 Press **TONE** on the AV receiver repeatedly to select either “**Bass**” or “**Treble**”.

2 Use **+** and **–** on the AV receiver to adjust.

Note

- To bypass the bass and treble tone circuits, select the Direct or Pure Audio listening mode.

Speaker Levels**Subwoofer Level**

▶ **–15 dB to 0 dB to +12 dB** in 1 dB steps

Center Level

▶ **–12 dB to 0 dB to +12 dB** in 1 dB steps

You can adjust the volume of each speaker while listening to an input source.

These temporary adjustments are cancelled when the AV receiver is set to Standby. To save the setting you made here, go to “Level Cal (Level Calibration)” (→ **page 42**) before setting the AV receiver to Standby.

Note

- You cannot use this function while the AV receiver is muted.
- Speakers that are set to “**No**” or “**None**” in “Sp Config (Speaker Configuration)” (→ **page 41**) cannot be adjusted.

Audyssey

■ Audyssey

See “Audyssey” of “Source Setup” (→ [page 44](#)).

■ Dynamic EQ

See “Dynamic EQ” of “Source Setup” (→ [page 44](#)).

■ Dynamic Volume

See “Dynamic Volume” of “Source Setup” (→ [page 45](#)).

Note

- These technologies can be used when all the following conditions are met:
 - Room Correction and Speaker Setup is completed. Note that “Audyssey” requires the “**Audyssey 2EQ Full Calibration**” method.
 - Any listening mode other than Direct or Pure Audio (**European, Australian and Asian models**) is selected.
 - A pair of headphones is not connected.
- The setting is stored individually for each input selector.

Late Night Function

■ Late Night

For **Dolby Digital** and **Dolby Digital Plus** sources, the options are:

- ▶ **Off**
- ▶ **Low:**
Small reduction in dynamic range.
- ▶ **High:**
Large reduction in dynamic range.

For **Dolby TrueHD** sources, the options are:

- ▶ **Auto:**
The Late Night function is set to “**On**” or “**Off**” automatically.
- ▶ **Off**
- ▶ **On**

Turn this setting on to reduce the dynamic range of Dolby Digital material so that you can still hear quiet parts even when listening at low volume levels—ideal for watching movies late at night when you don’t want to disturb anyone.

Note

- The effect of the Late Night function depends on the material that you are playing and the intention of the original sound designer, and with some material there will be little or no effect when you select the different options.
- The Late Night function can be used only when the input source is Dolby Digital, Dolby Digital Plus, or Dolby TrueHD.
- The Late Night function is set to “**Off**” when the AV receiver is set to Standby. For Dolby TrueHD sources, it will be set to “**Auto**”.

Music Optimizer

■ Music Optimizer

- ▶ **Off**
- ▶ **On**

Turn this setting on to enhance the sound quality of compressed music files. Use it with music files that use “lossy” compression, such as MP3.

Tip

- (**North American and Taiwan models**) Alternatively, you can use the AV receiver’s **MUSIC OPTIMIZER**.

Note

- The Music Optimizer function only works with PCM digital audio input signals with a sampling rate below 48 kHz and analog audio input signals. The Music Optimizer is disabled when the Direct or Pure Audio listening mode is selected.
- The setting is stored individually for each input selector.
- The **M.Opt** indicator will light (→ [page 8](#)).
- (**North American and Taiwan models**) The **MUSIC OPTIMIZER** indicator lights on the front panel (→ [page 8](#)).

CinemaFILTER

■ Cinema Filter

- ▶ **Off**
- ▶ **On**

Turn this setting on to soften overly bright movie soundtracks, which are typically mixed for reproduction in a movie theater.

CinemaFILTER can be used with the following listening modes: Dolby Digital, Dolby Digital EX, Dolby Digital Plus, Dolby TrueHD, Dolby Pro Logic IIX Movie, Dolby Pro Logic II Movie, Multichannel, DTS, DTS-ES, DTS Neo:6 Cinema, DTS 96/24, Neo:6, DTS-HD High Resolution Audio, DTS-HD Master Audio and DTS Express.

Note

- The CinemaFILTER may not work when used with certain input sources.

Zone 2

In addition to the main listening room, you can also enjoy playback in another room, which we call Zone 2. For either of the rooms, you can specify a different input source.

Making Zone 2 Connections

Connecting the Zone Speakers to an Additional Amplifier

This setup allows 5.1-channel playback in your main listening room and 2-channel stereo playback in Zone 2.

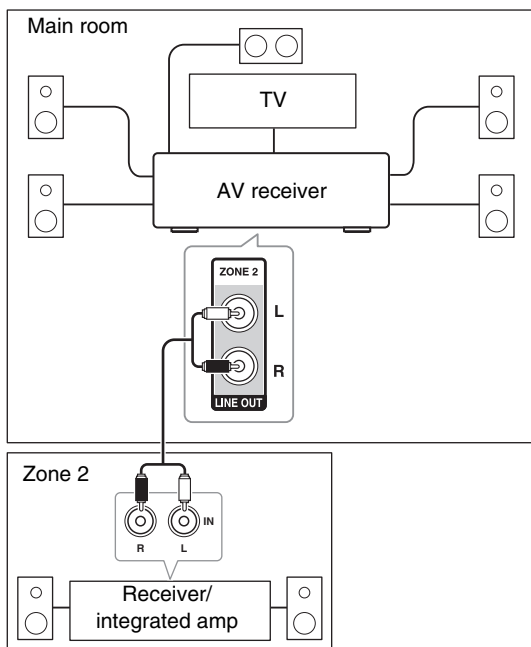

Note

- The volume of Zone 2 must be set on the Zone 2 amp.

Controlling Zone 2 Components

Operating on the AV receiver

ZONE 2 OFF Input selector buttons

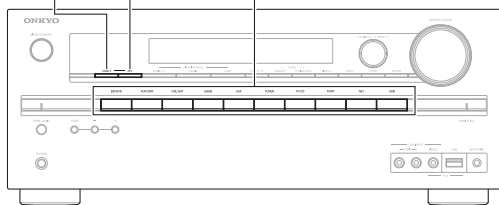

- 1 To turn on Zone 2 and select an input source, press **ZONE 2** followed by an input selector button within 8 seconds.

The **Z2** (Zone 2) indicator lights.

To select AM or FM, press the **TUNER** input selector and **ZONE 2** repeatedly.

To select the same source as the main room's, press **ZONE 2** twice. "**Z2 Selector: Source**" appears on the display.

To turn off Zone 2, press **OFF**.

The zone is turned off.

Operating on the remote controller

To control Zone 2, you must press **ZONE2** on the remote controller first.

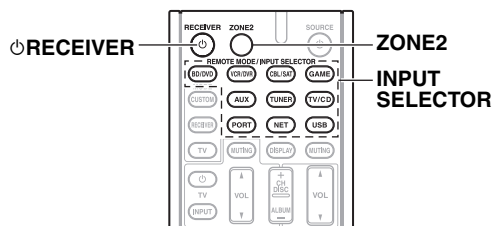

- 1 Press **ZONE2**, then point the remote controller at the AV receiver and press **RECEIVER**.

The **Z2** (Zone 2) indicator lights.

- 2 To select an input source for Zone 2, press **ZONE2**, followed by **INPUT SELECTOR**.

To select AM or FM, press the **TUNER** input selector and **ZONE2** repeatedly.

To turn off Zone 2, press **ZONE2**, followed by **RECEIVER**.

The zone is turned off.

Note

- With Zone 2, only analog input sources are processed. Digital input sources are not output. If no sound is heard when an input source is selected, verify that the source is connected to an analog input.
- You cannot select different AM or FM radio stations for your main room and Zone 2. The same AM/FM radio station will be heard in each room. Namely, if you have selected an FM station for the main room, that station will also be output in Zone 2.
- When you have selected either **NET** or **USB** as the input selector for the main room, the same one will be set for Zone 2.
- When the input selector of Zone 2 is selected, the power consumption in standby mode slightly increases.
- While Zone 2 is on, **RI** functions will not work.
- When setting the AV receiver to standby mode while Zone 2 is active, the **Z2** indicator is dimly lit.
- Activating Zone 2 in the main room when the listening mode is set to Pure Audio will automatically switch it to Direct.

iPod/iPhone Playback via Onkyo Dock

Using the Onkyo Dock

Dock is sold separately. Models sold are different depending on the region.

For the latest information on the Onkyo Dock components, see the Onkyo web site at:

<http://www.onkyo.com>

Before using the Onkyo Dock components, update your iPod/iPhone with the latest software, available from the Apple web site.

For supported iPod/iPhone models, see the instruction manual of the Onkyo Dock.

UP-A1 Dock

With the UP-A1 Dock, you can easily play the music, photo, or movie stored on your Apple iPod/iPhone through the AV receiver and enjoy great sound.

You can use the AV receiver's remote controller to operate your iPod/iPhone.

■ System Function

The AV receiver may take several seconds to startup, so you might not hear the first few seconds of the first song.

Auto Power On

If you start iPod/iPhone playback while the AV receiver is on Standby, the AV receiver will automatically turn on and select your iPod/iPhone as the input source.

Direct Change

If you start iPod/iPhone playback while listening to another input source, the AV receiver will automatically select your iPod/iPhone as the input source.

Using the AV receiver's Remote Controller

You can use the AV receiver's remote controller to control basic iPod/iPhone functions (→ [page 54](#)).

■ Operating Notes

- Functionality depends on your iPod/iPhone model and generation.
- Before selecting a different input source, stop iPod/iPhone playback to prevent the AV receiver from selecting the iPod/iPhone input source by mistake.
- If any accessories are connected to your iPod/iPhone, the AV receiver may not be able to select the input source properly.
- When connecting UP-A1 Dock to the radio tuner UP-HT1 (North American models)/UP-DT1 (European, Australian and Asian models) with AUTO selected by the tuner's Mode Selector switch, you can switch the input source between UP-A1 Dock and the tuner, by pressing **PORT** repeatedly on the front panel.
- While your iPod/iPhone is in the UP-A1 Dock, its volume control has no effect. If you adjust your iPod/iPhone models volume control while it's in the UP-A1 Dock, make sure it's not set too high before you reconnect your headphones.
- The Auto Power On function will not work if you set your iPod/iPhone in the UP-A1 Dock while it is playing.
- When Zone 2 is turned on, you can't use Auto Power On and Direct Change functions.
- Do not turn off the power with the iPod/iPhone still connected to this unit via the UP-A1 Dock.
- Set your iPod/iPhone in the UP-A1 Dock after the AV receiver turns on.
- "**UP-A1 ChargeMode**" must be set to "**On**" to enable the Auto Power On and Direct Change functions (→ [page 47](#)).

■ Using Your iPod/iPhone models Alarm Clock

You can use your iPod/iPhone models Alarm Clock function to automatically turn on your iPod/iPhone and the AV receiver at a specified time. The AV receiver's input source will automatically be set to the **PORT** selector.

Note

- To use this function, your iPod/iPhone must be in the UP-A1 Dock, and the UP-A1 Dock must be connected to the AV receiver.
- This function works only in the Standard mode (→ [page 55](#)).
- When you use this function, be sure to set the AV receiver's volume control to a suitable level.
- When Zone 2 is turned on, you can't use this function.
- You cannot use this function for sound effects on your iPod/iPhone.
- "**UP-A1 ChargeMode**" must be set to "**On**" to enable the Alarm Clock (→ [page 47](#)).

■ Charging Your iPod/iPhone models Battery

The UP-A1 Dock charges your iPod/iPhone models battery while your iPod/iPhone is in the UP-A1 Dock connected to the AV receiver. While your iPod/iPhone is seated in the UP-A1 Dock, its battery will be charged when the AV receiver is set to On or Standby.

You can specify how the power is fed to your iPod/iPhone when the AV receiver is in Standby Mode (→ [page 47](#)).

Note

- When UP-A1 Dock that seated iPod/iPhone is connected, the power consumption on standby mode slightly increases.

■ Status Messages

If either of the following message is not displayed on the AV receiver's display, check the connection to your iPod/iPhone.

• PORT Reading

The AV receiver is checking the connection with the dock.

• PORT Not Support

The AV receiver do not support the connected dock.

• PORT UP-A1

UP-A1 Dock is connected.

Note

- The AV receiver displays the message "UP-A1" for several seconds after recognizing the UP-A1.

RI Dock

With the RI Dock, you can easily play the music stored on your Apple iPod/iPhone through the AV receiver and enjoy great sound, and watch iPod/iPhone slideshows and videos on your TV. In addition, the onscreen display (OSD) allows you to view, navigate, and select your iPod/iPhone model's contents on your TV, and with the supplied remote controller, you can control your iPod/iPhone from the comfort of your sofa. You can even use the AV receiver's remote controller to operate your iPod/iPhone.

Note

- Enter the appropriate remote control code before using the AV receiver's remote controller for the first time (→ **page 56**).
- Connect the RI Dock to the AV receiver with an **RI** cable (→ **page 17**).
- Set the RI Dock's RI MODE switch to "HDD" or "HDD/DOCK".
- Set the AV receiver's Input Display to "DOCK" (→ **page 37**).

■ System Function

System On

When you turn on the AV receiver, RI Dock and iPod/iPhone turn on automatically. In addition, when RI Dock and iPod/iPhone are on, the AV receiver can be turned on by pressing **SOURCE**.

Auto Power On

If you press the remote controller's **▶** (Playback) while the AV receiver is on Standby, the AV receiver will automatically turn on, select your iPod/iPhone as the input source, and your iPod/iPhone will start playback.

Direct Change

If you start iPod/iPhone playback while listening to another input source, the AV receiver will automatically switch to the input to which RI Dock is connected.

Other Remote Controllers

You can use the remote controller that came with the AV receiver to control other iPod/iPhone functions. The available functionality depends on the AV receiver.

iPod/iPhone Alarm

If you use the Alarm function on your iPod/iPhone to start playback, the AV receiver will turn on at the specified time and select your iPod/iPhone as the input source automatically.

Note

- Linked operations do not work with video playback or when the alarm is set to play a sound.
- If you use your iPod/iPhone with any other accessories, iPod/iPhone playback detection may not work.

■ Operating Notes

- Use the AV receiver's volume control to adjust the playback volume.
- While your iPod/iPhone is inserted in RI Dock, its volume control has no effect.
- If you do adjust the volume control on your iPod/iPhone while it's inserted in RI Dock, be careful that it's not set too loud before you reconnect your earphones.

Note

- On the iPod with video and iPod nano(1st generation), the click wheel is disabled during playback.

Controlling Your iPod/iPhone

By pressing **REMOTE MODE** that's been programmed with the remote control code for your Dock, you can control your iPod/iPhone in the Dock with the following buttons.

See "Entering Remote Control Codes" for details on entering a remote control code (→ **page 56**).

See the Dock's instruction manual for more information.

■ UP-A1 Dock

PORT is preprogrammed with the remote control code for controlling a Dock with Universal Port connector.

You can control your iPod/iPhone when "PORT" is selected as the input source.

■ RI Dock

- Set the RI Dock's RI MODE switch to "HDD" or "HDD/DOCK".
- **SOURCE** may not work with a remote control code (without **RI**). In this case, make an **RI** connection and enter the remote control code **81993** (with **RI**).

With the RI Control

In this case, make an **RI** connection and enter the remote control code **81993** (with **RI**).

- Set the AV receiver's Input Display to "DOCK" (→ **page 37**).

Without the RI Control

You must enter the remote control code **82990** first (→ **page 56**).

✓: Available buttons

Press the appropriate **REMOTE MODE** first.

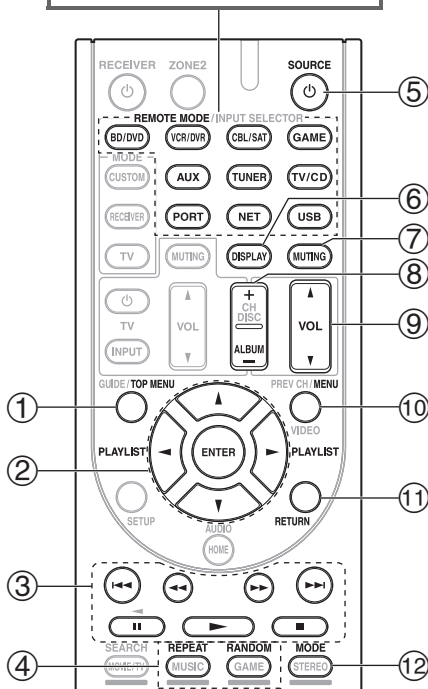

		Onkyo Dock	UP-A1 Dock	RI Dock
Buttons				
①	TOP MENU*1			✓
②	▲/▼/◀/▶, ENTER	✓*2		✓
	PLAYLIST ◀/▶	✓		✓
③	▶, II, ■, ◀◀, ▶▶, ◀◀, ▶▶	✓		✓
④	REPEAT	✓		✓
	RANDOM	✓		✓
⑤	⏻ SOURCE*3			✓
⑥	DISPLAY*4	✓		✓
⑦	MUTING	✓		✓
⑧	ALBUM +/-	✓		✓
⑨	VOL ▲/▼	✓		✓
⑩	MENU			✓
⑪	RETURN	✓		
⑫	MODE	✓*5		✓*6

Note

- With some iPod/iPhone models, generations and RI Docks, certain buttons may not work as expected.
- For detailed operation of iPod/iPhone, please refer to the instruction manual of RI Dock.
- *1 **TOP MENU** works as a Mode button when used with a DS-A2 RI Dock.
- *2 In Extended mode (see *5), ◀/▶ is used as the page jump button.
With the page modes, you can quickly locate your favorite songs even when your song lists, artist lists, and so on are very long.
- *3 This button does not turn the Onkyo DS-A2 or DS-A2X RI Dock on or off. Your iPod/iPhone may not respond the first time you press this button, in which case you should press it again.
This is because the remote controller transmits the On and Standby commands alternately, so if your iPod/iPhone is already on, it will remain on when the remote controller transmits an On command.
Similarly, if your iPod/iPhone is already off, it will remain off when the remote controller transmits an Off command.
- *4 **DISPLAY** turns on backlight for 30 seconds.
- *5 Press **MODE** to change the following modes:
Standard mode
Nothing is displayed on your TV and you navigate and select your contents by using your iPod/iPhone models display.
Only this mode can playback the video.
Extended mode
Playlists (artists, albums, songs, and so on) are displayed on your TV, and you can navigate and select your music while looking at your TV.
- *6 **Resume mode**
With the Resume function, you can resume playback of the song that was playing when you removed your iPod/iPhone from the RI Dock or changed the OSD mode to Off.

Note

- In Extended mode (see *5), the playback will be continued even if the AV receiver is turned off.
- In Extended mode (see *5), you cannot operate your iPod/iPhone directly.
- In Extended mode (see *5), it may take some time to acquire the contents.
- In Extended mode (see *5), video contents can not display on your TV.
- In Extended mode (see *5), the on-screen navigation menus only appear on a TV that is connected to the HDMI output.

Controlling Other Components

You can use the AV receiver's remote controller to control your other AV components. This section explains how to enter the remote control code (with the default underlined) for a component that you want to control: DVD, TV, CD, etc.

Preprogrammed Remote Control Codes

The following **REMOTE MODE** are preprogrammed with remote control codes for controlling the components listed. You do not need to enter a remote control code to control these components.

For details on controlling these components, see the pages indicated.

- BD/DVD** Onkyo Blu-ray Disc player (→ **page 57**)
TV/CD Onkyo CD player (→ **page 56**)
PORT Onkyo Universal Port Option (→ **page 54**)

Entering Remote Control Codes

You'll need to enter a code for each component that you want to control.

1 Look up the appropriate remote control code in the separate Remote Control Codes list.

The codes are organized by category (e.g., DVD player, TV, etc.).

2 While holding down the **REMOTE MODE** to which you want to assign a code, press and hold down **DISPLAY** until the remote indicator lights (about 3 seconds).

Note

- Remote control codes cannot be entered for **RECEIVER** and **ZONE 2**.
- Only TV remote control codes can be entered for **TV**.
- Apart from **RECEIVER**, **TV**, and **ZONE 2**, remote control codes from any category can be entered for **REMOTE MODE**. However, these buttons also work as input selector buttons (→ **page 20**), so choose a **REMOTE MODE** that corresponds with the input to which you connect your component. For example, if you connect your CD player to the CD input, choose **TV/CD** when entering its remote control code.

3 Within 30 seconds, use the number buttons to enter the 5-digit remote control code.

The remote indicator flashes twice.

If the remote control code is not entered successfully, the remote indicator will flash once slowly.

Note

- The remote control codes provided are correct at the time of printing, but are subject to change.

Remote Control Codes for Onkyo Components Connected via **RI**

Onkyo components that are connected via **RI** are controlled by pointing the remote controller at the AV receiver, not the component. This allows you to control components that are out of view, in a rack, for example.

- 1 **Make sure the Onkyo component is connected with an **RI** cable and an analog audio cable (RCA).**
See "Connecting Onkyo **RI** Components" for details (→ **page 17**).
- 2 **Enter the appropriate remote control code for **REMOTE MODE**, by referring to the previous section.**
 - ▶ **42157:**
Onkyo cassette tape deck with **RI**
 - ▶ **81993:**
Onkyo Dock with **RI**
- 3 **Press **REMOTE MODE**, point the remote controller at the AV receiver, and operate the component.**

Controlling Onkyo components without **RI**

If you want to control an Onkyo component by pointing the remote controller directly at it, or you want to control an Onkyo component that's not connected via **RI**, use the following remote control codes:

- ▶ **30627:**
Onkyo DVD player without **RI**
- ▶ **71817:**
Onkyo CD player without **RI**
- ▶ **32900/33100/33500:**
Onkyo Blu-ray Disc player
- ▶ **32901/33104/33504:**
Onkyo HD DVD player
- ▶ **70868:**
Onkyo MD recorder without **RI**
- ▶ **71323:**
Onkyo CD recorder without **RI**
- ▶ **82990:**
Onkyo Dock without **RI**

Resetting REMOTE MODE Buttons

You can reset a **REMOTE MODE** to its default remote control code.

- 1 While holding down the **REMOTE MODE** that you want to reset, press and hold down **HOME** until the remote indicator lights (about 3 seconds).
- 2 Within 30 seconds, press the **REMOTE MODE** again.

The remote indicator flashes twice, indicating that the button has been reset.

Each of the **REMOTE MODE** is preprogrammed with a remote control code. When a button is reset, its preprogrammed code is restored.

Resetting the Remote Controller

You can reset the remote controller to its default settings.

- 1 While holding down **RECEIVER**, press and hold down **HOME** until the remote indicator lights (about 3 seconds).
- 2 Within 30 seconds, press **RECEIVER** again.

The remote indicator flashes twice, indicating that the remote controller has been reset.

Controlling Other Components

By pressing **REMOTE MODE** that's been programmed with the remote control code for your component, you can control your component as below.

For details on entering a remote control code for a different component (→ page 56).

Controlling a TV

TV is preprogrammed with the remote control code for controlling a TV that supports the **RIHD***1 (limited to some models). The TV must be able to receive remote control commands via **RIHD** and be connected to the AV receiver via HDMI. If controlling your TV via **RIHD** doesn't work very well, program your TV's remote control code into **TV** and use the TV remote mode to control your TV.

Use the following remote control codes:

▶ **11807/13100/13500:**

TV with **RIHD**

Controlling a Blu-ray Disc/DVD Player, HD DVD Player or DVD Recorder

BD/DVD is preprogrammed with the remote control code for controlling a component that supports the **RIHD***1. The component must be able to receive remote control commands via **RIHD** and be connected to the AV receiver via HDMI.

Use the following remote control codes:

▶ **32910/33101/33501/31612:**

Blu-ray Disc/DVD player with **RIHD**

*1 The **RIHD** supported by the AV receiver is the CEC system control function of the HDMI standard.

✓: Available buttons

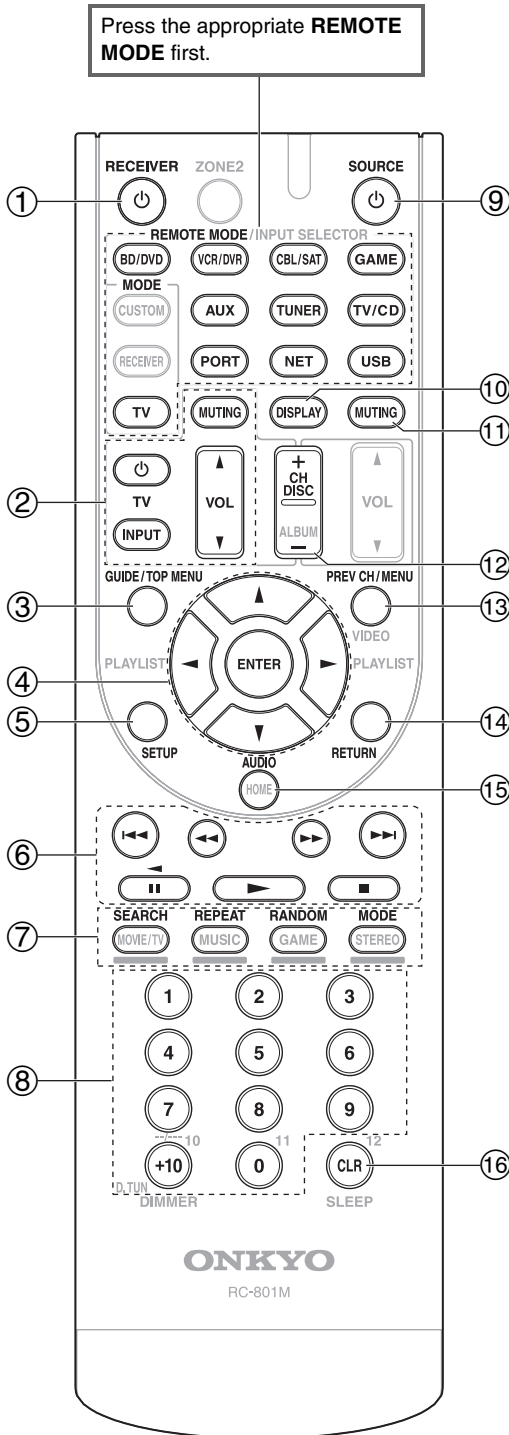

Buttons	Components						
	TV	DVD player/DVD recorder	Blu-ray Disc player HD DVD player	VCR/PVR	Satellite receiver Cable receiver	CD player/CD recorder MD recorder	Cassette tape deck
1 RECEIVER	✓	✓		✓	✓	✓	✓
2 INPUT, TV VOL ▲/▼, MUTING	✓						
3 GUIDE TOP MENU	✓			✓	✓		
4 ▲/▼/◀/▶ ENTER	✓	✓		✓	✓	✓	
5 SETUP	✓	✓		✓	✓	✓	
6 ▶, II, ■, ◀, ▶, ◀, ▶▶, ▶▶▶	✓*1	✓		✓	✓	✓	✓*3
7 SEARCH REPEAT RANDOM MODE	✓*1*2	✓*1	✓*2		✓*2	✓	
8 Number: 1 to 9, 0	✓	✓		✓	✓	✓	
9 NUMBER: +10	✓*1	✓*1		✓	✓	✓	
10 DISPLAY	✓	✓		✓	✓	✓	
11 MUTING	✓	✓		✓	✓	✓	✓
12 CH +/- DISC +/-	✓	✓		✓	✓	✓	
13 PREV CH MENU	✓			✓	✓		
14 RETURN	✓	✓		✓	✓		
15 AUDIO	✓*1	✓*1			✓		
16 CLR	✓	✓		✓	✓	✓	

*1 The **RIHD** function is not supported. The **RIHD** supported by the AV receiver is the CEC system control function of the HDMI standard.

*2 These buttons function as colored buttons or A, B, C, D buttons.

*3 **II** (Pause) functions as reverse playback.

*4 When you press the **SOURCE**, the related component is turned on (or off).

Note

• See the “Controlling Your iPod/iPhone” about the operation of iPod/iPhone (→ **page 54**).

Note

• With some components, certain buttons may not work as expected, and some may not work at all.

Troubleshooting

If you have any trouble using the AV receiver, look for a solution in this section. If you can't resolve the issue yourself, contact your Onkyo dealer.

If you can't resolve the issue yourself, try resetting the AV receiver before contacting your Onkyo dealer.

To reset the AV receiver to its factory defaults, turn it on and, while holding down VCR/DVR, press **ON/STANDBY. “Clear” will appear on the display and the AV receiver will enter Standby mode.**

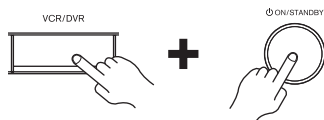

Note that resetting the AV receiver will delete your radio presets and custom settings.

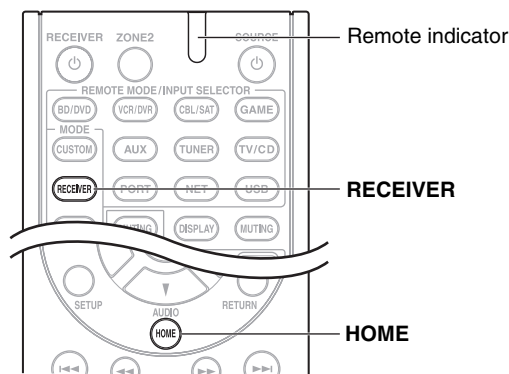

To reset the remote controller to its factory defaults, while holding down **RECEIVER**, press and hold down **HOME** until the remote indicator lights (about 3 seconds). Within 30 seconds, press **RECEIVER** again.

The on-screen setup menus appear only on a TV that is connected to the HDMI OUT. If your TV is connected to the MONITOR OUT V or the COMPONENT VIDEO OUT, use the AV receiver's display when changing settings.

Power

■ Can't turn on the AV receiver

Make sure that the power cord is properly plugged into the wall outlet. —

Unplug the power cord from the wall outlet, wait five seconds or more, then plug it in again. —

■ The AV receiver turns off unexpectedly

When the set Auto Standby starts running, the AV receiver will automatically go standby. **47**

■ When the power is restored after a power interruption, “CHECK SP WIRE” appears on the display

The protection circuit has been activated. Remove the power cord from the wall outlet immediately. Disconnect all speaker cables and input sources, and leave the AV receiver with its power cord disconnected for 1 hour. After that, reconnect the power cord and set the volume to maximum. If the AV receiver stays on, set the volume to minimum, disconnect the power cord, and reconnect your speakers and input sources. If the AV receiver turns off when you set the volume to maximum, disconnect the power cord, and contact your Onkyo dealer.

Audio

■ There's no sound, or it's very quiet

Make sure that the digital input source is selected properly. **40**

Make sure that all audio connecting plugs are pushed in all the way. **14**

Make sure that the inputs and outputs of all components are connected properly. **15-17**

Make sure that the polarity of the speaker cables is correct, and that the bare wires are in contact with the metal part of each speaker terminal. **12**

Make sure that the input source is properly selected. **20**

Make sure that the speaker cables are not shorting. **12**

Check the volume. The AV receiver is designed for home theater enjoyment. It has a wide volume range, allowing precise adjustment. **20**

While a pair of headphones is connected to the **PHONES** jack, no sound is output from the speakers. **37**

If there's no sound from a DVD player connected to an HDMI IN, check the DVD player's output settings, and be sure to select a supported audio format. **71**

Check the digital audio output setting on the connected device. On some game consoles, such as those that support DVD, the default setting is off. —

With some DVD-Video discs, you need to select an audio output format from a menu. —

If your turntable uses an MC cartridge, you must connect an MC head amp, or an MC transformer. **16**

Make sure that none of the connecting cables are bent, twisted, or damaged. —

Not all listening modes use all speakers. **31**

Specify the speaker distances and adjust the individual speaker levels. **42**

Make sure that the speaker setup microphone is not still connected. —

The input signal format is set to “PCM” or “DTS”. Set it to “Off”. **46**

■ Only the front speakers produce sound

When the Stereo or Mono listening mode is selected, only the front speakers and subwoofer produce sound. **33**

Check the Speaker Configuration. **41**

■ Only the center speaker produces sound

If you use the Dolby Pro Logic IIx Movie, Dolby Pro Logic IIx Music, or Dolby Pro Logic IIx Game listening mode with a mono source, such as an AM radio station or mono TV program, the sound is concentrated in the center speaker. —

Make sure the speakers are configured correctly. **41**

■ The surround speakers produce no sound

When the T-D (Theater-Dimensional), Stereo or Mono listening mode is selected, the surround speakers produce no sound. —

Depending on the source and current listening mode, not much sound may be produced by the surround speakers. Try selecting another listening mode. **31–32**

Make sure the speakers are configured correctly. **41**

■ The center speaker produces no sound

When the Stereo or Mono listening mode is selected, the center speaker produces no sound. **33**

Make sure the speakers are configured correctly. **41**

■ The surround back speakers produce no sound

Depending on the current listening mode, no sound may be produced by the surround back speakers. Select another listening mode. **31**

Not much sound may be produced by the surround back speakers with some sources. —

Make sure the speakers are configured correctly. **41**

■ The subwoofer produces no sound

When you play source material that contains no information in the LFE channel, the subwoofer produces no sound. —

Make sure the speakers are configured correctly. **41**

■ There's no sound with a certain signal format

Check the digital audio output setting on the connected device. On some game consoles, such as those that support DVD, the default setting is off. —

With some DVD-Video discs, you need to select an audio output format from a menu. —

Depending on the input signal, some listening modes cannot be selected. **31–32**

■ Can't select the Pure Audio listening mode

(European, Australian and Asian models) The Pure Audio listening mode cannot be selected while Zone 2 is on. —

■ Can't get 6.1/7.1 playback

If no surround back speakers are connected, 6.1/7.1 playback is not possible. —

You can not always select all of the listening modes, depending on the number of the speakers connected. **31–32**

■ The speaker volume cannot be set as required

Check to see if a maximum volume has been set. **20**

If the volume level of each individual speaker has been adjusted to high positive values, then the maximum master volume possible may be reduced. Note that the individual speaker volume levels are set automatically after the Audyssey 2EQ® Room Correction and Speaker Setup has been completed. **28, 42**

■ Noise can be heard

Using cable ties to bundle audio cables with power cords, speaker cables, and so on may degrade the audio performance, so don't do it. —

An audio cable may be picking up interference. Try repositioning your cables. —

■ The Late Night function doesn't work

Make sure the source material is Dolby Digital, Dolby Digital Plus, and Dolby TrueHD. **51**

■ About DTS signals

When DTS program material ends and the DTS bitstream stops, the AV receiver remains in DTS listening mode and the DTS indicator remains on. This is to prevent noise when you use the pause, fast forward, or fast reverse function on your player. If you switch your player from DTS to PCM, because the AV receiver does not switch formats immediately, you may not hear any sound, in which case you should stop your player for about three seconds, and then resume playback. —

With some CD and LD players, you won't be able to playback DTS material properly even though your player is connected to a digital input on the AV receiver. This is usually because the DTS bitstream has been processed (e.g., output level, sampling rate, or frequency response changed) and the AV receiver doesn't recognize it as a genuine DTS signal. In such cases, you may hear noise. —

Playing DTS program material, using the pause, fast forward, or fast reverse function on your player may produce a short audible noise. This is not a malfunction. —

■ The beginning of audio received by an HDMI IN can't be heard

Since it takes longer to identify the format of an HDMI signal than it does for other digital audio signals, audio output may not start immediately. —

Video

■ There's no picture

Make sure that all video connecting plugs are pushed in all the way. **14**

Make sure that each video component is properly connected. **15, 16, 17**

If the video source is connected to a component video input, you must assign that input to an input selector, and your TV must be connected to **COMPONENT VIDEO OUT**. **16, 40**

If the video source is connected to a composite video input, your TV must be connected to the corresponding composite video output. **16**

If the video source is connected to an HDMI input, you must assign that input to an input selector, and your TV must be connected to the **HDMI OUT**. **15, 40**

(European, Australian and Asian models) While the Pure Audio listening mode is selected, the video circuitry is turned off and only video signals input through **HDMI IN** can be output. **31**

On your TV, make sure that the video input to which the AV receiver is connected is selected. —

■ There's no picture from a source connected to an HDMI IN

Reliable operation with an HDMI-to-DVI adapter is not guaranteed. In addition, video signals from a PC are not guaranteed. **72**

■ The on-screen menus don't appear

On your TV, make sure that the video input to which the AV receiver is connected is selected. —

When the AV receiver is not connected to a TV via HDMI, onscreen menus are not displayed. —

Tuner

■ Reception is noisy, FM stereo reception is noisy, or the FM STEREO indicator doesn't light

Relocate your antenna. —

Move the AV receiver away from your TV or computer. —

Listen to the station in mono. **26**

When listening to an AM station, operating the remote controller may cause noise. —

Passing cars and airplanes can cause interference. —

Concrete walls weaken radio signals. —

If nothing improves the reception, install an outdoor antenna. —

Remote Controller

■ The remote controller doesn't work

Before operating this unit, be sure to press **RECEIVER**. —

Make sure that the batteries are installed with the correct polarity. **4**

Install new batteries. Don't mix different types of batteries, or old and new batteries. **4**

Make sure that the remote controller is not too far away from the AV receiver, and that there's no obstruction between the remote controller and the AV receiver's remote control sensor. **4**

Make sure that the AV receiver is not subjected to direct sunshine or inverter-type fluorescent lights. Relocate if necessary. —

If the AV receiver is installed in a rack or cabinet with colored-glass doors, the remote controller may not work reliably when the doors are closed. —

Make sure you've selected the correct remote controller mode. **10, 57**

When using the remote controller to control other manufacturers' AV components, some buttons may not work as expected. —

Make sure you've entered the correct remote control code. **56**

Make sure to set the same ID on both the AV receiver and remote controller. **46**

■ Can't control other components

If it's an Onkyo component, make sure that the **RI** cable and analog audio cable are connected properly. Connecting only an **RI** cable won't work. **17**

Make sure you've selected the correct remote controller mode. **10, 57**

If you've connected a cassette tape deck to the **TV/CD IN** jack, or an RI Dock to the **TV/CD IN** or **GAME IN** or **VCR/DVR IN** jacks, for the remote controller to work properly, you must set the input display appropriately. **37**

If you cannot operate it, you will need to enter the appropriate remote control code. **56**

To control another manufacturer's component, point the remote controller at that component. **56**

To control an Onkyo component that's connected via **RI**, point the remote controller at the AV receiver. Be sure to enter the appropriate remote control code first. **56**

To control an Onkyo component that's not connected via **RI**, point the remote controller at the component. Be sure to enter the appropriate remote control code first. **56**

The entered remote control code may not be correct. If more than one code is listed, try each one. —

UP-A1 Dock for iPod/iPhone

■ There's no sound

Make sure your iPod/iPhone is actually playing. —

Make sure your iPod/iPhone is inserted properly in the Dock. —

Make sure the UP-A1 Dock is connected to the **UNIVERSAL PORT** jack on the AV receiver. —

Make sure the AV receiver is turned on, the correct input source is selected, and the volume is turned up. —

Make sure the plugs are pushed in all the way. —

Try resetting your iPod/iPhone. —

■ There's no video

Make sure that your iPod/iPhone models TV OUT setting is set to On. —

Make sure the correct input is selected on your TV or the AV receiver. —

Some versions of the iPod/iPhone do not output video. —

■ The AV receiver's remote controller doesn't control your iPod/iPhone

Make sure your iPod/iPhone is properly inserted in the Dock. If your iPod/iPhone is in a case, it may not connect properly to the Dock. Always remove your iPod/iPhone from the case before inserting it into the Dock. —

The iPod/iPhone cannot be operated while it's displaying the Apple logo. —

Make sure you've selected the right remote mode. —

When you use the AV receiver's remote controller, point it toward your AV receiver. —

When connecting UP-A1 Dock to the radio tuner UP-HT1 (North American models)/UP-DT1 (European, Australian and Asian models) with AUTO selected by the tuner's Mode Selector switch, you can switch the input source between UP-A1 Dock and the tuner, by pressing **PORT** repeatedly on the front panel. —

If you still can't control your iPod/iPhone, start playback by pressing your iPod/iPhone model's Play button. Remote operation should then be possible. —

Try resetting your iPod/iPhone. —

Depending on your iPod/iPhone, some buttons may not work as expected. —

■ The AV receiver unexpectedly selects your iPod/iPhone as the input source

Always pause iPod/iPhone playback before selecting a different input source. If playback is not paused, the Direct Change function may select your iPod/iPhone as the input source by mistake during the transition between tracks. —

Recording

■ Can't record

On your recorder, make sure the correct input is selected. —

(European, Australian and Asian models) When the Pure Audio listening mode is selected, recording is not possible because no video signals are output. Select another listening mode. —

Zone 2

■ There's no sound

Only components connected to analog inputs can be played in Zone 2. —

Music Server and Internet Radio

■ Can't access the server or Internet radio

Check the network connection between the AV receiver and your router or switch. —

Make sure that your modem and router are properly connected, and make sure they are both turned on. —

Make sure the server is up and running and compatible with the AV receiver. **64**

Check the "Network Setup". **49**

■ Playback stops while listening to music files on the server

Make sure your server is compatible with the AV receiver. **64**

If you download or copy large files on your computer, playback may be interrupted. Try closing any unused programs, use a more powerful computer, or use a dedicated server. —

If the server is serving large music files to several networked devices simultaneously, the network may become overloaded and playback may be interrupted. Reduce the number of playback devices on the network, upgrade your network, or use a switch instead of a hub. —

■ Can't connect to the AV receiver from a Web browser

If you're using DHCP, your router may not always allocate the same IP address to the AV receiver, so if you find that you can't connect to a server or Internet radio station, recheck the AV receiver's IP address on "Network" screen. **49**

Check the "Network Setup". **49**

USB Device Playback

■ Can't access the music files on a USB device

Make sure the USB device is plugged in properly. —

The AV receiver supports USB devices that support the USB mass storage device class. However, playback may not be possible with some USB devices even if they conform to the USB mass storage device class. —

USB memory devices with security functions cannot be played. —

Others

■ Standby power consumption

In the following cases, the power consumption may reach up to a maximum of 37 W: **48, 49, 53**

1. You are using the Universal Port jack.
2. "Network Control" is set to "Enable" in the "Network Setup" setting.
3. "HDMI Ctrl (RIHD)" setting is set to "On". (Depending on the TV status, the AV receiver will enter Standby mode as usual.)

■ The sound changes when I connect my headphones

When a pair of headphones is connected, the listening mode is set to Stereo, unless it's already set to Stereo, Mono, Direct, or Pure Audio (European, Australian and Asian models). —

■ The display doesn't work

The display is turned off when the Pure Audio listening mode is selected. —

■ How do I change the language of a multiplex source

Use the "Input Ch (Mux)" setting in the "Audio Adjust" menu to select "Main" or "Sub". **43**

■ The RI functions don't work

To use RI, you must make an RI connection and an analog audio connection (RCA) between the component and AV receiver, even if they are connected digitally. **17**

■ The functions and Direct Change don't work for components connected via RI

These functions don't work when Zone 2 is turned on. **17**

■ **When performing “Automatic Speaker Setup”, the measurement fails showing the message “Ambient noise is too high.”**

This can be caused by any malfunction in your speaker unit. Check if the unit produces normal sounds.

■ **The following settings can be made for the composite video inputs**

You must use the buttons on the unit to make these settings.

On the AV receiver, press the input selector for the input source that you want to set and the **SETUP** button simultaneously. While holding down the input selector button, press **SETUP** until “**Video ATT:ON**” appears on the display. Then, release both buttons. To reactivate the setting, repeat the above process so that “**Video ATT:OFF**” appears on the display, and release the buttons.

• **Video Attenuation**

This setting can be made for the **BD/DVD, VCR/DVR, CBL/SAT, GAME, or AUX** input.

If you have a game console connected to the composite video input, and the picture isn't very clear, you can attenuate the gain.

Video ATT:OFF: (default).

Video ATT:ON: Gain is reduced by 2 dB.

■ **If the picture on your TV/monitor connected to HDMI OUT is unstable, try switching the DeepColor function off**

To turn off the DeepColor function, simultaneously press the **CBL/SAT** and **ON/STANDBY** buttons on the AV receiver. While holding down **CBL/SAT**, press **ON/STANDBY** until “**Off**” appears on the display. Then, release both buttons. To reactivate the DeepColor function, repeat the above process until “**On**” appears on the display and release the buttons.

The AV receiver contains a microcomputer for signal processing and control functions. In very rare situations, severe interference, noise from an external source, or static electricity may cause it to lockup. In the unlikely event that this happens, unplug the power cord from the wall outlet, wait at least five seconds, and then plug it back in.

Onkyo is not responsible for damages (such as CD rental fees) due to unsuccessful recordings caused by the unit's malfunction. Before you record important data, make sure that the material will be recorded correctly.

Before disconnecting the power cord from the wall outlet, set the AV receiver to Standby.

Network/USB Features

Connecting to the Network

The following diagram shows how you can connect the AV receiver to your home network. In this example, it's connected to a LAN port on a router, which has a 4-port 100Base-TX switch built-in.

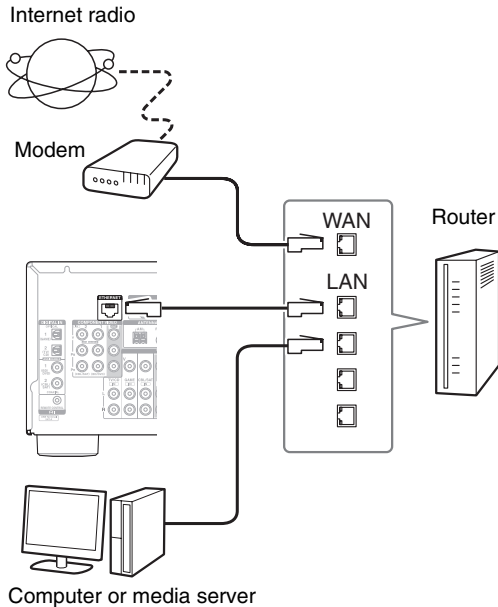

Network Requirements

■ Ethernet Network

For the best results, a 100Base-TX switched Ethernet network is recommended. Although it's possible to play music on a computer that's connected to the network wirelessly, playback may be unreliable, so it is recommended to use wired connections.

■ Ethernet Router

A router manages the network, data-routing and supplying of IP addresses. Your router must support the following:

- NAT (Network Address Translation). NAT allows several networked computers to access the Internet simultaneously via a single Internet connection. The AV receiver needs Internet access for Internet radio.
- DHCP (Dynamic Host Configuration Protocol). DHCP supplies IP addresses to the network devices, allowing them to configure themselves automatically.
- A router with a built-in 100Base-TX switch is recommended.

Some routers have a built-in modem, and some ISPs require you to use specific routers. Please consult your ISP or computer dealer if you're unsure.

■ CAT5 Ethernet cable

Use a shielded CAT5 Ethernet cable (straight-type) to connect the AV receiver to your home network.

■ Internet Access (for Internet radio)

To receive Internet radio, your Ethernet network must have Internet access. A narrowband Internet connection (e.g., 56K modem, ISDN) will not provide satisfactory results, so a broadband connection is strongly recommended (e.g., cable modem, xDSL modem, etc). Please consult your ISP or computer dealer if you're unsure.

Note

- To receive Internet radio with the AV receiver, your broadband Internet connection must be working and able to access the Web. Consult your ISP if you have any problems with your Internet connection.
- The AV receiver uses DHCP to configure its network settings automatically. If you want to configure these settings manually, see "Network Setup" (→ page 49).
- The AV receiver does not support PPPoE settings, so if you have a PPPoE-type Internet connection, you must use a PPPoE-compatible router.
- Depending on your ISP, you may need to specify a proxy server to use Internet radio. If your computer is configured to use a proxy server, use the same settings for the AV receiver (→ page 49).

Server Requirements

■ Server playback

The AV receiver can play digital music files stored on a computer or media server and supports the following technologies:

- Windows Media Player 11
- Windows Media Player 12
- Windows Media Connect 2.0
- DLNA-certified media server

If the operating system of your computer is Windows Vista, Windows Media Player 11 is already installed. Windows Media Player 11 for Windows XP can be downloaded for free from the Microsoft web site.

- The computer or media server must be on the same network as the AV receiver.
- Each folder may contain up to 20000 music files, and folders may be nested up to 16 levels deep.

Note

- Depending on the media server, the AV receiver may not recognize it, or may not be able to play its music files.

Minimum system requirements for Windows Media Player 11 on Windows XP

Operating system

Windows XP Home Edition (SP2), Windows XP Professional (SP2), Windows XP Tablet PC Edition (SP2), Update Rollup 2 for Windows XP Media Center Edition 2005 (KB900325), October 2006 Update Rollup for Windows XP Media Center Edition (KB925766)

Processor: 233 MHz Intel Pentium II, Advanced Micro Devices (AMD), etc.

Memory: 64 MB

Hard disk:	200 MB of free space
Drive:	CD or DVD drive
Modem:	28.8 kbps
Sound card:	16-bit sound card
Monitor:	Super VGA (800 x 600)
Video card:	64 MB VRAM, DirectX 9.0b
Software:	Microsoft ActiveSync (only when using a Windows Mobile-based Pocket PC or smartphone)
Web browser:	Microsoft Internet Explorer 6 or Netscape 7.1

■ Remote playback

- Windows Media Player 12
- DLNA-certified (within DLNA Interoperability Guidelines version 1.5) media server or controller device

Setting varies depending on the device. Refer to your device's instruction manual for details.

If the operating system of your personal computer is Windows 7, Windows Media Player 12 is already installed. For more information, see the Microsoft web site.

USB Device Requirements

- USB mass storage device class (but not always guaranteed).
- FAT16 or FAT32 file system format.
- If the storage device has been partitioned, each section will be treated as an independent device.
- Each folder may contain up to 20,000 music files and folders, and folders may be nested up to 16 levels deep.
- USB hubs and USB devices with hub functions are not supported.

Supported Audio File Formats

For server playback and playback from a USB device, the AV receiver supports the following music file formats. Not all servers support all formats.

Variable bit-rate (VBR) files are supported. However, playing times may not display correctly.

Note

- With remote playback, the AV receiver does not support the following music file formats: FLAC and Ogg Vorbis.
- In the case of server playback, the above-mentioned file formats may not be played depending on the server type.

■ MP3 (.mp3 or .MP3)

- MP3 files must be MPEG-1/MPEG-2 Audio Layer 3 format with a sampling rate of 8 kHz, 11.025 kHz, 12 kHz, 16 kHz, 22.05 kHz, 24 kHz, 32 kHz, 44.1 kHz, 48 kHz and bitrates of between 8 kbps and 320 kbps. Incompatible files cannot be played.

■ WMA (.wma or .WMA)

WMA stands for Windows Media Audio and is an audio compression technology developed by Microsoft Corporation. Audio can be encoded in WMA format by using Windows Media® Player.

- WMA files must have the copyright option turned off.

- Sampling rates of 8 kHz, 11.025 kHz, 12 kHz, 16 kHz, 22.05 kHz, 24 kHz, 32 kHz, 44.1 kHz, 48 kHz, bitrates of between 5 kbps and 320 kbps, and WMA DRM are supported.
- WMA Pro/Voice formats are not supported.

■ WMA Lossless (.wma or .WMA)

- Sampling rates of 44.1 kHz, 48 kHz, 88.2 kHz, 96 kHz are supported.
- Quantization bit: 16 bit, 24 bit

■ WAV (.wav or .WAV)

WAV files contain uncompressed PCM digital audio.

- Sampling rates of 8 kHz, 11.025 kHz, 12 kHz, 16 kHz, 22.05 kHz, 24 kHz, 32 kHz, 44.1 kHz, 48 kHz, 64 kHz, 88.2 kHz, and 96 kHz are supported.
- Quantization bit: 8 bit, 16 bit, 24 bit

■ AAC

(.aac/.m4a/.mp4/.3gp/.3g2/.AAC/.M4A/.MP4/.3GP or .3G2)

AAC stands for MPEG-2/MPEG-4 Audio.

- Sampling rates of 8 kHz, 11.025 kHz, 12 kHz, 16 kHz, 22.05 kHz, 24 kHz, 32 kHz, 44.1 kHz, 48 kHz, 64 kHz, 88.2 kHz, 96 kHz and bitrates of between 8 kbps and 320 kbps are supported.

■ FLAC (.flac or .FLAC)

FLAC is a file format for lossless audio data compression.

- Sampling rates of 8 kHz, 11.025 kHz, 12 kHz, 16 kHz, 22.05 kHz, 24 kHz, 32 kHz, 44.1 kHz, 48 kHz, 64 kHz, 88.2 kHz, and 96 kHz are supported.
- Quantization bit: 8 bit, 16 bit, 24 bit

■ Ogg Vorbis (.ogg or .OGG)

- Sampling rates of 8 kHz, 11.025 kHz, 12 kHz, 16 kHz, 22.05 kHz, 24 kHz, 32 kHz, 44.1 kHz, 48 kHz and bitrates of between 48 kbps and 500 kbps are supported. Incompatible files cannot be played.

■ LPCM (Linear PCM)

- Sampling rates of 8 kHz, 11.025 kHz, 12 kHz, 16 kHz, 22.05 kHz, 24 kHz, 32 kHz, 44.1 kHz, 48 kHz, 64 kHz, 88.2 kHz, and 96 kHz are supported.
- Quantization bit: 8 bit, 16 bit, 24 bit
- * Only for playback via network.

About DLNA

The Digital Living Network Alliance is an international, cross-industry collaboration. Members of DLNA develop a concept of wired and wireless interoperable networks where digital content such as photos, music, and videos can be shared through consumer electronics, personal computers, and mobile devices in and beyond the home. The AV receiver complies with the DLNA Interoperability Guidelines version 1.5.

Firmware Update

To update the firmware of the AV receiver, you can choose from the following two methods: update via network, or update via USB storage. Choose the one that best suits your environment. Before proceeding with the update, please read the corresponding explanations carefully.

■ Update via network

You need a wired Internet connection to update the firmware.

■ Update via USB storage (→ page 68)

Please prepare a USB storage device such as a USB flash memory stick. You need at least 32 MB of available space to update the firmware.

Note

- Check the network connection before updating.
- Do not touch the any cable or device connected to the AV receiver during the updating process.
- Do not attempt to access the AV receiver from your PC while it is being updated.
- Do not shutdown the power of the AV receiver while it is being updated.
- The storage media in the USB card reader may not work.
- If the USB device is partitioned, each section will be treated as an independent device.
- If the USB device contains a lot of data, the AV receiver may take a while to read it.
- Operation is not guaranteed for all USB devices, which includes the ability to power them.
- Onkyo takes no responsibility whatsoever for the loss or damage of data resulting from the use of a USB device with the AV receiver. Onkyo recommends that you back up your important music files beforehand.
- If you connect a USB hard disk drive to the USB port, Onkyo recommends that you use its AC adapter to power it.
- USB hubs and USB devices with hub functions are not supported. Do not connect your USB device via a USB hub.
- USB devices with security functions are not supported.

Limitation of liability

The program and accompanying online documentation are furnished to you for use at your own risk. Onkyo will not be liable and you will have no remedy for damages for any claim of any kind whatsoever concerning your use of the program or the accompanying online documentation, regardless of legal theory, and whether arising in tort or contract. In no event will Onkyo be liable to you or any third party for any special, indirect, incidental, or consequential damages of any kind, including, but not limited to, compensation, reimbursement or damages on account of the loss of present or prospective profits, loss of data, or for any other reason whatsoever.

See the Onkyo web site for latest information.

Updating the Firmware via Network

The AV receiver allows you to update the firmware using network connection on the rear panel.

Note

- Make sure your AV receiver and TV are turned on and an Ethernet cable is connected to the rear panel of the AV receiver.
- Never unplug or turn off the AV receiver while it is being updated.
- Never plug or unplug an HDMI or Ethernet cable during the update process.
- Do not attempt to access the AV receiver from your PC while it is being updated.
- Never unplug the power cord during the update process.
- It takes about 30 minutes to complete the firmware update.
- The AV receiver will retain all your settings after the update is finished.

Before you start

- Set the “**HDMI Ctrl (RIHD)**” setting to “**Off**” (→ page 48).
- Turn off the controller device connected via Ethernet cable.
- Turn off Zone 2.
- Stop playback of contents from Internet Radio, iPod/iPhone, USB or servers, etc.

Update procedure

1 Press RECEIVER followed by SETUP on the remote controller.

The Setup menu will be displayed on the TV screen. The procedures thereafter can also be performed on the AV receiver by using its **SETUP**, arrow and **ENTER** buttons.

2 Select “Update” and press ENTER.

Note that the “**Update**” option will be grayed out for about 50 seconds after the AV receiver is turned on. Please wait until it becomes operable.

3 Select “Via NET” and press ENTER.

4 Select “Update” and press ENTER.

The update process will begin.

During the update process, the on-screen display may disappear depending on the updated program. When this occurs, you can still view the update progress on the front display of the AV receiver. The on-screen display will reappear after the update is complete, and upon turning the AV receiver off and on again.

5 The message “Completed!” appears on the front display of the AV receiver, indicating that the update has been completed.

6 Using **ON/STANDBY** on the front panel, turn off and on the AV receiver.

Do not use **RECEIVER** on the remote controller. Congratulations! You now have the latest firmware installed on your Onkyo AV receiver.

Troubleshooting

Case 1:

If “**No Update**” is displayed on the front display of the AV receiver, it means that the firmware has already been updated. You do not need to do anything further.

Case 2:

If an error occurs, “**Error!! *-** No media**” is displayed on the front display of the AV receiver. (Alpha-numeric characters on the front display are denoted by asterisks.) Refer to the following table and take appropriate action.

■ Errors during an update via Network

Error Code	Description
*-10, *-20	The Ethernet cable was not detected. Reconnect the cable properly.
*-11, *-13, *-21, *-28	Internet connection error. Check the following items: <ul style="list-style-type: none">• Make sure the IP address, subnet mask, gateway address, and DNS server are configured properly.• Make sure the router is turned on.• Make sure the AV receiver and the router are connected with an Ethernet cable.• Make sure your router is configured properly. See the instruction manual of the router.• If your network allows only one client connection and there is any other device already connected, the AV receiver will not be able to access the network. Consult your Internet Service Provider (ISP).• If your modem does not function as a router, you will need a router. Depending on your network, you may need to configure the proxy server if necessary. See the document provided by your ISP. If you are still unable to access the Internet, the DNS or proxy server may be temporarily down. Contact your ISP.
Others	Retry the update procedure from the beginning. If the error persists, please contact Onkyo Support (→ page 69) and provide the error code.

Case 3:

If an error occurs during the update process, disconnect then reconnect the AC power cord and try again.

Case 4:

If an error occurs due to a wrong selection of input sources, turn off and on the AV receiver. Then retry the update.

Case 5:

If you do not have an Internet connection to the network, please contact Onkyo Support (→ **page 69**).

Updating the Firmware via USB

The AV receiver allows you to update the firmware using a USB device.

Note

- Never unplug or turn off the AV receiver during the update process.
- Never plug or unplug an HDMI cable or a USB device during the update process.
- Never unplug the USB storage device containing the firmware file or the AC power cord during the update process.
- Do not attempt to access the AV receiver from your PC while it is being updated.
- It takes about 30 minutes to complete the firmware update.
- The AV receiver will retain all your settings after the update is finished.

Before you start

- Set the “HDMI Ctrl (RIHD)” setting to “Off” (→ page 48).
- Turn off the controller device connected via Ethernet cable.
- Turn off Zone 2.
- Stop playback of contents from Internet Radio, iPod/iPhone, USB or servers, etc.
- If there is any data in the USB device, remove it first.

Update procedure

- 1** Connect a USB device to your PC. If there is any data in the USB device, remove it first.
- 2** Download the firmware file from the Onkyo web site. The file name is as follows:
ONKAVR****_*****.zip
Unzip the downloaded file. The following three files are created:
ONKAVR****_*****.of1
ONKAVR****_*****.of2
ONKAVR****_*****.of3
- 3** Copy the extracted files to the USB device. Be careful not to copy the zip file.
- 4** Remove the USB device from your PC and connect it to the USB port on the AV receiver.
- 5** Make sure the AV receiver and TV are turned on. If the AV receiver is in standby mode, press **ON/STANDBY** on the AV receiver to light the front display.
- 6** Select the USB input source. “Now Initializing” is displayed on the front display and then the name of the USB device is displayed. It takes 20 to 30 seconds to recognize the USB device.
- 7** Press **RECEIVER** followed by **SETUP** on the remote controller. Setup menu will be displayed on the TV screen. The procedures thereafter can also be performed on the AV receiver by using its **SETUP**, arrow and **ENTER** buttons.

8 Select “Update” and press **ENTER**.

9 Select “Via USB” and press **ENTER**.

10 Select “Update” and press **ENTER**.

The update process will begin.

During the update process, the on-screen display may disappear depending on the updated program. When this occurs, you can still view the update progress on the front display of the AV receiver. The on-screen display will reappear after the update is complete, and upon turning the AV receiver off and on again.

Do not turn off the AV receiver and do not remove the USB device during the update process.

11 The message “Completed!” appears on the front display of the AV receiver, indicating that the update has been completed.

12 Using **ON/STANDBY** on the front panel, turn off the AV receiver and then remove the USB device.

Do not use **RECEIVER** on the remote controller. Congratulations! You now have the latest firmware installed on your Onkyo AV receiver.

Troubleshooting

Case 1:

If “**No Update**” is displayed on the front display of the AV receiver, it means that the firmware has already been updated. You do not need to do anything further.

Case 2:

If an error occurs, “**Error!! *_** No media**” is displayed on the front display of the AV receiver. (Alpha-numeric characters on the front display are denoted by asterisks.) Refer to the following table and take appropriate action.

■ Errors during an update via USB

Error Code	Description
^-10, ^-20	The USB device was not detected. Make sure the USB flash memory or USB cable is properly connected to the USB port. If the USB storage device has its own power supply, use it to power the USB device.
^-14	The firmware file was not found in the root folder of the USB device, or the firmware file is for another model. Retry and download the file on the support page of the web site, following the on-site instructions. If the error persists, please contact Onkyo Support and provide the error code.
Others	Retry the update procedure from the beginning. If the error persists, please contact Onkyo Support and provide the error code.

Case 3:

If an error occurs during the update, disconnect then reconnect the AC power cord and try again.

Case 4:

If an error occurs due to a wrong selection of input sources, turn off and on the AV receiver. Then retry the update.

ONKYO CORPORATION

2-1, Nisshin-cho, Neyagawa-shi, OSAKA 572-8540, JAPAN

The Americas

ONKYO U.S.A. CORPORATION
18 Park Way, Upper Saddle River, N.J. 07458, U.S.A.
Tel: 800-229-1687, 201-785-2600
Fax: 201-785-2650
Hours: M-F 9am-8pm/Sat-Sun 10am-4pm ET
<<http://www.us.onkyo.com/>>

Europe

ONKYO EUROPE ELECTRONICS GmbH
Liegnitzerstrasse 6, 82194 Groebenzell, GERMANY
Tel: +49-8142-4401-0 Fax: +49-8142-4401-555
<<http://www.eu.onkyo.com/>>

China, Hong Kong

ONKYO CHINA LIMITED
Unit 1&12, 9/F, Ever Gain Plaza Tower 1, 88, Container Port Road,
Kwai Chung, N.T., Hong Kong
Tel: 852-2429-3118 Fax: 852-2428-9039
<<http://www.onkyochina.com/>>

Asia, Oceania, Middle East, Africa

Please contact an ONKYO distributor referring to Onkyo SUPPORT site.
<http://www.intl.onkyo.com/support/local_support/index.html>

Connection Tips and Video Signal Path

The AV receiver supports several connection formats for compatibility with a wide range of AV equipment. The format you choose will depend on the formats supported by your components. Use the following sections as a guide.

The on-screen setup menus appear only on a TV that is connected to the HDMI OUT. If your TV is connected to the MONITOR OUT V or the COMPONENT VIDEO OUT, use the AV receiver's display when changing settings.

Note

- The on-screen setup menus are displayed when:
 - There is no video input, or
 - The video input is 480p, 576p, 720p, 1080i, or 1080p.

Video Connection Formats

Video component can be connected by using any one of the following video connection formats: composite video, component video, or HDMI, the latter offering the best picture quality.

When choosing a connection format, bear in mind that the AV receiver doesn't convert between formats, so only outputs of the same format as the input will output the signal.

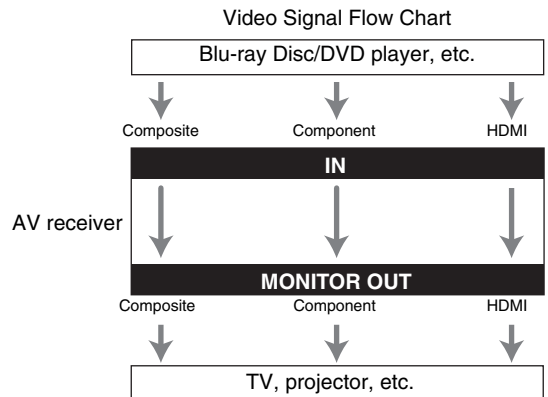

Audio Connection Formats

Audio component can be connected by using any of the following audio connection formats: analog, optical, coaxial, or HDMI.

When choosing a connection format, bear in mind that the AV receiver does not convert digital input signals for analog line outputs and vice versa. For example, audio signals connected to an optical or coaxial digital input are not output from the analog **VCR/DVR OUT**.

If signals are present at more than one input, the inputs will be selected automatically in the following order of priority: HDMI, digital, analog.

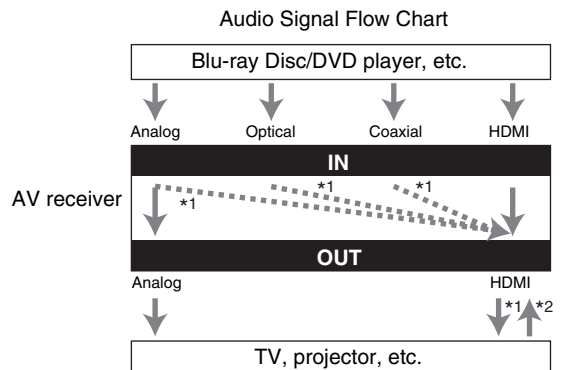

*1 Depends on the "Audio TV Out" setting (→ page 48).

*2 This is possible when "Audio Return Ch" is set to "Auto" (→ page 48), the TV/CD input selector is selected, and your TV is ARC capable.

About HDMI

Designed to meet the increased demands of digital TV, HDMI (High Definition Multimedia Interface) is a new digital interface standard for connecting TVs, projectors, Blu-ray Disc players/DVD players, set-top boxes, and other video components. Until now, several separate video and audio cables have been required to connect AV components. With HDMI, a single cable can carry control signals, digital video, and up to eight channels of digital audio (2-channel PCM, multichannel digital audio, and multichannel PCM).

The HDMI video stream (i.e., video signal) is compatible with DVI (Digital Visual Interface)*1, so TVs and displays with a DVI input can be connected by using an HDMI-to-DVI adapter cable. (This may not work with some TVs and displays, resulting in no picture.)

The AV receiver uses HDCP (High-bandwidth Digital Content Protection)*2, so only HDCP-compatible components can display the picture.

The AV receiver's HDMI interface is based on the following:

Audio Return Channel, 3D, x.v.Color, Deep Color, Lip Sync, DTS-HD Master Audio, DTS-HD High Resolution Audio, Dolby TrueHD, Dolby Digital Plus, DSD and Multichannel PCM

Supported Audio Formats

- 2-channel linear PCM (32–192 kHz, 16/20/24 bit)
- Multichannel linear PCM (up to 7.1 ch, 32–192 kHz, 16/20/24 bit)
- Bitstream (DSD, Dolby Digital, Dolby Digital Plus, Dolby TrueHD, DTS, DTS-HD High Resolution Audio, DTS-HD Master Audio)

Your Blu-ray Disc player/DVD player must also support HDMI output of the above audio formats.

About Copyright Protection

The AV receiver supports HDCP (High-bandwidth Digital Content Protection)*2, a copy-protection system for digital video signals. Other devices connected to the AV receiver via HDMI must also support HDCP.

*1 DVI (Digital Visual Interface): The digital display interface standard set by the DDWG*3 in 1999.

*2 HDCP (High-bandwidth Digital Content Protection): The video encryption technology developed by Intel for HDMI/DVI. It's designed to protect video content and requires a HDCP-compatible device to display the encrypted video.

*3 DDWG (Digital Display Working Group): Lead by Intel, Compaq, Fujitsu, Hewlett Packard, IBM, NEC, and Silicon Image, this open industry group's objective is to address the industry's requirements for a digital connectivity specification for high-performance PCs and digital displays.

Note

- The HDMI video stream is compatible with DVI (Digital Visual Interface), so TVs and displays with a DVI input can be connected by using an HDMI-to-DVI adapter cable. (Note that DVI connections only carry video, so you'll need to make a separate connection for audio.) However, reliable operation with such an adapter is not guaranteed. In addition, video signals from a PC are not supported.
- The HDMI audio signal (sampling rate, bit length, etc.) may be restricted by the connected source component. If the picture is poor or there's no sound from a component connected via HDMI, check its setup. Refer to the connected component's instruction manual for details.

Using an RIHD-compatible TV, Player, or Recorder

RIHD, which stands for Remote Interactive over HDMI, is the name of the system control function found on Onkyo components. The AV receiver can be used with CEC (Consumer Electronics Control), which allows system control over HDMI and is part of the HDMI standard. CEC provides interoperability between various components, however, operation with components other than **RIHD**-compatible components cannot be guaranteed.

About RIHD-compatible components

The following components are **RIHD**-compatible. (As of January 2011)

■ TV

- Toshiba REGZA-LINK compatible TV
- Sharp TV

■ Players/Recorders

- Onkyo and Integra **RIHD**-compatible players
- Toshiba REGZA-LINK compatible players and recorders (only when used together with Toshiba REGZA-LINK compatible TV)
- Sharp players and recorders (only when used together with Sharp TV)

* Models other than those mentioned above may have some interoperability if compatible with CEC, which is part of the HDMI Standard, but operation cannot be guaranteed.

Note

- For proper linked operations, do not connect more **RIHD**-compatible components than the quantities specified below, to the HDMI input terminal.
 - Blu-ray Disc/DVD players: up to three.
 - Blu-ray Disc/DVD recorders/Digital Video Recorders: up to three.
 - Cable/Satellite Set-top boxes: up to four.
- Do not connect the AV receiver to another AV receiver/AV amplifier via HDMI.
- Proper linked operations are not guaranteed when more **RIHD**-compatible components than the above-mentioned quantities are connected.

Operations that can be performed with RIHD connection

■ For RIHD-compatible TV

The following linked operation is possible by connecting the AV receiver to an **RIHD**-compatible TV.

- The AV receiver will enter Standby mode when the power of the TV is turned to Standby.
- You can set on the menu screen of the TV to either output the audio from the speakers connected to the AV receiver, or from the speakers of the TV.
- It is possible to output the video/audio coming from the antenna or from the input jack of the TV from the speakers connected to the AV receiver. (A connection such as optical digital cable or similar is required in addition to the HDMI cable.)
- Input to the AV receiver can be selected with the remote controller of the TV.
- Operations such as volume adjustment or similar for the AV receiver can be performed from the remote controller of the TV.

■ For RIHD-compatible players/recorders

The following linked operation is possible by connecting the AV receiver to an **RIHD**-compatible player/recorder.

- When playback is started on the player/recorder, AV receiver will switch to the HDMI input of the player/recorder that is playing back.
- Operation of the player/recorder is possible via the remote controller supplied with the AV receiver.

* Not all functions may operate depending on the model.

■ How to connect and setup

1 Confirm the connection and settings.

1. Connect the **HDMI OUT** jack to the HDMI input jack of the TV.

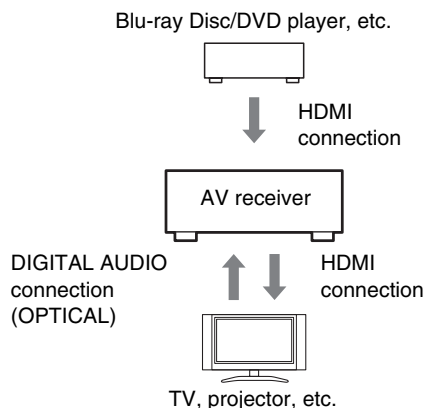

2. Connect the audio output from the TV to the **OPTICAL IN 2** jack of the AV receiver using an optical digital cable.

Note

- When the audio return channel (ARC) function is used with an ARC capable TV, this connection is not necessary (→ [page 48](#)).
3. Connect the HDMI output of the Blu-ray Disc/DVD player/recorder to the **HDMI IN 1** jack of the AV receiver.

Note

- It is necessary to assign the HDMI input when connecting the Blu-ray Disc/DVD player/recorder to other jacks (→ [page 40](#)). Do not assign the components connected to the HDMI IN to the TV/CD input at this time. Appropriate CEC (Consumer Electronics Control) operation can not be guaranteed.

2 Change each item in the “HDMI Setup” menu according to the following settings:

- **HDMI Ctrl (RIHD): On**
- **Audio Return Ch (ARC): Auto**

See details of each setting (→ [page 48](#)).

3 Confirm the settings.

1. Turn on the power for all connected components.
2. Turn off the power of the TV, and confirm that the power of the connected components is turned off automatically with the link operation.
3. Turn on the power of the Blu-ray Disc/DVD player/recorder.
4. Start playback on the Blu-ray Disc/DVD player/recorder, and verify the following:
 - The AV receiver automatically turns on, and selects the input to which the Blu-ray Disc/DVD player/recorder is connected.
 - The TV automatically turns on, and selects the input to which the AV receiver is connected.
5. Following the operating instructions of the TV, select “Use the TV speakers” from the menu screen of the TV, and confirm that the audio is output from the speakers of the TV, and not from the speakers connected to the AV receiver.
6. Select “Use the speakers connected from the AV receiver” from the menu screen of the TV, and confirm that the audio is output from the speakers connected to the AV receiver, and not from the TV speakers.

Note

- Perform the above operations when you use the AV receiver for the first time, when the settings of each component are changed, when the main power of each component is turned off, when the power cable is disconnected from the power supply, or when there has been a power outage.

4 Operate with the remote controller.

For buttons that can be operated (→ [page 58](#)).

Note

- Audio from DVD-Audio or Super Audio CD may not output from the TV speakers. You will be able to output the audio from the TV speakers by setting the audio output of the DVD player to 2ch PCM. (It may not be possible depending on the player models.)
- Even if you set to output audio on the TV speakers, audio will be output from the speakers connected to the AV receiver when you adjust the volume or switch the input on the AV receiver. To output audio from the TV speakers, re-do the corresponding operations on the TV.
- In case of a **RIHD** connection with **RI** and **RI** audio control compatible components, do not connect the RI cable at the same time.
- On the TV, when you select anything other than the HDMI jack to which the AV receiver is connected, the input on the AV receiver will be switched to “**TV/CD**”.
- The AV receiver will automatically power on in conjunction when it determines it to be necessary. Even if the AV receiver is connected to an **RIHD** compatible TV or player/recorder, it will not power on if it is not necessary. It may not power on in conjunction when the TV is set to output audio from the TV.
- Linked functions with the AV receiver may not work depending on the component model connected. Operate the AV receiver directly in such cases.

Specifications

Amplifier Section

Rated Output Power
All channels: (North American)
80 watts minimum continuous power per channel, 8 ohm loads, 2 channels driven from 20 Hz to 20 kHz, with a maximum total harmonic distortion of 0.7% (FTC)
110 watts minimum continuous power per channel, 6 ohm loads, 2 channels driven at 1 kHz, with a maximum total harmonic distortion of 0.9% (FTC)

(Others)
1 ch × 130 W at 6 ohms, 1 kHz, 1 ch driven of 1% (IEC)

Maximum Effective Output Power

(Asian)
1 ch × 160 W at 6 ohms, 1 kHz, 1 ch driven (JEITA)

Dynamic Power*

* IEC60268-Short-term maximum output power

180 W (3 Ω, Front)
160 W (4 Ω, Front)
100 W (8 Ω, Front)

THD+N (Total Harmonic Distortion+Noise)

0.08% (20 Hz - 20 kHz, half power)

Damping Factor 60 (Front, 1 kHz, 8 Ω)

Input Sensitivity and Impedance (Unbalance)

200 mV/47 kΩ (LINE)

Rated RCA Output Level and Impedance

200 mV/2.2 kΩ (REC OUT)

Maximum RCA Output Level and Impedance

2 V/2.2 kΩ (REC OUT)

Frequency Response 20 Hz - 50 kHz/+1 dB, -3 dB (DSP bypass)

Tone Control Characteristics

±10 dB, 50 Hz (BASS)
±10 dB, 20 kHz (TREBLE)

Signal to Noise Ratio 100 dB (LINE, IHF-A)

Speaker Impedance 6 Ω - 16 Ω

Video Section

Input Sensitivity/Output Level and Impedance

1 V_{p-p}/75 Ω (Component Y)
0.7 V_{p-p}/75 Ω (Component Pb/Cb, Pr/Cr)
1 V_{p-p}/75 Ω (Composite)

Component Video Frequency Response

5 Hz - 100 MHz/+0 dB, -3 dB

Tuner Section

FM Tuning Frequency Range

(North American) 87.5 MHz - 107.9 MHz
(Taiwan) 87.5 MHz - 108.0 MHz
(Others) 87.5 MHz - 108.0 MHz, RDS

AM Tuning Frequency Range

522/530 kHz - 1611/1710 kHz

Preset Channel 40

General

Power Supply (North American and Taiwan)
AC 120 V, 60 Hz

(European and Australian)

AC 230 V, 50 Hz

(Others) AC 220 - 240 V, 50/60 Hz

Power Consumption (North American and Taiwan) 3.9 A
(European and Australian) 370 W
(Others) 410 W

Stand-by Power Consumption

(North American and Taiwan) 0.2 W

(Others) 0.3 W

Dimensions

(W × H × D) 435 mm × 173.5 mm × 328 mm

17-1/8" × 6-13/16" × 12-15/16"

Weight

(North American and Taiwan)

8.5 kg (18.7 lbs.)

(European and Australian)

9.2 kg (20.3 lbs.)

(Others)

9.3 kg (20.5 lbs.)

■ HDMI

Input IN 1, IN 2, IN 3, IN 4

Output OUT

Video Resolution 1080p

Audio Format Dolby True HD, DTS Master Audio, DVD-Audio, DSD

Supported 3D, Audio Return Channel, DeepColor, x.v.Color, LipSync, CEC (RIHD)

■ Video Inputs

Component IN 1, IN 2

Composite BD/DVD, VCR/DVR, CBL/SAT, GAME, AUX

■ Video Outputs

Component OUT

Composite MONITOR OUT, VCR/DVR OUT

■ Audio Inputs

Digital Optical: 2

Coaxial: 2

Analog BD/DVD, VCR/DVR, CBL/SAT, GAME, TV/CD, AUX

■ Audio Outputs

Analog VCR/DVR, ZONE2 LINE OUT

Pre Outputs SBL, SBR

Subwoofer Pre Output 1

Speaker Outputs Main (L, R, C, SL, SR)

Phones 1 (6.3 φ)

■ Others

Setup Mic 1

Universal Port 1

RI 1

USB 1 (Front)

Ethernet 1

Specifications and features are subject to change without notice.

Memo

ONKYO®

ONKYO SOUND & VISION CORPORATION

2-1, Nisshin-cho, Neyagawa-shi, OSAKA 572-8540, JAPAN
Tel: 072-831-8023 Fax: 072-831-8163

ONKYO U.S.A. CORPORATION

18 Park Way, Upper Saddle River, N.J. 07458, U.S.A.
Tel: 800-229-1687, 201-785-2600 Fax: 201-785-2650
<http://www.us.onkyo.com/>

ONKYO EUROPE ELECTRONICS GmbH

Liegnitzerstrasse 6, 82194 Groebenzell, GERMANY
Tel: +49-8142-4401-0 Fax: +49-8142-4401-555
<http://www.eu.onkyo.com/>

ONKYO EUROPE ELECTRONICS GmbH (UK BRANCH)

The Coach House 81A High Street, Marlow, Buckinghamshire, SL7 1AB, UK
Tel: +44-(0)1628-473-350 Fax: +44-(0)1628-401-700

ONKYO CHINA LIMITED

Unit 1 & 12, 9/F, Ever Gain Plaza Tower 1, 88, Container Port Road, Kwai Chung,
N.T., Hong Kong. Tel: 852-2429-3118 Fax: 852-2428-9039
<http://www.ch.onkyo.com/>

SN 29400571

(C) Copyright 2010 ONKYO SOUND & VISION CORPORATION Japan. All rights reserved.

Y1012-1



* 2 9 4 0 0 5 7 1 *