

ONKYO

Integrated Amplifier

A-9050/ A-9030

Instruction Manual

Thank you for purchasing an Onkyo Integrated Amplifier. Please read this manual thoroughly before making connections and plugging in the unit. Following the instructions in this manual will enable you to obtain optimum performance and listening enjoyment from your new Integrated Amplifier. Please retain this manual for future reference.

Contents

Introduction2

Connections.....12

Turning On & Basic Operations..... 21

Advanced Operations25

Others.....26

WARNING:

TO REDUCE THE RISK OF FIRE OR ELECTRIC SHOCK, DO NOT EXPOSE THIS APPARATUS TO RAIN OR MOISTURE.

CAUTION:

TO REDUCE THE RISK OF ELECTRIC SHOCK, DO NOT REMOVE COVER (OR BACK). NO USER-SERVICEABLE PARTS INSIDE. REFER SERVICING TO QUALIFIED SERVICE PERSONNEL.



WARNING
RISK OF ELECTRIC SHOCK
DO NOT OPEN

AVIS
RISQUE DE CHOC ELECTRIQUE
NE PAS OUVRIR



The lightning flash with arrowhead symbol, within an equilateral triangle, is intended to alert the user to the presence of uninsulated "dangerous voltage" within the product's enclosure that may be of sufficient magnitude to constitute a risk of electric shock to persons.



The exclamation point within an equilateral triangle is intended to alert the user to the presence of important operating and maintenance (servicing) instructions in the literature accompanying the appliance.

Important Safety Instructions

1. Read these instructions.
2. Keep these instructions.
3. Heed all warnings.
4. Follow all instructions.
5. Do not use this apparatus near water.
6. Clean only with dry cloth.
7. Do not block any ventilation openings. Install in accordance with the manufacturer's instructions.
8. Do not install near any heat sources such as radiators, heat registers, stoves, or other apparatus (including amplifiers) that produce heat.
9. Do not defeat the safety purpose of the polarized or grounding-type plug. A polarized plug has two blades with one wider than the other. A grounding type plug has two blades and a third grounding prong. The wide blade or the third prong are provided for your safety. If the provided plug does not fit into your outlet, consult an electrician for replacement of the obsolete outlet.
10. Protect the power cord from being walked on or pinched particularly at plugs, convenience receptacles, and the point where they exit from the apparatus.
11. Only use attachments/accessories specified by the manufacturer.
12. Use only with the cart, stand, tripod, bracket, or table specified by the manufacturer, or sold with the apparatus. When a cart is used, use caution when moving the cart/apparatus combination to avoid injury from tip-over.

PORTABLE CART WARNING
S3125A
13. Unplug this apparatus during lightning storms or when unused for long periods of time.
14. Refer all servicing to qualified service personnel. Servicing is required when the apparatus has been damaged in any way, such as power-supply cord or plug is damaged, liquid has been spilled or objects have fallen into the apparatus, the apparatus has been exposed to rain or moisture, does not operate normally, or has been dropped.
15. Damage Requiring Service
Unplug the apparatus from the wall outlet and refer servicing to qualified service personnel under the following conditions:
 - A. When the power-supply cord or plug is damaged,
 - B. If liquid has been spilled, or objects have fallen into the apparatus,
 - C. If the apparatus has been exposed to rain or water,
 - D. If the apparatus does not operate normally by following the operating instructions. Adjust only those controls that are covered by the operating instructions as an improper adjustment of other controls may result in damage and will often require extensive work by a qualified technician to restore the apparatus to its normal operation,
 - E. If the apparatus has been dropped or damaged in any way, and
 - F. When the apparatus exhibits a distinct change in performance this indicates a need for service.
16. Object and Liquid Entry
Never push objects of any kind into the apparatus through openings as they may touch dangerous voltage points or short-out parts that could result in a fire or electric shock.
The apparatus shall not be exposed to dripping or splashing and no objects filled with liquids, such as vases shall be placed on the apparatus.
Don't put candles or other burning objects on top of this unit.
17. Batteries
Always consider the environmental issues and follow local regulations when disposing of batteries.
18. If you install the apparatus in a built-in installation, such as a bookcase or rack, ensure that there is adequate ventilation.
(Leave 20 cm (8") of free space at the top and sides and 10 cm (4") at the rear. When a shelf is located above the unit, the rear edge of the shelf shall be set 10 cm (4") away from the backboard to improve ventilation.)

Precautions

1. **Recording Copyright**—Unless it's for personal use only, recording copyrighted material is illegal without the permission of the copyright holder.
2. **AC Fuse**—The AC fuse inside the unit is not user-serviceable. If you cannot turn on the unit, contact your Onkyo dealer.
3. **Care**—Occasionally you should dust the unit all over with a soft cloth. For stubborn stains, use a soft cloth dampened with a weak solution of mild detergent and water. Dry the unit immediately afterwards with a clean cloth. Don't use abrasive cloths, thinners, alcohol, or other chemical solvents, because they may damage the finish or remove the panel lettering.

4. Power

WARNING

BEFORE PLUGGING IN THE UNIT FOR THE FIRST TIME, READ THE FOLLOWING SECTION CAREFULLY.

AC outlet voltages vary from country to country. Make sure that the voltage in your area meets the voltage requirements printed on the unit's rear panel (e.g., AC 230 V, 50 Hz or AC 120 V, 60 Hz).

The power cord plug is used to disconnect this unit from the AC power source. Make sure that the plug is readily operable (easily accessible) at all times.

For models with [POWER] button, or with both [POWER] and [ON/STANDBY] buttons:

Pressing the [POWER] button to select OFF mode does not fully disconnect from the mains. If you do not intend to use the unit for an extended period, remove the power cord from the AC outlet.

For models with [ON/STANDBY] button only: Pressing the [ON/STANDBY] button to select Standby mode does not fully disconnect from the mains. If you do not intend to use the unit for an extended period, remove the power cord from the AC outlet.

5. Preventing Hearing Loss

Caution

Excessive sound pressure from earphones and headphones can cause hearing loss.

6. Batteries and Heat Exposure

Warning

Batteries (battery pack or batteries installed) shall not be exposed to excessive heat as sunshine, fire or the like.

7. Never Touch this Unit with Wet Hands

—Never handle this unit or its power cord while your hands are wet or damp. If water or any other liquid gets inside this unit, have it checked by your Onkyo dealer.

8. Handling Notes

- If you need to transport this unit, use the original packaging to pack it how it was when you originally bought it.
- Do not leave rubber or plastic items on this unit for a long time, because they may leave marks on the case.

- This unit's top and rear panels may get warm after prolonged use. This is normal.
- If you do not use this unit for a long time, it may not work properly the next time you turn it on, so be sure to use it occasionally.

For U.S. models

FCC Information for User

CAUTION:

The user changes or modifications not expressly approved by the party responsible for compliance could void the user's authority to operate the equipment.

NOTE:

This equipment has been tested and found to comply with the limits for a Class B digital device, pursuant to Part 15 of the FCC Rules. These limits are designed to provide reasonable protection against harmful interference in a residential installation.

This equipment generates, uses and can radiate radio frequency energy and, if not installed and used in accordance with the instructions, may cause harmful interference to radio communications. However, there is no guarantee that interference will not occur in a particular installation. If this equipment does cause harmful interference to radio or television reception, which can be determined by turning the equipment off and on, the user is encouraged to try to correct the interference by one or more of the following measures:

- Reorient or relocate the receiving antenna.
- Increase the separation between the equipment and receiver.
- Connect the equipment into an outlet on a circuit different from that to which the receiver is connected.
- Consult the dealer or an experienced radio/TV technician for help.

For Canadian Models

NOTE: THIS CLASS B DIGITAL APPARATUS COMPLIES WITH CANADIAN ICES-003.

For models having a power cord with a polarized plug:

CAUTION: TO PREVENT ELECTRIC SHOCK, MATCH WIDE BLADE OF PLUG TO WIDE SLOT, FULLY INSERT.

Modèle pour les Canadien

REMARQUE: CET APPAREIL NUMÉRIQUE DE LA CLASSE B EST CONFORME À LA NORME NMB-003 DU CANADA.

Sur les modèles dont la fiche est polarisée:

ATTENTION: POUR ÉVITER LES CHOCS ÉLECTRIQUES, INTRODUIRE LA LAME LA PLUS LARGE DE LA FICHE DANS LA BORNE CORRESPONDANTE DE LA PRISE ET POUSSER JUSQU'AU FOND.

For British models

Replacement and mounting of an AC plug on the power supply cord of this unit should be performed only by qualified service personnel.

IMPORTANT

The wires in the mains lead are coloured in accordance with the following code:

Blue: Neutral

Brown: Live

As the colours of the wires in the mains lead of this apparatus may not correspond with the coloured markings identifying the terminals in your plug, proceed as follows:

The wire which is coloured blue must be connected to the terminal which is marked with the letter N or coloured black.

The wire which is coloured brown must be connected to the terminal which is marked with the letter L or coloured red.

IMPORTANT

The plug is fitted with an appropriate fuse. If the fuse needs to be replaced, the replacement fuse must be approved by ASTA or BSI to BS1362 and have the same ampere rating as that indicated on the plug. Check for the ASTA mark or the BSI mark on the body of the fuse.

If the power cord's plug is not suitable for your socket outlets, cut it off and fit a suitable plug. Fit a suitable fuse in the plug.

For European Models

Declaration of Conformity

We, ONKYO EUROPE
ELECTRONICS GmbH
LIEGNITZERSTRASSE 6,
82194 GROEBENZELL,
GERMANY



declare in own responsibility, that the ONKYO product described in this instruction manual is in compliance with the corresponding technical standards such as EN60065, EN55013, EN55020 and EN61000-3-2, -3-3.

GROEBENZELL, GERMANY

K. MIYAGI

ONKYO EUROPE ELECTRONICS GmbH

Supplied Accessories

Make sure you have the following accessories:

Remote controller and two batteries

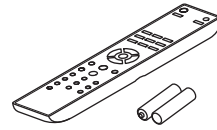

Remote controller (RC-830S) (1)

Batteries (R03/AAA) (2)

(Note for China: The battery for the remote controller is not supplied for this unit.)

Power cord (A-9050 only)

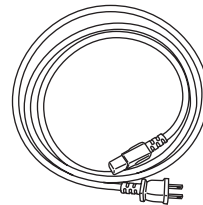

Power cord (5.9 ft/1.8 m) (1)

(Plug type varies from country to country.)

* In catalogs and on packaging, the letter at the end of the product name indicates the color. Specifications and operations are the same regardless of color.

Features

A-9050 Integrated Digital Amplifier

- Three-stage Inverted Darlington Circuitry
- Digital Inputs (Optical/Coaxial)
- Wolfson 192 kHz/24 bit DACs with DIDRC Circuitry Inside (WM8718)
- Phase Matching Bass Technology
- 1.6 mm Full Flat Chassis
- 75 W/ch (1 kHz, 8 ohms, 0.08 % THD, 2ch Driven FTC)
- WRAT (Wide Range Amplifier Technology)
- DIDRC (Dynamic Intermodulation Distortion Reduction Circuitry)
- High Current Low Impedance Drive
- 10,000 μ F Capacitor \times 2
- Optimum Gain Volume
- Aluminum Front Panels and Volume Knob
- Direct Mode Switch

A-9030 Integrated Digital Amplifier

- Three-stage Inverted Darlington Circuitry
- Phase Matching Bass Technology
- 1.6 mm Full Flat Chassis
- 65 W/ch (1 kHz, 4 ohms, 0.08 % THD, 2ch Driven IEC)
- WRAT (Wide Range Amplifier Technology)
- High Current Low Impedance Drive
- 8,200 μ F Capacitor \times 2
- Optimum Gain Volume
- Direct Mode Switch

Contents

Introduction

Important Safety Instructions	2
Precautions	3
Supplied Accessories	4
Features	5
Before Using the Integrated Amplifier	7
Installing the Batteries	7
Using the Remote Controller	7
Installing the Integrated Amplifier	7
Getting to Know the Integrated Amplifier	8
Front Panel	8
Rear Panel	9
Remote Controller	10

Connections

Connections	12
Connecting Your Speakers	12
Cable and Jacks	14
Connecting the Power Cord	14
Connecting a CD Player	15
Connecting a Tuner	16
Connecting an Onkyo Dock	17
Connecting Onkyo RI Components	18
Connecting a Turntable	19
Connecting a Cassette Tape Deck	19
Connecting a Recording Component	19
Connecting a Subwoofer With	
Built-In Power Amplifier	20
Using the Integrated Amplifier as a Preamplifier	20

Turning On & Basic Operations

Basic Operations	21
Turning On/Off the Integrated Amplifier	21
Selecting Speakers A and Speakers B	22
Adjusting the Volume	22
Selecting the Input Source	23
Using the Direct Function	23
Using the PHASE MACHING BASS Function	23
Adjusting the Bass, Treble and Balance	24
Muting the Sound	24
Using Headphones	24

Advanced Operations

Custom Setup	25
Setting the Auto Standby Function	25
Setting the speaker impedance	25

Others

Troubleshooting	26
Specifications	28

Before Using the Integrated Amplifier

Installing the Batteries

- 1 To open the battery compartment, press the small hollow and slide the cover.

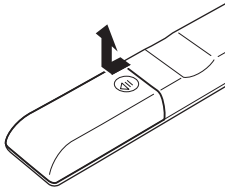

- 2 Insert the two supplied batteries (R03/AAA) in accordance with the polarity diagram inside the battery compartment.

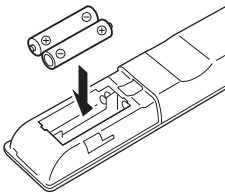

- 3 Replace the cover and slide it shut.

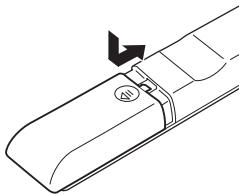

Note

- If the remote controller doesn't work reliably, try replacing the batteries.
- Don't mix new and old batteries or different types of batteries.
- If you intend not to use the remote controller for a long time, remove the batteries to prevent damage from leakage or corrosion.
- Remove expired batteries as soon as possible to prevent damage from leakage or corrosion.

Using the Remote Controller

To use the remote controller, point it at the integrated amplifier's remote control sensor, as shown below.

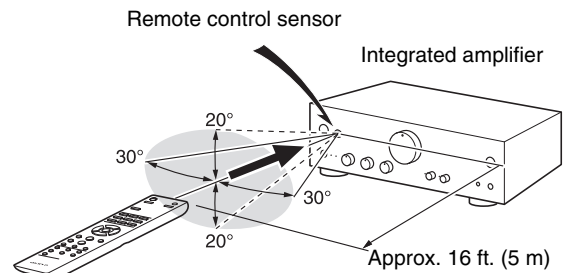

Note

- The remote controller may not work reliably if the integrated amplifier is subjected to bright light, such as direct sunlight or inverter-type fluorescent lights. Keep this in mind when installing.
- If another remote controller of the same type is used in the same room, or the integrated amplifier is installed close to equipment that uses infrared rays, the remote controller may not work reliably.
- Don't put anything, such as a book, on the remote controller, because the buttons may be pressed inadvertently, thereby draining the batteries.
- The remote controller may not work reliably if the integrated amplifier is installed in a rack behind colored glass doors. Keep this in mind when installing.
- The remote controller will not work if there's an obstacle between it and the integrated amplifier's remote control sensor.

Installing the Integrated Amplifier

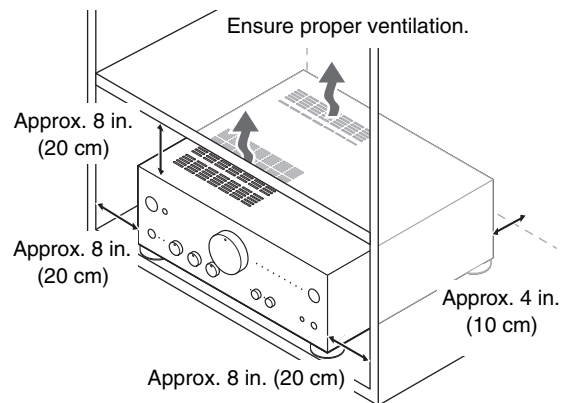

Install the integrated amplifier on a sturdy rack or shelf. Position it so that its weight is evenly dispersed on its four legs. Do not install the integrated amplifier in a place with vibration or an unstable location.

The integrated amplifier is designed to have high conversion efficiency, however, its temperature will become much higher than other audio equipment. Therefore, make sure not to hamper heat dissipation by ensuring proper ventilation.

Getting to Know the Integrated Amplifier

Front Panel

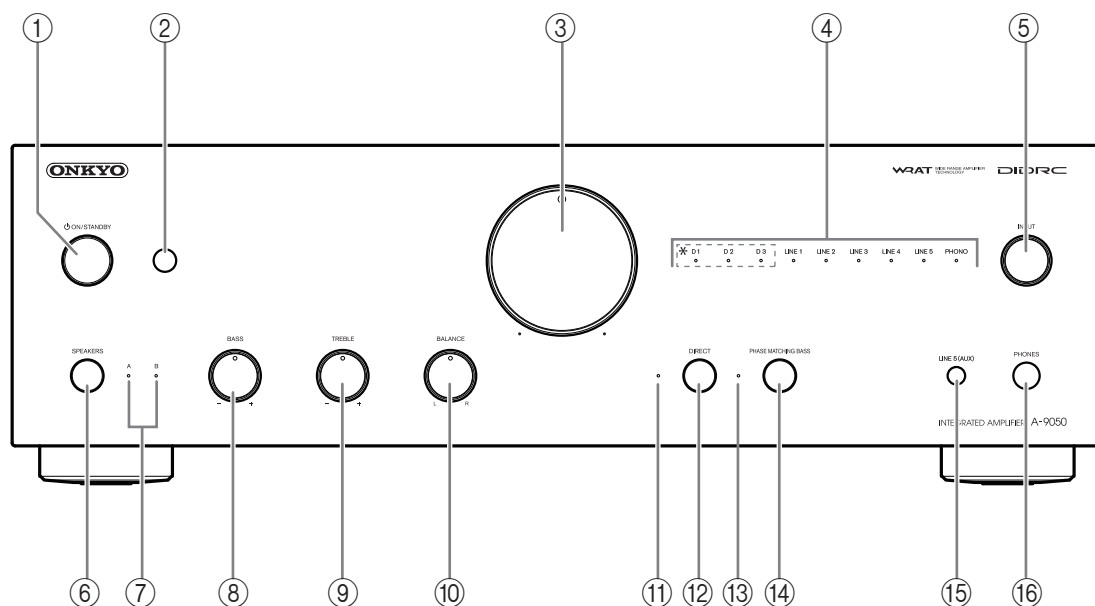

For detailed information, see the pages in parentheses.

- ① **ON/STANDBY button** (→ page 21)
Sets the integrated amplifier to On or Standby.
- ② **Remote control sensor** (→ page 7)
Receives control signals from the remote controller.
- ③ **Volume controller** (→ page 22)
Adjusts the volume.
- ④ **Input source LEDs** (→ page 23)
Lights according to the selected input source.
(*A-9050 only)
- ⑤ **INPUT selector** (→ page 23)
Selects the input sources in sequence.
- ⑥ **SPEAKERS button** (→ page 22)
Selects Speakers A, Speakers B, or both.
- ⑦ **A/B LEDs** (→ page 22)
Lights according to the selected speaker output.
- ⑧ **BASS $-/+$ controller** (→ page 24)
Adjusts the level of bass sounds.
- ⑨ **TREBLE $-/+$ controller** (→ page 24)
Adjusts the level of treble sounds.
- ⑩ **BALANCE L/R controller** (→ page 24)
Adjusts the balance of left and right channels.
- ⑪ **DIRECT LED** (→ page 23)
Lights when the integrated amplifier is in Direct mode.
- ⑫ **DIRECT button** (→ page 23)
Enables or disables the Direct function.
- ⑬ **PHASE MATCHING BASS LED** (→ page 23)
Lights when the integrated amplifier is in Phase matching bass mode.
- ⑭ **PHASE MATCHING BASS button** (→ page 23)
Enables or disables the Phase matching bass function.
- ⑮ **LINE5 (AUX) jack**
Connect playback devices with analog audio output.
- ⑯ **PHONES jack** (→ page 24)
Connects headphones with a standard plug.

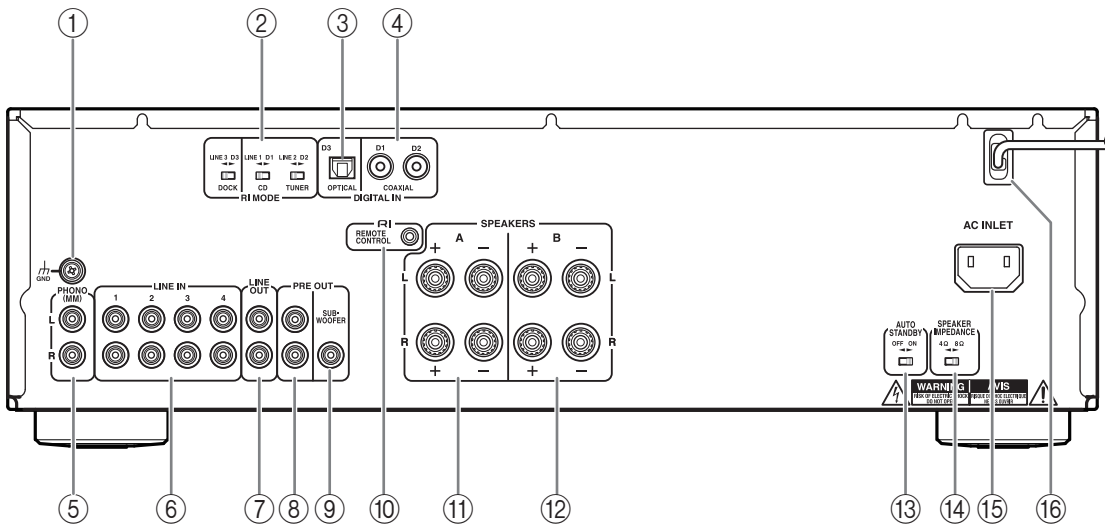

- ① **GND screw**
Connects the turntable's ground wire.
- ② **RI MODE selector (A-9050 only)**
- ③ **DIGITAL IN OPTICAL D3 jack (A-9050 only)**
Connects components such as CD players with optical digital audio output.
- ④ **DIGITAL IN COAXIAL D1/D2 jacks (A-9050 only)**
Connect components such as CD players with coaxial digital audio output.
- ⑤ **PHONO (MM) L/R jacks**
Connect a turntable with analog audio output.
- ⑥ **LINE IN 1/2/3/4 L/R jacks**
Connect playback devices with analog audio output.
- ⑦ **LINE OUT L/R jacks**
Connect components such as analog line-level sources. The input signals are output with no level adjustment.
- ⑧ **PRE OUT L/R jacks (A-9050 only)**
Connect a power amplifier when the integrated amplifier is used as a preamplifier (Pre mode).
- ⑨ **PREOUT SUBWOOFER jack**
- ⑩ **RI REMOTE CONTROL jack**
Connect Onkyo components such as Onkyo Docks, CD Players, or Tuner with **RI** (Remote Interactive) jacks.
- ⑪ **SPEAKERS A terminals**
Connect Speakers A.
- ⑫ **SPEAKERS B terminals**
Connect Speakers B.
- ⑬ **AUTO STANDBY selector**
Enables or disables the Auto standby function.
- ⑭ **SPEAKER IMPEDANCE selector (A-9050 only)**
Switches the speaker impedance to 4 Ω or 8 Ω.
- ⑮ **AC INLET (A-9050 only)**
Connects the supplied power cord. The other end of the power cord should be connected to a suitable wall outlet.
- ⑯ **POWER CORD (A-9030 only)**

See "Connections" for connection information
(→ **page 12**).

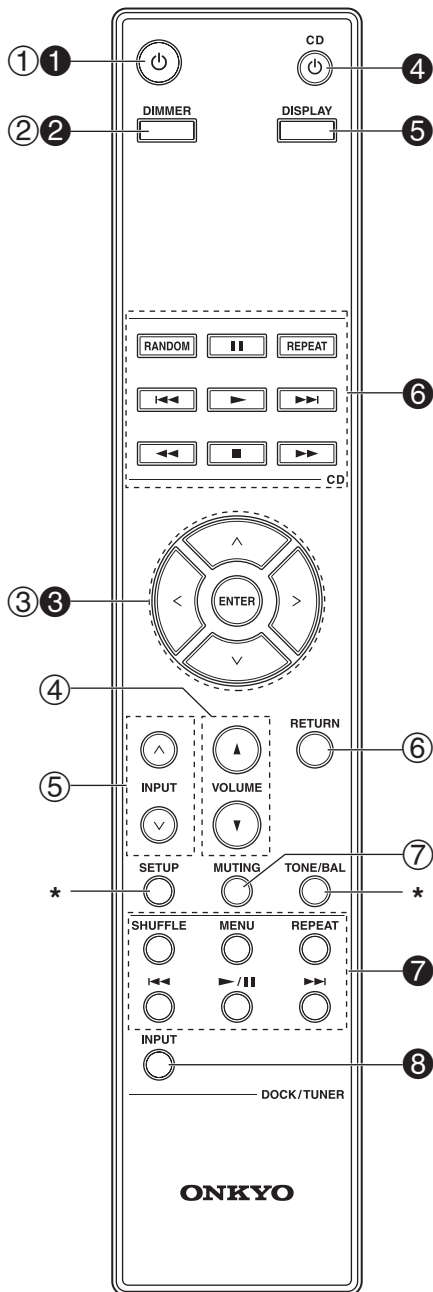

* Not used with the integrated amplifier

For detailed information, see the pages in parentheses.

- ① **⏻ button** (→ **page 21**)
Sets the integrated amplifier to On or Standby.
- ② **DIMMER button**
Adjusts the display brightness.
- ③ **^/∇/◀/▶ and ENTER buttons**
Select and adjust settings.
- ④ **VOLUME ▲/▼ buttons** (→ **page 22**)
Adjust the volume of the integrated amplifier.
- ⑤ **INPUT ^/∇ buttons** (→ **page 23**)
Select an input source.
- ⑥ **RETURN button**
Returns to the previous display when changing settings.
- ⑦ **MUTING button** (→ **page 24**)
Mutes or unmutes the integrated amplifier.

You can also use the remote controller to control your Onkyo CD Player, Onkyo **RI** Dock, or Onkyo Tuner.

Note

- With some components, the remote controller may not work, or only partially.
- To control the Onkyo Dock and Onkyo Tuner, an **RI** connection is required (→ **page 18**).
- Refer to the manuals supplied with your Onkyo CD Players, Tuner or **RI** Docks.

■ Controlling the Onkyo CD player

- ④ **⏻ CD button**
- ⑥ **Playback mode buttons**

Note































- Make sure the remote controller is pointed at the CD player when using it.

■ Controlling the Onkyo Dock

- ① **⏻ button**
- ② **DIMMER button**
- ③ **^/∇ and ENTER buttons**
- ⑦ **Dock control buttons**

■ Controlling the Onkyo Tuner / Network Tuner

- ① **⏻ button**
- ② **DIMMER button**
- ③ **^/∇/◀/▶ and ENTER buttons**
- ⑤ **DISPLAY button**
- ⑦ **Network Tuner control buttons**
- ⑧ **INPUT SELECTOR or BAND buttons**

	Connecting Terminal	LINE1/D1*	LINE2/D2*	LINE3/D3*
	Component			
Button on Remote Controller		CD Player	TUNER	RI DOCK
1				
2	DIMMER	DIMMER	DIMMER	
3			 (Tuning Up/Down)	
			 (Preset Up/Down)	
	ENTER		ENTER	ENTER
4	 CD			
5	DISPLAY		Display the current input and settings.	
6	RANDOM	RANDOM		
	REPEAT	REPEAT		
				
				
				
				
				
				
7	SHUFFLE		SHUFFLE	SHUFFLE
	MENU		MENU	MENU
	REPEAT		REPEAT	REPEAT
				
				
				
8	INPUT		INPUT SELECTOR / BAND	

*: A-9050 only

Connections

Connecting Your Speakers

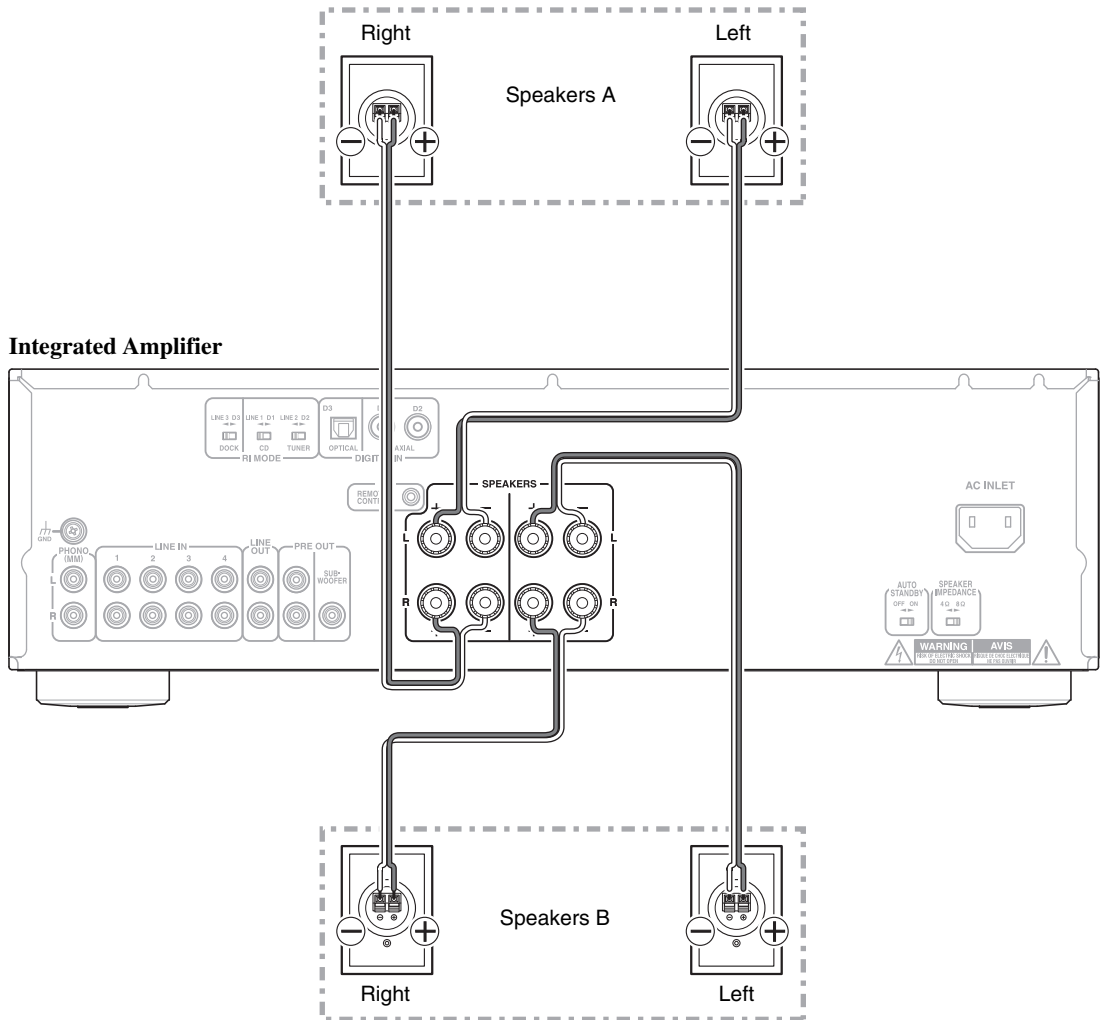

■ Screw-type speaker terminals

Strip 1/2" to 5/8" (12 to 15 mm) of insulation from the ends of the speaker cables, and twist the bare wires tightly, as shown.

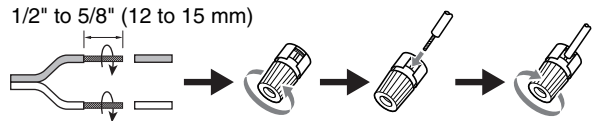

■ Banana Plugs (North American models)

- If you are using banana plugs, tighten the speaker terminal before inserting the banana plug.
- Do not insert the speaker code directly into the center hole of the speaker terminal.

Note

- Make sure that the wires do not touch metal parts on the back panel or elsewhere.
- Y plugs cannot be connected.
- Two sets of speakers (Speakers A and Speakers B) can be connected to the integrated amplifier. You can select which speakers to output audio to when listening to music. You can also output audio from both sets of speakers.
- If you use Speakers A or Speakers B, make sure to use speakers with an impedance of 4 to 16 ohms. If you use Speakers A and Speakers B, make sure to use speakers with an impedance of 8 to 16 ohms. Connecting speakers with an impedance less than 8 ohms may cause the protection circuit to activate.
- When using only one speaker, or when playing back monaural audio, don't connect a single speaker to both the left and right speaker terminals.
- Pay close attention to speaker wiring polarity. In other words, connect positive (+) terminals only to positive (+) terminals, and negative (-) terminals only to negative (-) terminals. If you get them the wrong way around, the sound will be out of phase and will feel unnatural.
- Be careful not to short the positive and negative wires. Doing so may damage the integrated amplifier.
- Make sure the metal core of the wire does not have contact with the integrated amplifier's rear panel. Doing so may damage the integrated amplifier.

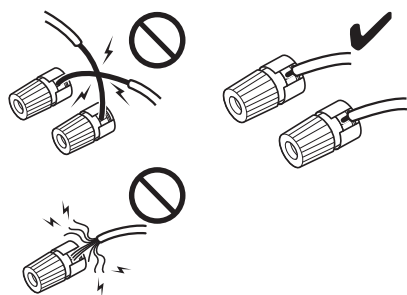

- Don't connect more than one speaker wire to a single speaker terminal. Doing so could damage the integrated amplifier or cause it to malfunction.

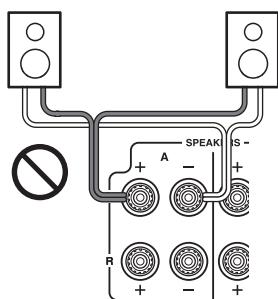

Bi-wiring Connection

Bi-wiring provides improved bass and treble performance. Using terminals of both **SPEAKERS A** and **SPEAKERS B**, it separates high frequency from low frequency signals.

Important:

- Bi-wiring can be used only with speakers that support bi-wiring and that have an impedance of 8-16 ohms.
- When making the bi-wiring connections, be sure to remove the jumper bars that link the speakers' tweeter (high) and woofer (low) terminals.
- When making the bi-wiring connections, set **SPEAKERS** to **A+B** (→ page 22).



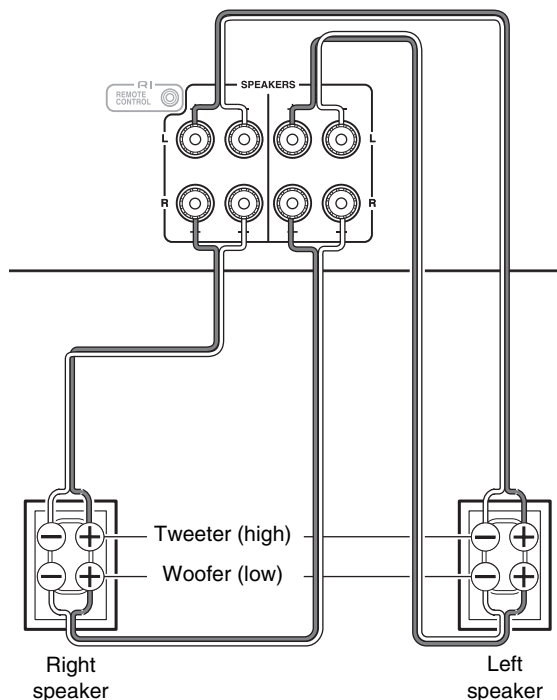





Integrated Amplifier

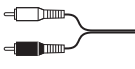

Tip

- As shown on the illustration, the wiring terminals of **SPEAKERS A** are connected to the woofer and **SPEAKERS B** are connected to the tweeter. However, wiring them the other way around is also possible.

Cable and Jacks

Optical digital audio (A-9050 only)		 OPTICAL	Optical digital connections allow you to enjoy digital sound such as PCM. The maximum sampling rate for PCM input is 96 kHz/24 bit, 2ch.
Coaxial digital audio* (A-9050 only)		 Orange	Coaxial digital connections allow you to enjoy digital sound such as PCM. The maximum sampling rate for PCM input is 96 kHz/24 bit, 2ch. The integrated amplifier provides 75-ohm impedance matching.
Analog audio (RCA)		L  White R  Red	Analog audio connections (RCA) carry analog audio.
RI		 RI REMOTE CONTROL	To use RI (Remote Interactive), you need to connect your Onkyo CD Player, Tuner, or RI Dock to the integrated amplifier with an RI cable.

Note

- Push plugs in all the way to make good connections (loose connections can cause noise or malfunctions).
- To prevent interference, keep audio cables away from power cords and speaker cables.
- The integrated amplifier's optical digital jack have shutter-type covers that open when an optical plug is inserted and close when it's removed. Push plugs in all the way.
- To prevent shutter damage, hold the optical plug straight when inserting and removing.
- Do not use digital audio signals other than PCM.
- * An analog audio cable can be used instead of a coaxial cable. However, we recommend that you use a coaxial or a composite video cable.

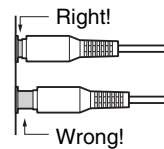

Connecting the Power Cord

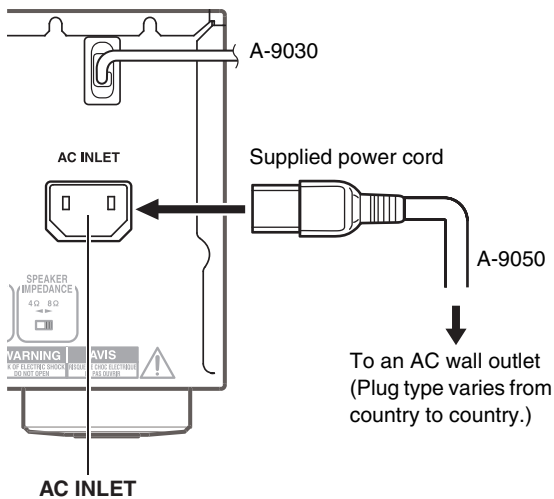

Tip

- To reduce noise, do not tie signal cables together with the power cable. Wire them so that they are away from each other.
- Depending on the country, the integrated amplifier may be polarity-sensitive. In this case, plug the power cord in a way that provides the best sound quality.

Note

- **Never disconnect the power cord from the integrated amplifier while the other end is still plugged into a wall outlet.** Doing so may cause an electric shock. Always disconnect the power cord from the wall outlet first, and then the integrated amplifier.
- Turning on the integrated amplifier may cause a momentary power surge that might interfere with other electrical equipment on the same circuit. If this is a problem, plug the integrated amplifier into a different branch circuit.
- Do not use a power cord other than the one supplied with the integrated amplifier. The supplied power cord is designed exclusively for use with the integrated amplifier and should not be used with any other equipment.

- 1** Connect all of your speakers and components.
- 2** Connect the supplied power cord to the integrated amplifier's **AC INLET**. (A-9050 only)
- 3** Plug the power cord into an AC wall outlet.

Connecting a CD Player

This is an example of connection using the CD Player.

Digital Connection (A-9050 only)

Integrated Amplifier

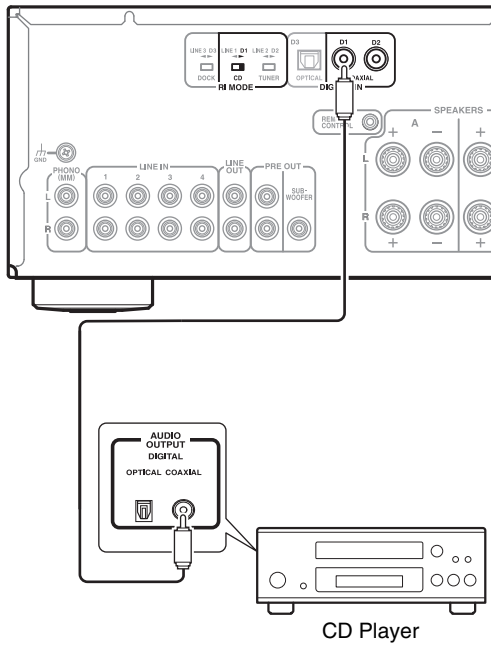

- 1 Connect the coaxial digital cable to the **COAXIAL D1** jack.
- 2 Set the **RI MODE** switch to **CD D1**.

Tip

- The CD player can be connected to the **COAXIAL D1** or **D2** jack or the **OPTICAL D3** jack. However, when using the **RI** interlock function, be sure to connect the CD player to the **COAXIAL D1** jack.

Analog Connection

Integrated Amplifier

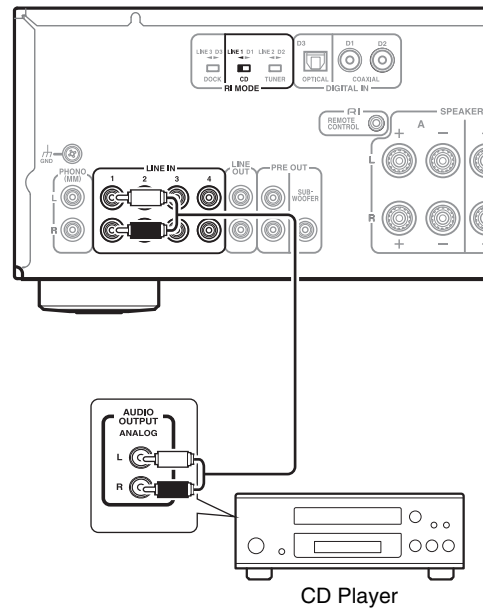

- 1 Connect an audio pin cable to the **LINE IN 1** jack.
- 2 Set the **RI MODE** switch to **CD LINE 1**. (A-9050 only)

Tip

- The CD player can be connected to the **LINE IN 1/2/3/4** jack. However, when using the **RI** interlock function, be sure to connect the CD player to the **LINE IN 1** jack.

Connecting a Tuner

This is an example of connection using the Tuner.

Digital Connection (A-9050 only)

Integrated Amplifier

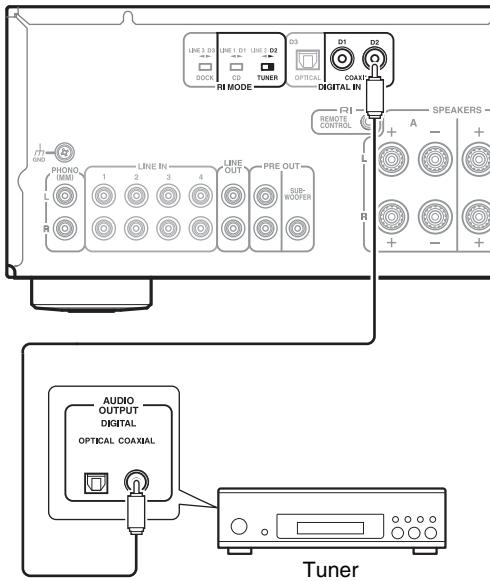

- 1** Connect coaxial digital cable to the **COAXIAL D2** jack.
- 2** Set the **RI MODE** switch to **TUNER D2**.

Tip

- The Tuner can be connected to the **COAXIAL D1** or **D2** jack or the **OPTICAL D3** jack. However, when using the **RI** interlock function, be sure to connect the Tuner to the **COAXIAL D2** jack.

Analog Connection

Integrated Amplifier

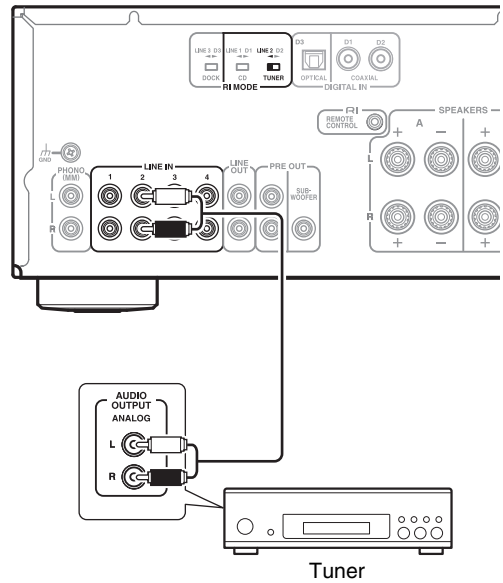

- 1** Connect an audio pin cable to the **LINE IN 2** jack.
- 2** Set the **RI MODE** switch to **TUNER LINE 2**.
(A-9050 only)

Tip

- A Tuner can be connected to the **LINE IN 1/2/3/4** jack. However, when using the **RI** interlock function, be sure to connect the Tuner to the **LINE IN 2** jack.

Connecting an Onkyo Dock

This is an example of connection using the Onkyo **RI** Dock.

Digital Connection (A-9050 only)

Integrated Amplifier

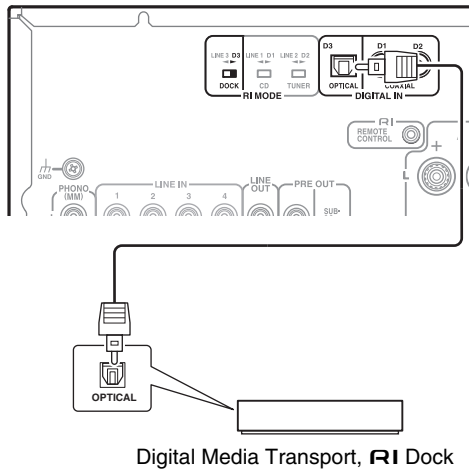

- 1** Connect the optical digital cable to the **OPTICAL D3** jack.
- 2** Set the **RI MODE** switch to **DOCK D3**.

Tip

- An Onkyo Dock can be connected to the **COAXIAL D1** or **D2** jack or the **OPTICAL D3** jack. However, when using the **RI** interlock function, be sure to connect the Onkyo Dock to the **OPTICAL D3** jack.

Analog Connection

Integrated Amplifier

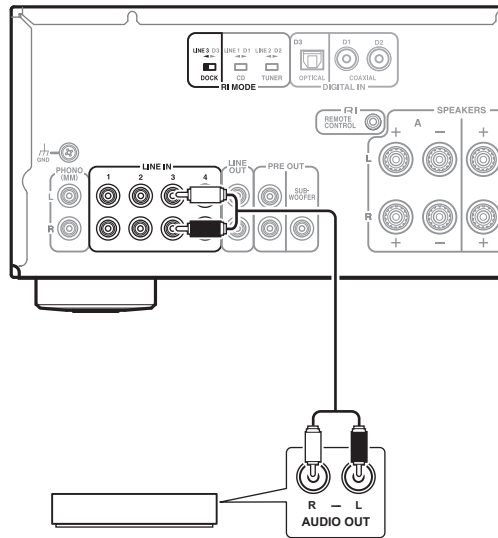

Digital Media Transport, **RI** Dock

- 1** Connect the audio pin cable to the **LINE IN 3** jack.
- 2** Set the **RI MODE** switch to **DOCK LINE 3**.
(A-9050 only)

Tip

- An Onkyo Dock can be connected to the **LINE IN 1/2/3/4** jack. However, when using the **RI** interlock function, be sure to connect the Onkyo Dock to the **LINE IN 3** jack.

Connecting Onkyo RI Components

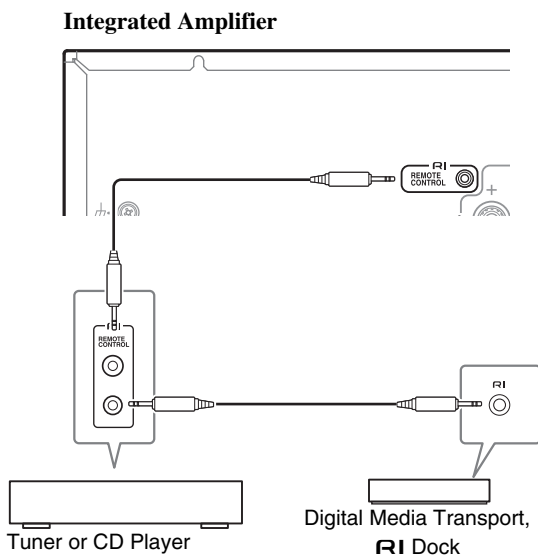

- 1 Make sure that each Onkyo CD Player, Tuner or RI Dock is connected and that the RI MODE switch is set correctly (→ pages 15 to 17).

Caution

- Settings will not be enabled even when the selector is changed in the Standby mode.
- To change a setting, be sure to turn on the unit prior to making any changes.

- 2 Make the RI connections (see the illustration).

With RI (Remote Interactive), you can use the following special functions:

■ Auto Power On

When you start playback on a component connected via RI while the integrated amplifier is on Standby, the integrated amplifier will automatically turn on and select that component as the input source.

■ Direct Change

When playback is started on a component connected via RI, the integrated amplifier automatically selects that component as the input source.

■ System Off

When you turn off the integrated amplifier, the components turn off automatically.

■ Remote Control

You can use the integrated amplifier's remote controller to control your other RI-capable Onkyo Components, pointing the remote controller at the integrated amplifier's remote control sensor instead of the component.

To operate the CD player, point the remote controller at the CD player.

Tip

- For details on operating the connected components, see "Remote Controller" (→ page 11).

Note

- Use only RI cables for RI connections. RI cables are supplied with your Onkyo CD Player, Tuner or RI Dock.
- If two RI jacks are present, you can use either one indifferently as they work the same way.
- Connect only an Onkyo CD Player, Tuner or RI Dock to the RI jack. Connecting other manufacturer's components may cause a malfunction.
- Only Onkyo CD Players, Tuners, and RI Docks are supported by the integrated amplifier's RI. With other components such as MD recorders, the RI won't work properly.
- Some components may not support all RI functions. Refer to the manuals supplied with your Onkyo CD Players, Tuner or RI Docks.
- The CD Players only support the Auto Power On and Direct Change functions.

Connecting a Turntable

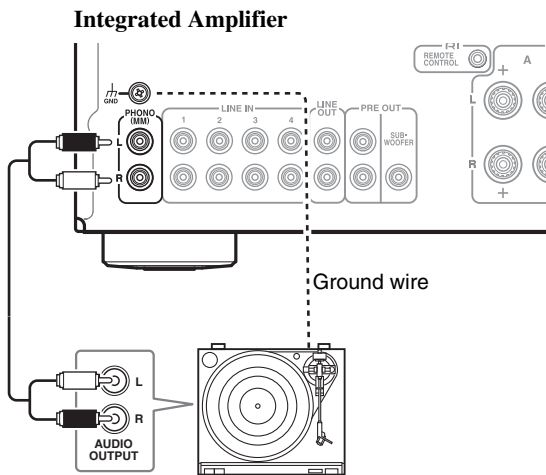

The **PHONO** input jacks are for use with moving-magnet (MM) type cartridges.

Use an analog audio cable to connect the **PHONO L/R** jacks to the audio output jacks on the turntable, as shown.

If your amplifier has shorting pin plugs, remove the shorting pin plugs before connecting your turntable.

Tip

- If the turntable has a ground wire, connect it to **GND** terminal. With some turntables, connecting the ground wire may cause hum, in which case it should be disconnected.
- If the turntable has a moving-coil (MC) type cartridge, you'll need a commercially available MC phono preamp. In this case, connect the turntable to the phono preamp's input, and connect the phono preamp's output to the **PHONO L/R** jacks.

Connecting a Cassette Tape Deck

Integrated Amplifier

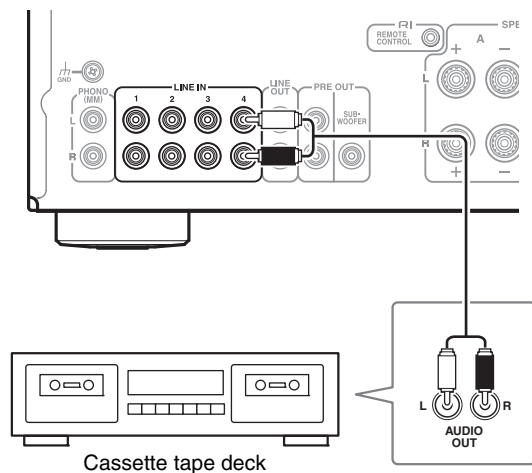

Tip

- Connect your cassette tape deck to either of the following jacks: **LINE IN 1/2/3/4**.

Connecting a Recording Component

Important:

- Unless you have the full consent of the copyright holder, copyright laws prohibit using your recordings for anything other than personal enjoyment!
- Do not change the integrated amplifier's input while recording. Doing so will cause the audio from the selected component to be recorded.

Note

- Volume adjustments and use of the muting function are not reflected in the signal output from **LINE OUT**.
- Manual tone adjustments using the **BASS -/+** controller, **TREBLE -/+** controller, **BALANCE L/R** controller, direct function, and phase matching bass function are not reflected in the signal output from **LINE OUT**.
- See the manual of the recording component for instructions on correct use.

Integrated Amplifier

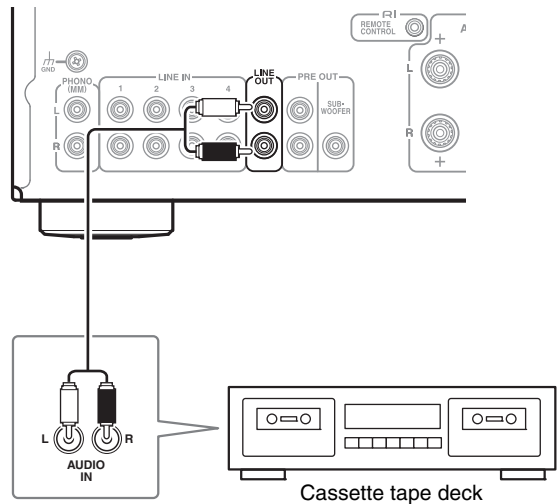

Connecting a Subwoofer With Built-In Power Amplifier

A subwoofer with a built-in power amplifier can be connected to be used.

Connect LINE INPUT on the subwoofer with a built-in power amplifier to PRE OUT: SUBWOOFER terminal on the integrated amplifier.

If your subwoofer does not have a built-in amplifier, connect the input jack of your amplifier to the pre out jack of the subwoofer.

For details, refer to the manual supplied with your subwoofer.

Integrated Amplifier

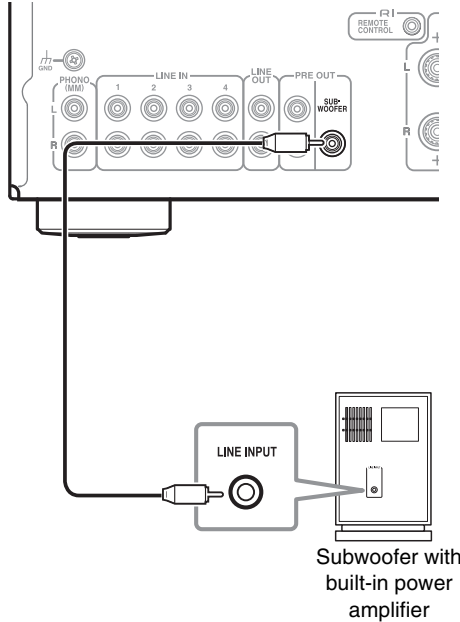

Using the Integrated Amplifier as a Preamplifier

The integrated amplifier can be used as a preamplifier (Pre mode). This is an example of connection using the power amplifier. (A-9050 only)

Integrated Amplifier

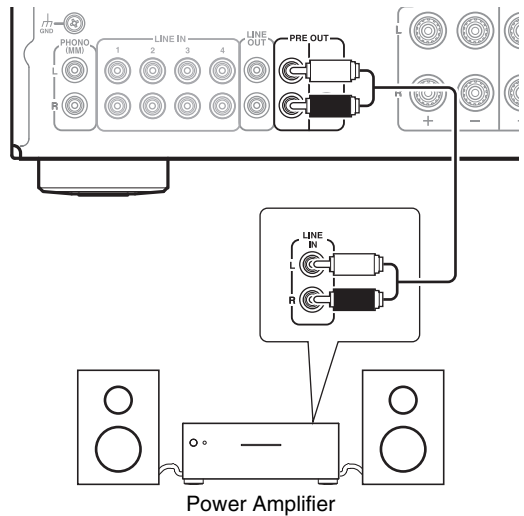

Basic Operations

Turning On/Off the Integrated Amplifier

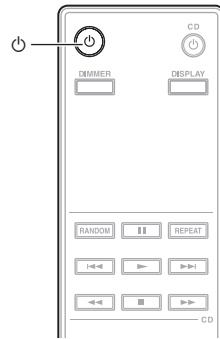
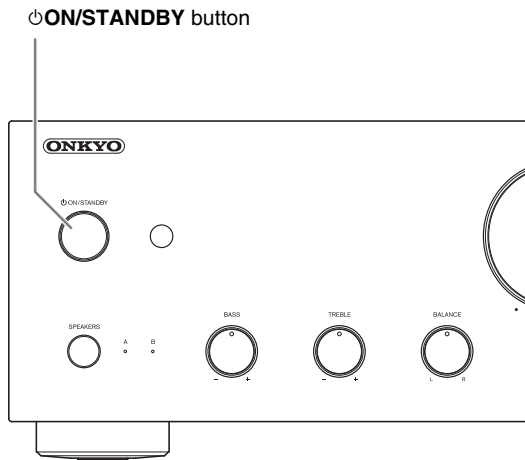

Turning On the Integrated Amplifier

■ Operating with the remote controller

1 Press .

The SPEAKERS (A/B) and Input source LEDs blink, then light up after a short time.

■ Operating on the integrated amplifier

1 Press ON/STANDBY.

The SPEAKERS (A/B) and Input source LEDs blink, then light up after a short time.

Tip

- After a certain time of warming up, the internal temperature of the integrated amplifier stabilizes, and the sound is softened.
- The integrated amplifier remembers the state when power was last turned off, and returns to that state.

Turning Off the Integrated Amplifier

■ Operating with the remote controller

1 Press .

The integrated amplifier enters Standby mode and the LED goes off.

■ Operating on the integrated amplifier

1 Press ON/STANDBY.

The integrated amplifier enters Standby mode and the LED goes off.

Tip

- For details on power management settings, see “Setting the Auto Standby Function” (→ [page 25](#)).

Selecting Speakers A and Speakers B

You can select to output sound from Speakers A, Speakers B, or both A + B.

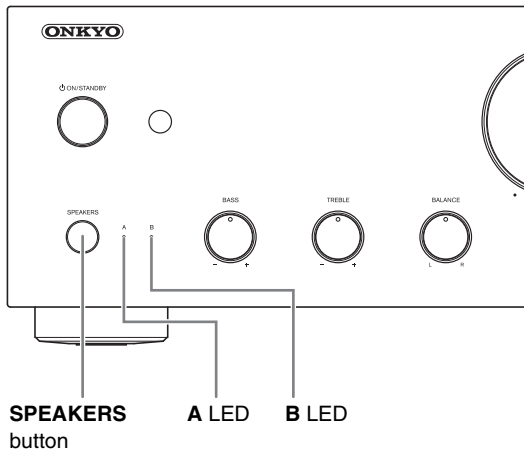

1 Press **SPEAKERS** repeatedly on the integrated amplifier.

The LED of the selected speakers lights.

Note

- While headphones are connected, this setting is disabled.
- When this setting is set to **A + B**, the impedance of speakers is restricted. For further details, see “Connecting Your Speakers” (→ **page 12**).

Adjusting the Volume

■ Operating with the remote controller

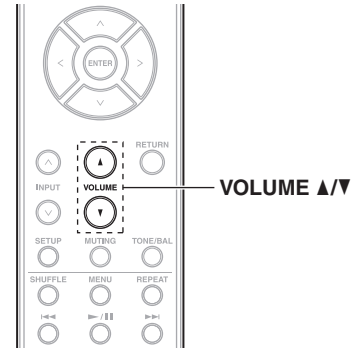

1 Press **VOLUME ▲/▼** repeatedly.

■ Operating on the integrated amplifier

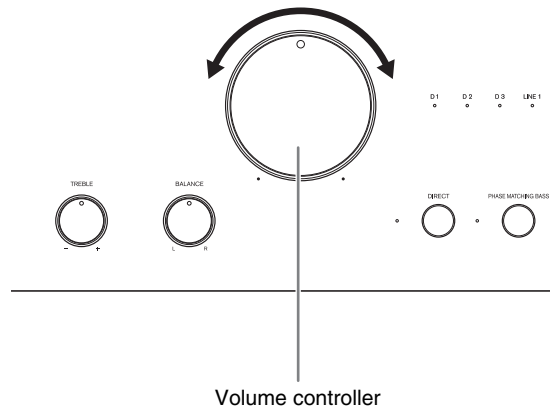

1 Use the volume controller.

Tip

- The default level is 0.

Selecting the Input Source

You can switch inputs to select the desired source component. Choose an input from the following: **LINE1, LINE2, LINE3, LINE4, LINE5, PHONO (D1, D2, D3 (A-9050 only))**

The LED corresponding to the selected input will light up.

Tip

- The LED will blink when **D1, D2** or **D3** is selected and a signal is not input. (A-9050 only)

■ Operating with the remote controller

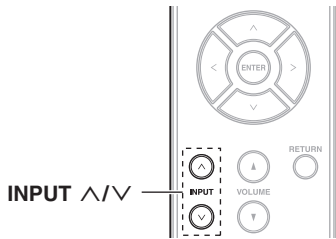

1 Press **INPUT** \wedge/\vee repeatedly.

■ Operating on the integrated amplifier

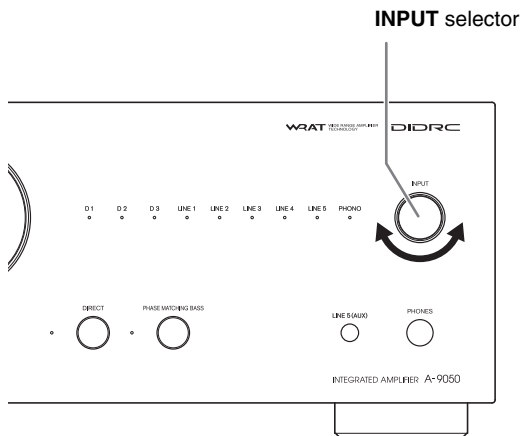

1 Use the **INPUT** selector.

Using the Direct Function

By bypassing the tone control circuit, the Direct function uses the shortest path for enhanced sound quality. Also, since the left/right balance setting uses a system that doesn't affect the sound quality, the balance can be adjusted even if the Direct function is enabled.

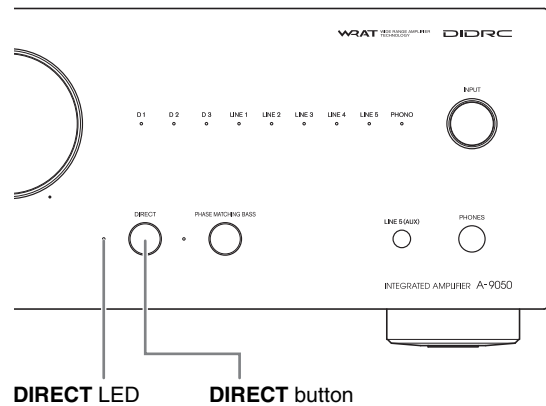

1 Press the **DIRECT** button.
The **DIRECT** LED lights.

Using the PHASE MATCHING BASS Function

From the warm low notes produced by a cello to the deep frequencies of electronic music, a good compact audio system should be able to deliver plenty of bass resonance. While traditional enhancement systems effectively boost low-frequency sound, they are often prone to the effects of phase shifting, which can overwhelm mid-range frequencies and muddy the sound.

Our Phase-Matching Bass Boost technology effectively preserves mid-range clarity-allowing vocals and strings to shine-while maintaining a smooth, powerful bass response at all volume levels.

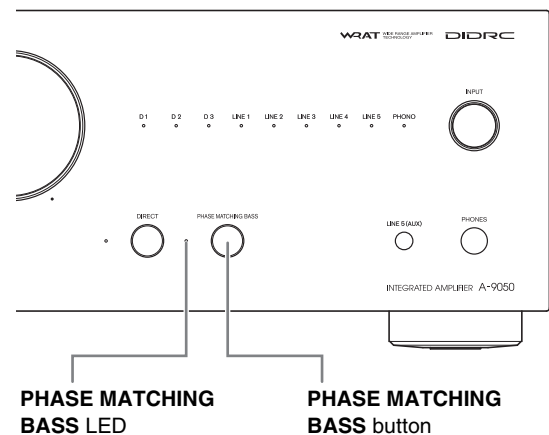

1 Press the **PHASE MATCHING BASS** button.
The **PHASE MATCHING BASS** LED lights up.

- When the **DIRECT** function is on, turn the function off to use the **PHASE MATCHING BASS** effect.

Adjusting the Bass, Treble and Balance

You can adjust the bass, treble and left/right output balance respectively.

■ Operating on the integrated amplifier

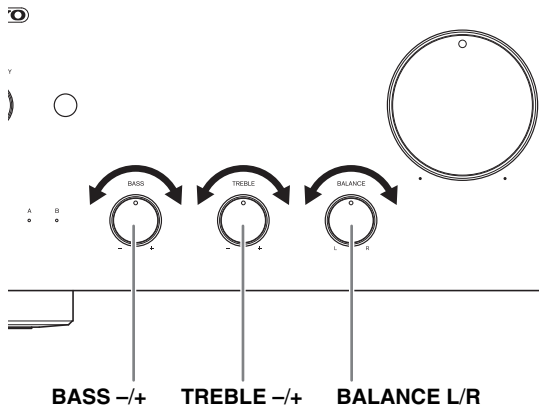

1 Turn the **BASS -/+**, **TREBLE -/+** and **BALANCE L/R** knobs.

Tip

- By default, bass, treble and balance is set to the center position.

Note

- While the Direct function is enabled, bass and treble are disabled.

Muting the Sound

You can temporarily mute the output of the integrated amplifier.

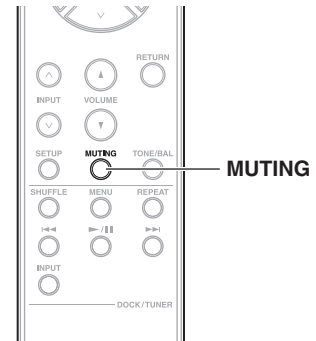

1 Press **MUTING**.

The **SPEAKERS (A/B)** and **SELECTOR LEDs** blink. To unmute the integrated amplifier, press **MUTING** again.

Note

- While the integrated amplifier is muted:
 - Adjusting the volume or setting the integrated amplifier to Standby will unmute the integrated amplifier.

Using Headphones

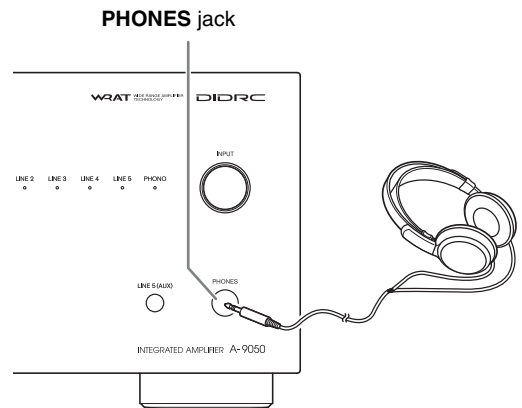

1 Connect a pair of stereo headphones with a standard plug (1/4 inch or 6.3 mm) to the **PHONES jack**.

When connecting the headphones, the **SPEAKERS (A/B)** LEDs go off.

You can adjust the volume and mute the sound, by using **VOLUME ▲/▼**.

While headphones are connected, no sound is output from the speakers and PRE OUT jacks.

Note

- Always turn down the volume before connecting your headphones.
- When headphones are connected, the **SPEAKERS** button cannot be used.

Custom Setup

Setting the Auto Standby Function

When the Auto Standby (ASb) function is activated, the integrated amplifier will automatically enter Standby mode if there is no operation for 30 minutes with no audio signal input.

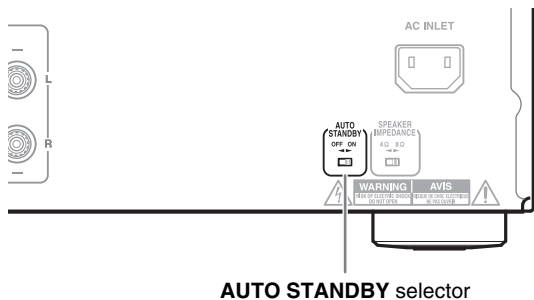

AUTO STANDBY selector

1 Switch the AUTO STANDBY selector on the unit's rear panel.

- ▶ [ON]
Enables auto standby.
- ▶ [OFF]
Disables auto standby.

Setting the speaker impedance

You can set the impedance of the speakers that you connect to the unit. (A-9050 only)

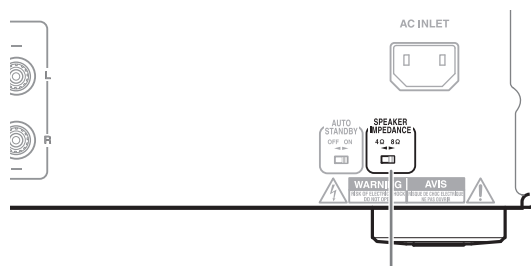

SPEAKER IMPEDANCE selector

1 Switch the SPEAKER IMPEDANCE selector on the unit's rear panel.

- ▶ [4 Ω or more and less than 8 Ω]
Sets the impedance to 4 Ω.
- ▶ [8 Ω or more and 16 Ω or less]
Sets the impedance to 8 Ω.

Caution

- Settings will not be enabled even when the selector is changed in the Standby mode.
To change a setting, be sure to turn on the unit prior to making any changes.

Troubleshooting

First check the followings.

Since the issue may be caused by other components that are connected, be sure to also check them while referring to their manuals.

Further product operating procedures and FAQs (frequently asked questions) are available from the Onkyo web site.

<http://www.jp.onkyo.com/support/>

Tip

Before requesting repairs

If the integrated amplifier is no longer working or functioning, any issues may be resolved by resetting the microcomputer contained in the integrated amplifier to revert all settings to their defaults.

Before requesting repairs, follow the procedure below to reset the microcomputer.

With the integrated amplifier turned on, hold down DIRECT and press ON/STANDBY.

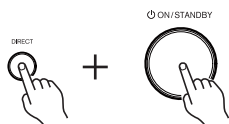

Power

Can't turn on the Integrated Amplifier.

- Make sure that the power cord is properly plugged into the wall outlet (→ page 14).
- Unplug the power cord from the wall outlet, wait 5 seconds or more, then plug it in again.

The Integrated Amplifier turns off unexpectedly.

- When the protection circuit is activated (because of speaker short-circuit, overload, or over-current), the integrated amplifier enters Standby mode. Remove the source of the problem and turn the integrated amplifier back on.
- Check that the switch on the back of the integrated amplifier is set to the correct setting (→ page 25).
- The settings are not enabled when the switch is changed during the Standby mode.
To change a setting, be sure to turn on the unit prior to making any changes.

Audio

There's no sound.

- Make sure the integrated amplifier's volume control is not set to minimum (→ page 22).
- Make sure the correct input source is selected (→ page 23).
- Make sure the integrated amplifier is not muted (→ page 24).
- Make sure the speakers are connected correctly (→ page 12).
- Check all connections and correct as necessary (→ page 12).
- While headphones are connected, the speakers output no sound (→ page 24).
- The integrated amplifier does not support digital formats other than PCM. Inputting a digital format other than PCM will cause loud noise.

The sound quality is not good.

- Make sure the speaker cables are connected with the correct polarity (→ page 12).
- Make sure all audio connecting plugs are pushed in all the way (→ page 14).
- The sound quality can be affected by strong magnetic fields, such as those from a TV. Try moving any such devices away from the integrated amplifier.
- If you have any devices that emit high-intensity radio waves near the integrated amplifier, such as a cellular phone that's being used to make a call, the integrated amplifier may output noise.

Headphone output is intermittent or there's no sound.

- This may be due to dirty contacts. Clean the headphones plug. See your headphones' instruction manual for cleaning information. Also, make sure that the headphones cable is not broken or damaged.

Audio performance

- Audio performance will be at its best about 10 to 30 minutes after the integrated amplifier has been turned on and had time to warm up.
- Using cable ties to bundle audio cables with speaker or power cables may degrade the sound quality, so refrain from doing it.
- Depending on the country, the integrated amplifier may be polarity-sensitive. In this case, plug the power cord in a way that provides the best sound quality.
- Install the integrated amplifier on a sturdy rack or shelf. Position it so that its weight is evenly dispersed on its four legs. Do not install the integrated amplifier in a place with vibration or an unstable location.
- Plug the power cord into an AC wall outlet.

Onkyo Dock

There's no sound.

- Make sure that the Onkyo Dock is connected to the integrated amplifier properly.
- Make sure that no video content is being played.
- Reset the iPod.

Other

- When the Auto Standby (ASb) function is activated, the power of the Onkyo Dock connected via **RI** is automatically turned off (→ **page 25**).

Can't control properly by using the remote controller.

- Make sure that the **RI** cable is connected to the integrated amplifier correctly.
Check that each device is connected correctly and that the **RI MODE** switch is set correctly (→ **page 17**).

External Components

No sound is heard from a connected component.

- Make sure the correct input source is selected (→ **page 23**).
- Make sure the analog audio cable is connected correctly (→ **page 14**).

When the **RI** interlock does not function properly

- Check that each device is connected correctly and that the **RI MODE** switch is set correctly (→ **pages 15 to 17**).
- Check that the switch on the back of the integrated amplifier is set to the correct setting.
- The settings are not enabled when the switch is changed during the Standby mode.
To change a setting, be sure to turn on the unit prior to making any changes.
- The connecting method may vary depending on the device that will be connected. Please refer to the **RI** connection section in the owner's manual of the connected device.

The sound from turntable is distorted.

- If your turntable has a built-in phono preamp, connect to other analog inputs such as **LINE IN**.
- If your turntable does not have a built-in phono preamp, connect a turntable to **PHONO** (→ **page 19**).
- Make sure that the ground wire is connected. Otherwise, it may produce an audible hum and noise.

Remote Controller

The remote controller doesn't work properly.

- Make sure the batteries have been installed with the correct polarity (+/-) (→ **page 7**).
- Replace both batteries with new ones. (Do not mix different types of batteries or new and old batteries.)
- The remote controller is too far away from the integrated amplifier, or there's an obstacle between them (→ **page 7**).
- The integrated amplifier's remote control sensor is being subjected to bright light (inverter-type fluorescent light or sunlight).
- The integrated amplifier is located behind the glass doors of an audio rack or cabinet.

Onkyo is not responsible for damages (such as CD rental fees) due to unsuccessful recordings caused by the unit's malfunction. Before you record important data, make sure that the material will be recorded correctly.

The integrated amplifier contains a microcomputer for signal processing and control functions. In very rare situations, severe interference, noise from an external source, or static electricity may cause it to lockup. In the unlikely event that this should happen, unplug the power cord, wait at least 5 seconds, and then plug it again.

Before disconnecting the power cord from the wall outlet, set the integrated amplifier to Standby.

If during idling the cover is too hot to touch, then ventilation needs to be improved.

Specifications

	A-9050	A-9030
Rated Output Power	(North American) (FTC) 75 watts minimum continuous power per channel, 8 ohm loads, 2 channels driven at 1 kHz, with a maximum total harmonic distortion of 0.08 % (FTC) 65 watts minimum continuous power per channel, 4 ohm loads, 2 channels driven at 1 kHz, with a maximum total harmonic distortion of 0.08 % (European) (IEC) 2 ch × 75 W at 8 ohms, 1 kHz, 2 ch Driven of 0.08 %	(IEC) 2 ch × 65 W at 8 ohms, 1 kHz, 2 ch Driven of 0.08 %
Maximum Effective Output Power		(Asian) (JEITA) 2 ch × 80 W at 4 ohms, 1 kHz, 2 ch driven
THD+N (Total Harmonic Distortion+N)	0.08 % (Rated Output Power)	0.08 % (Rated Output Power)
Damping Factor	60 (Front, 1 kHz, 8 Ω)	60 (Front, 1 kHz, 8 Ω)
Input Sensitivity and Impedance (Unbalance)	275 mV/33 kΩ (LINE) 4.8 mV/47 kΩ (PHONO MM)	275 mV/33 kΩ (LINE) 4.8 mV/47 kΩ (PHONO MM)
Rated RCA Output Level and Impedance	0.275 V/2.2 kΩ (REC OUT)	0.275 V/2.2 kΩ (REC OUT)
Phono Overload	100 mV (MM 1 kHz 0.5 %)	100 mV (MM 1 kHz 0.5 %)
Frequency Response	10 Hz - 100 kHz/+1 dB, -3 dB (LINE1)	10 Hz - 100 kHz/+1 dB, -3 dB (LINE1)
Tone Control Characteristics	+14 dB, -14 dB, 100 Hz (BASS) +14 dB, -14 dB, 10 kHz (TREBLE) +0 dB, -14 dB (BALANCE) +8 dB, 80 Hz (PM.BASS)	+14 dB, -14 dB, 100 Hz (BASS) +14 dB, -14 dB, 10 kHz (TREBLE) +0 dB, -14 dB (BALANCE) +8 dB, 80 Hz (PM.BASS)
Signal to Noise Ratio	110 dB (LINE, IHF-A) 80 dB (PHONO MM, IHF-A)	105 dB (LINE, IHF-A) 80 dB (PHONO MM, IHF-A)
Speaker Impedance	4 Ω - 16 Ω	4 Ω - 16 Ω
Power Supply	(North American) AC 120 V, 60 Hz (European) AC 230 V, 50 Hz	(European) AC 230 V, 50 Hz (Asian) AC 220 V, 50 Hz
Power Consumption	160 W	(European) 135 W (Asian) 125 W
No-sound Power Consumption	(North American) 45 W (European) 50 W	35 W
Stand-by Power Consumption	(North American) 0.2 W (European) 0.3 W	0.3 W
Dimensions (W × H × D)	435 mm × 139 mm × 330.3 mm 17-1/8" × 5-1/2" × 13"	435 mm × 139 mm × 330.3 mm 17-1/8" × 5-1/2" × 13"
Weight	8.2 kg (18.1 lbs)	7.4 kg (16.3 lbs)

■ Audio Inputs

Digital Inputs	1 (Rear Optical) 2 (Rear Coaxial)	
Analog Stereo Inputs	LINE1, LINE2, LINE3, LINE4, LINE5, PHONO	LINE1, LINE2, LINE3, LINE4, LINE5, PHONO

■ Audio Outputs

Analog Stereo Outputs	LINE OUT, PRE OUT	LINE OUT
Subwoofer Pre Outputs	1	1
Speaker Outputs	SP-A, B	SP-A, B
Phones	1 (6.3 ϕ)	1 (6.3 ϕ)

■ Others

RI	1	1
-----------	---	---

Specifications and features are subject to change without notice.

MEMO

MEMO



MEMO

ONKYO

Onkyo Corporation

2-1, Nisshin-cho, Neyagawa-shi, OSAKA 572-8540, JAPAN

Tel: 072-831-8023 Fax: 072-831-8163

<http://www.onkyo.com/>

Onkyo U.S.A. Corporation

18 Park Way, Upper Saddle River, N.J. 07458, U.S.A.

Tel: 800-229-1687, 201-785-2600 Fax: 201-785-2650

<http://www.us.onkyo.com/>

Onkyo Europe Electronics GmbH

Liegnitzerstrasse 6, 82194 Groebenzell, GERMANY

Tel: +49-8142-4401-0 Fax: +49-8142-4208-213

<http://www.eu.onkyo.com/>

Onkyo Europe Electronics GmbH (UK Branch)

The Coach House 81A High Street, Marlow, Buckinghamshire, SL7 1AB, UK

Tel: +44-(0)1628-473-350 Fax: +44-(0)1628-401-700

Onkyo China Limited

Unit 1033, 10/F, Star House, No 3, Salisbury Road, Tsim Sha Tsui Kowloon, Hong Kong.

Tel: 852-2429-3118 Fax: 852-2428-9039

<http://www.onkyochina.com/>

Onkyo China PRC

1301, 555 Tower, No.555 West NanJin Road, Jin an, Shanghai,

China 200041, Tel: 86-21-52131366 Fax: 86-21-52130396

<http://www.cn.onkyo.com/>

C1207-1

SN 29401270

(C) Copyright 2012 Onkyo Corporation Japan. All rights reserved.



* 2 9 4 0 1 2 7 0 *