

ScanSnap
Color Image Scanner
iX500

Operator's Guide

Introduction

Thank you for purchasing the color image scanner ScanSnap iX500 (hereinafter referred to as "the ScanSnap").

This manual explains how to handle and operate the ScanSnap.

Be sure to read this manual, "Safety Precautions", and "Getting Started" thoroughly before using the ScanSnap to ensure correct use.

We hope that this manual will provide you with useful information in order to utilize the ScanSnap.

If you are using a Windows[®] operating system, either Adobe[®] Acrobat[®] (7.0 or later) or Adobe[®] Reader[®] (7.0 or later) is required to display or print this manual.

Safety Information

The attached "Safety Precautions" manual contains important information about the safe and correct use of the ScanSnap. Make sure that you read and understand it before using the ScanSnap.

Trademarks

Microsoft, Windows, Windows Vista, Excel, PowerPoint, Outlook, SharePoint, Windows Live, Internet Explorer, and Entourage are either registered trademarks or trademarks of Microsoft Corporation in the United States and/or other countries.

Word is the product of Microsoft Corporation in the United States.

Apple, the Apple logo, Mac, Mac OS, OS X, iPhoto, iTunes, and App Store are trademarks of Apple Inc.

Adobe, the Adobe logo, Acrobat, and Reader are either registered trademarks or trade names of Adobe Systems Incorporated in the United States and/or other countries.

Intel and Intel Core are registered trademarks or trademarks of Intel Corporation in the United States and other countries.

ABBYY[™] FineReader[™] Engine © ABBYY. OCR by ABBYY

ABBYY and FineReader are trademarks of ABBYY.

Evernote is a registered trademark or trademark of Evernote Corporation.

Google, Google Docs, Android, and Google Play are registered trademarks or trademarks of Google Inc.

Salesforce, the Salesforce logo, and Salesforce CRM are registered trademarks or trademarks of salesforce.com, inc. in the United States and other countries.

Wi-Fi and Wi-Fi Protected Setup are trademarks of Wi-Fi Alliance.

Besides the software authored by the product developer (PFU LIMITED), the ScanSnap contains other free software, such as software copyrighted under the GNU General Public License (GPL) or the GNU Lesser General Public License (LGPL). For details concerning the conditions of the licenses, refer to "Terms and Conditions for End User License" (file name: OSS_License.pdf) contained in the Setup DVD-ROM.

ScanSnap, the ScanSnap logo, ScanSnap Manager, ScanSnap Organizer, CardMinder, and Rack2-File are registered trademarks or trademarks of PFU LIMITED in Japan.

Other company names and product names are the registered trademarks or trademarks of the respective companies.

Manufacturer

PFU LIMITED

International Sales Dept., Imaging Business Division, Products Group
Solid Square East Tower 580 Horikawa-cho, Saiwai-ku, Kawasaki-shi,
Kanagawa 212-8563, Japan

Phone: (81-44)-540-4538







© PFU LIMITED 2012-2013







Manuals

Read the following manuals as needed when using the ScanSnap.

Manual	Description	Location
Safety Precautions	Read this manual before you start using the product because it contains important information about the safe use of the ScanSnap.	<p>Included in the package. You can also refer to this manual by following the procedure below when the software has been installed.</p> <p>Windows Select [Start] menu → [All Programs] → [ScanSnap Manager] → [Safety Precautions] (for Windows 8, right-click the Start screen, and select [All apps] on the app bar → [Safety Precautions] under [ScanSnap Manager]).</p> <p>Mac OS From the sidebar in Finder, select [Applications] → [ScanSnap] → [Manual], and then double-click [Safety Precautions].</p>
ScanSnap iX500 Getting Started	This manual explains about the ScanSnap package contents, software installation, connecting the ScanSnap, and checking the operation.	<p>Windows Select [Start] menu → [All Programs] → [ScanSnap Manager] → [Getting Started] (for Windows 8, right-click the Start screen, and select [All apps] on the app bar → [Getting Started] under [ScanSnap Manager]).</p> <p>Mac OS From the sidebar in Finder, select [Applications] → [ScanSnap] → [Manual], and then double-click [Getting Started].</p>
ScanSnap iX500 Operator's Guide (this manual)	Read this manual for information about the basic operations of the ScanSnap, software installation, scanning methods, various settings, and handling of the ScanSnap.	<p>Windows Select [Start] menu → [All Programs] → [ScanSnap Manager] → [Operator's Guide] (for Windows 8, right-click the Start screen, and select [All apps] on the app bar → [Operator's Guide] under [ScanSnap Manager]).</p> <p>Mac OS From the sidebar in Finder, select [Applications] → [ScanSnap] → [Manual], and then double-click [Operator's Guide].</p>

Manual	Description	Location
<p>Troubleshooting (installation)</p>	<p>Read this manual when you failed to install the software or when the ScanSnap does not operate normally after software installation. It explains about the resolutions for such troubles.</p>	<p>Windows</p> <ul style="list-style-type: none"> ● Click [Manuals] → [Troubleshooting (installation)] in the [ScanSnap Setup] dialog box that appears when you insert the Setup DVD-ROM into the DVD-ROM drive. ● Select [Start] menu → [All Programs] → [ScanSnap Manager] → [Troubleshooting (installation)] (for Windows 8, right-click the Start screen, and select [All apps] on the app bar → [Troubleshooting (installation)] under [ScanSnap Manager]). <p>Mac OS</p> <ul style="list-style-type: none"> ● Double-click the [Troubleshooting (installation)] icon in the [ScanSnap] window that appears when you insert the Setup DVD-ROM into the DVD-ROM drive. ● From the sidebar in Finder, select [Applications] → [ScanSnap] → [Manual], and double-click [Troubleshooting (installation)].
<p>ScanSnap Connect Application User's Guide (iOS)</p>	<p>Read this manual for information about connecting the mobile device and the computer, ScanSnap Connect Application operations on the mobile device, settings and receiving files.</p>	<p>Start ScanSnap Connect Application on the iOS mobile device, tap [i] on the [File List] screen, and then tap [Help] on the [Information] screen that appears.</p>
<p>ScanSnap Connect Application User's Guide (Android)</p>	<p>Read this manual for information about connecting the mobile device and the computer, ScanSnap Connect Application operations on the mobile device, settings and receiving files.</p>	<p>Start ScanSnap Connect Application on the Android mobile device, and when the [File List] screen is displayed, press the [Menu] button on the device or tap the software [Menu] to display the menu. Tap [i] in the menu, and then tap [Help] on the [Information] screen that appears.</p>

Manual	Description	Location
<p> ScanSnap Organizer User's Guide</p>	<p>Read these manuals when using this product for the first time, or when you need more information in general, on product features and operating environment.</p>	<p> Select [Start] menu → [All Programs] → [ScanSnap Organizer] → [Manual] (for Windows 8, right-click the Start screen, and select [All apps] on the app bar → [Manual] under [ScanSnap Organizer]).</p>
<p>CardMinder User's Guide</p>		<p> Select [Start] menu → [All Programs] → [CardMinder] → [Manual] (for Windows 8, right-click the Start screen, and select [All apps] on the app bar → [Manual] under [CardMinder]).</p> <p> From the sidebar in Finder, select [Applications] → [CardMinder] → [Manual], and then double-click [User's Guide].</p>
<p> Scan to Microsoft SharePoint User Guide</p>	<p>Read these manuals when using this product for the first time, or when you need more information on product features, dialog boxes/windows, operating environment and functions.</p>	<p> Select [Start] menu → [All Programs] → [KnowledgeLake] → [Scan to Microsoft SharePoint User Guide] (for Windows 8, right-click the Start screen, and select [All apps] on the app bar → [Scan to Microsoft SharePoint User Guide] under [KnowledgeLake]).</p>
<p> ABBYY FineReader for ScanSnap User's Guide</p>	<p>Read this manual when questions or problems regarding operations (e.g. when setting items) arise.</p>	<p> Select [Start] menu → [All Programs] → [ABBYY FineReader for ScanSnap(TM) 5.0] → [User's Guide] (for Windows 8, right-click the Start screen, and select [All apps] on the app bar → [User's Guide] under [ABBYY FineReader for ScanSnap(TM) 5.0]).</p>

Manual	Description	Location
ScanSnap Manager Help	<p>Read this Help file when questions or problems regarding operations (e.g. when setting items) arise.</p> <p>This Help file explains about scanner operations, operational troubles and their resolution, dialog boxes/windows and messages.</p>	<p>Refer to this Help by one of the following methods:</p> <p>Windows</p> <ul style="list-style-type: none"> ● The ScanSnap Manager icon  is displayed in the menu that appears when you click  in the notification area. Right-click the ScanSnap Manager icon , and then select [Help] → [Help] from the menu that appears. ● Select [Start] menu → [All Programs] → [ScanSnap Manager] → [ScanSnap Manager Help] (for Windows 8, right-click the Start screen, and select [All apps] on the app bar → [ScanSnap Manager Help] under [ScanSnap Manager]). ● Click the Help button () for ScanSnap Manager. ● Press the [F1] key on the keyboard when a dialog box is displayed. ● Click the [Help] button in each dialog box. <p>Mac OS</p> <ul style="list-style-type: none"> ● Click the ScanSnap Manager icon  in the Dock while pressing the [control] key on the keyboard, and then select [Help] → [Help] from the menu that appears. ● Click the Help button () for ScanSnap Manager. ● From the menu bar, select [Help] → [ScanSnap Manager Help].

Manual	Description	Location
ScanSnap Online Update Help	Read this Help file when questions or problems regarding operations arise. This Help file explains about operations, dialog boxes/windows and messages.	Refer to this Help by either of the following methods: Windows <ul style="list-style-type: none"> ● Select [Start] menu → [All Programs] → [ScanSnap Online Update] → [Help] (for Windows 8, right-click the Start screen, and select [All apps] on the app bar → [Help] under [ScanSnap Online Update]). ● Press the [F1] key on the keyboard when a dialog box is displayed. ● Click the [Help] button in each dialog box. Mac OS <ul style="list-style-type: none"> ● Click the Help button (?) for ScanSnap online update. ● From the menu bar, select [Help] → [ScanSnap Online Update Help].
ScanSnap Wireless Setup Tool Help	Read this Help file when questions or problems regarding operations arise. This Help file explains about scanner operations, operational troubles and their resolution, dialog boxes/windows and messages.	Refer to this Help by either of the following methods: Windows <ul style="list-style-type: none"> ● Press the [F1] key on the keyboard when a dialog box is displayed. ● Click [About this screen] or [About this message] on each screen. Mac OS <ul style="list-style-type: none"> ● Click the Help button (?) in each window.
Windows ScanSnap Organizer Help CardMinder Help	Read these Help files when questions or problems regarding operations (e.g. when setting items) arise. These Help files explain about operations, dialog boxes/windows and messages.	For details about how to start up the Help, refer to the User's Guide for each product.
Windows Adobe Acrobat Help	Read these Help files when questions or problems regarding operations (e.g. when setting items) arise.	Windows From the menu bar, select [Help] → [Adobe Acrobat XI Help].
Mac OS ABBYY FineReader for ScanSnap Help		Mac OS From the menu bar, select [Help] → ABBYY FineReader for ScanSnap Help.

Structure of This Manual

This manual consists of the following:

ScanSnap Overview

This chapter covers the features of the ScanSnap, an overview of ScanSnap Manager, and how to use the ScanSnap via wireless LAN, as well as the basic operations of the ScanSnap.

Installing the Software

This chapter explains about the software bundled with the ScanSnap, system requirements and installation procedures.

Using the ScanSnap (for Windows Users)/Using the ScanSnap (for Mac OS Users)

This chapter explains how to perform scanning and how to set the ScanSnap Manager.

Troubleshooting

This chapter provides references for resolving troubles such as removing jammed documents.

Daily Care

This chapter explains about the cleaning materials and how to clean the ScanSnap.

Consumables

This chapter explains how to replace the consumables.

Appendix

This appendix explains how to update ScanSnap Manager, how to uninstall the software, about settings that differ by the scanning method, how to purchase/clean the Carrier Sheet and the ScanSnap installation specifications.



About Maintenance

Contact your FUJITSU scanner dealer or an authorized FUJITSU scanner service provider for repairs on this product.



Read this manual in order starting from "ScanSnap Overview" through "Using the ScanSnap" for a better understanding of ScanSnap operations.

Symbols Used in This Manual

The following indications are used in this manual to obviate any chance of accident or damage to you and people near you, and your property. Warning labels indicate the warning level and statements. The symbols indicating warning levels and their meanings are as follows.

Indication	Description
	This indication alerts operators to an operation that, if not strictly observed, may result in severe injury or death.
	This indication alerts operators to an operation that, if not strictly observed, may result in safety hazards to personnel or damage to the product.

Besides warning indicators, the following symbols are also used in this manual.

Symbol	Description
	This symbol indicates operations using Windows.
	This symbol indicates operations using Mac OS.

Arrow Symbols in This Manual

Right-arrow symbols [→] are used to connect icons or menu options you should select in succession.

Example: Select [Start] menu → [Computer].

Screen Examples in This Manual



Windows screen



Microsoft product screenshots are reprinted with permission from Microsoft Corporation.

The screenshots used in this manual are of Windows 7.

The actual windows and operations may differ depending on the operating system.

- Icon in the notification area

The ScanSnap Manager icon  is displayed in the menu which appears when you click  in the notification area.

To have the ScanSnap Manager icon  always displayed in the notification area, drag the icon  and drop it onto the notification area.

The notification area is located at the far right of the taskbar.

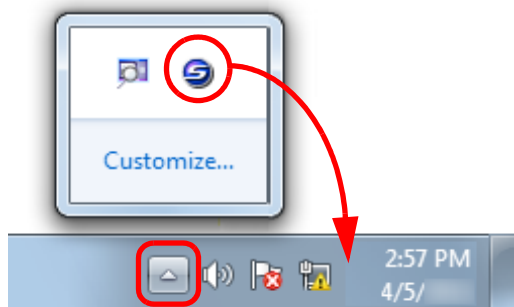

The explanations in the manual use the case in which the ScanSnap Manager icon  is always displayed in the notification area.

Mac OS screen

The screenshots used in this manual are of Mac OS X v10.7.

The actual windows and operations may differ depending on the operating system.

The screen examples in this manual are subject to change without notice in the interest of product development.

If the actual screen differs from the screen examples in this manual, operate by following the actual displayed screen.

For Windows 8 Users

To start ScanSnap applications or display Control Panel, use the All apps screen. The All apps screen is displayed by following the procedure below.

1. Right-click the Start screen.
2. Click [All apps] on the app bar.

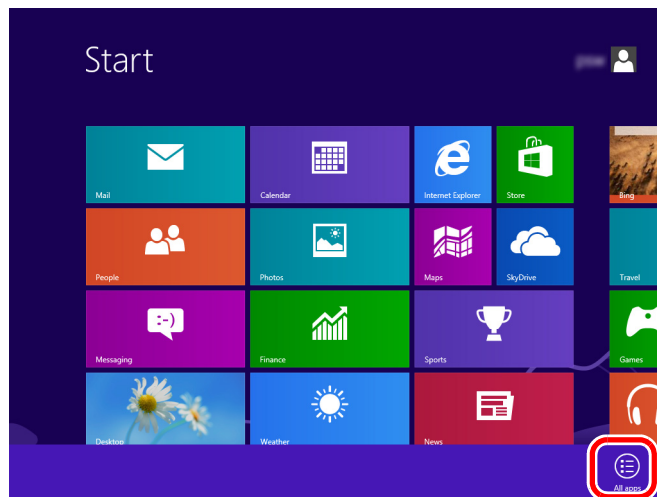

Abbreviations Used in This Manual

The following abbreviations are used in this manual:

Abbreviation Used	Designation
Windows 8	Windows [®] 8 operating system, English Version Windows [®] 8 Pro operating system, English Version Windows [®] 8 Enterprise operating system, English Version
Windows 7	Windows [®] 7 Starter operating system, English Version Windows [®] 7 Home Premium operating system, English Version Windows [®] 7 Professional operating system, English Version Windows [®] 7 Enterprise operating system, English Version Windows [®] 7 Ultimate operating system, English Version
Windows Vista	Windows Vista [®] Home Basic operating system, English Version Windows Vista [®] Home Premium operating system, English Version Windows Vista [®] Business operating system, English Version Windows Vista [®] Enterprise operating system, English Version Windows Vista [®] Ultimate operating system, English Version
Windows XP	Windows [®] XP Home Edition operating system, English Version Windows [®] XP Professional operating system, English Version
Windows	Windows 8, Windows 7, Windows Vista, or Windows XP operating system
Microsoft Office	Microsoft [®] Office
Word	Microsoft [®] Word 2013 Microsoft [®] Word 2010 Microsoft [®] Office Word 2007 Microsoft [®] Office Word 2003 Microsoft [®] Word for Mac 2011 Microsoft [®] Word 2008 for Mac Microsoft [®] Word 2004 for Mac
Excel	Microsoft [®] Excel [®] 2013 Microsoft [®] Excel [®] 2010 Microsoft [®] Office Excel [®] 2007 Microsoft [®] Office Excel [®] 2003 Microsoft [®] Excel [®] for Mac 2011 Microsoft [®] Excel [®] 2008 for Mac Microsoft [®] Excel [®] 2004 for Mac

Abbreviation Used	Designation
PowerPoint	Microsoft® PowerPoint® 2013 Microsoft® PowerPoint® 2010 Microsoft® Office PowerPoint® 2007 Microsoft® Office PowerPoint® 2003 Microsoft® PowerPoint® for Mac 2011 Microsoft® PowerPoint® 2008 for Mac Microsoft® PowerPoint® 2004 for Mac
SharePoint	Microsoft® SharePoint® Server 2010, English Version Microsoft® Office SharePoint® Server 2007, English Version Microsoft® Office SharePoint® Portal Server 2003, English Version Microsoft® SharePoint® Foundation 2010, English Version Microsoft® Windows® SharePoint® Services 2.0/3.0, English Version
Internet Explorer	Windows® Internet Explorer® Microsoft® Internet Explorer®
Windows Live Mail	Windows Live™ Mail
Windows Mail	Microsoft® Windows® Mail
Outlook	Microsoft® Outlook® 2013 Microsoft® Outlook® 2010 Microsoft® Office Outlook® 2007 Microsoft® Office Outlook® 2003
Outlook Express	Microsoft® Outlook® Express
Outlook for Mac	Microsoft® Outlook® for Mac
.NET Framework	Microsoft® .NET Framework
Entourage	Microsoft® Entourage®
Mac OS	OS X v10.8, Mac OS X v10.7, or Mac OS X v10.6
Adobe Acrobat	Adobe® Acrobat®
Adobe Reader	Adobe® Reader®
ABBYY FineReader for ScanSnap	ABBYY FineReader for ScanSnap™ All the descriptions in this manual assume the usage of ABBYY FineReader for ScanSnap bundled with the ScanSnap. Unless otherwise specified, the term ABBYY FineReader for ScanSnap refers to the ABBYY FineReader for ScanSnap bundled with the ScanSnap. Note that ABBYY FineReader for ScanSnap may be upgraded without notice. If the descriptions differ from the actual displayed screens, refer to ABBYY FineReader for ScanSnap Help.
Google Docs	Google Docs™
Android	Android™
WPS	Wi-Fi Protected Setup™

Abbreviation Used	Designation
Wireless access point	Wireless access point Wireless router
ScanSnap	Color Image Scanner ScanSnap iX500
Carrier Sheet	ScanSnap Carrier Sheet

Table of Contents

- Introduction 2**
 - Safety Information..... 2**
 - Trademarks 2**
 - Manufacturer..... 3**
 - Manuals 4**
 - Structure of This Manual 9**
 - Symbols Used in This Manual..... 10**
 - Arrow Symbols in This Manual 10**
 - Screen Examples in This Manual..... 11**
 - For Windows 8 Users..... 12**
 - Abbreviations Used in This Manual..... 13**

- ScanSnap Overview 22**
 - Features of the ScanSnap 23**
 - Simple 23
 - Speedy 23
 - Compact..... 24
 - Use in a Manner That Best Suits Your Intended Use 24
 - Linkage Functions to Increase Range of Useful Applications 25
 - Save Data to a Computer via Wireless LAN 25
 - Save Data Easily to Mobile Devices 26
 - Easy Linkage with Cloud Services 26
 - Creating Data According to Intended Application 27
 - Scan Easily Using Automatic Functions 29
 - Bundled Software Can Be Used with Various Applications 30
 - Other Useful Functions 31

Parts and Functions	32
Front.....	32
Back	34
ScanSnap Manager Overview	35
ScanSnap Manager Icon	35
Right-Click Menu (Windows).....	37
ScanSnap Manager Menu (Mac OS).....	39
Quick Menu	41
How to Perform a Scan	42
Scan from a Computer	42
Scan from a Wireless LAN-connected Mobile Device	44
Turning the ScanSnap ON/OFF	45
Turning the ScanSnap ON.....	45
Turning the ScanSnap OFF	47
Sleep Mode	48
Automatic Power OFF.....	49
Connecting the ScanSnap to a Wireless LAN	50
Preparation	51
Set a Wireless LAN Using the ScanSnap Wireless Setup Tool.....	52
Connect a Computer to the ScanSnap	54
Connect a Mobile Device to the ScanSnap	55
Reconnect to a Wireless Access Point Using the ScanSnap WPS Button.....	56
Documents for Scanning	58
Conditions for Documents to Scan	58
Conditions for Using the Carrier Sheet	60
How to Load Documents	63
Installing the Software	68
Bundled Software Overview	69
System Requirements	71
Windows	71
Mac OS	74

Installing in Windows	76
How to Install the Software	76
ScanSnap Software	78
Dropbox for Windows.....	83
Evernote for Windows.....	85
SugarSync Manager for Windows	88
Scan to Microsoft SharePoint	90
Trial Software.....	92
Adobe Acrobat	94
Installing in Mac OS	96
How to Install the Software	96
ScanSnap Software	98
ABBYY FineReader Express Edition for Mac	103
Dropbox for Mac	106
Evernote for Mac.....	108
SugarSync Manager for Mac	111
Using the ScanSnap (for Windows Users)	113
Basic Scanning Operation Flow	114
Selecting a Profile Depending on the Document	114
Scanning	116
Stopping the Scan.....	118
Using ScanSnap with the Quick Menu	119
Saving Data in ScanSnap Organizer	124
Storing Business Cards in CardMinder.....	127
Saving Data in a Specified Folder.....	131
Attaching Files to E-Mail	137
Using the ScanSnap as a Copy Machine	142
Saving Data in Rack2-Filer Smart.....	146
Saving Data in Magic Desktop.....	150
Saving Data to a Mobile Device.....	152
Saving Data to Your Dropbox Folder	161
Saving Documents to Evernote	165
Saving Handwritten Notes to Evernote	169
Saving Documents to Google Docs	172
Posting to Salesforce Chatter	177
Saving Data to Your SugarSync Folder	183
Converting into Word/Excel/PowerPoint Documents.....	188

Saving Data in SharePoint.....	195
Saving Data to Picture Folder	199
Profile	203
How to Configure Scan Settings	204
Profile Management.....	204
How to Perform a Scan.....	213
ScanSnap Folder Operations	216
How to Configure Scan Settings	217
How to Perform a Scan.....	217
Creating Scanned Images Depending on Intended Use	222
Scanning Only One Side of a Document	222
Scanning Color Documents in Gray or Black & White	224
Scanning Color Documents in High Compression	226
Deleting Blank Pages.....	228
Correcting Skewed Character Strings.....	230
Rotating the Scanned Image to its Correct Orientation	232
Reducing Bleed-Through	234
Scanning Documents of Different Widths or Lengths in One Batch	236
Scanning Documents Larger Than A4/Letter Size.....	240
Scanning Documents Such as Photographs and Clippings.....	245
Long Page Scanning.....	249
Saving Scanned Images in Multiple PDF Files	251
Creating Searchable PDF Files	253
Setting Keywords in PDF Files	256
Setting Passwords for PDF Files	262
Creating PDF/A Files	266
Configuring ScanSnap Manager.....	268
How to Configure Scan Settings	268
Quick Menu Settings.....	271
Automatic Linkage with Applications.....	276
ScanSnap's Communication Status.....	280
Showing the Scanning Progress.....	283
Using the ScanSnap (for Mac OS Users).....	285
Basic Scanning Operation Flow	286
Selecting a Profile Depending on the Document	286
Scanning	288

Stopping the Scan.....	290
Using ScanSnap with the Quick Menu	291
Saving Data in a Specified Folder.....	295
Attaching Files to E-Mail	299
Using the ScanSnap as a Copy Machine	304
Creating Searchable PDF Files	308
Storing Business Cards in CardMinder.....	316
Saving Data to a Mobile Device.....	320
Saving Data to Your Dropbox Folder	333
Saving Documents to Evernote	337
Saving Handwritten Notes to Evernote	341
Saving Documents to Google Docs	344
Posting to Salesforce Chatter	349
Saving Data to Your SugarSync Folder	355
Converting into Word/Excel/PowerPoint Documents.....	359
Saving Scanned Images in iPhoto	366
Profile	369
How to Configure Scan Settings	370
Profile Management.....	370
How to Perform a Scan.....	379
Creating Scanned Images Depending on Intended Use	381
Scanning Only One Side of a Document	381
Scanning Color Documents in Gray or Black & White	383
Deleting Blank Pages.....	385
Correcting Skewed Character Strings.....	387
Rotating Scanned Image to its Correct Orientation	389
Reducing Bleed-Through	391
Scanning Documents of Different Widths or Lengths in One Batch	393
Scanning Documents Larger Than A4/Letter Size.....	397
Scanning Documents Such as Photographs and Clippings.....	402
Long Page Scanning.....	406
Saving Scanned Images in Multiple PDF Files	408
Creating Searchable PDF Files	410
Setting Keywords in PDF Files	414
Saving Two Files or Pages into One Double-Page Spread Image	420
Configuring ScanSnap Manager.....	421
How to Configure Scan Settings	421

Quick Menu Settings	424
Automatic Linkage with Applications.....	430
ScanSnap's Communication Status.....	432
Showing the Scanning Progress.....	435
Troubleshooting	437
Daily Care	438
Cleaning Materials.....	439
Cleaning the Outside of the ScanSnap	440
Cleaning the Inside of the ScanSnap	441
Consumables	446
Part Numbers and Replacement Cycle of Consumables	447
Replacing the Roller Set.....	450
Appendix	457
ScanSnap Online Update.....	458
Uninstalling the Software	460
Uninstalling in Windows	460
Uninstalling in Mac OS.....	462
Setting Items by Scanning Method.....	468
Purchasing/Cleaning the Carrier Sheet.....	476
Purchasing the Carrier Sheet.....	476
Cleaning the Carrier Sheet	477
Wireless LAN Specifications.....	478
Installation Specifications	479
About Maintenance	480
Index	481

ScanSnap Overview

This chapter explains important items you should know before operating ScanSnap.

Features of the ScanSnap	23
Parts and Functions	32
ScanSnap Manager Overview	35
How to Perform a Scan	42
Turning the ScanSnap ON/OFF	45
Connecting the ScanSnap to a Wireless LAN	50
Documents for Scanning	58
How to Load Documents	63

Features of the ScanSnap

The main features of the ScanSnap are as follows:

Simple

Turn documents into digital data by just pressing the [Scan] button

By converting paper documents cluttering up your desk into PDF or JPEG files, you can conveniently view, edit, manage and archive the documents in your computer.

The Quick Menu makes the operation easy even for beginners

The Quick Menu will allow you to start using the ScanSnap right away even if it is your first time. Simply press the [Scan] button on the scanner to scan your document, and then the Quick Menu will appear where you can select the desired action.

 (→ [page 119](#))

 (→ [page 291](#))

Speedy

Speedy scanning

Double-sided color documents of A4 or Letter size can be scanned at approximately 25 sheets/minute.

HINT

Scan test system and scan settings are as shown below.

- Scan test system

Intel® Core™ i5 2.5GHz or higher processor, 4 GB or more memory



Windows 8, Windows 7, Windows Vista, or Windows XP operating system



OS X v10.8, Mac OS X v10.7, or Mac OS X v10.6

- Scan settings

Default settings

When the default settings are not used, and scanning is performed under the following conditions, scanning speed may slow down.

- When scanning documents in [B&W] (black & white) mode
Example: Scanning color brochures in [B&W] mode (converting a color image to black & white)
- When [Deskew by text on document] is enabled
- When creating a searchable PDF file

Scanning speed may also slow down when you have enabled other functions.

Compact

Small size saves desktop space

Smaller than an A4 or Letter size paper, the ScanSnap does not require much desktop space.

Use in a Manner That Best Suits Your Intended Use

Compatible with both Windows and Mac OS

You can use the ScanSnap in a manner that best suits your intended use in either Windows or Mac OS.

ATTENTION

The following functions are not available for Mac OS:

- ScanSnap Folder
- Color high compression
- Place document face up
- Output in PDF/A-1b
- Set a password for PDF file

Linkage Functions to Increase Range of Useful Applications

E-mail or print a scanned image directly from scanning

You can attach the scanned image to an e-mail without needing any additional application or print it out instead of using a copy machine.

Windows

- Attach to e-mail (→ [page 137](#))
- Print (→ [page 142](#))

Mac OS

- Attach to e-mail (→ [page 299](#))
- Print (→ [page 304](#))

Share documents converted into digital data with others

You can conveniently share documents by saving the scanned image directly in SharePoint.

 (→ [page 195](#))

Save Data to a Computer via Wireless LAN

Save documents converted into digital data to a computer

By connecting the ScanSnap to a computer via wireless LAN, you can save the image data in the computer.

Use the ScanSnap Wireless Setup Tool to connect the ScanSnap to a wireless LAN.

Once the ScanSnap is connected to a wireless LAN, even if the computer is away from the ScanSnap, you can use the ScanSnap in the same way as using the ScanSnap connected to a USB cable.

- Connecting the ScanSnap to a wireless LAN (→ [page 50](#))
- ScanSnap Wireless Setup Tool (→ ScanSnap Wireless Setup Tool Help).

ATTENTION

Only one computer can be connected to the ScanSnap.

Save Data Easily to Mobile Devices

Save documents converted into digital data to a mobile device

Scanned image can be saved to mobile devices such as tablet devices and smartphones using wireless LAN.

You can receive the scanned image sent from your computer on a mobile device, or use the ScanSnap from a mobile device to receive the scanned image directly.

Windows

- Save scanned images to a mobile device via your computer (→ [page 152](#))
- Save directly to a mobile device (→ ScanSnap Connect Application User's Guide)

Mac OS

- Save scanned images to a mobile device via your computer (→ [page 320](#))
- Save directly to a mobile device (→ ScanSnap Connect Application User's Guide)

Easy Linkage with Cloud Services

Access documents converted into digital data anytime, anywhere

ScanSnap Manager can be linked with the following cloud services. Through linkage with these services, you can access scanned images anytime from your computer or smartphone no matter where you are.

- Dropbox
- Evernote
- Google Docs
- Salesforce Chatter
- SugarSync

Windows (→ [page 122](#))

Mac OS (→ [page 293](#))

HINT

"Cloud services" refer to services that allow the user to save documents or photos that have been converted into digital data to a network, and then access them when necessary from, for example, a computer or smartphone.

Creating Data According to Intended Application

Create searchable PDF files

You can create searchable PDF files by performing automatic text recognition for PDF files after scanning.

You can also perform text recognition on character strings marked by a highlight pen in black & white documents, and add them as keywords for the PDF file.

- Create searchable PDF files
 - Create using scan settings

By configuring scan settings to scan documents into searchable PDF files, you can link the searchable PDF files with various applications.

Windows (→ [page 253](#))

Mac OS (→ [page 410](#))
 - Create using the Quick Menu
 - **Windows**

You can create a searchable PDF file by using ScanSnap Organizer.
(→ ScanSnap Organizer Help)
 - **Mac OS**

You can create a searchable PDF file by using [Searchable PDF Converter].
(→ [page 308](#))
 - Create using ScanSnap Organizer **Windows**

You can use ScanSnap Organizer to convert a created PDF file to a searchable PDF file. When you convert multiple PDF files, you can convert the files more efficiently by using the idle time of the computer.

Windows (→ ScanSnap Organizer Help)
 - Create using [Searchable PDF Converter] **Mac OS**

You can use [Searchable PDF Converter] to convert created PDF files to searchable PDF files. When you convert multiple PDF files, you can convert the files more efficiently by using the idle time of the computer.

Mac OS (→ [page 313](#))
- Set keywords
 - Create using scan settings

By configuring scan settings to set a marked character string as a keyword for the PDF file, you can link keyword-set PDF files with various applications.

Windows (→ [page 256](#))

Mac OS (→ [page 414](#))

- Create using ScanSnap Organizer **Windows**
You can use ScanSnap Organizer to create a PDF file with marked character strings as keywords.
Windows (→ ScanSnap Organizer Help)
- Create using [Searchable PDF Converter] **Mac OS**
You can use [Searchable PDF Converter] to create a PDF file in which character strings in the marked sections are set as keywords.
Mac OS (→ ScanSnap Manager Help)

Two separate scanned images can be merged into a single image

Two scanned images can be merged into a single image either vertically or horizontally.

Windows (→ ScanSnap Organizer Help)

Mac OS (→ ScanSnap Manager Help)

Create PDF/A files **Windows**

You can create PDF files that conform to PDF/A-1b which is a suitable file format when you need to store image data for a long time.

Windows (→ [page 266](#))

Scan Easily Using Automatic Functions

Automatically recognize color and black & white documents (Auto color detection)

The ScanSnap determines the color mode of each document, saves color documents in color, black & white documents in black & white, and black & white documents with photos or illustrations in grayscale. This function will optimize your PDF file size.

Scan different size documents together (Automatic page size detection, Carrier Sheet mixed batch scanning)

Paper size is automatically recognized so that you do not need to change the paper size setting. The bundled Carrier Sheet allows you to scan documents larger than A4/Letter size as well as photographs and clippings. Multiple Carrier Sheets can be scanned at once and together with regular documents in the same batch.

Windows

- Automatic size detection (→ [page 236](#))
- Carrier Sheet (→ [page 240](#))

Mac OS

- Automatic size detection (→ [page 393](#))
- Carrier Sheet (→ [page 397](#))

Automatically set the resolution by the paper size (Automatic resolution function)

Documents are scanned at 300 dpi at first, then the image is saved at 300 dpi if the document length is 148 mm (5.83 in.) or less, and converted to 200 dpi for longer documents. When linked with a text recognition application (e.g. for scanning business cards), you can save high resolution image data without having to change the scan settings.

Bundled Software Can Be Used with Various Applications

Organize and manage scanned images

You can use ScanSnap Organizer to organize and manage scanned images.

- Setting a keyword (Intelligent Indexing)
Keywords can be set by the following methods:
 - Recognize a character string on a page (OCR) and set as a keyword (Zone OCR)
 - Set any character string as a keyword
 - Set a marked character string as a keyword (Marker Index)
 - Drag and drop a keyword from the keyword list (Keyword Addition by Drag&Drop)
 The keywords can be viewed in thumbnails. (Keyword Overlay)
- Distributing files by keyword (Automatic Keyword Sort)
Files can also be sorted into folders according to the keyword set for files as a sorting condition.
- Search a variety of files (Search Engine Selection)
Files can be found quickly searched by file name, keyword, text or date.
- Cropping marked sections (Intelligent Cropping)
Selections on a page that are marked with a highlight pen can be cut and pasted elsewhere to create scrapbooks.

 (→ [ScanSnap Organizer Help](#))

Easy filing of business cards

Text recognition can be performed on business cards which then can be easily converted into digital data with the business card application. With CardMinder, you can create a database which facilitates data search of business cards converted into digital data.

The business card application is as follows:

 CardMinder (→ [page 127](#))

 CardMinder (→ [page 316](#))

Convert paper documents into Word/Excel/PowerPoint files

Use the "ABBYY FineReader for ScanSnap" to directly convert the scanned image into a Word/Excel/PowerPoint file.

 (→ [page 188](#))

 (→ [page 359](#))

Other Useful Functions

Link with a wide variety of applications by using ScanSnap

Folder

You can use ScanSnap Folder to link with a wide variety of applications, including Web applications (e.g. Webmail, cloud service).

By selecting ScanSnap Folder from the file selection window of the application, you can use the scanned image file directly.

 (→ [page 216](#))

Note: The ScanSnap does not conform to the TWAIN, ISIS and WIA standards.

Parts and Functions

This section explains names and functions of the ScanSnap parts.

Front

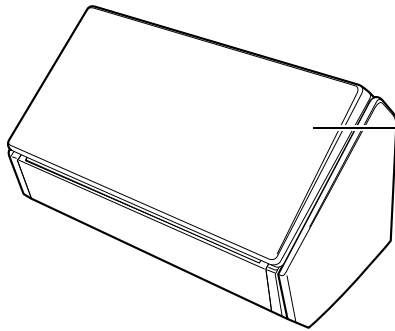

ADF paper chute (cover) (*)

Open to use the ScanSnap.

⇒ Opening the ADF paper chute (cover) turns on the ScanSnap.

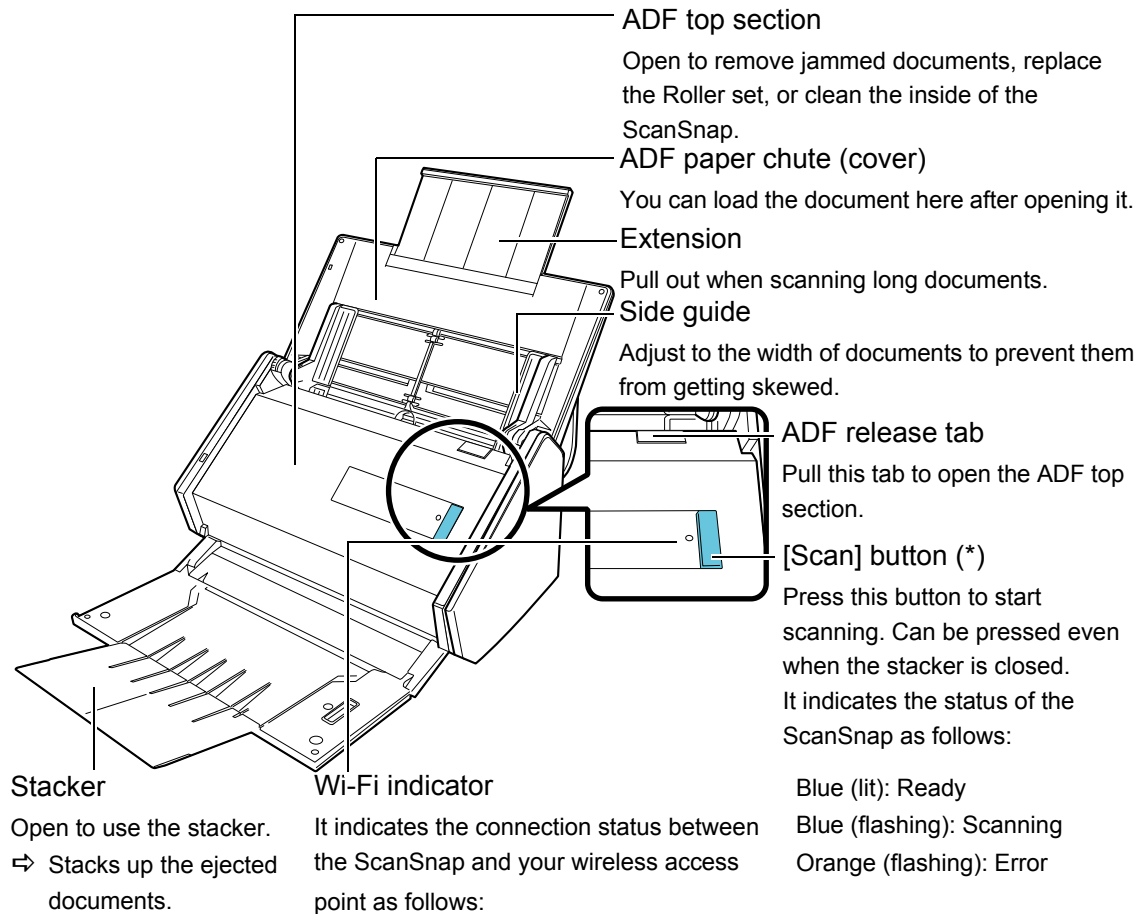

* : When the ScanSnap has turned off automatically because of the automatic power off function, either press the [Scan] button (this will not start scanning), or close the ADF paper chute (cover), then open it again to turn the ScanSnap back on. For details, refer to ["Automatic Power OFF" \(page 49\)](#).

Back

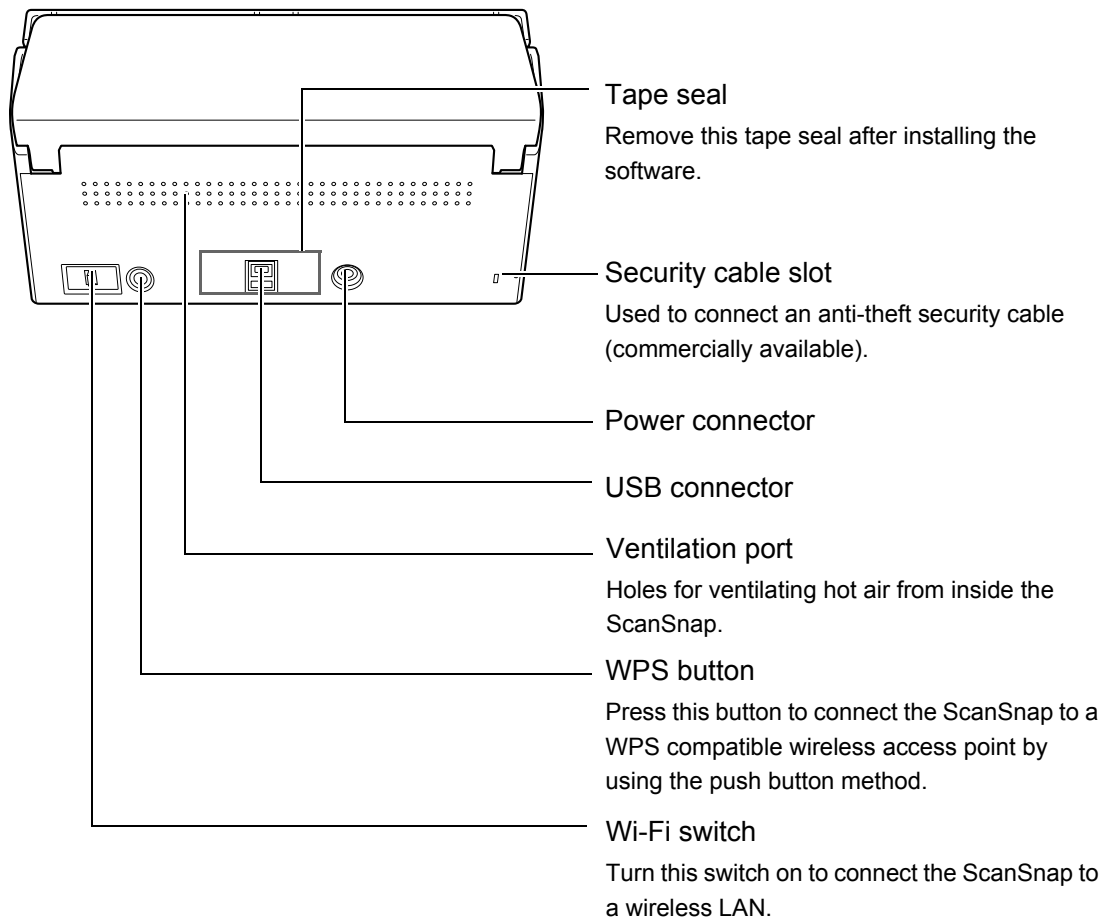

ScanSnap Manager Overview

The ScanSnap Manager is a scanner driver that is required to scan documents with the ScanSnap. The scanned image can be saved as a PDF or JPEG file to a computer. All operations on the ScanSnap are managed in ScanSnap Manager.











ScanSnap Manager Icon

When ScanSnap Manager is running, the ScanSnap Manager icon appears as follows:

 Notification area

 Dock

The ScanSnap Manager icon indicates whether or not ScanSnap Manager is successfully communicating with the ScanSnap. The appearance of the icon changes according to the communication status as shown below.

Status	ScanSnap Manager icon	
		
Communicating		
Not communicating		
Connected to a computer via a wireless LAN		
Connected to a mobile device via a wireless LAN		

HINT

- Turn the ScanSnap on to perform communication between ScanSnap Manager and ScanSnap. For details about how to turn on the ScanSnap, refer to ["Turning the ScanSnap ON/OFF" \(page 45\)](#).

Mac OS

When you add the ScanSnap Manager icon to the Dock,  is constantly displayed.

A blue light appears under the ScanSnap Manager icon when ScanSnap Manager is running.



You can display the menu for scanning documents and ScanSnap Manager settings from the ScanSnap Manager icon.

Windows

- Right-clicking
Displays the Right-Click Menu.
For details, refer to ["Right-Click Menu \(Windows\)" \(page 37\)](#).
- Left-clicking
Displays the Left-Click Menu.
For details, refer to ["Profile" \(page 203\)](#).

Mac OS

- Clicking while pressing the [control] key on the keyboard
Displays the ScanSnap Manager menu.
For details, refer to ["ScanSnap Manager Menu \(Mac OS\)" \(page 39\)](#).
- Clicking
Displays the Profile menu.
For details, refer to ["Profile" \(page 369\)](#).

Right-Click Menu (Windows)

This menu appears when you right-click the ScanSnap Manager icon .

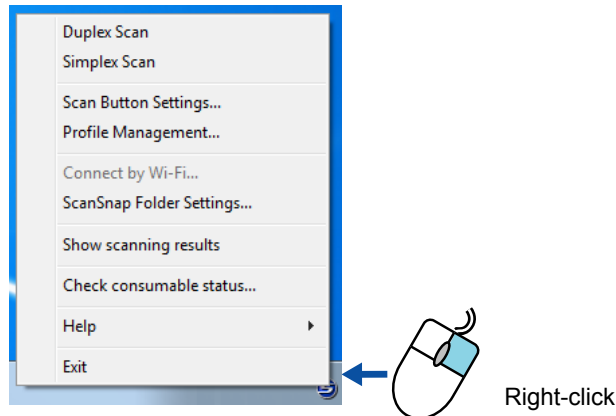

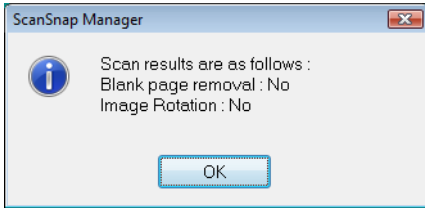
Item	Function
Duplex Scan	Scans both sides of the document. Follows the settings configured in [Scan Button Settings].
Simplex Scan	Scans only one side of the document. Follows the settings configured in [Scan Button Settings].
Scan Button Settings	Displays the ScanSnap setup dialog box. You can configure the scan settings in this dialog box. "How to Configure Scan Settings" (page 268)
Profile Management	Displays the [ScanSnap Manager - Profile Management] dialog box. You cannot select [Profile Management] when the [Use Quick Menu] check box is selected in the ScanSnap setup dialog box. "Profile Management" (page 204)
Connect by Wi-Fi	Displays the [ScanSnap Manager - Connect by Wi-Fi] dialog box. You can connect the ScanSnap to a computer via wireless LAN. You cannot select [Connect by Wi-Fi] when the ScanSnap is connected to a computer via a USB cable. "Connect a Computer to the ScanSnap" (page 54)
ScanSnap Folder Settings	Displays the ScanSnap setup dialog box. You can configure the scan settings for using ScanSnap Folder in this dialog box. "How to Configure Scan Settings" (page 268)
Show scanning results	After scanning is completed, a message appears to inform you whether blank pages are removed or the image is rotated. 

Item	Function
Check consumable status	Displays the [ScanSnap Manager - Check consumable status] dialog box. You can reset the consumable counters after replacing the consumables. "Consumables" (page 446)
Help	Displays the following menu: <ul style="list-style-type: none"> ● Help Opens the ScanSnap Manager Help. ● Troubleshooting Displays [Troubleshooting] in the ScanSnap Manager Help. ● ScanSnap Portal Site Opens the ScanSnap global homepage (http://scansnap.fujitsu.com/). ● About ScanSnap Manager Displays the [ScanSnap Manager - Version Information] dialog box. ● Preferences Displays the [ScanSnap Manager - Preferences] dialog box. ● Online Update Starts the ScanSnap Online Update (page 458).
To establish connection	Displayed when ScanSnap Manager is not communicating with the ScanSnap correctly.
Exit	Exits ScanSnap Manager. "Exiting ScanSnap Manager" (page 48)

ScanSnap Manager Menu (Mac OS)

This menu appears when you click the ScanSnap Manager icon  while pressing the [control] key on the keyboard.

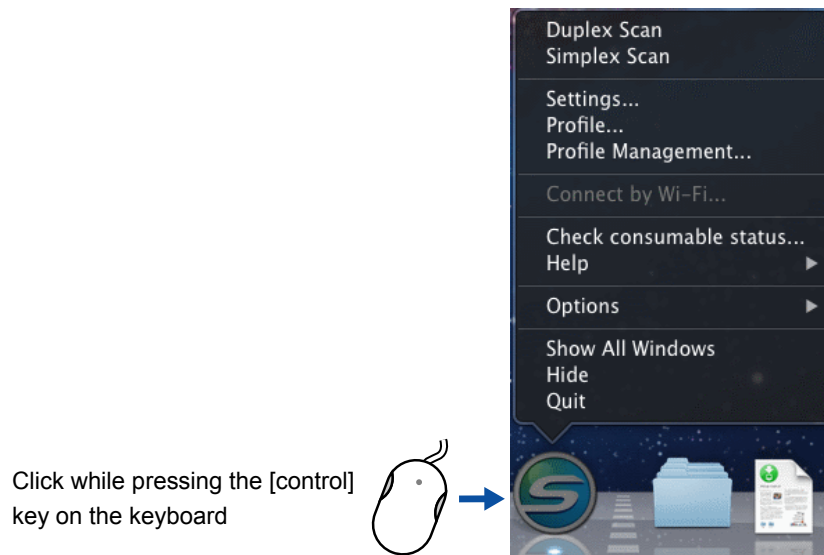

Item	Function
Duplex Scan	Scans both sides of the document. Follows the settings configured in [Settings].
Simplex Scan	Scans only one side of the document. Follows the settings configured in [Settings].
Settings	Displays the ScanSnap setup window. You can configure the scan settings in this window. "How to Configure Scan Settings" (page 421)
Profile	Displays the Profile menu. You cannot select [Profile] when the [Use Quick Menu] checkbox is selected in the ScanSnap setup window. "Profile" (page 369)
Profile Management	Displays the [ScanSnap Manager - Profile Management] window. You cannot select [Profile Management] when the [Use Quick Menu] checkbox is selected in the ScanSnap setup window. "Profile Management" (page 370)
Connect by Wi-Fi	Displays the [ScanSnap Manager - Connect by Wi-Fi] dialog box. You can connect the ScanSnap to a computer via wireless LAN. You cannot select [Connect by Wi-Fi] when the ScanSnap is connected to a computer via a USB cable. "Connect a Computer to the ScanSnap" (page 54)
Check consumable status	Displays the [ScanSnap Manager - Check consumable status] window. You can reset the consumable counters after replacing the consumables. "Consumables" (page 446)

Item	Function
Help	Displays the following menu: <ul style="list-style-type: none"> ● Help Opens the ScanSnap Manager Help. ● Troubleshooting Displays [Troubleshooting] in the ScanSnap Manager Help. ● ScanSnap Portal Site Opens the ScanSnap global homepage (http://scansnap.fujitsu.com/). ● About ScanSnap Manager Displays the [ScanSnap Manager - Version Information] window. ● Preferences Displays the [ScanSnap Manager - Preferences] window. ● Online Update Starts the ScanSnap Online Update (page 458).
To establish connection	Displayed when ScanSnap Manager is not communicating with the ScanSnap correctly.
Options	Displays the following menu: <ul style="list-style-type: none"> ● Keep in Dock Adds the ScanSnap Manager icon  to the Dock. ● Open at Login Automatically launches ScanSnap Manager when the computer is started up or logged in. ● Show in Finder Displays the contents of the [ScanSnap] folder by using the Finder.
Show All Windows (*)	Displays all windows from ScanSnap Manager in thumbnails.
Hide/Show	Hides or redisplay all windows of ScanSnap Manager that are being displayed.
Quit	Exits ScanSnap Manager. "Exiting ScanSnap Manager" (page 48)

* : Displayed for Mac OS X v10.7 or later.

Quick Menu

Simply press the [Scan] button on the scanner to scan your document, and the following Quick Menu will appear. Just select the application you want to link, and you can create and manage scanned images.

Windows



Mac OS



HINT

- For details about each application and how to perform scanning using the Quick Menu, refer to the following:
 - Windows** (→ [page 119](#))
 - Mac OS** (→ [page 291](#))
- The Quick Menu display mode and applications display order can be changed. For details, refer to the following:
 - Windows** (→ [page 271](#))
 - Mac OS** (→ [page 424](#))

How to Perform a Scan

This section explains how to use the ScanSnap to perform scanning.

You can scan documents in two different ways. Choose either way depending on your intended use of the scanned image.

- Scan from a computer (→ [page 42](#))
- Scan from a wireless LAN-connected mobile device (→ [page 44](#))

Scan from a Computer

Connect the ScanSnap to the computer using a USB cable or a wireless LAN, and scan the document.

For details about how to connect the ScanSnap to a computer via wireless LAN, refer to "[Connecting the ScanSnap to a Wireless LAN](#)" ([page 50](#)).

Scan from a computer according to the following procedures.

Scanning using the Quick Menu

After scanning the document using ScanSnap, you can simply select the application from the displayed menu to save, send as e-mail, or print the scanned image, as well as link the ScanSnap with an application or cloud services.

Scanning using the Quick Menu is set on default.

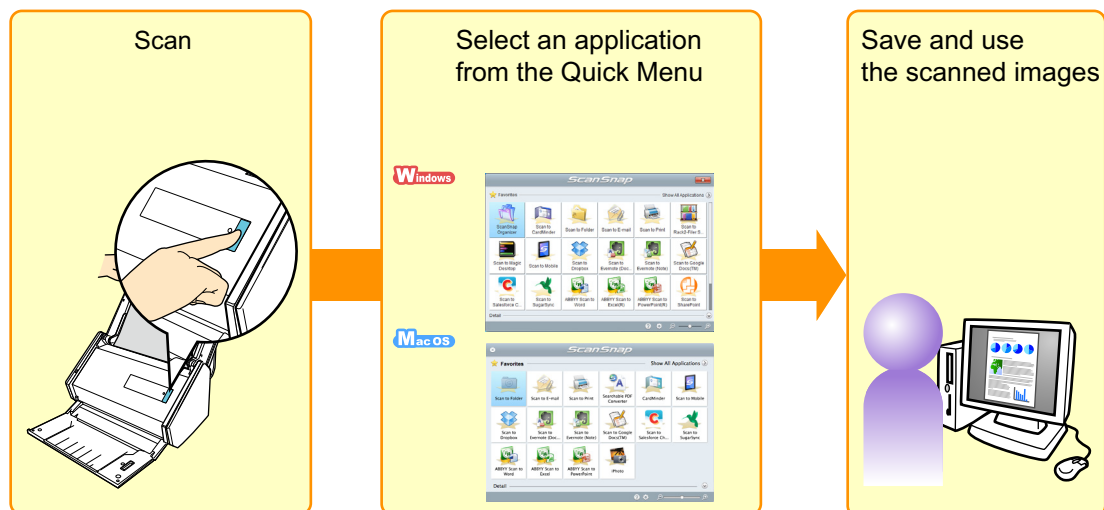

For details, refer to the following.

Windows (→ [page 119](#))

Mac OS (→ [page 291](#))

Scanning using a profile

Select a previously set profile (scan settings and linked application), and simply press the [Scan] button to scan the document and link with the application.

It is convenient to use when you want to scan a document using the same scan settings repeatedly.

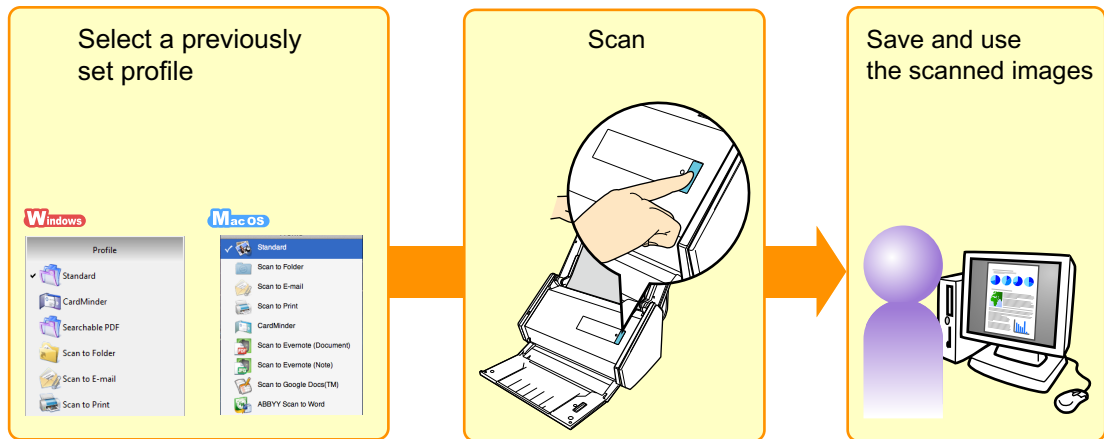

For details, refer to the following.

Windows (→ [page 203](#))

Mac OS (→ [page 369](#))

Scanning using ScanSnap Folder **Windows**

By selecting ScanSnap Folder from the file selection window of the application, you can scan a document from ScanSnap. You can use the scanned document file directly in the application.

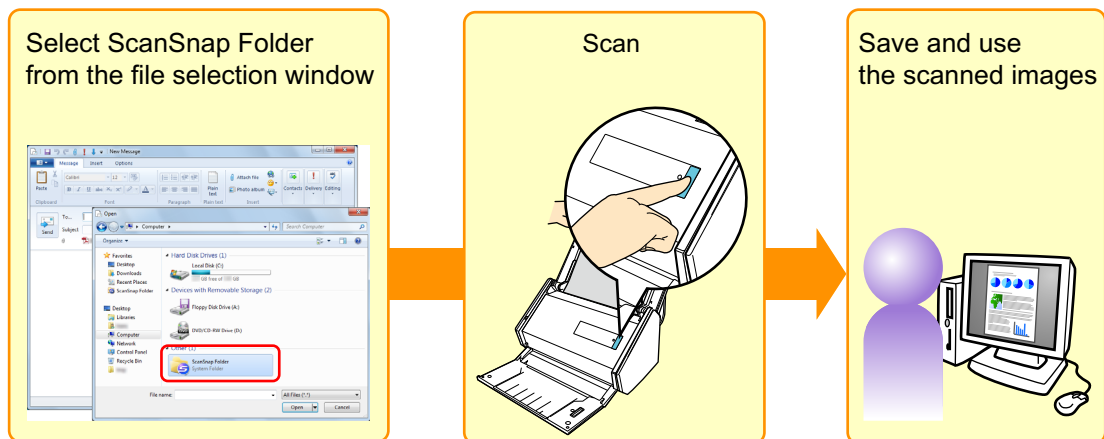

For details, refer to the following.

Windows (→ [page 216](#))

Scan from a Wireless LAN-connected Mobile Device

When ScanSnap Connect Application is installed on a mobile device, you can use the mobile device to scan documents with the ScanSnap connected to a wireless LAN. You can also specify document scan settings using ScanSnap Connect Application.

The scanned images can be received directly on the mobile device.

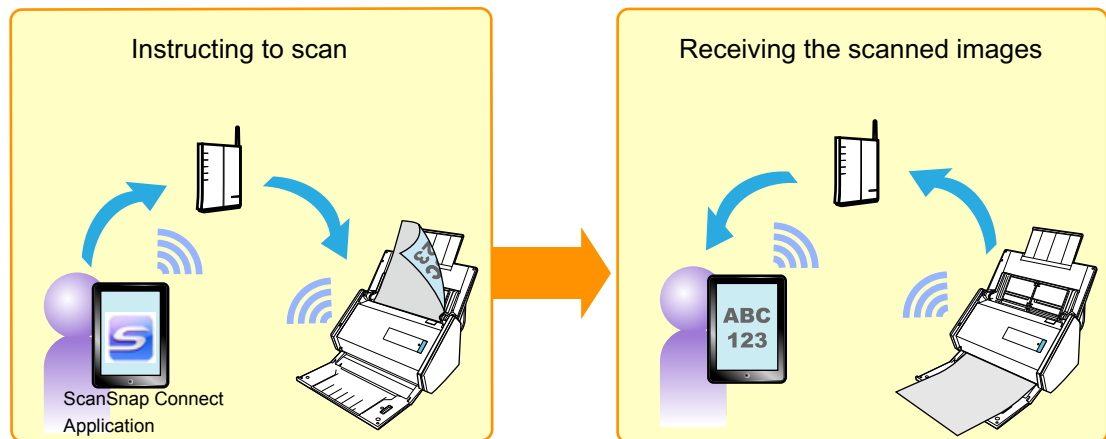

Refer to the following for details about how to connect the ScanSnap and a mobile device via wireless LAN and perform scanning.

- How to connect the ScanSnap and a mobile device via wireless LAN
["Connecting the ScanSnap to a Wireless LAN" \(page 50\)](#)
- How to scan from a mobile device
 ScanSnap Connect Application User's Guide for your mobile device

ATTENTION

The following differences exist between scanning a document from a computer, and scanning a document from a mobile device via wireless LAN.

- Image quality
- Recognition of document color
- Recognition of blank pages
- Detection of paper size

Turning the ScanSnap ON/OFF

This section explains how to turn the ScanSnap ON/OFF.

Turning the ScanSnap ON

1. Turn on the computer.

HINT



If you connect the ScanSnap and a mobile device via a wireless LAN and then scan a document, you do not have to turn on the computer.

Windows

⇒ The ScanSnap Manager icon  appears in the notification area when Windows starts up.



HINT

- If the ScanSnap Manager icon  is not displayed, select [Start] menu → [All Programs] → [ScanSnap Manager] → [ScanSnap Manager] (for Windows 8, right-click the Start screen, and select [All apps] on the app bar → [ScanSnap Manager] under [ScanSnap Manager]) to start up ScanSnap Manager.
- If ScanSnap Manager does not automatically start when you log on to your computer, register ScanSnap Manager in the following procedure:
 1. Click the ScanSnap Manager icon , and then select [Help] → [Preferences] from the menu that appears.
 - ⇒ The [ScanSnap Manager - Preferences] dialog box appears.
 2. In the [Auto Startup] tab, select the [Start up ScanSnap Manager when you log on] check box.

Mac OS

⇒ The ScanSnap Manager icon  appears in the Dock.

**HINT**

- If the ScanSnap Manager icon  is not displayed, from the sidebar in Finder, select [Applications] → [ScanSnap], and then double-click [ScanSnap Manager] to start up ScanSnap Manager.
- If ScanSnap Manager does not automatically start when you log on to your computer, select [Users & Groups] ([Accounts] on Mac OS X v10.6) → [Current User] ([My Account] on Mac OS X v10.6) → [Login Items] → [+] → [ScanSnap] → [ScanSnap Manager] in the [System Preferences] window to start up ScanSnap Manager.

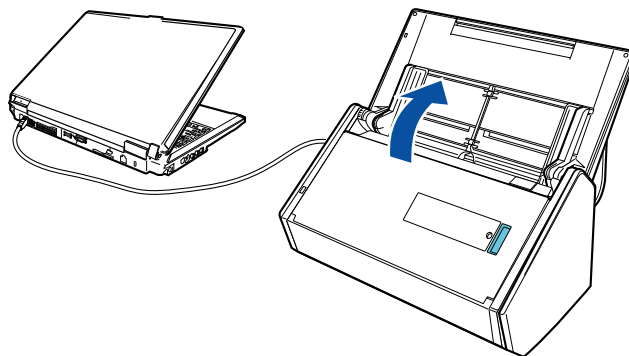

2. Open the ADF paper chute (cover) of the ScanSnap to turn the power on.





Example: When a USB cable is used for connection

⇒ The [Scan] button flashes in blue. The button returns to being lit normally when document scanning is enabled.

The ScanSnap Manager icon changes as shown below.





Windows From  to  ( when a wireless LAN is used for connection).

Mac OS From  to  ( when a wireless LAN is used for connection).

ATTENTION

With some computers, the initialization of the ScanSnap may be performed several times when the computer is started up.

HINT

There may be a slight delay before the ScanSnap Manager icon changes to  or  ( or  when a wireless LAN is used for connection) depending on your computer's performance, operating environment and load such as when multiple programs are running at the same time.

Turning the ScanSnap OFF

1. Close the ADF paper chute (cover).

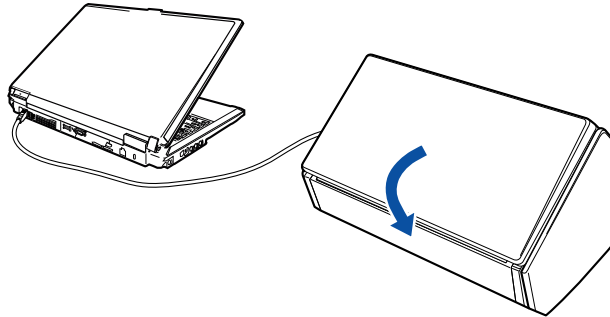

Example: When a USB cable is used for connection

⇒ The [Scan] button turns off.

The ScanSnap Manager icon changes as shown below.

Windows From  ( when a wireless LAN is used for connection) to .

Mac OS From  ( when a wireless LAN is used for connection) to .

ATTENTION

- Close the ADF paper chute (cover) after putting the extension back.
- If moving the ScanSnap, first turn the power OFF and remove all cables.
The bottom part of the ScanSnap may become hot when the ScanSnap is being used but this does not affect ScanSnap operation or cause any physical harm. Be careful not to drop the ScanSnap when carrying it.

HINT

- If the Wi-Fi switch is off, the power of the ScanSnap and the computer operate together. If you keep the ScanSnap connected to the computer, you do not have to worry about turning the power ON/OFF.
- With some computers, it may take 2 to 3 minutes until the light of the [Scan] button goes out after the computer is turned off.

Exiting ScanSnap Manager

You can exit ScanSnap Manager according to the following procedures. Normally, you do not have to exit ScanSnap Manager.

Windows

1. Select [Exit] from the Right-Click Menu.

For details about the Right-Click Menu, refer to ["Right-Click Menu \(Windows\)"](#) (page 37).

Mac OS

1. Select [Quit] from the ScanSnap Manager menu.

For details about the ScanSnap Manager menu, refer to ["ScanSnap Manager Menu \(Mac OS\)"](#) (page 39).

HINT

Start ScanSnap Manager again in the following procedure.

Windows

Select [Start] menu → [All Programs] → [ScanSnap Manager] → [ScanSnap Manager] (for Windows 8, right-click the Start screen, and select [All apps] on the app bar → [ScanSnap Manager] under [ScanSnap Manager]).

Mac OS

From the sidebar in Finder, select [Applications] → [ScanSnap], and then double-click [ScanSnap Manager].

Sleep Mode

When the ScanSnap has not been used for 14 minutes while the power is on, it enters sleep (power saving) mode.

The ScanSnap logo part to the left of the [Scan] button switches off in sleep mode.

Automatic Power OFF

When the ScanSnap is turned on and left unused for the specified time (default is "4 hours"), it will turn itself off automatically.

To turn the ScanSnap back on, perform one of the following operations:

- Press the [Scan] button on the ScanSnap (this will not start scanning)
- Close the ADF paper chute (cover) and open it again

HINT

- To continue using the ScanSnap, reset the time until auto power-off by performing one of the following:
 - Load a document in the ScanSnap
 - Press the [Scan] button on the ScanSnap
 - Close the ADF paper chute (cover) and open it again
- You can change the time until the ScanSnap automatically turns off, or set the ScanSnap to not automatically turn off. Set according to the following procedures:

Windows

1. Select [Help] → [Preferences] from the Right-Click Menu.
⇒ The [ScanSnap Manager - Preferences] dialog box appears.
2. In the [Power] tab, select one of the setting items for [Power off after].

Mac OS

1. Select [Help] → [Preferences] from the ScanSnap Manager menu.
⇒ The [ScanSnap Manager - Preferences] window appears.
 2. In the [Power] tab, select one of the setting items for [Power off after].
- A pop-up balloon or notification screen notifies you 5 minutes before the ScanSnap turns off automatically.

For details, refer to the following:

 (→ [page 280](#))

 (→ [page 432](#))

Connecting the ScanSnap to a Wireless LAN

By connecting the ScanSnap to a wireless LAN, you can scan documents with a computer or a mobile device. When a mobile device is used, a scanned image can be received directly to the mobile device.

Follow steps 1 through 3 to connect the ScanSnap to a wireless LAN.

1. Make preparations. (→ [page 51](#))

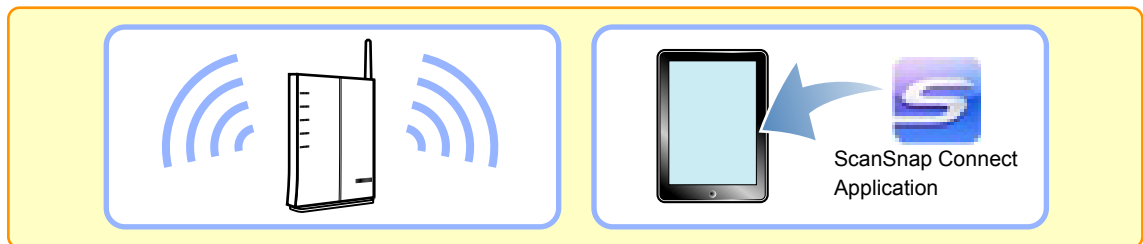

2. Configure wireless LAN connection settings. (→ [page 52](#))

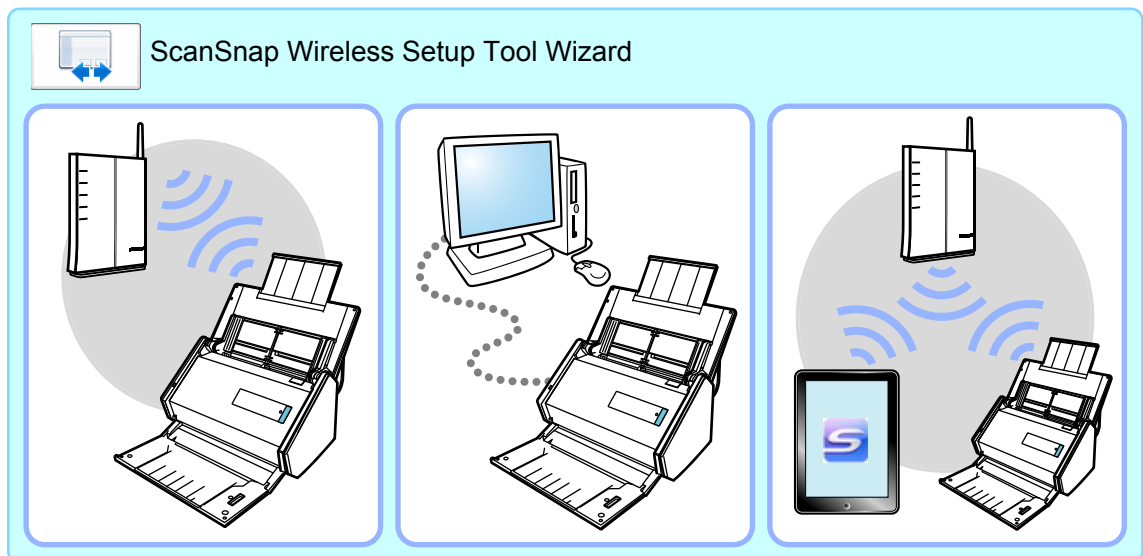

- Connecting the ScanSnap to a wireless access point
- Registering the connected computer
- Configuring the ScanSnap settings
- Checking the connection of a mobile device

3. Connect to the ScanSnap.

- Connect from a computer (→ [page 54](#))

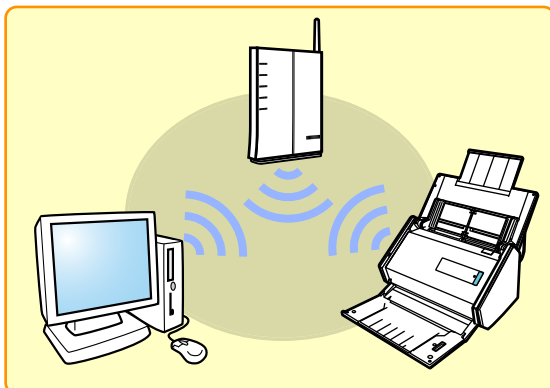

- Connect from a mobile device (→ [page 55](#))

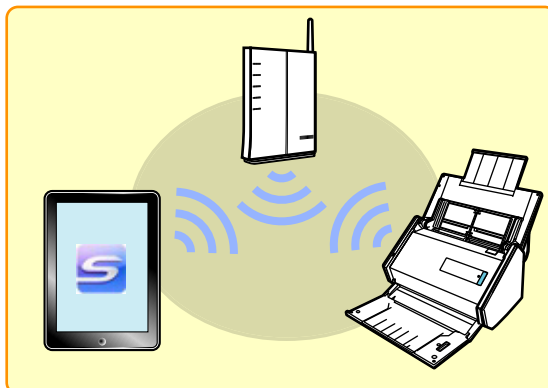

Preparation

To connect the ScanSnap to a wireless LAN, prepare the following:

- An environment in which a wireless LAN is available
When connecting the ScanSnap to a wireless LAN, you may need information for a wireless access point such as an SSID (network name) and a security key (password). For details, refer to the manual for the wireless access point.

ATTENTION

Do not place the following within 100 mm of the ScanSnap, or near your wireless access point.

- Obstacles that block radio waves (e.g. walls or metal plates)
 - Devices that cause radio wave interference (e.g. microwave ovens or cordless phones), or wireless devices
- ScanSnap Connect Application (when connecting the ScanSnap to a mobile device)
Install ScanSnap Connect Application on the mobile device that you want to connect. Download ScanSnap Connect Application for the mobile device from an application store such as iTunes/App Store or Google Play.

Set a Wireless LAN Using the ScanSnap Wireless Setup Tool

The ScanSnap Wireless Setup Tool is an application to configure the settings required for connecting your ScanSnap via wireless LAN in a wizard format. The ScanSnap Wireless Setup Tool can be used to configure and check the following wireless LAN settings.

- Connecting the ScanSnap to a wireless access point
- Registering the computer that will be connected to the ScanSnap via wireless LAN
- Setting the IP address, name, and password for the ScanSnap
- Checking the connection between the ScanSnap and the mobile device

Follow the procedure below to start the ScanSnap Wireless Setup Tool and configure the wireless settings.



- 1. Select [Start] menu → [All Programs] → [ScanSnap Manager] → [ScanSnap Wireless Setup Tool]. (For Windows 8, right-click the Start screen, and select [All Apps] on the app bar → [ScanSnap Wireless Setup Tool] under [ScanSnap Manager].)**

⇒ The ScanSnap Wireless Setup Tool will start running.

- 2. Click the [Wireless Network Setup Wizard] button  in the main menu.**

⇒ Displays the Wireless Network Setup Wizard.

- 3. Follow the instructions in the Wireless Network Setup Wizard to configure the wireless settings.**



- 1. From the sidebar in Finder, select [Applications] → [ScanSnap] and double-click [ScanSnap Wireless Setup Tool].**

⇒ The ScanSnap Wireless Setup Tool will start running.

2. Click the [Wireless Network Setup Wizard] button  in the main menu.

⇒ Displays the Wireless Network Setup Wizard.

3. Follow the instructions in the Wireless Network Setup Wizard to configure the wireless settings.

HINT

- For details and operation of ScanSnap Wireless Setup Tool, refer to ScanSnap Wireless Setup Tool Help.
- The ScanSnap Wireless Setup Tool is also started up when the ScanSnap software is installed.

Connect a Computer to the ScanSnap

You can use the ScanSnap Wireless Setup Tool Wizard to setup the connection between a computer and the ScanSnap (→ [page 52](#)).



To connect a computer to the ScanSnap with a wireless LAN, follow the procedure below.

1. Disconnect the USB cable connecting the ScanSnap to the computer.

ATTENTION

If the ScanSnap Manager icon is  or , exit ScanSnap Connect Application on the mobile device.

⇒ The ScanSnap is automatically connected to a computer via wireless LAN and the

ScanSnap Manager icon changes to  or .

If the icon does not change, go to step 2.

HINT

- If the [Connect automatically to the last connected ScanSnap by Wi-Fi] check box is selected and the last connected ScanSnap is available, the computer is connected to the ScanSnap automatically.
- The computer can be connected to only one ScanSnap.
- Only one computer can be connected to the ScanSnap.

2. Right-click the ScanSnap Manager icon (or) , and then select [Connect by Wi-Fi] from the menu that appears.

⇒ The [ScanSnap Manager - Connect by Wi-Fi] dialog box appears.

3. In the list of the ScanSnap units to be connected, select the ScanSnap that you want to connect, and click the [Connect] button.

ATTENTION

- If the [ScanSnap Manager - Enter Destination Password] dialog box appears, enter the password to connect.
The default password is the last four digits of the ScanSnap serial number.
The password can be changed with the ScanSnap Wireless Setup Tool. For details, refer to ScanSnap Wireless Setup Tool Help.
- If the intended ScanSnap for connection does not appear in the list of the ScanSnap units to be connected, refer to the ScanSnap Help.

⇒ The ScanSnap is connected to a computer via wireless LAN and the ScanSnap

Manager icon changes to  or .

Connect a Mobile Device to the ScanSnap

You can use the ScanSnap Wireless Setup Tool Wizard to configure and check the connection between a mobile device and the ScanSnap. (→ [page 52](#))

To connect a mobile device to the ScanSnap without using the ScanSnap Wireless Setup Tool, follow the procedure below.

1. Start ScanSnap Connect Application on your mobile device.

- ⇒ The mobile device will automatically be connected to an available ScanSnap on the same network.

HINT

If more than one available ScanSnap is detected when ScanSnap Connect Application is set for a mobile device not to be connected to a ScanSnap automatically, tap the name of the scanner you want to connect to under [Scanner] on the [Connect to] screen. For details, refer to the ScanSnap Connect Application User's Guide for your mobile device.

Reconnect to a Wireless Access Point Using the ScanSnap WPS Button

If the Wi-Fi indicator lights up or flashes in orange, reconnect the ScanSnap to a WPS compatible wireless access point. The reconnection can be established easily by pressing the WPS button on the ScanSnap.

Perform the following procedures to connect.

ATTENTION

Perform the following before you connect using the WPS button.

- If the ScanSnap Wireless Setup Tool is running while the ScanSnap is being connected to the computer with a USB cable, exit the ScanSnap Wireless Setup Tool.
- If scanning is currently being performed from ScanSnap Manager or a mobile device, end the scanning operation.

HINT

Button names and operating procedures may differ depending on the wireless access point. For details, refer to the manual for your wireless access point.

1. Turn on the ScanSnap.

For details, refer to ["Turning the ScanSnap ON" \(page 45\)](#).

2. Turn on the Wi-Fi switch on the back of the ScanSnap.

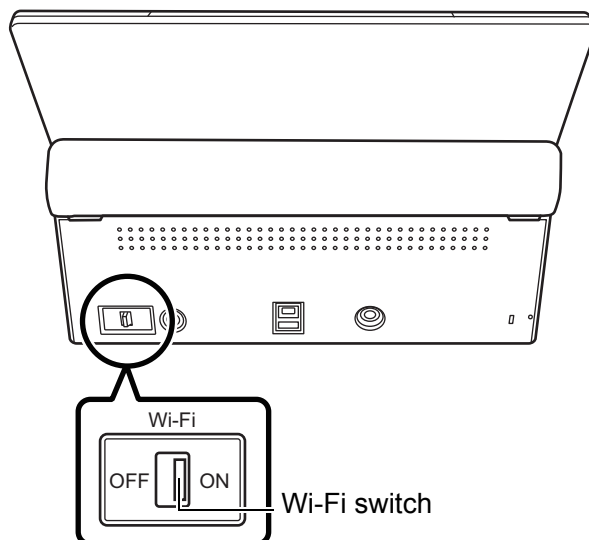

⇒ After blinking blue, the Wi-Fi indicator lights up in blue or orange.

3. Press the WPS button of the wireless access point.

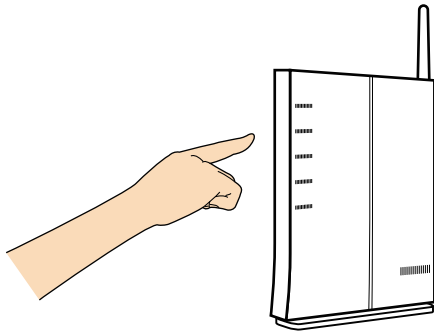

4. Press and hold (3 seconds or longer) the WPS button on the back of the ScanSnap within 2 minutes after pressing the WPS button of the wireless access point.

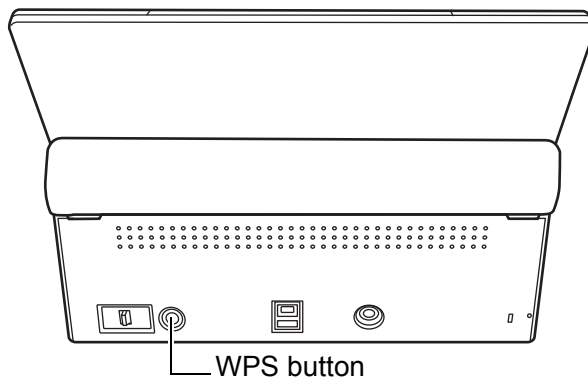

- ⇒ The ScanSnap is connected to the wireless access point and the Wi-Fi indicator lights up in blue.
If connection cannot be established, the Wi-Fi indicator blinks or lights up in orange.

ATTENTION

If you cannot connect the ScanSnap to a wireless access point, refer to "Troubleshooting" in the ScanSnap Manager Help.

HINT

For details about the Wi-Fi indicator status, refer to "[Parts and Functions](#)" (page 32).

Documents for Scanning

This section explains about the documents that can be scanned with the ScanSnap and the conditions for using the Carrier Sheet.

Conditions for Documents to Scan

Paper type	Standard office paper, postcards, business cards, plastic cards complying with ISO781A ID-1 type (54 × 86 mm / 2.1 × 3.4 in.)
Paper weight	40 to 209 g/m ² (10.7 to 55.7 lb) Long page documents 52 to 127 g/m ² (13.9 to 33.9 lb) A8 size (52 × 72 mm) or less 127 to 209 g/m ² (33.9 to 55.7 lb) Plastic cards 0.76 mm (0.03 in.) or less (embossed cards can be used)
Paper size	Width: 50.8 to 216 mm (2 to 8.5 in.) Length: 50.8 to 360 mm (2 to 14.17 in.) For long page (*) 216 × 863 mm / 8.5 × 34 in.

* : Scanning starts when you hold down the [Scan] button on the ScanSnap for 3 seconds or longer.



If you scan a magnetic card or IC card, do not bring the black magnetic part in contact with the magnetic part of the ADF top section. Otherwise, the data on the card may be lost.

ATTENTION

- The following types of documents must not be scanned:
 - Documents attached with the metals such as paper clips or staples that can damage the inside of the ScanSnap (remove the metals for scanning)
 - Documents on which the ink is still wet (wait until the ink dries completely to scan these documents)
 - Documents larger than 216 × 863 (mm) / 8.5 × 34 (in.) (width × length)
 - Documents other than paper such as fabric, metal foil and OHP film
- Be aware that picture side of postcards may get damaged when you scan picture postcards.
- When you scan plastic cards, in [Multifeed Detection] of the [Paper] tab of the ScanSnap setup window, select [None] or [Check Length].

- Be careful of the following when you scan plastic cards.
 - Cards that are bent may not be fed properly.
 - If the surface of the card is dirty with grease marks (e.g. fingerprints) and such, perform scanning after wiping the dirt off.
 - When you scan plastic cards with strong luster, some parts of the image may appear lighter or darker than the original.
e.g. gold colored credit card
 - When you scan embossed cards, put the embossed side down, and insert the card in landscape orientation.
 - If the background color of the card and the color of the embossed characters are similar (e.g. no gold or silver embossing), it may be difficult for the ScanSnap to recognize embossed characters. In that case, click the [Option] button in the [Scanning] tab of the ScanSnap setup dialog box, and select the [Increase text contrast] check box for a possible resolution.

Conditions for Using the Carrier Sheet

The bundled Carrier Sheet is a sheet designed to transport documents through the ScanSnap.

You can scan documents that are larger than A4/Letter size, photographs and clippings. Conditions for documents that can be scanned using the Carrier Sheet are as follows:



- Do not use a damaged Carrier Sheet because it may damage or cause the scanner to malfunction.
- Be careful not to cut your finger on the edge of the Carrier Sheet.

Paper type	Documents that cannot be fed directly into the ScanSnap
Paper weight	Up to 209 g/m ² (up to 55.7 lb) When scanning documents folded in half: Up to 104.5 g/m ² (up to 27.9 lb)
Paper size	Carrier Sheet size (216 × 297 mm) A3 (297 × 420 mm) (*) A4 (210 × 297 mm) A5 (148 × 210 mm) A6 (105 × 148 mm) B4 (257 × 364 mm) (*) B5 (JIS) (182 × 257 mm) B6 (JIS) (128 × 182 mm) Post card (100 × 148 mm) Business card (90 × 55 mm, 55 × 90 mm) Letter (8.5 × 11 in. (216 × 279.4 mm)) 11 × 17 in. (279.4 × 431.8 mm) (*) Custom size Width: 25.4 to 216 mm (1 to 8.5 in.) Length: 25.4 to 297 mm (1 to 11.69 in.)

* : Fold in half to scan.

Documents for Which the Carrier Sheet is Recommended for Scanning

It is recommended that you use the Carrier Sheet to scan the following documents.

- Documents written in pencil
Because there may be black traces left on the documents, it is recommended that you use the Carrier Sheet to scan such documents.
Clean the rollers occasionally when you scan such documents directly without using a Carrier Sheet because dirt accumulating on the rollers may cause feeding errors.
For details about how to clean the inside of the ScanSnap, refer to ["Cleaning the Inside of the ScanSnap" \(page 441\)](#).
- Carbonless paper
Because carbonless paper may contain chemicals that can harm the ScanSnap internal rollers, it is recommended that you use the Carrier Sheet to scan such documents.
Make sure to clean the rollers occasionally to maintain the scanner performance when scanning carbonless paper directly without using the Carrier Sheet. Depending on the type of carbonless paper, the life span of the scanner may be shortened compared to scanning standard office paper.
For details about how to clean the inside of the ScanSnap, refer to ["Cleaning the Inside of the ScanSnap" \(page 441\)](#).
- Scanning the following types of documents without using the Carrier Sheet can result in documents being damaged or scanned incorrectly
 - Documents smaller than 50.8 × 50.8 (mm) / 2 × 2 (in.) (width × length)
 - Documents whose paper weight is less than 40 g/m² (10.7 lb)
 - Documents of non-uniform thickness (e.g. envelopes and paper sheets with attached materials)
 - Wrinkled or curled documents
 - Folded or torn documents
 - Tracing paper
 - Coated paper
 - Photographs (photographic paper)
 - Perforated or punched documents
 - Odd shaped documents (not square or rectangular)
 - Carbon paper or thermal paper
 - Documents with memo papers or sticky notes attached

ATTENTION

- **Using the Carrier Sheet**

Be careful of the following when you use the Carrier Sheet:

- Do not stain, or cut the end with a black & white pattern because the Carrier Sheet will not be recognized properly.
- Do not place the Carrier Sheet upside down. Otherwise, a paper jam may occur and damage the Carrier Sheet and the document inside.
- Do not fold or pull the Carrier Sheet.
- Paper jams may occur when several small size documents such as photographs and postcards are placed inside the Carrier Sheet to be scanned at once. It is recommended that you scan such documents one at a time.
- If paper jams occur frequently, feed about 50 sheets of PPC paper (recycled paper) before scanning with the Carrier Sheet. The PPC paper can either be blank or printed.

- **Storing the Carrier Sheet**

Be careful of the following when you store the Carrier Sheet:

- Do not leave your document inside the Carrier Sheet for a long time. Otherwise, the ink on the document may be transferred onto the Carrier Sheet.
- To avoid deformation, do not use or leave the Carrier Sheet in high temperature places such as under direct sunlight or near a heating apparatus for a long time.
- To avoid deformation, store the Carrier Sheet on a flat surface without any weight on it.

How to Load Documents

Load documents in the ScanSnap in the following procedure.

For details about documents that can be loaded, refer to ["Documents for Scanning"](#) (page 58).

1. If you are loading multiple sheets, check the number of sheets.

The maximum number of sheets in the ScanSnap is as follows:

For A4 or smaller sizes: Up to 50 sheets can be loaded (with paper weight of 80 g/m² [20 lb] and thickness of the document stack under 5 mm).

ATTENTION

If you try to scan more than the maximum amount that can be loaded, the following problems may occur:

- Files cannot be properly created due to excessive file size.
- Paper jams during scanning

2. Fan the documents.

1. Hold both ends of the documents and fan them a few times.

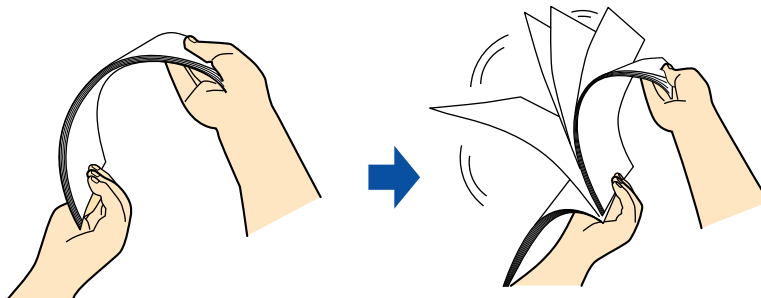

2. Rotate the documents by 90 degrees and fan them in the same manner.

3. Straighten the edges of the documents and slightly displace the top edges at an angle.

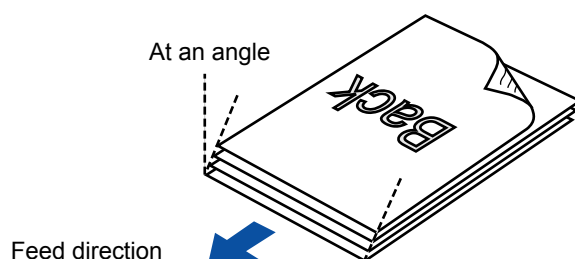

ATTENTION

Paper jams or damage to documents may occur if you scan the documents without aligning the edges first.

4. Open the ADF paper chute (cover) of the ScanSnap.

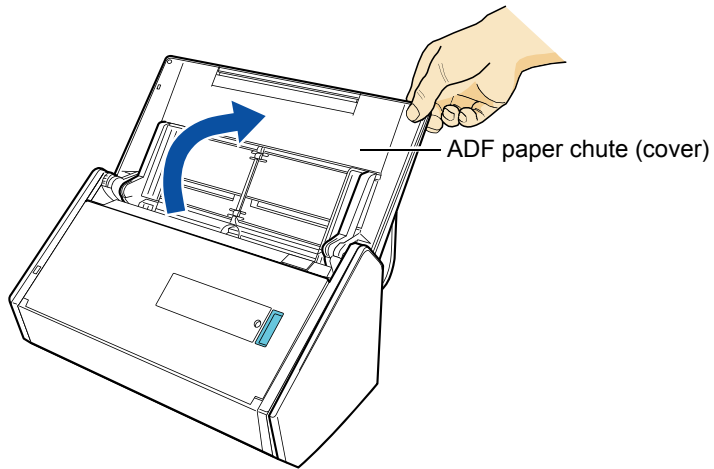

5. Pull the stacker towards you.

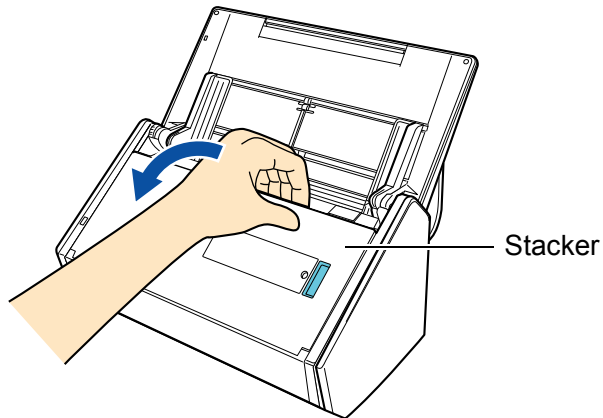

6. Depending on documents to scan, pull out the extension on the ADF paper chute (cover) and open the stacker.

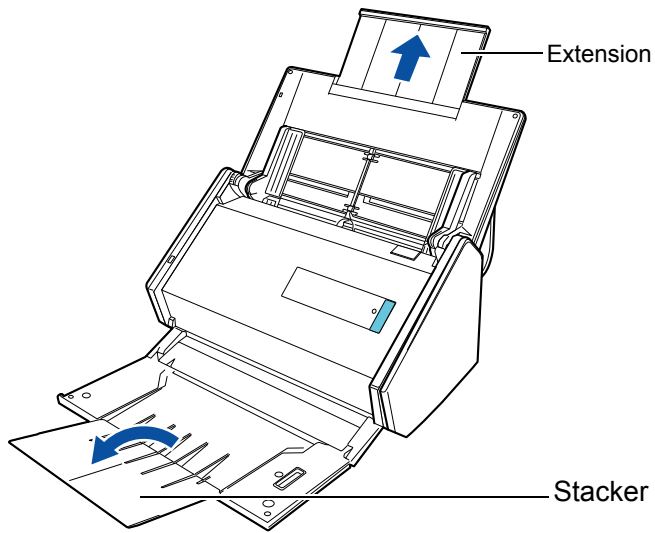

7. Load the documents in the ADF paper chute (cover).

Load the documents face-down and top-first with their back facing you. Load the documents so that they are not beyond the reference marks within the side guides.

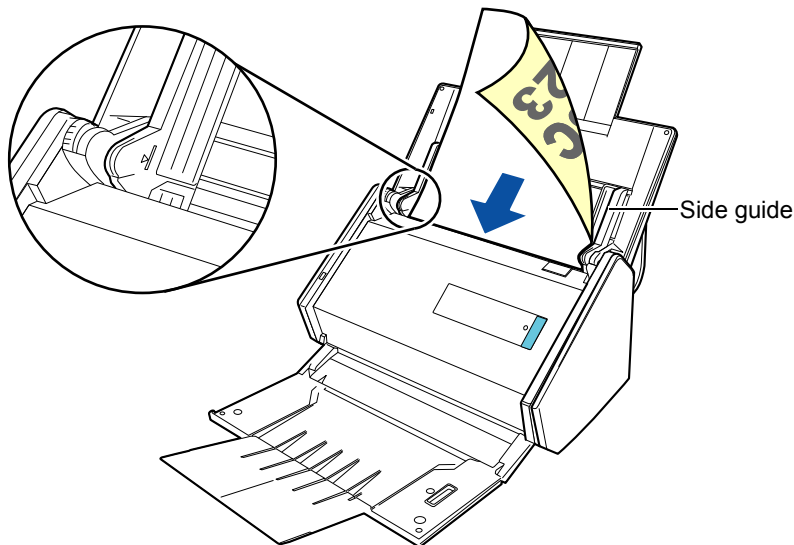

ATTENTION

- Do not accumulate more than 50 sheets (with paper weight of 80 g/m² [20 lb]) in the stacker.



- Right-click the ScanSnap Manager icon  in the notification area and select [Scan Button Settings]. Then, select the [Scanning] tab → the [Option] button, to show the [Scanning mode option] dialog box. If the [Place document face up] check box is selected in the [Scanning mode option] dialog box, load documents face-up and bottom edge first.

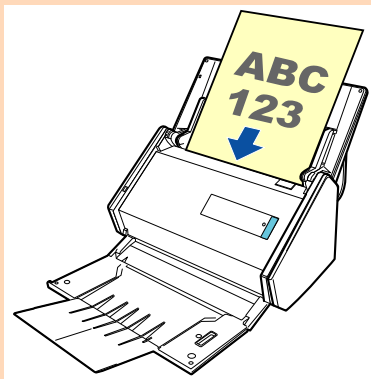

8. Adjust the side guides to the width of the documents.

Hold the side guides in the middle and then move them so that there is no space left between the side guides and the documents.

Otherwise, the documents may be fed skewed.

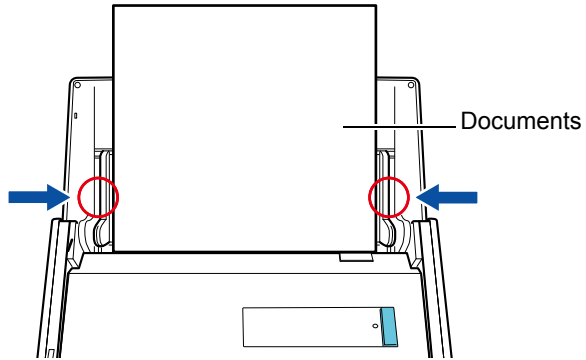

Installing the Software

This chapter explains about the software bundled with the ScanSnap, system requirements and how to install them.

- Bundled Software Overview 69**
- System Requirements..... 71**
- Installing in Windows..... 76**
- Installing in Mac OS 96**

Bundled Software Overview

This section gives an overview of each bundled software and their functions. You can edit, manage and arrange the scanned image by using the following software:

ScanSnap Manager

This scanner driver is required to scan documents with the ScanSnap. The scanned image can be saved as a PDF or JPEG file to a computer.

You need to have ScanSnap Connect Application installed on your mobile device to save PDF or JPEG files to your mobile device.

You can download ScanSnap Connect Application for your mobile device from its application market.

ScanSnap Organizer

You can use this application to display image data (PDF or JPEG files) without opening them, create folders and arrange files as you like.

CardMinder

You can use this application to efficiently digitalize a large number of business cards.

Text recognition can be performed on business cards and you can create a database to facilitate card data management and searches. Data in the database can be printed and linked with various applications.

For Mac OS version, the data can be also shared with PIM (Personal Information Manager), which has Address Book.

ABBYY FineReader for ScanSnap

This application can perform text recognition on the scanned images using OCR (Optical Character Recognition) and convert the image data to Word, Excel or PowerPoint files that can be edited.

ScanSnap Online Update

This application checks if any updates have been released on the download server, and automatically updates the programs.

Evernote for Windows / Evernote for Mac

You can easily save files in Evernote using the ScanSnap.

Scan to Microsoft SharePoint 

You can easily save files in SharePoint using the ScanSnap.

Adobe Acrobat XI Standard 

This is a global standard application for creating, editing, managing, and utilizing PDF format electronic documents.

Rack2-Filer Smart trial version 

This application provides integrated management of digitalized paper documents (electronic documents) and digital data created with computer, as if you are filing paper documents in actual binders.

Magic Desktop trial version 

This application enables you to sort data scanned from the ScanSnap, or memos and images created on a mobile device into various work or personal groups for management.

ABBYY FineReader Express Edition for Mac 

This application can perform text recognition on the scanned images using OCR (Optical Character Recognition) and convert the image data to searchable files.

You can download the following software from the Setup DVD-ROM.

SugarSync Manager for Windows  / **SugarSync Manager for Mac** 

You can easily save files to your SugarSync folder using the ScanSnap.

Dropbox for Windows  / **Dropbox for Mac** 

You can easily save files to your Dropbox folder using the ScanSnap.

System Requirements

The system requirements for the ScanSnap are as follows:

For the latest information on requirements, please visit the ScanSnap Support Site at:

<http://scansnap.fujitsu.com/g-support/en/>

Windows

Operating system	Windows 8 (32-bit/64-bit) (*1) Windows 7 (32-bit/64-bit) Windows Vista (32-bit/64-bit) (*2) Windows XP (32-bit) (*3)
CPU	Intel® Core™2 Duo 2.2 GHz or higher (Recommended: Intel® Core™ i5 2.5 GHz or higher)
Memory	32-bit: 1 GB or more (Recommended: 4 GB or more) 64-bit: 2 GB or more (Recommended: 4 GB or more)
Display Resolution (*4)	Windows 8: 1024 × 768 pixels or higher Windows 7/Windows Vista/Windows XP: 800 × 600 pixels or higher
Hard disk space	Free space required to install the software bundled with the ScanSnap is as follows: <ul style="list-style-type: none"> ● ScanSnap Manager: 700 MB ● ScanSnap Organizer: 670 MB ● CardMinder: 660 MB ● ABBYY FineReader for ScanSnap: 620 MB ● ScanSnap Online Update: 10 MB ● Evernote for Windows: 150 MB ● Scan to Microsoft SharePoint: 40 MB ● Adobe Acrobat XI Standard: 1.5 GB
USB port	USB 3.0 (*5) / USB 2.0 / USB 1.1

*1 : The software bundled with the ScanSnap operates as a desktop application.

*2 : Service Pack 2 or later required.

*3 : Service Pack 3 or later required.

*4 : When the font size is large, some screens may not be displayed properly.

In that case, use a smaller font size.

*5 : Some computers do not recognize the ScanSnap when it is connected to a USB 3.0 port.

For the latest information on USB 3.0, please visit the following web page:

<http://scansnap.fujitsu.com/g-support/en/>

ATTENTION

- If the system requirements above are not satisfied, the ScanSnap may not operate.
- Do not use the USB port on the keyboard or the monitor to connect the ScanSnap (it may not function properly).
- Make sure to use a powered hub equipped with an AC adapter if you are using a commercially available USB hub.
- Scanning speed will slow down in the following cases:
 - The CPU or the memory does not meet the required specifications
 - The version of the USB port or the USB hub is USB 1.1
- The actual increase in used disk space after installation and the required disk space for installation may differ from each other depending on your Windows system disk management.
- A disk space approximately three times larger than the resulting scanned file size is required when scanning documents.
- Characters may not be correctly displayed when using the following functions:
 - CardMinder
 - Scan to Mobile
 - Scan to Salesforce Chatter
 - Scan to SugarSync
 - Scan to Dropbox

Perform the following:

- Windows XP
 - Select [Control Panel] → [Regional and Language Options] → [Language] tab → [Install files for East Asian languages] check box.
 - Install the universal font (Arial Unicode MS) from the setup disc for Microsoft Office 2000 or later.
- Windows Vista/Windows 7/Windows 8
 - Install the universal font (Arial Unicode MS) from the setup disc for Microsoft Office 2003 or later.

HINT

- For Windows 8, Windows Vista or Windows XP, .NET Framework 3.5 SP1 may be installed (maximum of 500 MB free disk space required) at the same time as the following software:
 - ScanSnap Manager
 - ScanSnap Organizer
 - CardMinder
- For Windows XP, .NET Framework 2.0 may be installed (maximum of 280 MB free disk space required) at the same time as the following software:
 - Scan to Microsoft SharePoint

The following shows the estimated file size when scanning one side of a color document.

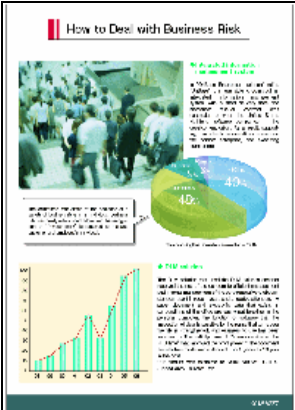
Sample document	Specification
	<ul style="list-style-type: none"> ● Paper type Normal catalog ● Paper size A4 ● File format PDF ● Compression rate 3

Estimated image data size (KB)

Color mode	Automatic resolution	Normal	Better	Best	Excellent
Color	363.6	245.6	363.6	644.8	1673.2
Gray	328.4	223.6	328.4	580.4	1832.8
B&W	212.8	136	212.8	455.2	1300.4
Color high compression	163.6	123.2	163.6	124.8	-

Mac OS

Operating system (*)	OS X v10.8 (Recommended: 10.8.1 or later) Mac OS X v10.7 (Recommended: 10.7.4 or later) Mac OS X v10.6 (Recommended: 10.6.8)
CPU	Intel® Core™2 Duo 2.4 GHz or higher (Recommended: Intel® Core™ i5 2.5 GHz or higher)
Memory	2 GB or more (Recommended: 4 GB or more)
Display Resolution	1024 × 768 pixels or higher
Hard disk space	Free space required to install the software bundled with the ScanSnap is as follows: <ul style="list-style-type: none"> ● ScanSnap Manager: 980 MB ● CardMinder: 570 MB ● ABBYY FineReader for ScanSnap: 590 MB ● ScanSnap Online Update: 10 MB ● ABBYY FineReader Express: 220 MB ● Evernote for Mac: 80 MB
USB port	USB 3.0 / USB 2.0 / USB 1.1

* : It is recommended to apply the latest updates to the Mac OS.

ATTENTION

- If the system requirements above are not satisfied, the ScanSnap may not operate.
- Do not use the USB port on the keyboard or the monitor to connect the ScanSnap (it may not function properly).
- Make sure to use a powered hub equipped with an AC adapter if you are using a commercially available USB hub.
- Scanning speed will slow down in the following cases:
 - The CPU or the memory does not meet the required specifications
 - The version of the USB port or the USB hub is USB 1.1
- A disk space approximately three times larger than the resulting scanned file size is required when scanning documents.

The following shows the estimated file size when scanning one side of a color document.

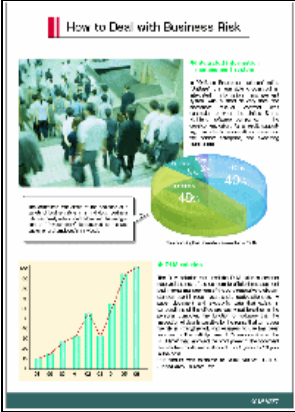
Sample document	Specification
	<ul style="list-style-type: none"> ● Paper type Normal catalog ● Paper size A4 ● File format PDF ● Compression rate 3

Estimated image data size (KB)

Color mode	Automatic resolution	Normal	Better	Best	Excellent
Color	381.9	260.9	381.9	698	2136.9
Gray	319.5	221.3	319.5	562.2	1788.4
B&W	234.6	151	234.6	445.4	1452

Installing in Windows

This section explains how to install the software in Windows.

How to Install the Software

When you insert the Setup DVD-ROM into the DVD-ROM drive on your computer, the [ScanSnap Setup] dialog box appears.

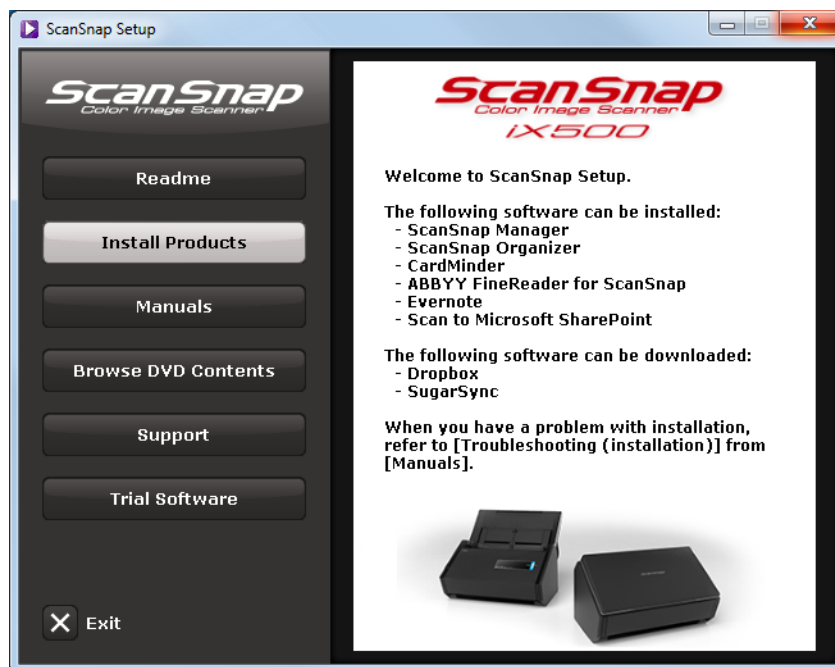

The functions of each button in the [ScanSnap Setup] dialog box are as follows.

Button	Function
Readme	Displays the [Readme] dialog box where you can refer to the Readme file of each software.

Button	Function
Install Products	<p>Displays the [Install Products] dialog box.</p> <ul style="list-style-type: none"> ● [ScanSnap] button Installs the following software: <ul style="list-style-type: none"> - ScanSnap Manager - ScanSnap Organizer - CardMinder - ABBYY FineReader for ScanSnap - ScanSnap Online Update ● [Dropbox] button Opens the Dropbox for Windows download web page. ● [Evernote] button Opens the [Evernote] dialog box. You can install Evernote for Windows or display the download web page. ● [SugarSync] button Opens the SugarSync Manager for Windows download web page. ● [Scan to Microsoft SharePoint] button Installs Scan to Microsoft SharePoint.
Manuals	<p>Displays the [Manuals] dialog box where you can refer to the software manuals including "Safety Precautions", "Getting Started", "Troubleshooting (installation)", and "Operator's Guide (this manual)".</p>
Browse DVD Contents	<p>Opens Windows Explorer to display the files from the DVD-ROM.</p>
Support	<p>Displays contact information for customer support.</p>
Trial Software	<p>Displays the [Trial Software] dialog box from which you can install the trial version software.</p>

ScanSnap Software

HINT

When the installation is complete, a pop-up balloon which indicates that the latest updates are available on the download server may appear.

For details, refer to the ScanSnap Online Update Help.

Install the following software:

- ScanSnap Manager
- ScanSnap Organizer
- CardMinder
- ABBYY FineReader for ScanSnap

The following software is installed at the same time as the above software:

- ScanSnap Online Update

The procedure is as follows.

- 1. Turn on the computer and log on as a user with Administrator privileges.**
- 2. Insert the Setup DVD-ROM into the DVD-ROM drive.**

⇒ The [ScanSnap Setup] dialog box appears.

HINT

If the [ScanSnap Setup] dialog box does not appear, double-click "ScanSnap.exe" in the Setup DVD-ROM via Windows Explorer.

3. Click the [Install Products] button.

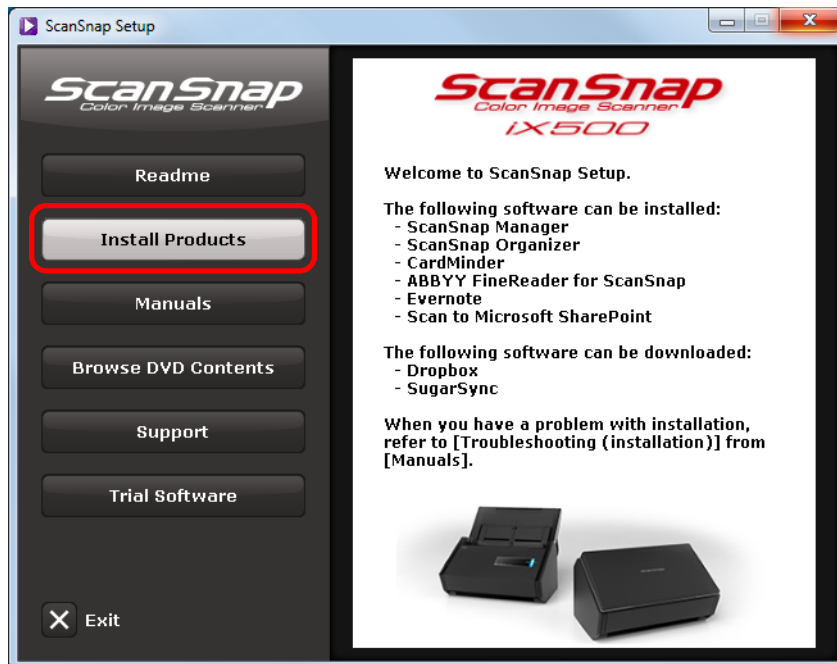

⇒ The [Install Products] dialog box appears.

4. Click the [ScanSnap] button.

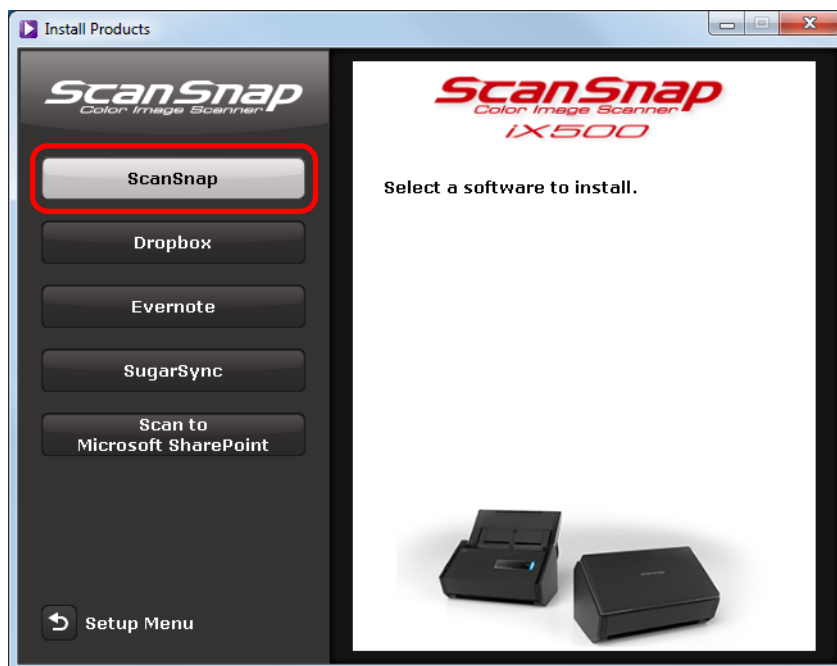

⇒ The [ScanSnap] dialog box appears, displaying the [Welcome to the InstallShield Wizard for ScanSnap] screen.

5. Click the [Next] button.

⇒ [Setup Type] appears.

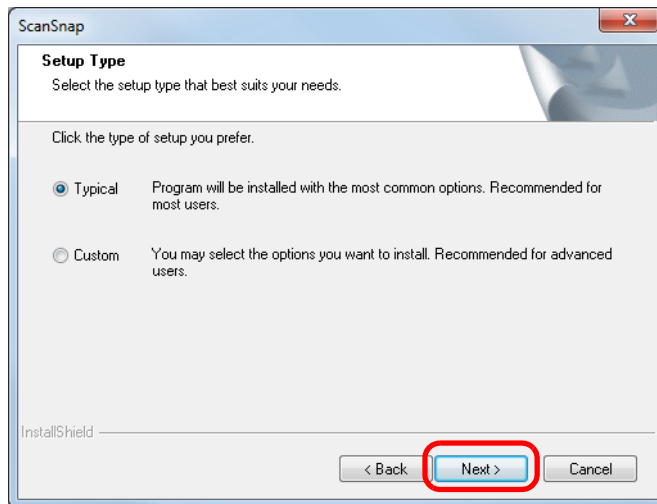
6. Click the [Next] button.**HINT**

You can specify the software you want to install and the installation destination by selecting [Custom], and then clicking the [Next] button.

⇒ A confirmation about accepting the license agreement appears.

7. Read the "END-USER LICENSE AGREEMENT", select [I accept the terms of the license agreement], and then click the [Next] button.

⇒ The [Start Copying Files] screen appears.

8. Confirm the settings, and then click the [Next] button.

⇒ Installation starts. When the installation is complete, the [About ScanSnap's Auto Power OFF function] screen appears.

9. Read the explanation, and then click the [Next] button.

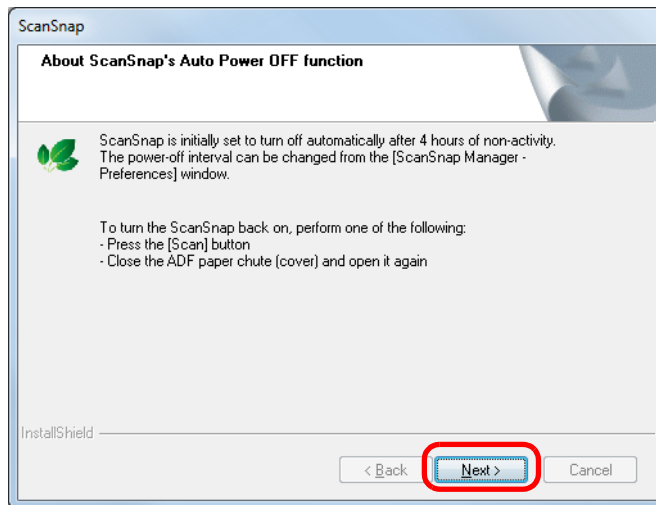

⇒ The [Install Complete] screen appears.

10. Click the [Finish] button.

⇒ When you installed ScanSnap Manager, the [ScanSnap - Connecting the ScanSnap] screen appears.

11. Follow the instructions on the screen to check the connection between the ScanSnap and the computer.

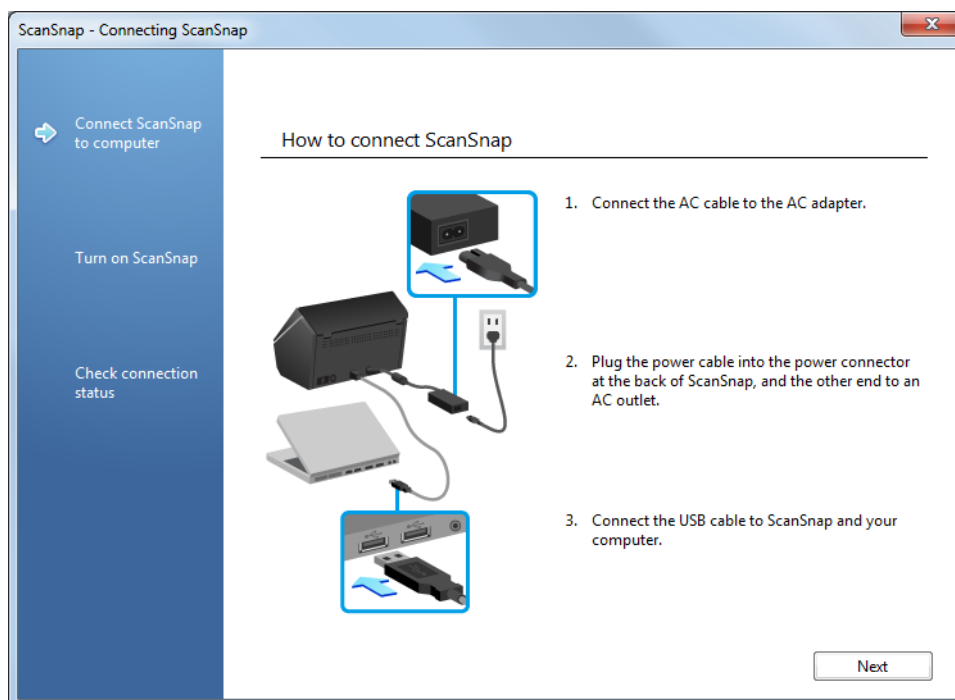

⇒ When the connection confirmation is complete, the [ScanSnap Wireless Network Setup] screen appears.

12. Select whether you want to configure the wireless settings for connecting the ScanSnap to a wireless LAN.

To configure the wireless settings, click the [Setup Now] button, and then follow the instructions on the screen. For details of each screen, click the link next to [?]. Otherwise, click the [Later] button.



HINT

If you want to configure the wireless settings for connecting the ScanSnap to a wireless LAN at another time, refer to "Connecting the ScanSnap to a Wireless LAN" (page 50).

13. Remove the Setup DVD-ROM from the DVD-ROM drive.

ATTENTION

If the installation is not successfully completed, select [Manuals] → [Troubleshooting (installation)] in the [ScanSnap Setup] dialog box, and refer to the Troubleshooting (installation).

Dropbox for Windows

HINT

An Internet connection is required to install Dropbox for Windows.

The procedure is as follows.

1. Turn on the computer and log on as a user with Administrator privileges.
2. Insert the Setup DVD-ROM into the DVD-ROM drive.

⇒ The [ScanSnap Setup] dialog box appears.

HINT

If the [ScanSnap Setup] dialog box does not appear, double-click "ScanSnap.exe" in the Setup DVD-ROM via Windows Explorer.

3. Click the [Install Products] button.

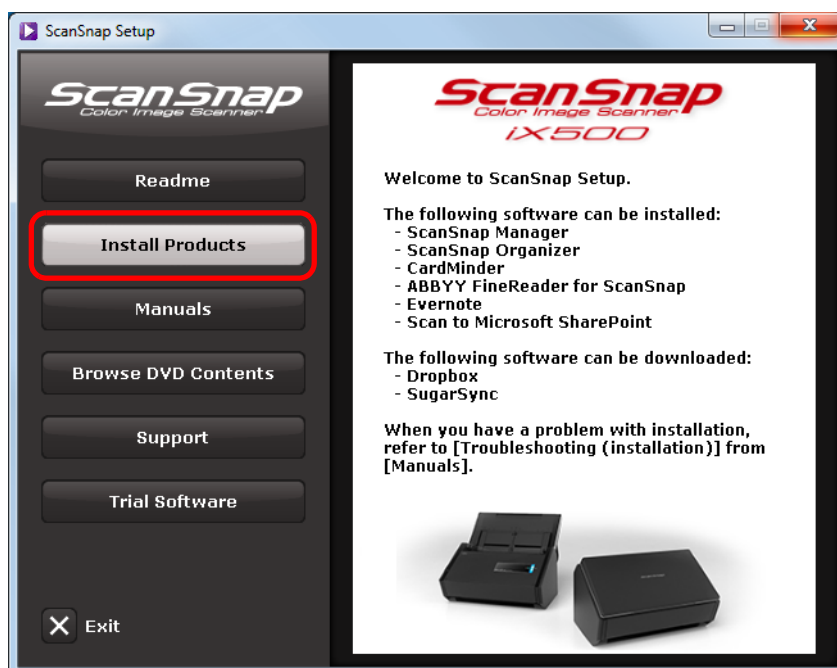

⇒ The [Install Products] dialog box appears.

4. Click the [Dropbox] button.

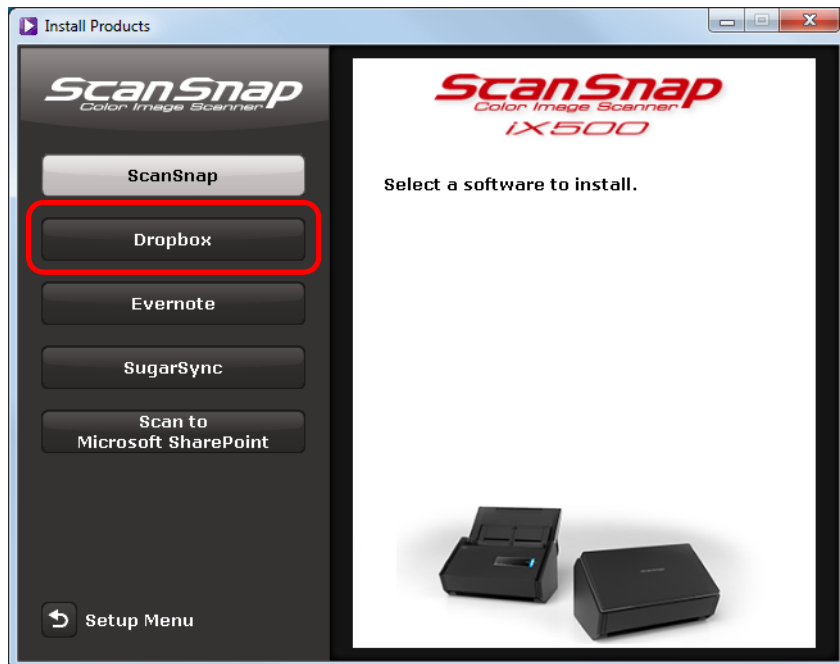

⇒ A web browser starts up and the Dropbox for Windows download web page opens. Download and install Dropbox for Windows.

5. When the installation is complete, remove the Setup DVD-ROM from the DVD-ROM drive.

Evernote for Windows

The procedure is as follows.

1. Turn on the computer and log on as a user with Administrator privileges.

2. Insert the Setup DVD-ROM into the DVD-ROM drive.

⇒ The [ScanSnap Setup] dialog box appears.

HINT

If the [ScanSnap Setup] dialog box does not appear, double-click "ScanSnap.exe" in the Setup DVD-ROM via Windows Explorer.

3. Click the [Install Products] button.

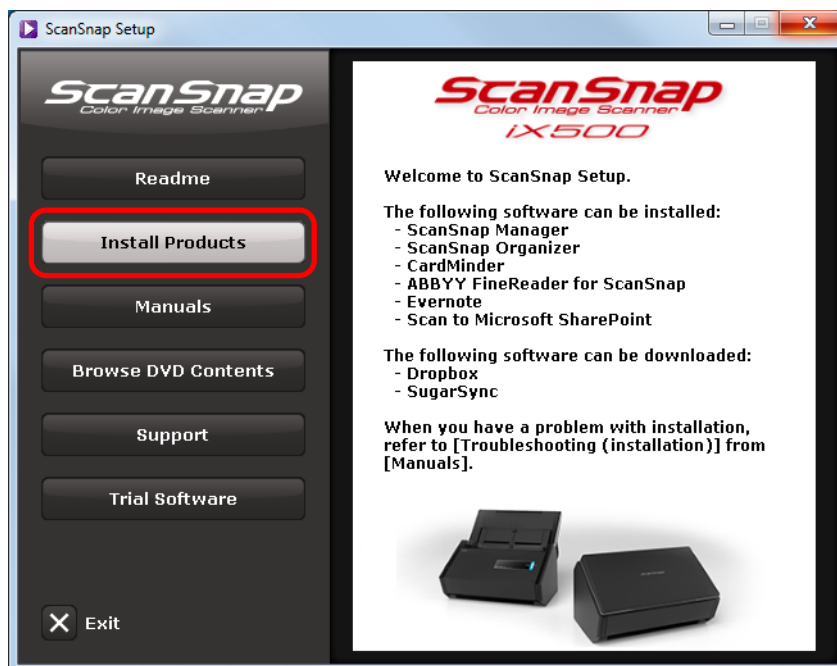

⇒ The [Install Products] dialog box appears.

4. Click the [Evernote] button.

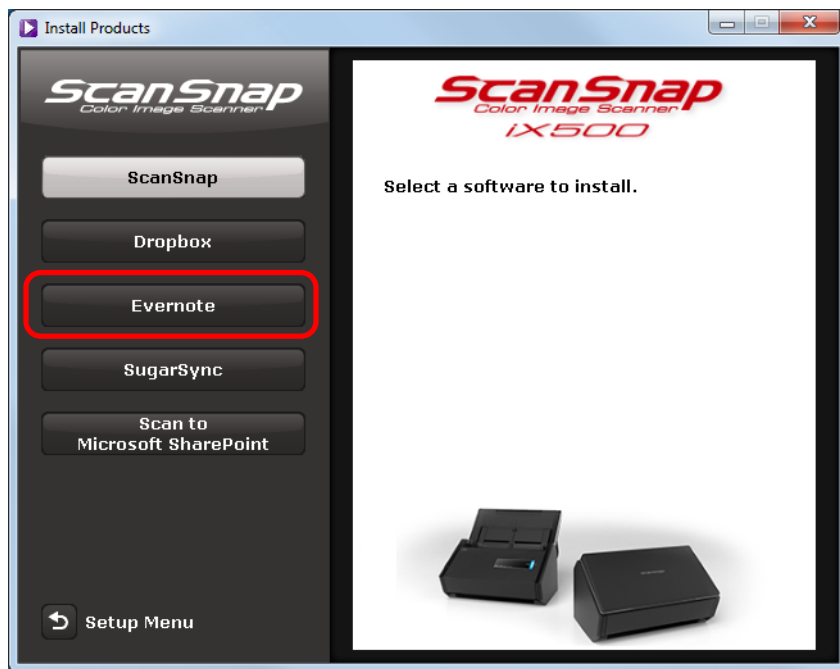

⇒ The [Evernote] dialog box appears.

5. Click the [Install Product] button.

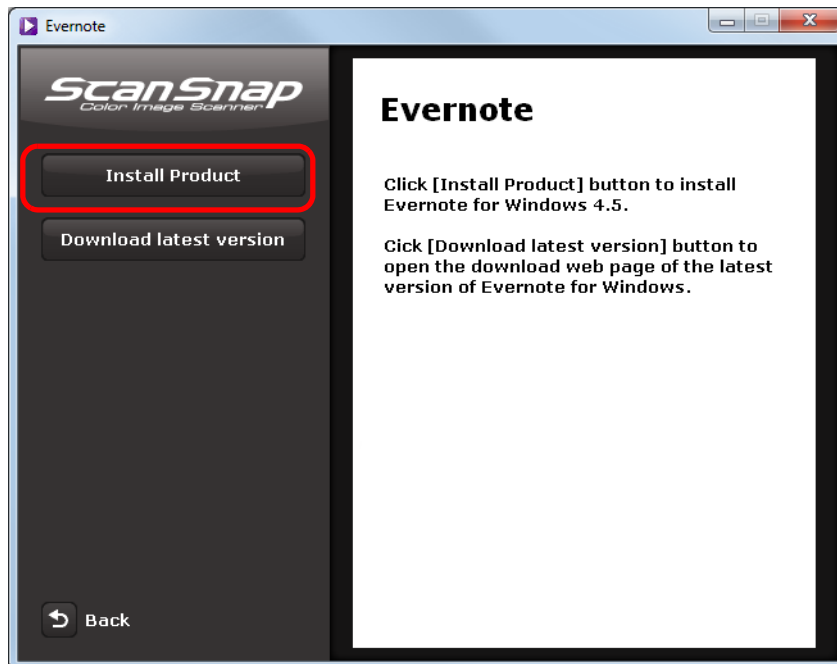

HINT

If you require the latest version of Evernote for Windows, click the [Download latest version] button. A web browser starts up and the Evernote for Windows download web page opens. Download and install Evernote for Windows.

⇒ Installation starts.

6. Follow the instructions on the screen to complete the installation.

7. Click the [Finish] button when the installation complete notification is displayed.

8. Remove the Setup DVD-ROM from the DVD-ROM drive.

SugarSync Manager for Windows

HINT

An Internet connection is required to install SugarSync Manager for Windows.

The procedure is as follows.

1. Turn on the computer and log on as a user with Administrator privileges.
2. Insert the Setup DVD-ROM into the DVD-ROM drive.

⇒ The [ScanSnap Setup] dialog box appears.

HINT

If the [ScanSnap Setup] dialog box does not appear, double-click "ScanSnap.exe" in the Setup DVD-ROM via Windows Explorer.

3. Click the [Install Products] button.

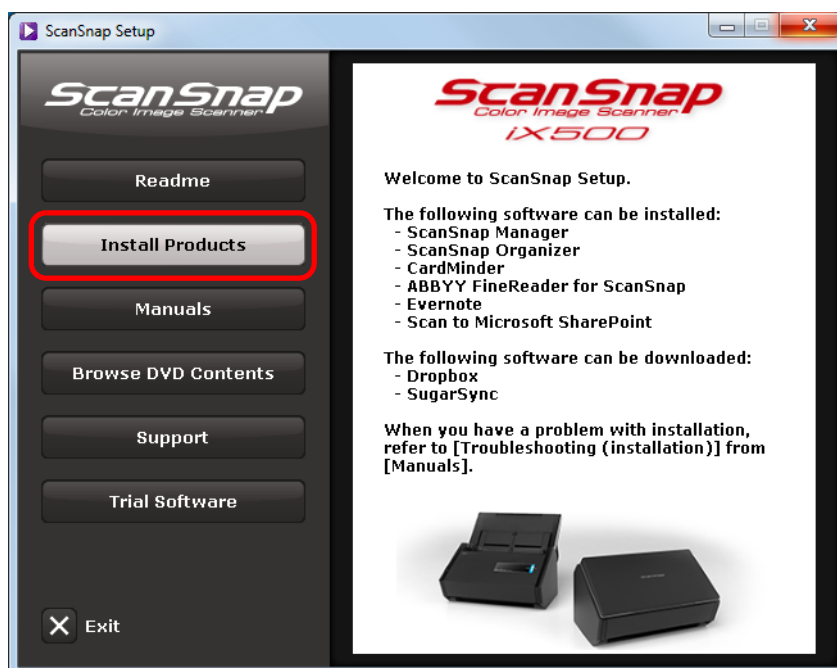

⇒ The [Install Products] dialog box appears.

4. Click the [SugarSync] button.

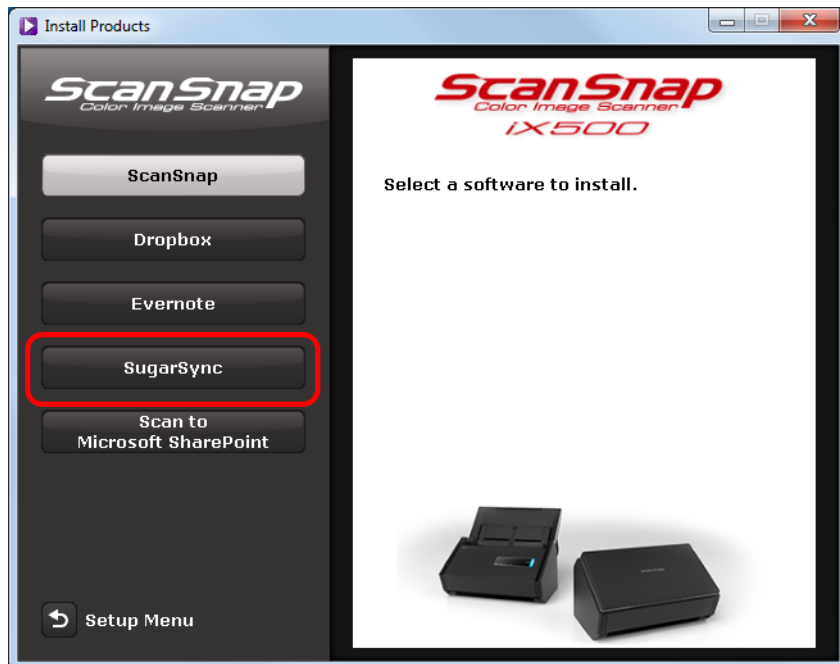

- ⇒ A web browser starts up and the SugarSync Manager for Windows download web page opens.
Download and install SugarSync Manager for Windows.

5. When the installation is complete, remove the Setup DVD-ROM from the DVD-ROM drive.

Scan to Microsoft SharePoint

The procedure is as follows.

HINT

For details about system requirements and notes on installation, refer to "Readme" of Scan to Microsoft SharePoint. Click the [Scan to Microsoft SharePoint] button in the [Readme] dialog box to open the Readme file.

1. Turn on the computer and log on as a user with Administrator privileges.

2. Insert the Setup DVD-ROM into the DVD-ROM drive.

⇒ The [ScanSnap Setup] dialog box appears.

HINT

If the [ScanSnap Setup] dialog box does not appear, double-click "ScanSnap.exe" in the Setup DVD-ROM via Windows Explorer.

3. Click the [Install Products] button.

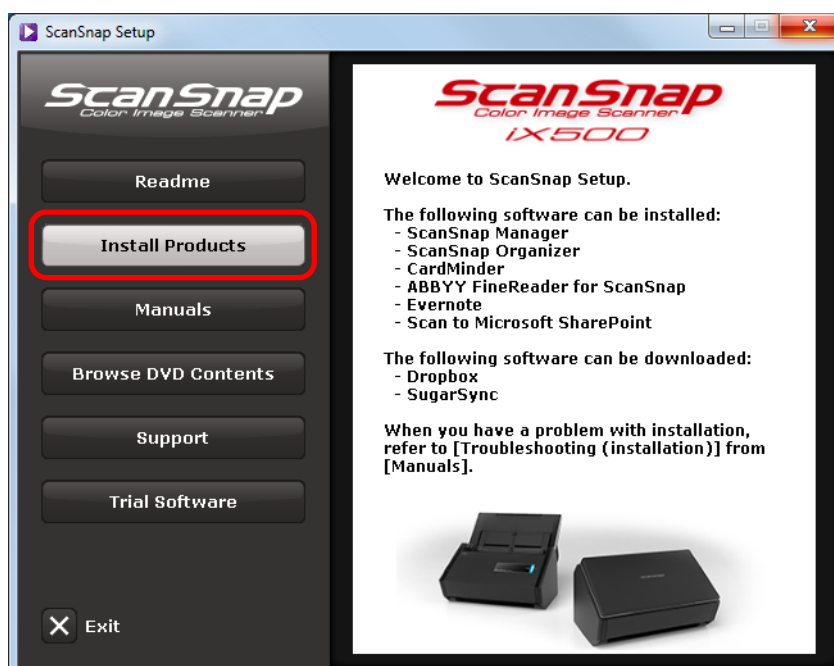

⇒ The [Install Products] dialog box appears.

4. Click the [Scan to Microsoft SharePoint] button.

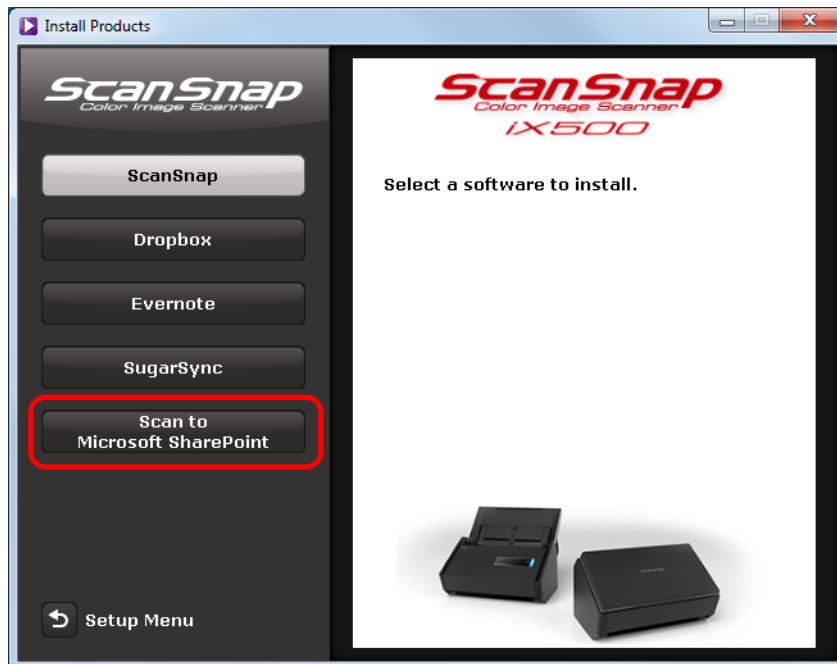

⇒ Installation starts.

5. Follow the instructions on the screen to complete the installation.

6. Click the [Finish] button when the installation complete notification is displayed.

7. Remove the Setup DVD-ROM from the DVD-ROM drive.

HINT

For details about how to use Scan to Microsoft SharePoint, refer to the Scan to Microsoft SharePoint User's Guide. Click the [Scan to Microsoft SharePoint] button in the [Manuals] dialog box to open the Scan to Microsoft SharePoint User's Guide.

Trial Software

The procedure is as follows.

HINT

- An Internet connection is required to install the trial software.
- For details about system requirements and installation of the trial software, refer to the download web page. Click the button of the trial software to install in the [Trial Software] dialog box, then click the link banner of the download web page at the right of the screen to open the web page.

1. Turn on the computer and log on as a user with Administrator privileges.

2. Insert the Setup DVD-ROM into the DVD-ROM drive.

⇒ The [ScanSnap Setup] dialog box appears.

HINT

If the [ScanSnap Setup] dialog box does not appear, double-click "ScanSnap.exe" in the Setup DVD-ROM via Windows Explorer.

3. Click the [Trial Software] button.

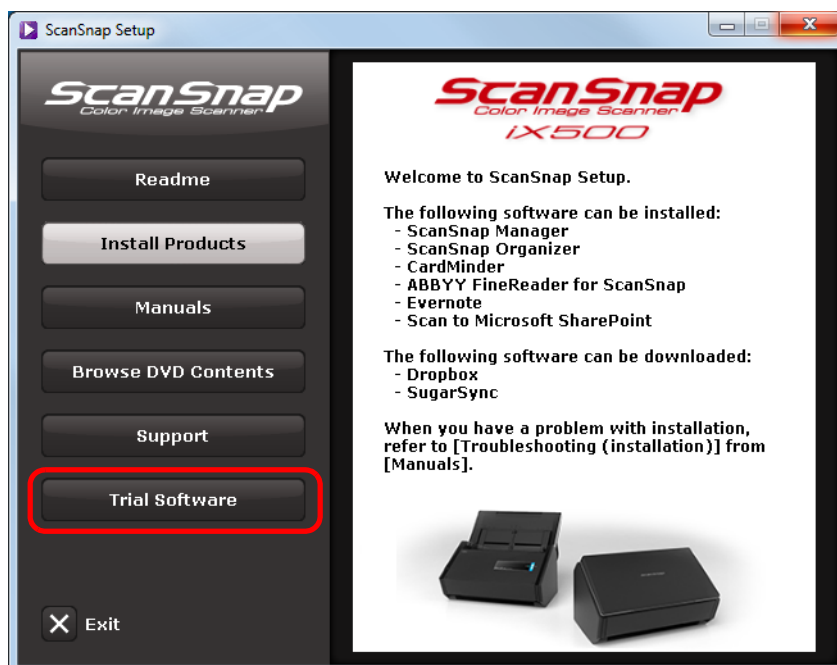

⇒ The [Trial Software] dialog box appears.

4. Click the button of the trial software you want to install.

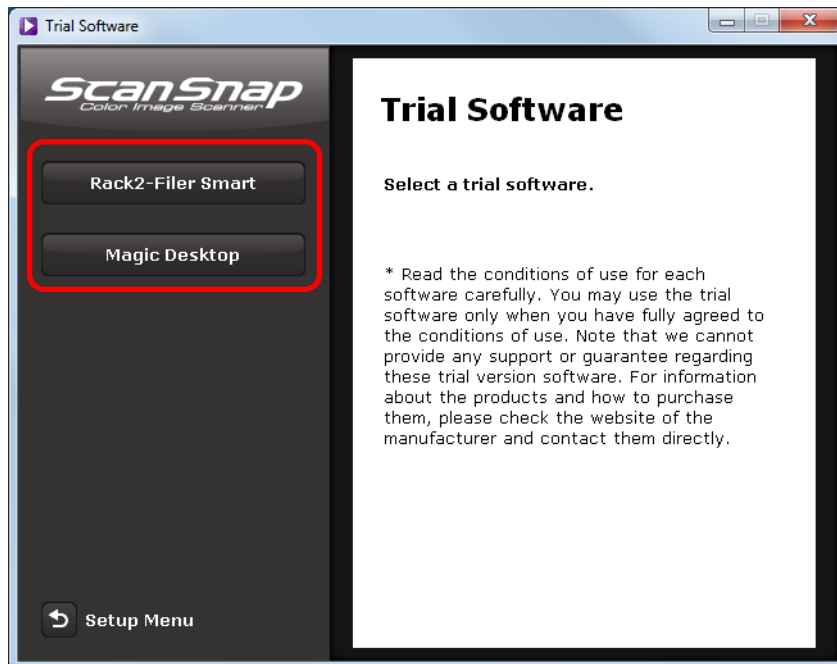

⇒ The link banner of the download web page for the trial version appears at the right of the screen.

Download the trial software from the download web page, and then install it.

5. When the installation is complete, remove the Setup DVD-ROM from the DVD-ROM drive.

HINT

For details about how to use the trial software, refer to the software manual. The manual is installed at the same time as the software. The manuals can be referenced as follows.

- Rack2-Filer Smart trial version
Select [Start] menu → [All Programs] → [Rack2-Filer Smart] → [Rack2-Filer Smart Your Guide] (for Windows 8, right-click the Start screen, and select [All apps] on the app bar → [Rack2-Filer Smart Your Guide] under [Rack2-Filer Smart]).
- Magic Desktop trial version
Select [Start] menu → [All Programs] → [Magic Desktop] → [Magic Desktop Your Guide] (for Windows 8, right-click the Start screen, and select [All apps] on the app bar → [Magic Desktop Your Guide] under [Magic Desktop]).

Adobe Acrobat

The procedure is as follows.

ATTENTION

Adobe Acrobat can be used in the following operating systems:

- Windows 8
- Windows 7
- Windows XP (Service Pack 3 or later required)

Additional requirements are as follows:

- Internet Explorer 7.0 or later/Firefox (ESR)/Google Chrome
- Screen resolution: 1024 × 768 or more

HINT

Adobe Acrobat can display the scanned image through linkage with ScanSnap Manager. If the latest version of Adobe Acrobat is already installed on your computer, you do not need to install it again.

1. Insert the Adobe Acrobat DVD-ROM into the DVD-ROM drive.

⇒ The [AutoPlay] dialog box appears.

2. Click [Run Setup.exe].

⇒ The [Setup] dialog box appears.

3. Select [English (United States)], and click the [OK] button.

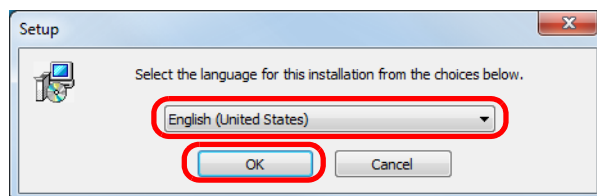

⇒ The Adobe Acrobat XI Standard setup dialog box appears.

4. Click the [Next] button.

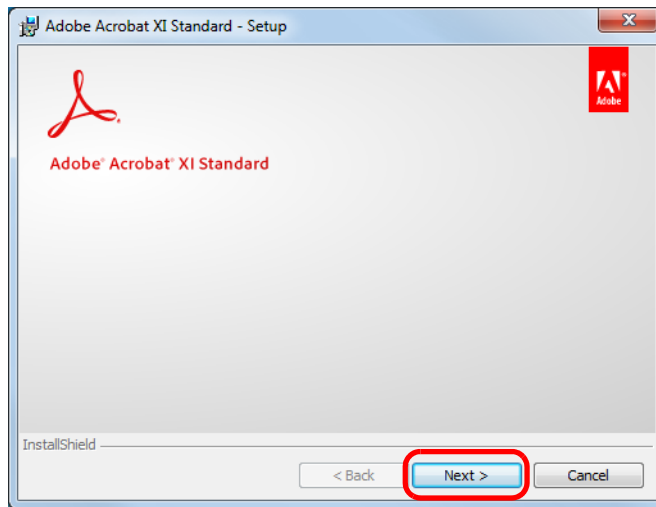

5. Follow the instructions on the screen to complete the installation.

HINT

- For details about the installation of Adobe Acrobat, refer to "Readme" included on the Adobe Acrobat DVD-ROM.
To open Readme, open the file below via Windows Explorer.
DVD-ROM drive:\ReadMe.htm
- For details about how to use Adobe Acrobat, refer to the Adobe Acrobat Help.

6. When the installation is complete, remove the Adobe Acrobat DVD-ROM from the DVD-ROM drive.

Installing in Mac OS

This section explains how to install the software in Mac OS.

How to Install the Software

When you insert the Setup DVD-ROM into the DVD-ROM drive on your computer, the [ScanSnap] window appears.

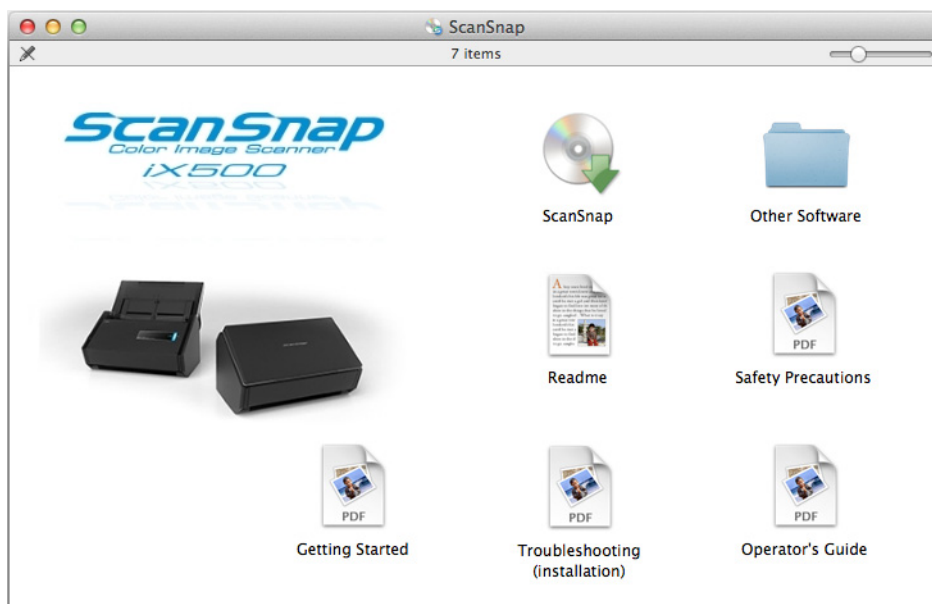

The functions of each icon in the [ScanSnap] window are as follows.

Icon	Function
ScanSnap	Installs the following software: <ul style="list-style-type: none"> ● ScanSnap Manager ● CardMinder ● ABBYY FineReader for ScanSnap ● ScanSnap Online Update
Other Software	Displays the [Other Software] window. <ul style="list-style-type: none"> ● [ABBYY FineReader Express] icon Opens the [ABBYY FineReader Express] window. ● [Dropbox] icon Opens the Dropbox for Mac download web page. ● [Evernote] icon Opens the [Evernote] window. You can install Evernote for Mac or display the download web page. ● [SugarSync] icon Opens the SugarSync Manager for Mac download web page.
Readme	Displays the Readme file.

Icon	Function
Safety Precautions	Displays "Safety Precautions".
Getting Started	Displays "Getting Started".
Troubleshooting (Installation)	Displays "Troubleshooting (installation)".
Operator's Guide	Displays this manual.

ScanSnap Software

HINT

When the installation is complete, the [ScanSnap Online Update] window may appear.
For details, refer to the ScanSnap Online Update Help.

Install the following software:

- ScanSnap Manager
- CardMinder
- ABBYY FineReader for ScanSnap
- ScanSnap Online Update

The procedure is as follows.

- 1. Turn on the computer and log in as a user with Administrator privileges.**
- 2. Insert the Setup DVD-ROM into the DVD-ROM drive.**
⇒ The [ScanSnap] window appears.
- 3. Double-click the [ScanSnap] icon.**

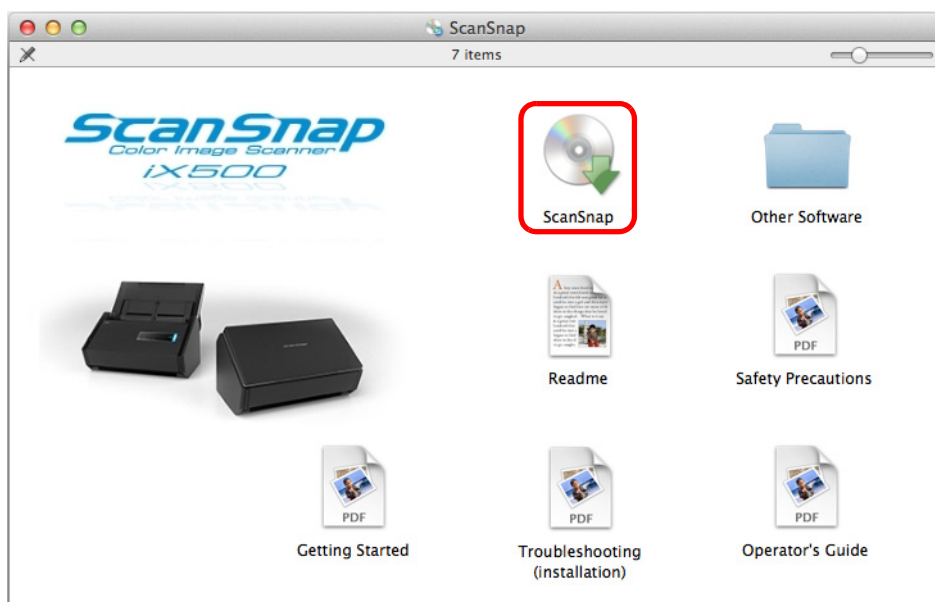

⇒ A confirmation message appears.

4. Click the [Continue] button.

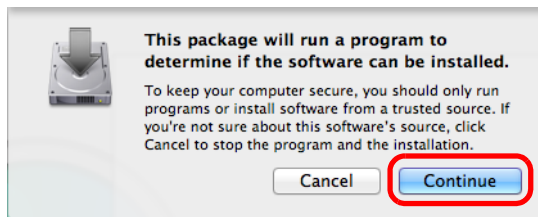

⇒ The [Install ScanSnap] window appears, displaying the [Welcome to the ScanSnap Installer] screen.

5. Click the [Continue] button.

⇒ The [Important Information] screen appears.

6. Read [Important Information], and then click the [Continue] button.

⇒ The [Software License Agreement] screen appears.

7. Read the "END-USER LICENSE AGREEMENT", and click the [Continue] button.

⇒ A confirmation message appears.

8. To accept the license agreement, click the [Agree] button.



⇒ The [Standard Install on "*disk name*"] screen appears.

9. Click the [Install] button.

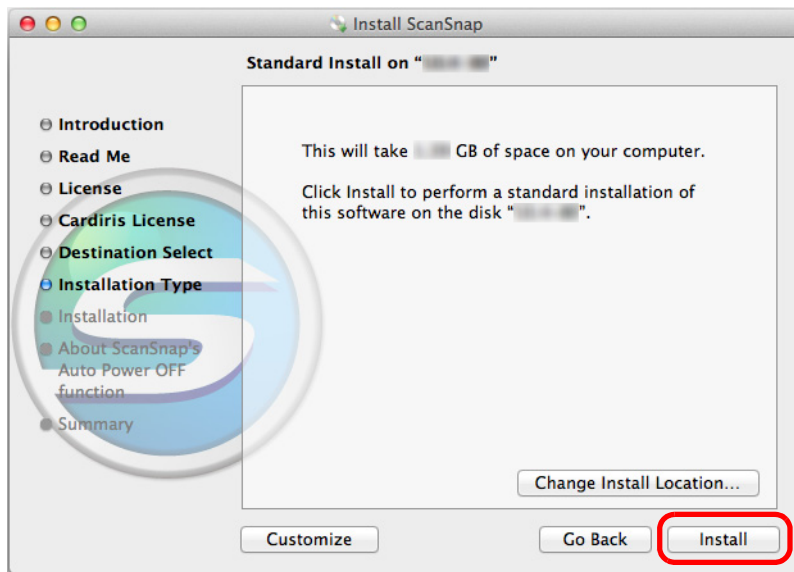

HINT

You can specify the software you want to install by clicking the [Customize] button. The ScanSnap Manager and ScanSnap Online Update settings cannot be changed.

⇒ An authentication window appears.

10. Enter the user name and password for a user with Administrator privileges, and click the [Install Software] button ([OK] on Mac OS X v10.6).

⇒ The [ScanSnap - Connecting ScanSnap] screen appears.

11. Follow the instructions on the screen to check the connection between the ScanSnap and the computer.

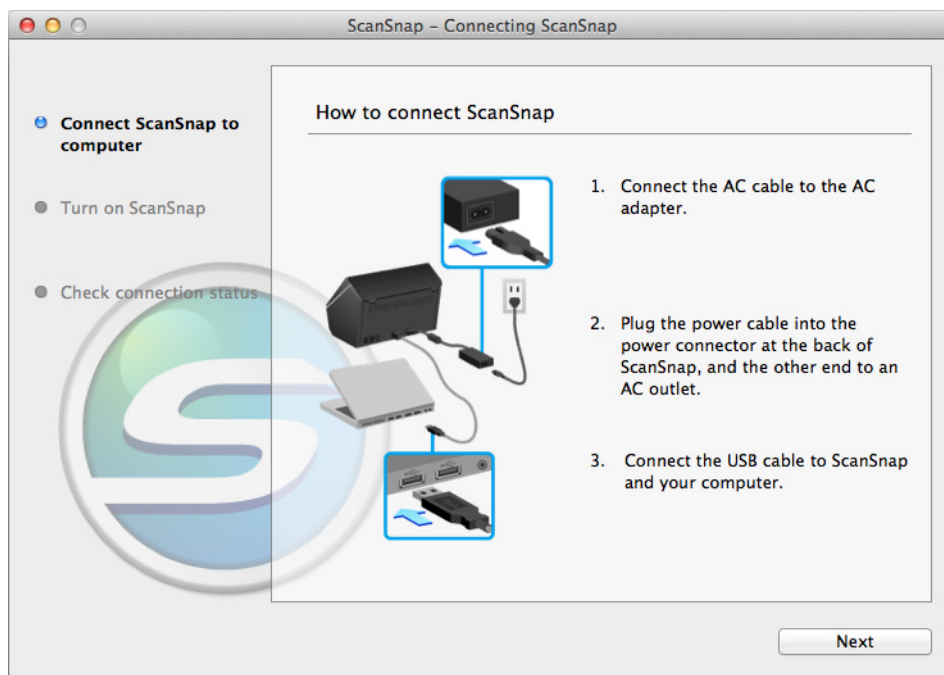

⇒ When the connection confirmation is complete, the [ScanSnap Wireless Network Setup] screen appears.

12. Select whether you want to configure the wireless settings for connecting the ScanSnap to a wireless LAN.

To configure the wireless settings, click the [Setup Now] button, and then follow the instructions on the screen. For details of each screen, click the [?] button. Otherwise, click the [Later] button.

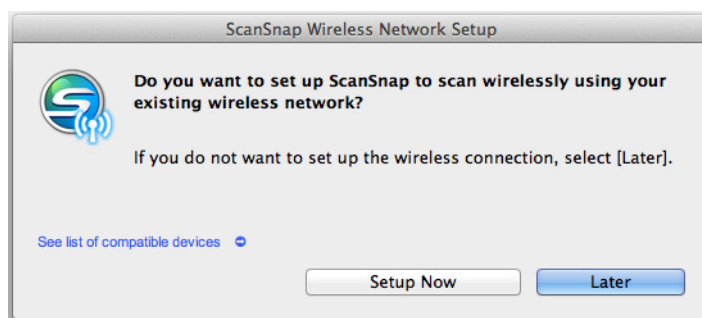

HINT

If you want to configure the wireless settings for connecting the ScanSnap to a wireless LAN at another time, refer to "[Connecting the ScanSnap to a Wireless LAN](#)" (page 50).

⇒ When the installation is complete, the [About ScanSnap's Auto Power OFF function] screen appears.

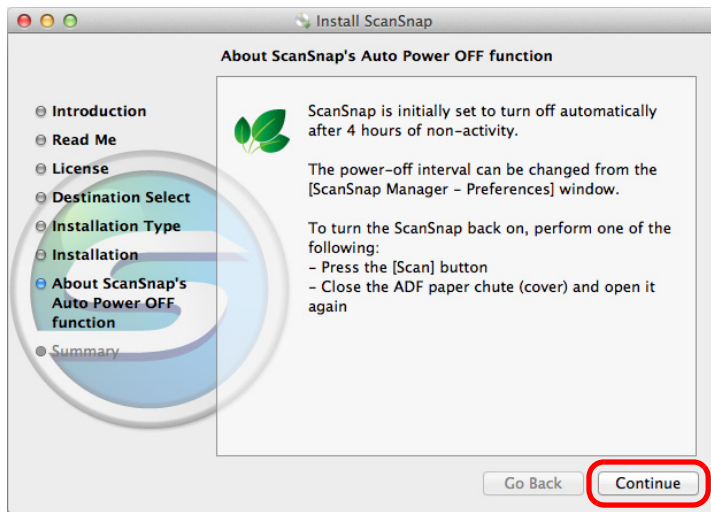
13. Read the explanation, and then click the [Continue] button.

⇒ The message "The installation was successful." appears on the screen.

14. Click the [Close] button.**15.** Remove the Setup DVD-ROM from the DVD-ROM drive.

ABBYY FineReader Express Edition for Mac

The procedure is as follows.

1. Turn on the computer and log in as a user with Administrator privileges.
2. Insert the Setup DVD-ROM into the DVD-ROM drive.
⇒ The [ScanSnap] window appears.
3. Double-click the [Other Software] icon.

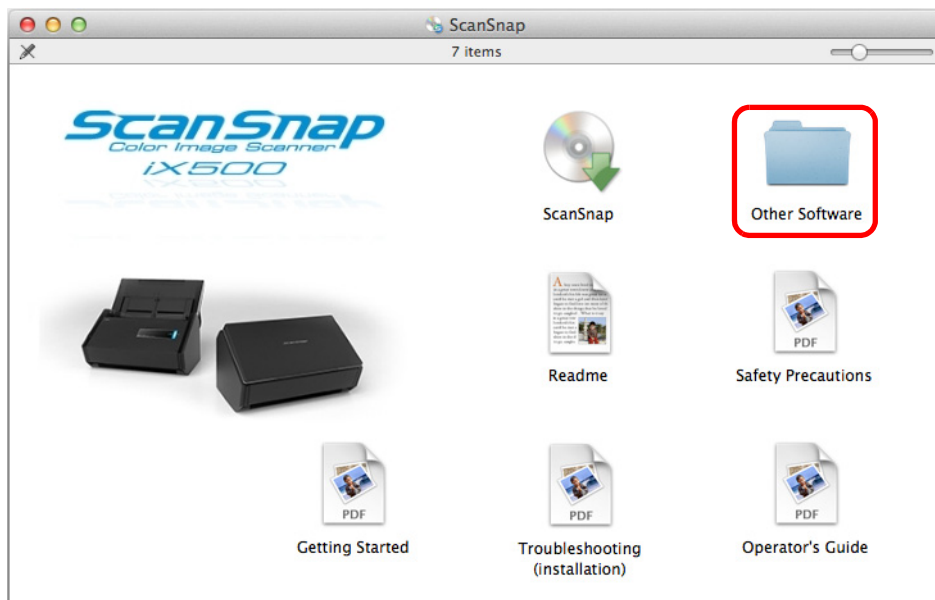

⇒ The [Other Software] window appears.

4. Double-click the [ABBYY FineReader Express] icon.

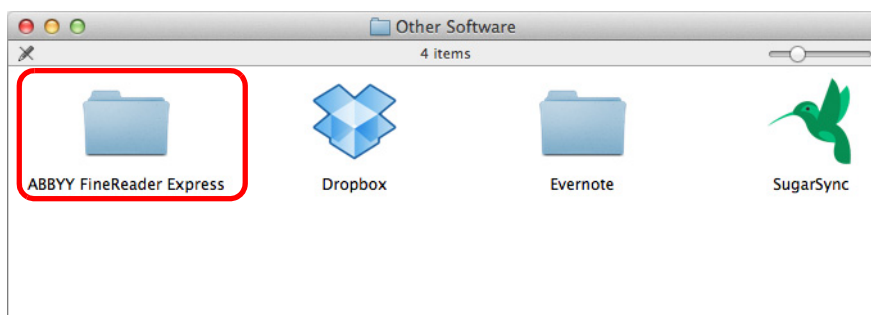

⇒ The [ABBYY FineReader Express] window appears.

5. Double-click the [ABBYFineReaderExpress] icon.

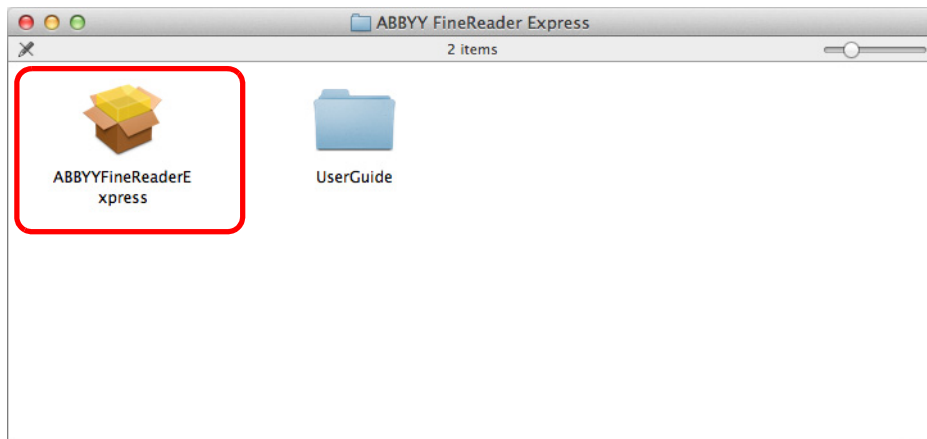

⇒ The [Install ABBYYFineReaderExpress] window appears, displaying the [Welcome to the ABBYYFineReaderExpress Installer] screen.

6. Click the [Continue] button.

⇒ The [Standard Install on "disk name"] screen appears.

7. Click the [Install] button.

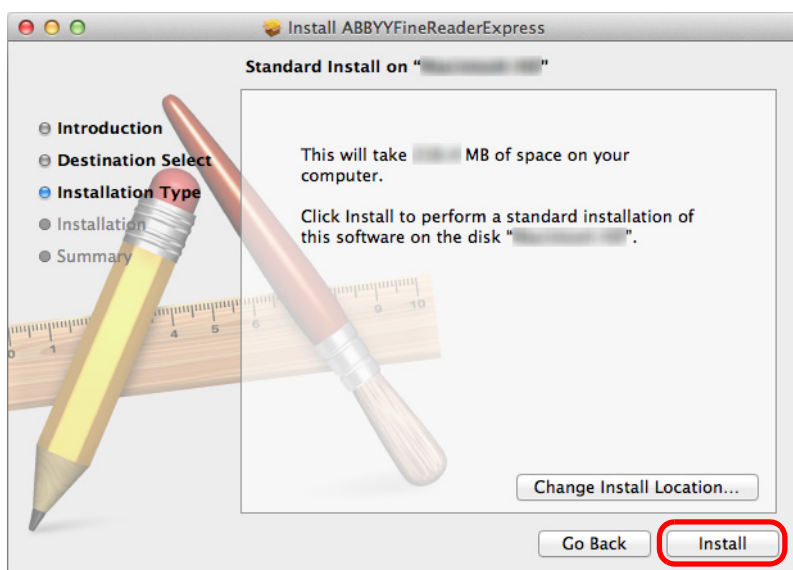

⇒ An authentication window appears.

8. Enter the user name and password for a user with Administrator privileges, and click the [Install Software] button ([OK] on Mac OS X v10.6).

⇒ Installation starts.

When the installation is complete, the message "The installation was successful." appears on the screen.

9. Click the [Close] button.

10. Remove the Setup DVD-ROM from the DVD-ROM drive.

Dropbox for Mac

HINT

An Internet connection is required to install Dropbox for Mac.

The procedure is as follows.

1. Turn on the computer and log in as a user with Administrator privileges.
2. Insert the Setup DVD-ROM into the DVD-ROM drive.
⇒ The [ScanSnap] window appears.
3. Double-click the [Other Software] icon.

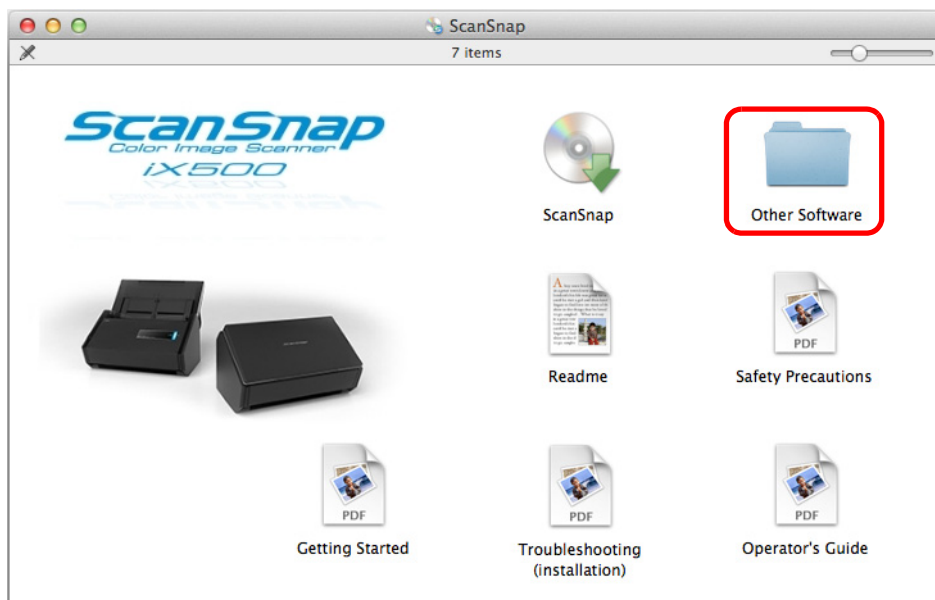

⇒ The [Other Software] window appears.

4. Double-click the [Dropbox] icon.

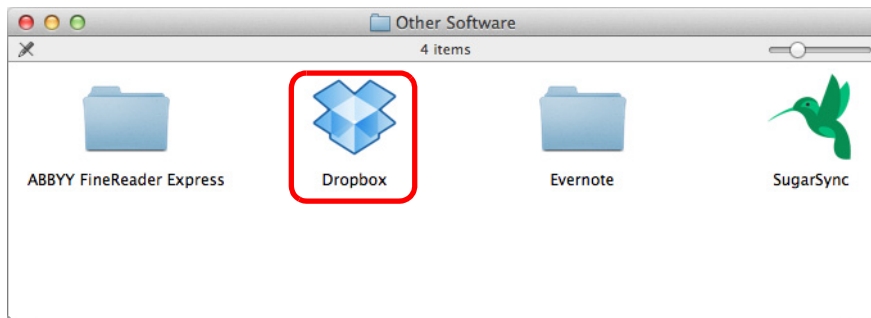

⇒ A web browser starts up and the Dropbox for Mac download web page opens.
Download and install Dropbox for Mac.

5. When the installation is complete, remove the Setup DVD-ROM from the DVD-ROM drive.

Evernote for Mac

The procedure is as follows.

1. Turn on the computer and log in as a user with Administrator privileges.
2. Insert the Setup DVD-ROM into the DVD-ROM drive.
⇒ The [ScanSnap] window appears.
3. Double-click the [Other Software] icon.

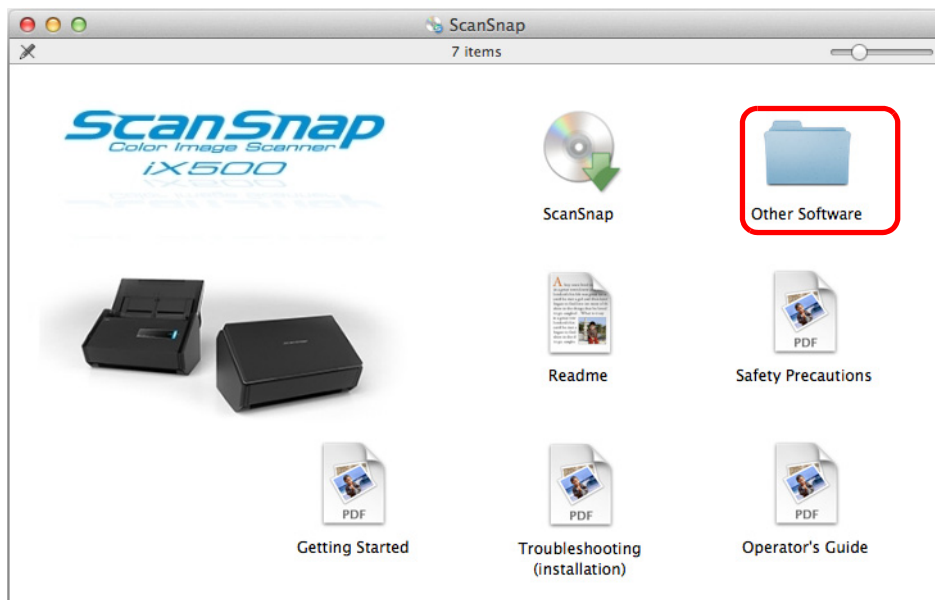

⇒ The [Other Software] window appears.

4. Double-click the [Evernote] icon.

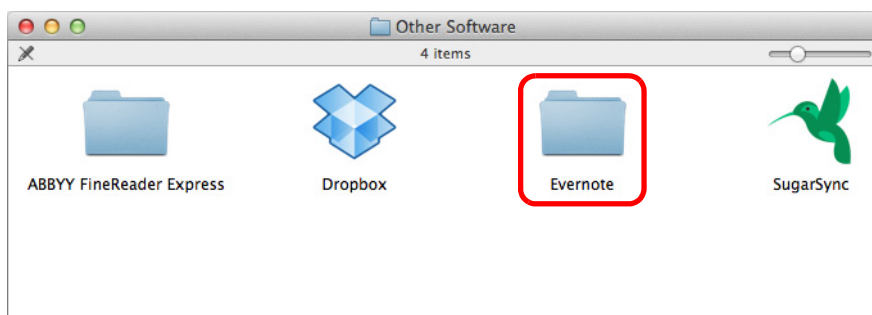

⇒ The [Evernote] window is displayed.

5. Double-click the [Install Product] icon.

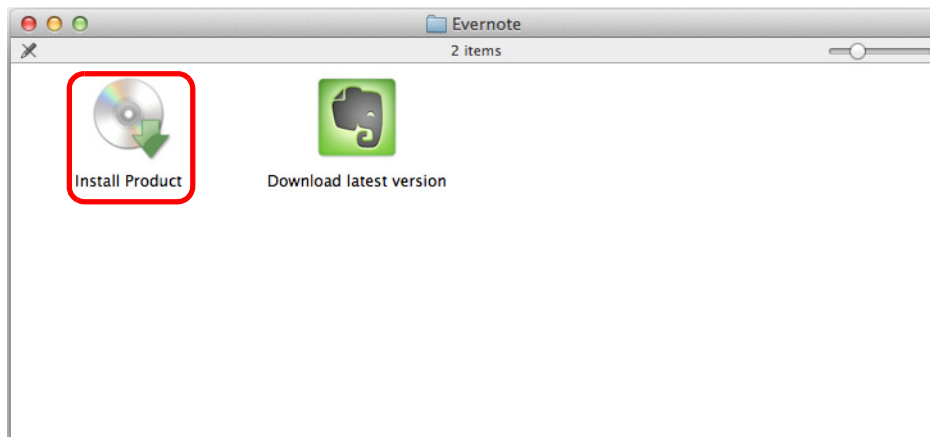

HINT

If you require the latest version of Evernote for Mac, double-click the [Download latest version] icon. A web browser starts up and the Evernote for Mac download web page opens. Download and install Evernote for Mac.

⇒ A confirmation message appears.

6. To accept the license agreement, click the [Agree] button.

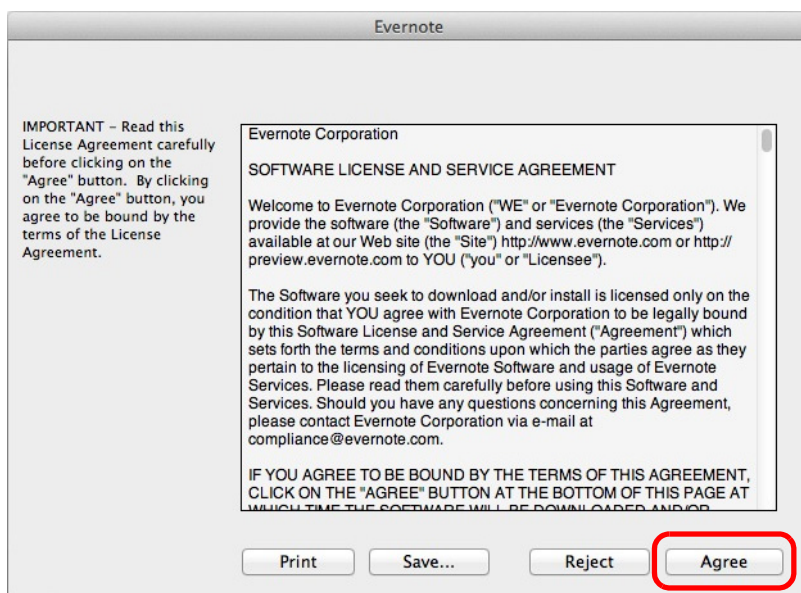

⇒ A window to start installing Evernote for Mac appears.

7. Drag the [Evernote] icon onto the [Applications] icon.



⇒ Evernote for Mac is copied into the [Applications] folder.

8. When the copying is finished, drag the Evernote icon on the desktop into the Trash.

9. Remove the Setup DVD-ROM from the DVD-ROM drive.

ATTENTION

If the installation is not successfully completed, select [Troubleshooting (installation)] in the [ScanSnap] window and refer to Troubleshooting (installation).

10. Prepare for the linkage with Evernote.

Start up Evernote and create a new Notebook.

SugarSync Manager for Mac

HINT

An Internet connection is required to install SugarSync Manager for Mac.

The procedure is as follows.

1. Turn on the computer and log in as a user with Administrator privileges.
2. Insert the Setup DVD-ROM into the DVD-ROM drive.
⇒ The [ScanSnap] window appears.
3. Double-click the [Other Software] icon.

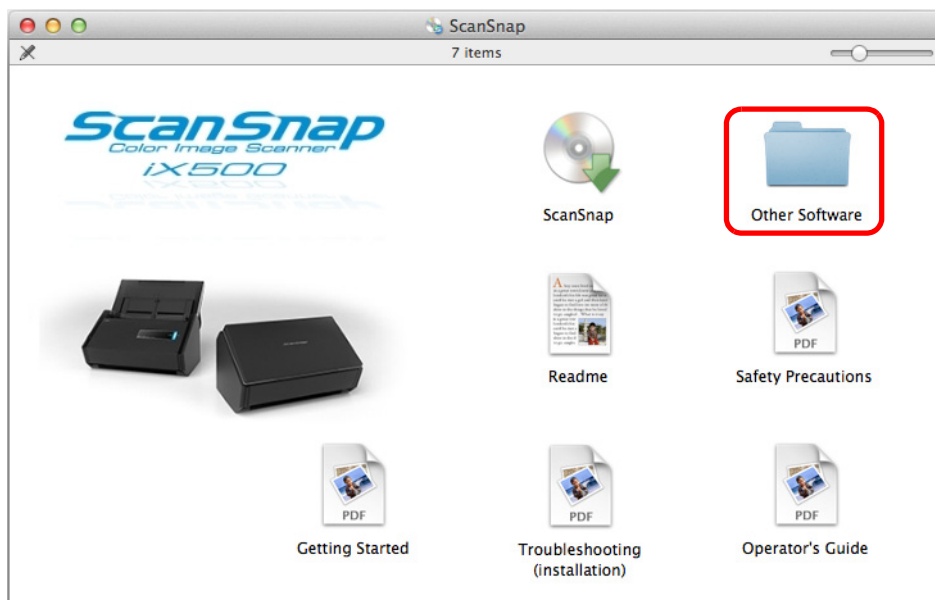

⇒ The [Other Software] window appears.

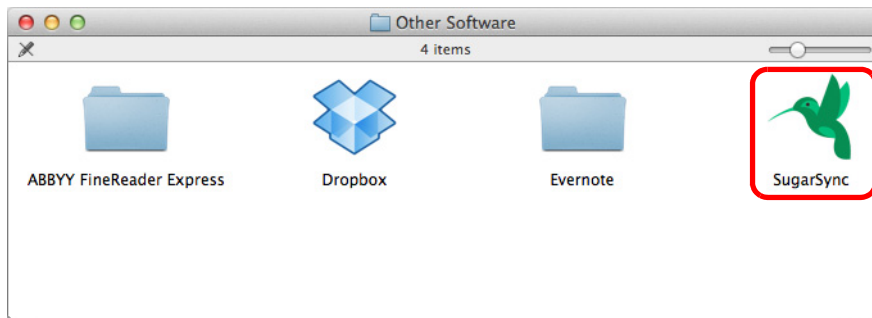
4. Double-click the [SugarSync] icon.

- ⇒ A web browser starts up and the SugarSync Manager for Mac download web page opens.
Download and install SugarSync Manager for Mac.

5. When the installation is complete, remove the Setup DVD-ROM from the DVD-ROM drive.

Using the ScanSnap (for Windows Users)

This chapter explains how to perform scanning and how to set the ScanSnap Manager in Windows.

- Basic Scanning Operation Flow 114**
- Using ScanSnap with the Quick Menu 119**
- Profile 203**
- ScanSnap Folder Operations 216**
- Creating Scanned Images Depending on Intended Use 222**
- Configuring ScanSnap Manager..... 268**

Basic Scanning Operation Flow

This section explains the flow of operations for scanning documents using ScanSnap. The explanations in this section use an example in which the Quick Menu is used for the scanning operation flow. This flow is the basic scanning procedure.

Selecting a Profile Depending on the Document

There are profile buttons that you can use depending on the scan settings for the document. Scanned images with the optimum scan settings can be created by just selecting the profile button.

Profile Button	Description
[Recommended] button	Settings are [Automatic resolution] for [Image quality] in the [Scanning] tab in the ScanSnap setup dialog box and default for other settings. It is recommended that you select this button when you want to scan documents in optimum quality suitable for the paper size of the document.
[Small File] button	Settings are [Normal] (Color/Gray: 150 dpi, B&W: 300 dpi) for [Image quality] in the [Scanning] tab in the ScanSnap setup dialog box and default for other settings. It is recommended that you select this button when you want to reduce the file size.
[High Quality] button	Settings are [Best] (Color/Gray: 300 dpi, B&W: 600 dpi) for [Image quality] in the [Scanning] tab in the ScanSnap setup dialog box and default for other settings. It is recommended that you select this button when you want to scan documents in high quality.
[Customize] button	Default settings are the same as the [Recommended] settings. Scan settings can be changed depending on your scanning purpose.

HINT

You cannot change the settings for the [Recommended], [Small File], and [High Quality] buttons. If you change any of these settings, the profile automatically switches to [Customize].

For details about how to change scan settings, refer to ["How to Configure Scan Settings" \(page 268\)](#).

Select a profile in the following procedure:

1. Turn on the ScanSnap.

For details, refer to ["Turning the ScanSnap ON" \(page 45\)](#).

⇒ Scanning becomes enabled.

2. Select [Scan Button Settings] from the Right-Click Menu.

For details about the Right-Click Menu, refer to "[Right-Click Menu \(Windows\)](#)" (page 37).

⇒ The ScanSnap setup dialog box appears.

3. Select the [Use Quick Menu] check box.

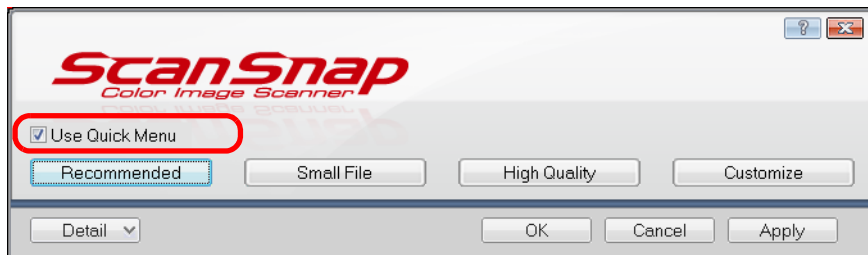

4. Click one of the profile buttons.

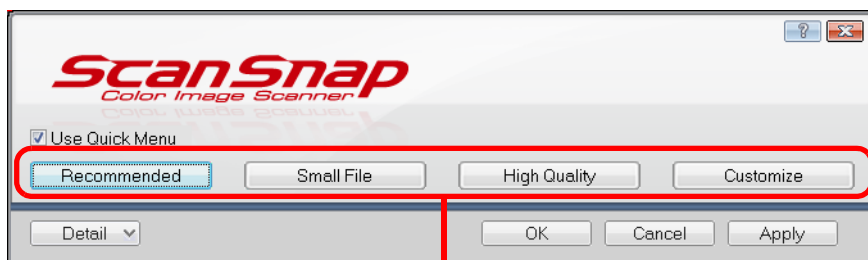

Profile Buttons

HINT

- The [Recommended] button is selected in default.
- For details about the default settings when using the Quick Menu, refer to the ScanSnap Manager Help.

5. Click the [OK] button to close the ScanSnap setup dialog box.

Scanning

Scan a document in the following procedure:

1. Load a document in the ScanSnap.

For details, refer to ["How to Load Documents"](#) (page 63).

2. Press the [Scan] button on the ScanSnap to start a scan.

HINT

- The [Scan] button setting is [Duplex Scan (Double-sided)] in default. Note that you can switch the [Scan] button setting to [Simplex Scan (Single-sided)] in ScanSnap Manager. For details, refer to ["Scanning Only One Side of a Document"](#) (page 222).
- You can also start scanning from the Right-Click Menu.
For details, refer to ["Right-Click Menu \(Windows\)"](#) (page 37).

ATTENTION

- Do not connect or disconnect the ScanSnap and other USB devices during scanning.
- Do not close the ADF paper chute (cover) during scanning.
- Do not switch users during scanning. Doing so will cancel scanning.
- Do not allow the ScanSnap to enter into sleep mode during scanning.

⇒ The [Scan] button on the ScanSnap flashes in blue throughout the scan.
The [ScanSnap Manager - Image scanning and file saving] dialog box appears.

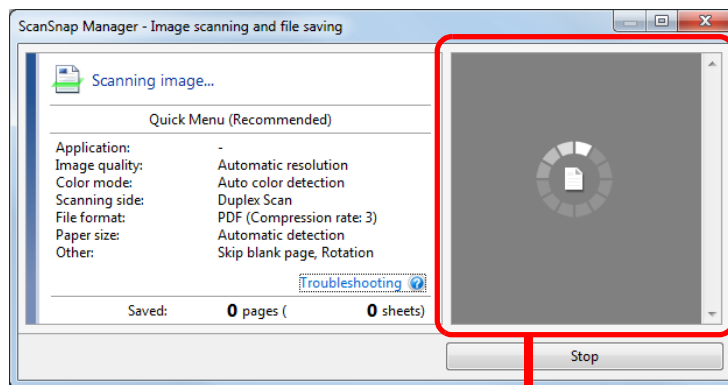

Preview

When you scan more than one document, the preview area will display the scanned images in thumbnails. Up to 150 thumbnails can be displayed.

HINT

Press the [Stop] button to stop scanning the document. For details, refer to ["Stopping the Scan"](#) (page 118).

⇒ The Quick Menu appears when the scanning is completed.

3. In the Quick Menu, click the icon of the application to link with ScanSnap Manager.

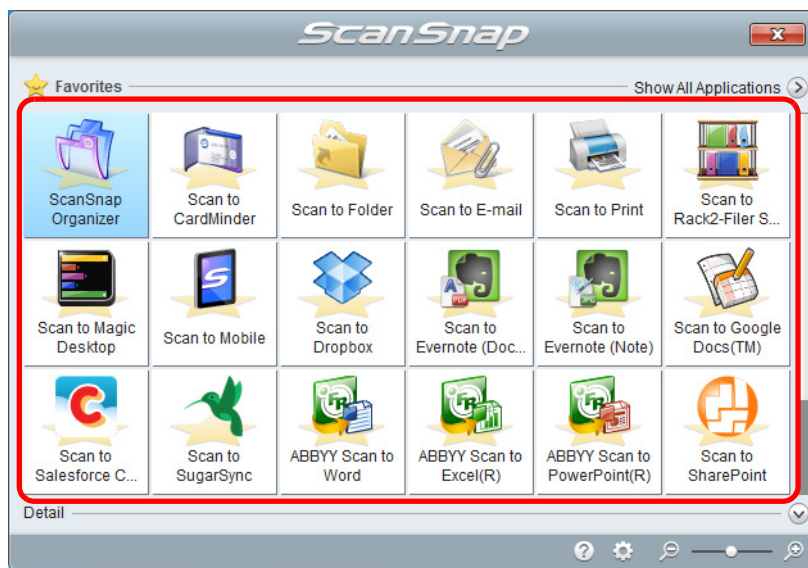

⇒ The selected application starts up.

For details about each application, refer to ["Using ScanSnap with the Quick Menu"](#) (page 119).

ATTENTION

- You cannot start scanning when the Quick Menu is displayed. Either select an icon from the Quick Menu and finish the process, or close the Quick Menu before you perform the next scan.
- Do not move, delete or rename the scanned image in other applications when the Quick Menu is displayed.

HINT

- The output image may slightly differ from the original document in size.
- Performing a scan by pressing the [Scan] button on the ScanSnap while one of the following applications is active (with its dialog box brought to the front and selected on taskbar) automatically starts the linkage between ScanSnap Manager and the application:
 - ScanSnap Organizer
 - CardMinder (linked only when the document is of business card size)
 - Rack2-Filer Smart trial version
 - Rack2-Filer Smart (provided with ScanSnap iX500 Deluxe or sold separately)
 - Magic Desktop trial version
 - Magic Desktop (provided with ScanSnap iX500 Deluxe or sold separately)
 - Scan to Mobile

For details, refer to ["Automatic Linkage with Applications"](#) (page 276).

- The Quick Menu display mode and icon display order can be changed. For details, refer to ["Quick Menu Settings"](#) (page 271).

Stopping the Scan

You can stop a scan in progress in case you are scanning a wrong document or the wrong side of a document.

Stop the scan in the following procedure:

1. Click the [Stop] button in the [ScanSnap Manager - Image scanning and file saving] dialog box which appears during scanning.

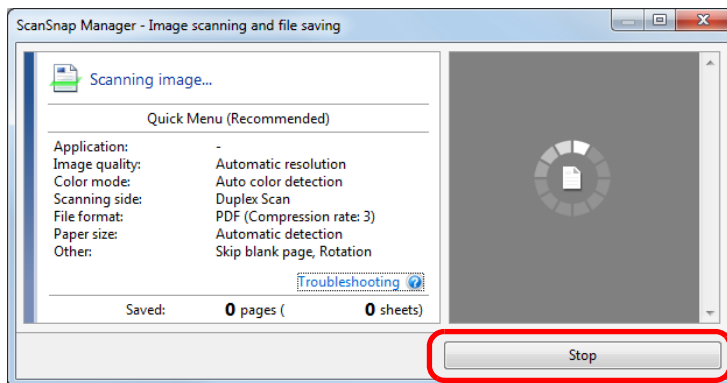

HINT

Remove all documents from the ScanSnap after stopping the scan. For details about how to remove documents, refer to "Troubleshooting" in the ScanSnap Manager Help.

⇒ The following dialog box appears when the scanning stops.

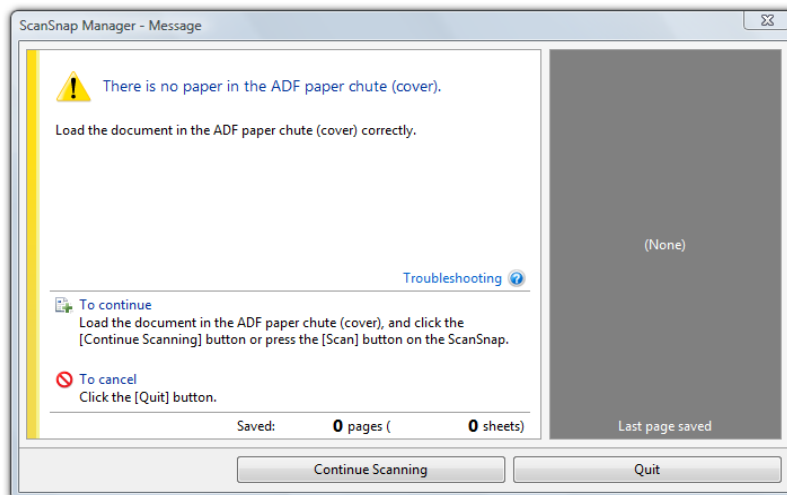

2. Click the [Quit] button.

To continue scanning, click the [Continue Scanning] button or press the [Scan] button on the ScanSnap after loading another document in the ScanSnap.

Using ScanSnap with the Quick Menu



The Quick Menu will allow you to start using the ScanSnap right away even if it is your first time.

Select an icon from the Quick Menu to perform the following desired operations:

- Using scanned images (→ [page 119](#))
- Linkage with applications (→ [page 120](#))
- Linkage with cloud services (→ [page 122](#))

Using Scanned Images

Share the scanned document files with others.



Scan to Folder

Save the scanned image directly in a shared folder on a network after scanning, share the scanned image with others and inform them of the destination folder path by an e-mail message automatically created with the path stated.

Send document files to participants of a meeting via e-mail.



Scan to E-mail

Send an e-mail message to others with the scanned image file attached.

Use a printer rather than a copy machine to make copies of documents.



Scan to Print

Print the scanned image with a printer.

Save scanned documents to a mobile device.



Scan to Mobile (*)

Save the scanned image to a mobile device connected to the computer. You can access the saved files through linkage with an application that can view PDF or JPEG files.

Convert catalogs and pamphlets into digital data and save them.



Scan to Picture Folder

Save scanned images of catalogs and pamphlets directly into your Pictures folder.

Linking with Applications

Organize and manage the scanned document files.



ScanSnap Organizer

Save the scanned images in a folder specified in ScanSnap Organizer, allowing you to organize and manage the scanned images in ScanSnap Organizer.
Displayed when ScanSnap Organizer is installed.

File and organize a large number of business cards.



CardMinder

Store and manage business cards in CardMinder.
Displayed when CardMinder is installed.

Convert your paper documents into digital data to conveniently organize them (Rack2-Filer Smart).



Scan to Rack2-Filer Smart

Save the scanned images as PDF files in Rack2-Filer Smart to manage and organize them.

Displayed when Rack2-Filer Smart trial version or Rack2-Filer Smart (provided with ScanSnap iX500 Deluxe or sold separately) is installed.

Convert your paper documents into digital data to conveniently organize them (Magic Desktop).



Scan to Magic Desktop

Save the scanned images files in Magic Desktop to manage and organize them.

Displayed when Magic Desktop trial version or Magic Desktop (provided with ScanSnap iX500 Deluxe or sold separately) is installed.

Quote text from your paper documents when you do not want to type it.



ABBYY Scan to Word,



ABBYY Scan to Excel(R),



ABBYY Scan

to PowerPoint(R)

Have the scanned image text recognized and converted into a Word, Excel, or PowerPoint document.

Displayed when ABBYY FineReader for ScanSnap (5.0 or later) is installed.

Share the scanned document files through linkage with SharePoint.



Scan to SharePoint

Save the scanned image in SharePoint.

Displayed when Scan to Microsoft SharePoint is installed.

Linking with Cloud Services

Manage scanned documents through linkage with Dropbox.



Scan to Dropbox

Save scanned image files to your Dropbox folder.

Displayed when Dropbox for Windows 1.1.45 or later is installed.

Manage scanned documents through linkage with Evernote.



Scan to Evernote (Document)

Save PDF files in Evernote.

Displayed when Evernote for Windows 3.5 or later is installed.

Manage handwritten notes through linkage with Evernote.



Scan to Evernote (Note)

Save JPEG files in Evernote.

Displayed when Evernote for Windows 3.5 or later is installed.

Manage scanned documents through linkage with Google Docs.



Scan to Google Docs(TM) (*)

Save PDF files in Google Docs.

Manage scanned documents through linkage with Salesforce Chatter.



Scan to Salesforce Chatter (*)

Post scanned image files to Salesforce Chatter and manage them with Salesforce CRM.

Manage scanned documents through linkage with SugarSync.



Scan to SugarSync

Save scanned image files to your SugarSync folder.

Displayed when SugarSync Manager for Windows 1.9.28 or later is installed.

* : Displayed when .NET Framework 3.0 is installed.

Note that .NET Framework 3.0 is also included in .NET Framework 3.5 (SP1 or later). It is recommended that you use .NET Framework 3.5 (SP1 or later) by updating Windows.

Even if .NET Framework 4 or later is already installed, you need to install .NET Framework 3.0 separately because .NET Framework 3.0 is not included in .NET Framework 4 or later version.

The following are explanations on how to use the Quick Menu.

Saving Data in ScanSnap Organizer

This section explains how to save the scanned image file in ScanSnap Organizer. You can use ScanSnap Organizer to display image data without opening them, create folders and arrange files as you like.

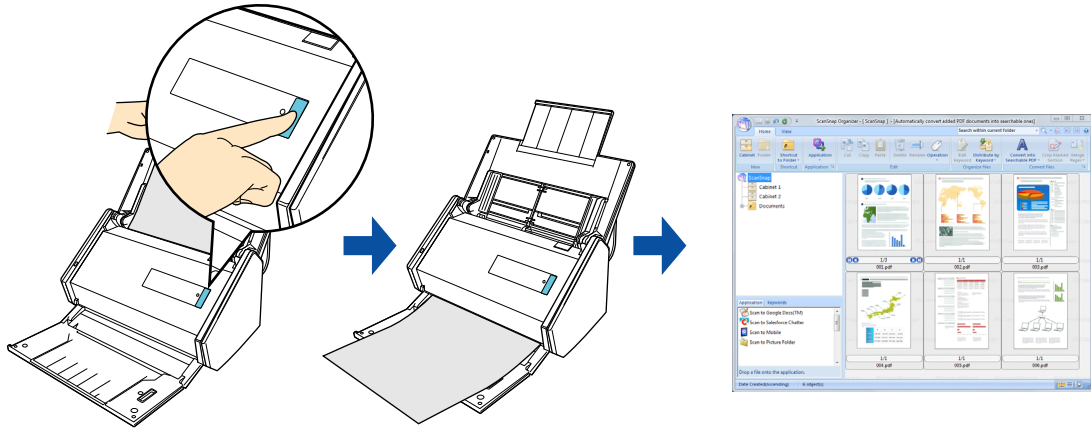

HINT

- By registering the scan and save settings as a profile, you can scan documents with the same profile at any time. For details, refer to ["Profile"](#) (page 203).
- ScanSnap Manager can link with ScanSnap Organizer automatically. For details, refer to ["Automatic Linkage with Applications"](#) (page 276).

Procedures

HINT

To use the Quick Menu, you need to select the [Use Quick Menu] check box in the ScanSnap setup dialog box.

For details about how to perform scanning by using the Quick Menu, refer to "[Basic Scanning Operation Flow](#)" (page 114).

1. Load a document in the ScanSnap.

For details, refer to "[How to Load Documents](#)" (page 63).

2. Press the [Scan] button on the ScanSnap to start a scan.

⇒ The Quick Menu appears when the scanning is completed.



ATTENTION

- You cannot start scanning when the Quick Menu is displayed. Wait until ScanSnap Organizer links before scanning another document.
- Do not move, delete or rename the scanned image in other applications when the Quick Menu is displayed.

3. Click the [ScanSnap Organizer] icon



⇒ The [ScanSnap Organizer] dialog box appears.

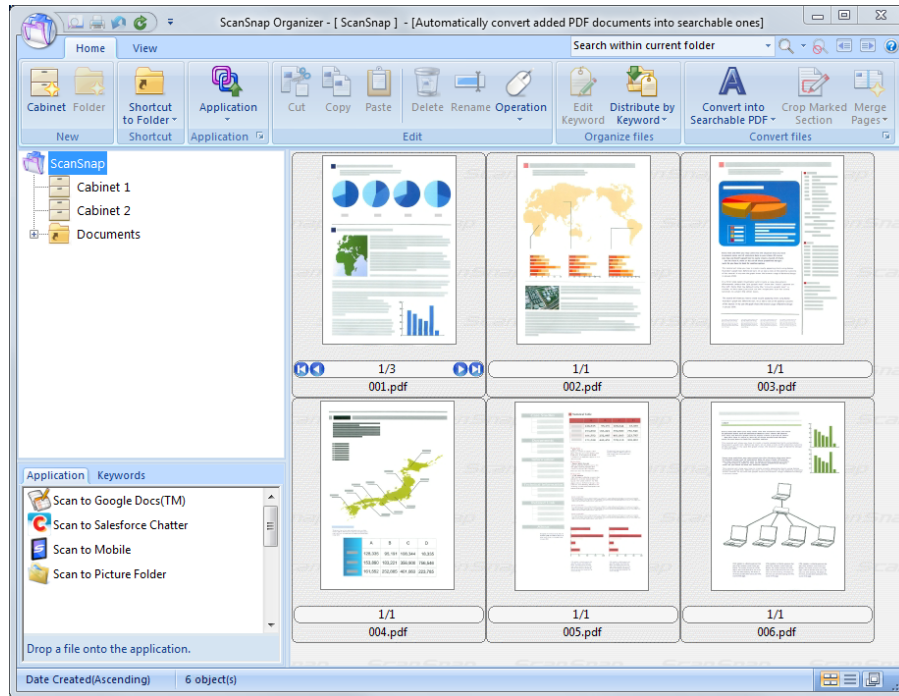

HINT

For details about the functions of ScanSnap Organizer and how to use it, refer to the ScanSnap Organizer User's Guide and ScanSnap Organizer Help.

Storing Business Cards in CardMinder

This section explains how to store business card images and the related information in CardMinder.

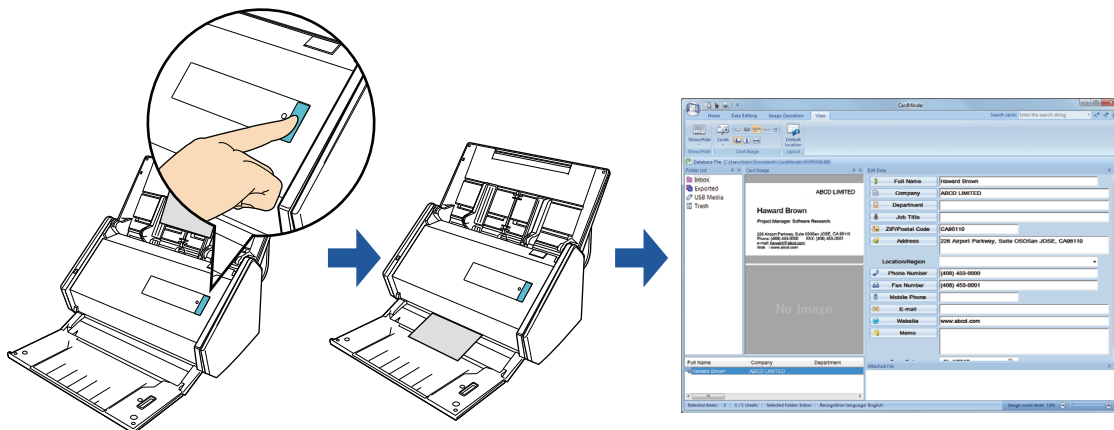

ATTENTION

- Blank pages are not removed even if the [Blank page removal] is selected when you store scanned images of business cards in CardMinder.
- Data of up to 1,000 pages, including blank pages, can be stored in CardMinder at once.

HINT

- By registering the scan and save settings as a profile, you can scan documents with the same profile at any time. For details, refer to "[Profile](#)" (page 203).
- ScanSnap Manager can link with CardMinder automatically. For details, refer to "[Automatic Linkage with Applications](#)" (page 276).

Procedures

HINT

To use the Quick Menu, you need to select the [Use Quick Menu] check box in the ScanSnap setup dialog box.

For details about how to perform scanning by using the Quick Menu, refer to "[Basic Scanning Operation Flow](#)" (page 114).

1. Load a business card in the ScanSnap.

- Load the business card so that the front side faces the ADF paper chute (cover).
- To scan multiple business cards, load them in a pile.
- Do not leave space between the side guides and business cards.

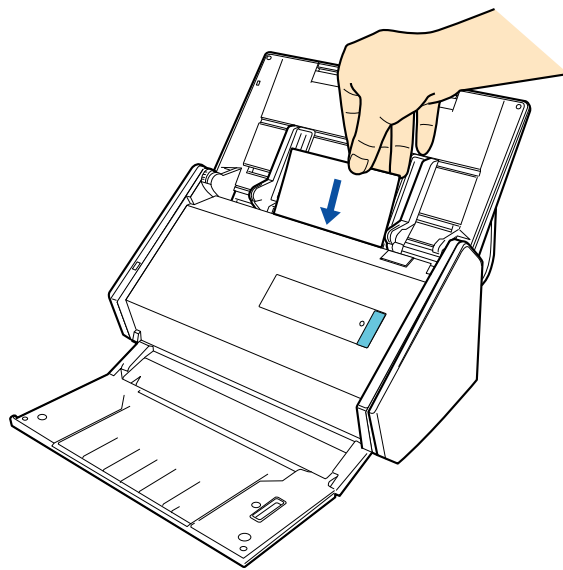

2. Press the [Scan] button on the ScanSnap to start a scan.

HINT

It is recommended that you select [Automatic resolution] or [Best] for [Image quality] in the [Scanning] tab of the ScanSnap setup dialog box. ScanSnap Manager cannot link with CardMinder when [Image quality] is set to [Excellent].

⇒ The Quick Menu appears when the scanning is completed.



ATTENTION

- You cannot start scanning when the Quick Menu is displayed. Wait until ScanSnap Manager links with CardMinder before scanning another document.
- Do not move, delete or rename the scanned image in other applications when the Quick Menu is displayed.

3. Click the [CardMinder] icon .

⇒ The [CardMinder] dialog box appears.

4. Check the scanned card image and the text recognition result.

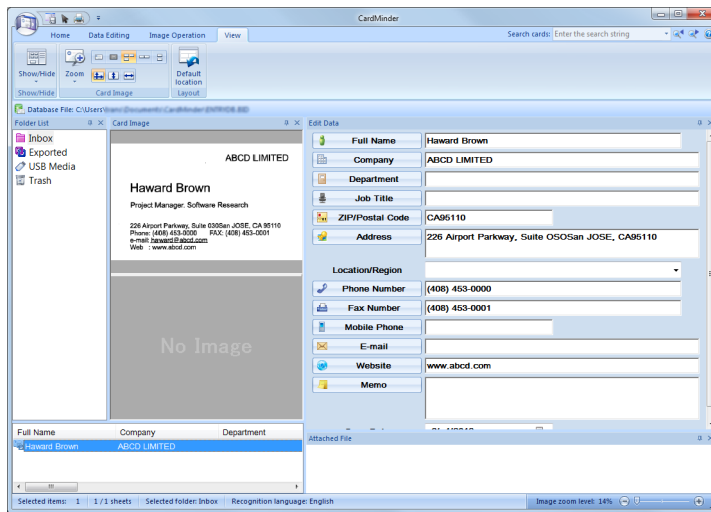

HINT

For details about the functions of CardMinder and how to use it, refer to the CardMinder User's Guide and CardMinder Help.

Saving Data in a Specified Folder

This section explains how to save the scanned image file in a specified folder. You can save the scanned image file in a shared folder on the network and share it with others. In addition, you can inform others of the destination folder path by an e-mail message automatically created with the path stated.

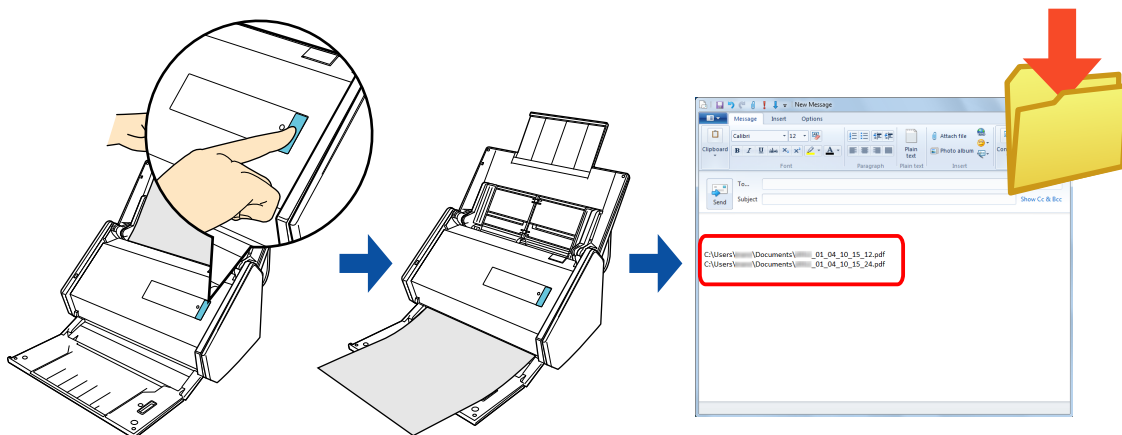

HINT

- The default e-mail program is used as the e-mail program to link with. The e-mail program may not properly link with ScanSnap Manager even if it is the default e-mail program. In this case, contact the manufacturer of the e-mail software. For configuring e-mail program settings, refer to ["E-mail Program Settings" \(page 135\)](#).
- By registering the scan and save settings as a profile, you can scan documents with the same profile at any time. For details, refer to ["Profile" \(page 203\)](#).

Procedures

HINT

To use the Quick Menu, you need to select the [Use Quick Menu] check box in the ScanSnap setup dialog box.

For details about how to perform scanning by using the Quick Menu, refer to "[Basic Scanning Operation Flow](#)" (page 114).

1. Load a document in the ScanSnap.

For details, refer to "[How to Load Documents](#)" (page 63).

2. Press the [Scan] button on the ScanSnap to start a scan.

⇒ The Quick Menu appears when the scanning is completed.



3. Click the [Scan to Folder] icon .

⇒ The [Scan to Folder] dialog box appears.

4. Check the scanned image in the preview area.

In the [Scan to Folder] dialog box, you can change files names, destination folders, and specify whether to state a path to a destination folder in an e-mail message to notify others.

For details about the [Scan to Folder] dialog box, refer to the ScanSnap Manager Help.

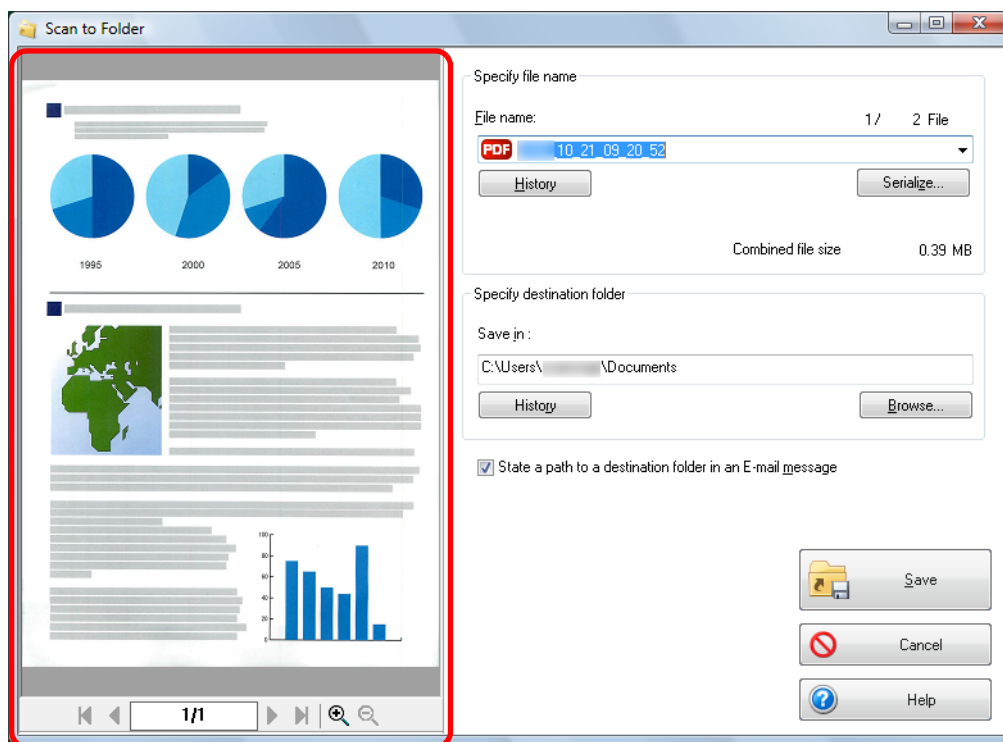

Preview

ATTENTION

- You cannot start scanning after the Quick Menu is displayed and before the [Scan to Folder] dialog box is closed. Close the [Scan to Folder] dialog box before scanning the next document.
- Do not move, delete, or rename scanned image in other applications after the Quick Menu is displayed and before the [Scan to Folder] dialog box is closed.

5. Click the [Save] button.

⇒ The scanned image file is saved in the specified folder.

HINT

When you select the [State a path to a destination folder in an E-mail message] check box in the [Scan to Folder] dialog box, a new message window appears listing the destination folder path where the file is saved.

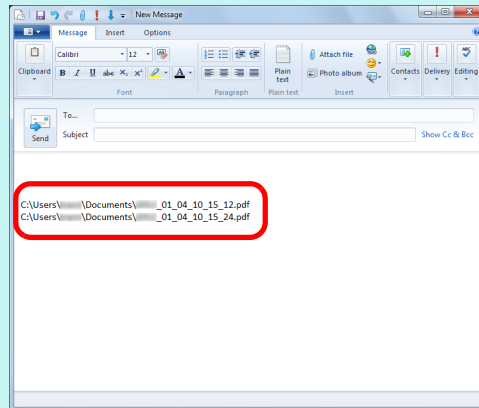

E-mail Program Settings

Configure e-mail program settings in the following procedure.

Windows 8

- 1. Right-click the Start screen, and click [All apps] on the app bar → [Set your default programs] under [Default Programs].**
⇒ The [Set Default Programs] dialog box appears.
- 2. Select an e-mail program to link with ScanSnap Manager from [Programs].**
- 3. Select [Set this program as default] and click the [OK] button.**

Windows 7/Windows Vista

- 1. Select [Start] menu → [Default Programs] → [Set your default programs].**
⇒ The [Set your default programs] dialog box appears.
- 2. Select an e-mail program to link with ScanSnap Manager from [Programs].**
- 3. Select [Set this program as default] and click the [OK] button.**

Windows XP

The e-mail program selected in Internet Explorer [Tools] menu → [Internet Options] → the [Programs] tab → [E-mail] drop-down list is used to link with ScanSnap Manager. If no e-mail program is selected, select an e-mail program to link with ScanSnap Manager in the [E-mail] drop-down list. E-mail programs that cannot be selected here cannot be set to link with ScanSnap Manager.

Tested e-mail programs

- Windows Live Mail
- Windows Mail (Windows Vista)
- Outlook 2013 /2010 / 2007 / 2003
- Outlook Express 6
- Thunderbird version 17.0.2

Attaching Files to E-Mail

This section explains how to attach the scanned image file to an e-mail message.

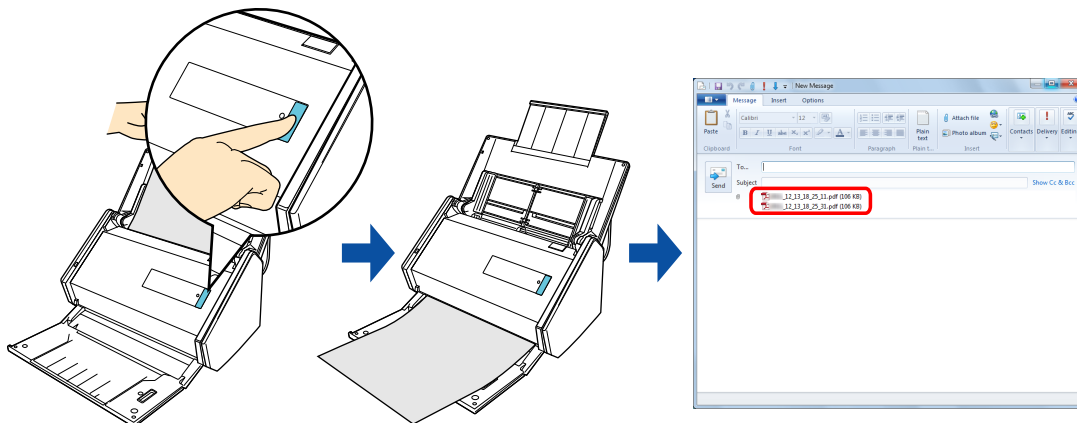

HINT

- The default e-mail program is used as the e-mail program to link with. The e-mail program may not properly link with ScanSnap Manager even if it is the default e-mail program. In this case, contact the manufacturer of the e-mail software. For configuring e-mail program settings, refer to ["E-mail Program Settings" \(page 135\)](#).
- By registering the scan and save settings as a profile, you can scan documents with the same profile at any time. For details, refer to ["Profile" \(page 203\)](#).
- ScanSnap Folder can also be used for this operation. For details, refer to ["ScanSnap Folder Operations" \(page 216\)](#).

Procedures

HINT

To use the Quick Menu, you need to select the [Use Quick Menu] check box in the ScanSnap setup dialog box.

For details about how to perform scanning by using the Quick Menu, refer to "[Basic Scanning Operation Flow](#)" (page 114).

1. Load a document in the ScanSnap.

For details, refer to "[How to Load Documents](#)" (page 63).

ATTENTION

Up to ten files can be attached to an e-mail message.

When you scan more than one document with the scan settings shown below, multiple files are created. Pay attention to the number of documents to scan:



- File format: JPEG (*.jpg)
- [Generate one PDF file per (n) page(s)] check box is selected

2. Press the [Scan] button on the ScanSnap to start a scan.

⇒ The Quick Menu appears when the scanning is completed.



To change the settings for [Scan to E-mail], move the mouse cursor to the [Scan to E-

mail] icon , and then click . For details about how to change the settings, "[Preferences](#)" (page 141).

3. Click the [Scan to E-mail] icon .

⇒ The [Scan to E-mail] dialog box appears.

HINT

You can configure the settings to not show the [Scan to E-mail] dialog box. If you configure the settings to not show the [Scan to E-mail] dialog box, a new message window appears with the file attached.

For details about how to change the settings, "[Preferences](#)" (page 141).

4. Check the scanned image in the preview area.

In the [Scan to E-mail] dialog box, you can rename the file, specify whether to set a "Document Open Password", and save the scanned image in the folder specified for [Image saving folder] after sending it by e-mail.

For details about the [Scan to E-mail] dialog box, refer to the ScanSnap Manager Help.

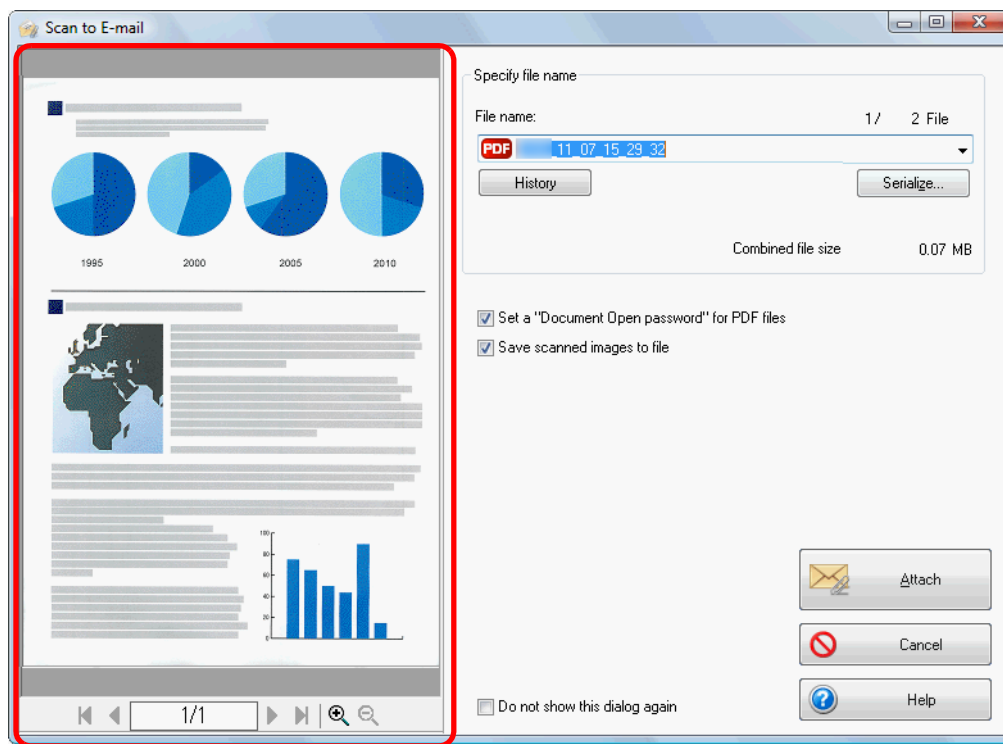

Preview

ATTENTION

- You cannot start scanning after the Quick Menu is displayed and before the [Scan to E-mail] dialog box is closed. Close the [Scan to E-mail] dialog box before scanning the next document.
- Do not move, delete, or rename scanned image in other applications after the Quick Menu is displayed and before the [Scan to E-mail] dialog box is closed.

5. Click the [Attach] button.

⇒ A new e-mail message window appears with the file attached.

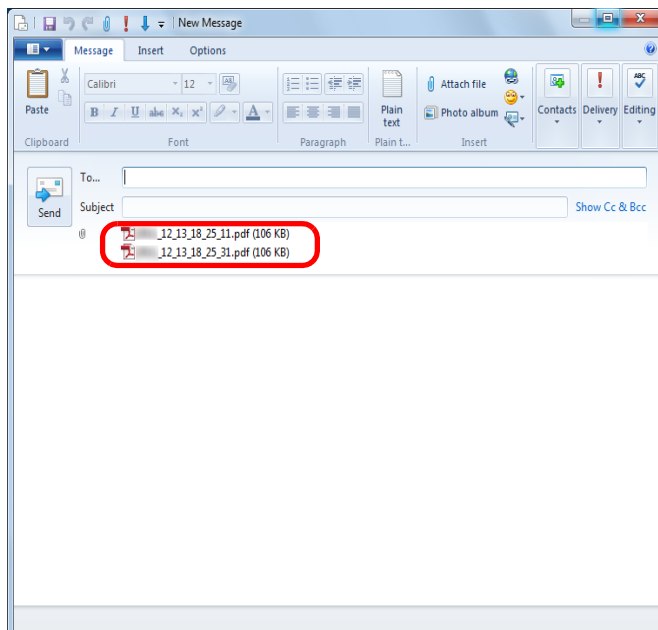

HINT

When the [Set a "Document Open password" for PDF files] check box is selected in the [Scan to E-mail - Options] dialog box or the [Scan to E-mail] dialog box, click the [Attach] button to display the following [Scan to E-mail - Set a password] dialog box.

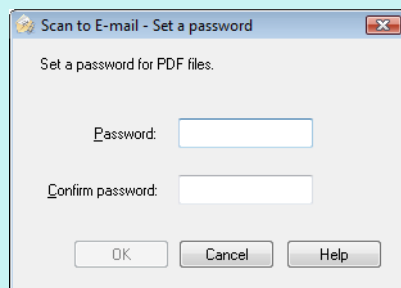



Enter a password, and then click the [OK] button.

If you click the [Cancel] button, a confirmation message appears to continue processing without a password. If you do not want to set a document open password, click the [Yes] button.

Preferences

You can configure the settings in order to link with [Scan to E-mail].

1. Move the mouse cursor to the [Scan to E-mail] icon  , and then click  .

⇒ The [Scan to E-mail - Options] dialog box appears.

2. Change the settings.

For details about the [Scan to E-mail - Options] dialog box, refer to the ScanSnap Manager Help.

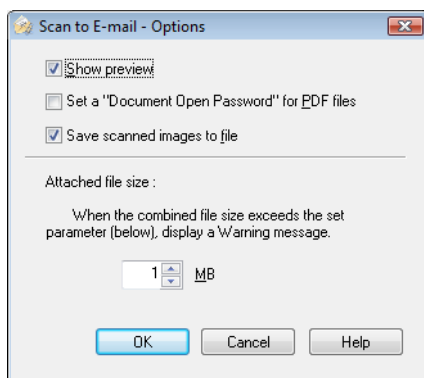

3. Click the [OK] button to close the [Scan to E-mail - Options] dialog box.

Using the ScanSnap as a Copy Machine

This section explains how to print the scanned image with a printer.

When a printer links with ScanSnap Manager, the ScanSnap can be used as a copy machine.

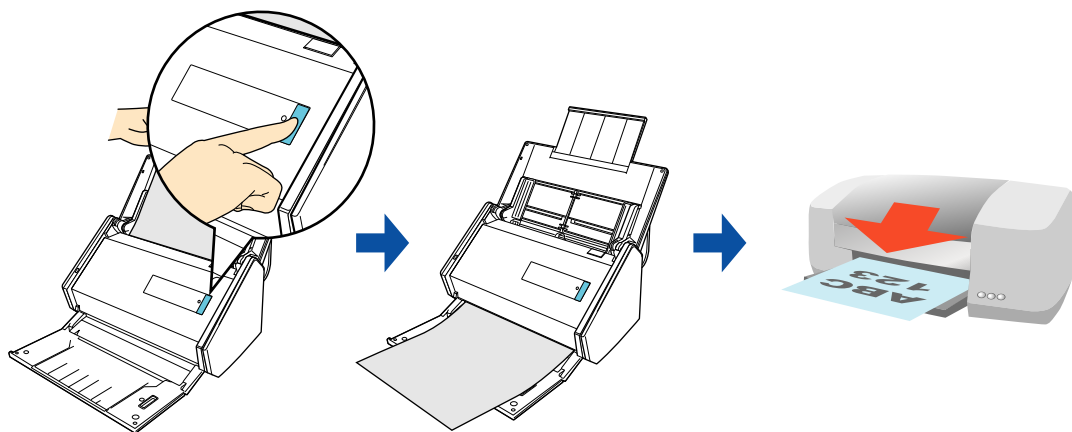

ATTENTION

- Note that shadows around the edges of the document may appear as lines on the generated scanned image, depending on the scanning method and paper conditions. If you print such an image, the printed image will also have lines appearing in it.
- The scanned image will be printed at a resolution of 150 dpi regardless of the settings specified for [Image quality] in the [Scanning] tab.

HINT

By registering the scan and save settings as a profile, you can scan documents with the same profile at any time. For details, refer to "[Profile](#)" (page 203).

Procedures

HINT

To use the Quick Menu, you need to select the [Use Quick Menu] check box in the ScanSnap setup dialog box.

For details about how to perform scanning by using the Quick Menu, refer to "[Basic Scanning Operation Flow](#)" (page 114).

1. Load a document in the ScanSnap.



For details, refer to "[How to Load Documents](#)" (page 63).

2. Press the [Scan] button on the ScanSnap to start a scan.

⇒ The Quick Menu appears when the scanning is completed.



To change the settings for [Scan to Print], move the mouse cursor to the [Scan to Print]

icon , and then click . For details about how to change the settings, "[Preferences](#)" (page 145).

3. Click the [Scan to Print] icon .

⇒ The [Scan to Print] dialog box appears.

HINT

You can configure the settings to not show the [Scan to Print] dialog box. If you configure the settings to not show the [Scan to Print] dialog box, printing is performed directly.

For details about how to change the settings, "[Preferences](#)" (page 145).

4. Check the scanned image in the preview area.

In the [Scan to Print] dialog box, you can specify the printer to be used, the number of copies and size of the scanned image to be printed, and whether to save the scanned image in the folder specified for [Image saving folder].

For details about the [Scan to Print] dialog box, refer to the ScanSnap Manager Help.

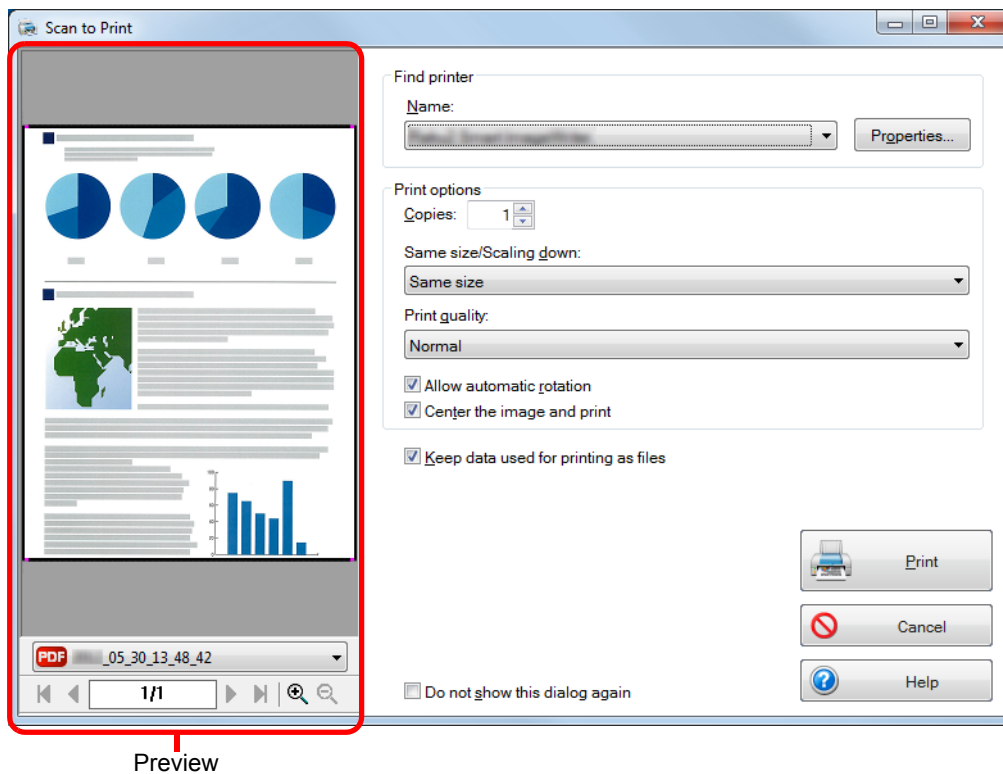

ATTENTION



- You cannot start scanning after the Quick Menu is displayed and before the [Scan to Print] dialog box is closed. Close the [Scan to Print] dialog box before scanning the next document.
- Do not move, delete, or rename the scanned image in other applications after the Quick Menu is displayed and before the [Scan to Print] dialog box is closed.

5. Click the [Print] button.

⇒ The scanned image is printed.

Preferences

You can configure the settings in order to link with [Scan to Print].

1. Move the mouse cursor to the [Scan to Print] icon  , and then click  .

⇒ The [Scan to Print - Options] dialog box appears.

2. Change the setting.

For details about the [Scan to Print - Options] dialog box, refer to the ScanSnap Manager Help.

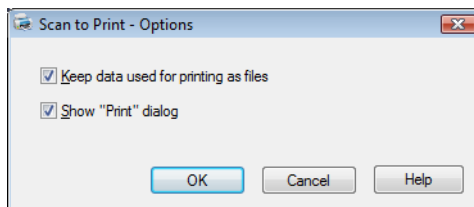

3. Click the [OK] button to close the [Scan to Print - Options] dialog box.

Saving Data in Rack2-Filer Smart

This section explains how to save image data converted into a PDF file in Rack2-Filer Smart trial version or Rack2-Filer Smart (provided with ScanSnap iX500 Deluxe or sold separately).

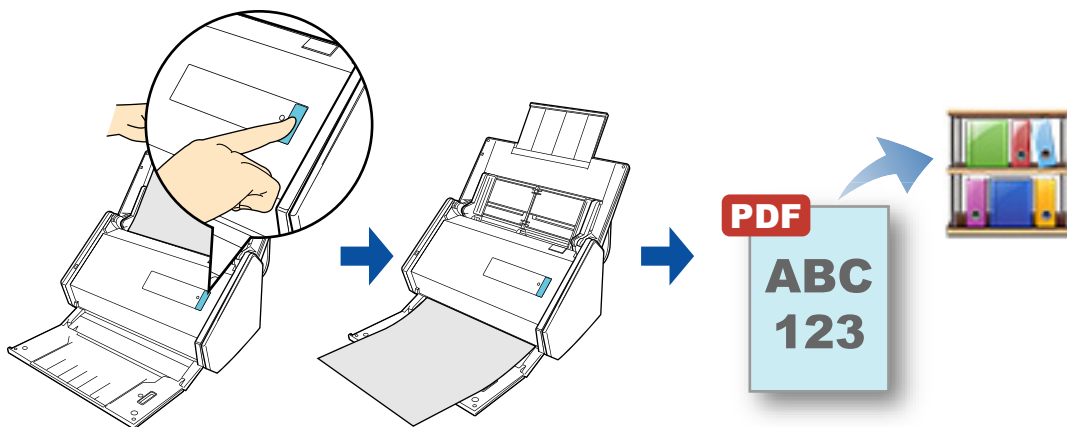

ATTENTION

- Rack2-Filer Smart trial version or Rack2-Filer Smart (provided with ScanSnap iX500 Deluxe or sold separately) is required to use this function.
Rack2-Filer Smart is an application that converts paper documents and electronic documents into PDF files and manages them in a computer. You can manage the documents as if you bind them, store them on a bookshelf, and browse them as if you flip through a book.
- The following settings in ScanSnap Manager are disabled when the scanned image is saved to Rack2-Filer Smart:
 - Rename file after scanning
 - Color high compression

HINT

- By registering the scan and save settings as a profile, you can scan documents with the same profile at any time. For details, refer to "[Profile](#)" (page 203).
- ScanSnap Folder can also be used for this operation. For details, refer to "[ScanSnap Folder Operations](#)" (page 216).
- ScanSnap Manager can link with Rack2-Filer Smart automatically. For details, refer to "[Automatic Linkage with Applications](#)" (page 276).

Procedures

ATTENTION

When you perform a scan with [JPEG(*.jpg)] selected for [File format] in the [File option] tab of the ScanSnap setup dialog box, you cannot save the image in Rack2-Filer Smart.

HINT

To use the Quick Menu, you need to select the [Use Quick Menu] check box in the ScanSnap setup dialog box.

For details about how to perform scanning by using the Quick Menu, refer to "[Basic Scanning Operation Flow](#)" (page 114).

1. Load a document in the ScanSnap.



For details, refer to "[How to Load Documents](#)" (page 63).

2. Press the [Scan] button on the ScanSnap to start a scan.

⇒ The Quick Menu appears when the scanning is completed.



To change the settings for [Scan to Rack2-Filer Smart], move the mouse cursor to the

[Scan to Rack2-Filer Smart] icon , and then click . For details about how to change the settings, "[Preferences](#)" (page 149).

ATTENTION

- You cannot start scanning when the Quick Menu is displayed. Save the scanned image to Rack2-Filer Smart before scanning another document.
- Do not move, delete or rename the scanned image in other applications when the Quick Menu is displayed.

3. Click the [Scan to Rack2-Filer Smart] icon .

- ⇒ Rack2-Filer Smart starts up, and the PDF file created by the ScanSnap is saved in Rack2-Filer Smart.

HINT

For details about how to use Rack2-Filer Smart, refer to the Rack2-Filer Smart Your Guide.

Preferences

You can configure the settings in order to link with [Scan to Rack2-Filer Smart].

1. Move the mouse cursor to the [Scan to Rack2-Filer Smart] icon , and then click .

⇒ The [ScanSnap -> Rack2-Filer Smart] dialog box appears.

2. Change the settings.

In this dialog box, specify the destination to save the scanned image.

For details about the [ScanSnap -> Rack2-Filer Smart] dialog box, refer to the Rack2-Bookshelf Window Help. To show the Rack2-Bookshelf Window Help, click the [Help] button in the [ScanSnap -> Rack2-Filer Smart] dialog box.

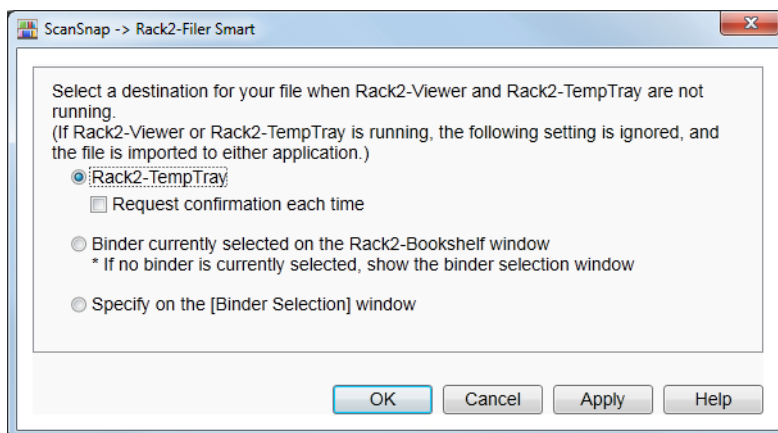

3. Click the [OK] button to close the [ScanSnap -> Rack2-Filer Smart] dialog box.

Saving Data in Magic Desktop

This section explains how to save image data converted into a PDF file or a JPEG file in Magic Desktop trial version or Magic Desktop (provided with ScanSnap iX500 Deluxe or sold separately).

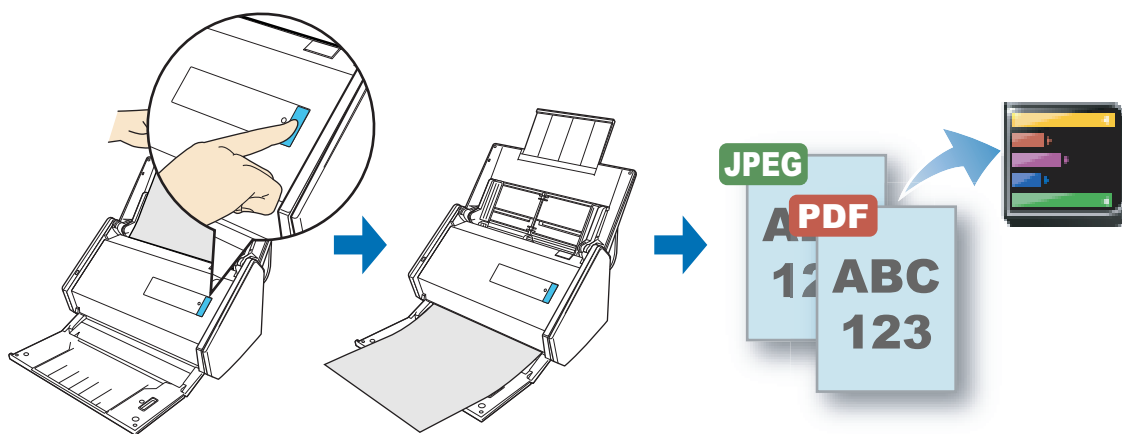

ATTENTION

- Magic Desktop trial version or Magic Desktop (provided with ScanSnap iX500 Deluxe or sold separately) is required to use this function.
Magic Desktop is an application for organizing information. You can associate scanned images from the ScanSnap or memos and images created on a mobile device with various work or personal groups, manage them, and save them to Rack2-Filer Smart. Magic Desktop can also link with Facebook.
- The following settings in ScanSnap Manager are disabled when the scanned image is saved to Magic Desktop:
 - Renaming file after scanning
 - Color high compression

HINT

- By registering the scan and save settings as a profile, you can scan documents with the same profile at any time. For details, refer to "[Profile](#)" (page 203).
- ScanSnap Folder can also be used for this operation. For details, refer to "[ScanSnap Folder Operations](#)" (page 216).
- ScanSnap Manager can link with Magic Desktop automatically. For details, refer to "[Automatic Linkage with Applications](#)" (page 276).

Procedures

HINT

To use the Quick Menu, you need to select the [Use Quick Menu] check box in the ScanSnap setup dialog box.

For details about how to perform scanning by using the Quick Menu, refer to "[Basic Scanning Operation Flow](#)" (page 114).

1. Load a document in the ScanSnap.

For details, refer to "[How to Load Documents](#)" (page 63).

2. Press the [Scan] button on the ScanSnap to start a scan.

⇒ The Quick Menu appears when the scanning is completed.



ATTENTION

- You cannot start scanning when the Quick Menu is displayed. Save the scanned image to Magic Desktop before scanning another document.
- Do not move, delete or rename the scanned image in other applications when the Quick Menu is displayed.

3. Click the [Scan to Magic Desktop] icon .

⇒ Magic Desktop starts up, and the scanned image created by the ScanSnap is saved in Magic Desktop.

HINT

For details about how to use Magic Desktop, refer to the Magic Desktop Your Guide.

Saving Data to a Mobile Device

This section explains how to save the scanned image as a PDF or a JPEG file to a mobile device.

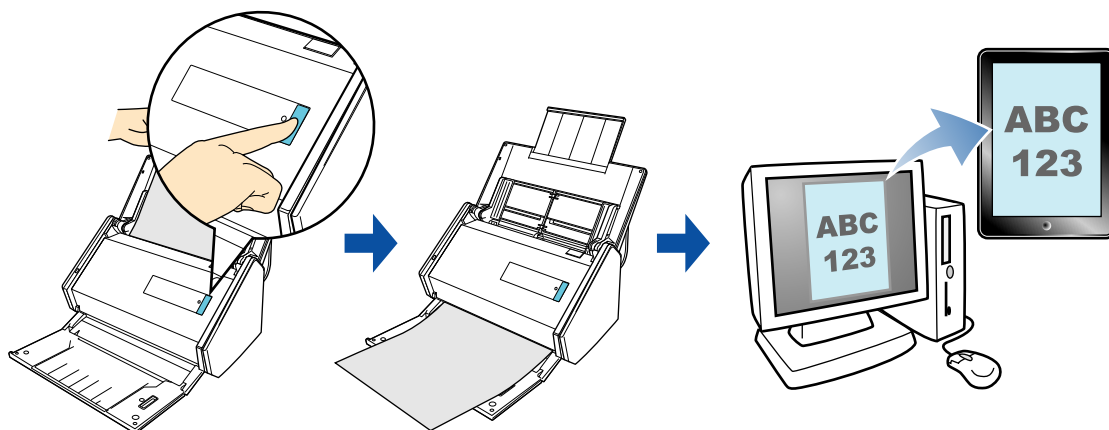

ATTENTION

- Only one mobile device can be connected to the computer.
- You need to have .NET Framework 3.0 installed in order to use this function.
Note that .NET Framework 3.0 is also included in .NET Framework 3.5 (SP1 or later). It is recommended that you use .NET Framework 3.5 (SP1 or later) by updating Windows. If .NET Framework 4 or later is already installed, you need to install .NET Framework 3.0 separately because .NET Framework 3.0 is not included in .NET Framework 4 or later version.
- You need to have ScanSnap Connect Application installed on the mobile device in order to use this function. Download ScanSnap Connect Application for the mobile device from an application store such as iTunes, the App Store or Google Play.
For information about the operating system that ScanSnap Connect Application supports, please visit the following web page:
<http://scansnap.fujitsu.com/g-support/en/>
- The number of scanned image files and the maximum file size that can be saved on a mobile device at once are as follows:
 - Number of files: Up to 100
 - File size: 2048 MB

HINT

- By connecting the ScanSnap and a mobile device via wireless LAN, you can save scanned images to the mobile device without passing through a computer. For details about how to configure settings, refer to "[Connecting the ScanSnap to a Wireless LAN](#)" (page 50).
- When you first launch [Scan to Mobile], a message appears. When [Scan to Mobile] is running, an icon is displayed in the notification area. For details, refer to "[Before Using \[Scan to Mobile\]](#)" (page 153).
- By registering the scan and save settings as a profile, you can scan documents with the same profile at any time. For details, refer to "[Profile](#)" (page 203).

This section describes the basic procedures and the procedures for automatic linkage with applications.

- Procedures (→ [page 155](#))
- Automatic Linkage (→ [page 158](#))

Before Using [Scan to Mobile]

First launch

- A firewall alert may be displayed. When the alert is displayed, select [Allow access] or [Unblock] buttons to continue processing.
- The following message appears. Click the [OK] button to open the [Scan to Mobile - Basic] dialog box.

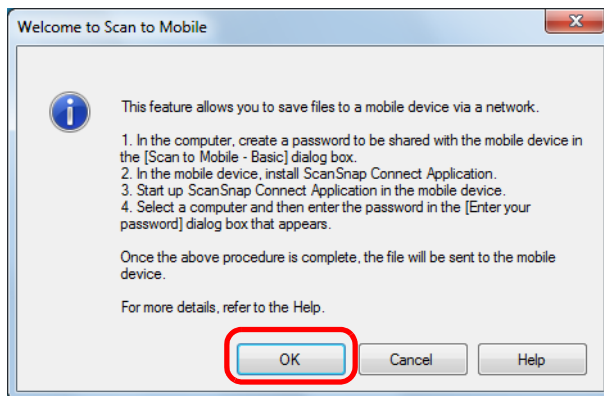

In the [Scan to Mobile - Basic] dialog box, enter a password to connect to the mobile device.



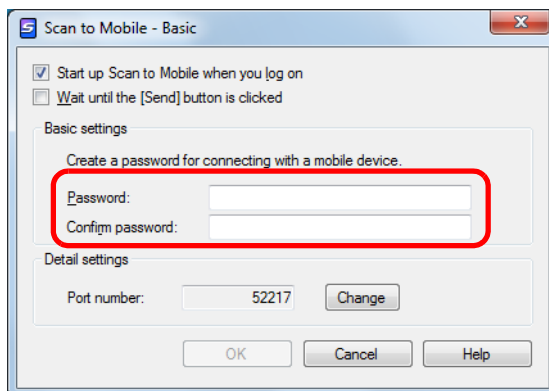

For details about other setting items, refer to the Scan to Mobile Help.



[Scan to Mobile] icon

When [Scan to Mobile] is running, click  in the notification area to display the [Scan to Mobile] icon in the displayed menu.

The [Scan to Mobile] icon shows the communication status between the computer and the mobile device. The appearance of the icon changes according to the communication status as shown below.

Status	[Scan to Mobile] icon
Waiting	
Standby	
Sending	
Sending error	
Rejected	

Procedures

HINT

To use the Quick Menu, you need to select the [Use Quick Menu] check box in the ScanSnap setup dialog box.

For details about how to perform scanning by using the Quick Menu, refer to "[Basic Scanning Operation Flow](#)" (page 114).

1. Load a document in the ScanSnap.



For details, refer to "[How to Load Documents](#)" (page 63).

2. Press the [Scan] button on the ScanSnap to start a scan.

⇒ The Quick Menu appears when the scanning is completed.



To change the settings for [Scan to Mobile], move the mouse cursor to the [Scan to

Mobile] icon , and then click . For details about how to change the settings, "[Preferences](#)" (page 160).

ATTENTION

- When [Scan to Mobile] has already started and is active (with the application selected on the taskbar and the [Scan to Mobile] dialog box brought to front), ScanSnap Manager links with [Scan to Mobile] automatically and the Quick Menu does not appear. To show the Quick Menu, minimize the [Scan to Mobile] dialog box first, and then try scanning again.
- You cannot start scanning when the Quick Menu is displayed. Wait until ScanSnap Manager links with [Scan to Mobile] before scanning another document.
- Do not move, delete or rename the scanned image in other applications when the Quick Menu is displayed.

3. Click the [Scan to Mobile] icon .

⇒ The [Scan to Mobile] dialog box appears.

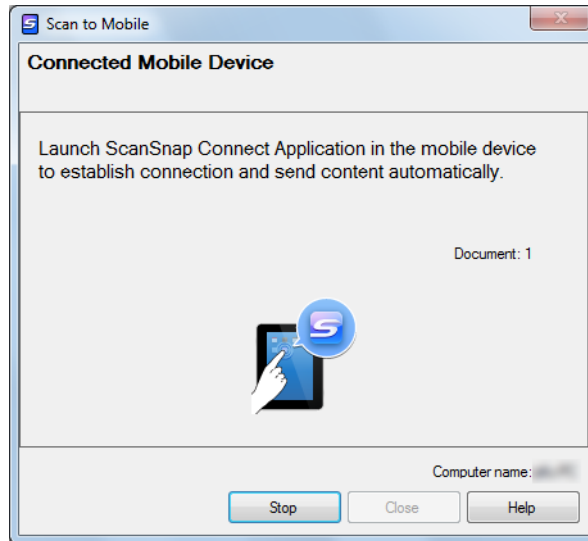

4. Connect to the computer from your mobile device.

For details about how to connect to the computer from your mobile device, refer to the ScanSnap Connect Application User's Guide for your mobile device.

- ⇒ When the connection is established, the [Scan to Mobile] dialog box appears showing the mobile device that is currently connected to the computer. Then, the scanned image is sent to the mobile device.

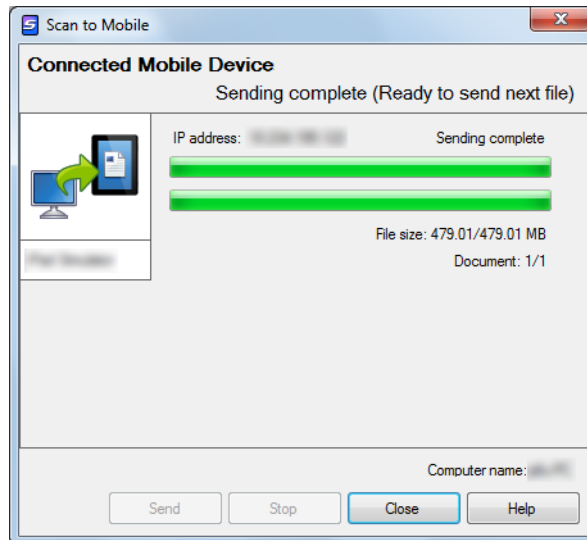

HINT

- When you select the [Wait until the [Send] button is clicked] check box in the [Scan to Mobile - Basic] dialog box, the [Send] button appears in the [Scan to Mobile] dialog box. Click the [Send] button to send the image to the mobile device.
- For details about the features of ScanSnap Connect Application for mobile devices and how to use it, refer to the ScanSnap Connect Application User's Guide for your mobile device.

5. Click the [Close] button to close the [Scan to Mobile] dialog box when sending of the scanned image is completed.

HINT

The [Scan to Mobile] dialog box closes automatically when the mobile device is disconnected from the computer.

Automatic Linkage

HINT

- For details about the features of ScanSnap Connect Application for mobile devices and how to use it, refer to the ScanSnap Connect Application User's Guide for your mobile device.
- For details about automatic linkage to active applications, refer to "[Automatic Linkage with Applications](#)" (page 276).

1. Select [Start] menu → [All Programs] → [ScanSnap Manager] → [Scan to Mobile] (for Windows 8, right-click the Start screen, and select [All apps] on the app bar → [Scan to Mobile] under [ScanSnap Manager]).

⇒ The Scan to Mobile icon  appears in the notification area.



2. Connect to the computer from your mobile device.

For details about how to connect to the computer from your mobile device, refer to the ScanSnap Connect Application User's Guide for your mobile device.

⇒ The [Scan to Mobile] dialog box appears on your computer.

When the connection is established, the mobile device that is currently connected to the computer is shown in the [Scan to Mobile] dialog box.

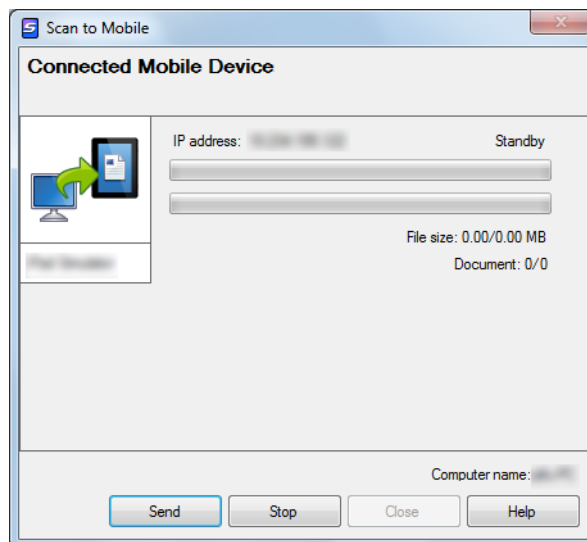

3. Load a document in the ScanSnap.

For details, refer to "[How to Load Documents](#)" (page 63).

4. Press the [Scan] button on the ScanSnap to start a scan.

ATTENTION

To enable automatic linkage with Scan to Mobile, press the [Scan] button on the ScanSnap and start a scan while [Scan to Mobile] is active (where this application is currently selected on the taskbar and the [Scan to Mobile] dialog box is brought to front).

- ⇒ Scanned images will be sent to the mobile device from the computer when the scanning is completed.

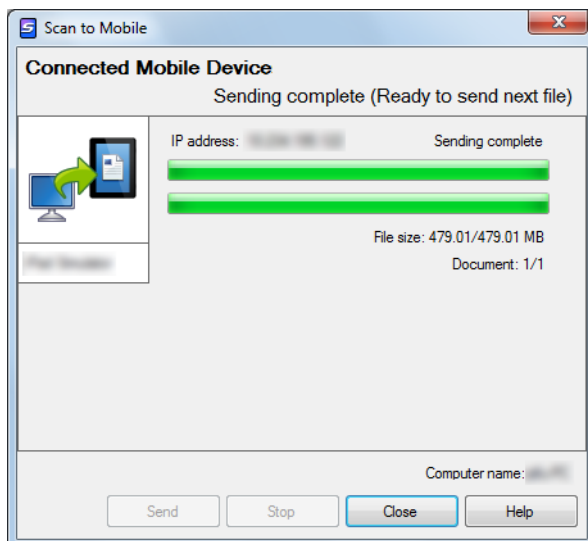

HINT

When you select the [Wait until the [Send] button is clicked] check box in the [Scan to Mobile - Basic] dialog box, the [Send] button appears in the [Scan to Mobile] dialog box. Click the [Send] button to send the image to the mobile device.



5. Click the [Close] button to close the [Scan to Mobile] dialog box when sending of the scanned image is completed.

HINT

The [Scan to Mobile] dialog box closes automatically when the mobile device is disconnected from the computer.

Preferences

You can configure the settings in order to link with [Scan to Mobile].

1. Move the mouse cursor to the [Scan to Mobile] icon , and then click .

⇒ The [Scan to Mobile - Options] dialog box appears.

2. Change the settings.

For details about the [Scan to Mobile - Options] dialog box, refer to the ScanSnap Manager Help.

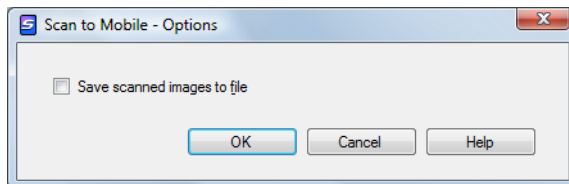

3. Click the [OK] button to close the [Scan to Mobile - Options] dialog box.

Saving Data to Your Dropbox Folder

This section explains how to save the scanned image as a PDF or a JPEG file to your Dropbox folder.

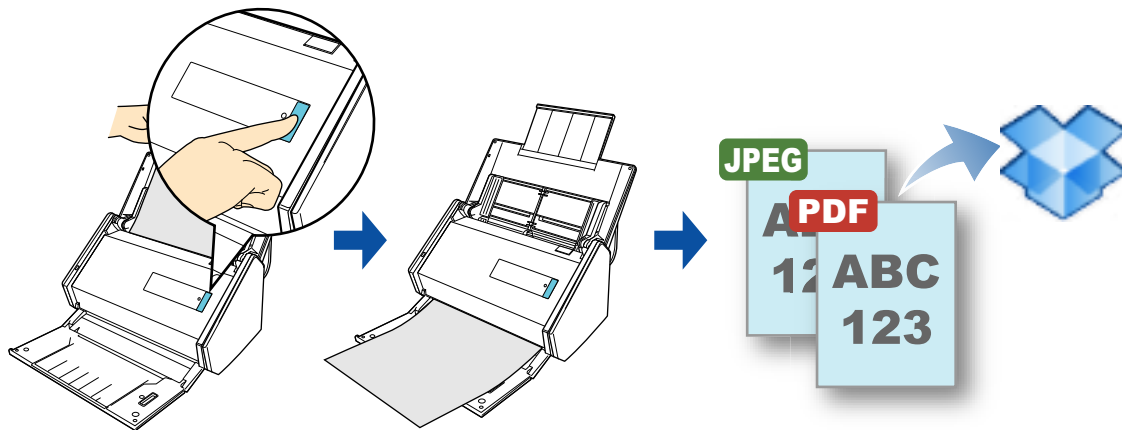

ATTENTION

- You need to have a Dropbox account.
- You need to have Dropbox for Windows 1.1.45 or later installed in order to use this function.
- You can save up to 100 files to your Dropbox folder at once.

HINT

- When you first log into Dropbox after installing Dropbox for Windows, the Dropbox folder, which is the sync folder used for Dropbox, is automatically created.
- By registering the scan and save settings as a profile, you can scan documents with the same profile at any time. For details, refer to ["Profile" \(page 203\)](#).
- ScanSnap Folder can also be used for this operation. For details, refer to ["ScanSnap Folder Operations" \(page 216\)](#).

Procedures

HINT

To use the Quick Menu, you need to select the [Use Quick Menu] check box in the ScanSnap setup dialog box.

For details about how to perform scanning by using the Quick Menu, refer to "[Basic Scanning Operation Flow](#)" (page 114).

1. Load a document in the ScanSnap.



For details, refer to "[How to Load Documents](#)" (page 63).

2. Press the [Scan] button on the ScanSnap to start a scan.

⇒ The Quick Menu appears when the scanning is completed.



To change the settings for [Scan to Dropbox], move the mouse cursor to the [Scan to

Dropbox] icon , and then click . For details about how to change the settings, "[Preferences](#)" (page 164).

3. Click the [Scan to Dropbox] icon .

⇒ The [Scan to Dropbox] dialog box appears.

HINT

You can configure the settings to not show the [Scan to Dropbox] dialog box. If you configure the settings to not show the [Scan to Dropbox] dialog box, scanned images are saved directly to the Dropbox folder.

For details about how to change the settings, "[Preferences](#)" (page 164).

4. Check the scanned image in the preview area.

In the [Scan to Dropbox] dialog box, you can rename the file and specify your Dropbox folder.

For details about the [Scan to Dropbox] dialog box, refer to the ScanSnap Manager Help.

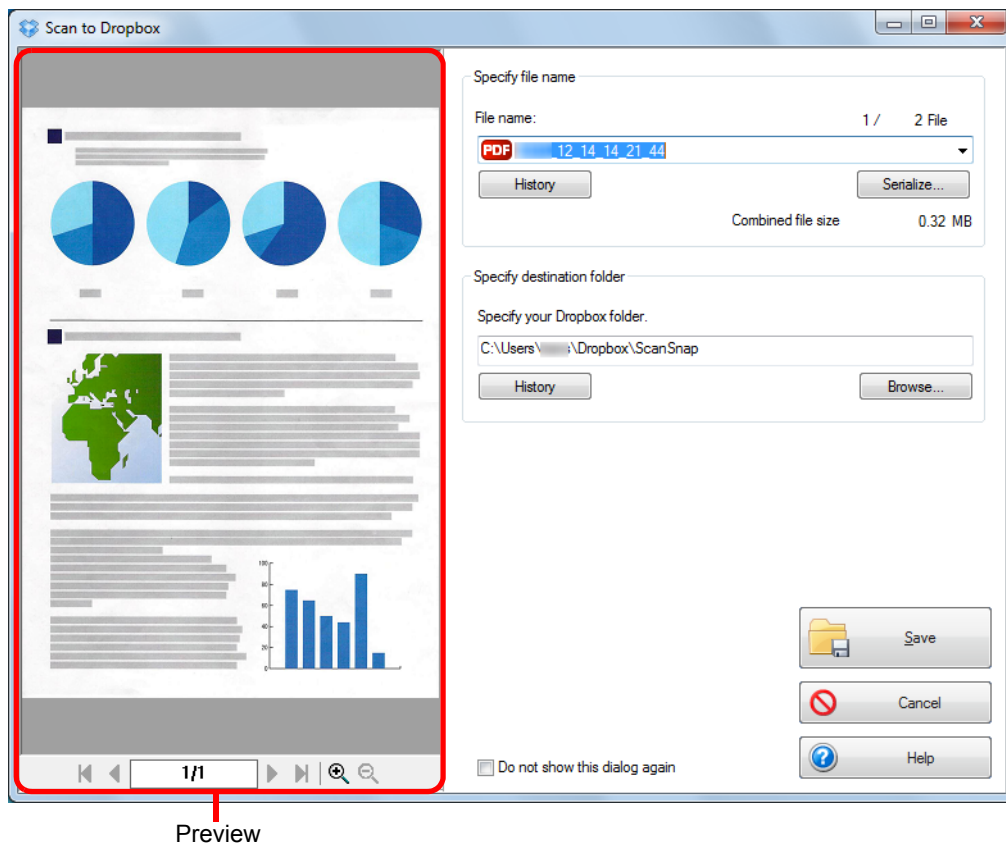

ATTENTION



- The file will not be synced with Dropbox unless you select the Dropbox folder as the destination folder.
- You cannot start scanning after the Quick Menu is displayed and before the [Scan to Dropbox] dialog box is closed. Close the [Scan to Dropbox] dialog box before scanning the next document.
- Do not move, delete or rename the scanned image in other applications after the Quick Menu is displayed and before the [Scan to Dropbox] dialog box is closed.

5. Click the [Save] button.

⇒ The scanned image is saved to your Dropbox folder.

Preferences

You can configure the settings in order to link with [Scan to Dropbox].

- 1. Move the mouse cursor to the [Scan to Dropbox] icon , and then click .**

⇒ The [Scan to Dropbox - Options] dialog box appears.

- 2. Change the setting.**

For details about the [Scan to Dropbox - Options] dialog box, refer to the ScanSnap Manager Help.

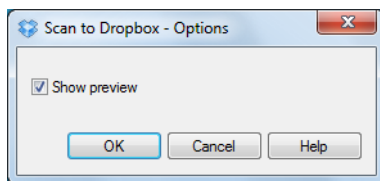

- 3. Click the [OK] button to close the [Scan to Dropbox - Options] dialog box.**

Saving Documents to Evernote

This section explains how to save the scanned image as a PDF file to Evernote.

When you save a scanned image to Evernote after converting it into a searchable PDF, the PDF file becomes searchable in Evernote.

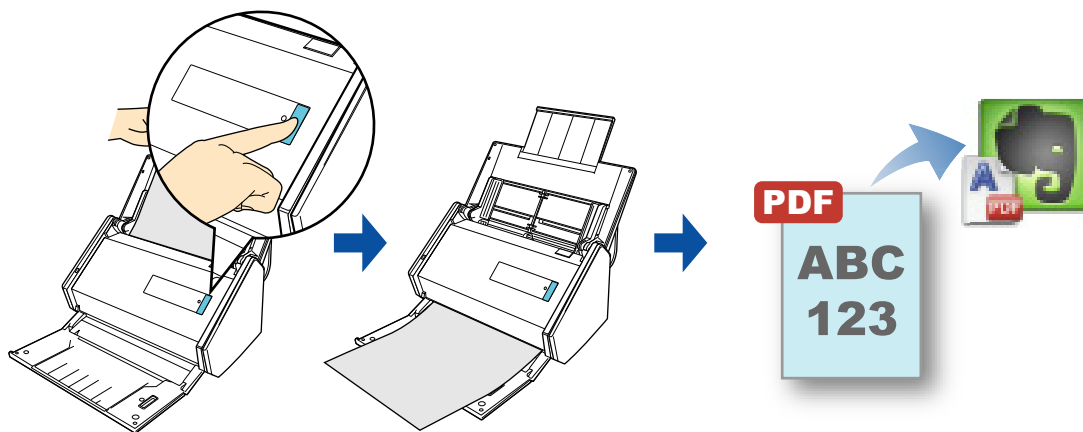

ATTENTION

- You need to create an Evernote account (free or paid).
- You first need to sign in to Evernote for Windows to save a file to Evernote.

HINT

- By registering the scan and save settings as a profile, you can scan documents with the same profile at any time. For details, refer to "[Profile](#)" (page 203).
- ScanSnap Folder can also be used for this operation. For details, refer to "[ScanSnap Folder Operations](#)" (page 216).

Procedures

HINT

To use the Quick Menu, you need to select the [Use Quick Menu] check box in the ScanSnap setup dialog box.

For details about how to perform scanning by using the Quick Menu, refer to "[Basic Scanning Operation Flow](#)" (page 114).

1. Load a document in the ScanSnap.

For details, refer to "[How to Load Documents](#)" (page 63).

2. Press the [Scan] button on the ScanSnap to start a scan.

⇒ The Quick Menu appears when the scanning is completed.



To change the settings for [Scan to Evernote (Document)], move the mouse cursor to

the [Scan to Evernote (Document)] icon  , and then click  . For details about how to change the settings, "[Preferences](#)" (page 168).

ATTENTION

- You cannot start scanning when the Quick Menu is displayed. Save the PDF file to Evernote before scanning the next document.
- Do not move, delete or rename the scanned image in other applications when the Quick Menu is displayed.

3. Click the [Scan to Evernote (Document)] icon .

⇒ Text recognition is performed. The following dialog box appears during text recognition.

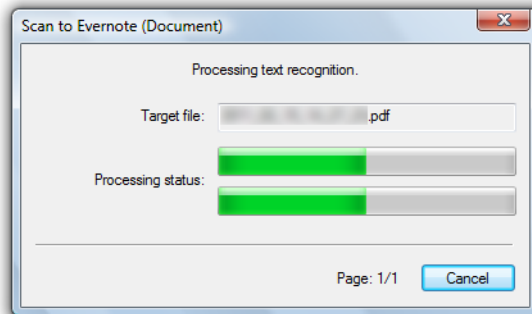

HINT

- If [JPEG(*.jpg)] is selected for [File format] in the [File option] tab of the ScanSnap setup dialog box, a separate PDF file will be created from each JPEG file. The following dialog box appears during file creation.

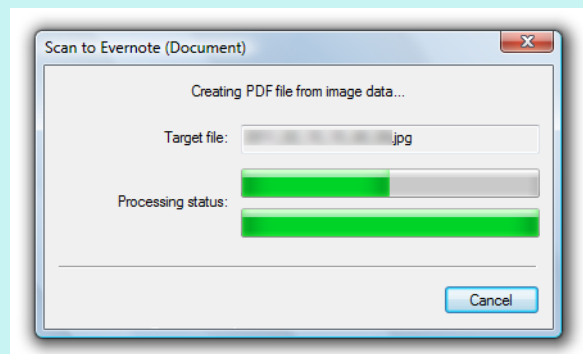

- Note that text recognition will be performed only on pages containing text which is not yet recognized.

⇒ Evernote for Windows starts up, and the PDF file is saved to Evernote.

HINT

The file in which the scanned image is saved remains in the folder specified for [Image saving folder] in the [Save] tab of the ScanSnap setup dialog box even after the scanned image is saved to Evernote. Delete this file if unnecessary.

Preferences

You can configure the settings in order to link with [Scan to Evernote (Document)].

1. Move the mouse cursor to the [Scan to Evernote (Document)] icon



⇒ The [Scan to Evernote - Options] dialog box appears.

2. Change the settings.

For details about the [Scan to Evernote - Options] dialog box, refer to the ScanSnap Manager Help.

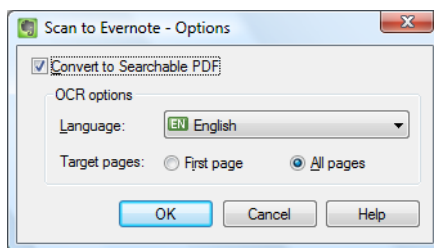

3. Click the [OK] button to close the [Scan to Evernote - Options] dialog box.

Saving Handwritten Notes to Evernote

This section explains how to save the scanned image as a JPEG file to Evernote. When you save a JPEG file to Evernote, text recognition is performed on all text, including handwritten characters, and the file becomes searchable in Evernote.

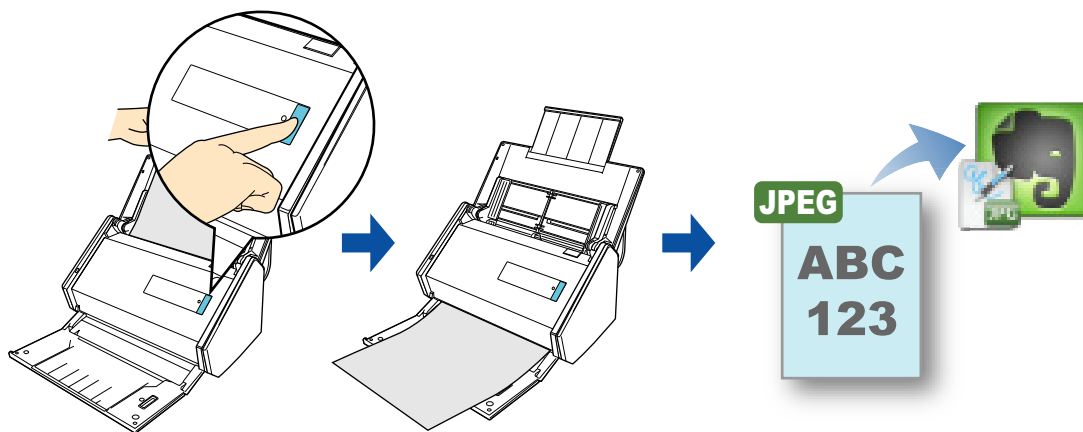

ATTENTION

- You need to create an Evernote account (free or paid).
- You first need to sign in to Evernote for Windows to save a file to Evernote.

HINT

- By registering the scan and save settings as a profile, you can scan documents with the same profile at any time. For details, refer to "[Profile](#)" (page 203).
- ScanSnap Folder can also be used for this operation. For details, refer to "[ScanSnap Folder Operations](#)" (page 216).

Procedures

HINT

To use the Quick Menu, you need to select the [Use Quick Menu] check box in the ScanSnap setup dialog box.

For details about how to perform scanning by using the Quick Menu, refer to "[Basic Scanning Operation Flow](#)" (page 114).

1. Load a document in the ScanSnap.

For details, refer to "[How to Load Documents](#)" (page 63).

2. Press the [Scan] button on the ScanSnap to start a scan.

⇒ The Quick Menu appears when the scanning is completed.



ATTENTION

- You cannot start scanning when the Quick Menu is displayed. Save the JPEG file to Evernote before scanning the next document.
- Do not move, delete or rename the scanned image in other applications when the Quick Menu is displayed.

3. Click the [Scan to Evernote (Note)] icon .

⇒ Evernote for Windows starts up, and the JPEG file is saved to Evernote.

HINT

- When you select [PDF(*.pdf)] for [File format] in the [File option] tab of the ScanSnap setup dialog box, a JPEG file is created from a PDF file. A single JPEG file is created for each page of the PDF file.

The following dialog box appears during file creation.

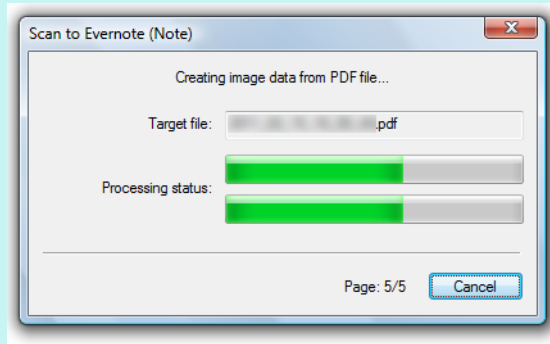

- When you select [PDF(*.pdf)] for [File format] in the [File option] tab of the ScanSnap setup dialog box, a four-digit serial number is automatically added to the name of the file which is saved to Evernote.
e.g. When the file name is [ScanSnap], the file is saved as:
ScanSnap_0001, ScanSnap_0002, ScanSnap_0003...
- The file in which the scanned image is saved remains in the folder specified for [Image saving folder] in the [Save] tab of the ScanSnap setup dialog box even after the scanned image is saved to Evernote. Delete this file if unnecessary.

Saving Documents to Google Docs

This section explains how to save the scanned image as a PDF file to Google Docs.

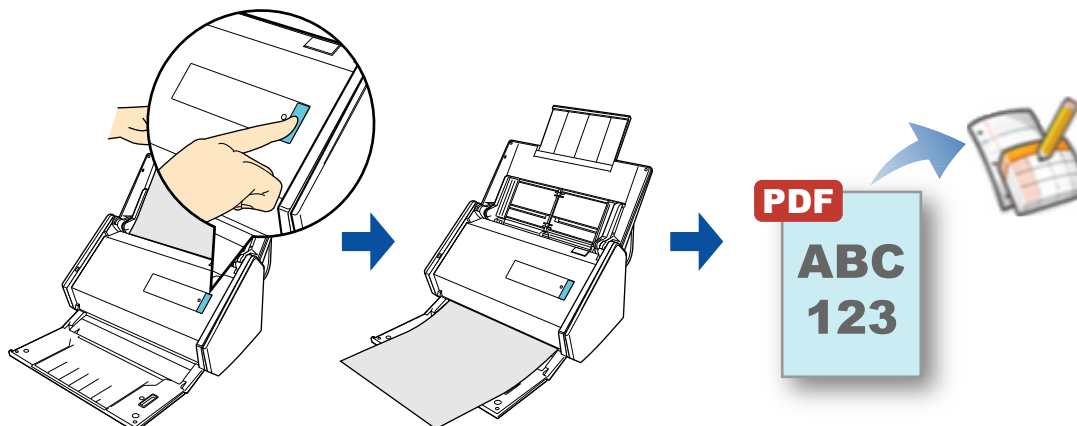

ATTENTION

- You need to create a Google account (free).
- You need to have .NET Framework 3.0 installed in order to use this function.
Note that .NET Framework 3.0 is also included in .NET Framework 3.5 (SP1 or later). It is recommended that you use .NET Framework 3.5 (SP1 or later) by updating Windows.
If .NET Framework 4 or later is already installed, you need to install .NET Framework 3.0 separately because .NET Framework 3.0 is not included in .NET Framework 4 or later version.

HINT

- By registering the scan and save settings as a profile, you can scan documents with the same profile at any time. For details, refer to "[Profile](#)" (page 203).
- ScanSnap Folder can also be used for this operation. For details, refer to "[ScanSnap Folder Operations](#)" (page 216).

Procedures

HINT

To use the Quick Menu, you need to select the [Use Quick Menu] check box in the ScanSnap setup dialog box.

For details about how to perform scanning by using the Quick Menu, refer to "[Basic Scanning Operation Flow](#)" (page 114).

1. Load a document in the ScanSnap.



For details, refer to "[How to Load Documents](#)" (page 63).

2. Press the [Scan] button on the ScanSnap to start a scan.

⇒ The Quick Menu appears when the scanning is completed.



To change the settings for [Scan to Google Docs(TM)], move the mouse cursor to the

[Scan to Google Docs(TM)] icon , and then click . For details about how to change the settings, "[Preferences](#)" (page 176).

ATTENTION

- You cannot start scanning when the Quick Menu is displayed. Save the PDF file to Google Docs before scanning the next document.
- Do not move, delete or rename the scanned image in other applications when the Quick Menu is displayed.

3. Click the [Scan to Google Docs(TM)] icon



⇒ The [Scan to Google Docs(TM)] dialog box appears.

4. Enter your e-mail address and password, and then click the [OK] button.

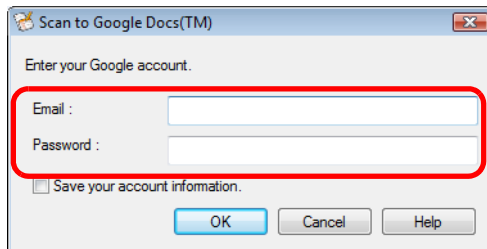

ATTENTION

- If the computer is shared with other users, do not select the [Save your account information.] check box in this dialog box. Otherwise, other users will be able to log into Google Docs automatically.
- Scan to Google Docs(TM) is not available in a proxy environment that requires authentication upon connecting to the Internet.

HINT

If you specify a Google account in the [Scan to Google Docs(TM) - Options] dialog box, the [Scan to Google Docs(TM)] dialog box does not appear.

⇒ Text recognition is performed. The following dialog box appears during text recognition.

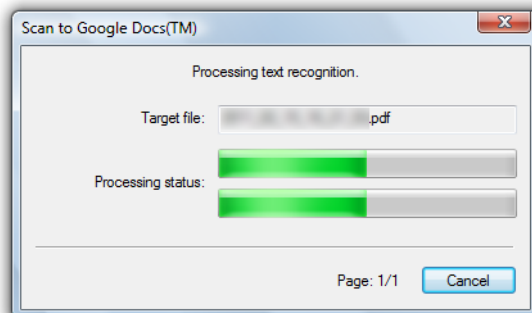

HINT

- If [JPEG(*.jpg)] is selected for [File format] in the [File option] tab of the ScanSnap setup dialog box, a separate PDF file will be created from each JPEG file. The following dialog box appears during file creation.

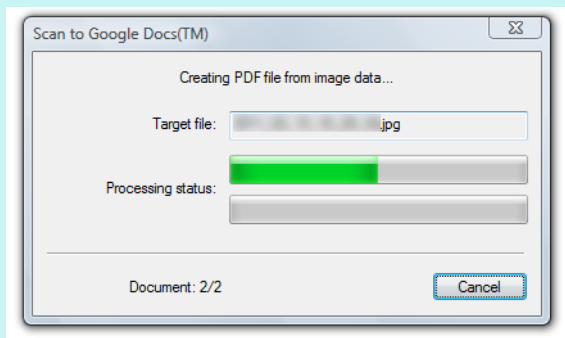

- Note that text recognition will be performed only on pages containing text which is not yet recognized.

⇒ Saving to Google Docs starts.

Click the [Close] button to close the [Scan to Google Docs(TM)] dialog box when the saving is completed.

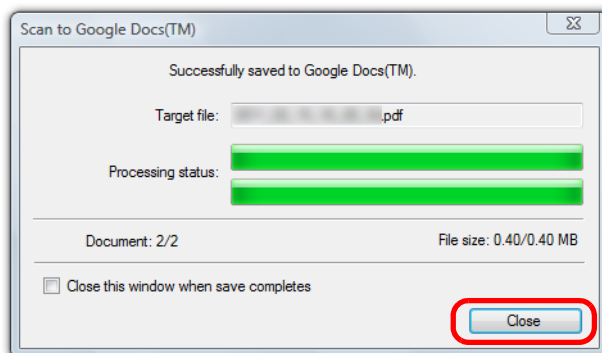

HINT

If you select the [Close this window when save completes] check box in the [Scan to Google Docs(TM)] dialog box, the [Scan to Google Docs(TM)] dialog box will automatically close from next scanning on when the saving is completed.

HINT

Google Docs does not start up after the saving has completed. To check the saved PDF file, start a web browser and log into Google Docs.

Preferences

You can configure the settings in order to link with [Scan to Google Docs(TM)].

1. Move the mouse cursor to the [Scan to Google Docs(TM)] icon , and then click .

⇒ The [Scan to Google Docs(TM) - Options] dialog box appears.

2. Change the settings.

For details about the [Scan to Google Docs(TM) - Options] dialog box, refer to the ScanSnap Manager Help.

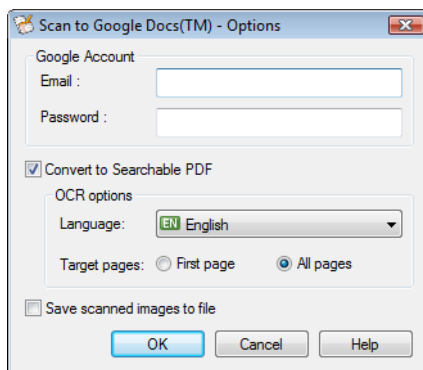

ATTENTION

If the computer is shared with other users, do not set your information in [Email] and [Password]. Otherwise, other users will be able to log into Google Docs automatically. It is recommended to set only [Email] in this dialog box, and type in the password every time.

3. Click the [OK] button to close the [Scan to Google Docs(TM) - Options] dialog box.

Posting to Salesforce Chatter

This section explains how to post a scanned image as a PDF or a JPEG file to Salesforce Chatter.

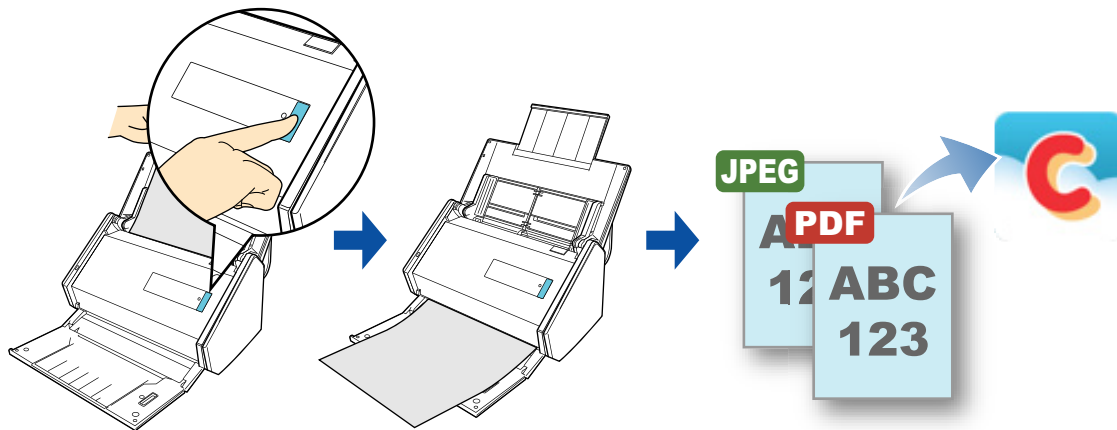

ATTENTION

- A Salesforce CRM license is required separately.
- ScanSnap Manager can link with the following Salesforce editions:
 - Unlimited
 - Enterprise
- You need to have .NET Framework 3.0 installed in order to use this function.
Note that .NET Framework 3.0 is also included in .NET Framework 3.5 (SP1 or later). It is recommended that you use .NET Framework 3.5 (SP1 or later) by updating Windows.
If .NET Framework 4 or later is already installed, you need to install .NET Framework 3.0 separately because .NET Framework 3.0 is not included in .NET Framework 4 or later version.
- A maximum of 100 scanned image files can be posted to Salesforce Chatter at once.

HINT

- By registering the scan and save settings as a profile, you can scan documents with the same profile at any time. For details, refer to "[Profile](#)" (page 203).
- ScanSnap Folder can also be used for this operation. For details, refer to "[ScanSnap Folder Operations](#)" (page 216).

Procedures

HINT

To use the Quick Menu, you need to select the [Use Quick Menu] check box in the ScanSnap setup dialog box.

For details about how to perform scanning by using the Quick Menu, refer to "[Basic Scanning Operation Flow](#)" (page 114).

1. Load a document in the ScanSnap.



For details, refer to "[How to Load Documents](#)" (page 63).

2. Press the [Scan] button on the ScanSnap to start a scan.

⇒ The Quick Menu appears when the scanning is completed.



To change the settings for [Scan to Salesforce Chatter], move the mouse cursor to the

[Scan to Salesforce Chatter] icon , and then click . For details about how to change the settings, "[Preferences](#)" (page 182).

3. Click the [Scan to Salesforce Chatter] icon .

⇒ The [Scan to Salesforce Chatter - Login] dialog box appears.

4. Enter your user name and password, and then click the [OK] button.

Enter a security token if needed.

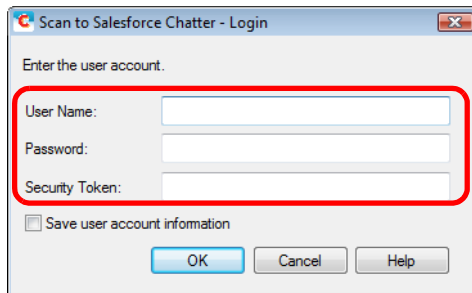

ATTENTION

- If the computer is shared with other users, do not select the [Save user account information] check box in this dialog box. Otherwise, other users will be able to log into Salesforce automatically.
- Scan to Salesforce Chatter is not available in a proxy environment that requires authentication upon connecting to the Internet.

HINT

If you specify a Salesforce account in the [Scan to Salesforce Chatter - Options] dialog box, the [Scan to Salesforce Chatter - Login] dialog box does not appear.

⇒ The [Scan to Salesforce Chatter] dialog box appears.

5. Check the scanned image in the preview area.

In the [Scan to Salesforce Chatter] dialog box, you can set the posting destination and method, the message to post, the name and description of the image file that will be posted to Salesforce Chatter, and whether to save the scanned image in the folder specified for [Image saving folder].

For details about the [Scan to Salesforce Chatter] dialog box, refer to the ScanSnap Manager Help.

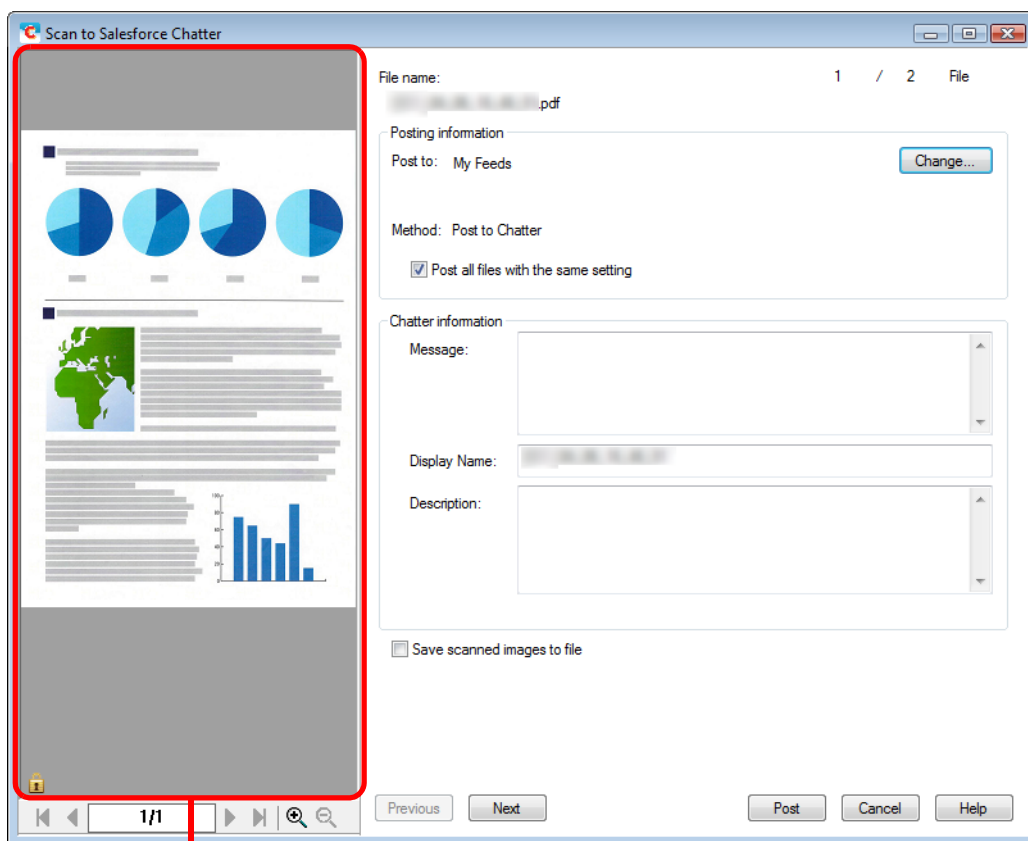

Preview

ATTENTION

- You cannot start scanning after the Quick Menu is displayed and before the [Scan to Salesforce Chatter] dialog box is closed. Close the [Scan to Salesforce Chatter] dialog box before scanning the next document.
- Do not move, delete or rename the scanned image in other applications when the Quick Menu is displayed.

6. Click the [Post] button.

⇒ Posting to Salesforce Chatter starts.

Click the [Close] button to close the [Scan to Salesforce Chatter] dialog box when the posting is completed.

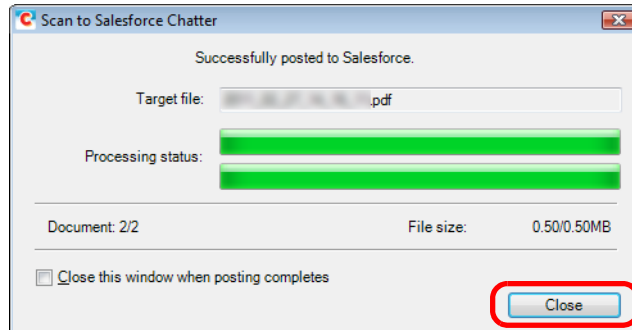



HINT

- If you select the [Close this window when posting completes] check box above, the [Scan to Salesforce Chatter] dialog box will automatically close from next scanning on when the posting is completed.
- Salesforce does not start up after the posting has completed. To check the saved scanned image file, start a web browser and log into Salesforce.

Preferences

You can configure the settings in order to link with [Scan to Salesforce Chatter].

1. Move the mouse cursor to the [Scan to Salesforce Chatter] icon , and then click .

⇒ The [Scan to Salesforce Chatter - Options] dialog box appears.

2. Change the settings.

For details about the [Scan to Salesforce Chatter - Options] dialog box, refer to the ScanSnap Manager Help.

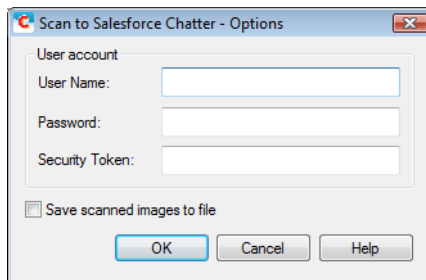

ATTENTION

If the computer is shared with other users, do not set your information in [User Name], [Password] and [Security Token]. Otherwise, other users will be able to log into Salesforce automatically. It is recommended to set only [User Name] and [Security Token] in this dialog box, and type in the password every time.

3. Click the [OK] button to close the [Scan to Salesforce Chatter - Options] dialog box.

Saving Data to Your SugarSync Folder

This section explains how to save the scanned image as a PDF or a JPEG file to your SugarSync folder.

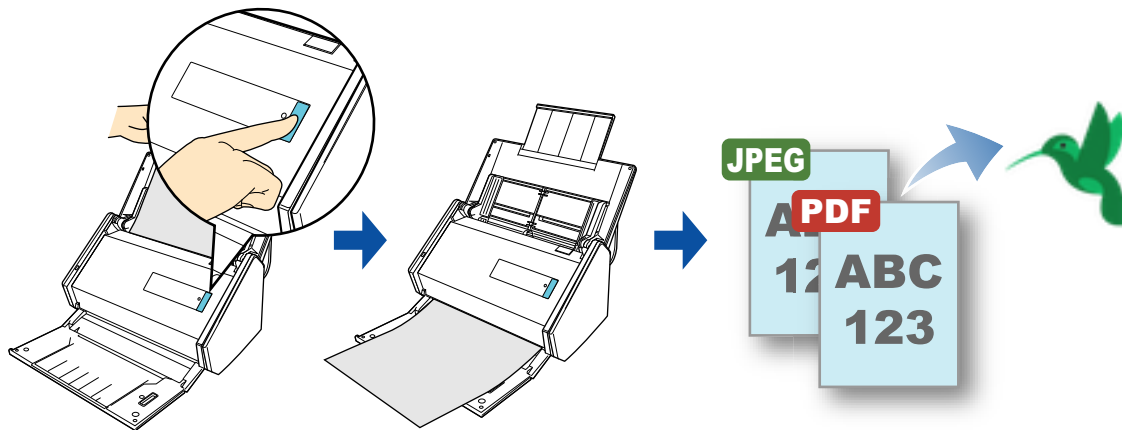

ATTENTION

- You need to have a SugarSync account.
- You need to have SugarSync Manager for Windows 1.9.28 or later installed in order to use this function.
- You can save up to 100 files to your SugarSync folder at once.

HINT

- When you first log into SugarSync after installing SugarSync Manager for Windows, My SugarSync is automatically created.
My SugarSync is a sync folder used in SugarSync.
- By registering the scan and save settings as a profile, you can scan documents with the same profile at any time. For details, refer to ["Profile" \(page 203\)](#).
- ScanSnap Folder can also be used for this operation. For details, refer to ["ScanSnap Folder Operations" \(page 216\)](#).

Procedures

HINT

To use the Quick Menu, you need to select the [Use Quick Menu] check box in the ScanSnap setup dialog box.

For details about how to perform scanning by using the Quick Menu, refer to "[Basic Scanning Operation Flow](#)" (page 114).

1. Load a document in the ScanSnap.

For details, refer to "[How to Load Documents](#)" (page 63).

2. Press the [Scan] button on the ScanSnap to start a scan.

⇒ The Quick Menu appears when the scanning is completed.



To change the settings for [Scan to SugarSync], move the mouse cursor to the [Scan to

SugarSync] icon , and then click . For details about how to change the settings, "[Preferences](#)" (page 187).

3. Click the [Scan to SugarSync] icon .

⇒ The [Scan to SugarSync] dialog box appears.

HINT

You can configure the settings to not show the [Scan to SugarSync] dialog box. If you configure the settings to not show the [Scan to SugarSync] dialog box, scanned images are saved directly to the SugarSync sync folder.

For details about how to change the settings, "[Preferences](#)" (page 187).

4. Check the scanned image in the preview area.

In the [Scan to SugarSync] dialog box, you can rename the file and specify your SugarSync folder.

For details about the [Scan to SugarSync] dialog box, refer to the ScanSnap Manager Help.

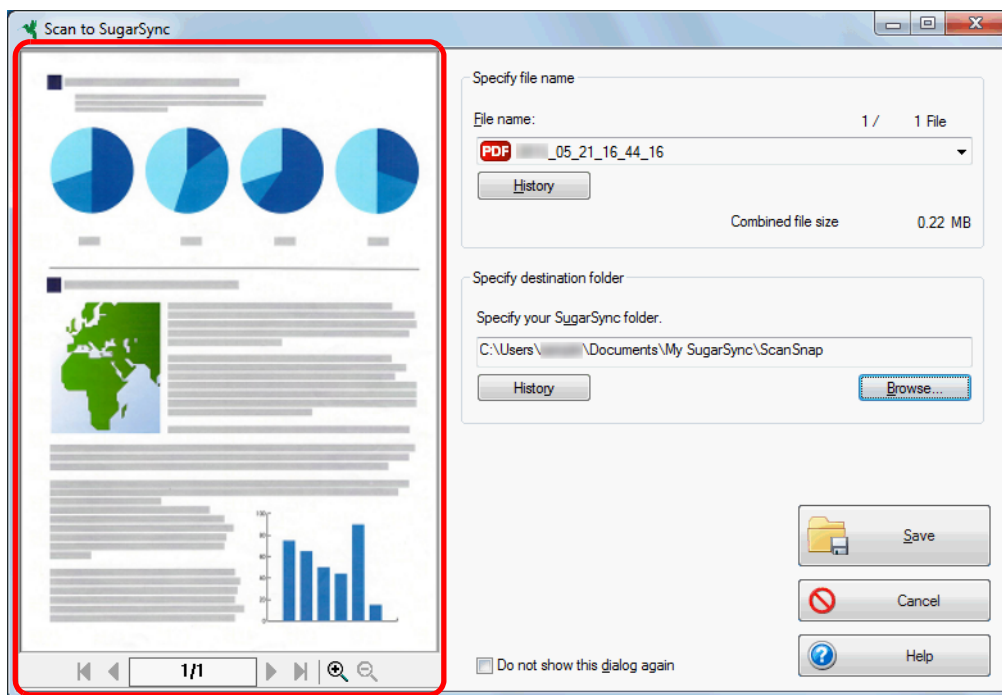

Preview

ATTENTION



- The file will not be synced with SugarSync unless you select a SugarSync folder as the destination folder.
- You cannot start scanning after the Quick Menu is displayed and before the [Scan to SugarSync] dialog box is closed. Close the [Scan to SugarSync] dialog box before scanning the next document.
- Do not move, delete or rename the scanned image in other applications after the Quick Menu is displayed and before the [Scan to SugarSync] dialog box is closed.

5. Click the [Save] button.

⇒ The scanned image is saved to your SugarSync folder.

Preferences

You can configure the settings in order to link with [Scan to SugarSync].

1. Move the mouse cursor to the [Scan to SugarSync] icon , and then click .

⇒ The [Scan to SugarSync - Options] dialog box appears.

2. Change the settings.

For details about the [Scan to SugarSync - Options] dialog box, refer to the ScanSnap Manager Help.

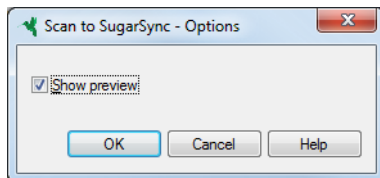

3. Click the [OK] button to close the [Scan to SugarSync - Options] dialog box.

Converting into Word/Excel/PowerPoint Documents

This section explains how to convert the scanned image into Word/Excel/PowerPoint files using ABBYY FineReader for ScanSnap bundled with the ScanSnap.

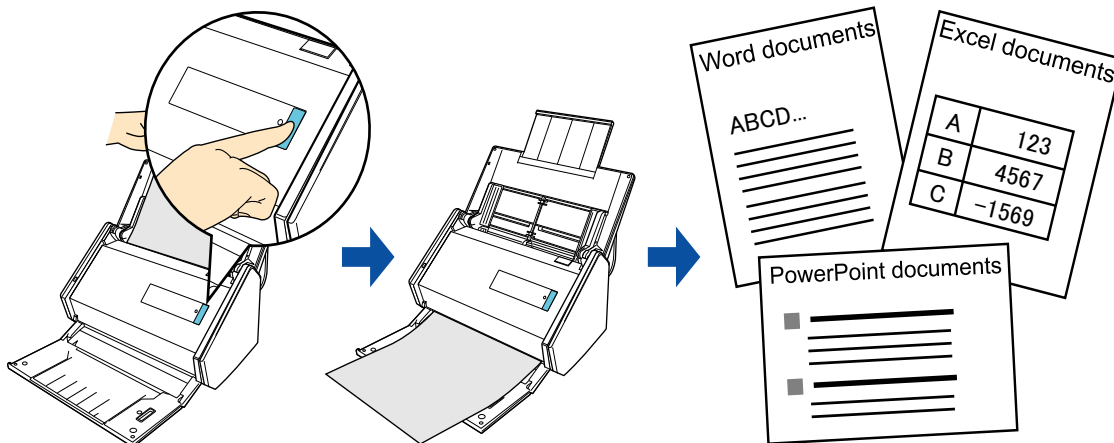

ATTENTION

- The following applications must be installed in your computer in order to perform text-recognition:
 - ABBYY FineReader for ScanSnap (bundled with the ScanSnap)
 - Word
 - Excel
 - PowerPoint
- The converted data is saved in one of the following formats.
 - Scan to Word: DOCX format (.docx)
 - Scan to Excel: XLSX format (.xlsx)
 - Scan to PowerPoint: PPTX format (.pptx)
- You cannot view the documents converted into Word, Excel and PowerPoint files unless these applications are installed and you completed the user registration to use them. Install these applications and complete the user registration to view the converted documents on your computer.
- For details on the applications that are supported by ABBYY FineReader for ScanSnap and their versions, refer to the ABBYY FineReader for ScanSnap User's Guide. After installing a supported application, enable the application.
- Do not use this function while you are working in Word, Excel or PowerPoint. In addition, do not use Word, Excel or PowerPoint while this function is being executed. Otherwise, a message such as "Call is rejected by callee" may appear and the conversion result may not be displayed.
- For details about the OCR function of ABBYY FineReader for ScanSnap, refer to ["OCR function of ABBYY FineReader for ScanSnap" \(page 192\)](#).

HINT

By registering the scan and save settings as a profile, you can scan documents with the same profile at any time. For details, refer to ["Profile" \(page 203\)](#).

Procedures

ATTENTION

When you perform a scan with [JPEG(*.jpg)] selected for [File format] in the [File option] tab of the ScanSnap setup dialog box, scanned data cannot be converted into a Word, Excel or PowerPoint file.

HINT

To use the Quick Menu, you need to select the [Use Quick Menu] check box in the ScanSnap setup dialog box.

For details about how to perform scanning by using the Quick Menu, refer to "[Basic Scanning Operation Flow](#)" (page 114).

1. Load a document in the ScanSnap.

For details, refer to "[How to Load Documents](#)" (page 63).

2. Press the [Scan] button on the ScanSnap to start a scan.

HINT

It is recommended that you select [Automatic resolution] or [Best] for [Image quality] in the [Scanning] tab of the ScanSnap setup dialog box.

⇒ The Quick Menu appears when the scanning is completed.



To change the settings for [ABBYY Scan to Word], [ABBYY Scan to Excel(R)] or [ABBYY Scan to PowerPoint(R)], move the mouse cursor to the corresponding icon

(shown below), and then click .

- The [ABBYY Scan to Word] icon 

- The [ABBYY Scan to Excel(R)] icon 

- The [ABBYY Scan to PowerPoint(R)] icon 

For details about how to change the settings, refer to "Preferences" (page 191).

ATTENTION

- You cannot start scanning when the Quick Menu is displayed. Wait until the conversion is over to scan another document.
- Do not move, delete or rename the scanned image in other applications when the Quick Menu is displayed.

3. Click the [ABBYY Scan to Word] icon  , [ABBYY Scan to Excel(R)] icon  or [ABBYY Scan to PowerPoint(R)] icon .



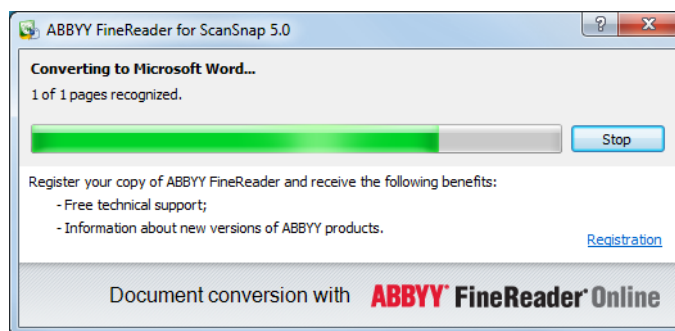

⇒ The following dialog box appears, and conversion starts.



⇒ When the conversion is completed, Word, Excel or PowerPoint starts up, and the conversion result is displayed.

Preferences

You can configure the settings in order to link with [ABBYY Scan to Word], [ABBYY Scan to Excel(R)] or [ABBYY Scan to PowerPoint(R)].

1. Move the mouse cursor to the [ABBYY Scan to Word] icon ,
[ABBYY Scan to Excel(R)] icon  or [ABBYY Scan to
PowerPoint(R)] icon , and then click .

⇒ The [ABBYY FineReader for ScanSnap 5.0 Settings] dialog box appears.

2. Change the settings.

For details about the [ABBYY FineReader for ScanSnap 5.0 Settings] dialog box, refer to the ABBYY FineReader for ScanSnap User's Guide.

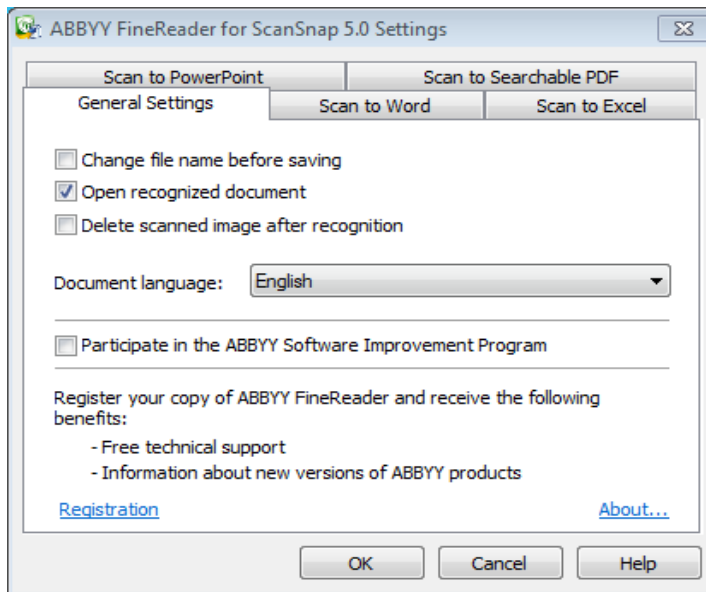

3. Click the [OK] button to close the [ABBYY FineReader for ScanSnap 5.0 Settings] dialog box.

OCR function of ABBYY FineReader for ScanSnap

Overview of ABBYY FineReader for ScanSnap

ABBYY FineReader for ScanSnap is an application used exclusively with the ScanSnap. This program can perform text recognition only for PDF files created by using the ScanSnap. It cannot perform text recognition for files created using Adobe Acrobat or other applications.

Features of OCR Function

The optical character recognition program has the following features. Before performing text recognition, check whether the documents you want to convert are suitable for conversion according to the following guidelines:

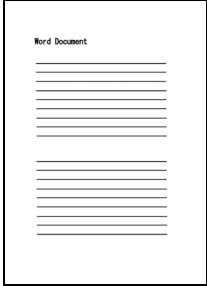
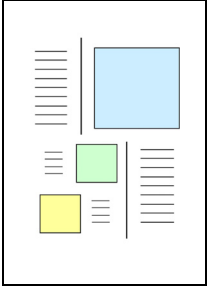
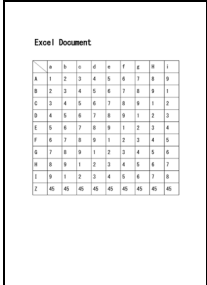
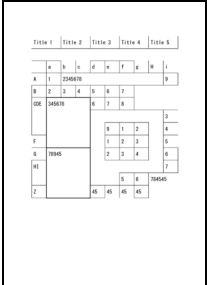
Application	Suitable for conversion	Not suitable for conversion
ABBYY Scan to Word	<p>Documents with simple layouts consisting of single or double columns</p> 	<p>Documents with complex layouts containing a mixture of diagrams, tables and text (e.g. brochures, magazines and newspapers)</p> 
ABBYY Scan to Excel(R)	<p>Documents containing simple tables with no cells merged</p> 	<p>Documents containing:</p> <ul style="list-style-type: none"> ● Tables with no solid border lines ● Tables with complicated cell formats ● Complex tables containing sub-tables ● Diagrams ● Graphs ● Photos ● Vertical text 

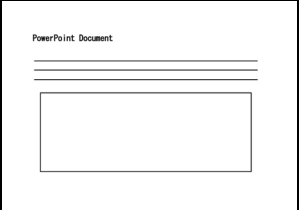
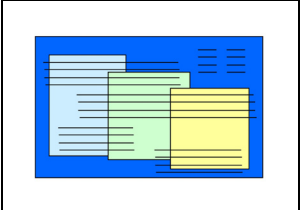
Application	Suitable for conversion	Not suitable for conversion
ABBY Scan to PowerPoint(R)	<p>Documents containing text and simple diagrams/tables on a white or light monocholor background</p> 	<ul style="list-style-type: none"> ● Documents with complex layouts containing text mixed with diagrams or illustrations ● Documents containing photographs or patterns set as the background ● Documents with light colored text on a deep colored background 

Information that cannot be reproduced as in the original document

The following parameters may not be reproduced as they are in the original document. It is recommended that you check the conversion result in Word, Excel or PowerPoint and edit the data if necessary:

- Character font and size
- Character and line spacing
- Underlined, bold and italic characters
- Superscript/subscript

Document where characters cannot be recognized correctly

The following types of documents (characters) may not be recognized correctly. Better results in text recognition may be achieved by changing the color mode or increasing the resolution:

- Documents including handwritten characters
- Documents containing small characters (smaller than 10 points)
- Skewed documents
- Documents written in languages other than the specified language
- Documents with characters on an unevenly colored background
e.g. Shaded characters
- Documents with many decorated characters
e.g. Decorated characters (embossed/outlined)
- Documents with characters on a patterned background
e.g. Characters overlapping illustrations and diagrams
- Documents with many characters contacting underlines or borders
- Documents with a complex layout and documents with image noise
(It may take extra time to process text recognition for these documents.)

Other considerations

- When you convert a large-sized long page document into a Word file, it may be converted into the max size available for Word.
- When converting to Excel files, if the recognition result exceeds 65,536 lines, no more results are saved.
- When converting to Excel files, information about the layout of the entire document, diagrams, and length/width of graphs and tables is not duplicated. Only tables and character strings are reproduced.
- A converted PowerPoint document will not have the original background color and patterns.
- Documents placed upside down or in landscape orientation cannot be recognized properly. Select the [Automatic image rotation] check box ([page 232](#)), or load documents face down in portrait orientation.
- If bleed-through reduction is enabled, the recognition rate may be lowered. In that case, disable it in the following procedure.
Select [Scan Button Settings] → [Scanning] tab → [Option] button from the Right-Click Menu to show the [Scanning mode option] dialog box. Clear the [Reduce bleed-through] check box.

Saving Data in SharePoint

This section explains how to save the scanned image in SharePoint.

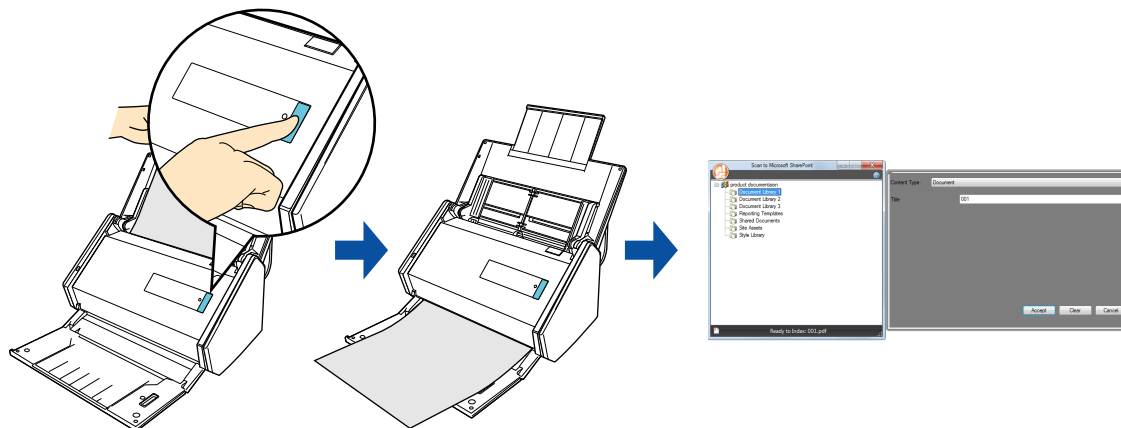

ATTENTION

- To save a large file to SharePoint, you may need to have the system administrator change the SharePoint setting.
- When you start up Scan to Microsoft SharePoint for the first time, you need to register a SharePoint site. Once you register the SharePoint site, ScanSnap Manager automatically connects to that site from the next startup.
For more details, refer to the Scan to Microsoft SharePoint User's Guide.

HINT

By registering the scan and save settings as a profile, you can scan documents with the same profile at any time. For details, refer to ["Profile"](#) (page 203).

Procedures

HINT

To use the Quick Menu, you need to select the [Use Quick Menu] check box in the ScanSnap setup dialog box.

For details about how to perform scanning by using the Quick Menu, refer to "[Basic Scanning Operation Flow](#)" (page 114).

1. Load a document in the ScanSnap.

For details, refer to "[How to Load Documents](#)" (page 63).

2. Press the [Scan] button on the ScanSnap to start a scan.

⇒ The Quick Menu appears when the scanning is completed.



To change the settings for [Scan to SharePoint], move the mouse cursor to the [Scan to

SharePoint] icon , and then click . For details about how to change the settings, "[Preferences](#)" (page 198).

ATTENTION

- You cannot start scanning when the Quick Menu is displayed. Wait until ScanSnap Manager links with Microsoft SharePoint before scanning another document.
- Do not move, delete or rename the scanned image in other applications when the Quick Menu is displayed.

3. Click the [Scan to SharePoint] icon .

⇒ Scan to Microsoft SharePoint starts up.

4. From the Site Tree Pane, select the document library in which you want to save the scanned image.

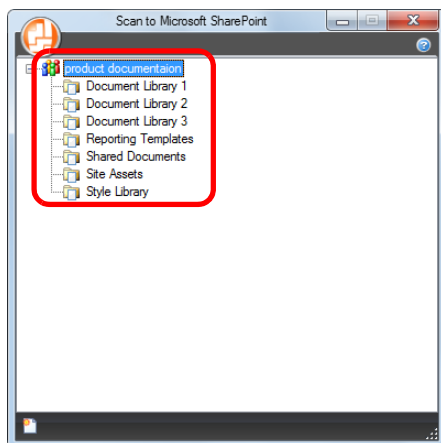

⇒ The Index Pane appears.

5. Enter information, such as the title, and click the [Accept] button.

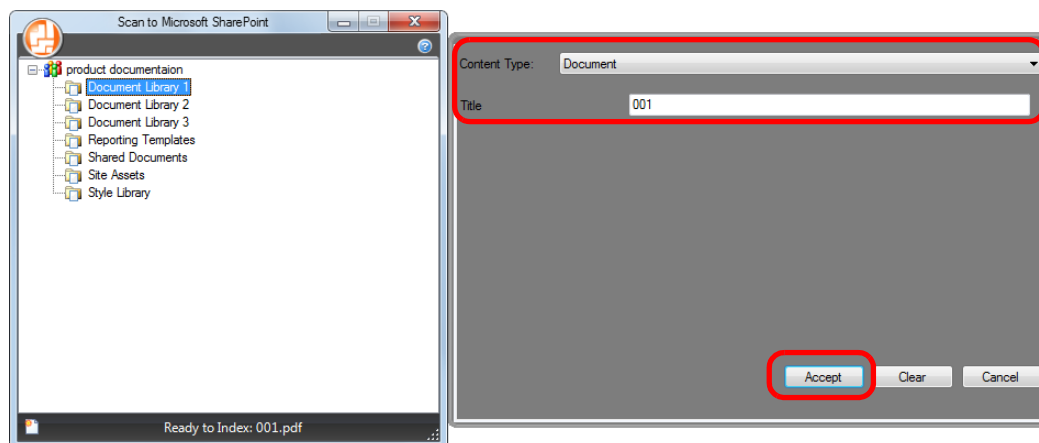



⇒ The scanned image is saved in the specified document library.

HINT

For details, refer to the Scan to Microsoft SharePoint User's Guide.

Preferences

You can configure the settings in order to link with [Scan to SharePoint].

1. Move the mouse cursor to the [Scan to SharePoint] icon , and then click .

⇒ The [Scan to SharePoint - Options] dialog box appears.

2. Change the settings.

For details about the [Scan to SharePoint - Options] dialog box, refer to the ScanSnap Manager Help.

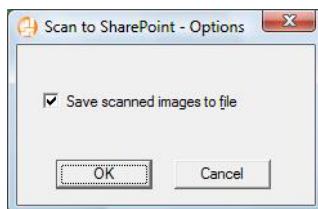

3. Click the [OK] button to close the [Scan to SharePoint - Options] dialog box.

Saving Data to Picture Folder

This section explains how to save the scanned image as a JPEG file to Picture Folder.

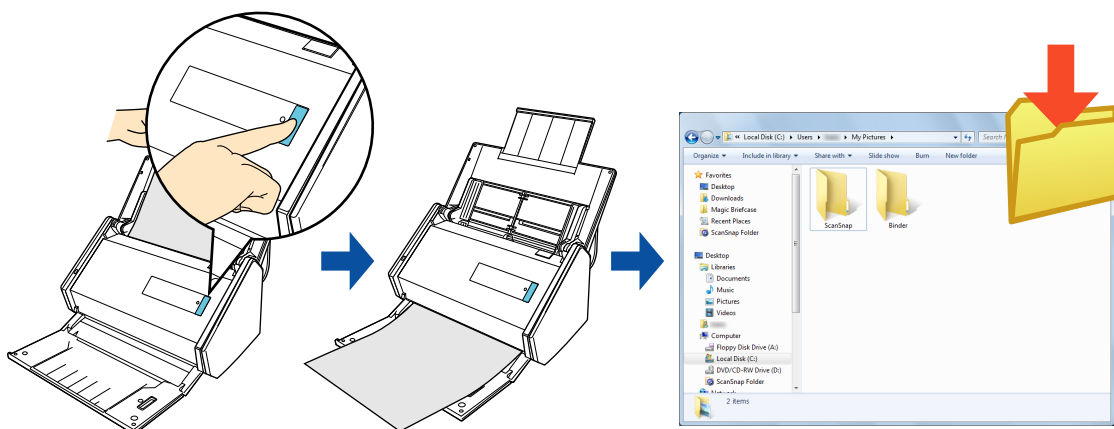

HINT

- The following folder is set as the "Pictures folder" by default:
 - Windows 8/Windows 7/Windows Vista
Drive name (such as C): \Users*user name*\Pictures\ScanSnap
 - Windows XP
Drive name (such as C): \Documents and Settings*user name*\My Documents\
My Pictures\ScanSnap
- By registering the scan and save settings as a profile, you can scan documents with the same profile at any time. For details, refer to ["Profile"](#) (page 203).

Procedures

HINT

To use the Quick Menu, you need to select the [Use Quick Menu] check box in the ScanSnap setup dialog box.

For details about how to perform scanning by using the Quick Menu, refer to "[Basic Scanning Operation Flow](#)" (page 114).

1. Load a document in the ScanSnap.



For details, refer to "[How to Load Documents](#)" (page 63).

2. Press the [Scan] button on the ScanSnap to start a scan.

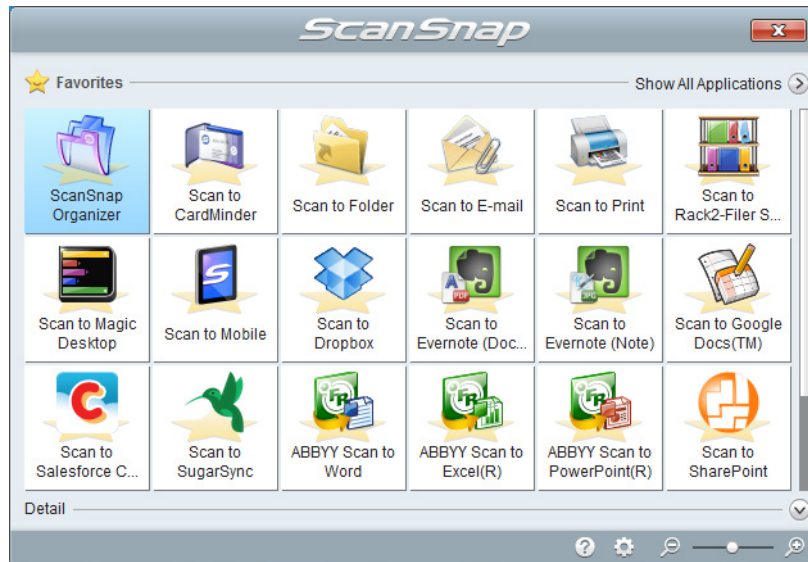
⇒ The Quick Menu appears when the scanning is completed.



To change the settings for [Scan to Picture Folder], move the mouse cursor to the [Scan

to Picture Folder] icon , and then click . For details about how to change the settings, "[Preferences](#)" (page 202).

3. Click the [Scan to Picture Folder] icon .

⇒ The [Scan to Picture Folder] dialog box appears.

HINT

You can configure the settings to not show the [Scan to Picture Folder] dialog box. If you configure the settings to not show the [Scan to Picture Folder] dialog box, scanned images are saved directly to Picture Folder.

For details about how to change the settings, "[Preferences](#)" (page 202).

4. Check the scanned image in the preview area.

In the [Scan to Picture Folder] dialog box, you can rename the file, change the destination folder, and specify whether to save the scanned image in the folder specified for [Image saving folder].

For details about the [Scan to Picture Folder] dialog box, refer to the ScanSnap Manager Help.

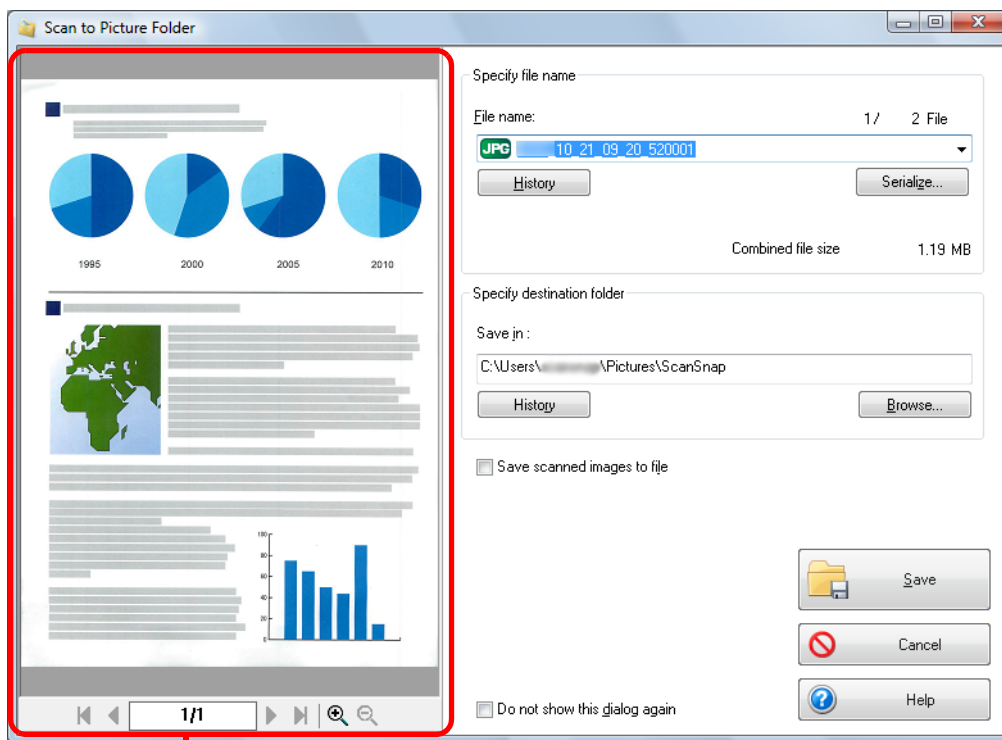

Preview

ATTENTION

- You cannot start scanning after the Quick Menu is displayed and before the [Scan to Picture Folder] dialog box is closed. Close the [Scan to Picture Folder] dialog box before scanning the next document.
- Do not move, delete, or rename scanned image in other applications after the Quick Menu is displayed and before the [Scan to Picture Folder] dialog box is closed.

HINT



In [Specify destination folder], you can change the destination folder for the image data to a folder other than the Pictures folder.

5. Click the [Save] button.

⇒ The scanned image is saved in the Pictures folder.

Preferences

You can configure the settings in order to link with [Scan to Picture Folder].

1. Move the mouse cursor to the [Scan to Picture Folder] icon , and then click .

⇒ The [Scan to Picture Folder - Options] dialog box appears.

2. Change the settings.

For details about the [Scan to Picture Folder - Options] dialog box, refer to the ScanSnap Manager Help.

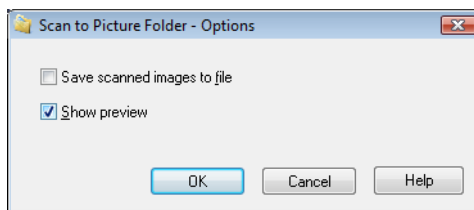

3. Click the [OK] button to close the [Scan to Picture Folder - Options] dialog box.

Profile

Once the frequently used scan settings are saved as profiles, you can select a profile to easily change scan settings depending on your scanning purpose.

You can manage up to 20 profiles.

To select a profile, left-click the ScanSnap Manager icon  to show the Left-Click Menu.

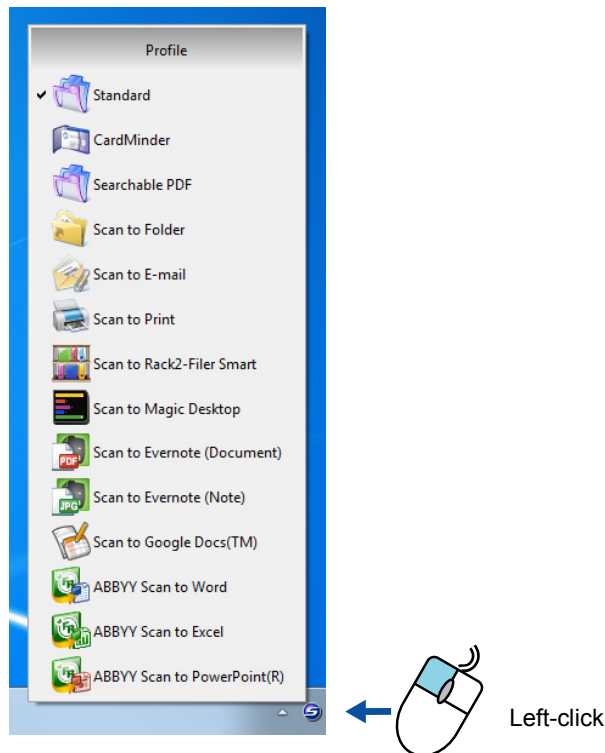

Left-Click Menu example

HINT

- To use a profile, you need to clear the [Use Quick Menu] check box in the ScanSnap setup dialog box.
- You can also select a profile from [Profile] in the ScanSnap setup dialog box.
- Profiles configured for the following scanner models will be carried over to ScanSnap iX500 if the computer is the same:
 - ScanSnap S1500
 - ScanSnap S1500M
 - ScanSnap S1300i
 - ScanSnap S1300
 - ScanSnap S1100
 - ScanSnap S510
 - ScanSnap S300

How to Configure Scan Settings

You can configure scan settings depending on your intended use of the scanned images.

The scan settings can be configured in the ScanSnap setup dialog box.

For details about how to configure scan settings, refer to "[How to Configure Scan Settings](#)" (page 268).

Profile Management

For details about how to add, change or delete profiles, refer to the following:

- To add a profile (→ [page 204](#))
- To change scan settings for profiles (→ [page 208](#))
- To rename a profile (→ [page 210](#))
- To delete a profile (→ [page 212](#))

Adding Profiles

1. Select [Scan Button Settings] from the Right-Click Menu.

For details about the Right-Click Menu, refer to "[Right-Click Menu \(Windows\)](#)" (page 37).

⇒ The ScanSnap setup dialog box appears.

HINT

Clear the [Use Quick Menu] check box if it is selected.

2. Configure the scan settings in each tab.

For details about each tab, refer to the ScanSnap Manager Help.

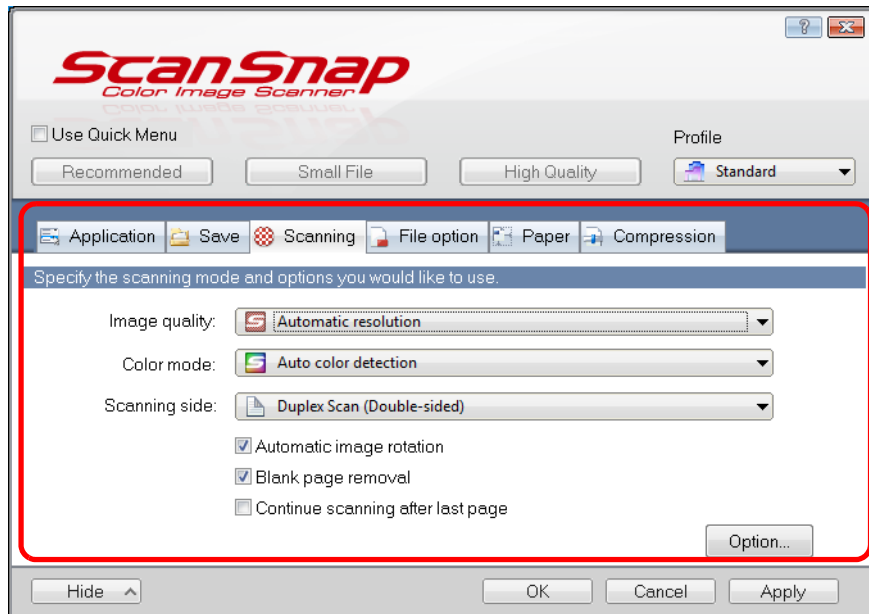

3. Select [Add Profile] from [Profile].

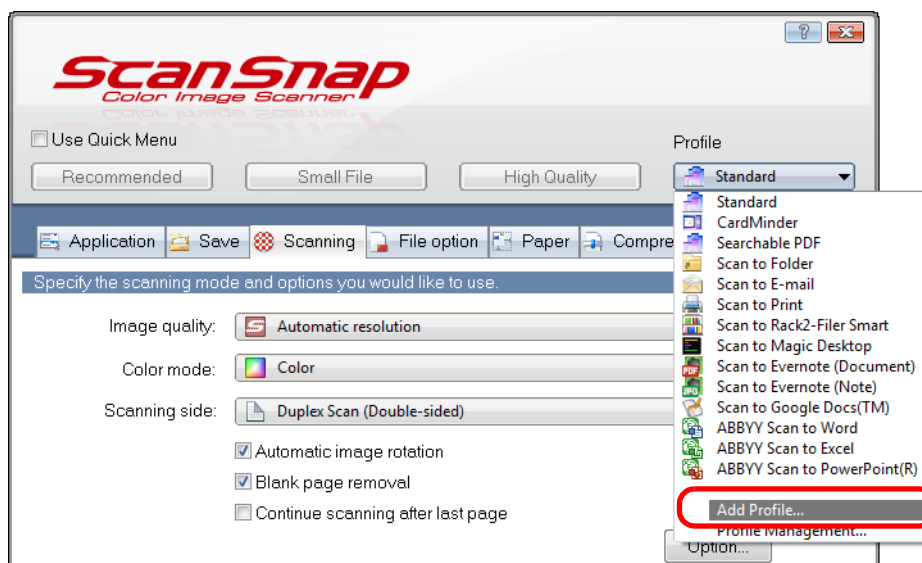

⇒ The [Add new profile] dialog box appears.

4. Type in a new profile name and click the [OK] button.

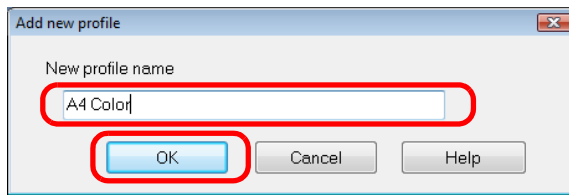

⇒ The added profile appears in [Profile] in the ScanSnap setup dialog box.

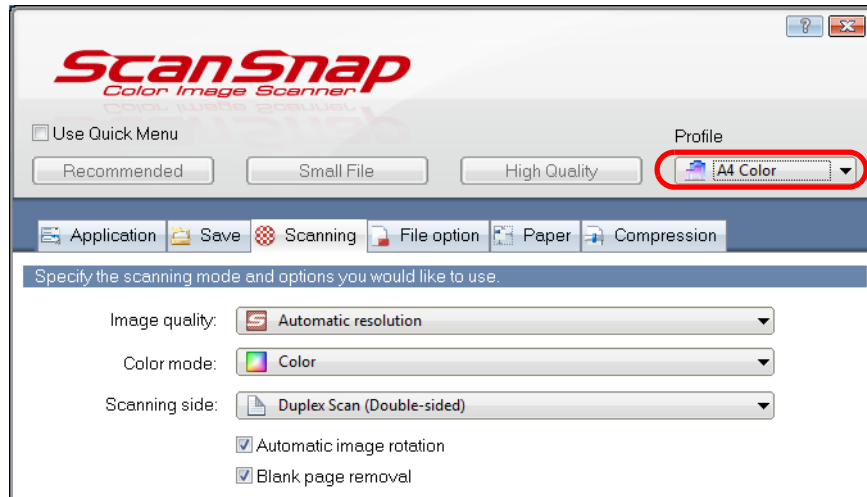

5. Click the [OK] button to close the ScanSnap setup dialog box.

HINT

- Up to 20 profiles can be saved including the [Standard] profile.
 - You can change the display order of profiles.
However, you cannot change the [Standard] display order.
1. Select [Profile Management] from the Right-Click Menu or [Profile] in the ScanSnap setup dialog box.
⇒ The [ScanSnap Manager - Profile Management] dialog box appears.
 2. Select a profile from the list to arrange profiles in a different order.
 3. Click the [Up] or [Down] button to move the profile to its desired position in the list.

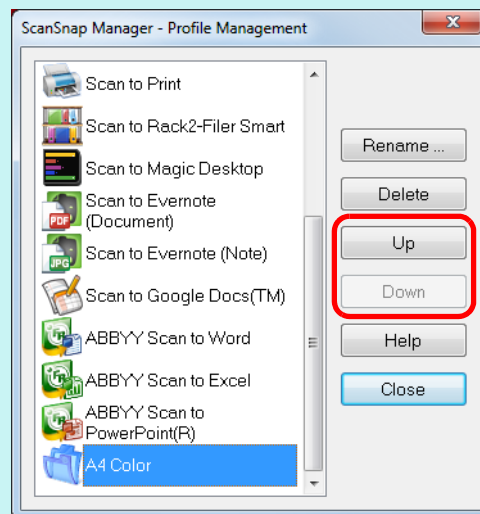

4. Click the [Close] button to close the [ScanSnap Manager - Profile Management] dialog box.

Changing Profile Settings

1. Select [Scan Button Settings] from the Right-Click Menu.

For details about the Right-Click Menu, refer to "[Right-Click Menu \(Windows\)](#)" (page 37).

⇒ The ScanSnap setup dialog box appears.

HINT

Clear the [Use Quick Menu] check box if it is selected.

2. Select a profile to change from [Profile].

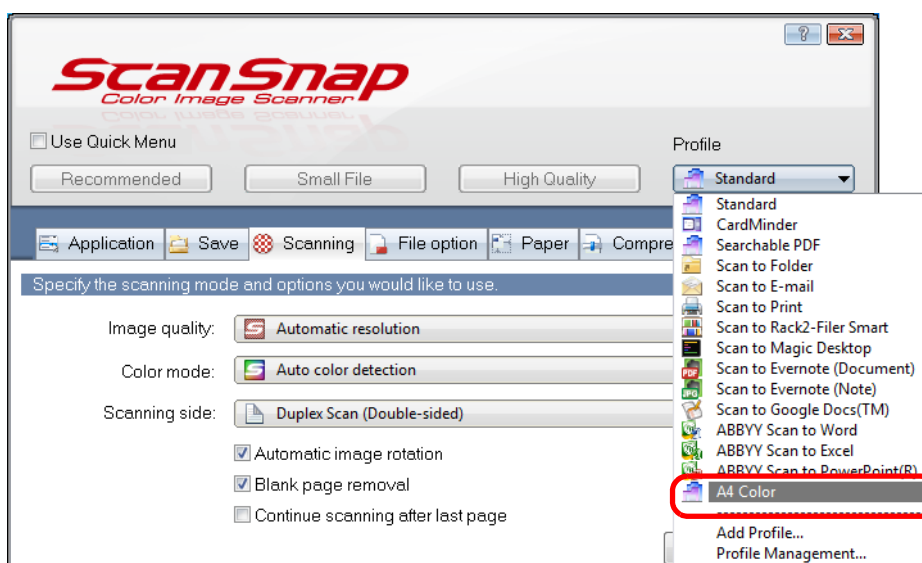

3. Change the scan settings in each tab.

For details about each tab, refer to the ScanSnap Manager Help.

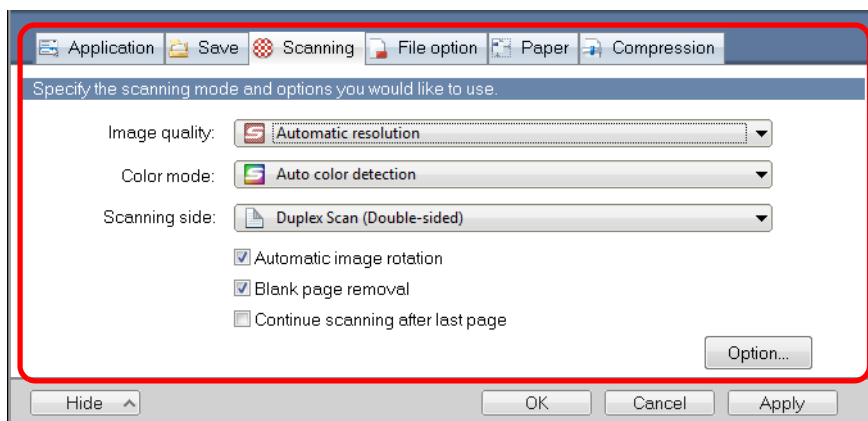

4. When you finish changing the settings for the selected profile, click the [OK] button.

⇒ The overwrite confirmation dialog box appears.

HINT

If you select another profile from [Profile] before clicking the [OK] button, the following message appears.

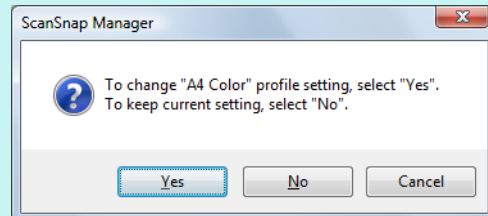

When you click the [Yes] button, the modified settings are overwritten and the profile switches to the one you selected from [Profile].

When you click the [No] button, the modified settings are canceled and the profile switches to the one you selected from [Profile].

5. To overwrite the profile, click the [Yes] button. To save the settings as "Standard", click the [No] button.

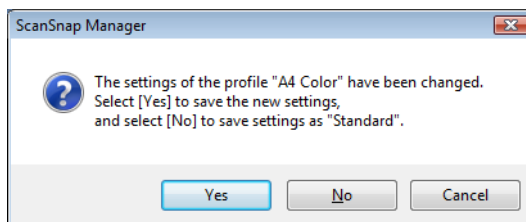

HINT

The confirmation message does not appear when the [Standard] profile is selected in step 2.

Renaming Profiles

1. Select [Profile Management] from the Right-Click Menu.

For details about the Right-Click Menu, refer to ["Right-Click Menu \(Windows\)"](#) (page 37).

⇒ The [ScanSnap Manager - Profile Management] dialog box appears.

HINT

- If you cannot select [Profile Management] in the Right-Click Menu, clear the [Use Quick Menu] check box in the ScanSnap setup dialog box.
- You can also display the [ScanSnap Manager - Profile Management] dialog box by selecting [Profile Management] from [Profile] in the ScanSnap setup dialog box.

2. Select a profile and click the [Rename] button.

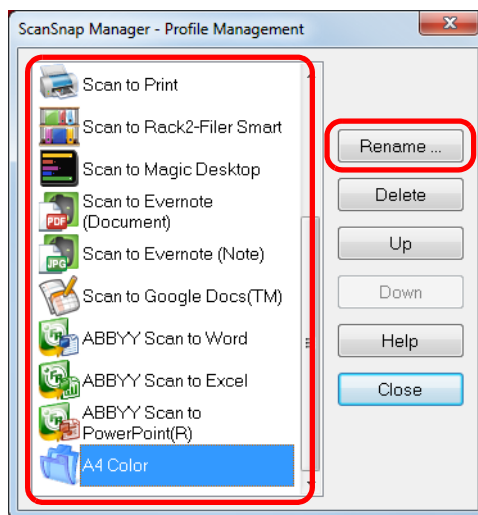

⇒ The [Rename] dialog box appears.

ATTENTION

The [Standard] profile cannot be renamed.

3. Type in a new name, and click the [OK] button.

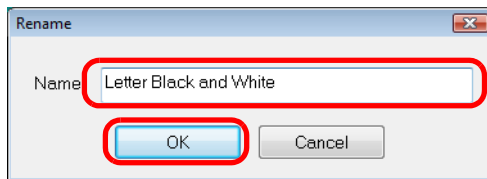

⇒ The profile is renamed.

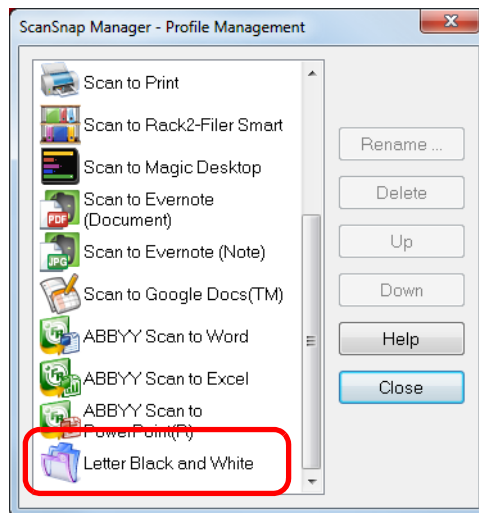

4. Click the [Close] button to close the [ScanSnap Manager - Profile Management] dialog box.

Deleting Profiles

1. Select [Profile Management] from the Right-Click Menu.

For details about the Right-Click Menu, refer to ["Right-Click Menu \(Windows\)"](#) (page 37).

⇒ The [ScanSnap Manager - Profile Management] dialog box appears.

HINT

- If you cannot select [Profile Management] in the Right-Click Menu, clear the [Use Quick Menu] check box in the ScanSnap setup dialog box.
- You can also display the [ScanSnap Manager - Profile Management] dialog box by selecting [Profile Management] from [Profile] in the ScanSnap setup dialog box.

2. Select a profile and click the [Delete] button.

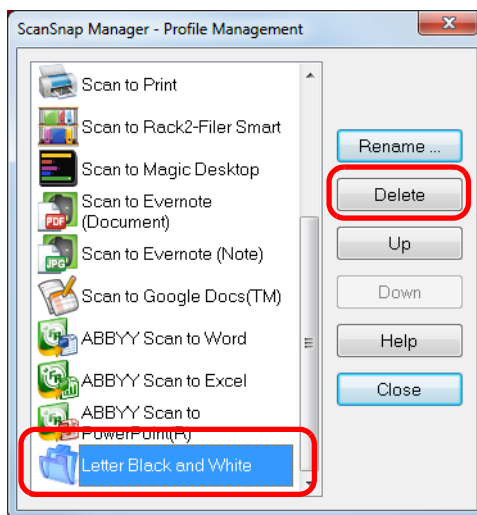

ATTENTION

The [Standard] profile cannot be deleted.

⇒ The [Delete Profile] dialog box appears.

3. Click the [Yes] button.

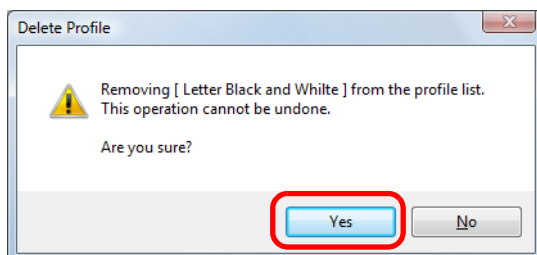

⇒ The selected profile is deleted.

4. Click the [Close] button to close the [ScanSnap Manager - Profile Management] dialog box.

How to Perform a Scan

This section explains how to use profiles to perform scanning.

The following explains an example in which the scanned image file is saved to ScanSnap Organizer.

1. Select [Scan Button Settings] from the Right-Click Menu.

For details about the Right-Click Menu, refer to ["Right-Click Menu \(Windows\)"](#) (page 37).

⇒ The ScanSnap setup dialog box appears.

2. Clear the [Use Quick Menu] check box.

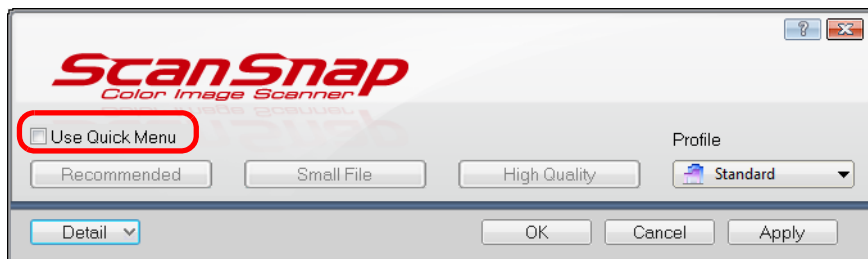

3. Click the [OK] button to close the ScanSnap setup dialog box.

4. Select [Standard] from the Right-Click Menu.

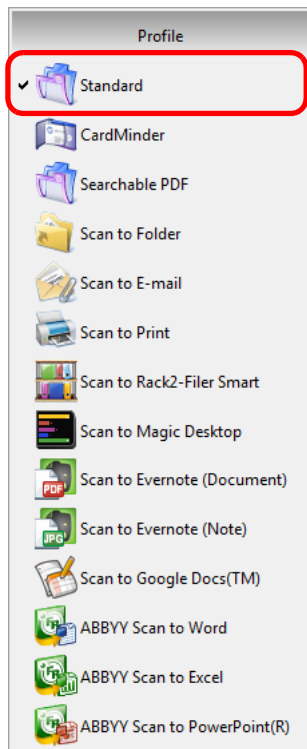

5. Load a document in the ScanSnap.

For details, refer to ["How to Load Documents"](#) (page 63).

6. Press the [Scan] button on the ScanSnap to start a scan.

⇒ The [ScanSnap Organizer] dialog box appears when the scanning is completed.

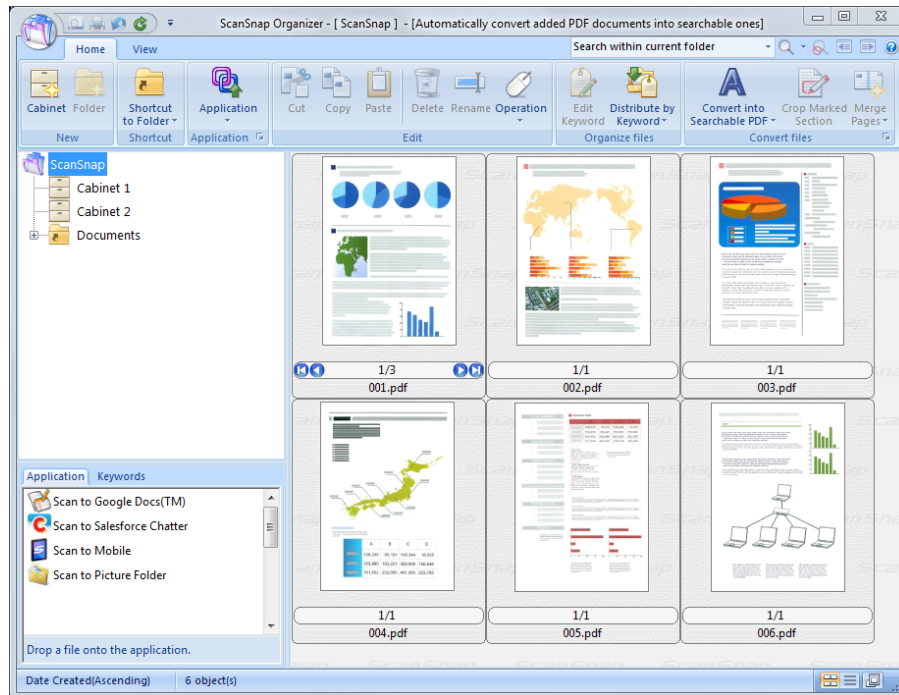

ScanSnap Folder Operations

"ScanSnap Folder" is a temporary folder where you can save images scanned with the ScanSnap to upload the file to a Web application or attach the file to an e-mail. ScanSnap Folder supports a wide range of applications including Web applications. Files saved in this folder can be used by specifying ScanSnap Folder directly from the application when you scan.



ATTENTION

You can use ScanSnap Folder with applications or cloud services that support the following:

- PDF files or JPEG files
- Those without a file format specified

HINT

The files in ScanSnap Folder will be deleted automatically after a set number of days because it is a temporary folder. The number of days to keep the files can be changed. For details, refer to the ScanSnap Manager Help.

How to Configure Scan Settings

You can configure scan settings depending on your intended use of the scanned images. Scan settings can be configured in the ScanSnap setup dialog box.

For details about how to configure scan settings, refer to "[How to Configure Scan Settings](#)" (page 268).

How to Perform a Scan

This section explains how to use ScanSnap Folder to perform scanning.

The following explains an example in which the scanned image file is attached to an e-mail in Windows Live Mail.

ATTENTION

ScanSnap Folder cannot be used if it is disabled. To enable ScanSnap Folder, refer to the ScanSnap Manager Help.

1. Click the [Attach file] button.

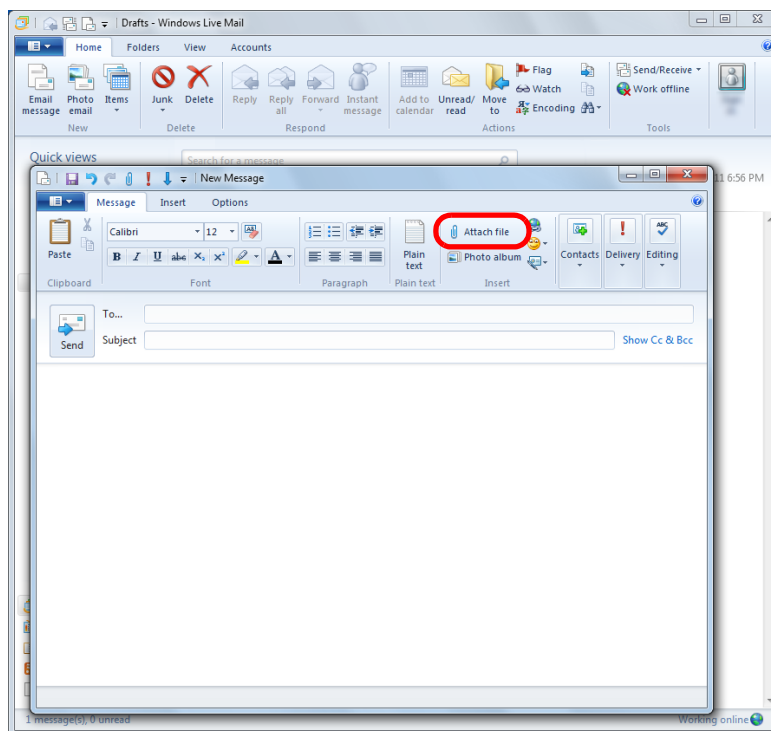

⇒ The [Open] dialog box appears.

2. Click [Computer] ([My Computer] for Windows XP).

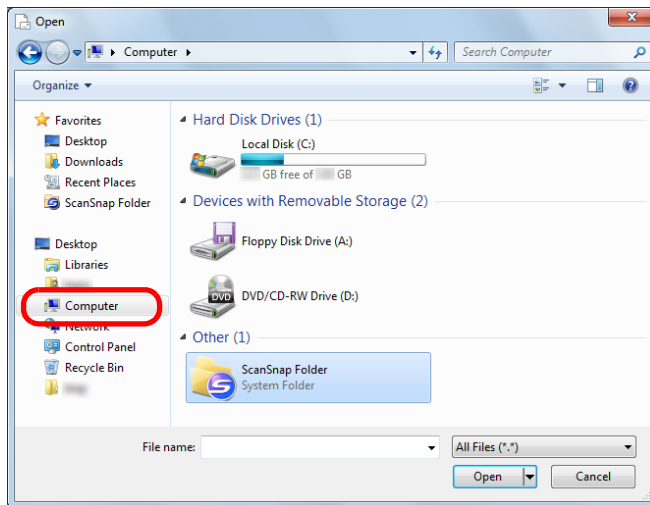

HINT

For Windows 8, Windows 7, or Windows Vista, when you select the ScanSnap Folder registered in [Favorites] ([Favorite Links] for Windows Vista), scanning becomes available in some applications.

3. Select ScanSnap Folder.

⇒ A pop-up balloon appears from the ScanSnap Manager icon in the notification area, and scanning becomes available.

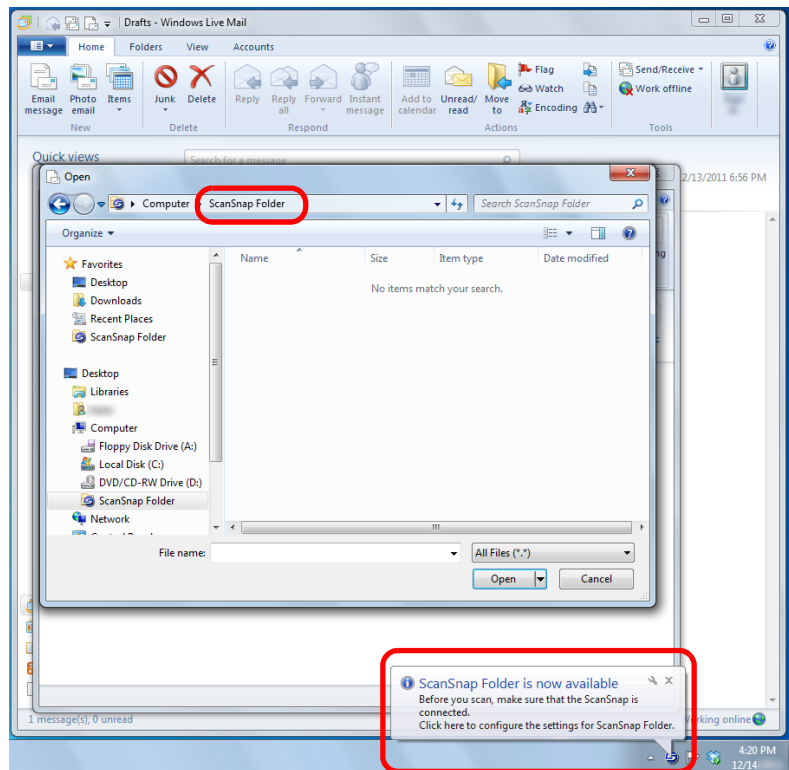

ATTENTION

Selecting "ScanSnap Folder" from some applications may terminate those applications. If your application ends, take an alternate measure. Use your application separately after starting an application in the Quick Menu to process and save the scanned image.

4. Load a document in the ScanSnap.

For details, refer to ["How to Load Documents"](#) (page 63).

5. Press the [Scan] button on the ScanSnap to start a scan.

⇒ The [ScanSnap Folder] dialog box appears when the scanning is completed.

6. Check the scanned image in the preview area.

In the [ScanSnap Folder] dialog box, you can rename the file and convert the file format. For details about the [ScanSnap Folder] dialog box, refer to the ScanSnap Manager Help.

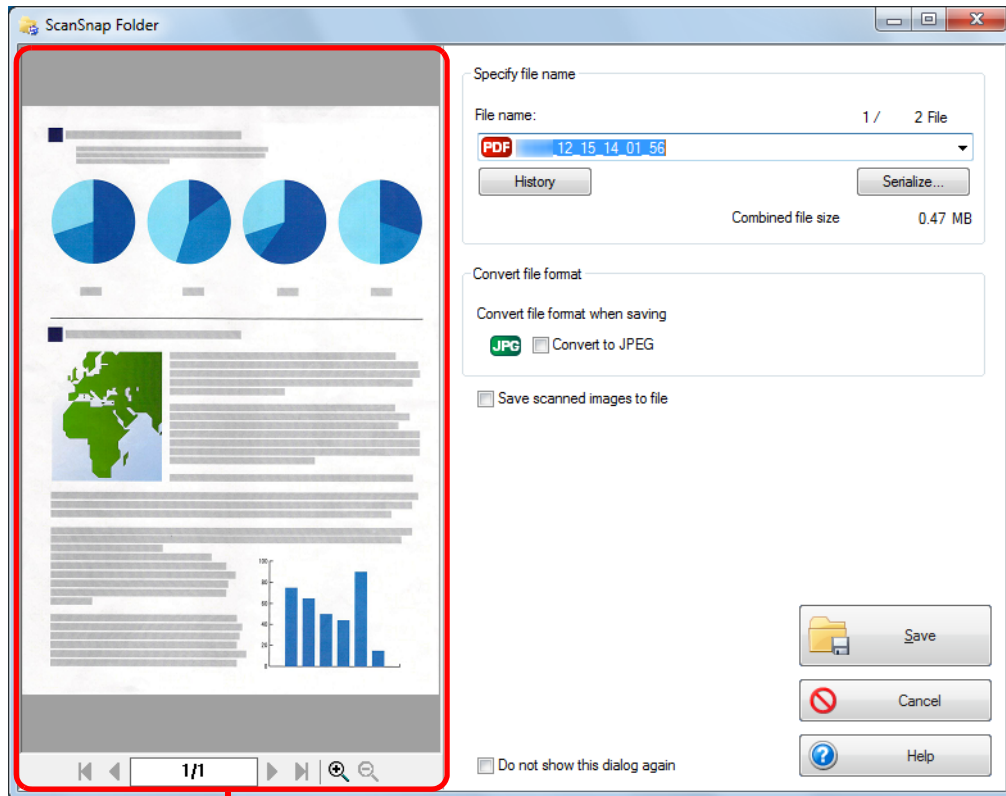

Preview

7. Click the [Save] button.

⇒ The file is saved to ScanSnap Folder.

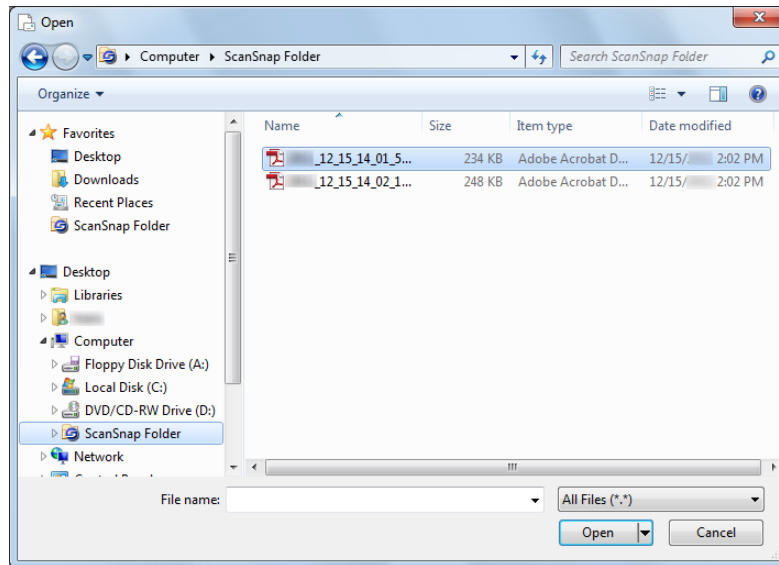

8. Select the file to be attached, and click the [Open] button.

⇒ The file is attached.

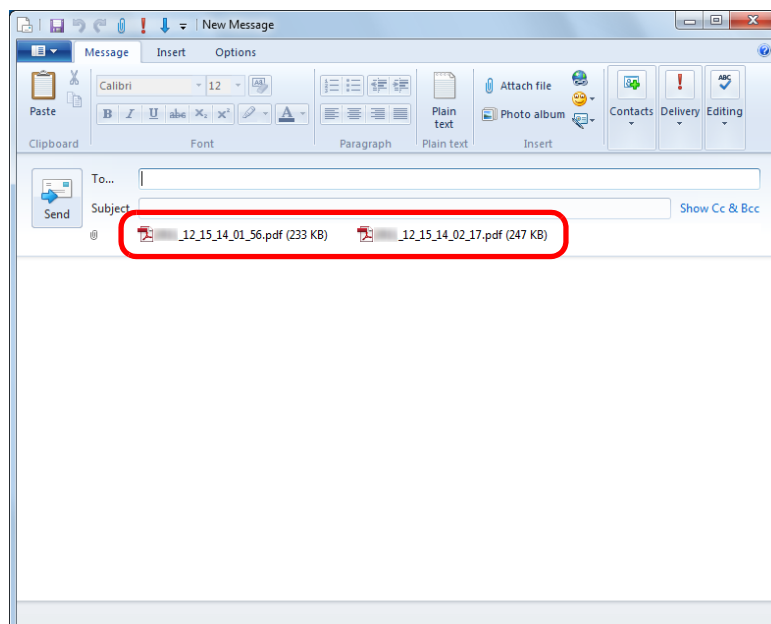

Creating Scanned Images Depending on Intended Use

This section explains about various ways of using the ScanSnap.

Scanning Only One Side of a Document

By default, the ScanSnap scans in duplex mode.

To perform simplex scanning, perform the following steps to change the setting.

1. Select [Scan Button Settings] from the Right-Click Menu.

For details about the Right-Click Menu, refer to ["Right-Click Menu \(Windows\)"](#) (page 37).

⇒ The ScanSnap setup dialog box appears.

2. In the [Scanning side] drop-down list in the [Scanning] tab, select [Simplex Scan (Single-sided)].

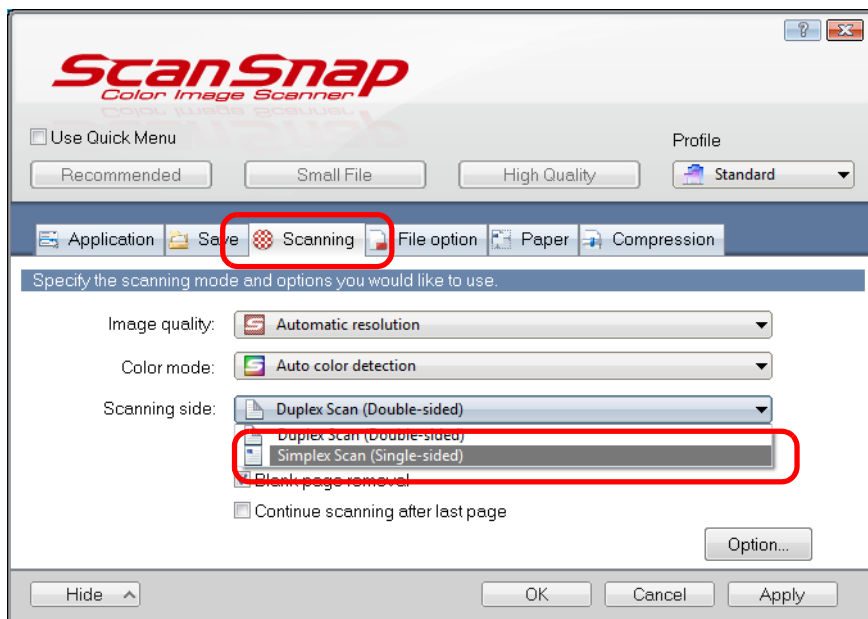

3. Click the [OK] button to close the ScanSnap setup dialog box.

4. Load a document in the ScanSnap.

For details, refer to ["How to Load Documents"](#) (page 63).

5. Press the [Scan] button on the ScanSnap to start a scan.

HINT

When you select [Simplex scan] from the Right-Click Menu, scanning is performed in simplex mode even if [Duplex Scan (Double-sided)] is specified for [Scanning side] in the [Scanning] tab.

⇒ Image data of the scanned side of the document is saved.

Scanning Color Documents in Gray or Black & White

When [Auto color detection] is specified for [Color mode] in the [Scanning] tab of the ScanSnap setup dialog box, the ScanSnap automatically recognizes whether the scanned document is color, gray or black & white, and saves documents in their respective color modes.

If you want to scan color documents and save them in gray or black & white, change the settings in the following procedure.

1. Select [Scan Button Settings] from the Right-Click Menu.

For details about the Right-Click Menu, refer to ["Right-Click Menu \(Windows\)"](#) (page 37).

⇒ The ScanSnap setup dialog box appears.

2. In [Color mode] drop-down list in the [Scanning] tab, select [Gray] or [B&W].

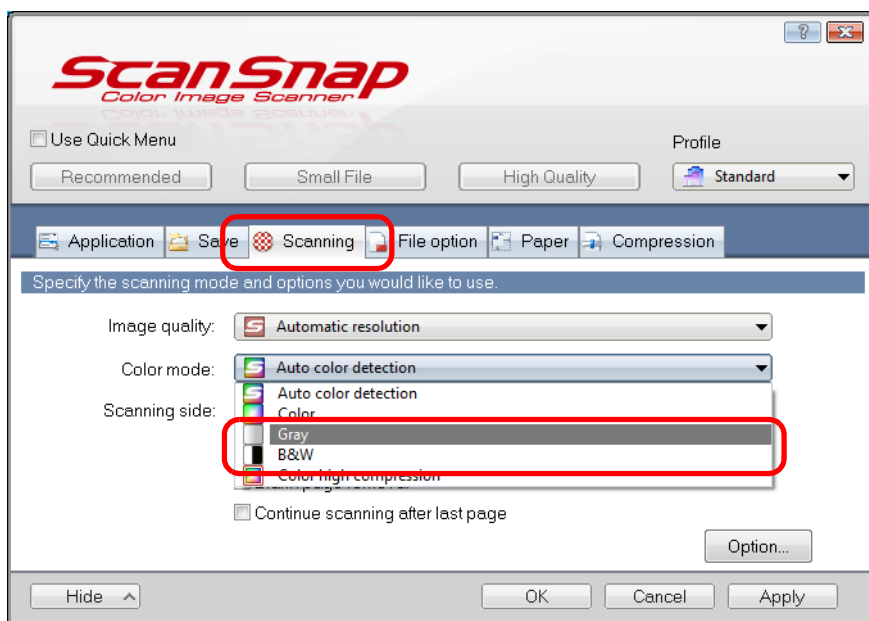

3. Click the [OK] button to close the ScanSnap setup dialog box.

4. Load a document in the ScanSnap.

For details, refer to "[How to Load Documents](#)" (page 63).

5. Press the [Scan] button on the ScanSnap to start a scan.

⇒ Scanned image is saved in gray or black & white.

Scanning Color Documents in High Compression

The ScanSnap can save image data of color documents in high compression mode. You can scan large quantities of color documents in high compression mode and save them as a compact PDF file.

To scan color documents in high compression mode, perform the following steps to change the setting.

ATTENTION

In [Color high compression] mode, different compression rates are applied to characters and backgrounds. Therefore, the file size of a document with mostly text characters is reduced, while the quality of the characters is kept high. However, high compression is applied to photographs and figures since they are regarded as backgrounds, resulting in deteriorated image data. For this reason, this mode is not appropriate for scanning color documents (e.g. photographs).

1. Select [Scan Button Settings] from the Right-Click Menu.

For details about the Right-Click Menu, refer to "[Right-Click Menu \(Windows\)](#)" (page 37).

⇒ The ScanSnap setup dialog box appears.

2. In the [Color mode] drop-down list in the [Scanning] tab, select [Color high compression].

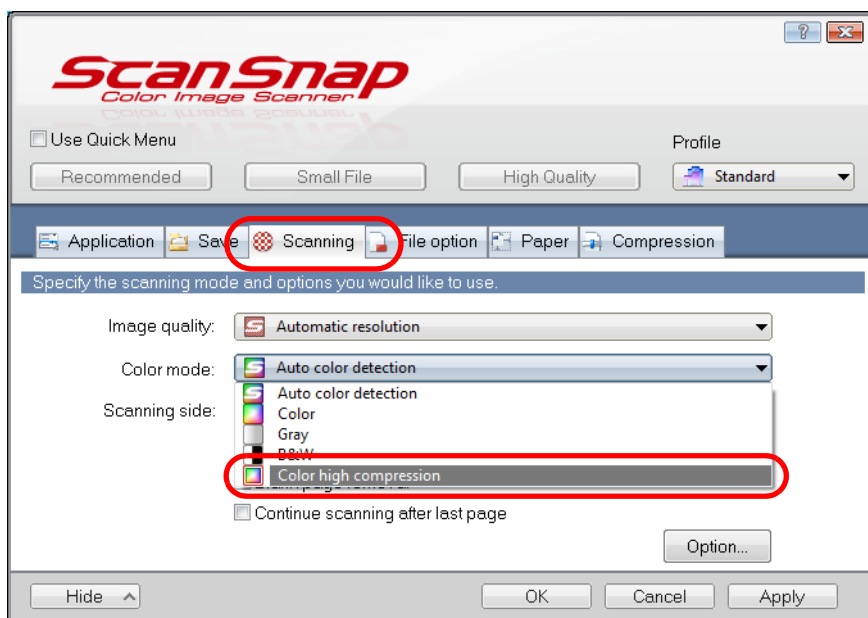

3. Click the [OK] button to close the ScanSnap setup dialog box.

4. Load a document in the ScanSnap.

For details, refer to "[How to Load Documents](#)" (page 63).

5. Press the [Scan] button on the ScanSnap to start a scan.

⇒ The scanned document is saved as highly compressed color image data.

Deleting Blank Pages

The ScanSnap can detect and automatically delete blank pages from a scanned image. For example, when you scan a mixed batch of double-sided and single-sided documents in duplex mode, the images are generated without the back sides of the single-sided documents (blank pages).

To delete blank pages, perform the following steps to change the setting.

ATTENTION

- The following documents may be detected as blank.
 - Almost blank documents with only a few characters
 - Documents of only one color (including black) and without any patterns, lines or characters
 When you scan such documents, clear the [Blank page removal] check box. Also make sure to check the image data for accidentally deleted pages when discarding the scanned document.
- Blank pages are not deleted when CardMinder is used.

1. Select [Scan Button Settings] from the Right-Click Menu.

For details about the Right-Click Menu, refer to ["Right-Click Menu \(Windows\)" \(page 37\)](#).

⇒ The ScanSnap setup dialog box appears.

2. Select the [Blank page removal] check box in the [Scanning] tab.

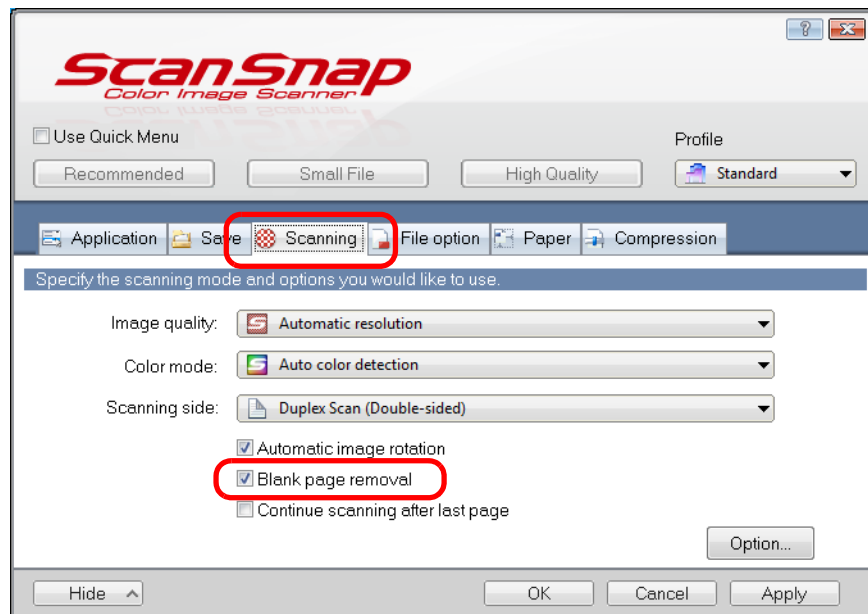

3. Click the [OK] button to close the ScanSnap setup dialog box.

4. Load a document in the ScanSnap.

For details, refer to "[How to Load Documents](#)" (page 63).

5. Press the [Scan] button on the ScanSnap to start a scan.

⇒ Scanned image is saved without any blank pages.

Correcting Skewed Character Strings

When documents with skewed character strings are scanned, the ScanSnap is able to detect the skewed character strings and correct them.

To correct skewed character strings, change the settings in the following procedure.

ATTENTION

- Up to ± 5 degrees of skew can be corrected.
- Since this option is performed assuming that the document contains a certain amount of text, character strings may be adjusted at a wrong angle when scanning the following types of documents. In that case, clear the [Deskew by text on document] check box:
 - Documents on which pitches between lines or characters are extremely narrow, or characters are overlapped
 - Documents with many outlined or decorated characters
 - Documents with many photographs or figures and few characters
 - Documents with characters on a patterned background
e.g. Characters overlapping illustrations and diagrams
 - Documents with characters printed in various directions such as drawings
 - Documents with long diagonal lines
 - Documents including handwritten characters
- Skewed character strings are not corrected if scanning with the Carrier Sheet.

HINT

You do not have to enable [Deskew by text on document] when [Automatic detection] is specified for [Paper size] in the [Paper] tab of the ScanSnap setup dialog box because the skewed image is always corrected when documents are scanned by this setting.

1. Select [Scan Button Settings] from the Right-Click Menu.

For details about the Right-Click Menu, refer to "[Right-Click Menu \(Windows\)](#)" (page 37).

⇒ The ScanSnap setup dialog box appears.

2. Click the [Option] button in the [Scanning] tab.

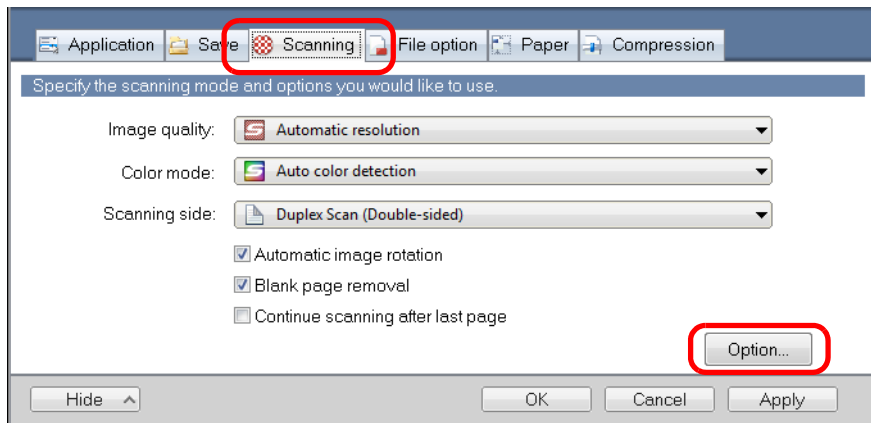

⇒ The [Scanning mode option] dialog box appears.

3. Select the [Deskew by text on document] check box.

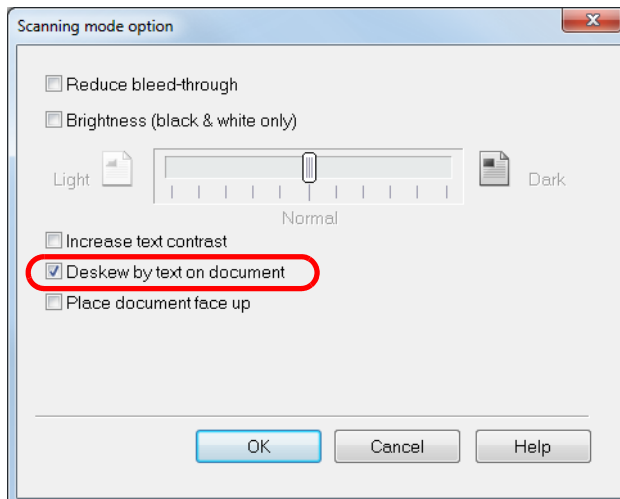

4. Click the [OK] button to close all open dialog boxes.

5. Load a document in the ScanSnap.

For details, refer to ["How to Load Documents"](#) (page 63).

6. Press the [Scan] button on the ScanSnap to start a scan.

⇒ Scanned image is saved with skewed character strings corrected.

Rotating the Scanned Image to its Correct Orientation

In an office environment, it is often the case that a single batch contains same size documents of different page orientations.

The ScanSnap is able to automatically rotate each scanned image to its correct orientation for such document batches.

To rotate scanned images to their correct orientations, change the settings in the following procedure.

ATTENTION

Since this option determines the document's page orientation based on the character strings printed on the document, the following types of documents may not be rotated.

In that case, clear the [Automatic image rotation] check box:

- Documents with many extremely large or small characters
- Documents on which pitches between lines or characters are extremely narrow, or characters are overlapped
- Documents with many characters contacting underlines or borders
- Documents with many photographs or figures and few characters
- Documents with characters on an unevenly colored background
e.g. Shaded characters
- Documents with many decorated characters
e.g. Decorated characters (embossed/outlined)
- Documents with characters on a patterned background
e.g. Characters overlapping illustrations and diagrams
- Documents with characters printed in various directions such as drawings
- Documents written using only capital letters
- Documents including handwritten characters
- Skewed documents
- Documents written in an unsupported language (language other than Japanese/English/ French/ German/Italian/Spanish/Chinese (simplified)/Chinese (traditional)/Korean/Russian/ Portuguese)
- Documents with complex layouts
- Documents with a large amount of image noise
- Documents with faint characters
- Documents with faded characters

1. Select [Scan Button Settings] from the Right-Click Menu.

For details about the Right-Click Menu, refer to "[Right-Click Menu \(Windows\)](#)" (page 37).

⇒ The ScanSnap setup dialog box appears.

2. Select the [Automatic image rotation] check box in the [Scanning] tab.

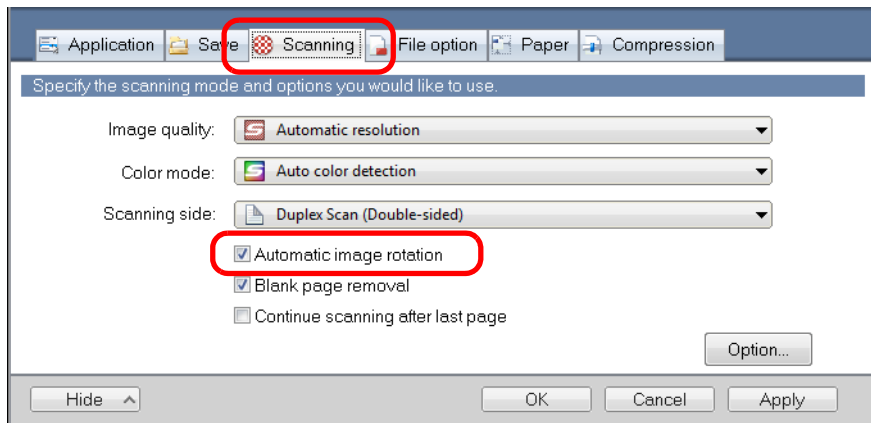

3. Click the [OK] button to close the ScanSnap setup dialog box.

4. Load a document in the ScanSnap.

For details, refer to ["How to Load Documents" \(page 63\)](#).

5. Press the [Scan] button on the ScanSnap to start a scan.

⇒ The scanned image is saved in correct orientation.

Reducing Bleed-Through

You can reduce the bleed-through that appears in the scanned image when there is text or illustration on the back side of the document.

To reduce bleed-through, perform the following steps to change the setting.

ATTENTION

For documents like the following, bleed-through reduction may not function effectively. In that case, clear the [Reduce bleed-through] check box.

- Documents with light colored letters or pictures / documents with thin letters or lines / documents with a dark background color
The color may not be reproduced or the color may be changed. If you want to recognize the marked character strings, the recognition rate for the characters may be lowered.
- Documents where the color for letters is light or the letters are thin
The recognition rate for the characters may be lowered.
- Documents with a lot of bleed-through
The bleed-through may be emphasized.

1. Select [Scan Button Settings] from the Right-Click Menu.

For details about the Right-Click Menu, refer to "[Right-Click Menu \(Windows\)](#)" (page 37).

⇒ The ScanSnap setup dialog box appears.

2. Click the [Option] button in the [Scanning] tab.

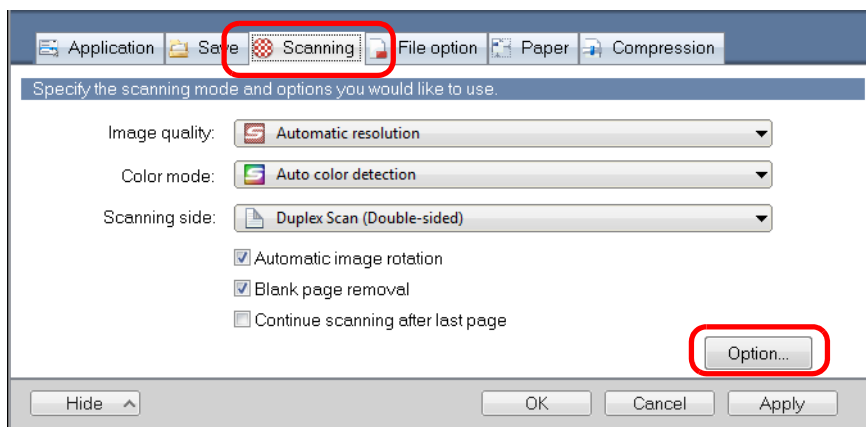

⇒ The [Scanning mode option] dialog box appears.

3. Select the [Reduce bleed-through] check box.

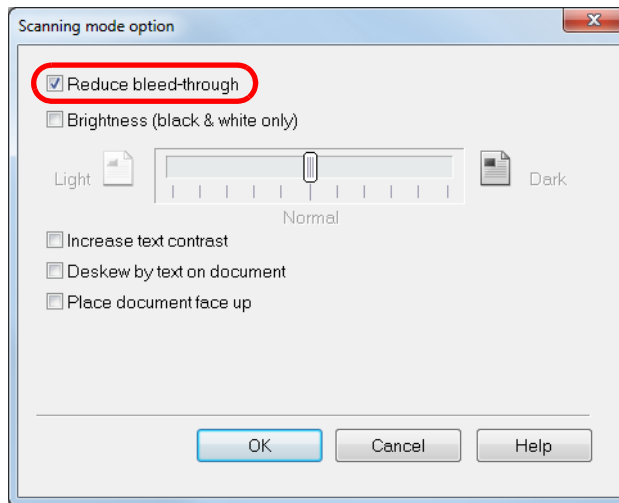

⇒ The following message appears.

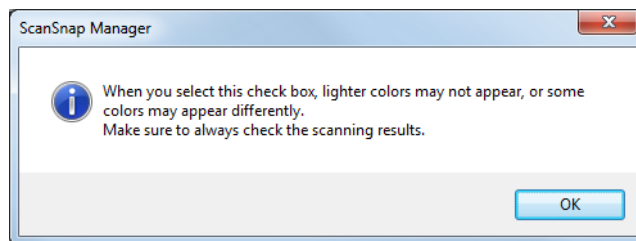

4. Click the [OK] button to close all open dialog boxes.

5. Load a document in the ScanSnap.

For details, refer to "[How to Load Documents](#)" (page 63).

6. Press the [Scan] button on the ScanSnap to start a scan.

⇒ The scanned image is saved with reduced bleed-through.

Scanning Documents of Different Widths or Lengths in One Batch

You can scan documents of different widths or lengths in one batch.

To scan documents of different widths or lengths in one batch, change the settings in the following procedure.

1. Select [Scan Button Settings] from the Right-Click Menu.

For details about the Right-Click Menu, refer to "[Right-Click Menu \(Windows\)](#)" (page 37).

⇒ The ScanSnap setup dialog box appears.

2. In the [Paper] tab, select [Automatic detection] in [Paper size].

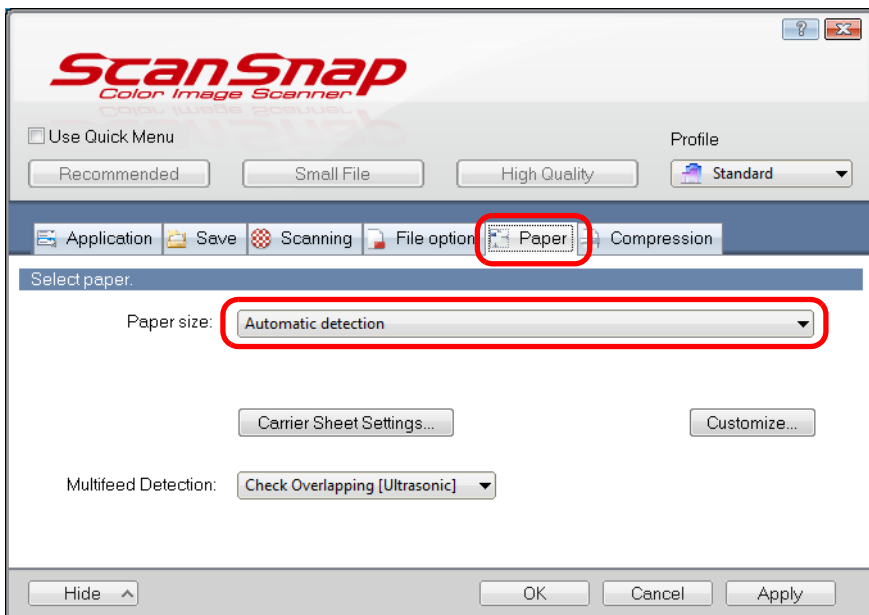

3. Select [None] in [Multifeed Detection] drop-down list.

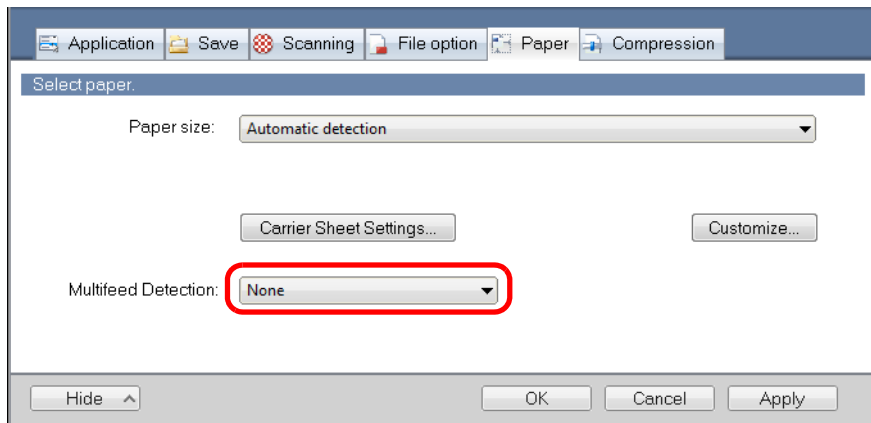

ATTENTION

If you scan documents of different widths or lengths in one batch with [Check Length] selected, documents will be detected as multifeeds and scanning cannot be performed. Note that scanning Letter and A4 size documents in the same batch does not result in multifeed detection.

4. Click the [OK] button to close the ScanSnap setup dialog box.

5. Load documents in the ScanSnap.

1. Align the edges of the documents.

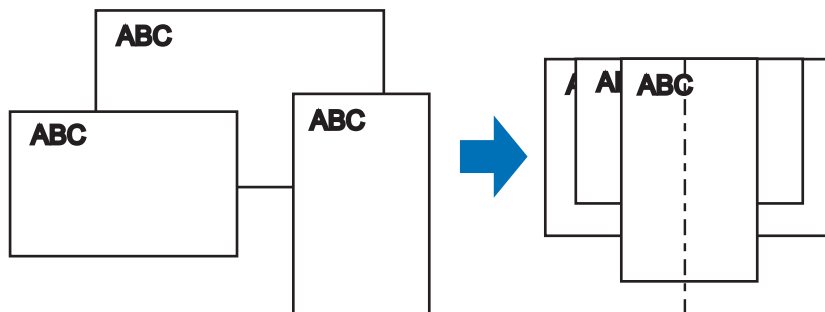

2. Place the documents at the center of the ADF paper chute.

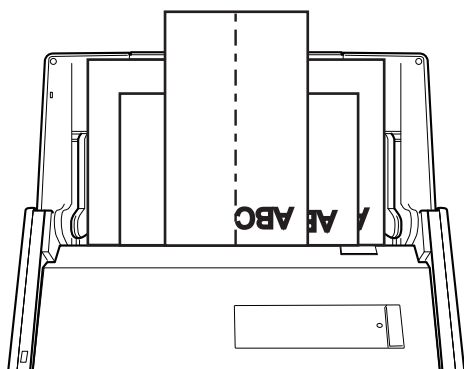

ATTENTION

- Make sure that all documents are placed above the pick roller. Otherwise, some documents will not be picked.

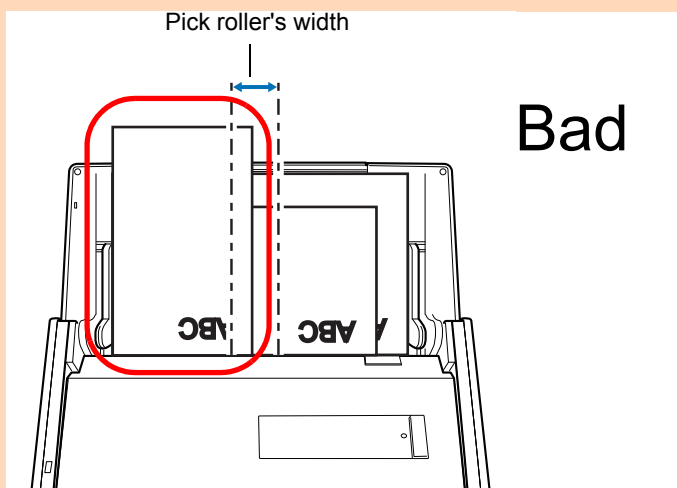

- Adjust the side guides to the widest document in the batch.
- Carefully load small documents that cannot reach the side guides straight into the ADF paper chute (cover). If the documents are skewed during scanning, the quality of scanned image data may be degraded (partly lost image data/slant lines produced) or scanned image data may be output in a different size than the original. If you have difficulties in scanning the documents straight, it is recommended to scan documents in several batches, documents of the same width being in the same batch, and enable continuous scanning.
- Note that documents that cannot be guided by the side guides may cause paper jams.

6. Press the [Scan] button on the ScanSnap to start a scan.

⇒ Scanned images are saved in the original document sizes.

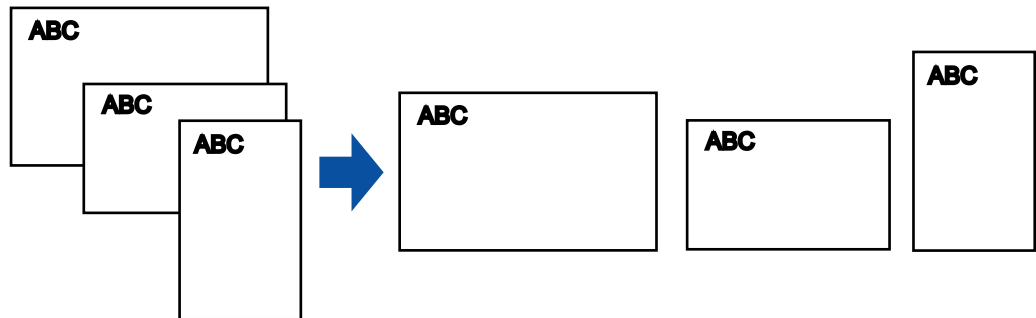

ATTENTION

If the documents are scanned skewed, the images may not be output in their original sizes.

Scanning Documents Larger Than A4/Letter Size

You can scan documents larger than A4/Letter size such as A3, 11 × 17 in. and B4 size using the Carrier Sheet. By folding the document in half and scanning in duplex mode, the two sides are merged into a single image.

ATTENTION

The [Deskew by text on document] check box ([Scanning] tab → [Option] in the ScanSnap setup dialog box) will be disabled.

HINT

You can also scan documents smaller than A4/Letter size and have both sides saved as a single image.

1. Select [Scan Button Settings] from the Right-Click Menu.

For details about the Right-Click Menu, refer to "[Right-Click Menu \(Windows\)](#)" (page 37).

⇒ The ScanSnap setup dialog box appears.

2. In the [Paper] tab, select [Automatic detection] in [Paper size], and then click the [Carrier Sheet Settings] button.

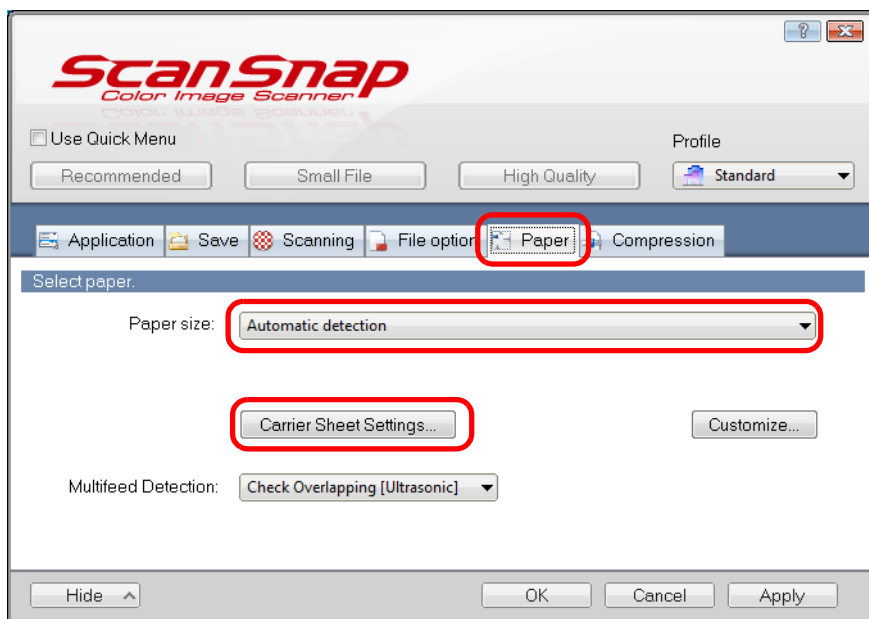

⇒ The [Carrier Sheet Settings] dialog box appears.

3. Select [one double-page spread image] in [Save as] and click the [OK] button.

For details about the Carrier Sheet settings, refer to the ScanSnap Manager Help.

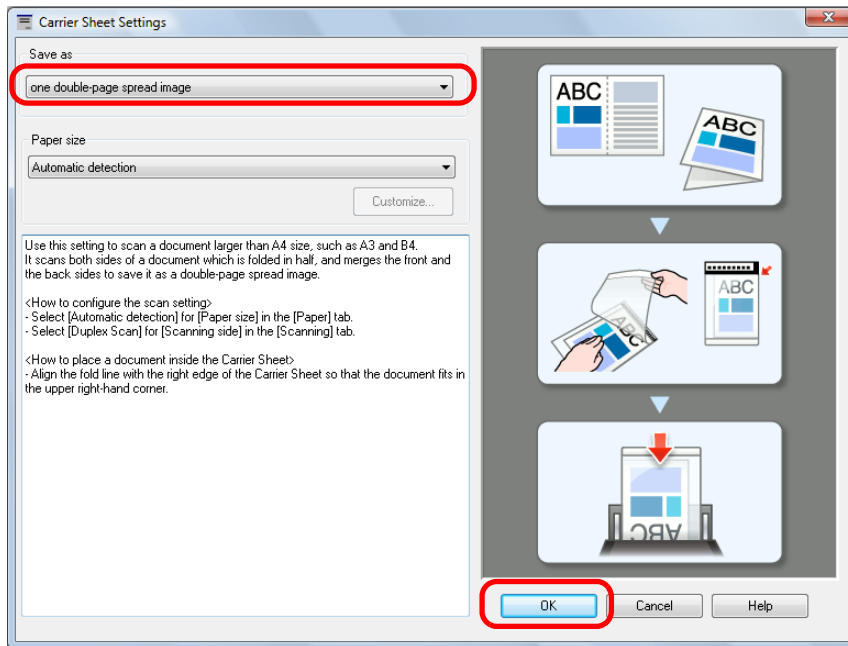

4. In the [Scanning side] drop-down list in the [Scanning] tab, select [Duplex Scan (Double-sided)] and click the [OK] button.

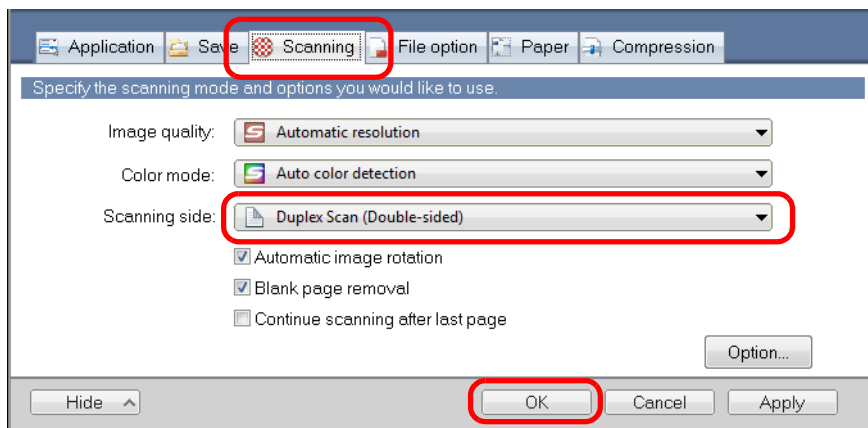

ATTENTION

If [Simplex Scan (Single-sided)] is specified for [Scanning side] in the [Scanning] tab, the ScanSnap outputs the same result as performing a simplex scan in [two separate images (front and back)] mode.

5. Place the document inside the Carrier Sheet.

1. Fold the document in half so that the sides to be scanned are facing out.
Fold it tightly and smooth out any creases.

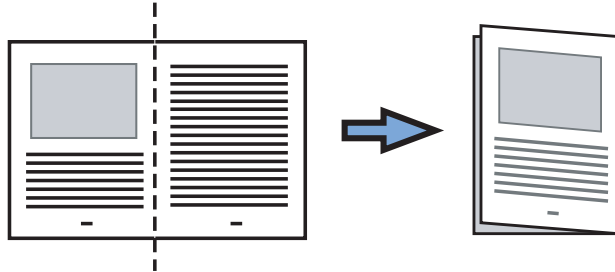

2. Open the Carrier Sheet to bind the document.

Align the fold line with the right edge of the Carrier Sheet so that the document fits in the upper right-hand corner of the Carrier Sheet.

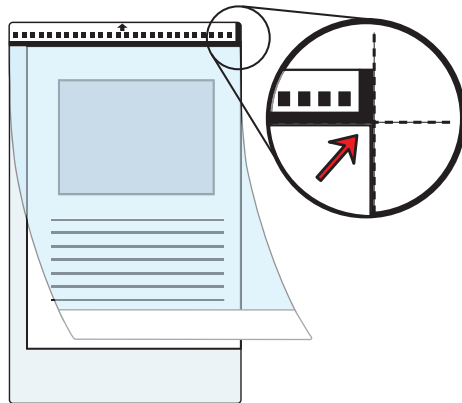

HINT

Note that the front side of the Carrier Sheet has a thick vertical line in the upper right-hand corner.

6. Place the end with the black and white pattern as the leading edge in the direction of the arrow.

Secure the Carrier Sheet with the side guides to avoid skewing.

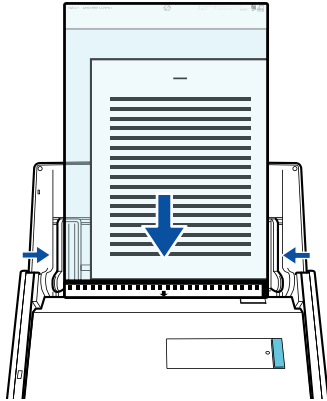

7. Press the [Scan] button on the ScanSnap to start a scan.

⇒ Both sides of the document are scanned and saved as one double-page spread image.

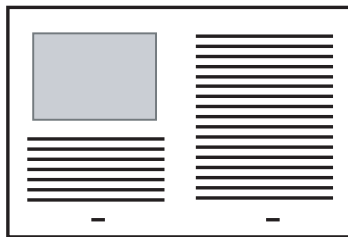

ATTENTION

- There may be a line or a gap appearing between the front and back side images.
Also when you scan thick papers, images on both left and right may skew towards each other from the top.
These symptoms may be improved when you perform the following:
 - Fold the document properly
 - Neatly align the edges of the document with the edges of the Carrier Sheet when placing the document inside the Carrier Sheet
- If [Automatic detection] is specified for [Paper size] in the [Carrier Sheet Settings] dialog box, an optimal size will be selected automatically from the available standard sizes (A3, B4 or 11 × 17 in.) from the same drop-down list.
Note that the size of the image may become smaller than the original document depending on the document.
Example:
When you scan an A3 size document whose content is printed to fit A4 size in the center, the image data is output in B4 size.
To output the scanned image in its original size, specify the document size in the [Paper size] drop-down list.
- Part of the image data around where the document is folded may appear missing. In that case, place the document so that its edge is about 1 mm inside from the edge of the Carrier Sheet.

Scanning Documents Such as Photographs and Clippings

Using the Carrier Sheet allows you to scan documents that can be damaged quite easily such as photographs, or non-standard size documents that are difficult to load directly such as clippings.

Change the settings to scan documents such as photographs and clippings in the following procedure.

ATTENTION

The [Deskew by text on document] check box ([Scanning] tab [Option] in the ScanSnap setup dialog box) will be disabled.

1. Select [Scan Button Settings] from the Right-Click Menu.

For details about the Right-Click Menu, refer to "[Right-Click Menu \(Windows\)](#)" (page 37).

⇒ The ScanSnap setup dialog box appears.

2. In the [Paper] tab, select [Automatic detection] in [Paper size], and then click the [Carrier Sheet Settings] button.

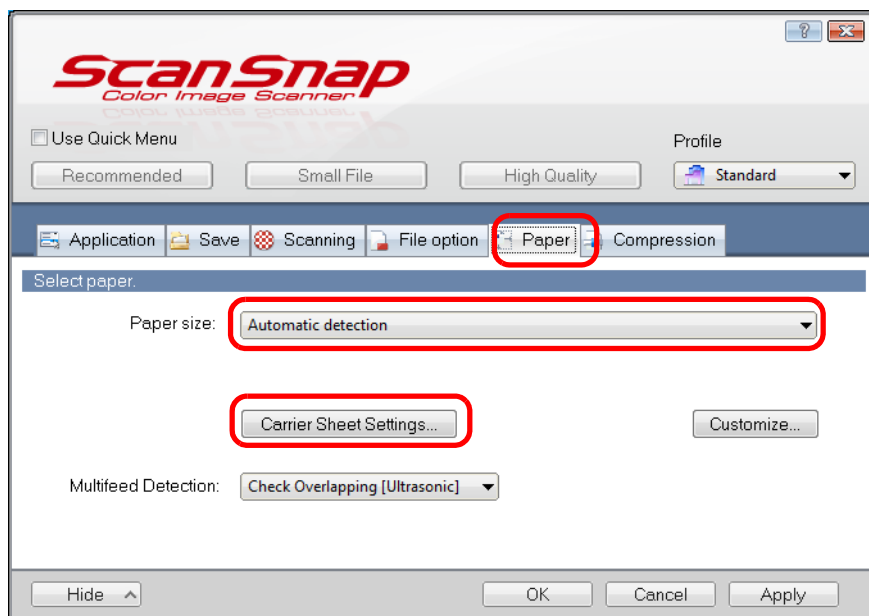

⇒ The [Carrier Sheet Settings] dialog box appears.

3. Select [two separate images (front and back)] in [Save as] and click the [OK] button.

For details about the Carrier Sheet settings, refer to the ScanSnap Manager Help.

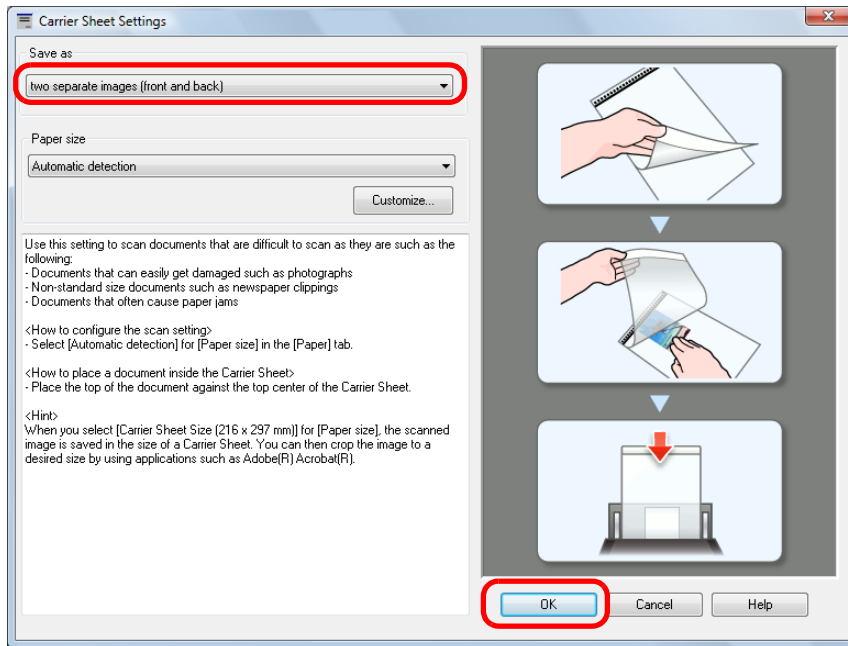

4. Click the [OK] button to close the ScanSnap setup dialog box.

5. Place the document inside the Carrier Sheet.

Open the Carrier Sheet and place the top of the document against the top center of the Carrier Sheet.

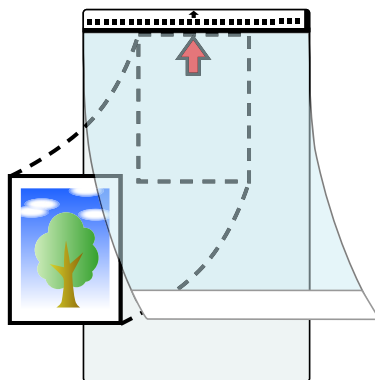

6. Place the end with the black and white pattern as the leading edge in the direction of the arrow.

Set the back side of the document facing towards you.

Secure the Carrier Sheet with the side guides to avoid skewing.

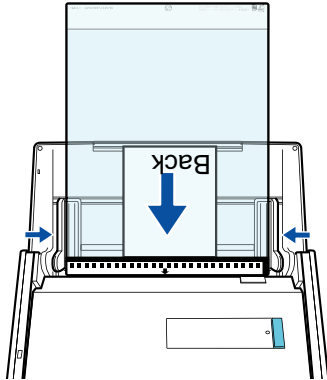

ATTENTION

When the [Place document face up] check box is selected in the [Scanning mode option] dialog box (Right-Click Menu → [Scan Button Settings] → [Scanning] tab → [Option] button), place the document in the Carrier Sheet face-up and bottom edge down.

7. Press the [Scan] button on the ScanSnap to start a scan.

⇒ Scanned image is saved.

ATTENTION

- The scanned image is output at the center of the page in the size specified in the [Paper size] drop-down list of the [Carrier Sheet Settings] dialog box.
- If [Automatic detection] is specified for [Paper size] in the [Carrier Sheet Settings] dialog box, an optimal size will be selected automatically from the available standard sizes (A3, B4 or 11 × 17 in.) from the same drop-down list. Note that the size of the image may become smaller than the original document depending on the document scanned, or part of the image may appear missing.

Example: When an A5 size image is printed in the center of an A4 size document, the image is output in A5 size.

To output the scanned image in its original size, specify the document size in the [Paper size] drop-down list.

HINT

In the following cases, place a blank (white) sheet of paper underneath the document when scanning:

- The scanned image is not saved in the correct size (when [Automatic detection] is selected in the [Paper size] drop-down list of the [Carrier Sheet Settings] dialog box)
- Shadows appear around the edges of the scanned image
- Black lines appear around the edges of a uniquely shaped cutting

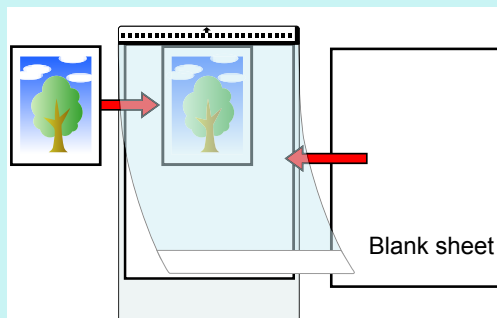

Long Page Scanning

Documents up to 863 mm (34 in.) in length can be scanned.
The following explains how to scan long pages.

1. Load a document in the ScanSnap.

For details about documents that can be loaded, refer to ["Documents for Scanning" \(page 58\)](#).

ATTENTION

- Long page documents should be loaded one sheet at a time in the ADF paper chute (cover).
- When you scan long pages, take note of the following.

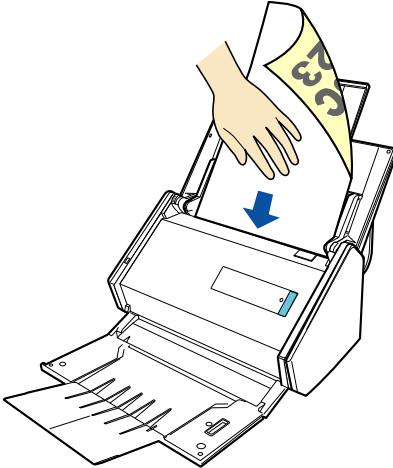
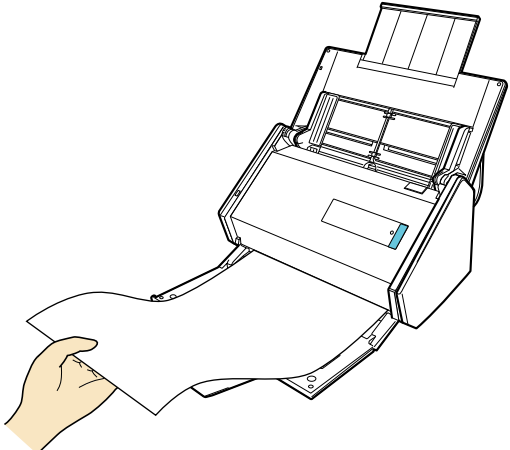
Loading	Ejecting
<p>Hold the document with your hands so that it does not fall out of the ADF paper chute (cover).</p> 	<p>Secure enough space where the documents are ejected from the ScanSnap, and pick up the documents with your hands to prevent them from falling off the unit where the ScanSnap is placed on.</p> 

2. Press the [Scan] button on the ScanSnap for 3 seconds or longer until it flashes in blue.

⇒ Scanning starts.

HINT

When you scan the first page as a long page and continue scanning, the next document is also scanned as long page.

ATTENTION

- When [Excellent] is selected in the [Image quality] drop-down list of the [Scanning] tab in the ScanSnap setup dialog box, the dialog box below appears and long page scanning is not available.

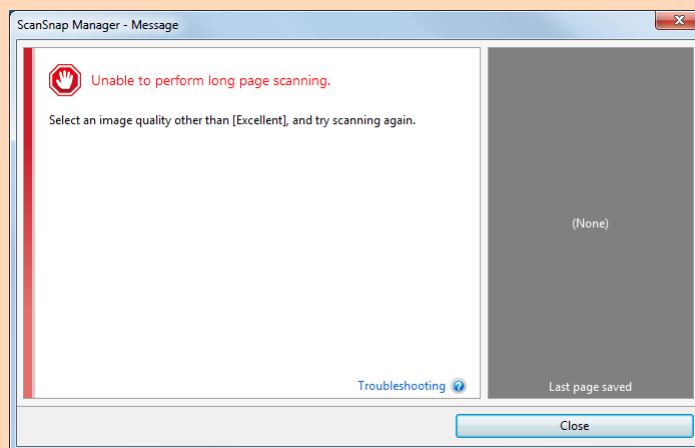

- When you perform a long page scan, the current settings are ignored and the following settings are used:
 - Multifeed Detection: None
 - Paper size: Automatic detection

Saving Scanned Images in Multiple PDF Files

The ScanSnap is able to save scanned image in separate PDF files based on the specified number of pages. For example, you can scan a batch of slips, and save each slip as a PDF file.

To save image data in multiple PDF files, change the settings in the following procedure.

1. Select [Scan Button Settings] from the Right-Click Menu.

For details about the Right-Click Menu, refer to ["Right-Click Menu \(Windows\)"](#) (page 37).

⇒ The ScanSnap setup dialog box appears.

2. In the [File format] drop-down list in the [File option] tab, select [PDF (*.pdf)], and then click the [Option] button.

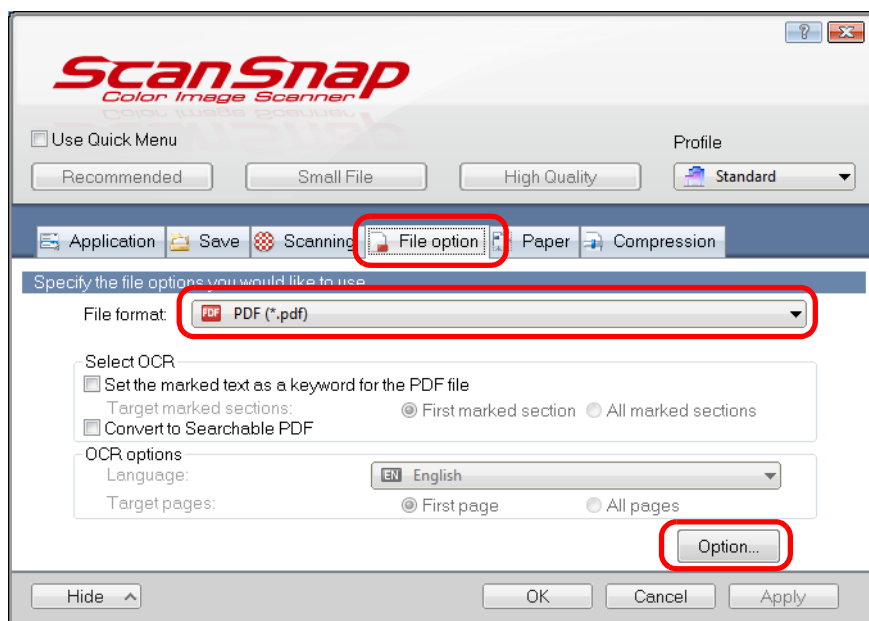

⇒ The [PDF file format option] dialog box appears.

3. Select [Generate one PDF file per (n) page(s)] and enter the number of pages to split.

One PDF is created every time the number of pages specified here has been saved.

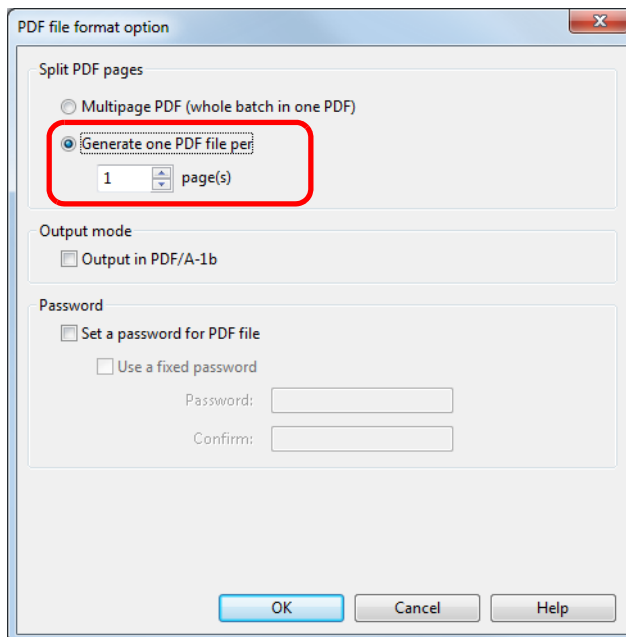

HINT

In duplex mode, two pages (front/back) are created per document.

When you select the [Blank page removal] check box in the [Scanning] tab, the number of pages of the original document and the scanned image does not match because blank pages are deleted.

Clear this check box when you want to keep the original page number order.

4. Click the [OK] button to close all open dialog boxes.

5. Load a document in the ScanSnap.

For details, refer to ["How to Load Documents"](#) (page 63).

6. Press the [Scan] button on the ScanSnap to start a scan.

⇒ One PDF file is created every time the number of pages specified in step 3. has been scanned.

Creating Searchable PDF Files

The ScanSnap is able to perform text recognition on a scanned image automatically and create a searchable PDF file.

To create searchable PDF files, change the settings in the following procedure.

1. Select [Scan Button Settings] from the Right-Click Menu.

For details about the Right-Click Menu, refer to ["Right-Click Menu \(Windows\)"](#) (page 37).

⇒ The ScanSnap setup dialog box appears.

2. In the [File format] drop-down list in the [File option] tab, select [PDF (*.pdf)].

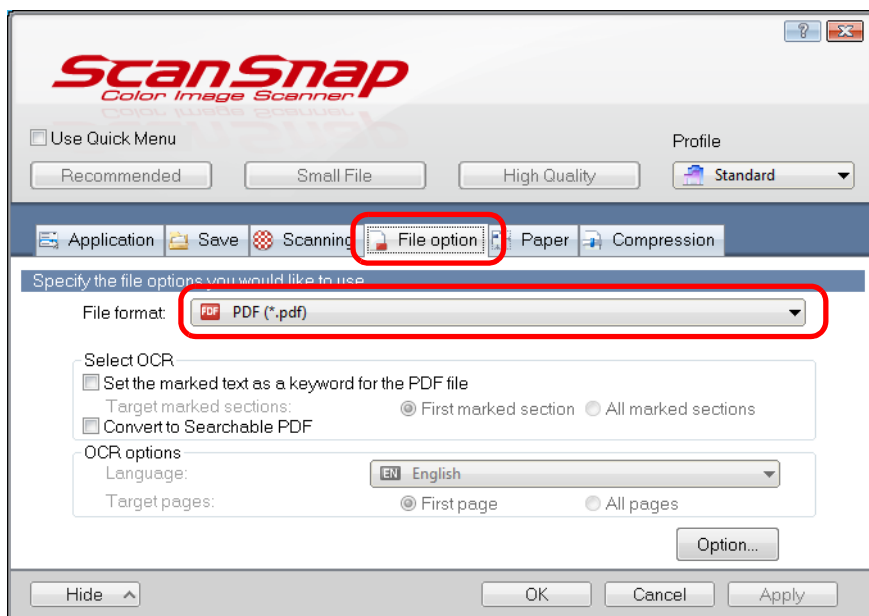

HINT

It is recommended that you select [Better] or [Best] for [Image quality] in the [Scanning] tab of the ScanSnap setup dialog box.

3. Select the [Convert to Searchable PDF] check box.

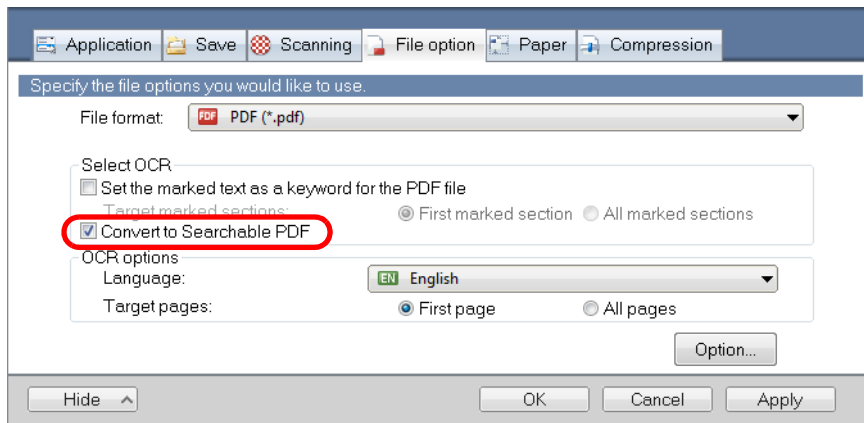

⇒ The following message appears.

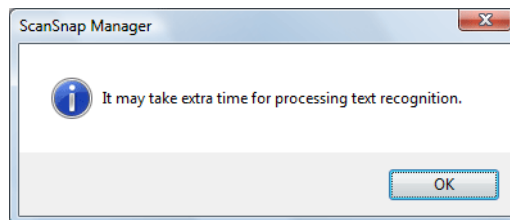

4. Click the [OK] button to close the message.

5. Specify the text recognition option.

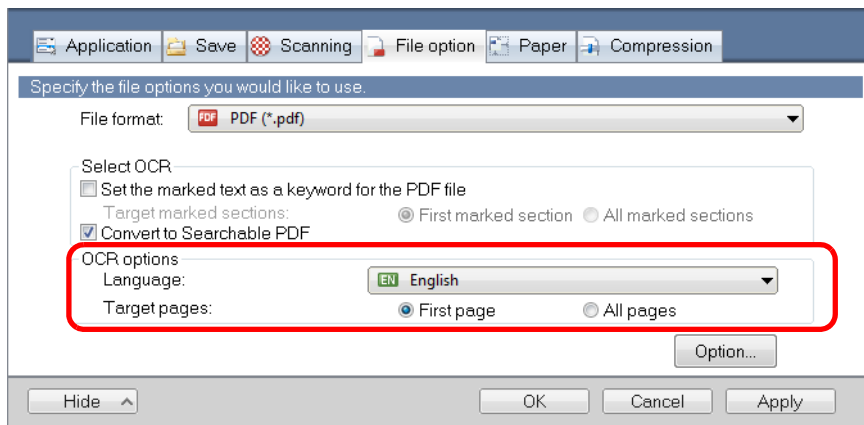

- Language
Select the language. Japanese, English, French, German, Italian, Spanish, Chinese (simplified), Chinese (traditional), Korean, Russian, and Portuguese can be selected.
- Target pages
Select [All pages] to perform text recognition for all pages and [First page] for just the first page.

6. Click the [OK] button to close the ScanSnap setup dialog box.

7. Load a document in the ScanSnap.

For details, refer to ["How to Load Documents" \(page 63\)](#).

8. Press the [Scan] button on the ScanSnap to start a scan.

⇒ Text recognition is performed on the scanned image and a searchable PDF file is created.

ATTENTION

- It may take extra time to process text recognition depending on your computer system environment when you enable this setting in step 3.
- Scanned images of the following types of documents (characters) may not be recognized correctly. In that case, better results in text recognition may be achieved by changing the setting for [Color mode] or specifying a higher resolution in [Image quality].
 - Documents including handwritten characters
 - Documents with small characters scanned at a low resolution
 - Skewed documents
 - Documents written in languages other than the specified language
 - Documents including texts written in italic characters
 - Documents containing characters with superscripts/subscripts and complicated mathematical expressions
 - Documents with characters on an unevenly colored background
e.g. Shaded characters
 - Documents with many decorated characters
e.g. Decorated characters (embossed/outlined)
 - Documents with characters on a patterned background
e.g. Characters overlapping illustrations and diagrams
 - Documents with many characters contacting underlines or borders
- It may take extra time to perform text recognition on the following documents:
 - Documents with complex layouts
 - Documents with information other than text
e.g. Text on a shaded background
- If bleed-through reduction is enabled, the recognition rate may be lowered. In that case, disable it in the following procedure.
Select [Scan Button Settings] → [Scanning] tab → [Option] button from the Right-Click Menu to show the [Scanning mode option] dialog box. Clear the [Reduce bleed-through] check box.

Setting Keywords in PDF Files

If the document is black & white, character strings (e.g. page heading, title) can be set as keywords and used for a PDF file search.

Mark a character string to be set as a keyword with a water-based highlight pen so that the character string is completely covered.

When you perform a scan, the marked character strings are recognized and set as keywords for the PDF file.

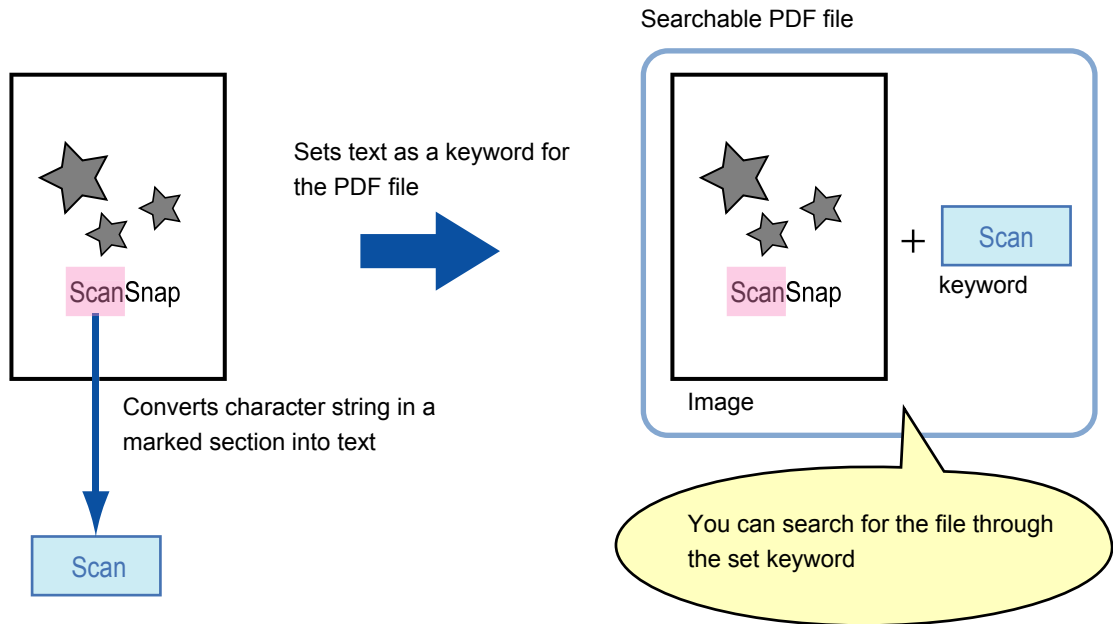

Mark black & white documents in the following way:

- Any regular highlight pen can be used.

The following shows the colors and thickness recommended for highlight pens:

Pink	Yellow	Blue	Green

- Mark a straight line over a single character string.
- The supported range of a marked section is as follows:
Minimum: 3 mm (short side) × 10 mm (long side)
Maximum: 20 mm (short side) × 150 mm (long side)
- Use only one color per page for marking.

- Make sure to cover the entire character string when marking it.
Mark sections so that the entire section is evenly colored.

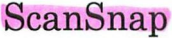
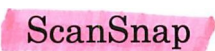
Good example:	Bad example 1: (does not cover the entire section)	Bad example 2: (unevenly colored)
		

- Do not mark more than ten sections per page.

ATTENTION

- It is recommended that you use a blue or a green highlight pen for marking. When you use colors such as pink or yellow for marking, the marked sections may not be recognized as keywords.
- Use a blue highlight pen for documents with dark background colors such as newspapers. Marked sections may not be detected when a color other than blue is used.
- For the following documents, marked sections cannot be recognized and set as keywords:
 - Color documents such as catalogues or pamphlets
 - Documents in which two or more colors are used for marking
 - Documents containing colors other than for marking (pens other than highlight pens are used or the document is stained)
 - Documents with too many marked sections on a single page
- The following types of marked character strings cannot be set as keywords:
 - The size of the marked section is outside the supported range
 - The marking is irregular (e.g. skewed)
 - Multiple marked sections are too close to each other
 - The color of the highlight pen is too pale or the color has faded

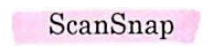

- When you mark more than one character string, make sure to leave a gap of at least 5 mm between the marked sections. Marked sections that are too close to each other may be detected as one marked section.
- In the following case, character strings surrounding marked sections may be set as keywords:
Marked section overlaps the line above and below
- In the following cases, unmarked character strings may be set as keywords:
 - Color documents such as catalogues or pamphlets
 - Documents with color text, diagrams, pictures, tables and lines
 - Documents containing sections framed by a highlight pen
 - Stained documents

HINT

- Increase the resolution when you have trouble setting the keywords correctly.
- Keywords set for a PDF file can be checked in the ScanSnap Organizer Main Window (thumbnail view), or in [Document Properties] of Adobe Acrobat/Adobe Reader.

Change the settings in the following procedure to automatically set keywords for PDF files.

1. Select [Scan Button Settings] from the Right-Click Menu.

For details about the Right-Click Menu, refer to "[Right-Click Menu \(Windows\)](#)" (page 37).

⇒ The ScanSnap setup dialog box appears.

2. In the [File format] drop-down list in the [File option] tab, select [PDF (*.pdf)].

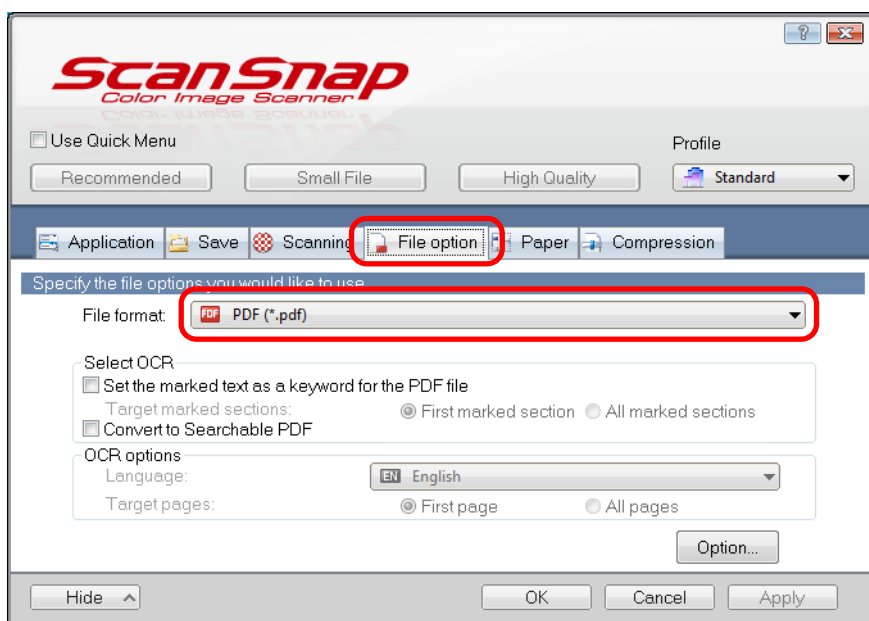

HINT

It is recommended that you select [Better] or [Best] for [Image quality] in the [Scanning] tab of the ScanSnap setup dialog box.

3. Select the [Set the marked text as a keyword for the PDF file] check box.

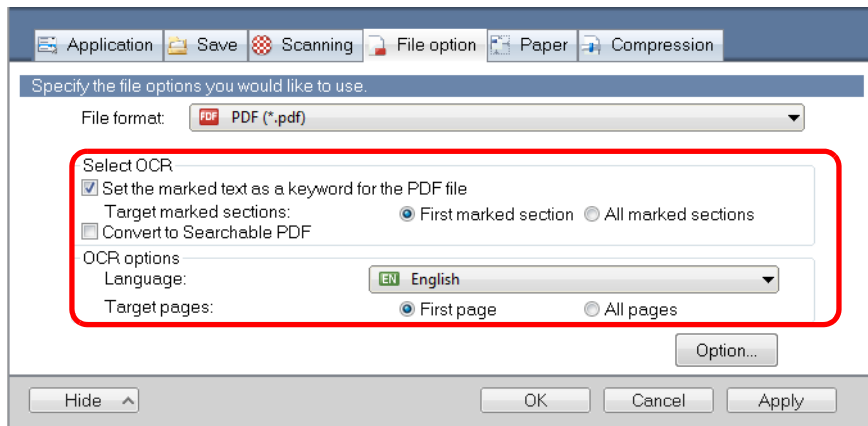

● Target marked sections

Select [First marked section] to perform text recognition and set a keyword for the PDF file only for the character strings in the first marked section, and [All marked sections] for all marked sections.

ATTENTION

Do not select [First marked section] when the text orientation of your document is vertical.

HINT

The following explanation is for when you select [First marked section]:

- Select this button to set a character string such as a title of a document as a keyword for the PDF file.

Example: When only the title of a document is marked, the marked character string is set as a keyword for the PDF file, and the PDF file becomes searchable by the title character string.

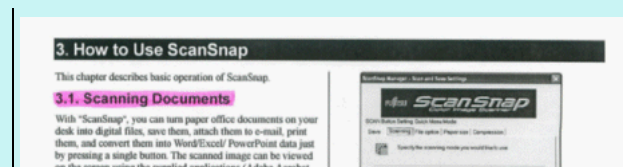

- When multiple marked sections exist in line, the marked character string closest to the top of the document is set as a keyword.

Example: In the following case, the character string in marked section B, which is higher than marked section A, is set as a keyword.

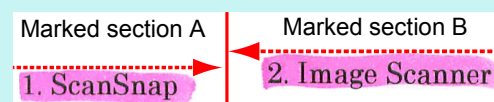

- Language
Select the language. Japanese, English, French, German, Italian, Spanish, Chinese (simplified), Chinese (traditional), Korean, Russian, and Portuguese can be selected.
- Target pages
Select [First page] to perform text recognition and set a keyword for the PDF file only for the first page, and [All pages] for all pages.

4. Click the [OK] button to close the ScanSnap setup dialog box.

5. Load a document in the ScanSnap.

For details, refer to ["How to Load Documents" \(page 63\)](#).

6. Press the [Scan] button on the ScanSnap to start a scan.

⇒ Text recognition is performed on marked character strings and a PDF file is created with the keywords added.

ATTENTION

- It may take extra time to process text recognition depending on your computer system environment when you enable this setting in step 3.
- Scanned images of the following types of documents (characters) may not be recognized correctly.
In that case, better results in text recognition may be achieved by specifying a higher resolution in [Image quality].
 - Documents including handwritten characters
 - Documents with small characters scanned at a low resolution
 - Skewed documents
 - Documents written in languages other than the specified language
 - Documents including texts written in italic characters
 - Documents containing characters with superscripts/subscripts and complicated mathematical expressions
 - Documents with characters on an unevenly colored background
e.g. Shaded characters
 - Documents with many decorated characters
e.g. Decorated characters (embossed/outlined)
 - Documents with characters on a patterned background
e.g. Characters overlapping illustrations and diagrams
 - Documents with many characters contacting underlines or borders
- It may take extra time to perform text recognition on the following documents:
 - Documents with complex layouts
 - Documents with information other than text
e.g. Text on a shaded background
- If bleed-through reduction is enabled, the recognition rate may be lowered, and the marker may be erased or lightened. In that case, disable it in the following procedure.
Select [Scan Button Settings] → [Scanning] tab → [Option] button from the Right-Click Menu to show the [Scanning mode option] dialog box. Clear the [Reduce bleed-through] check box.

- If the same character string is marked several times in the document, the same keyword is added multiple times in the PDF file.
- Total length of all the keywords can be up to 255 characters, including punctuation marks in between keywords.
- When you check keywords in Adobe Acrobat or Adobe Reader, the added keywords may be displayed with a set of quotation marks (e.g. "ABC").

Setting Passwords for PDF Files

You can set Document Open passwords for PDF files when saving the image data as PDF files.

Once you set a password for a PDF file, the password-protected PDF files cannot be opened by anyone except the person who knows the password. You can protect important information by setting a password for private or confidential documents.

Change the settings to set passwords for PDF files in the following procedure.

ATTENTION

- When you use the Quick Menu, you cannot set passwords to scanned documents.
- If a password is specified for a created PDF/A file, it does not conform to PDF/A-1b.

1. Select [Scan Button Settings] from the Right-Click Menu.

For details about the Right-Click Menu, refer to "[Right-Click Menu \(Windows\)](#)" (page 37).

⇒ The ScanSnap setup dialog box appears.

2. In the [File format] drop-down list in the [File option] tab, select [PDF (*.pdf)], and then click the [Option] button.

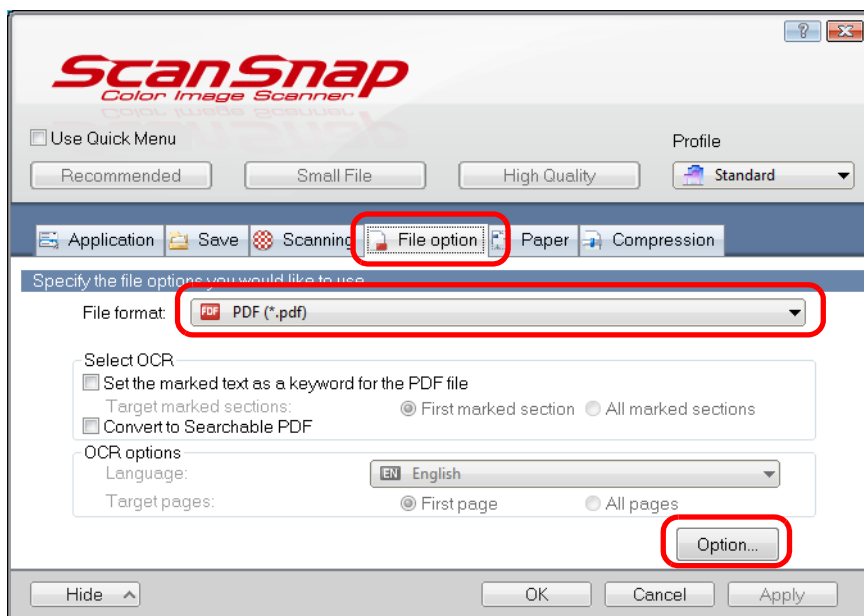

⇒ The [PDF file format option] dialog box appears.

3. Select the [Set a password for PDF file] check box.

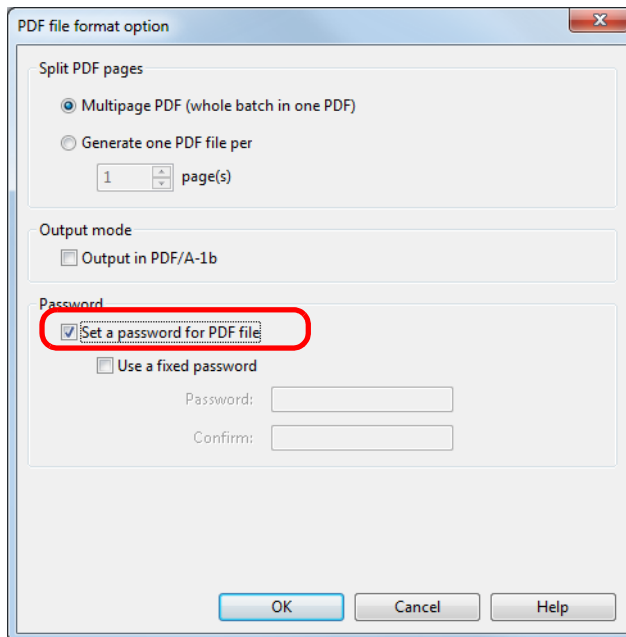

- To set a different password per scan
Clear the [Use a fixed password] check box.
You can set a different password per scan.

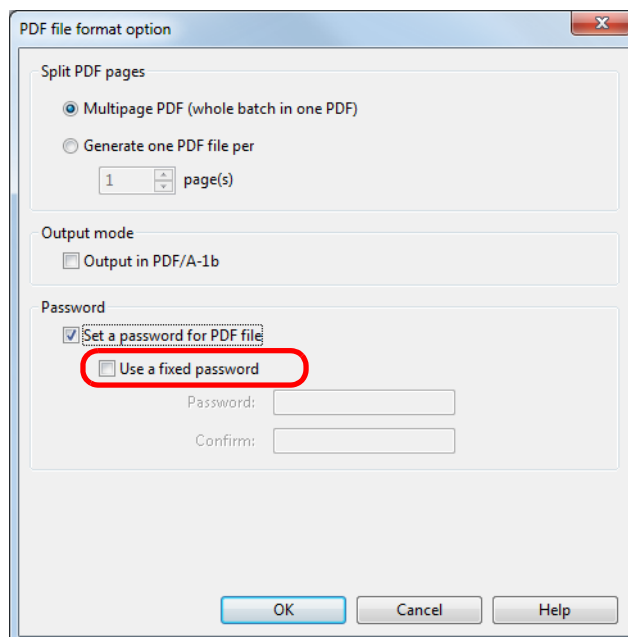

- To use a preset password

1. Select the [Use a fixed password] check box.

The same password is set for all PDF files. You do not have to set a password every time a document is scanned.

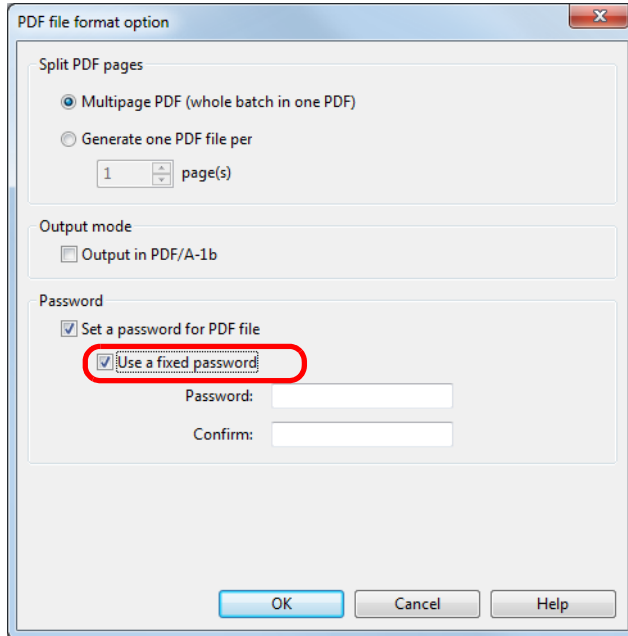

2. Type in the same password in the [Password] and [Confirm] fields.

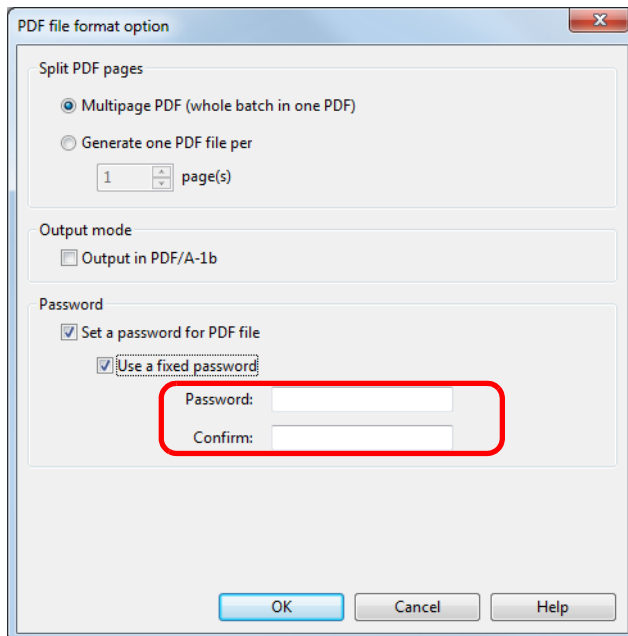

HINT

The following characters can be used to set passwords:

Max. characters : Up to 16 characters

Alphanumeric characters : A-Z, a-z, 0-9

Symbols : ! " # \$ % & ' () * + , - . / : ; < = > ? @ [\] ^ _ ` { | } ~

4. Click the [OK] button to close all open dialog boxes.

5. Load a document in the ScanSnap.

For details, refer to ["How to Load Documents"](#) (page 63).

6. Press the [Scan] button on the ScanSnap to start a scan.

⇒ When the [Use a fixed password] check box is cleared in step 3., the following dialog box appears after scanning is completed.

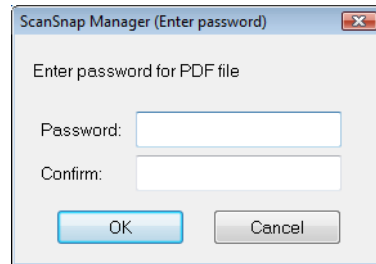

Type in the same password in the [Password] and [Confirm] fields, and then click the [OK] button.

HINT

- The following characters can be used to set passwords:
Max. characters : Up to 16 characters
Alphanumeric characters : A-Z, a-z, 0-9
Symbols : ! " # \$ % & ' () * + , - . / : ; < = > ? @ [\] ^ _ ` { | } ~
- If you click the [Cancel] button, the PDF file is saved without a password.

⇒ The scanned image is saved as a password-protected PDF file.

ATTENTION

It is not possible to open a PDF file if you forget the password.

Creating PDF/A Files

You can create PDF/A files that conform to PDF/A-1b.

PDF/A is a file format that is used for long-term storage and management of electronic documents. This is a suitable file format when you need to convert documents into image data and store them for a long time.

PDF/A-1b is one of the compliance levels for PDF/A.

To create PDF/A files, change the settings in the following procedure.

ATTENTION

- If you edit a created PDF/A file, it may no longer conform to PDF/A-1b.
- The following cannot be specified for PDF/A files.
 - Password

1. Select [Scan Button Settings] from the Right-Click Menu.

For details about the Right-Click Menu, refer to ["Right-Click Menu \(Windows\)"](#) (page 37).

⇒ The ScanSnap setup dialog box appears.

2. In the [File format] drop-down list in the [File option] tab, select [PDF (*.pdf)], and then click the [Option] button.

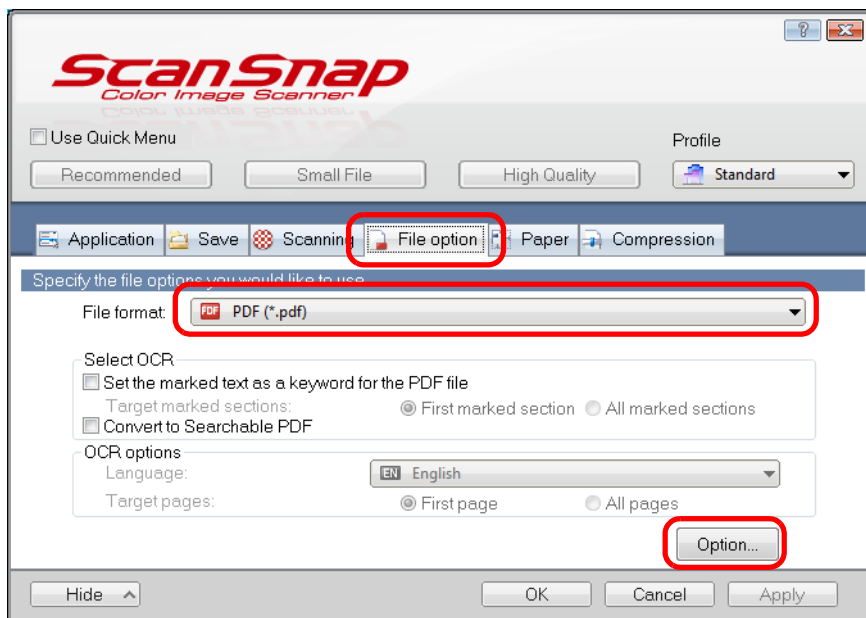

⇒ The [PDF file format option] dialog box appears.

3. Select the [Output in PDF/A-1b] check box.

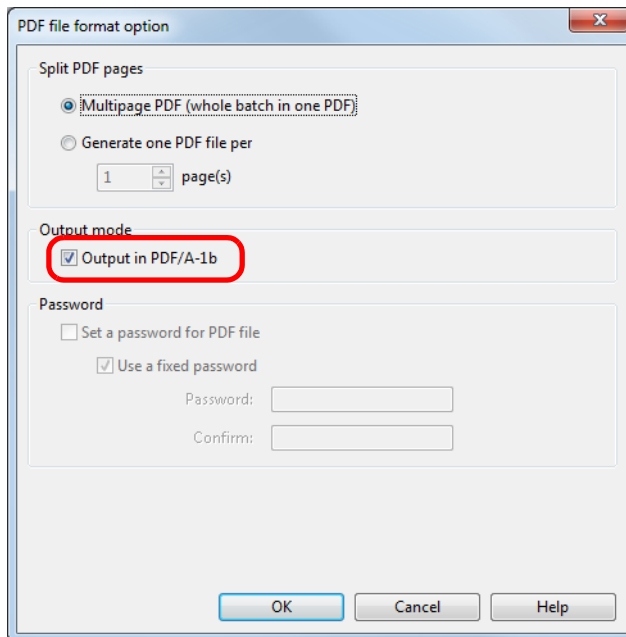

⇒ The following message appears.

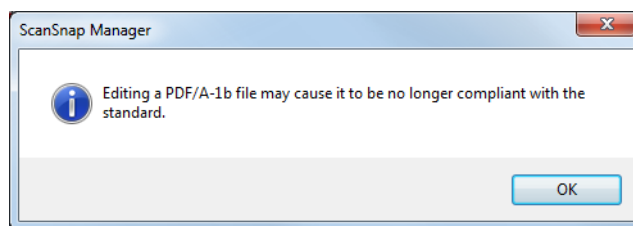

4. Click the [OK] button to close all open dialog boxes.

5. Load a document in the ScanSnap.

For details, refer to ["How to Load Documents"](#) (page 63).

6. Press the [Scan] button on the ScanSnap to start a scan.

⇒ The scanned image is saved as a PDF/A file.

Configuring ScanSnap Manager

This section explains how to configure scan and Quick Menu settings, automatic linkage with applications, scanning progress status, and dialog boxes displayed during scanning.

How to Configure Scan Settings

You can configure ScanSnap Manager scan settings depending on your intended use of the scanned images. Scan settings can be configured using the ScanSnap setup dialog box. You can configure scan settings for the following scanning methods.

- Basic Scanning Methods
 - Scanning using the Quick Menu ([page 114](#))
- Convenient Scanning Methods
 - Scanning using a profile ([page 203](#))
 - Scanning using ScanSnap Folder ([page 216](#))

Configure scan settings in the following procedure.

1. Open the ScanSnap setup dialog box.

- Scanning using the Quick Menu or profile:
 - Select [Scan Button Settings] from the Right-Click Menu.
 - Scanning using ScanSnap Folder:
 - Select [ScanSnap Folder Settings] from the Right-Click Menu.
- ⇒ The ScanSnap setup dialog box appears.
- If you use ScanSnap Folder to scan, go to step 3.

HINT

You can also open the ScanSnap setup dialog box by the following ways. If the "ScanSnap Folder" folder is opened, the ScanSnap setup dialog box for ScanSnap Folder appears. For details about ScanSnap Folder, refer to "[ScanSnap Folder Operations](#)" ([page 216](#)).

- Double-click the ScanSnap Manager icon .
- Press [Ctrl], [Shift], and [Space] keys simultaneously.
- Select [Start] menu → [All Programs] → [ScanSnap Manager] → [ScanSnap Manager settings] (for Windows 8, right-click the Start screen, and select [All apps] on the app bar → [ScanSnap Manager settings] under [ScanSnap Manager]).

2. Click the [Detail] button to switch to the detail view mode.

Example: ScanSnap setting dialog box when scanning using the Quick Menu.

Outline view

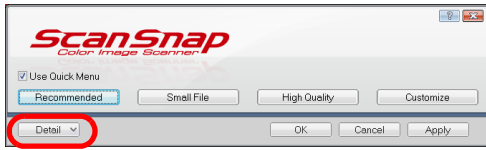

Detail view

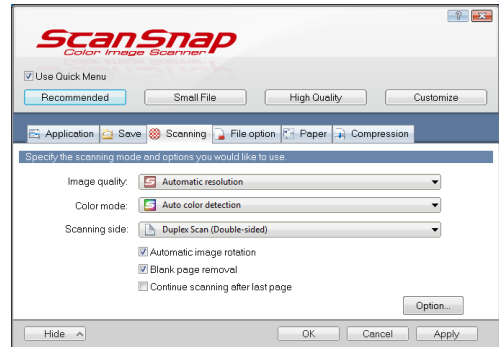

HINT

The ScanSnap setup dialog box retains the display status from the last time the ScanSnap was used. For example, if it was closed in detail view mode, the dialog box is displayed in detail view mode next time you open it.

3. Set the scan settings in each tab.

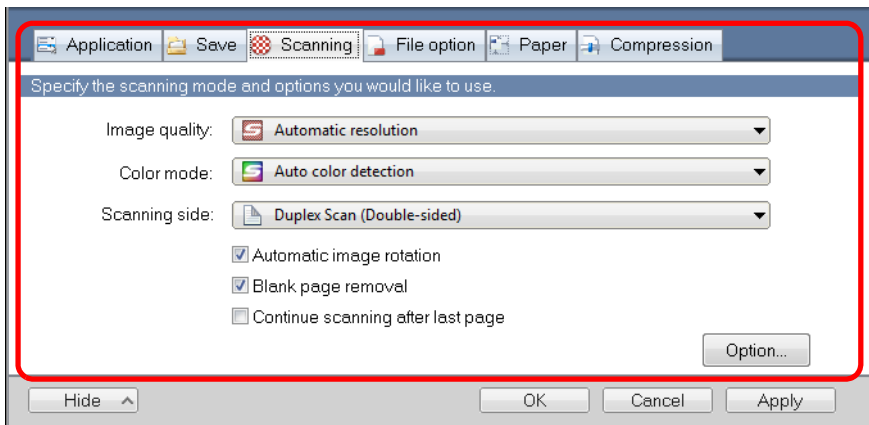

For details about each tab, refer to the ScanSnap Manager Help.

ATTENTION

Scan settings vary depending on the scanning method. For details about items that can be set, refer to "Setting Items by Scanning Method" (page 468).

4. Click the [OK] or [Apply] button.

⇒ Scan settings are changed.

- When you use the Quick Menu, scan settings for the [Customize] button are changed.
- When you use a profile, scan settings for the currently selected profile are changed.

HINT

If you press the [Scan] button on the ScanSnap while the ScanSnap setup dialog box is displayed, the ScanSnap setup dialog box closes and scanning starts. Scan settings that you have changed are saved and documents are scanned by these settings.

Note that when other dialog boxes are open, scanning does not start even if you press the [Scan] button on the ScanSnap unless open dialog boxes are closed.

Quick Menu Settings

This section explains the Quick Menu.

You can change the Quick Menu's display mode and the order in which the applications are displayed.

HINT

- For details about how to display the Quick Menu, refer to ["Scanning" \(page 116\)](#).
- For details about applications displayed in the Quick Menu, refer to ["Using ScanSnap with the Quick Menu" \(page 119\)](#).

Quick Menu

The Quick Menu displays applications that can be linked.



Applications that are newly added to the Quick Menu are indicated by the  mark.

HINT

You can freely add applications to the Quick Menu. For details, refer to the ScanSnap Manager Help.

Changing Display Mode

The following two modes are available in the Quick Menu:

- [Favorites] mode
Shows only the applications specified as favorites. When you set often-used applications as favorites and show them in [Favorites] mode, you can quickly and conveniently find the applications. For details about how to specify favorites, refer to ["Favorite Applications" \(page 274\)](#).
- [All Applications] mode
Shows all applications available in the Quick Menu.

By default, the Quick Menu is displayed in [Favorites] mode which includes all applications. To switch the display mode, click [Show All Applications] or [Show Favorites] in the Quick Menu.

HINT

The Quick Menu retains the last displayed status. For example, when you close the Quick Menu in [All Applications] mode, it will open in [All Applications] mode next time.

Changing Display Order

You can change the order in which applications are displayed in the Quick Menu. The procedure is as follows.

1. Click  in the Quick Menu.

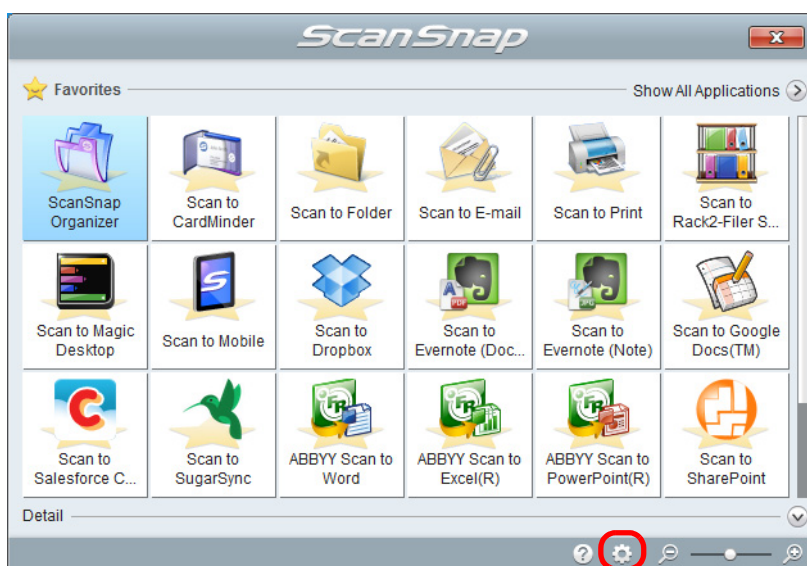

⇒ The [Applications to Show/Hide] dialog box appears.

2. Specify the order in which applications are displayed in the Quick Menu.

Applications are displayed in the Quick Menu in the same order as they are listed in the [Applications to Show/Hide] dialog box.

You can change the display order of an application by selecting the application and clicking either (▲) or (▼).

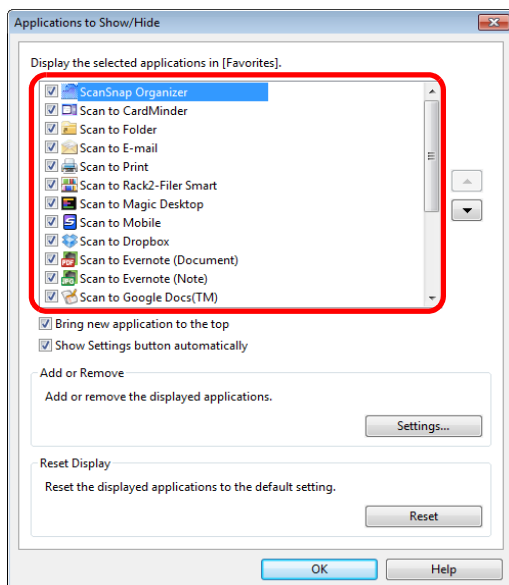

HINT

When you click the [Reset] button in the [Reset Display], the following return to their defaults.

- Order of applications displayed in the Quick Menu
- Favorites setting

The applications are displayed in the order shown below in the Quick Menu and in the application list of the [Applications to Show/Hide] dialog box.

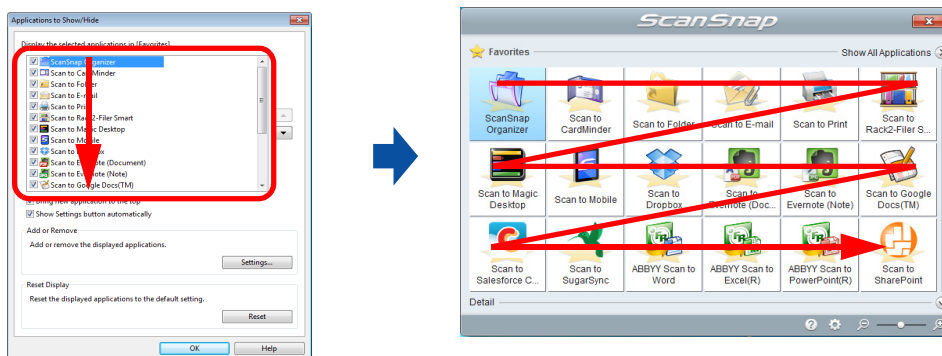

3. Click the [Close] button to close the [Applications to Show/Hide] dialog box.

⇒ The order in which applications are displayed in the Quick Menu is changed.

Favorite Applications

You can set often-used applications as favorites in order to select them from the Quick Menu easily.

The procedure is as follows.

1. Click [Show All Applications] in the Quick Menu.

⇒ The Quick Menu switches to [All Applications] mode.

2. Right-click an application that you want to set as a favorite and click [Add to Favorites] in the displayed menu.

⇒ The application is set as a favorite.

A check mark is placed next to [Add to Favorites] and a star is displayed behind the application icon.

HINT

- By default, all applications are set as favorites. To switch the favorites setting, clear the check mark for [Add to Favorites].
- You can also set favorite applications in the [Applications to Show/Hide] dialog box.

Recommended Applications

Depending on the size of the scanned document, ScanSnap Manager shows the recommended application.

Example:

When you scan a document of business card size, the following recommended application is shown.

- Scan to CardMinder



You can show or hide the recommended applications by clicking [Show Recommended] or [Hide Recommended] on the Quick Menu.

Automatic Linkage with Applications

When one of the applications which can automatically link with ScanSnap Manager is running and you perform scanning, ScanSnap Manager will automatically link with the corresponding application regardless of the current scan settings or whether you are using the Quick Menu.

Applications that can automatically link with ScanSnap Manager are as follows:

- ScanSnap Organizer
Scanned image is displayed in ScanSnap Organizer.
- CardMinder
Scanned image is displayed in CardMinder.
- Rack2-Filer Smart trial version or Rack2-Filer Smart (provided with ScanSnap iX500 Deluxe or sold separately)
Scanned image is saved in Rack2-Filer Smart.
- Magic Desktop trial version or Magic Desktop (provided with ScanSnap iX500 Deluxe or sold separately)
Scanned image is saved in Magic Desktop.
- Scan to Mobile (*)
Scanned image is sent to a mobile device.
* : Automatic linkage is available only when the application is active.

There are two modes for automatic linkage.

Link when one of the above applications is active (recommended)

When ScanSnap Organizer, CardMinder or Rack2-Filer Smart becomes active (with the application's dialog box brought to front and selected on taskbar), performing a scan by pressing the [Scan] button automatically starts the linkage between ScanSnap Manager and the active application.

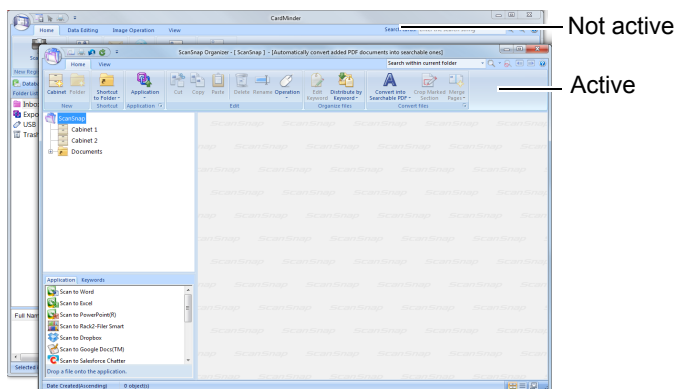

The example above shows ScanSnap Manager automatically linking with ScanSnap Organizer when ScanSnap Organizer's main window is in front (active).

Always link when one of the above applications is running

When ScanSnap Organizer, CardMinder, or Rack2-Filer Smart is started, the application specified for [Application] in the [Application] tab in the ScanSnap dialog box automatically switches to the running application. The application will automatically link with ScanSnap Manager even when the application window is minimized or not displayed in the front. The linkage between the application and ScanSnap Manager automatically ends once you exit the application.

When more than one application is running at the same time, priority will be given in the following order:

1. CardMinder
2. ScanSnap Organizer
3. Rack2-Filer Smart trial version or Rack2-Filer Smart (provided with ScanSnap iX500 Deluxe or sold separately)
4. Magic Desktop trial version or Magic Desktop (provided with ScanSnap iX500 Deluxe or sold separately)

ATTENTION

For Rack2-Filer Smart and Magic Desktop, linkage priority is given to the application that is launched later than the other one.

For example, if you start up Rack2-Filer Smart when Magic Desktop is already running, ScanSnap Manager will link with Rack2-Filer Smart.

When the Quick Menu is disabled, the name of the interacting application on the Left-Click Menu is followed by "is interacting".

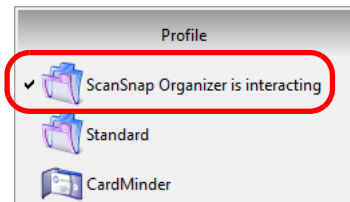

When ScanSnap Organizer is automatically interacting with ScanSnap Manager

ATTENTION

For CardMinder

- Scanning is performed with the current settings. If there are some settings that are not supported by CardMinder, the default settings are used. For details about CardMinder default settings, refer to the ScanSnap Manager Help.
- ScanSnap Manager automatically links with CardMinder when the document is of business card size. When documents of other sizes are scanned, ScanSnap Manager and CardMinder are not automatically linked, and the following error message appears.

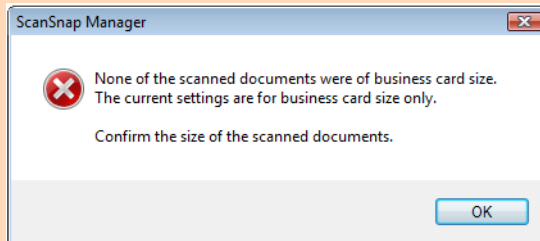

Changing Automatic Linkage Mode

Change automatic linkage mode options in the following procedure.

1. Select [Help] → [Preferences] from the Right-Click Menu.

For details about the Right-Click Menu, refer to "[Right-Click Menu \(Windows\)](#)" (page 37).

⇒ The [ScanSnap Manager - Preferences] dialog box appears.

2. Select the automatic linkage mode in the [Automatic Linkage] tab.

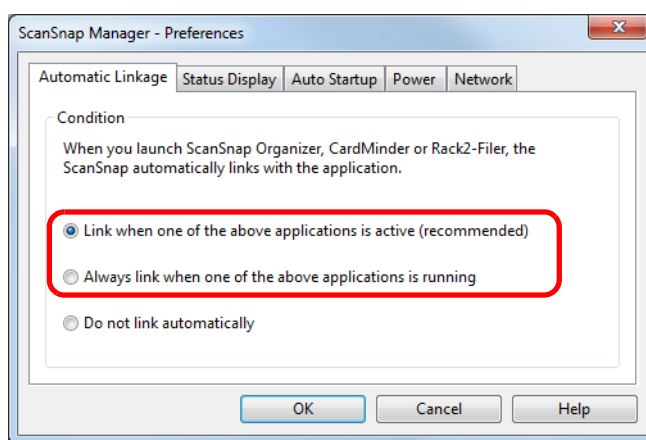

3. Click the [OK] button to close the [ScanSnap Manager - Preferences] dialog box.

⇒ The setting is changed to the selected automatic linkage mode.

HINT

To disable automatic linkage, select [Do not link automatically] in the [Automatic Linkage] tab of the [ScanSnap Manager - Preferences] dialog box.

ScanSnap's Communication Status

If you turn the ScanSnap ON/OFF or connect the ScanSnap to a wireless LAN while ScanSnap Manager is running, the pop-up balloon notifies you of the communication status of the ScanSnap.

When the ScanSnap is ON

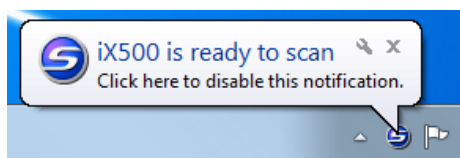

(When a USB cable is used for connection)

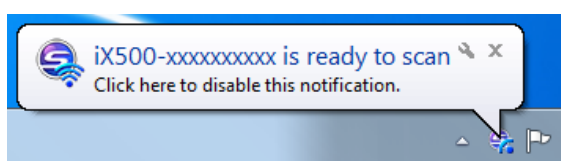

(When a wireless LAN is used for connection)

HINT

When you use automatic connection for the ScanSnap that had been connected with a wireless LAN before, if the password for the ScanSnap to be connected is changed, the pop-up balloon shown below appears.

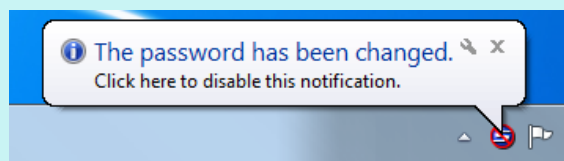

When the ScanSnap is OFF

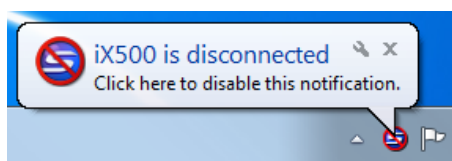

HINT

To disable notifications of the ScanSnap's communication status, click the pop-up balloon, and in the [Status Display] tab of the [ScanSnap Manager - Preferences] dialog box, clear the [Notify of the communication status] check box.

When the ScanSnap will be automatically turned off soon

When the time until auto power-off is specified, the notification appears in the notification dialog box 5 minutes before the ScanSnap turns off.

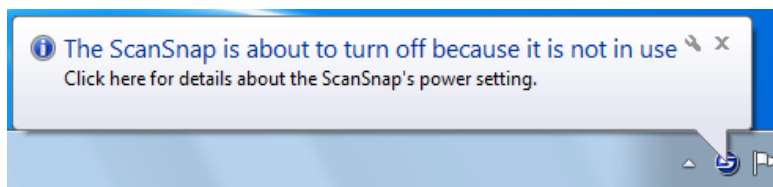

When connected to a mobile device via wireless LAN

When the ScanSnap and a mobile device are connected via wireless LAN, communication with ScanSnap Manager is disconnected, and the pop-up balloon notifies you of the communication status.

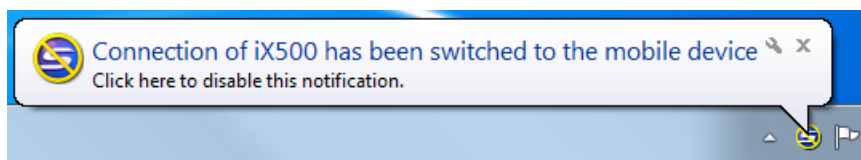

HINT

To disable notifications of the ScanSnap's communication status, click the pop-up balloon, and in the [Status Display] tab of the [ScanSnap Manager - Preferences] dialog box that appears, clear the [Notify of the communication status] check box.

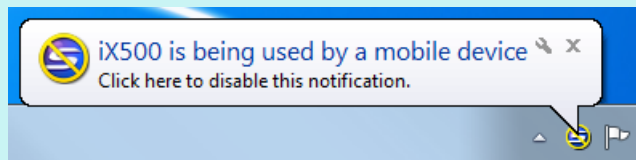

Receiving or hiding the ScanSnap's communication status notifications

You can specify whether or not to receive notifications of the ScanSnap's communication status with a pop-up balloon.

Configure the setting in the following procedure.

1. Select [Help] → [Preferences] from the Right-Click Menu.

For details about the Right-Click Menu, refer to "[Right-Click Menu \(Windows\)](#)" (page 37).

⇒ The [ScanSnap Manager - Preferences] dialog box appears.

2. In the [Status Display] tab, either select or clear the [Notify of the communication status] check box.

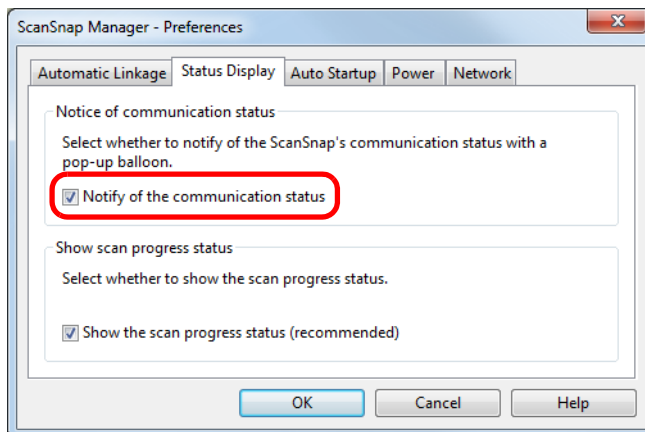

If you select the [Notify of the communication status] check box, you will be notified of the communication status in conjunction with the ScanSnap being turned ON/OFF. If you clear the [Notify of the communication status] check box, you will not be notified of the communication status.

3. Click the [OK] button to close the [ScanSnap Manager - Preferences] dialog box.

Showing the Scanning Progress

When scanning starts, the [ScanSnap Manager - Image scanning and file saving] dialog box appears.

The [ScanSnap Manager - Image scanning and file saving] dialog box consists of the following:

- Scan status
- Scan settings
- Save completed
- Preview

Note that you can stop scanning by clicking the [Stop] button in the [ScanSnap Manager - Image scanning and file saving] dialog box.

For details about how to stop scanning, refer to ["Stopping the Scan" \(page 118\)](#).

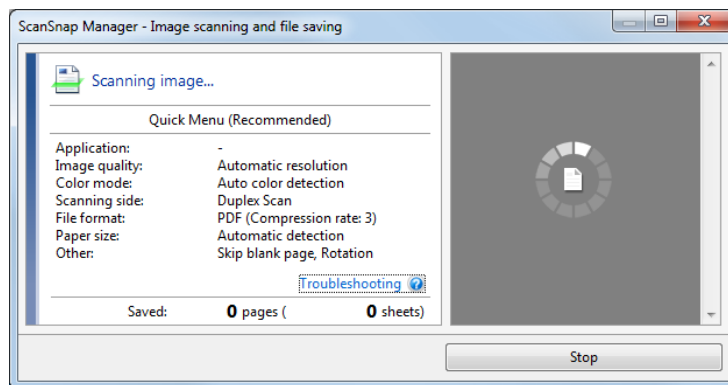

The [ScanSnap Manager - Image scanning and file saving] dialog box closes automatically after saving the scanned image of the last page scanned.

HINT

If the [Continue scanning after last page] check box is selected in the [Scanning] tab of the ScanSnap setup dialog box, you must click the [Finish Scanning] button, and then close the [ScanSnap Manager - Image scanning and file saving] dialog box.

Hiding the Scanning Progress Status

You can hide the [ScanSnap Manager - Image scanning and file saving] dialog box in the following procedure.

1. Select [Help] → [Preferences] from the Right-Click Menu.

For details about the Right-Click Menu, refer to "[Right-Click Menu \(Windows\)](#)" (page 37).

⇒ The [ScanSnap Manager - Preferences] dialog box appears.

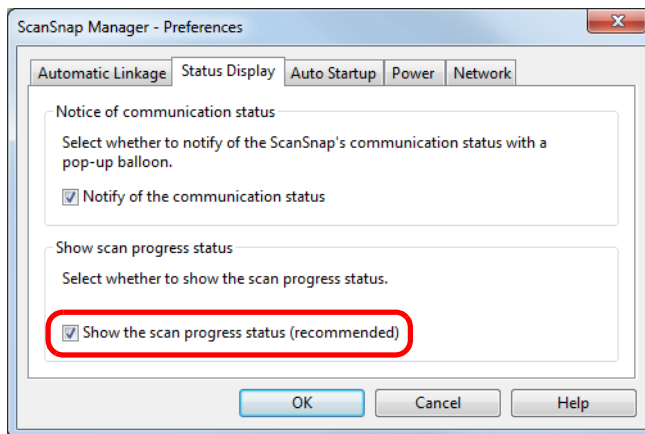

2. In the [Status Display] tab, clear the [Show the scan progress status (recommended)] check box.



3. Click the [OK] button to close the [ScanSnap Manager - Preferences] dialog box.

⇒ The [ScanSnap Manager - Image scanning and file saving] dialog box is hidden from next scanning on.

HINT

When the scanning progress status dialog box is hidden, the ScanSnap Manager icon in the notification area alternates between  and .

Using the ScanSnap (for Mac OS Users)

This chapter explains how to perform scanning and how to set the ScanSnap Manager in Mac OS.

Basic Scanning Operation Flow	286
Using ScanSnap with the Quick Menu	291
Profile	369
Creating Scanned Images Depending on Intended Use	381
Configuring ScanSnap Manager.....	421

Basic Scanning Operation Flow

This section explains how to perform scanning with the ScanSnap. The explanations in this section use an example in which the Quick Menu is used for the scanning operation flow. This flow is the basic scanning procedure.

Selecting a Profile Depending on the Document

There are profile buttons that you can use depending on the scan settings for the document. Scanned images with the optimum scan settings can be created by just selecting the profile button.

Profile Button	Description
[Recommended] button	Settings are [Automatic resolution] for [Image quality] in the [Scanning] tab in the ScanSnap setup window and default for other settings. It is recommended that you select this button when you want to scan documents in optimum quality suitable for the paper size of the document.
[Small File] button	Settings are [Normal] (Color/Gray: 150 dpi, B&W: 300 dpi) for [Image quality] in the [Scanning] tab in the ScanSnap setup window and default for other settings. It is recommended that you select this button when you want to reduce the file size.
[High Quality] button	Settings are [Best] (Color/Gray: 300 dpi, B&W: 600 dpi) for [Image quality] in the [Scanning] tab in the ScanSnap setup window and default for other settings. It is recommended that you select this button when you want to scan documents in high quality.
[Customize] button	Default settings are the same as the [Recommended] settings. Scan settings can be changed depending on your scanning purpose.

HINT

You cannot change the settings for the [Recommended], [Small File], and [High Quality] buttons. If you change any of these settings, the profile automatically switches to [Customize]. For details about how to change scan settings, refer to ["How to Configure Scan Settings" \(page 421\)](#).

Select a profile in the following procedure:

1. Turn on the ScanSnap.

For details, refer to ["Turning the ScanSnap ON/OFF" \(page 45\)](#).

⇒ Scanning becomes enabled.

2. Select [Settings] from the ScanSnap Manager menu.

For details about the ScanSnap Manager menu, refer to "[ScanSnap Manager Menu \(Mac OS\)](#)" (page 39).

⇒ The ScanSnap setup window appears.

3. Select the [Use Quick Menu] checkbox.

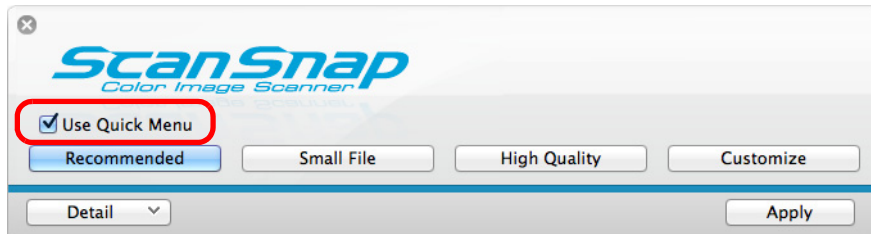

4. Click one of the profile buttons.

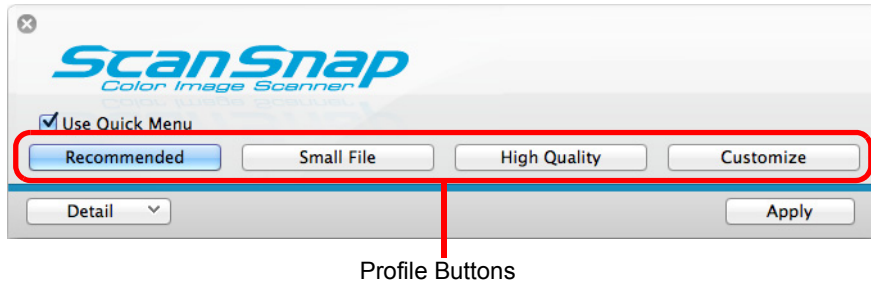

HINT

- The [Recommended] button is selected in default.
- For details about the default settings when using the Quick Menu, refer to the ScanSnap Manager Help.

5. Click the [Apply] button in the ScanSnap setup window.

6. Click the [X] button in the upper left corner to close the ScanSnap setup window.

Scanning

Scan a document in the following procedure:

1. Load a document in the ScanSnap.

For details, refer to ["How to Load Documents"](#) (page 63).

2. Press the [Scan] button on the ScanSnap to start a scan.

HINT

- The [Scan] button setting is [Duplex Scan (Double-sided)] in default. Note that you can switch the [Scan] button setting to [Simplex Scan (Single-sided)] in ScanSnap Manager. For details, refer to ["Scanning Only One Side of a Document"](#) (page 381).
- You can also start scanning from the ScanSnap Manager menu. For details, refer to ["ScanSnap Manager Menu \(Mac OS\)"](#) (page 39).

ATTENTION

- Do not connect or disconnect the ScanSnap and other USB devices during scanning.
- Do not close the ADF paper chute (cover) during scanning.
- Do not switch users during scanning.
- Do not allow the ScanSnap to enter into sleep mode during scanning.

⇒ The [Scan] button on the ScanSnap flashes in blue throughout the scan.
The [ScanSnap Manager - Image scanning and file saving] window appears.

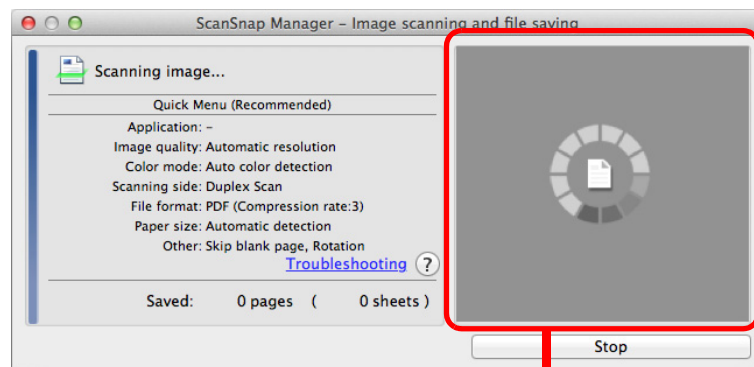

Preview

When you scan more than one document, the preview area will display the scanned images in thumbnails. Up to 150 thumbnails can be displayed.

HINT

Press the [Stop] button to stop scanning the document. For details, refer to ["Stopping the Scan"](#) (page 290).

⇒ The Quick Menu appears when the scanning is completed.

3. In the Quick Menu, click the icon of the application to link with ScanSnap Manager.

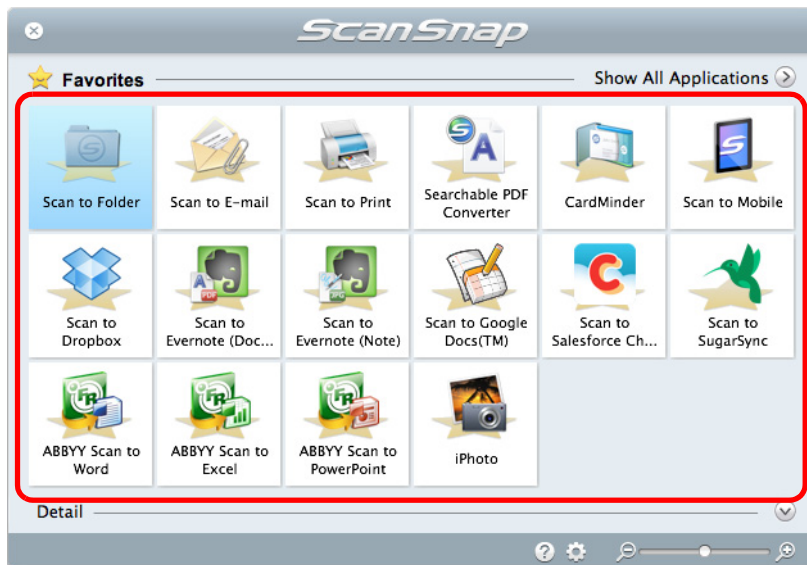

⇒ The selected application starts up.

For details about each application, refer to ["Using ScanSnap with the Quick Menu"](#) (page 291).

ATTENTION

- You cannot start scanning when the Quick Menu is displayed. Either select an icon from the Quick Menu and finish the process, or close the Quick Menu before you perform the next scan.
- Do not move, delete or rename the scanned image in other applications when the Quick Menu is displayed.

HINT

- The output image may slightly differ from the original document in size.
- When one of the below applications is active (application menu appears in the menu bar), scanning documents by pressing the [Scan] button on the ScanSnap automatically starts the linkage between ScanSnap Manager and the application.
 - CardMinder (linked only when the document is of business card size)
 - Scan to Mobile
 For details about automatic linkage, refer to ["Automatic Linkage with Applications"](#) (page 430).
- The Quick Menu display mode and icon display order can be changed. For details, refer to ["Quick Menu Settings"](#) (page 424).

Stopping the Scan

You can stop a scan in progress in case you are scanning a wrong document or the wrong side of a document.

Stop the scan in the following procedure:

1. Click the [Stop] button in the [ScanSnap Manager - Image scanning and file saving] window which appears during scanning.

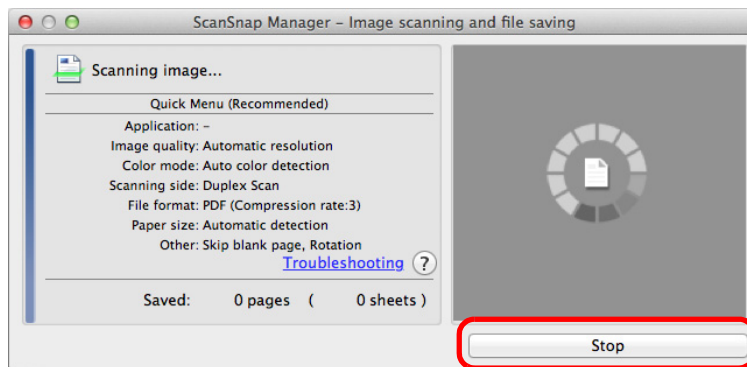

HINT

Remove all documents from the ScanSnap after stopping the scan. For details about how to remove documents, refer to "Troubleshooting" in the ScanSnap Manager Help.

⇒ The following window appears when the scanning stops.

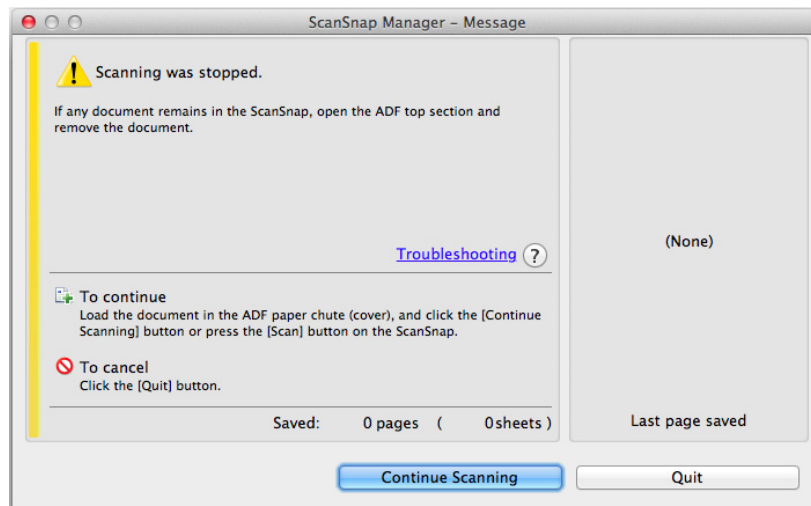

2. Click the [Quit] button.

To continue scanning, click the [Continue Scanning] button or press the [Scan] button on the ScanSnap after loading another document in the ScanSnap.

Using ScanSnap with the Quick Menu



The Quick Menu will allow you to start using the ScanSnap right away even if it is your first time.

Select an icon from the Quick Menu to perform the following desired operations:

- Using scanned images (→ [page 291](#))
- Linkage with applications (→ [page 292](#))
- Linkage with cloud services (→ [page 293](#))

Using Scanned Images

Share the scanned document files with others.



Scan to Folder

Save the scanned image directly in a shared folder on a network after scanning, share the scanned image with others and inform them of the destination folder path by an e-mail message automatically created with the path stated.

Send document files to participants of a meeting via e-mail.



Scan to E-mail

Send an e-mail message to others with the scanned image file attached.

Use a printer rather than a copy machine to make copies of documents.



Scan to Print

Print the scanned image with a printer.

Create a PDF file in which you can search for character strings.



Searchable PDF Converter

Convert scanned images into searchable PDF files while your computer is idle.

Save scanned documents to a mobile device.



Scan to Mobile

Save the scanned image to a mobile device connected to the computer. You can access the saved files through linkage with an application that can view PDF or JPEG files.

Linking with Applications

File and organize a large number of business cards.



CardMinder

Store and manage business cards in CardMinder.
Displayed when CardMinder is installed.

Quote text from your paper documents when you do not want to type it.



ABBYY Scan to Word,



ABBYY Scan to Excel(R),



ABBYY Scan

to PowerPoint(R)

Have the scanned image text recognized and converted into a Word, Excel, or PowerPoint document.

Displayed when ABBYY FineReader for ScanSnap (5.0 or later) is installed.

Convert catalogs and pamphlets into digital data and save them.



iPhoto

Save and manage scanned images of catalogs and pamphlets directly in iPhoto.
Displayed when iPhoto 5 or later is installed.

Linking with Cloud Services

Manage scanned documents through linkage with Dropbox.



Scan to Dropbox

Save scanned image files to your Dropbox folder.
Displayed when Dropbox for Mac 1.1.45 or later is installed.

Manage scanned documents through linkage with Evernote.



Scan to Evernote (Document)

Save PDF files in Evernote.
Displayed when Evernote for Mac 1.10 or later is installed.

Manage handwritten notes through linkage with Evernote.



Scan to Evernote (Note)

Save JPEG files in Evernote.
Displayed when Evernote for Mac 1.10 or later is installed.

Manage scanned documents through linkage with Google Docs.



Scan to Google Docs(TM)

Save PDF files in Google Docs.

Manage scanned documents through linkage with Salesforce Chatter.



Scan to Salesforce Chatter

Post scanned image files to Salesforce Chatter. You can use posted files with Salesforce CRM.

Manage scanned documents through linkage with SugarSync.



Scan to SugarSync

Save scanned image files to your SugarSync folder.

Displayed when SugarSync Manager for Mac 1.9.29 or later is installed.

The following are explanations on how to use the Quick Menu.

Saving Data in a Specified Folder

This section explains how to save the scanned image file in a specified folder. You can save the scanned image file in a shared folder on the network and share it with others. In addition, you can inform others of the destination folder path by an e-mail message automatically created with the path stated.

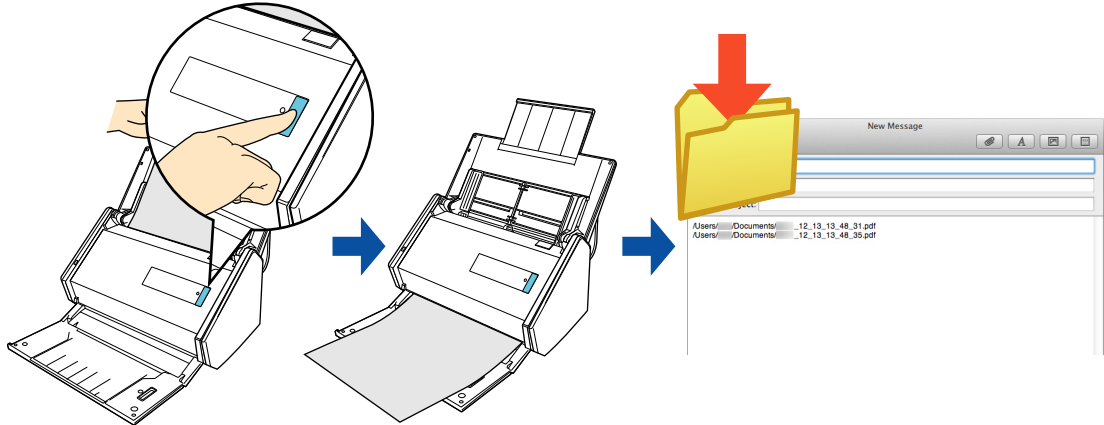

HINT

- The e-mail program configured in Mail when you select [Mail] menu → [Preferences] → [General] button → [Default email reader] is used as the e-mail program to link with ScanSnap Manager. The following e-mail programs are supported:
 - Mail
 - Outlook for Mac 2011
 - Entourage 2008 for Mac
 - Entourage 2004 for Mac
- By registering the scan and save settings as a profile, you can scan documents with the same profile at any time. For details, refer to "[Profile](#)" (page 369).

Procedures

HINT

To use the Quick Menu, you need to select the [Use Quick Menu] checkbox in the ScanSnap setup window.

For details about how to perform scanning by using the Quick Menu, refer to "[Basic Scanning Operation Flow](#)" (page 286).

1. Load a document in the ScanSnap.

For details, refer to "[How to Load Documents](#)" (page 63).

2. Press the [Scan] button on the ScanSnap to start a scan.

⇒ The Quick Menu appears when the scanning is completed.



3. Click the [Scan to Folder] icon .

⇒ The [Scan to Folder] window appears.

4. Check the scanned image in the preview area.

In the [Scan to Folder] window, you can change files names, destination folders, and specify whether to state a path to a destination folder in an e-mail message to notify others.

For details about the [Scan to Folder] window, refer to the ScanSnap Manager Help.

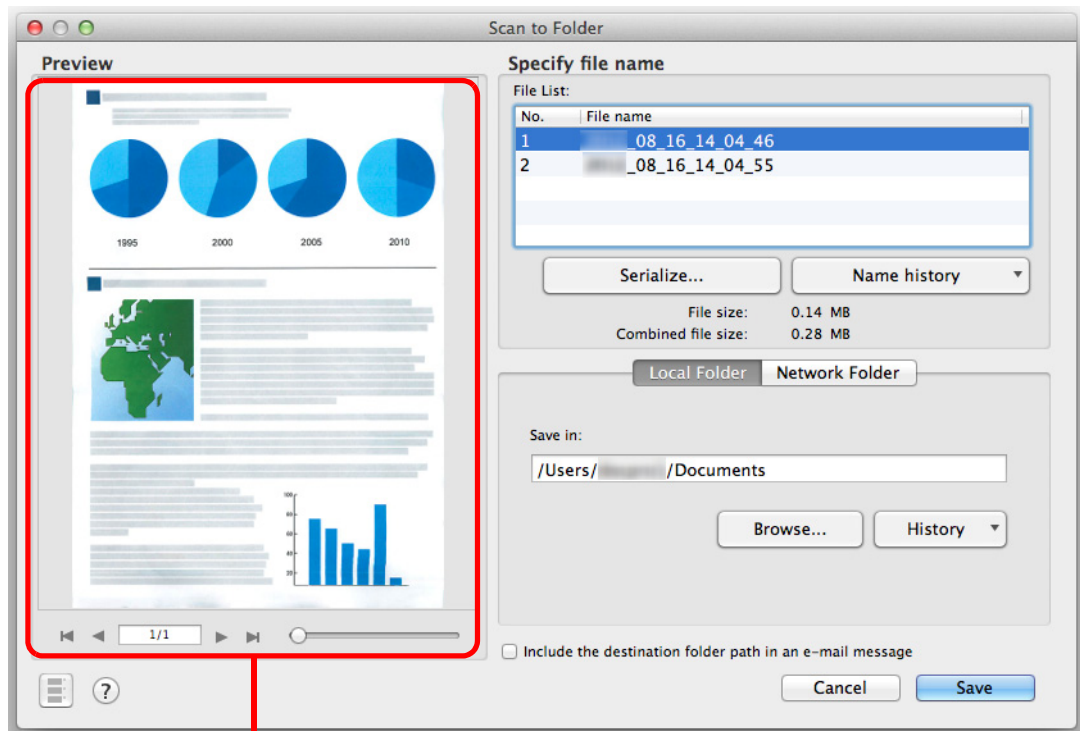

Preview

ATTENTION

- You cannot start scanning after the Quick Menu is displayed and before the [Scan to Folder] window is closed. Close the window before scanning the next document.
- Do not move, delete, or rename scanned image in other applications after the Quick Menu is displayed and before the [Scan to Folder] window is closed.

5. Click the [Save] button.

⇒ The scanned image file is saved in the specified folder.

HINT

When you select the [Include the destination folder path in an e-mail message] checkbox in the [Scan to Folder] window, a new message window appears listing the destination folder path where the file is saved.

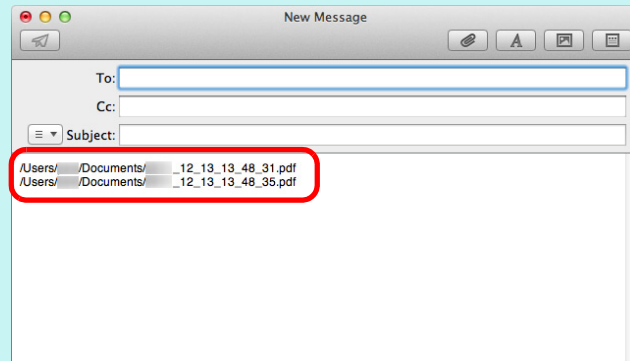

Attaching Files to E-Mail

This section explains how to attach the scanned image file to an e-mail message.

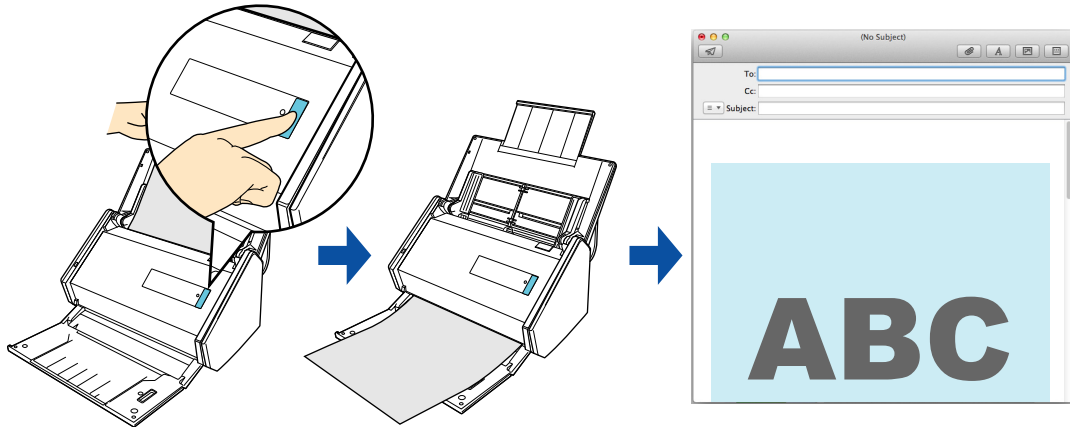

HINT

- The e-mail program configured in Mail when you select [Mail] menu → [Preferences] → [General] button → [Default email reader] is used as the e-mail program to link with ScanSnap Manager. The following e-mail programs are supported:
 - Mail
 - Outlook for Mac 2011
 - Entourage 2008 for Mac
 - Entourage 2004 for Mac
- By registering the scan and save settings as a profile, you can scan documents with the same profile at any time. For details, refer to "[Profile](#)" (page 369).

Procedures

HINT

To use the Quick Menu, you need to select the [Use Quick Menu] checkbox in the ScanSnap setup window.

For details about how to perform scanning by using the Quick Menu, refer to "[Basic Scanning Operation Flow](#)" (page 286).

1. Load a document in the ScanSnap.

For details, refer to "[How to Load Documents](#)" (page 63).

ATTENTION

Up to ten files can be attached to an e-mail message.

When you scan more than one document with the scan settings shown below, multiple files are created. Pay attention to the number of documents to scan:



- File format: JPEG (*.jpg)
- [Generate one PDF file per (n) page(s)] checkbox is selected

2. Press the [Scan] button on the ScanSnap to start a scan.

⇒ The Quick Menu appears when the scanning is completed.



To change the settings for [Scan to E-mail], move the mouse cursor to the [Scan to E-

mail] icon , and then click . For details about how to change the settings, "[Preferences](#)" (page 303).

3. Click the [Scan to E-mail] icon .

⇒ The [Scan to E-mail] window appears.

HINT

You can configure the settings to not show the [Scan to E-mail] window. If you configure the settings to not show the [Scan to E-mail] window, a new message window appears with the file attached. For details about how to change the settings, refer to "Preferences" (page 303).

4. Check the scanned image in the preview area.

In the [Scan to E-mail] window, you can rename the file and decide whether to save the scanned image in the folder specified for [Image saving folder] after sending it by e-mail. For details about the [Scan to E-mail] window, refer to the ScanSnap Manager Help.

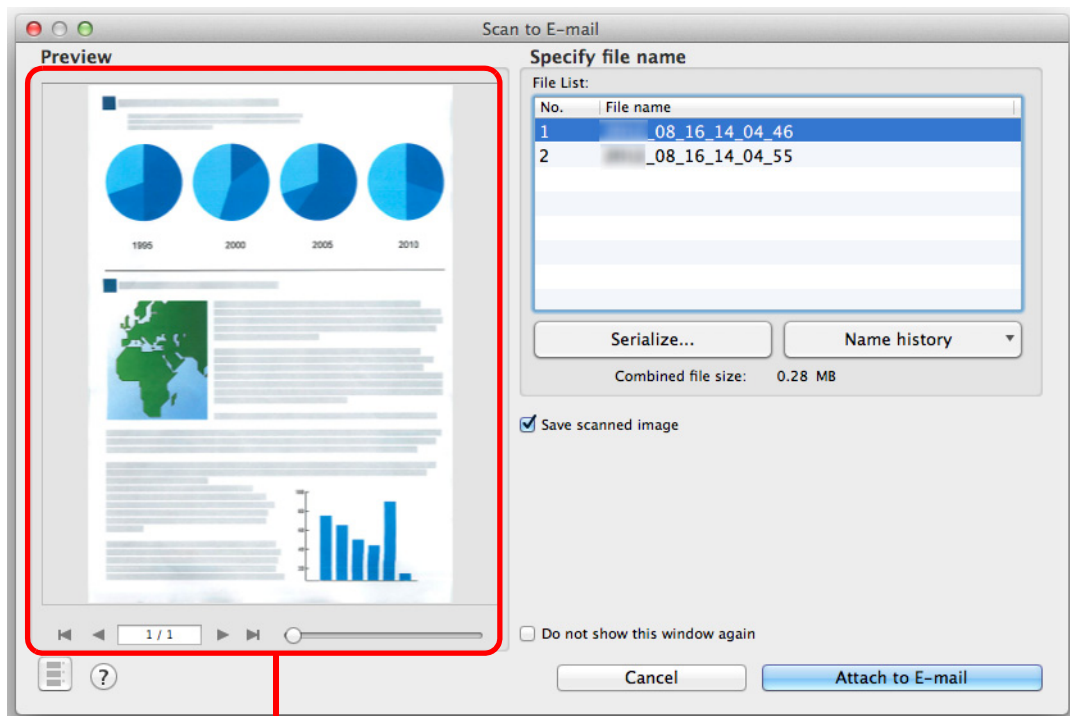

Preview

ATTENTION

- You cannot start scanning after the Quick Menu is displayed and before the [Scan to E-mail] window is closed. Close the [Scan to E-mail] window before scanning the next document.
- Do not move, delete, or rename scanned image in other applications after the Quick Menu is displayed and before the [Scan to E-mail] window is closed.

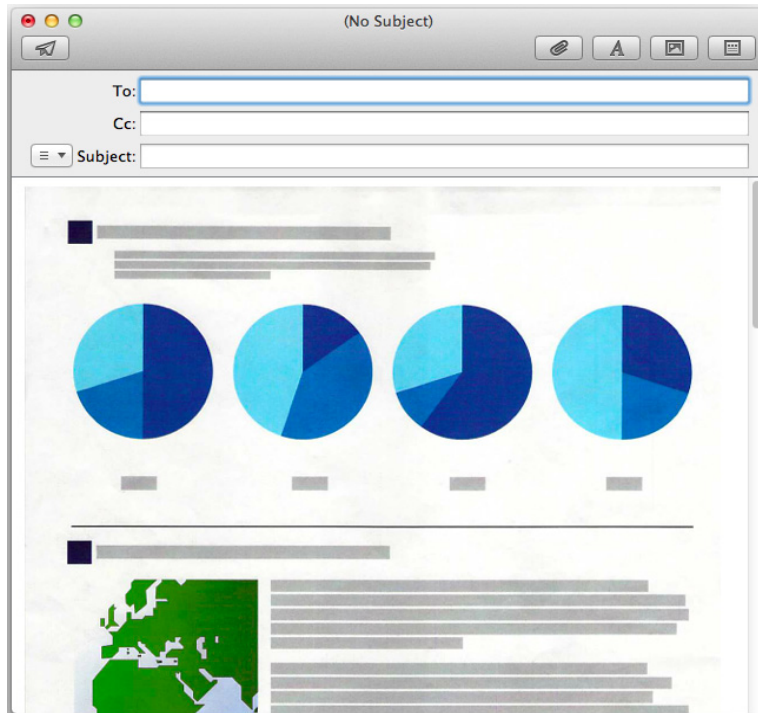

5. Click the [Attach to E-mail] button.

⇒ An e-mail message window appears with the file attached.



Preferences

You can configure the settings in order to link with [Scan to E-mail].

1. Move the mouse cursor to the [Scan to E-mail] icon  , and then click .

⇒ The [Scan to E-mail - Options] window appears.

2. Change the setting.

For details about the [Scan to E-mail - Options] window, refer to the ScanSnap Manager Help.

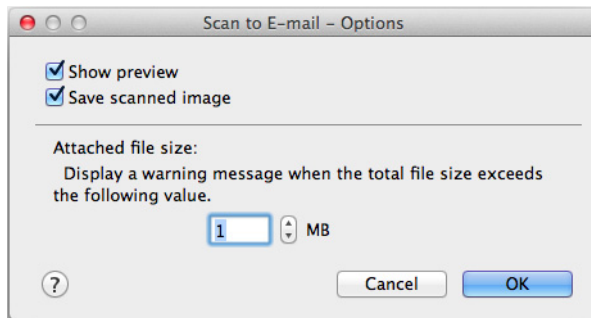

3. Click the [OK] button to close the [Scan to E-mail - Options] window.

Using the ScanSnap as a Copy Machine

This section explains how to print the scanned image with a printer.

When a printer links with ScanSnap Manager, the ScanSnap can be used as a copy machine.

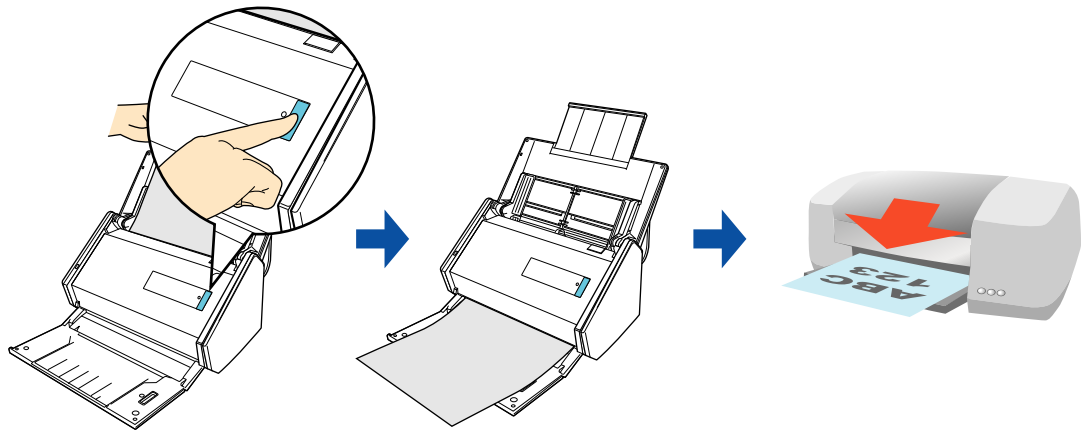

ATTENTION

Note that shadows around the edges of the document may appear as lines on the generated scanned image, depending on the scanning method and paper conditions. If you print such an image, the printed image will also have lines appearing in it.

HINT

By registering the scan and save settings as a profile, you can scan documents with the same profile at any time. For details, refer to "[Profile](#)" (page 369).

Procedures

HINT

To use the Quick Menu, you need to select the [Use Quick Menu] checkbox in the ScanSnap setup window.

For details about how to perform scanning by using the Quick Menu, refer to "[Basic Scanning Operation Flow](#)" (page 286).

1. Load a document in the ScanSnap.



For details, refer to "[How to Load Documents](#)" (page 63).

2. Press the [Scan] button on the ScanSnap to start a scan.

⇒ The Quick Menu appears when the scanning is completed.



To change the settings for [Scan to Print], move the mouse cursor to the [Scan to Print]

icon , and then click . For details about how to change the settings, "[Preferences](#)" (page 307).

3. Click the [Scan to Print] icon .

⇒ The [Print] window appears.

4. Configure print setup options in the [Print] window.

In the [Print] window, you can specify the printer to be used, the number of copies, and size and position of the scanned image to be printed, and whether to save the scanned image in the folder specified for [Image saving folder].

For details about the [Print] window, refer to the ScanSnap Manager Help.

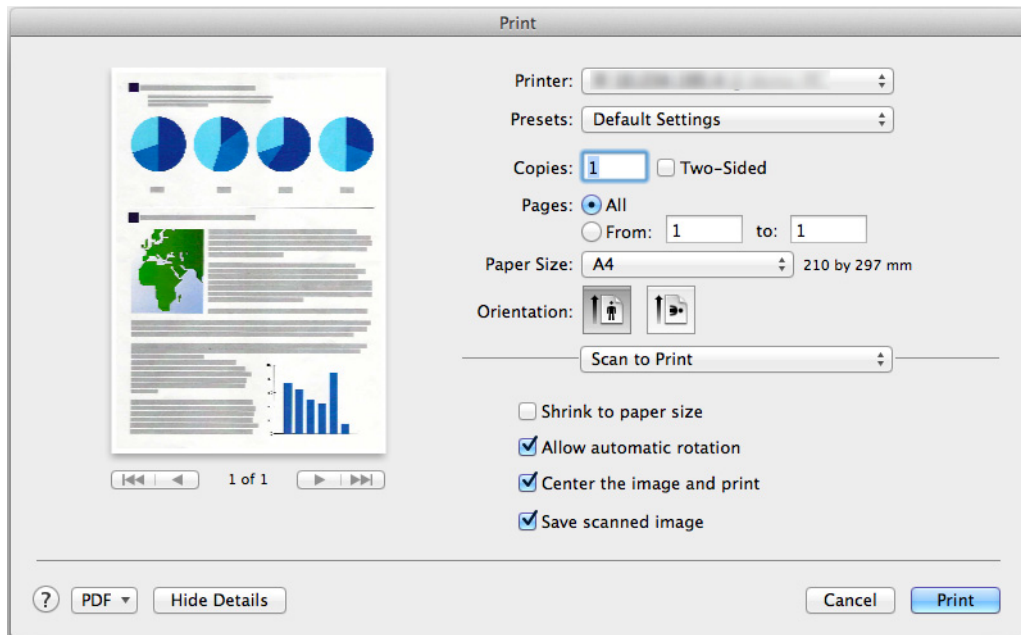

ATTENTION



- You cannot start scanning after the Quick Menu is displayed and before the [Print] window is closed. Close the [Print] window before scanning the next document.
- Do not move, delete, or rename the scanned image in other applications after the Quick Menu is displayed and before the [Print] window is closed.

5. Click the [Print] button.

⇒ The scanned image is printed.

Preferences

You can configure the settings in order to link with [Scan to Print].

1. Move the mouse cursor to the [Scan to Print] icon , and then click .

⇒ The [Scan to Print - Options] window appears.

2. Change the settings.

For details about the [Scan to Print - Options] window, refer to the ScanSnap Manager Help.

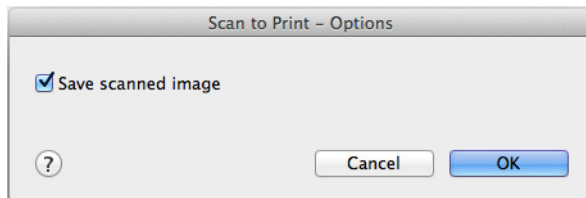

3. Click the [OK] button to close the [Scan to Print - Options] window.

Creating Searchable PDF Files

This section describes how to create searchable PDF files.

The process can be performed when your computer is idle, which allows you to efficiently create multiple searchable PDF files.

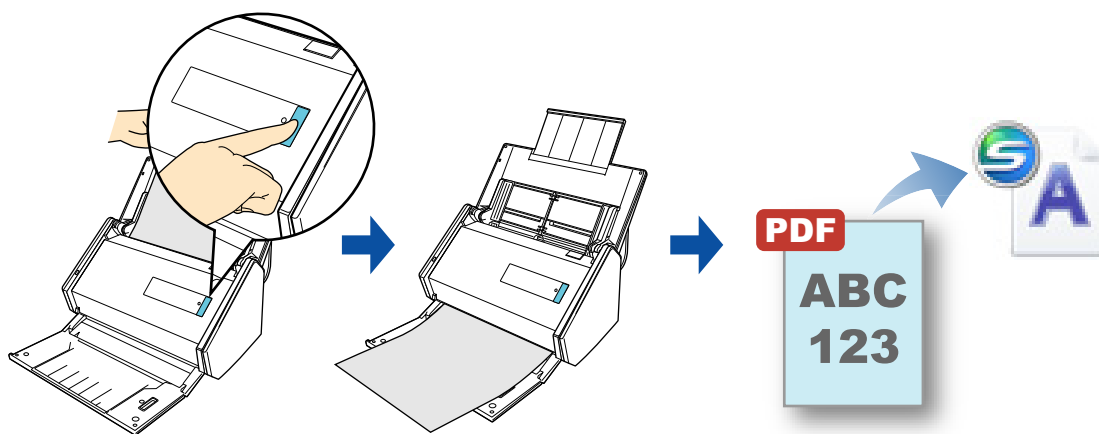

ATTENTION

- The following types of documents (characters) may not be converted into PDF file correctly. Such documents may be successfully converted into PDF file if scanned in color mode or at higher resolution.
 - All languages
 - Documents including handwritten characters
 - Documents with small characters scanned at a low resolution
 - Skewed documents
 - Documents written in languages other than the specified language
Japanese, Chinese (simplified / traditional), Korean
 - Documents including texts written in Italic characters
 - Documents containing characters with superscripts/subscripts and complicated mathematical expressions
 - Documents with characters on unevenly colored or patterned background
 - Decorated characters (embossed/outlined)
 - Shaded characters
 - Documents of complex layout and hard-to-scan documents due to print-through or smudges (The conversion of such a document may take long time.)
 - If bleed-through reduction is enabled, the recognition rate may be lowered. In that case, disable it in the following procedure.
Select [Settings] → [Scanning] tab → [Option] button from the ScanSnap Manager menu to show the [Scanning mode option] window. Clear the [Reduce bleed-through] checkbox.
 - Vertical text can be searched with Adobe Acrobat, but not with Spotlight or Preview.

HINT

- When you first launch [Searchable PDF Converter], a message appears. When [Searchable PDF Converter] is running, an icon is displayed on the status menu of the menu bar. For details, refer to ["Before Using \[Searchable PDF Converter\]"](#) (page 309).
- Scanned images that have been created by the ScanSnap can be converted to searchable PDF files. For details, refer to ["Converting Existing PDF Files Created by the ScanSnap to Searchable PDF Files"](#) (page 313).
- When linking with other applications, you can also create searchable PDF files by configuring scan settings. For details, refer to ["Creating Searchable PDF Files"](#) (page 410).
- By registering the scan and save settings as a profile, you can scan documents with the same profile at any time. For details, refer to ["Profile"](#) (page 369).

Before Using [Searchable PDF Converter]**First launch**

The following message appears when you first launch [Searchable PDF Converter]. Click the [OK] button to open the [Searchable PDF Converter - Initial Settings] window.

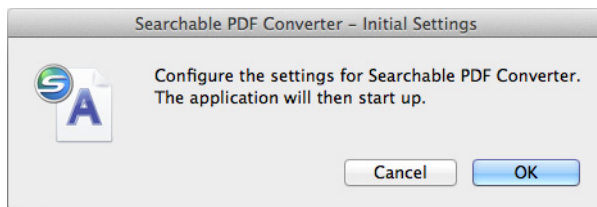



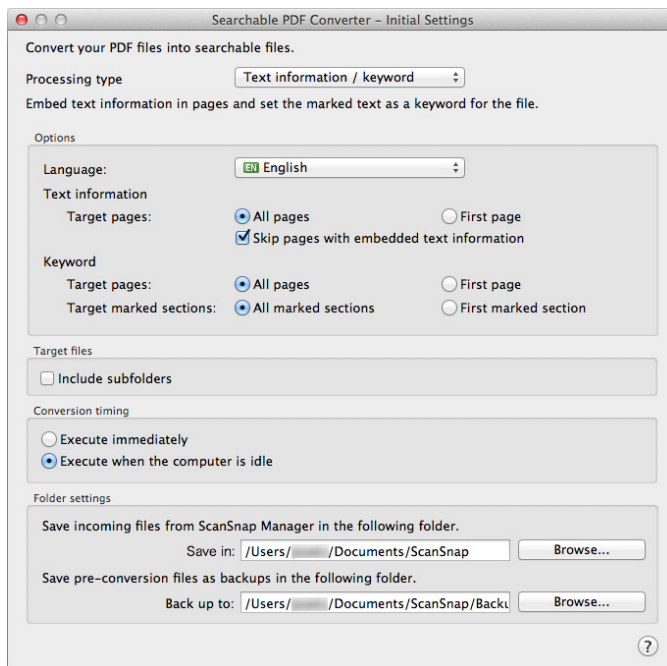





You can use the [Searchable PDF Converter - Initial Settings] window to specify the options, conversion timing, and folder settings for when a searchable PDF file is created.





[Searchable PDF Converter] icon

While [Searchable PDF Converter] is running, the [Searchable PDF Converter] icon is displayed on the status menu of the menu bar.

The [Searchable PDF Converter] icon indicates the processing status when converting to a PDF file. The appearance of the icon changes according to the processing status as shown below.

Status		[Searchable PDF Converter] icon
Standby	No file to convert/No error	
	There is a file to convert /No error	
	No file to convert/Error	
	There is a file to convert/Error	
Pause	No file to convert/No error	
	There is a file to convert/No error	
	No file to convert/Error	
	There is a file to convert/Error	

The [There is a file to convert / No error] standby icon  or [There is a file to convert / Error] standby icon  is displayed with animated images during the conversion process.

Procedures

HINT

To use the Quick Menu, you need to select the [Use Quick Menu] checkbox in the ScanSnap setup window.

For details about how to perform scanning by using the Quick Menu, refer to "[Basic Scanning Operation Flow](#)" (page 286).

1. Load a document in the ScanSnap.



For details, refer to "[How to Load Documents](#)" (page 63).

2. Press the [Scan] button on the ScanSnap to start a scan.

⇒ The Quick Menu appears when the scanning is completed.



To change the settings for [Searchable PDF Converter], move the mouse cursor to the

[Searchable PDF Converter] icon , and then click . For details about how to change the settings, "[Preferences](#)" (page 315).

ATTENTION

- You cannot start scanning when the Quick Menu is displayed. Wait until the scanned image file is added to the [Searchable PDF Converter - PDF Conversion List] window before you scan another document.
- Do not move, delete or rename the scanned image in other applications when the Quick Menu is displayed.

Converting Existing PDF Files Created by the ScanSnap to Searchable PDF Files

ATTENTION

- The following PDF files cannot be converted to searchable PDF files.
 - PDF files not scanned with the ScanSnap
 - PDF files, including those scanned with the ScanSnap, which are protected by security options such as passwords or containing digital signatures
 - PDF files with version lower than 1.3
 - PDF files of 1 GB or larger
 - PDF files over 1,001 pages
- Information such as comments added after scanning may be lost if the searchable PDF conversion is executed.
- The pre-converted PDF files are saved in the folder specified for [Back up to] in the [Searchable PDF Converter - Settings] window if the searchable PDF file conversion is executed.
Confirm that the PDF file has been converted into the searchable PDF file successfully before deleting the pre-converted PDF file.
- When a file is converted into a searchable PDF file, the owner of the converted PDF file and the backup PDF file may be changed to the user who converted the file.
- When converting a file, textual information is embedded and keywords are added to the PDF file. Therefore, the PDF file will be updated.
- If the [Searchable PDF Converter - PDF Conversion List] window is at the front of the screen, the conversion process starts even if the computer is not idle.
- If a PDF file that complies with PDF/A standard is converted, it will no longer comply with the PDF/A standard.

1. From the sidebar in Finder, select [Applications] → [ScanSnap], and then double-click [Searchable PDF Converter].

⇒ The [Searchable PDF Converter - PDF Conversion List] window appears.

2. Click the Searchable PDF Converter icon  in the status menu of the menu bar.

⇒ The Searchable PDF Converter menu appears.

3. Click the [Open] button in the displayed menu.



⇒ The [Open] window appears.

4. Select the PDF file you want to convert into the searchable PDF file, and click the [Open] button.

⇒ The selected files are displayed in the [Searchable PDF Converter - PDF Conversion List], and conversion starts.

Preferences

You can configure the settings in order to link with [Searchable PDF Converter].

1. Move the mouse cursor to the [Searchable PDF Converter] icon , and then click .

⇒ The [Searchable PDF Converter - Settings] window is displayed.

HINT

The [Searchable PDF Converter - Settings] window can also be displayed by clicking the [Searchable PDF Converter] icon  on the status menu of the menu bar, and then selecting [Settings].

2. Change the settings.

For details about the [Searchable PDF Converter - Settings] window, refer to the ScanSnap Manager Help.

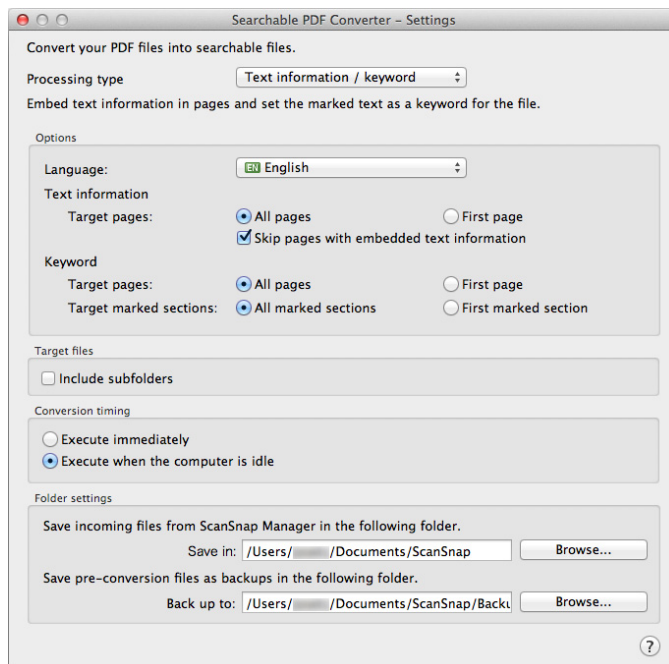

3. Click the [ⓧ] button to close the [Searchable PDF Converter - Settings] window.

Storing Business Cards in CardMinder

This section explains how to store business card images and the related information in CardMinder.

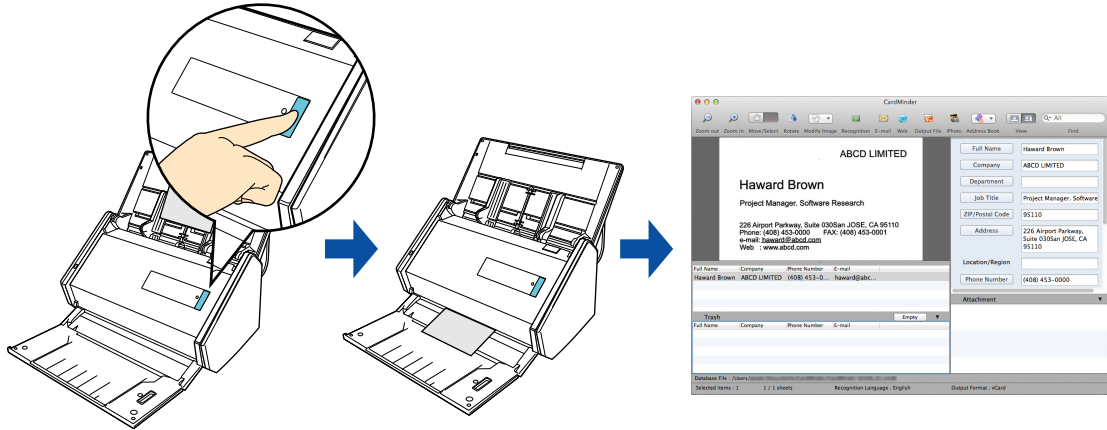

ATTENTION

Blank pages are not removed even if the [Blank page removal] is selected when you store scanned images of business cards in CardMinder.

HINT

- By registering the scan and save settings as a profile, you can scan documents with the same profile at any time. For details, refer to ["Profile"](#) (page 369).
- ScanSnap Manager can automatically link with CardMinder. For details, refer to ["Automatic Linkage with Applications"](#) (page 430)

Procedures

HINT

To use the Quick Menu, you need to select the [Use Quick Menu] checkbox in the ScanSnap setup window.

For details about how to perform scanning by using the Quick Menu, refer to "[Basic Scanning Operation Flow](#)" (page 286).

1. Load a business card in the ScanSnap.

- Load the business card so that the front side faces the ADF paper chute (cover).
- To scan multiple business cards, load them in a pile.
- Do not leave space between the side guides and business cards.

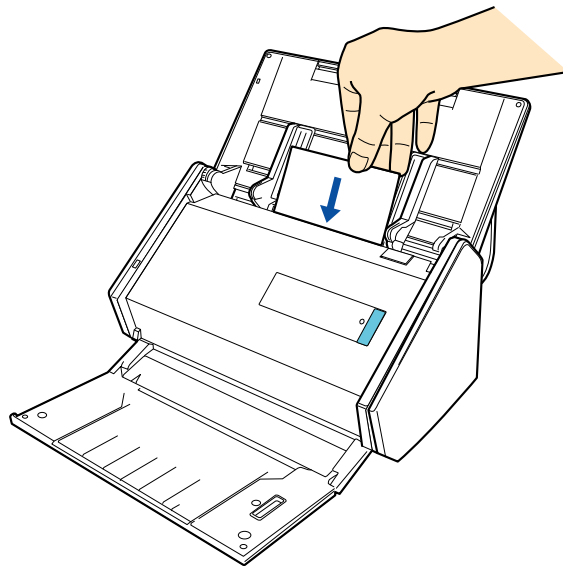

2. Press the [Scan] button on the ScanSnap to start a scan.

HINT

It is recommended that you select [Automatic resolution] or [Best] for [Image quality] in the [Scanning] tab of the ScanSnap setup window. ScanSnap Manager cannot link with CardMinder when [Image quality] is set to [Excellent].

⇒ The Quick Menu appears when the scanning is completed.



ATTENTION

- You cannot start scanning when the Quick Menu is displayed. Wait until ScanSnap Manager links with CardMinder before scanning another document.
- Do not move, delete or rename the scanned image in other applications when the Quick Menu is displayed.

3. Click the [CardMinder] icon .

⇒ CardMinder starts up and the [CardMinder] window appears.

4. Check the scanned card image and the text recognition result.

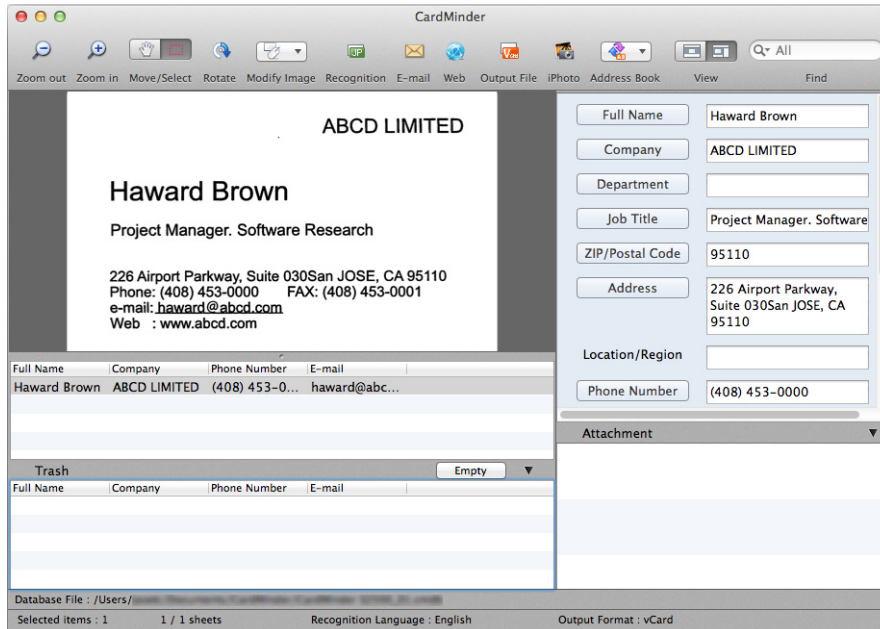

HINT

For details about the functions of CardMinder and how to use it, refer to the CardMinder User's Guide and CardMinder Help.

Saving Data to a Mobile Device

This section explains how to save the scanned image as a PDF or a JPEG file to a mobile device.

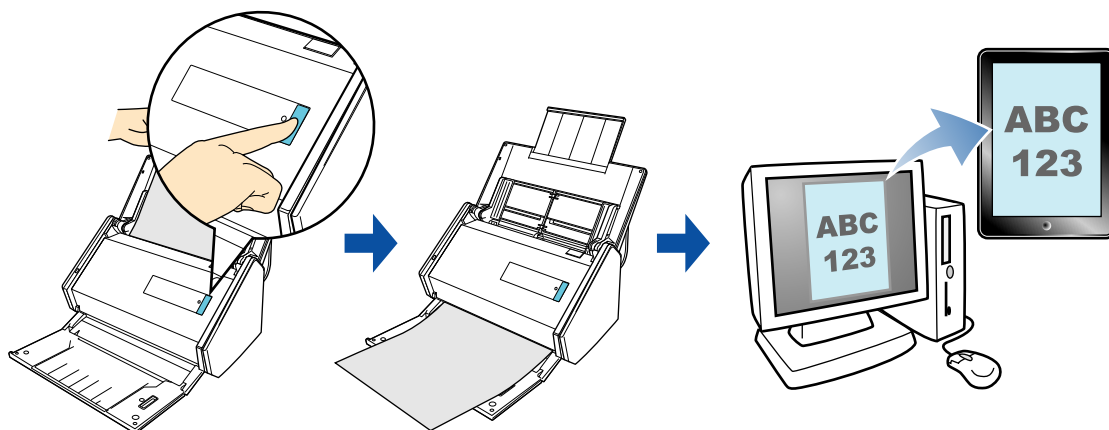

ATTENTION

- Only one mobile device can be connected to the computer.
- You need to have ScanSnap Connect Application installed in the mobile device in order to use this function. Download ScanSnap Connect Application for the mobile device from an application store such as iTunes, the App Store or Google Play.
For information about the operating system that ScanSnap Connect Application supports, please visit the following web page:
<http://scansnap.fujitsu.com/g-support/en/>
- The number of scanned image files and the maximum file size that can be saved on a mobile device at once are as follows:
 - Number of files: Up to 100
 - File size: 1024 MB

HINT

- By connecting the ScanSnap and a mobile device via wireless LAN, you can save scanned images to the mobile device without passing through a computer. For details about how to configure settings, refer to "[Connecting the ScanSnap to a Wireless LAN](#)" (page 50).
- When you first launch [Scan to Mobile], a message appears. When [Scan to Mobile] is running, an icon is displayed on the status bar of the menu bar. For details, refer to "[Before Using \[Scan to Mobile\]](#)" (page 321).
- You can also save existing files to a mobile device. For details, refer to "[Saving an Existing File to a Mobile Device](#)" (page 329).
- By registering the scan and save settings as a profile, you can scan documents with the same profile at any time. For details, refer to "[Profile](#)" (page 369).

This section describes the basic procedures and the procedures for automatic linkage with applications.

- Procedures (→ [page 323](#))
- Automatic Linkage (→ [page 326](#))

Before Using [Scan to Mobile]

First launch

- A firewall alert may be displayed. When the alert is displayed, allow access to proceed.
- The following message appears. Click the [OK] button to open the [Scan to Mobile - Basic] window.



In the [Scan to Mobile - Basic] window, enter a password to connect to the mobile device.



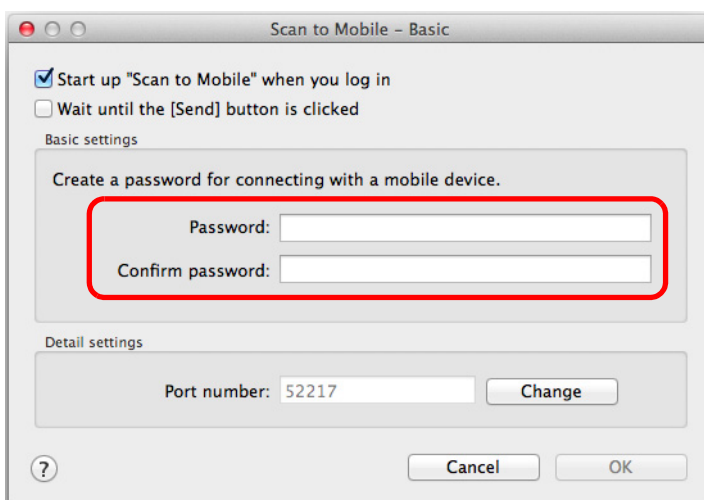

For details about other setting items, refer to the ScanSnap Manager Help.



[Scan to Mobile] icon

When [Scan to Mobile] is running, the [Scan to Mobile] icon is displayed on the status menu of the menu bar.

The [Scan to Mobile] icon shows the communication status between the computer and the mobile device. The appearance of the icon changes according to the communication status as shown below.

Status	[Scan to Mobile] icon
Waiting	
Standby	
Sending	
Sending error	
Rejected	

Procedures

HINT

To use the Quick Menu, you need to select the [Use Quick Menu] checkbox in the ScanSnap setup window.

For details about how to perform scanning by using the Quick Menu, refer to "[Basic Scanning Operation Flow](#)" (page 286).

1. Load a document in the ScanSnap.



For details, refer to "[How to Load Documents](#)" (page 63).

2. Press the [Scan] button on the ScanSnap to start a scan.

⇒ The Quick Menu appears when the scanning is completed.



To change the settings for [Scan to Mobile], move the mouse cursor to the [Scan to

Mobile] icon , and then click . For details about how to change the settings, "[Preferences](#)" (page 332).

ATTENTION

- When [Scan to Mobile] has already started and is active (with the Scan to Mobile menu appearing in the menu bar), ScanSnap Manager links with [Scan to Mobile] automatically and the Quick Menu does not appear.
To display the Quick Menu, change the menu bar menu to an application other than Scan to Mobile, and then try scanning again.
- You cannot start scanning when the Quick Menu is displayed. Wait until ScanSnap Manager links with [Scan to Mobile] before scanning another document.
- Do not move, delete or rename the scanned image in other applications when the Quick Menu is displayed.

3. Click the [Scan to Mobile] icon .

⇒ The [Scan to Mobile] window appears.

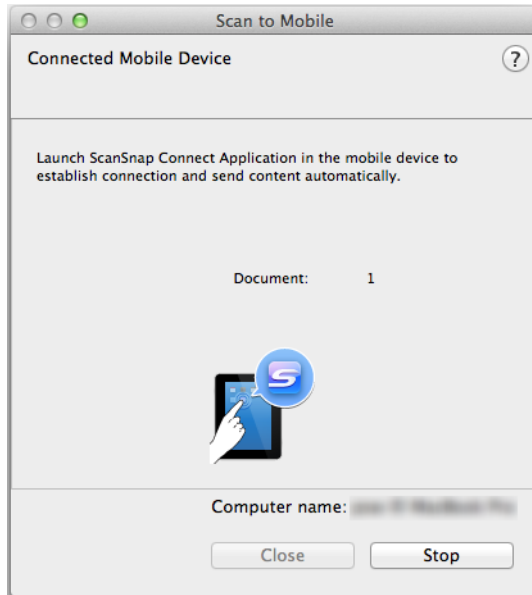

4. Connect to the computer from your mobile device.

For details about how to connect to the computer from your mobile device, refer to the ScanSnap Connect Application User's Guide for your mobile device.

⇒ When the connection is established, the [Scan to Mobile] window appears showing the mobile device that is currently connected to the computer. Then, the scanned image is sent to the mobile device.

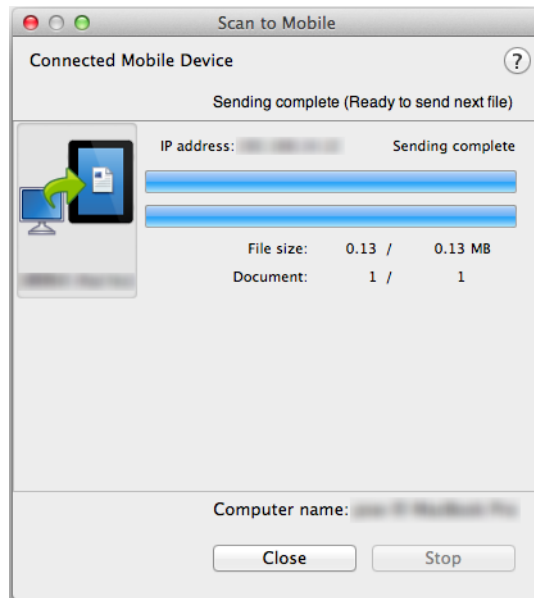

HINT

- When you select the [Wait until the [Send] button is clicked] checkbox in the [Scan to Mobile - Basic] window, the [Send] button appears in the [Scan to Mobile] window. Click the [Send] button to send the image to the mobile device.
- For details about the features of ScanSnap Connect Application for mobile devices and how to use it, refer to the ScanSnap Connect Application User's Guide for your mobile device.

5. Click the [Close] button to close the [Scan to Mobile] window when sending of the scanned image is completed.

HINT

The [Scan to Mobile] window closes automatically when the mobile device is disconnected from the computer.

Automatic Linkage

HINT

- For details about the features of ScanSnap Connect Application for mobile devices and how to use it, refer to the ScanSnap Connect Application User's Guide for your mobile device.
- For details about automatic linkage to active applications, refer to "[Automatic Linkage with Applications](#)" (page 430).

1. From the sidebar in Finder, select [Applications] → [ScanSnap], and double-click [Scan to Mobile].

⇒ The [Scan to Mobile] window appears.

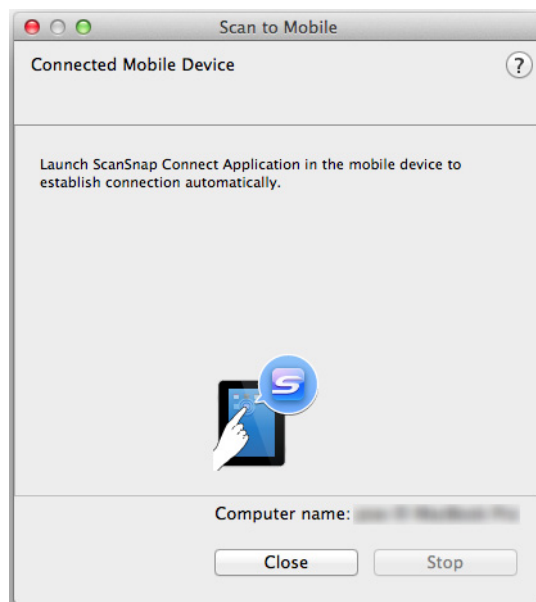

2. Connect to the computer from your mobile device.

For details about how to connect to the computer from your mobile device, refer to the ScanSnap Connect Application User's Guide for your mobile device.

⇒ When the connection is established, the [Scan to Mobile] window appears on the computer, showing the mobile device that is currently connected to the computer.

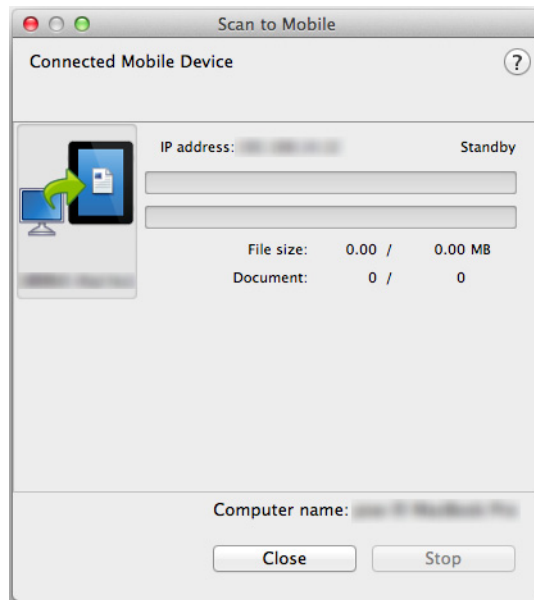

3. Load a document in the ScanSnap.

For details, refer to ["How to Load Documents" \(page 63\)](#).

4. Press the [Scan] button on the ScanSnap to start a scan.

ATTENTION

To enable automatic linkage with [Scan to Mobile], press the [Scan] button on the ScanSnap and start a scan while [Scan to Mobile] is active (the Scan to Mobile menu appears on the menu bar).

⇒ Scanned images will be sent to the mobile device from the computer when the scanning is completed.

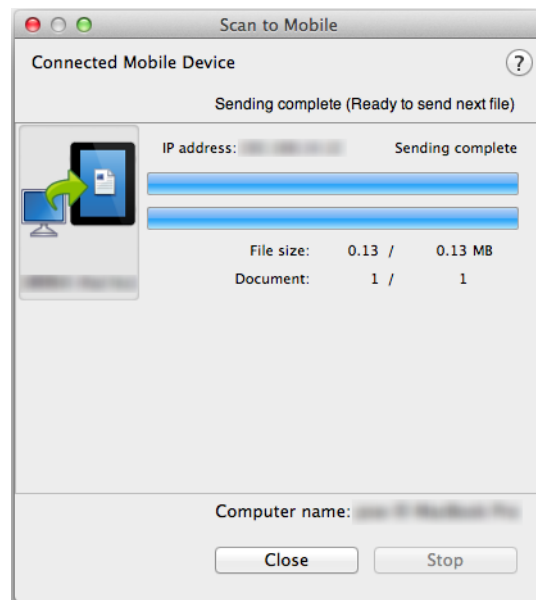

HINT

When you select the [Wait until the [Send] button is clicked] checkbox in the [Scan to Mobile - Basic] window, the [Send] button appears in the [Scan to Mobile] window. Click the [Send] button to send the image to the mobile device.

5. Click the [Close] button to close the [Scan to Mobile] window when sending of the scanned image is completed.

HINT

The [Scan to Mobile] window closes automatically when the mobile device is disconnected from the computer.

Saving an Existing File to a Mobile Device

HINT

For details about the features of ScanSnap Connect Application for mobile devices and how to use it, refer to the ScanSnap Connect Application User's Guide for your mobile device.

1. From the sidebar in Finder, select [Applications] → [ScanSnap], and double-click [Scan to Mobile].

⇒ The [Scan to Mobile] window appears.

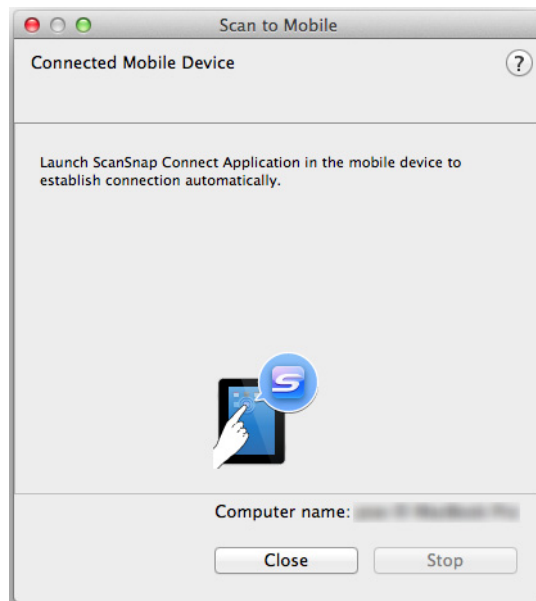

2. Connect to the computer from your mobile device.

For details about how to connect to the computer from your mobile device, refer to the ScanSnap Connect Application User's Guide for your mobile device.

⇒ When the connection is established, the [Scan to Mobile] window appears showing the mobile device that is currently connected to the computer.

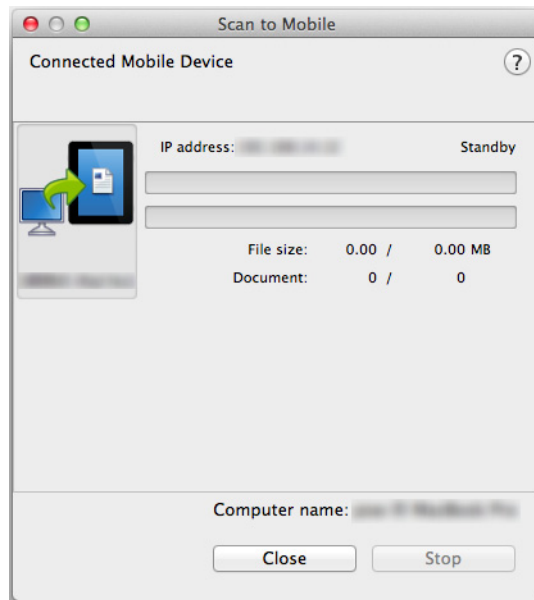

3. From the application menu in the menu bar, select [File] → [Open].

⇒ The [Open] window appears.

4. Select a PDF or JPEG file to save to the mobile device, and click the [Open] button.

⇒ The file is sent to the mobile device from the computer.

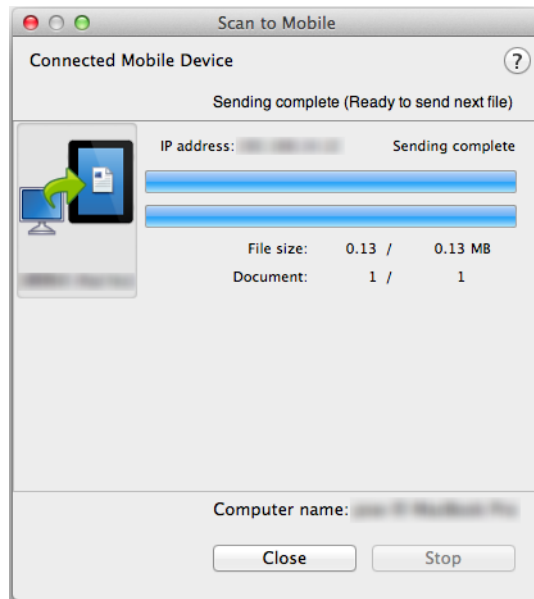

HINT

When you select the [Wait until the [Send] button is clicked] checkbox in the [Scan to Mobile - Basic] window, the [Send] button appears in the [Scan to Mobile] window. Click the [Send] button to send the image to the mobile device.



5. Click the [Close] button to close the [Scan to Mobile] window when sending of the scanned image is completed.

HINT

The [Scan to Mobile] window closes automatically when the mobile device is disconnected from the computer.

Preferences

You can configure the settings in order to link with [Scan to Mobile].

1. Move the mouse cursor to the [Scan to Mobile] icon , and then click .

⇒ The [Scan to Mobile - Options] window appears.

2. Change the settings.

For details about the [Scan to Mobile - Options] window, refer to the ScanSnap Manager Help.

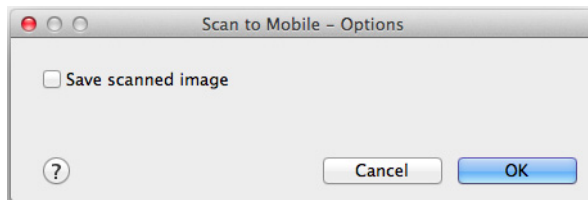

3. Click the [OK] button to close the [Scan to Mobile - Options] window.

Saving Data to Your Dropbox Folder

This section explains how to save the scanned image as a PDF or a JPEG file to your Dropbox folder.

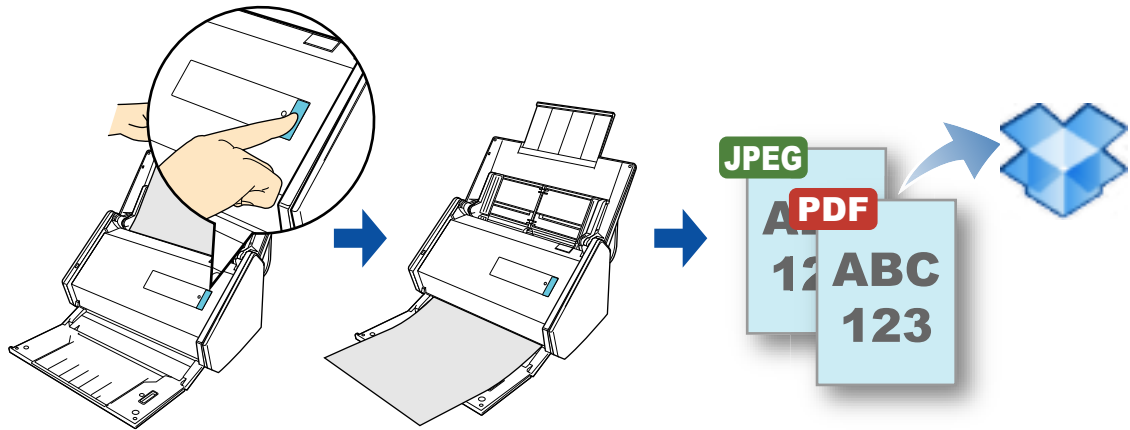

ATTENTION

- You need to have a Dropbox account.
- You need to have Dropbox for Mac 1.1.45 or later installed in order to use this function.

HINT

- When you first log into Dropbox after installing Dropbox for Mac, the Dropbox folder, which is the sync folder used for Dropbox, is automatically created.
- By registering the scan and save settings as a profile, you can scan documents with the same profile at any time. For details, refer to ["Profile" \(page 369\)](#).

Procedures

HINT

To use the Quick Menu, you need to select the [Use Quick Menu] checkbox in the ScanSnap setup window.

For details about how to perform scanning by using the Quick Menu, refer to "[Basic Scanning Operation Flow](#)" (page 286).

1. Load a document in the ScanSnap.



For details, refer to "[How to Load Documents](#)" (page 63).

2. Press the [Scan] button on the ScanSnap to start a scan.

⇒ The Quick Menu appears when the scanning is completed.



To change the settings for [Scan to Dropbox], move the mouse cursor to the [Scan to

Dropbox] icon , and then click . For details about how to change the settings, "[Preferences](#)" (page 336).

3. Click the [Scan to Dropbox] icon .

⇒ The [Scan to Dropbox] window appears.

HINT

You can configure the settings to not show the [Scan to Dropbox] window. If you configure the settings to not show the [Scan to Dropbox] window, scanned images are saved directly to the Dropbox folder.

For details about how to change the settings, "[Preferences](#)" (page 336).

4. Check the scanned image in the preview area.

In the [Scan to Dropbox] window, you can rename the file and specify your Dropbox folder.

For details about the [Scan to Dropbox] window, refer to the ScanSnap Manager Help.

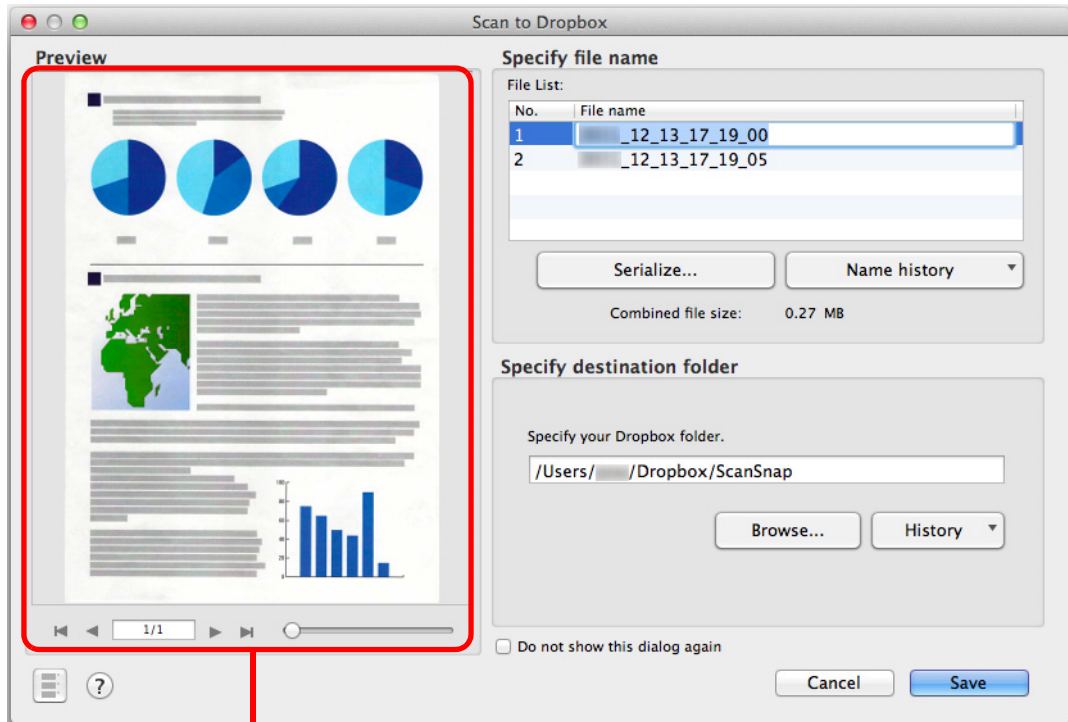

Preview

ATTENTION



- The file will not be synced with Dropbox unless you select the Dropbox folder as the destination folder.
- You cannot start scanning after the Quick Menu is displayed and before the [Scan to Dropbox] window is closed. Close the [Scan to Dropbox] window before scanning the next document.
- Do not move, delete or rename the scanned image in other applications after the Quick Menu is displayed and before the [Scan to Dropbox] window is closed.

5. Click the [Save] button.

⇒ The scanned image is saved to your Dropbox folder.

Preferences

You can configure the settings in order to link with [Scan to Dropbox].

1. Move the mouse cursor to the [Scan to Dropbox] icon  , and then click .

⇒ The [Scan to Dropbox - Options] window appears.

2. Change the settings.

For details about the [Scan to Dropbox - Options] window, refer to ScanSnap Manager Help.

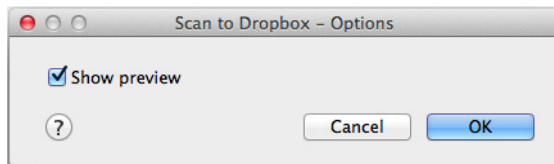

3. Click the [OK] button to close the [Scan to Dropbox - Options] window.

Saving Documents to Evernote

This section explains how to save the scanned image as a PDF file to Evernote.

When you save a scanned image to Evernote after converting it into a searchable PDF, the PDF file becomes searchable in Evernote.

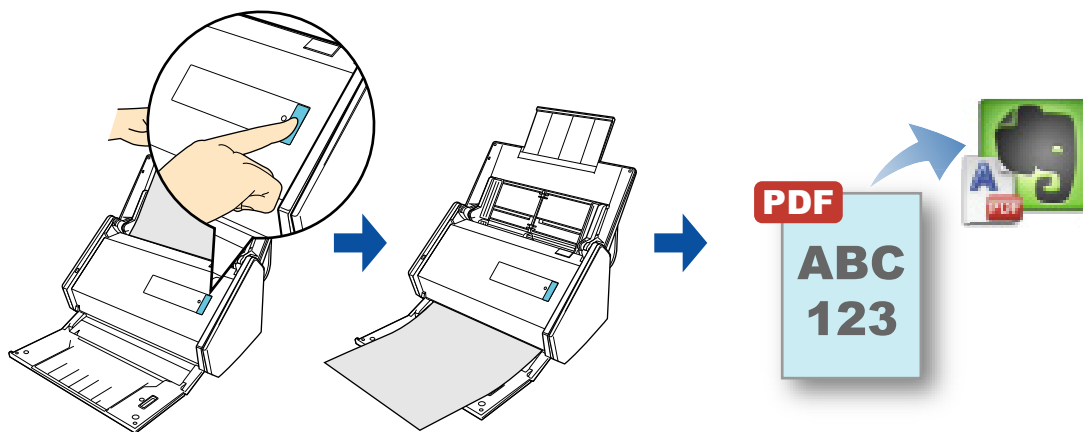

ATTENTION

- You need to create an Evernote account (free or paid).
- You first need to create a notebook in Evernote for Mac to save a file to Evernote.
- Disable [Bring the clip to the front] in Evernote [Preferences] window beforehand to prevent new notes appearing on the screen when you scan documents consecutively.

The screenshot below is from Evernote for Mac. Clear the [Bring the clip to the front] checkbox in this window.

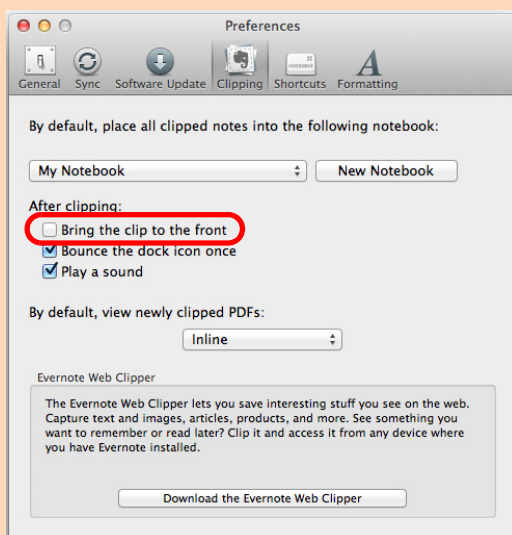

The actual window and the contents may differ depending on the Evernote version you are using.

HINT

By registering the scan and save settings as a profile, you can scan documents with the same profile at any time. For details, refer to "Profile" (page 369).

Procedures

HINT

To use the Quick Menu, you need to select the [Use Quick Menu] checkbox in the ScanSnap setup window.

For details about how to perform scanning by using the Quick Menu, refer to "[Basic Scanning Operation Flow](#)" (page 286).

1. Load a document in the ScanSnap.

For details, refer to "[How to Load Documents](#)" (page 63).

2. Press the [Scan] button on the ScanSnap to start a scan.

⇒ The Quick Menu appears when the scanning is completed.



To change the settings for [Scan to Evernote (Document)], move the mouse cursor to

the [Scan to Evernote (Document)] icon , and then click . For details about how to change the settings, "[Preferences](#)" (page 340).

ATTENTION

- You cannot start scanning when the Quick Menu is displayed. Save the PDF file to Evernote before scanning the next document.
- Do not move, delete or rename the scanned image in other applications when the Quick Menu is displayed.

3. Click the [Scan to Evernote (Document)] icon .

⇒ Text recognition is performed. The following window appears during text recognition.

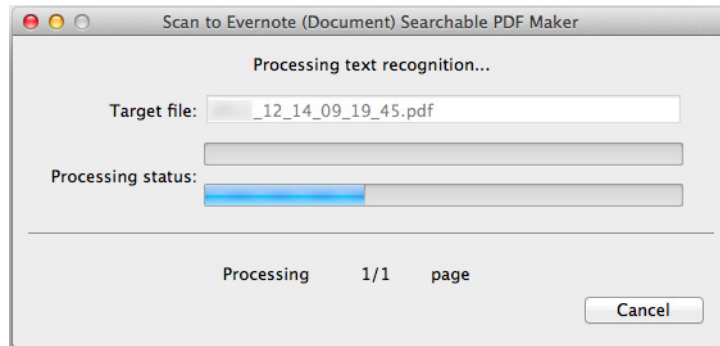

HINT

- If [JPEG(*.jpg)] is selected for [File format] in the [File option] tab of the ScanSnap setup window, a separate PDF file will be created from each JPEG file. The following window appears during file creation.

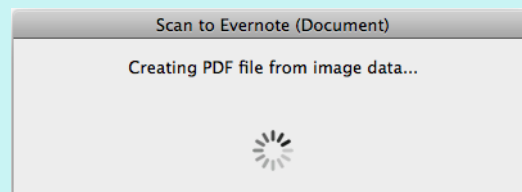

- Text recognition will be performed if there are any pages containing text which is not yet recognized. Note that text recognition will be performed on all pages, including pages containing text on which text recognition has already been performed.

⇒ Evernote for Mac starts up, and the PDF file is saved to Evernote.

HINT

The file in which the scanned image is saved remains in the folder specified for [Image saving folder] in the [Save] tab of the ScanSnap setup window even after the scanned image is saved to Evernote. Delete this file if unnecessary.

Preferences

You can configure the settings in order to link with [Scan to Evernote (Document)].

1. Move the mouse cursor to the [Scan to Evernote (Document)] icon



⇒ The [Scan to Evernote (Document) - Options] window appears.

2. Change the settings.

For details about the [Scan to Evernote (Document) - Options] window, refer to the ScanSnap Manager Help.

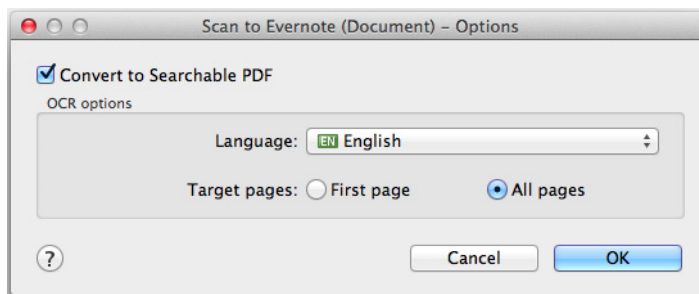

3. Click the [OK] button to close the [Scan to Evernote (Document) - Options] window.

Saving Handwritten Notes to Evernote

This section explains how to save the scanned image as a JPEG file to Evernote.

When you save a JPEG file to Evernote, text recognition is performed on all text, including handwritten characters, and the file becomes searchable in Evernote.

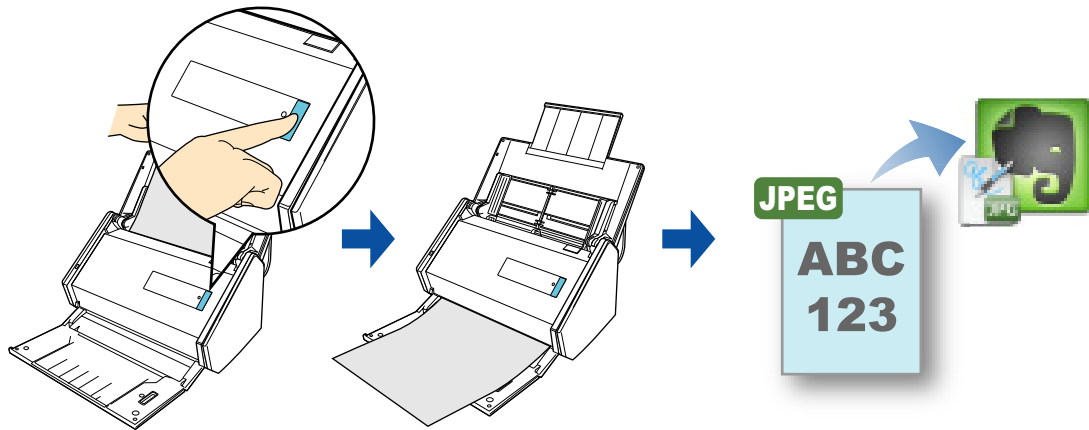

ATTENTION

- You need to create an Evernote account (free or paid).
- You first need to create a notebook in Evernote for Mac to save a file to Evernote.
- Disable [Bring the clip to the front] in Evernote [Preferences] window beforehand to prevent new notes appearing on the screen when you scan documents consecutively.

The screenshot below is from Evernote for Mac. Clear the [Bring the clip to the front] checkbox in this window.

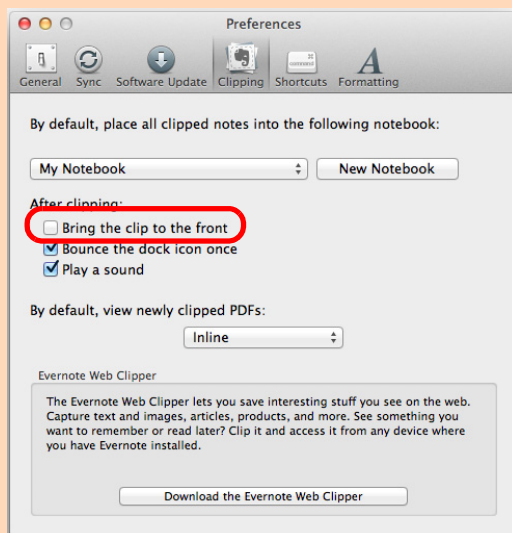

The actual window and the contents may differ depending on the Evernote version you are using.

HINT

By registering the scan and save settings as a profile, you can scan documents with the same profile at any time. For details, refer to "Profile" (page 369).

Procedures

HINT

To use the Quick Menu, you need to select the [Use Quick Menu] checkbox in the ScanSnap setup window.

For details about how to perform scanning by using the Quick Menu, refer to "[Basic Scanning Operation Flow](#)" (page 286).

1. Load a document in the ScanSnap.

For details, refer to "[How to Load Documents](#)" (page 63).

2. Press the [Scan] button on the ScanSnap to start a scan.

⇒ The Quick Menu appears when the scanning is completed.



ATTENTION

- You cannot start scanning when the Quick Menu is displayed. Save the JPEG file to Evernote before scanning the next document.
- Do not move, delete or rename the scanned image in other applications when the Quick Menu is displayed.

3. Click the [Scan to Evernote (Note)] icon .

⇒ Evernote for Mac starts up, and the JPEG file is saved to Evernote.

HINT

- If [PDF(*.pdf)] is selected for [File format] in the [File option] tab of the ScanSnap setup window, a separate JPEG file will be created from each page of the PDF file. The following window appears during file creation.

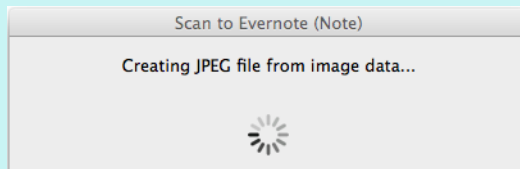

- When you select [PDF(*.pdf)] for [File format] in the [File option] tab of the ScanSnap setup window, a four-digit serial number is automatically added to the name of the file which is saved to Evernote.
e.g. When the file name is [ScanSnap], the file is saved as:
ScanSnap_0001, ScanSnap_0002, ScanSnap_0003...
- The file in which the scanned image is saved remains in the folder specified for [Image saving folder] in the [Save] tab of the ScanSnap setup window even after the scanned image is saved to Evernote. Delete this file if unnecessary.

Saving Documents to Google Docs

This section explains how to save the scanned image as a PDF file to Google Docs.

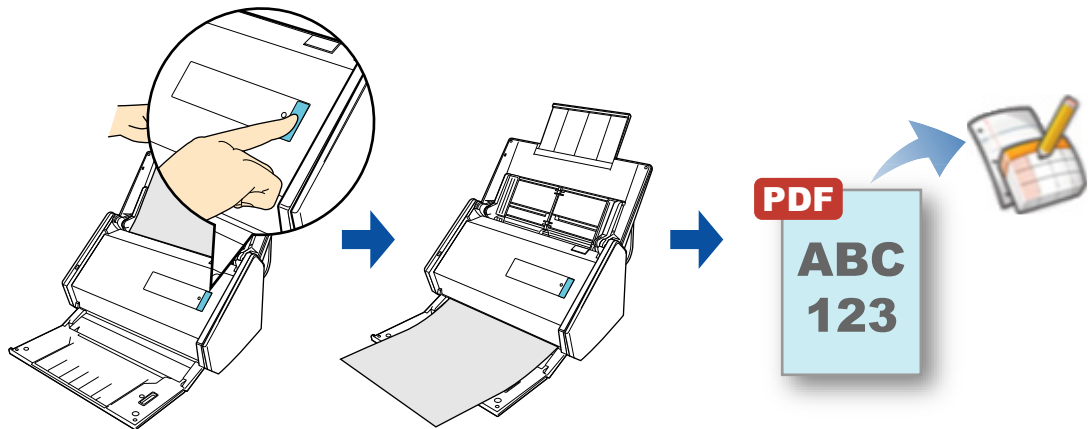

ATTENTION

You need to create a Google account (free).

HINT

By registering the scan and save settings as a profile, you can scan documents with the same profile at any time. For details, refer to "[Profile](#)" (page 369).

Procedures

HINT

To use the Quick Menu, you need to select the [Use Quick Menu] checkbox in the ScanSnap setup window.

For details about how to perform scanning by using the Quick Menu, refer to "[Basic Scanning Operation Flow](#)" (page 286).

1. Load a document in the ScanSnap.



For details, refer to "[How to Load Documents](#)" (page 63).

2. Press the [Scan] button on the ScanSnap to start a scan.

⇒ The Quick Menu appears when the scanning is completed.



To change the settings for [Scan to Google Docs(TM)], move the mouse cursor to the

[Scan to Google Docs(TM)] icon , and then click . For details about how to change the settings, "[Preferences](#)" (page 348).

ATTENTION

- You cannot start scanning when the Quick Menu is displayed. Save the PDF file to Google Docs before scanning the next document.
- Do not move, delete or rename the scanned image in other applications when the Quick Menu is displayed.

3. Click the [Scan to Google Docs(TM)] icon .

⇒ The [Scan to Google Docs(TM)] window appears.

4. Enter your e-mail address and password, and then click the [OK] button.

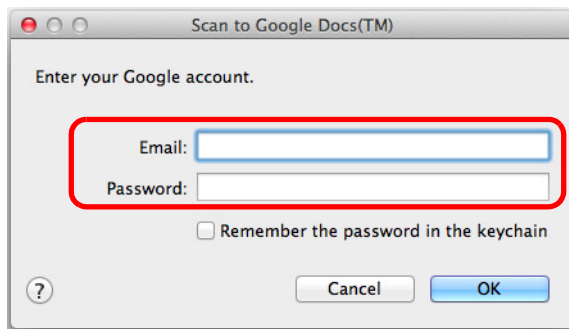

ATTENTION

- If the computer is shared with other users, do not select the [Remember the password in the keychain] checkbox in this window. Otherwise, other users will be able to log into Google Docs automatically.
- Scan to Google Docs(TM) is not available in a proxy environment that requires authentication upon connecting to the Internet.

HINT

If you specify a Google account in the [Scan to Google Docs(TM) - Options] window, the [Scan to Google Docs(TM)] window does not appear.

⇒ Text recognition is performed. The following window appears during text recognition.

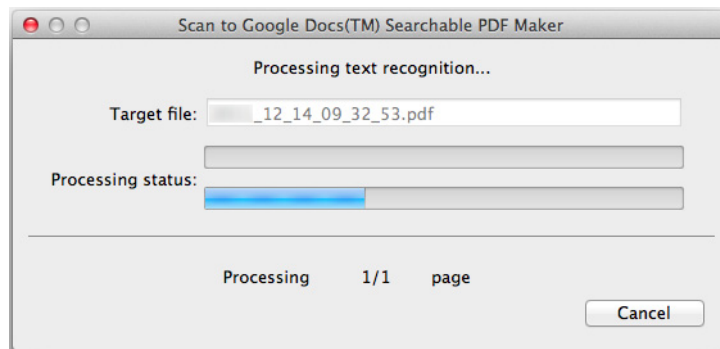

HINT

- If [JPEG(*.jpg)] is selected for [File format] in the [File option] tab of the ScanSnap setup window, a separate PDF file will be created from each JPEG file. The following window appears during file creation.

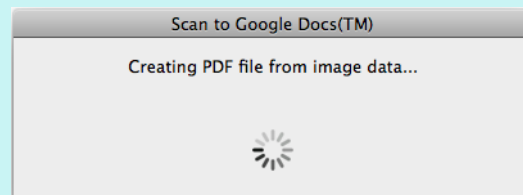

- Text recognition will be performed if there are any pages containing text which is not yet recognized. Note that text recognition will be performed on all pages, including pages containing text on which text recognition has already been performed.

⇒ Saving to Google Docs starts.

Click the [Close] button to close the [Scan to Google Docs(TM)] window when the saving is completed.

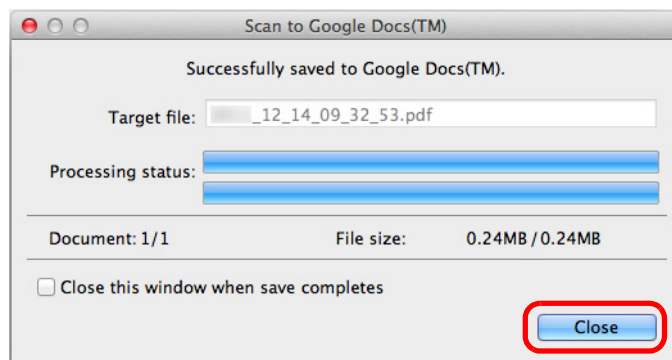

HINT



If you select the [Close this window when save completes] checkbox above, the [Scan to Google Docs(TM)] window will automatically close from next scanning on when the saving is completed.

HINT

Google Docs does not start up after the saving has completed. To check the saved PDF file, start a web browser and log into Google Docs.

Preferences

You can configure the settings in order to link with [Scan to Google Docs(TM)].

1. Move the mouse cursor to the [Scan to Google Docs(TM)] icon , and then click .

⇒ The [Scan to Google Docs(TM) - Options] window appears.

2. Change the settings.

For details about the [Scan to Google Docs(TM) - Options] window, refer to the ScanSnap Manager Help.

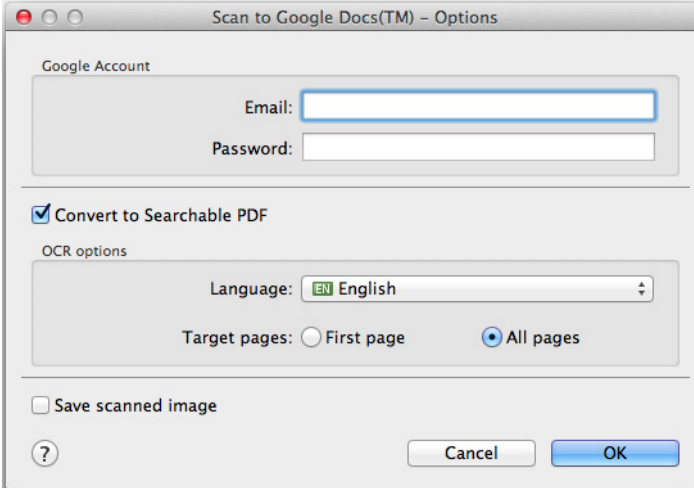

ATTENTION

If the computer is shared with other users, do not set your information in [Email] and [Password]. Otherwise, other users will be able to log into Google Docs automatically. It is recommended to set only [Email] in this window, and type in the password every time.

3. Click the [OK] button to close the [Scan to Google Docs(TM) - Options] window.

Posting to Salesforce Chatter

This section explains how to post a scanned image as a PDF or a JPEG file to Salesforce Chatter.

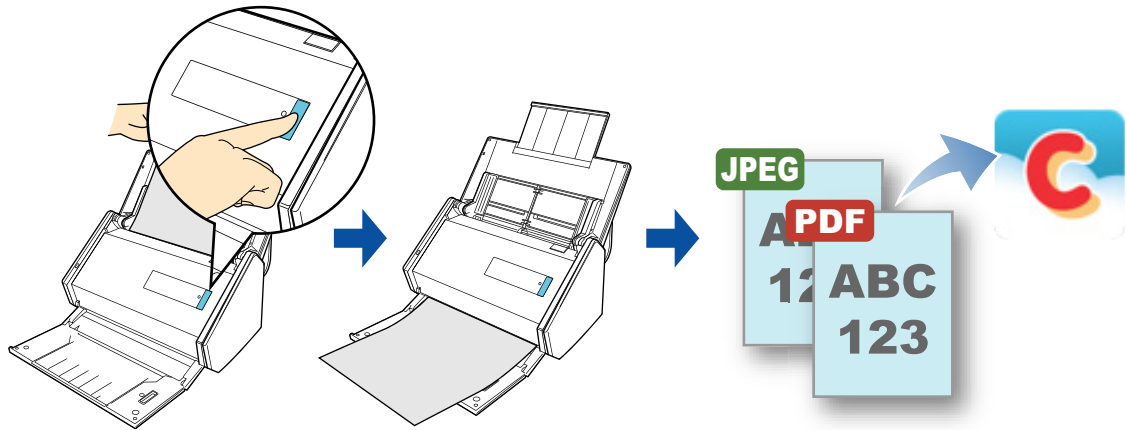

ATTENTION

- A Salesforce CRM license is required separately.
- ScanSnap Manager can link with the following Salesforce editions:
 - Unlimited
 - Enterprise

HINT

By registering the scan and save settings as a profile, you can scan documents with the same profile at any time. For details, refer to ["Profile"](#) (page 369).

Procedures

HINT

To use the Quick Menu, you need to select the [Use Quick Menu] checkbox in the ScanSnap setup window.

For details about how to perform scanning by using the Quick Menu, refer to "[Basic Scanning Operation Flow](#)" (page 286).

1. Load a document in the ScanSnap.



For details, refer to "[How to Load Documents](#)" (page 63).

2. Press the [Scan] button on the ScanSnap to start a scan.

⇒ The Quick Menu appears when the scanning is completed.



To change the settings for [Scan to Salesforce Chatter], move the mouse cursor to the

[Scan to Salesforce Chatter] icon , and then click . For details about how to change the settings, "[Preferences](#)" (page 354).

3. Click the [Scan to Salesforce Chatter] icon .

⇒ The [Scan to Salesforce Chatter - Login] window appears.

4. Enter your user name and password, and then click the [OK] button.

Enter a security token if needed.

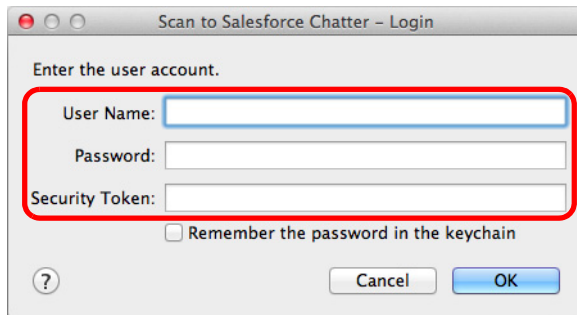

ATTENTION

- If the computer is shared with other users, do not select the [Remember the password in the keychain] checkbox in this window. Otherwise, other users will be able to log into Salesforce automatically.
- Scan to Salesforce Chatter is not available in a proxy environment that requires authentication upon connecting to the Internet.

HINT

If you specify a Salesforce account in the [Scan to Salesforce Chatter - Options] window, the [Scan to Salesforce Chatter - Login] window does not appear.

⇒ The [Scan to Salesforce Chatter] window appears.

5. Check the scanned image in the preview area.

In the [Scan to Salesforce Chatter] window, you can set the posting destination and method, the message to post, the name and description of the image file that will be posted to Salesforce Chatter, and whether to save the scanned image in the folder specified for [Image saving folder].

For details about the [Scan to Salesforce Chatter] window, refer to the ScanSnap Manager Help.

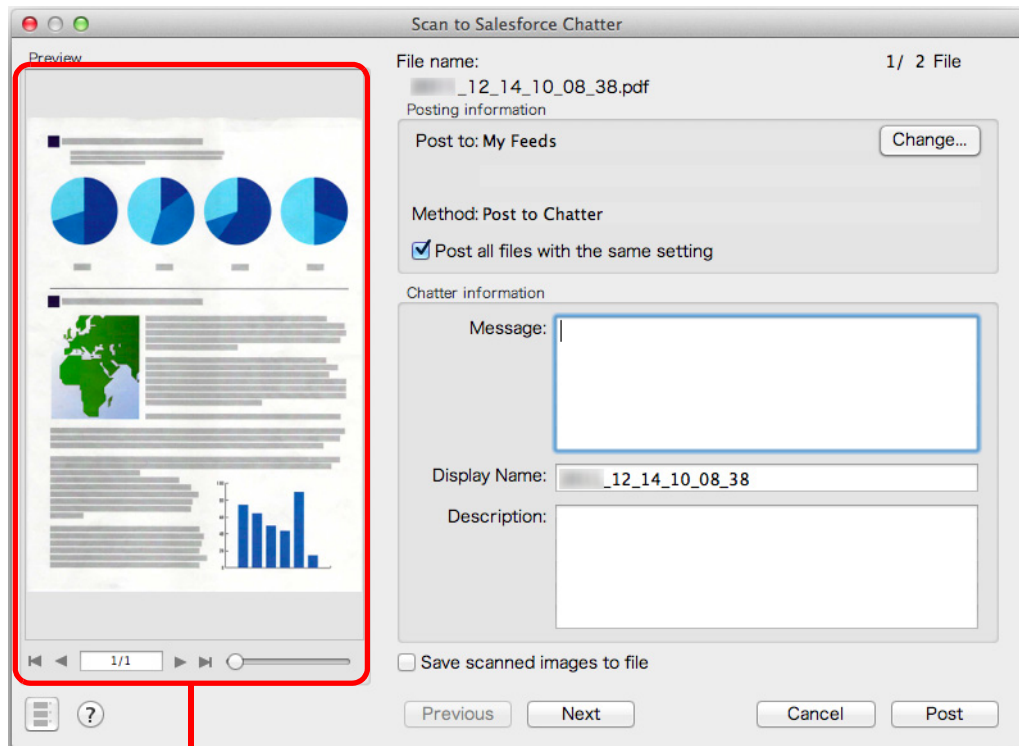

Preview

ATTENTION

- You cannot start scanning after the Quick Menu is displayed and before the [Scan to Salesforce Chatter] window is closed. Close the [Scan to Salesforce Chatter] window before scanning the next document.
- Do not move, delete or rename the scanned image in other applications when the Quick Menu is displayed.

6. Click the [Post] button.

⇒ Posting to Salesforce Chatter starts.

Click the [Close] button to close the [Scan to Salesforce Chatter] window when the posting is completed.

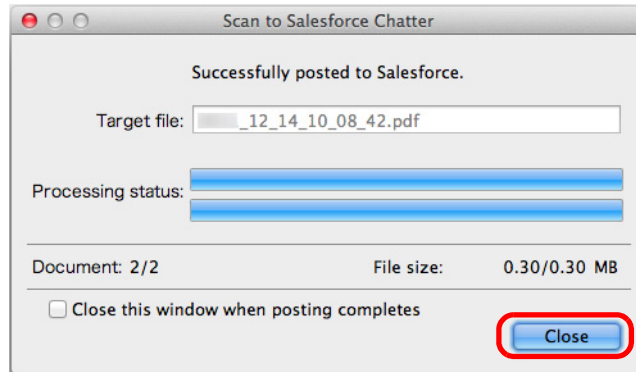

HINT

- If you select the [Close this window when posting completes] checkbox above, the [Scan to Salesforce Chatter] window will automatically close from next scanning on when the posting is completed.
- Salesforce does not start up after the posting has completed. To check the saved scanned image file, start a web browser and log into Salesforce.

Preferences

You can configure the settings in order to link with [Scan to Salesforce Chatter].

1. Move the mouse cursor to the [Scan to Salesforce Chatter] icon , and then click .

⇒ The [Scan to Salesforce Chatter - Options] window appears.

2. Change the settings.

For details about the [Scan to Salesforce Chatter - Options] window, refer to the ScanSnap Manager Help.

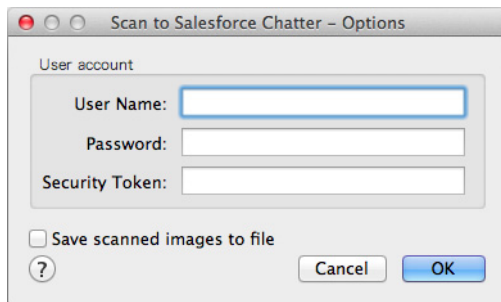

ATTENTION

If the computer is shared with other users, do not set your information in [User Name], [Password] and [Security Token]. Otherwise, other users will be able to log into Salesforce automatically. It is recommended to set only [User Name] and [Security Token] in this window, and type in the password every time.

3. Click the [OK] button to close the [Scan to Salesforce Chatter - Options] window.

Saving Data to Your SugarSync Folder

This section explains how to save the scanned image as a PDF or a JPEG file to your SugarSync folder.

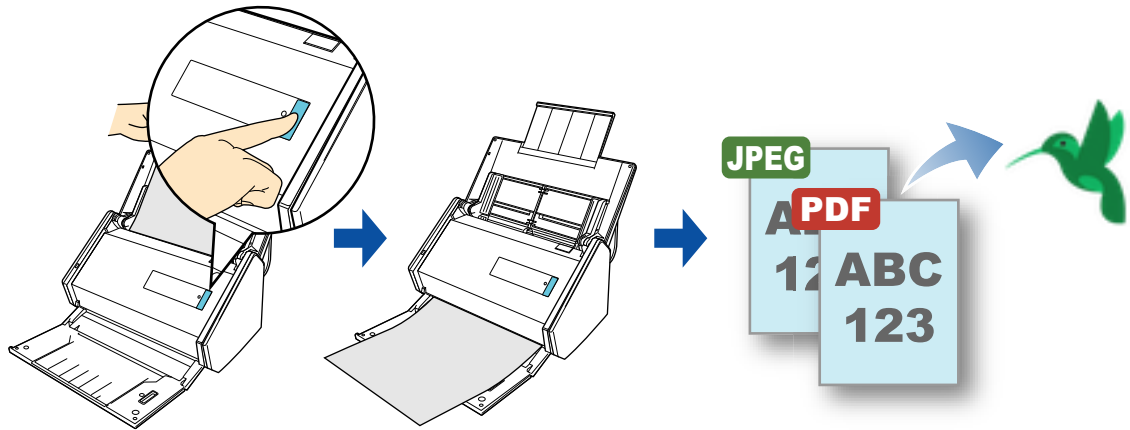

ATTENTION

- You need to have a SugarSync account.
- You need to have SugarSync Manager for Mac 1.9.29 or later installed in order to use this function.

HINT

- When you first log into SugarSync after installing SugarSync Manager for Mac is automatically created. My SugarSync is a sync folder used in SugarSync.
- By registering the scan and save settings as a profile, you can scan documents with the same profile at any time. For details, refer to ["Profile" \(page 369\)](#).

Procedures

HINT

To use the Quick Menu, you need to select the [Use Quick Menu] checkbox in the ScanSnap setup window.

For details about how to perform scanning by using the Quick Menu, refer to "[Basic Scanning Operation Flow](#)" (page 286).

1. Load a document in the ScanSnap.

For details, refer to "[How to Load Documents](#)" (page 63).

2. Press the [Scan] button on the ScanSnap to start a scan.

⇒ The Quick Menu appears when the scanning is completed.



To change the settings for [Scan to SugarSync], move the mouse cursor to the [Scan to

SugarSync] icon , and then click . For details about how to change the settings, "[Preferences](#)" (page 358).

3. Click the [Scan to SugarSync] icon .

⇒ The [Scan to SugarSync] window appears.

HINT

You can configure the settings to not show the [Scan to SugarSync] window. If you configure the settings to not show the [Scan to SugarSync] window, scanned images are saved directly to the SugarSync sync folder.

For details about how to change the settings, "[Preferences](#)" (page 358).

4. Check the scanned image in the preview area.

In the [Scan to SugarSync] window, you can rename the file and specify your SugarSync folder.

For details about the [Scan to SugarSync] window, refer to the ScanSnap Manager Help.

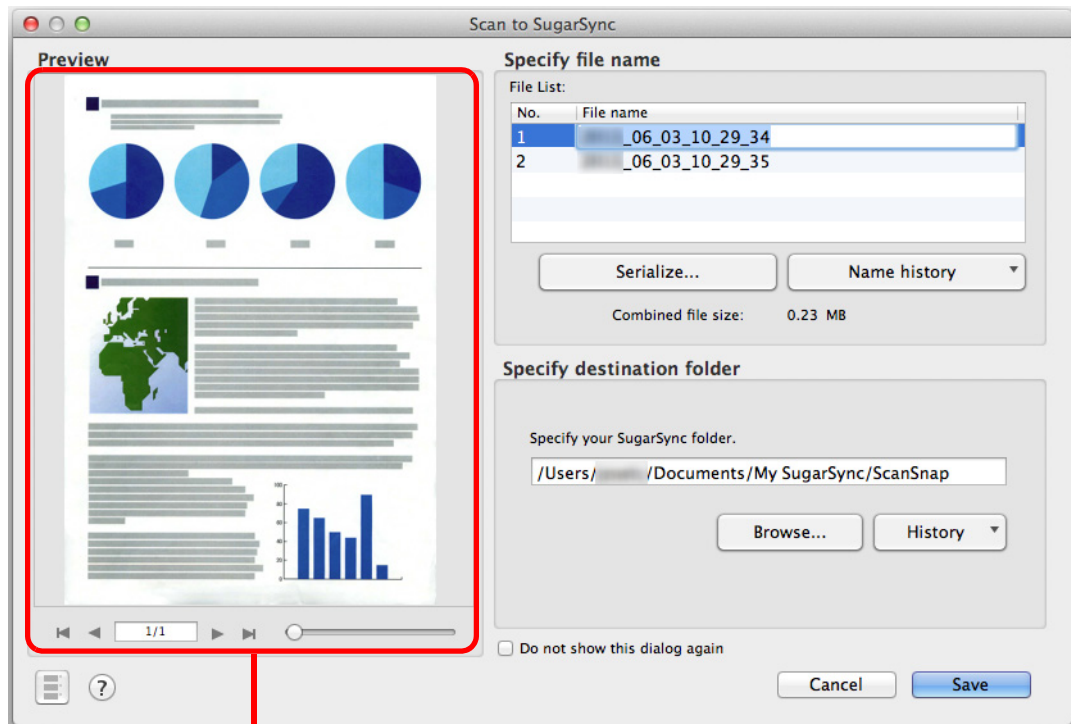

Preview

ATTENTION



- The file will not be synced with SugarSync unless you select a SugarSync folder as the destination folder.
- You cannot start scanning after the Quick Menu is displayed and before the [Scan to SugarSync] window is closed. Close the [Scan to SugarSync] window before scanning the next document.
- Do not move, delete or rename the scanned image in other applications after the Quick Menu is displayed and before the [Scan to SugarSync] window is closed.

5. Click the [Save] button.

⇒ The scanned image is saved to your SugarSync folder.

Preferences

You can configure the settings in order to link with [Scan to SugarSync].

1. Move the mouse cursor to the [Scan to SugarSync] icon , and then click .

⇒ The [Scan to SugarSync - Options] window appears.

2. Change the settings.

For details about the [Scan to SugarSync - Options] window, refer to the ScanSnap Manager Help.

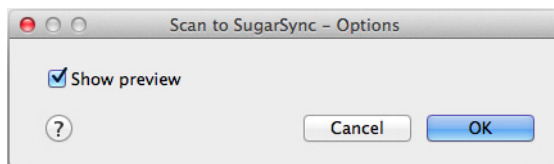

3. Click the [OK] button to close the [Scan to SugarSync - Options] window.

Converting into Word/Excel/PowerPoint Documents

This section explains how to convert the scanned image into Word/Excel/PowerPoint files using ABBYY FineReader for ScanSnap bundled with the ScanSnap.

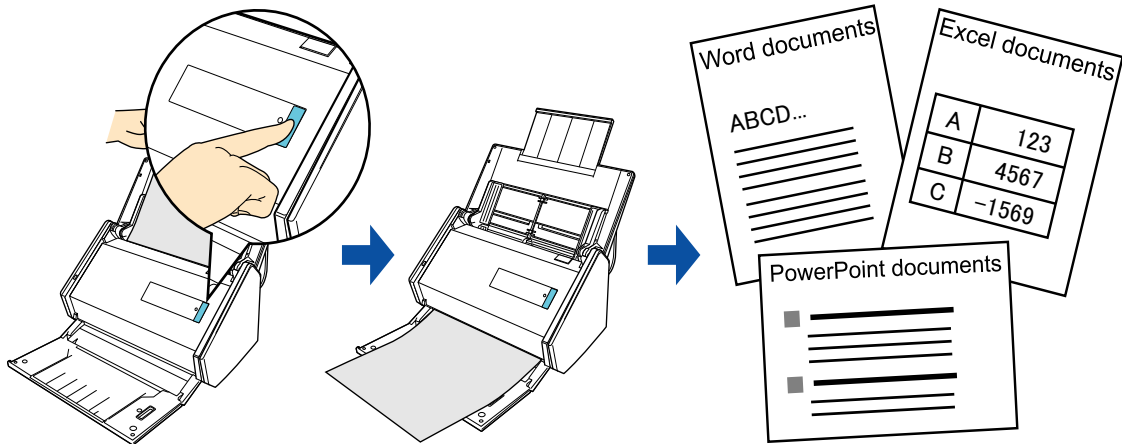

ATTENTION

- The following applications must be installed in your computer in order to perform text-recognition:
 - ABBYY FineReader for ScanSnap (bundled with the ScanSnap)
 - Word
 - Excel
 - PowerPoint

If Word is not installed in your computer, you can view documents converted to Word in TextEdit. If Excel or PowerPoint is not installed in your computer, you cannot view documents converted to Excel or PowerPoint.

- You cannot view the documents converted into Word, Excel and PowerPoint files unless these applications are installed and you completed the user registration to use them. Install these applications and complete the user registration to view the converted documents on your computer.
- For details on the applications that are supported by ABBYY FineReader for ScanSnap and their versions, refer to the ABBYY FineReader for ScanSnap Help. After installing a supported application, enable the application.
- Do not use this function while you are working in Word, Excel or PowerPoint. In addition, do not use Word, Excel or PowerPoint while this function is being executed. If you use either Word or Excel together with this function, the conversion result is saved to a file, but the conversion result may not be displayed even if the [Open recognized document] checkbox is selected on the [Preferences] window.
- For details about the OCR function of ABBYY FineReader for ScanSnap, refer to ["OCR function of ABBYY FineReader for ScanSnap" \(page 363\)](#).

HINT

By registering the scan and save settings as a profile, you can scan documents with the same profile at any time. For details, refer to ["Profile" \(page 369\)](#).

Procedures

ATTENTION

When you perform a scan with [JPEG(*.jpg)] selected for [File format] in the [File option] tab of the ScanSnap setup window, scanned data cannot be converted into a Word, Excel or PowerPoint file.

HINT

To use the Quick Menu, you need to select the [Use Quick Menu] checkbox in the ScanSnap setup window.

For details about how to perform scanning by using the Quick Menu, refer to "[Basic Scanning Operation Flow](#)" (page 286).

1. Load a document in the ScanSnap.

For details, refer to "[How to Load Documents](#)" (page 63).

2. Press the [Scan] button on the ScanSnap to start a scan.

HINT

It is recommended to select [Automatic resolution] or [Best] for [Image quality] in the [Scanning] tab in the ScanSnap setup window.

⇒ The Quick Menu appears when the scanning is completed.



To change the settings for [ABBYY Scan to Word], [ABBYY Scan to Excel(R)] or [ABBYY Scan to PowerPoint(R)], move the mouse cursor to the corresponding icon

(shown below), and then click .

- The [ABBYY Scan to Word] icon 

- The [ABBYY Scan to Excel(R)] icon 

- The [ABBYY Scan to PowerPoint(R)] icon 

For details about how to change the settings, refer to "[Preferences](#)" (page 362).

ATTENTION

- You cannot start scanning when the Quick Menu is displayed. Wait until the conversion is over to scan another document.
- Do not move, delete or rename the scanned image in other applications when the Quick Menu is displayed.

- 3.** Click the [ABBYY Scan to Word] icon  , [ABBYY Scan to Excel(R)] icon  or [ABBYY Scan to PowerPoint(R)] icon .



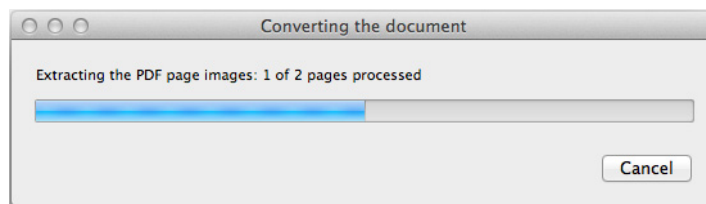

⇒ The following window appears, and conversion starts.



⇒ When the conversion is completed, Word, Excel or PowerPoint starts up, and the conversion result is displayed.

Preferences

You can configure the settings in order to link with [ABBYY Scan to Word], [ABBYY Scan to Excel(R)] or [ABBYY Scan to PowerPoint(R)].

1. Move the mouse cursor to the [ABBYY Scan to Word] icon ,
[ABBYY Scan to Excel(R)] icon  or [ABBYY Scan to
PowerPoint(R)] icon , and then click .

⇒ The [Preferences] window appears.

2. Change the settings.

For details about the [Preferences] window, refer to the ABBYY FineReader for ScanSnap Help.

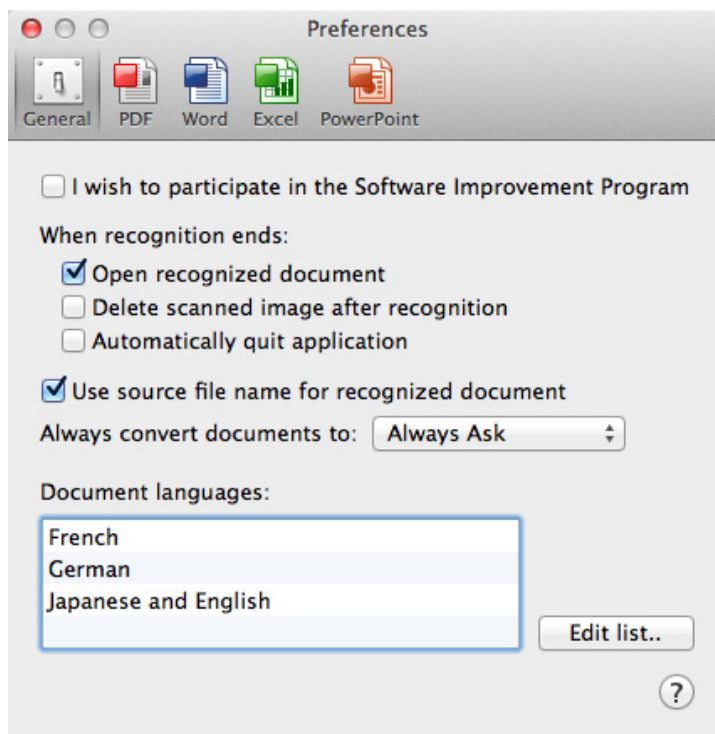

3. Click the [OK] button to close the [Preferences] window.

OCR function of ABBYY FineReader for ScanSnap

Overview of ABBYY FineReader for ScanSnap

ABBYY FineReader for ScanSnap is an application used exclusively with the ScanSnap. This program can perform text recognition only for PDF files created by using the ScanSnap. It cannot perform text recognition for files created using Adobe Acrobat or other applications.

Features of OCR Function

The optical character recognition program has the following features. Before performing text recognition, check whether the documents you want to convert are suitable for conversion according to the following guidelines:

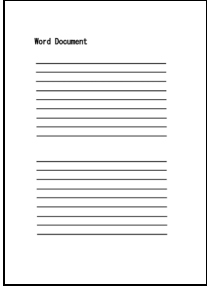
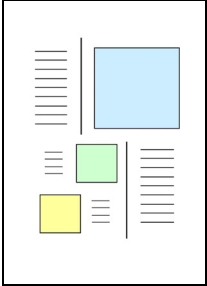
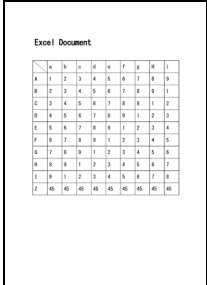
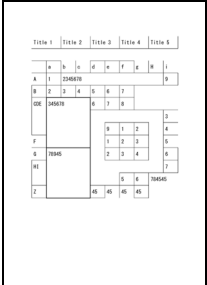
Application	Suitable for conversion	Not suitable for conversion
ABBYY Scan to Word	<p>Documents with simple layouts consisting of single or double columns</p> 	<p>Documents with complex layouts containing a mixture of diagrams, tables and text (e.g. brochures, magazines and newspapers)</p> 
ABBYY Scan to Excel(R)	<p>Documents containing simple tables with no cells merged</p> 	<p>Documents containing:</p> <ul style="list-style-type: none"> ● Tables with no solid border lines ● Tables with complicated cell formats ● Complex tables containing sub-tables ● Diagrams ● Graphs ● Photos ● Vertical text 

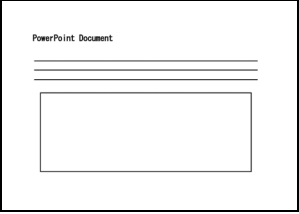
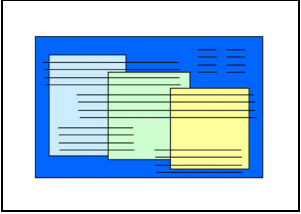
Application	Suitable for conversion	Not suitable for conversion
ABBY Scan to PowerPoint(R)	<p>Documents containing text and simple diagrams/tables on a white or light monocholor background</p> 	<ul style="list-style-type: none"> ● Documents with complex layouts containing text mixed with diagrams or illustrations ● Documents containing photographs or patterns set as the background ● Documents with light colored text on a deep colored background 

Information that cannot be reproduced as in the original document

The following parameters may not be reproduced as they are in the original document. It is recommended that you check the conversion result in Word, Excel or PowerPoint and edit the data if necessary:

- Character font and size
- Character and line spacing
- Underlined, bold and italic characters
- Superscript/subscript

Document where characters cannot be recognized correctly

The following types of documents (characters) may not be recognized correctly. Better results in text recognition may be achieved by changing the color mode or increasing the resolution:

- Documents including handwritten characters
- Documents containing small characters (smaller than 10 points)
- Skewed documents
- Documents written in languages other than the specified language
- Documents with characters on an unevenly colored background
e.g. Shaded characters
- Documents with many decorated characters
e.g. Decorated characters (embossed/outlined)
- Documents with characters on a patterned background
e.g. Characters overlapping illustrations and diagrams
- Documents with many characters contacting underlines or borders
- Documents with a complex layout and documents with image noise
(It may take extra time to process text recognition for these documents.)

Other considerations

- When converting to Excel files, if the recognition result exceeds 65,536 lines, no more results are saved.
- When converting to Excel files, information about the layout of the entire document, diagrams, and length/width of graphs and tables is not duplicated. Only tables and character strings are reproduced.
- A converted PowerPoint document will not have the original background color and patterns.
- Documents placed upside down or in landscape orientation cannot be recognized properly. Select the [Automatic image rotation] checkbox ([page 389](#)), or load documents face down in portrait orientation.
- If bleed-through reduction is enabled, the recognition rate may be lowered. In that case, disable it in the following procedure.
Select [Settings] → [Scanning] tab → [Option] button from the ScanSnap Manager menu to show the [Scanning mode option] window. Clear the [Reduce bleed-through] checkbox.

Saving Scanned Images in iPhoto

This section explains how to save the scanned image in iPhoto.

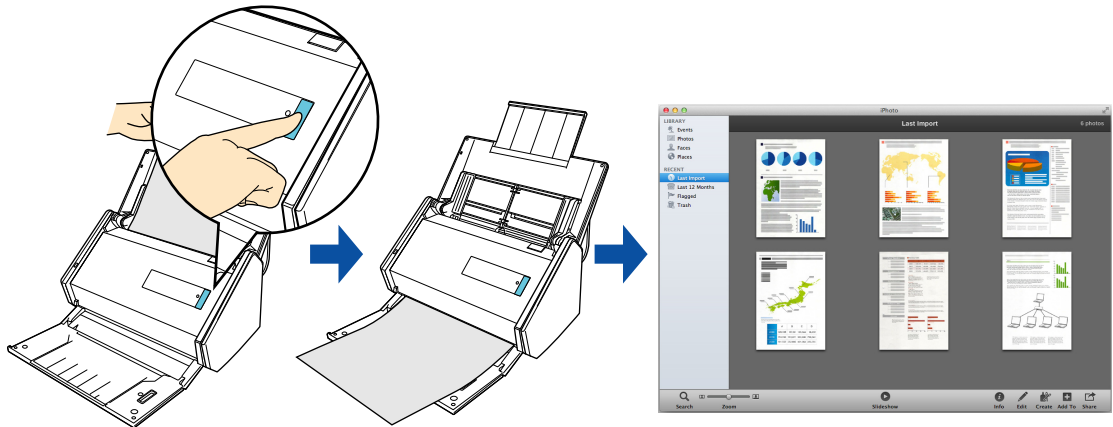

HINT

By registering the scan and save settings as a profile, you can scan documents with the same profile at any time. For details, refer to "[Profile](#)" (page 369).

Procedures

HINT

To use the Quick Menu, you need to select the [Use Quick Menu] checkbox in the ScanSnap setup window.

For details about how to perform scanning by using the Quick Menu, refer to "[Basic Scanning Operation Flow](#)" (page 286).

1. Load a document in the ScanSnap.

For details, refer to "[How to Load Documents](#)" (page 63).

2. Press the [Scan] button on the ScanSnap to start a scan.

⇒ The Quick Menu appears when the scanning is completed.



ATTENTION

- You cannot start scanning when the Quick Menu is displayed. Wait until ScanSnap Manager links with iPhoto before scanning another document.
- Do not move, delete or rename the scanned image in other applications when the Quick Menu is displayed.

3. Click the [iPhoto] icon .

⇒ The [iPhoto] window appears.

4. Check the scanned image stored in iPhoto.

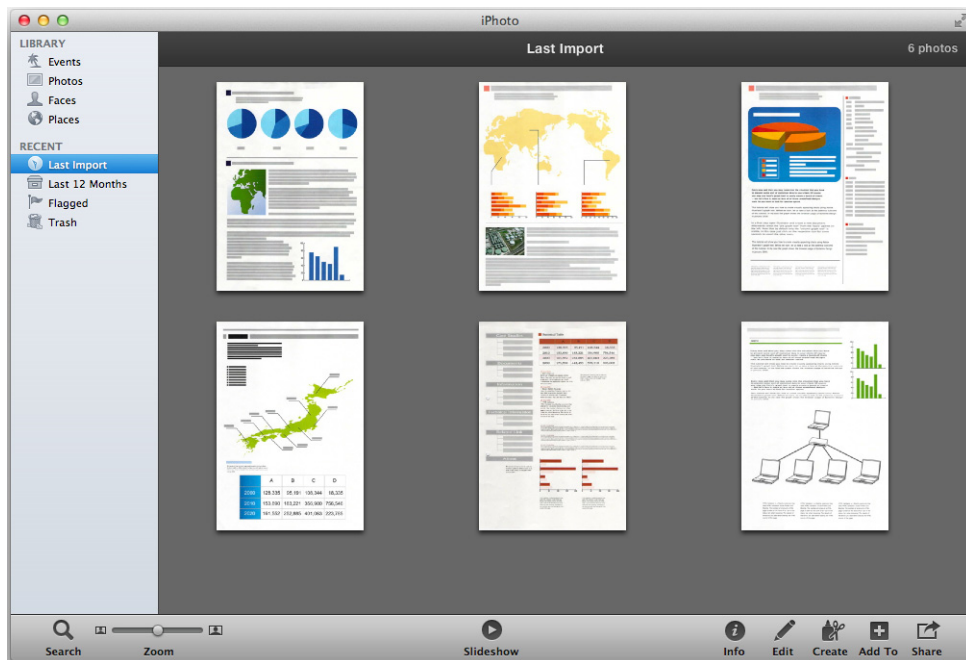

HINT

The scanned image is also saved in the folder specified for [Image saving folder] in the [Save] tab of the ScanSnap setup window at the same time when it is saved to iPhoto. Delete this file if unnecessary.

Profile

Once the frequently used scan settings are saved as profiles, you can select a profile to easily change scan settings depending on your scanning purpose. You can manage up to 20 profiles.

To select a profile, click the ScanSnap Manager icon  to show the Profile menu.

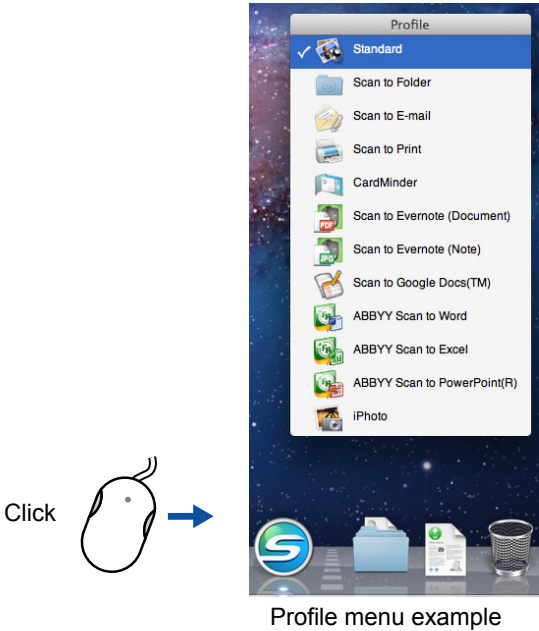

Profile menu example

- HINT**
- To use a profile, you need to clear the [Use Quick Menu] checkbox in the ScanSnap setup window.
 - You can also display the Profile menu by selecting [Profile] from ScanSnap Manager menu.
 - You can also select a profile by selecting [Profile] from ScanSnap setup window.
 - Profiles configured for the following scanner models will be carried over to ScanSnap iX500 if the computer is the same:
 - ScanSnap S1500
 - ScanSnap S1500M
 - ScanSnap S1300i
 - ScanSnap S1300
 - ScanSnap S1100
 - ScanSnap S510M
 - ScanSnap S300M

How to Configure Scan Settings

You can configure scan settings depending on your intended use of the scanned images.

Scan settings can be configured in the ScanSnap setup window.

For details about how to configure scan settings, refer to "[How to Configure Scan Settings](#)" ([page 421](#)).

Profile Management

For details about how to add, change or delete profiles, refer to the following:

- To add a profile (→ [page 370](#))
- To change scan settings for profiles (→ [page 374](#))
- To rename a profile (→ [page 376](#))
- To delete a profile (→ [page 378](#))

Adding Profiles

1. Select [Settings] from the ScanSnap Manager menu.

For details about the ScanSnap Manager menu, refer to "[ScanSnap Manager Menu \(Mac OS\)](#)" ([page 39](#)).

⇒ The ScanSnap setup window appears.

HINT

Clear the [Use Quick Menu] checkbox if it is selected.

2. Change the scan settings in each tab.

For details about each tab, refer to the ScanSnap Manager Help.

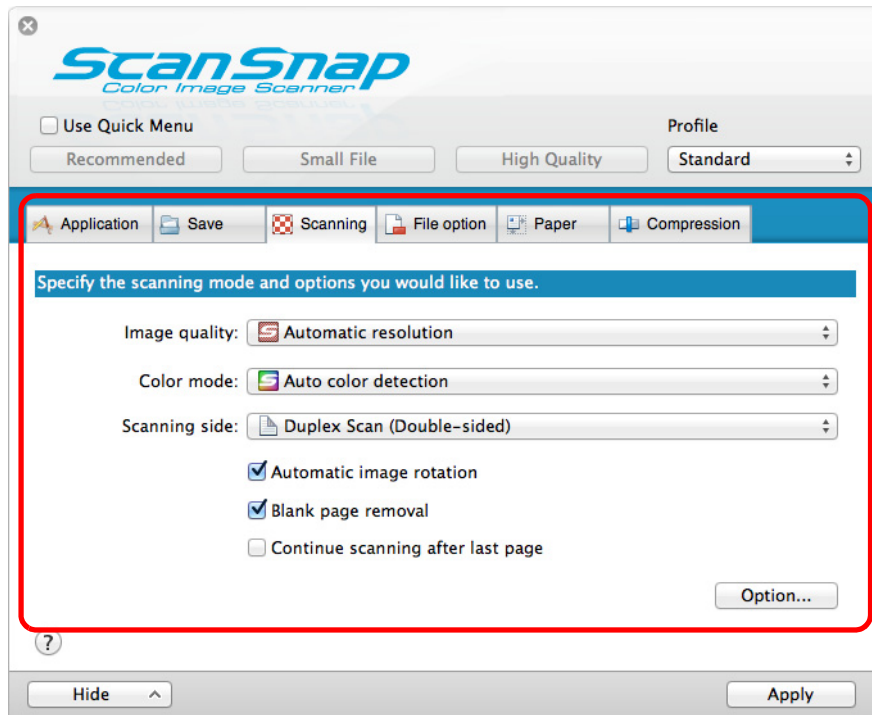

3. Select [Add Profile] from the [Profile].

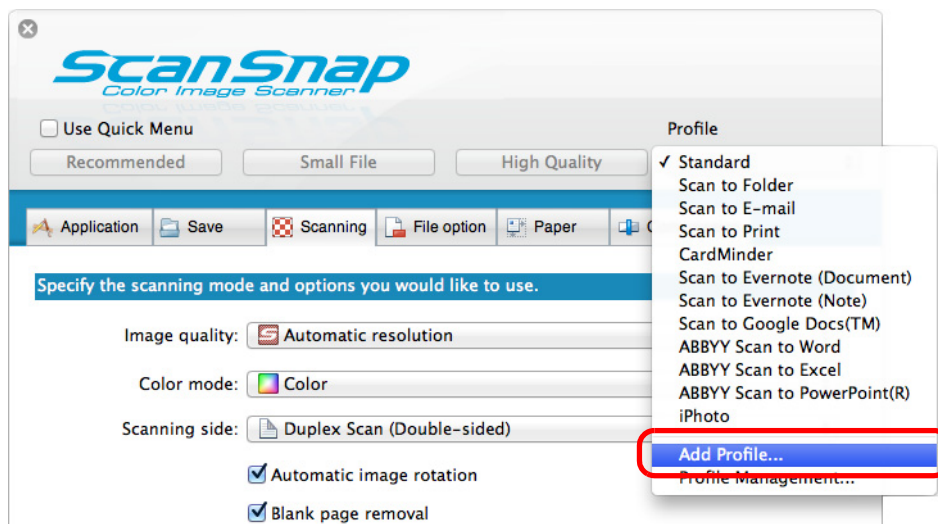

⇒ The [Add new profile] window appears.

4. Type in a new profile name and click the [OK] button.

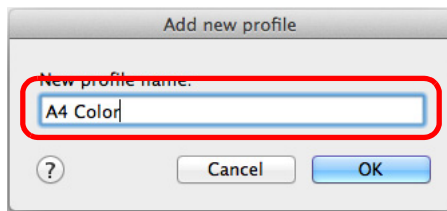

⇒ The added profile appears in [Profile] in the ScanSnap setup window.

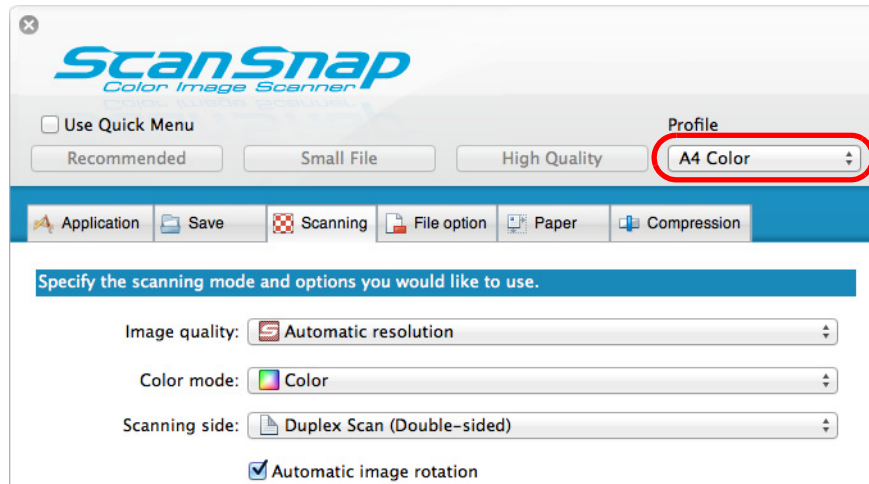

5. Click the [Apply] button.

6. Click the [X] button in the upper left corner to close the ScanSnap setup window.

HINT

- Up to 20 profiles can be saved including the [Standard] profile.
 - You can change the display order of profiles.
However, you cannot change the [Standard] display order.
1. Select [Profile Management] from the ScanSnap Manager menu or from [Profile] in the ScanSnap setup window.
⇒ The [ScanSnap Manager - Profile Management] appears.
 2. Drag the profile to move it to its desired position in the list.

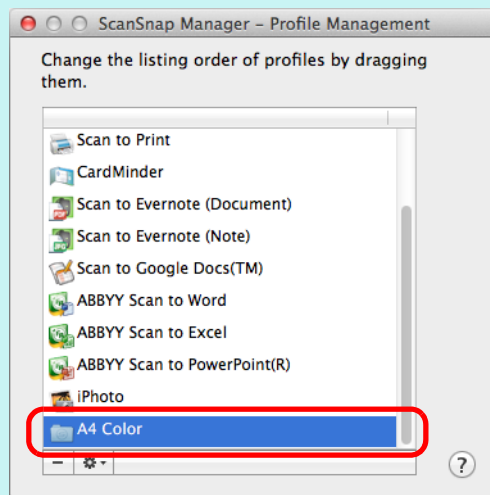

3. Click the [Close] button in the upper left to close the [ScanSnap Manager - Profile Management] window.

Changing Profile Settings

1. Select [Settings] from the ScanSnap Manager menu.

For details about the ScanSnap Manager menu, refer to "ScanSnap Manager Menu (Mac OS)" (page 39).

⇒ The ScanSnap setup window appears.

HINT
Clear the [Use Quick Menu] checkbox if it is selected.

2. Select a profile to change from [Profile].

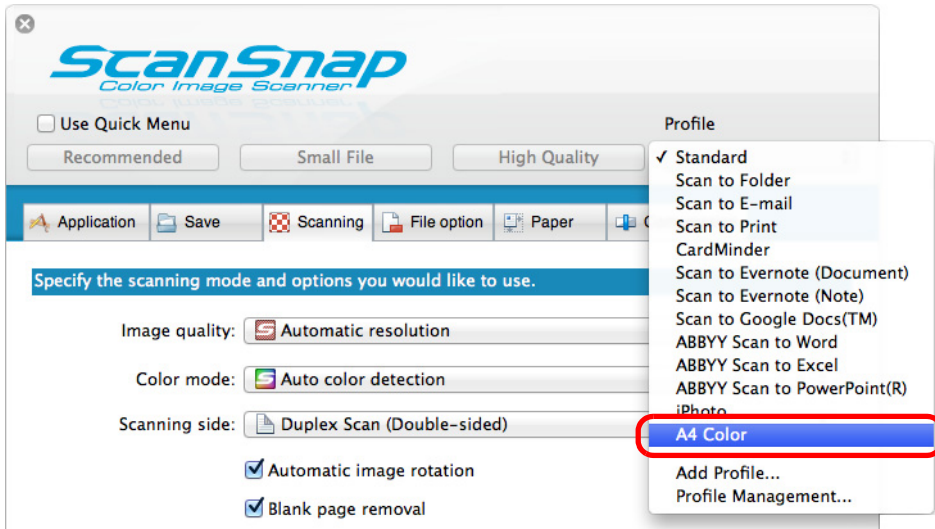

3. Change the scan settings in each tab.

For details about each tab, refer to the ScanSnap Manager Help.

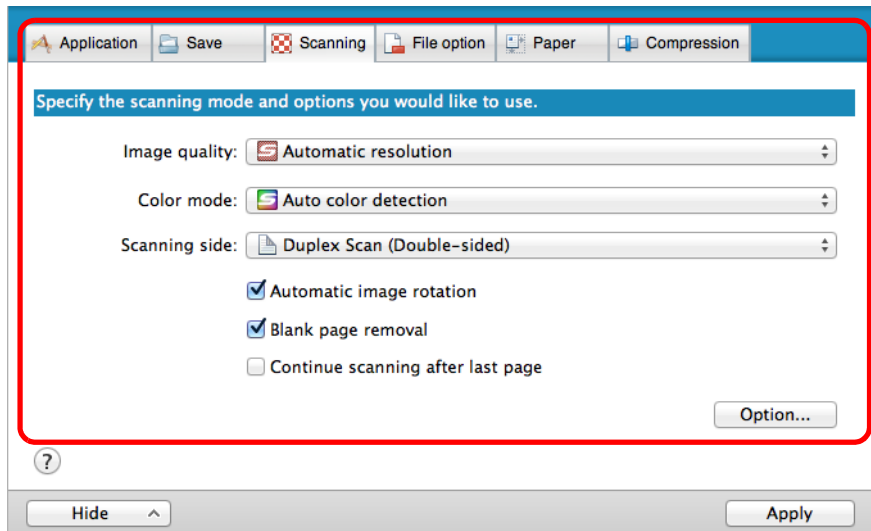

4. When you finish changing the settings for the selected profile, click the [Apply] button.

5. Click the [✕] button in the upper left corner to close the ScanSnap setup window.

Renaming Profiles

1. Select [Profile Management] from the ScanSnap Manager menu.

For details about the ScanSnap Manager menu, refer to "[ScanSnap Manager Menu \(Mac OS\)](#)" (page 39).

⇒ The [ScanSnap Manager - Profile Management] window appears.

HINT

- If you cannot select [Profile Management] in the ScanSnap Manager menu, clear the [Use Quick Menu] checkbox in the ScanSnap setup window.
- You can also display the [ScanSnap Manager - Profile Management] window by selecting [Profile Management] from [Profile] in the ScanSnap setup window.

2. Select a profile, click the [] button in the lower left corner, and select [Rename].

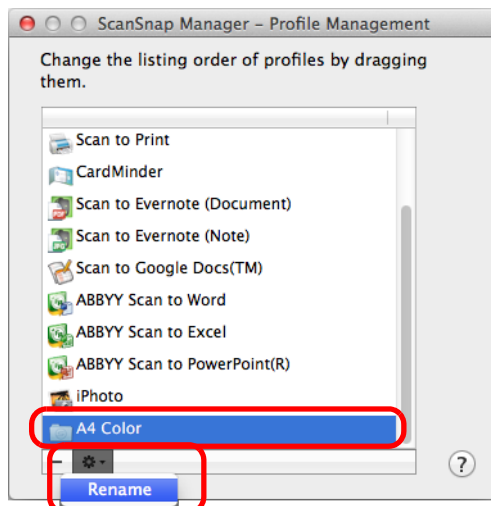

⇒ The name field of the profile becomes editable.

ATTENTION

The [Standard] profile cannot be renamed.

3. Type in a new name.

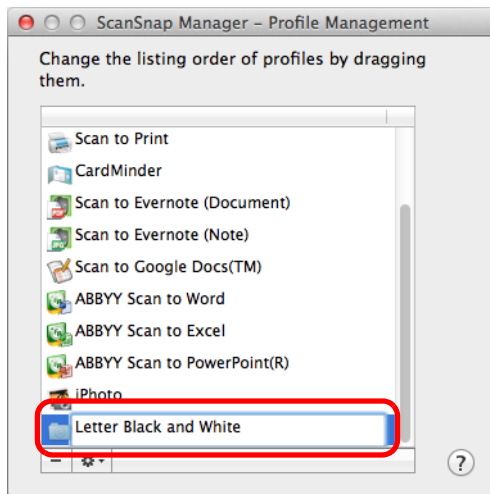

⇒ The profile is renamed.

4. Click the [⌵] button in the upper left to close the [ScanSnap Manager - Profile Management] window.

⇒ A message appears.

5. Click the [Apply] button.

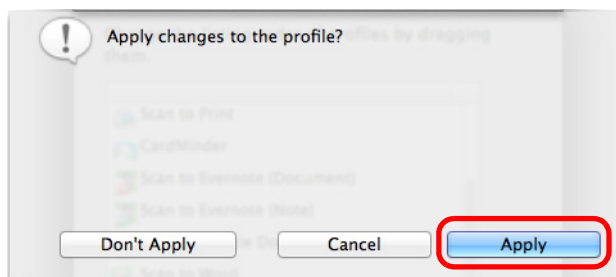

Deleting Profiles

1. Select [Profile Management] from the ScanSnap Manager menu.

For details about the ScanSnap Manager menu, refer to "[ScanSnap Manager Menu \(Mac OS\)](#)" (page 39).

⇒ The [ScanSnap Manager - Profile Management] window appears.

HINT

- If you cannot select [Profile Management] in the ScanSnap Manager menu, clear the [Use Quick Menu] checkbox in the ScanSnap setup window.
- You can also display the [ScanSnap Manager - Profile Management] window by selecting [Profile Management] from [Profile] in the ScanSnap setup window.

2. Select a profile to delete and click the [-] button.

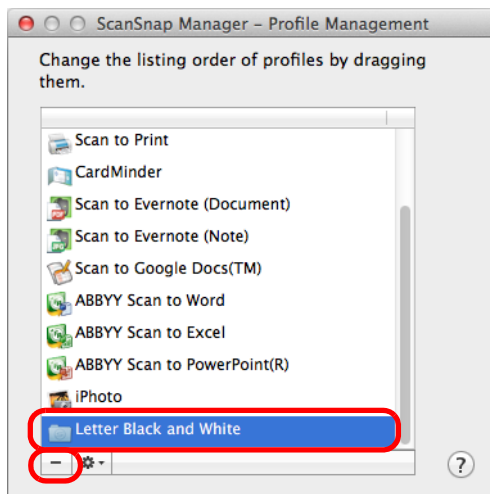

ATTENTION

The [Standard] profile cannot be deleted.

⇒ The selected profile is deleted.

3. Click the [⌵] button in the upper left to close the [ScanSnap Manager - Profile Management] window.

⇒ A message appears.

4. Click the [Apply] button.

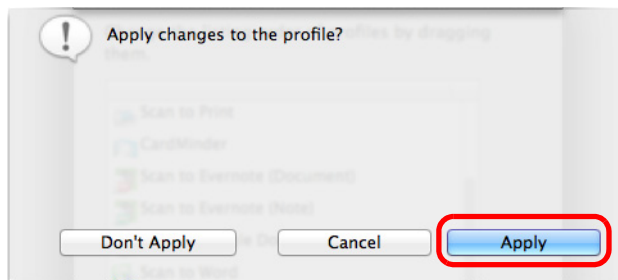

How to Perform a Scan

This section explains how to use profiles to perform scanning.

The following explains an example in which the scanned image file is linked to Mac OS Preview.

1. Select [Settings] from the ScanSnap Manager menu.

For details about the ScanSnap Manager menu, refer to "[ScanSnap Manager Menu \(Mac OS\)](#)" (page 39).

⇒ The ScanSnap setup window appears.

2. Clear the [Use Quick Menu] checkbox.

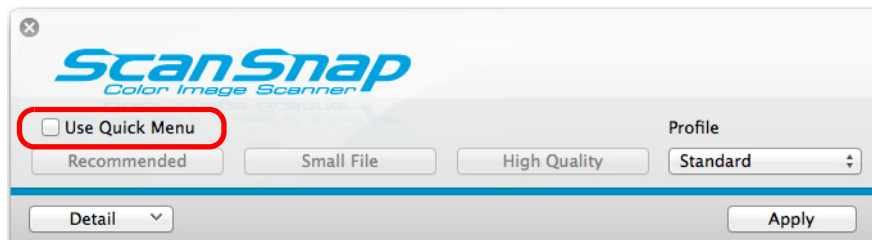

3. Click the [Apply] button in the ScanSnap setup window.

4. Click the [✕] button in the upper left corner to close the ScanSnap setup window.

5. Select [Standard] from the Profile menu.

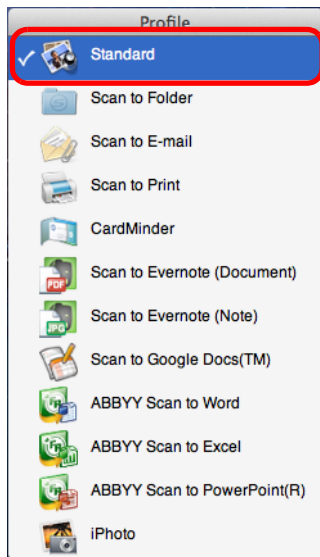

6. Load a document in the ScanSnap.

For details, refer to ["How to Load Documents"](#) (page 63).

7. Press the [Scan] button on the ScanSnap to start a scan.

⇒ The Mac OS Preview appears when the scanning is completed.



HINT

It is linked with Adobe Acrobat or Adobe Reader if either of these is installed.

Creating Scanned Images Depending on Intended Use

This section explains about various ways of using the ScanSnap.

Scanning Only One Side of a Document

By default, the ScanSnap scans in duplex mode.

To perform simplex scanning, perform the following steps to change the setting.

1. Select [Settings] from the ScanSnap Manager menu.

For details about the ScanSnap Manager menu, refer to "[ScanSnap Manager Menu \(Mac OS\)](#)" (page 39).

⇒ The ScanSnap setup window appears.

2. In the [Scanning side] pop-up menu in the [Scanning] tab, select [Simplex Scan (Single-sided)].

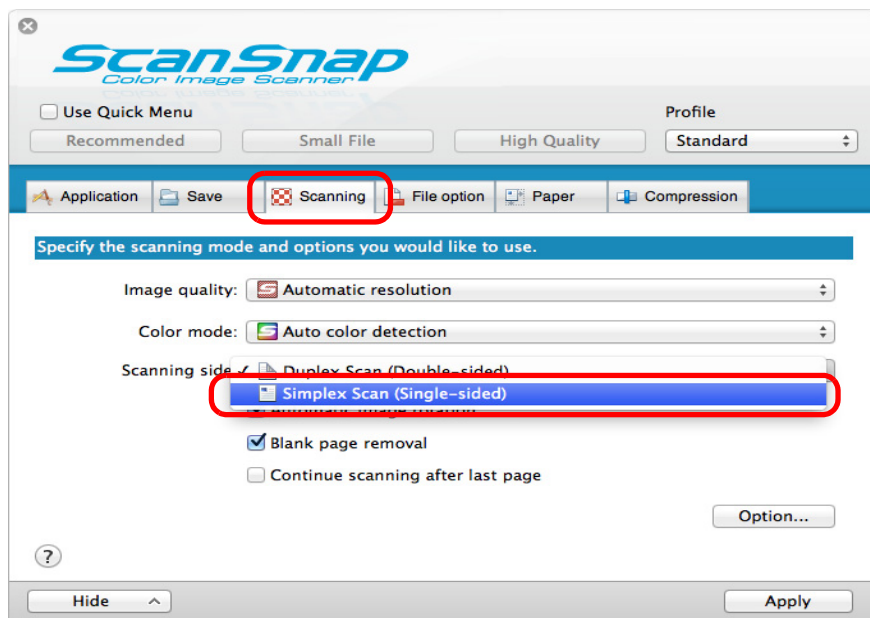

3. Click the [Apply] button in the ScanSnap setup window.

4. Click the [X] button in the upper left corner to close the ScanSnap setup window.

5. Load a document in the ScanSnap.

For details, refer to "[How to Load Documents](#)" (page 63).

6. Press the [Scan] button on the ScanSnap to start a scan.

HINT

When you select [Simplex scan] from the ScanSnap Manager menu, scanning is performed in simplex mode even if [Duplex Scan (Double-sided)] is specified for [Scanning side] in the [Scanning] tab.

⇒ Image data of the scanned side of the document is saved.

Scanning Color Documents in Gray or Black & White

When [Auto color detection] is specified for [Color mode] in the [Scanning] tab of the ScanSnap setup window, ScanSnap Manager automatically recognizes whether the scanned document is color, gray or black & white, and saves documents in their respective color modes.

If you want to scan color documents and save them in gray or black & white, change the settings in the following procedure.

1. Select [Settings] from the ScanSnap Manager menu.

For details about the ScanSnap Manager menu, refer to "[ScanSnap Manager Menu \(Mac OS\)](#)" (page 39).

⇒ The ScanSnap setup window appears.

2. In [Color mode] pop-up menu in the [Scanning] tab, select [Gray] or [B&W].

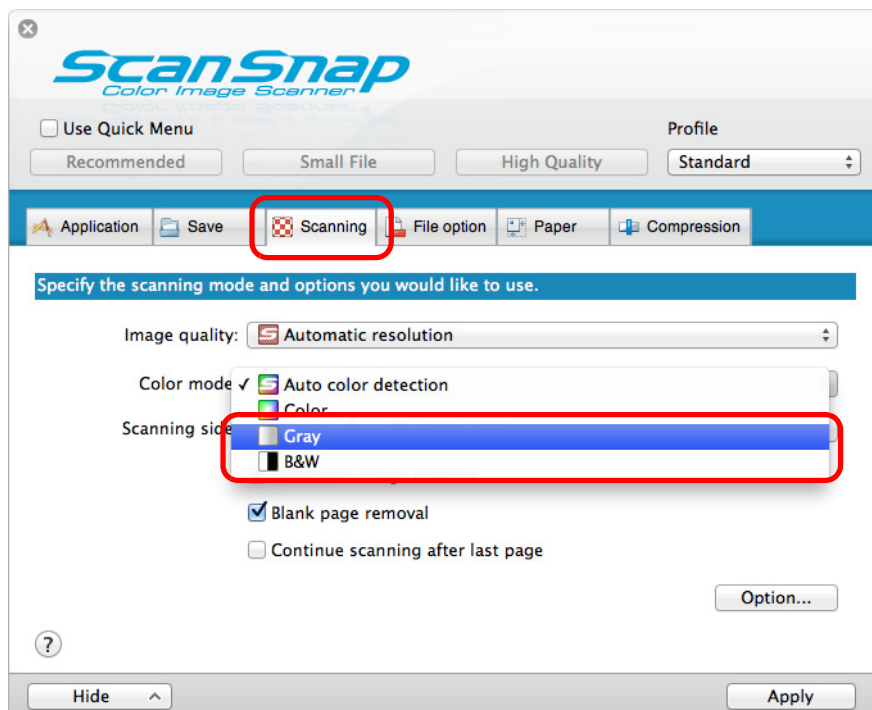

3. Click the [Apply] button.

4. Click the [] button in the upper left corner to close the ScanSnap setup window.

5. Load a document in the ScanSnap.

For details, refer to ["How to Load Documents" \(page 63\)](#).

6. Press the [Scan] button on the ScanSnap to start a scan.

⇒ Scanned image is saved in gray or black & white.

Deleting Blank Pages

The ScanSnap can detect and automatically delete blank pages from a scanned image. For example, when you scan a mixed batch of double-sided and single-sided documents in duplex mode, the images are generated without the back sides of the single-sided documents (blank pages).

To delete blank pages, perform the following steps to change the setting.

ATTENTION

- The following documents may be detected as blank.
 - Almost blank documents with only a few characters
 - Documents of only one color (including black) and without any patterns, lines or charactersWhen you scan such documents, clear the [Blank page removal] checkbox. Also make sure to check the image data for accidentally deleted pages when discarding the scanned document.
- Blank pages are not deleted when CardMinder is used.

1. Select [Settings] from the ScanSnap Manager menu.

For details about the ScanSnap Manager menu, refer to "[ScanSnap Manager Menu \(Mac OS\)](#)" (page 39).

⇒ The ScanSnap setup window appears.

2. Select the [Blank page removal] checkbox in the [Scanning] tab.

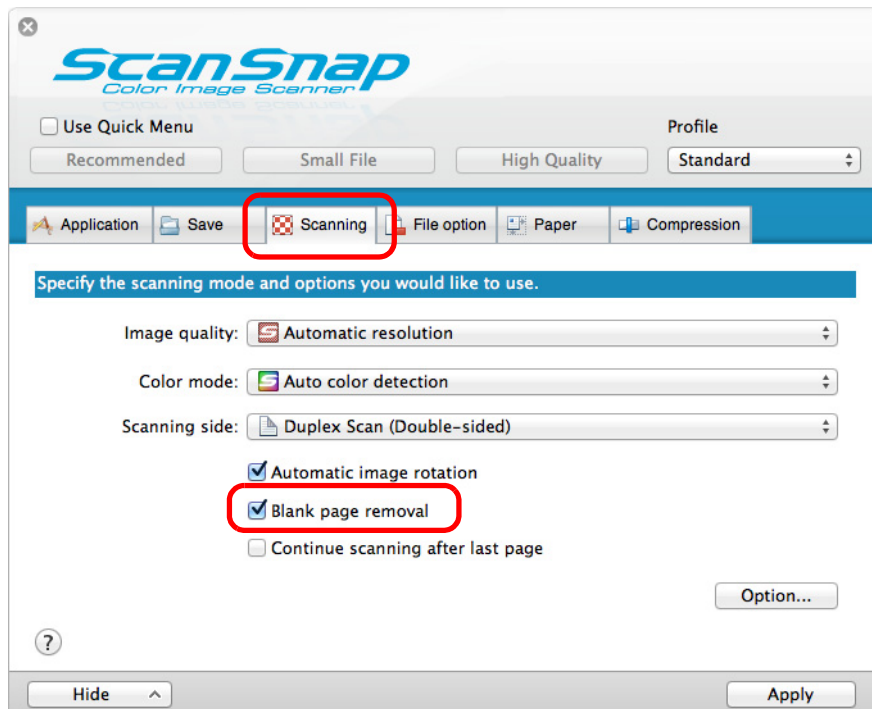

3. Click the [Apply] button in the ScanSnap setup window.

4. Click the [X] button in the upper left corner to close the ScanSnap setup window.

5. Load a document in the ScanSnap.

For details, refer to ["How to Load Documents"](#) (page 63).

6. Press the [Scan] button on the ScanSnap to start a scan.

⇒ Scanned image is saved without any blank pages.

Correcting Skewed Character Strings

When documents with skewed character strings are scanned, the ScanSnap is able to detect the skewed character strings and correct them.

To correct skewed character strings, change the settings in the following procedure.

ATTENTION

- Up to ± 5 degrees of skew can be corrected.
- Since this option is performed assuming that the document contains a certain amount of text, character strings may be adjusted at a wrong angle when scanning the following types of documents. In that case, clear the [Deskew by text on document] checkbox:
 - Documents on which pitches between lines or characters are extremely narrow, or characters are overlapped
 - Documents with many outlined or decorated characters
 - Documents with many photographs or figures and few characters
 - Documents with characters on a patterned background
e.g. Characters overlapping illustrations and diagrams
 - Documents with characters printed in various directions such as drawings
 - Documents with long diagonal lines
 - Documents including handwritten characters
- Skewed character strings are not corrected if scanning with the Carrier Sheet.

HINT

You do not have to enable [Deskew by text on document] when [Automatic detection] is specified for [Paper size] in the [Paper] tab of the ScanSnap setup window because the skewed image is always corrected when documents are scanned by this setting.

1. Select [Settings] from the ScanSnap Manager menu.

For details about the ScanSnap Manager menu, refer to "[ScanSnap Manager Menu \(Mac OS\)](#)" (page 39).

⇒ The ScanSnap setup window appears.

2. Click the [Option] button in the [Scanning] tab.

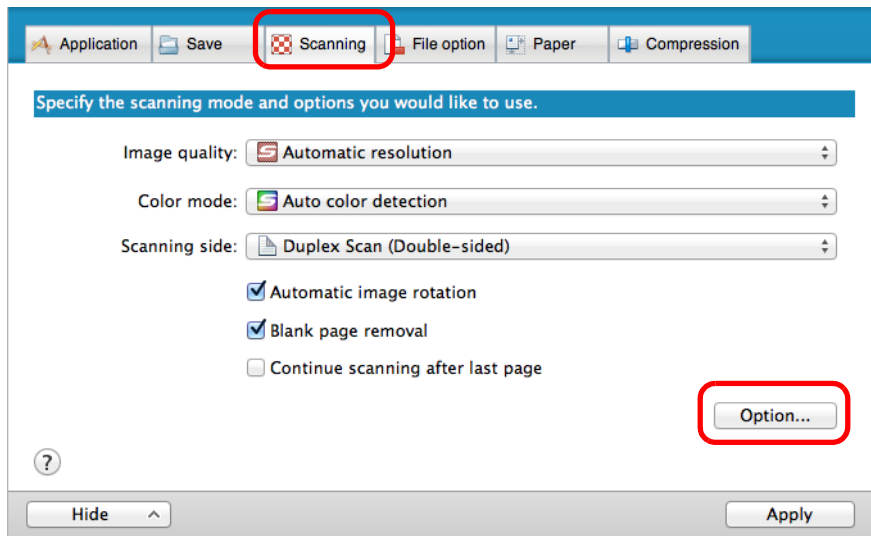

⇒ The [Scanning mode option] window appears.

3. Select the [Deskew by text on document] checkbox.

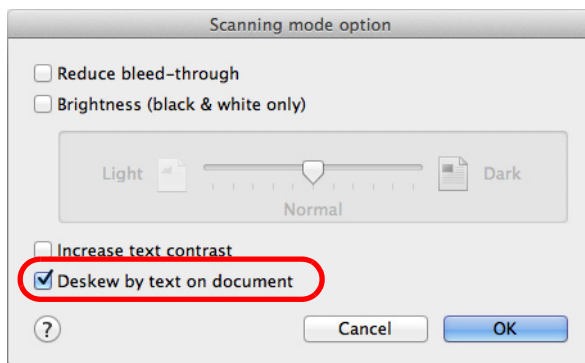

4. Click the [OK] button to close the [Scanning mode option] window.

5. Click the [Apply] button in the ScanSnap setup window.

6. Click the [X] button in the upper left corner to close the ScanSnap setup window.

7. Load a document in the ScanSnap.

For details, refer to ["How to Load Documents"](#) (page 63).

8. Press the [Scan] button on the ScanSnap to start a scan.

⇒ Scanned image is saved with skewed character strings corrected.

Rotating Scanned Image to its Correct Orientation

In an office environment, it is often the case that a single batch contains same size documents of different page orientations.

The ScanSnap is able to automatically rotate each scanned image to its correct orientation for such document batches.

To rotate scanned images to their correct orientations, change the settings in the following procedure.

ATTENTION

Since this option determines the document's page orientation based on the character strings printed on the document, the following types of documents may not be rotated.

In that case, clear the [Automatic image rotation] checkbox:

- Documents with many extremely large or small characters
- Documents on which pitches between lines or characters are extremely narrow, or characters are overlapped
- Documents with many characters contacting underlines or borders
- Documents with many photographs or figures and few characters
- Documents with characters on an unevenly colored background
e.g. Shaded characters
- Documents with many decorated characters
e.g. Decorated characters (embossed/outlined)
- Documents with characters on a patterned background
e.g. Characters overlapping illustrations and diagrams
- Documents with characters printed in various directions such as drawings
- Documents written using only capital letters
- Documents including handwritten characters
- Skewed documents
- Documents written in an unsupported language (language other than Japanese/English/ French/ German/Italian/Spanish/Russian/Portuguese)
- Documents with complex layouts
- Documents with a large amount of image noise
- Documents with faint characters
- Documents with faded characters

1. Select [Settings] from the ScanSnap Manager menu.

For details about the ScanSnap Manager menu, refer to "[ScanSnap Manager Menu \(Mac OS\)](#)" (page 39).

⇒ The ScanSnap setup window appears.

2. Select the [Automatic image rotation] checkbox in the [Scanning] tab.

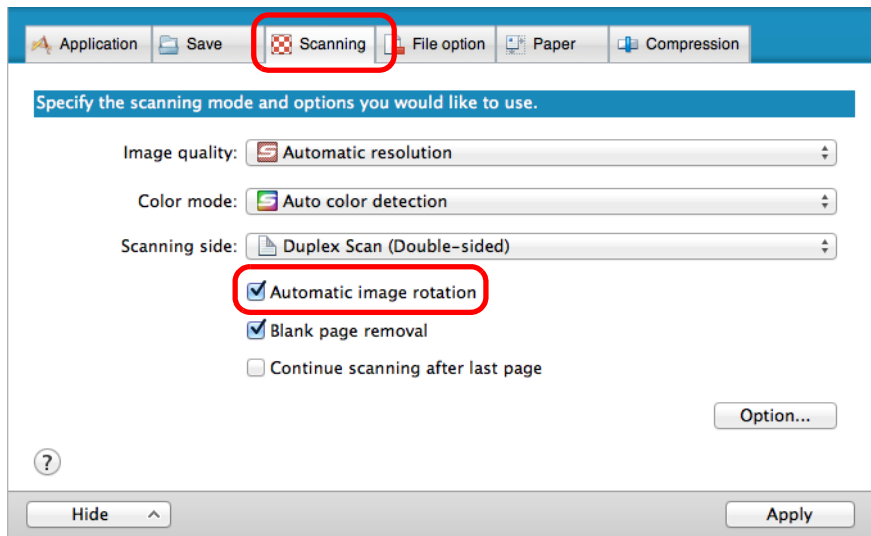

3. Click the [Apply] button in the ScanSnap setup window.

4. Click the [X] button in the upper left corner to close the ScanSnap setup window.

5. Load a document in the ScanSnap.

For details, refer to ["How to Load Documents" \(page 63\)](#).

6. Press the [Scan] button on the ScanSnap to start a scan.

⇒ The scanned image is saved in correct orientation.

Reducing Bleed-Through

You can reduce the bleed-through that appears in the scanned image when there is text or illustration on the back side of the document.

To reduce bleed-through, perform the following steps to change the setting.

ATTENTION

For documents like the following, bleed-through reduction may not function effectively. In that case, clear the [Reduce bleed-through] checkbox.

- Documents with light colored letters or pictures / documents with thin letters or lines / documents with a dark background color
The color may not be reproduced or the color may be changed. If you want to recognize the marked character strings, the recognition rate for the characters may be lowered.
- Documents where the color for letters is light or the letters are thin
The recognition rate for the characters may be lowered.
- Documents with a lot of bleed-through
The bleed-through may be emphasized.

1. Select [Settings] from the ScanSnap Manager menu.

For details about the ScanSnap Manager menu, refer to "[ScanSnap Manager Menu \(Mac OS\)](#)" (page 39).

⇒ The ScanSnap setup window appears.

2. Click the [Option] button in the [Scanning] tab.

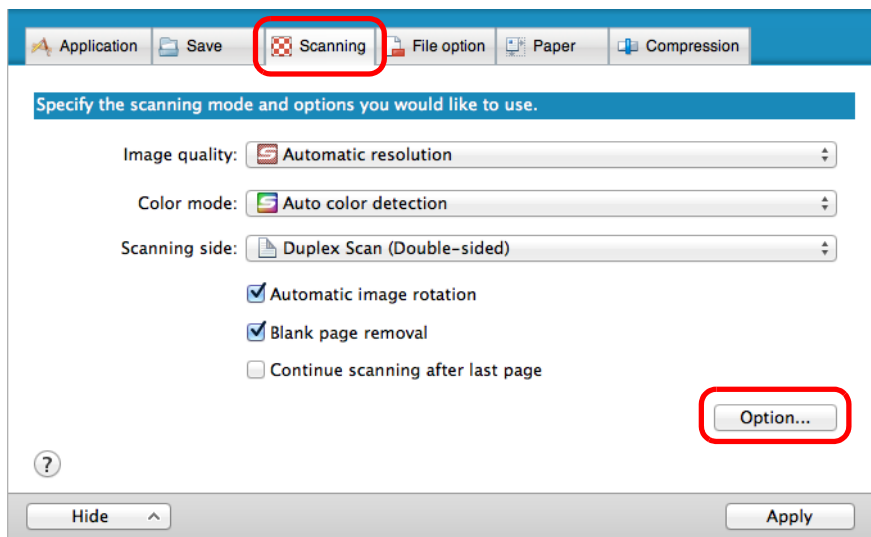

⇒ The [Scanning mode option] window appears.

3. Select the [Reduce bleed-through] checkbox.

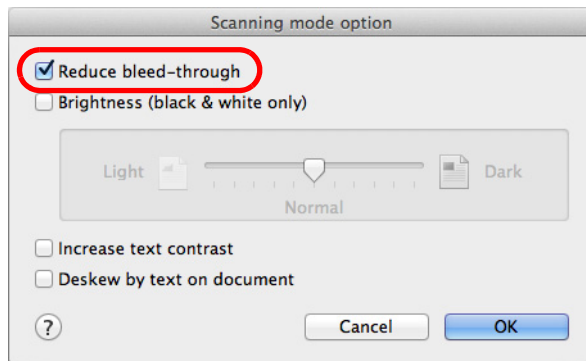

⇒ The following message appears.

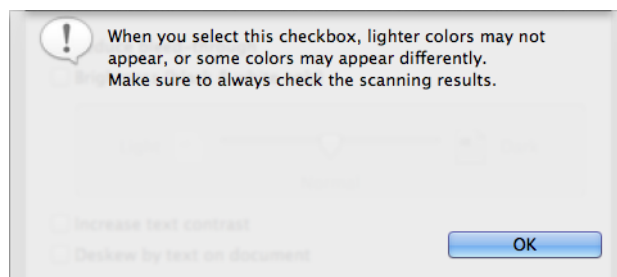

4. Click the [OK] button to close the message.

5. Click the [OK] button to close the [Scanning mode option] window.

6. Click the [Apply] button in the ScanSnap setup window.

7. Click the [✕] button in the upper left corner to close the ScanSnap setup window.

8. Load a document in the ScanSnap.

For details, refer to ["How to Load Documents"](#) (page 63).

9. Press the [Scan] button on the ScanSnap to start a scan.

⇒ The scanned image is saved with reduced bleed-through.

Scanning Documents of Different Widths or Lengths in One Batch

You can scan documents of different widths or lengths in one batch.

To scan documents of different widths or lengths in one batch, change the settings in the following procedure.

1. Select [Settings] from the ScanSnap Manager menu.

For details about the ScanSnap Manager menu, refer to "[ScanSnap Manager Menu \(Mac OS\)](#)" (page 39).

⇒ The ScanSnap setup window appears.

2. In the [Paper] tab, select [Automatic detection] in [Paper size].

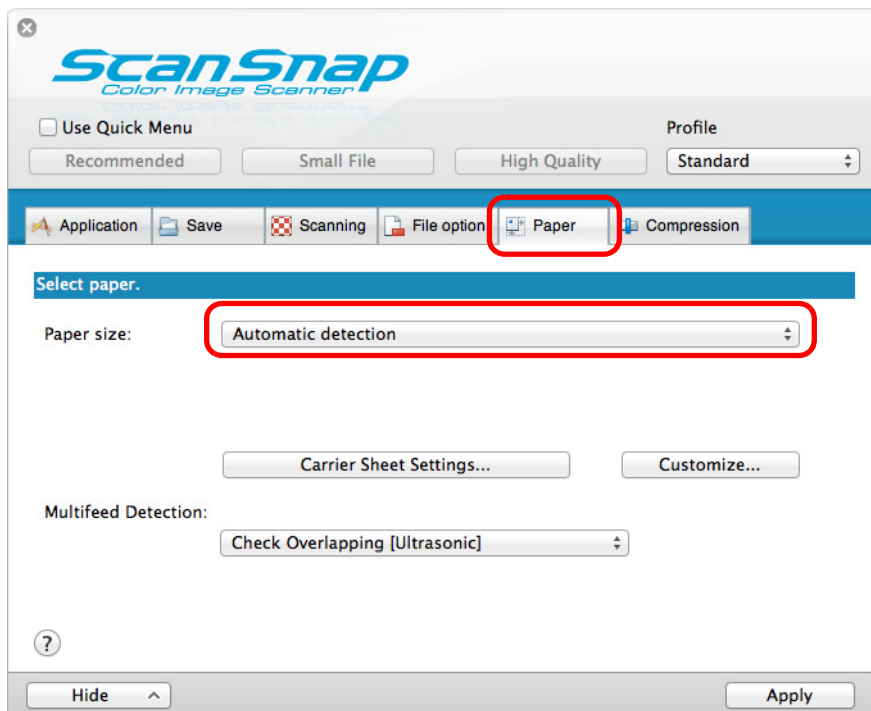

3. Select [None] in [Multifeed Detection] pop-up menu.

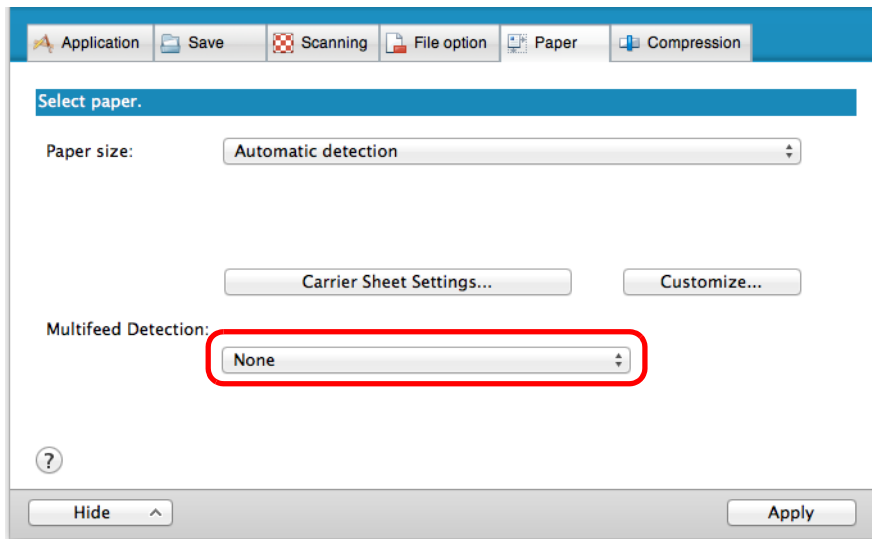

ATTENTION

If you scan documents of different widths or lengths in one batch with [Check Length] selected, documents will be detected as multifeeds and scanning cannot be performed. Note that scanning Letter and A4 size documents in the same batch does not result in multifeed detection.

4. Click the [Apply] button in the ScanSnap setup window.

5. Click the [✕] button in the upper left corner to close the ScanSnap setup window.

6. Load documents in the ScanSnap.

1. Align the edges of the documents.

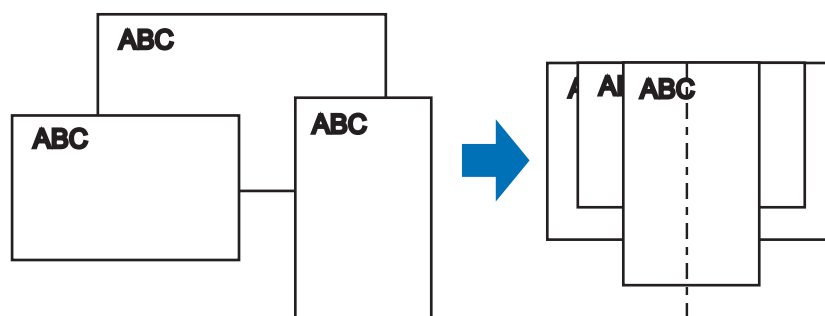

2. Place the documents at the center of the ADF paper chute.

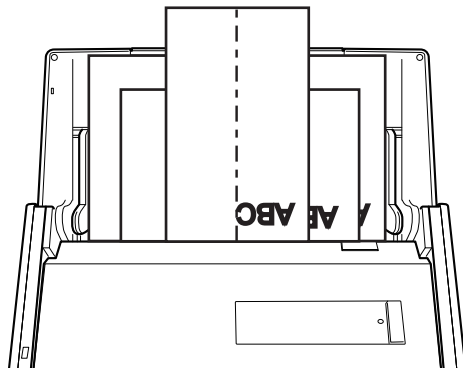

ATTENTION

- Make sure that all documents are placed above the pick roller. Otherwise, some documents will not be picked.

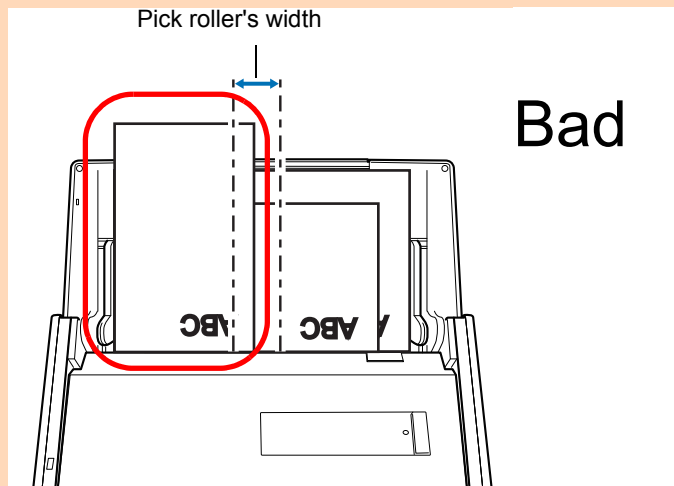

- Adjust the side guides to the widest document in the batch.
- Carefully load small documents that cannot reach the side guides straight into the ADF paper chute (cover). If the documents are skewed during scanning, the quality of scanned image data may be degraded (partly lost image data/slant lines produced) or scanned image data may be output in a different size than the original. If you have difficulties in scanning the documents straight, it is recommended to scan documents in several batches, documents of the same width being in the same batch, and enable continuous scanning.
- Note that documents that cannot be guided by the side guides may cause paper jams.

7. Press the [Scan] button on the ScanSnap to start a scan.

⇒ Scanned images are saved in the original document sizes.

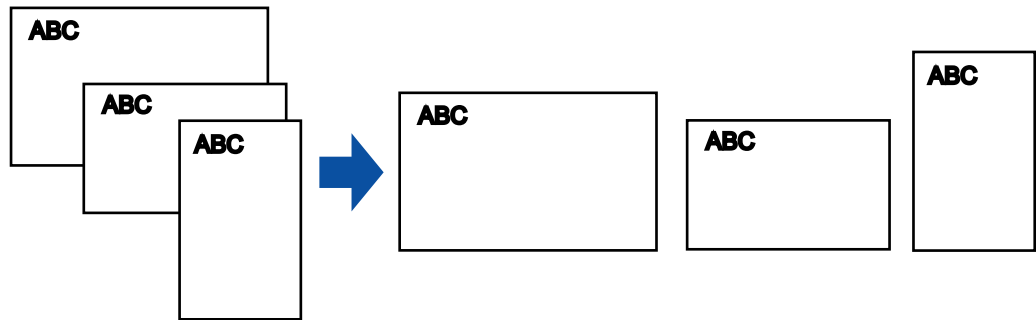

ATTENTION

If the documents are scanned skewed, the images may not be output in their original sizes.

Scanning Documents Larger Than A4/Letter Size

You can scan documents larger than A4/Letter size such as A3, 11 × 17 in. and B4 size using the Carrier Sheet. By folding the document in half and scanning in duplex mode, the two sides are merged into a single image.

ATTENTION

The [Deskew by text on document] checkbox ([Scanning] tab → [Option] in the ScanSnap setup window) will be disabled.

HINT

You can also scan documents smaller than A4/Letter size and have both sides saved as a single image.

1. Select [Settings] from the ScanSnap Manager menu.

For details about the ScanSnap Manager menu, refer to "[ScanSnap Manager Menu \(Mac OS\)](#)" (page 39).

⇒ The ScanSnap setup window appears.

2. In the [Paper] tab, select [Automatic detection] in [Paper size], and then click the [Carrier Sheet Settings] button.

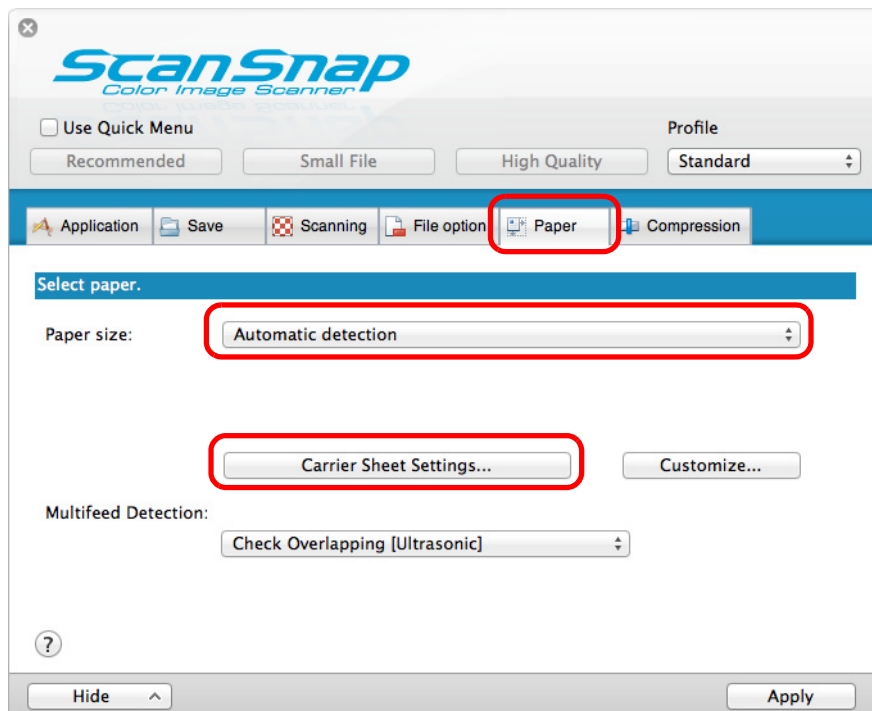

⇒ The [Carrier Sheet Settings] window appears.

3. Select [one double-page spread image] in [Save as] and click the [OK] button.

For details about the Carrier Sheet settings, refer to the ScanSnap Manager Help.

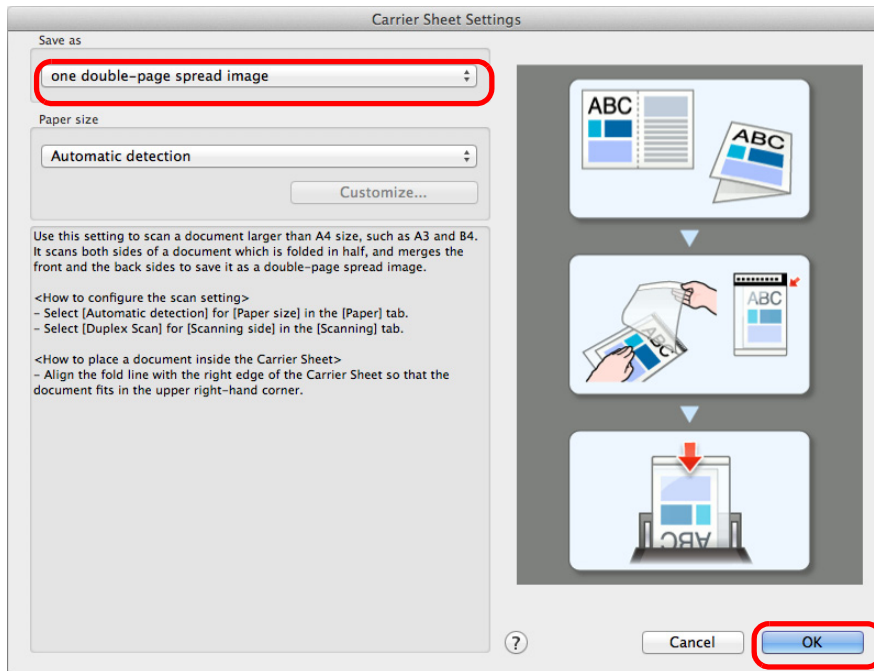

4. In the [Scanning side] pop-up menu in the [Scanning] tab, select [Duplex Scan (Double-sided)] and click the [Apply] button.

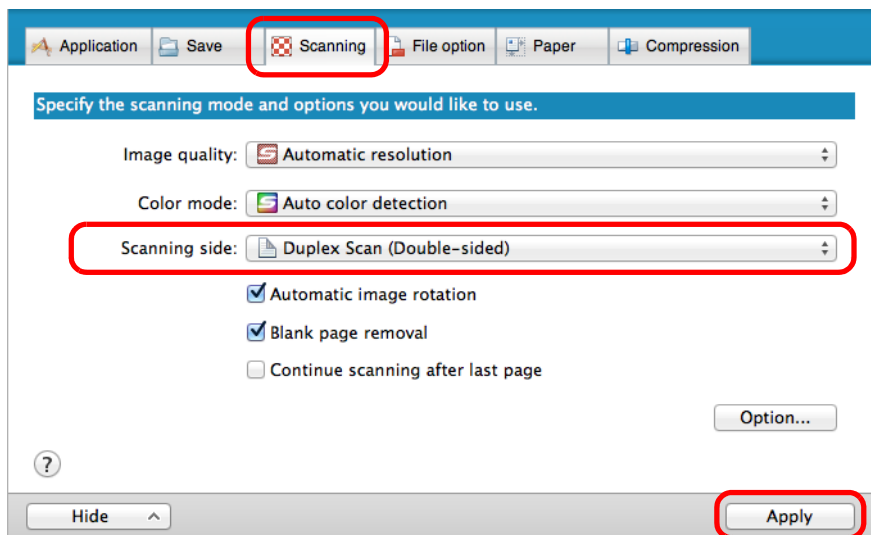

ATTENTION

If [Simplex Scan (Single-sided)] is specified for [Scanning side] in the [Scanning] tab, the ScanSnap outputs the same result as performing a simplex scan in [two separate images (front and back)] mode.

5. Click the [Apply] button in the ScanSnap setup window.
6. Click the [X] button in the upper left corner to close the ScanSnap setup window.
7. Place the document inside the Carrier Sheet.

1. Fold the document in half so that the sides to be scanned are facing out. Fold it tightly and smooth out any creases.

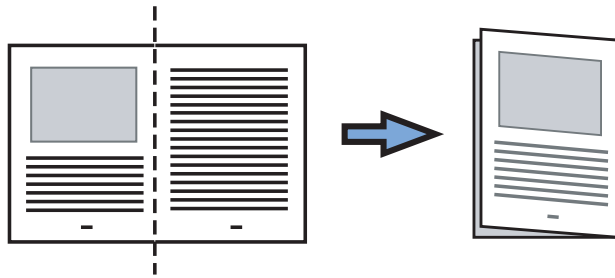

2. Open the Carrier Sheet to bind the document.

Align the fold line with the right edge of the Carrier Sheet so that the document fits in the upper right-hand corner of the Carrier Sheet.

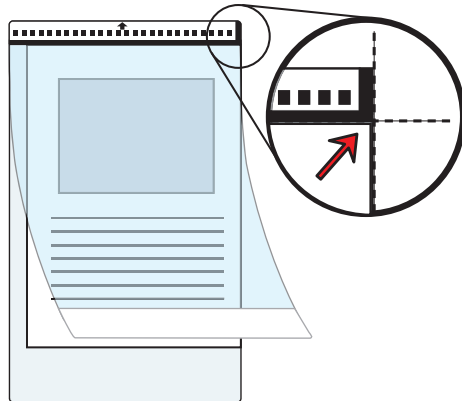

HINT

Note that the front side of the Carrier Sheet has a thick vertical line in the upper right-hand corner.

8. Place the end with the black and white pattern as the leading edge in the direction of the arrow.

Secure the Carrier Sheet with the side guides to avoid skewing.

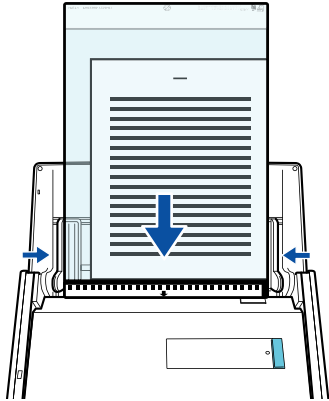

9. Press the [Scan] button on the ScanSnap to start a scan.

⇒ Both sides of the document are scanned and saved as one double-page spread image.

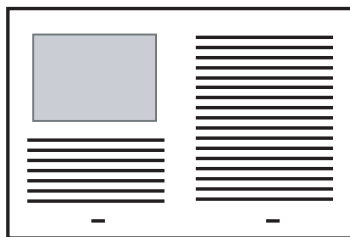

ATTENTION

- There may be a line or a gap appearing between the front and back side images.
Also when you scan thick papers, images on both left and right may skew towards each other from the top.
These symptoms may be improved when you perform the following:
 - Fold the document properly
 - Neatly align the edges of the document with the edges of the Carrier Sheet when placing the document inside the Carrier Sheet
- If [Automatic detection] is specified for [Paper size] in the [Carrier Sheet Settings] window, an optimal size will be selected automatically from the available standard sizes (A3, B4 or 11 × 17 in.) from the same pop-up menu. Note that the size of the image may become smaller than the original document depending on the document.
Example:
When you scan an A3 size document whose content is printed to fit A4 size in the center, the image data is output in B4 size.
To output the scanned image in its original size, specify the document size in the [Paper size] pop-up menu.
- Part of the image data around where the document is folded may appear missing. In that case, set the document so that its edge is about 1 mm inside from the edge of the Carrier Sheet.

Scanning Documents Such as Photographs and Clippings

Using the Carrier Sheet allows you to scan documents that can be damaged quite easily such as photographs, or non-standard size documents that are difficult to load directly such as clippings.

Change the settings to scan documents such as photographs and clippings in the following procedure.

ATTENTION

The [Deskew by text on document] checkbox ([Scanning] tab → [Option] in the ScanSnap setup window) will be disabled.

1. Select [Settings] from the ScanSnap Manager menu.

For details about the ScanSnap Manager menu, refer to "[ScanSnap Manager Menu \(Mac OS\)](#)" (page 39).

⇒ The ScanSnap setup window appears.

2. In the [Paper] tab, select [Automatic detection] in [Paper size], and then click the [Carrier Sheet Settings] button.

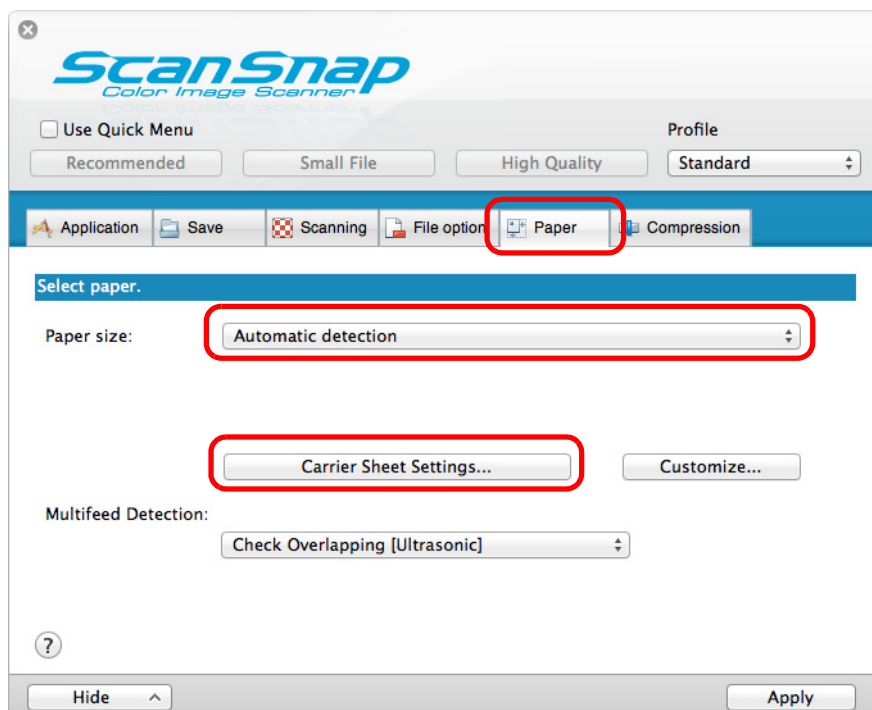

⇒ The [Carrier Sheet Settings] window appears.

3. Select [two separate images (front and back)] in [Save as] and click the [OK] button.

For details about the Carrier Sheet settings, refer to the ScanSnap Manager Help.

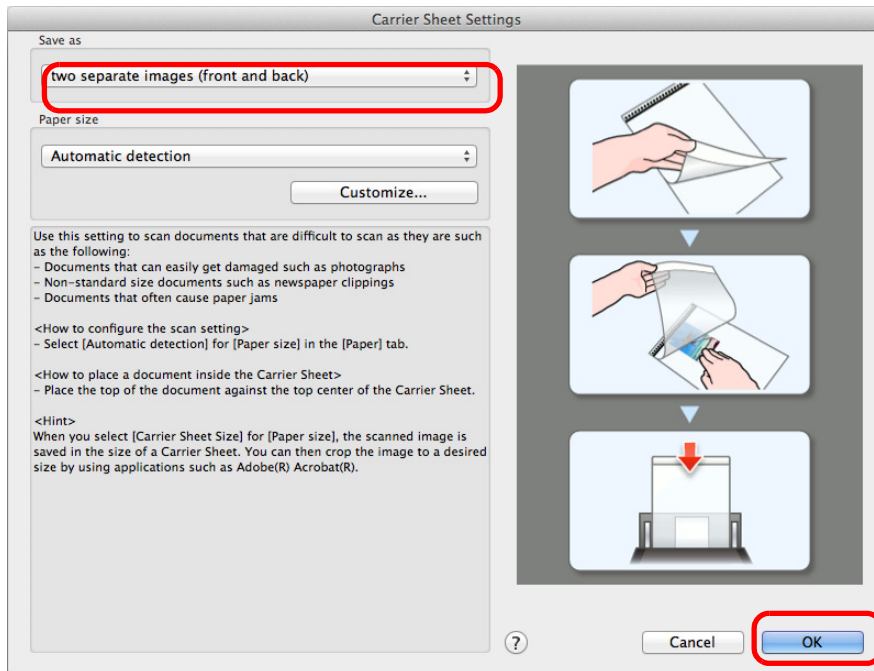

4. Click the [Apply] button in the ScanSnap setup window.
5. Click the [X] button in the upper left corner to close the ScanSnap setup window.
6. Place the document inside the Carrier Sheet.

Open the Carrier Sheet and place the top of the document against the top center of the Carrier Sheet.

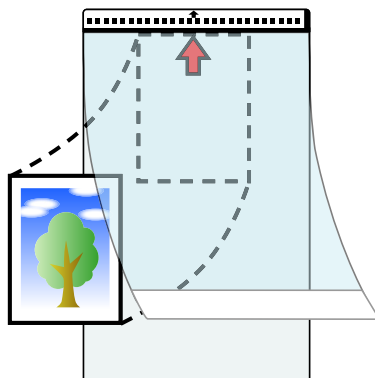

7. Place the end with the black and white pattern as the leading edge in the direction of the arrow.

Set the back side of the document facing towards you.

Secure the Carrier Sheet with the side guides to avoid skewing.

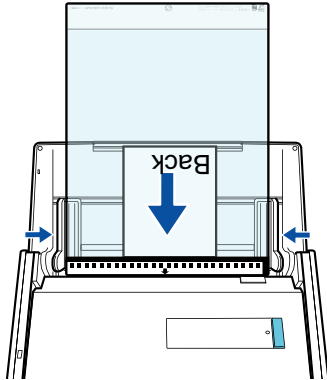

8. Press the [Scan] button on the ScanSnap to start a scan.

⇒ Scanned image is saved.

ATTENTION

- The scanned image is output at the center of the page in the size specified in the [Paper size] pop-up menu of the [Carrier Sheet Settings] window.
- If [Automatic detection] is specified for [Paper size] in the [Carrier Sheet Settings] window, an optimal size will be selected automatically from the available standard sizes (A3, B4 or 11 × 17 in.) from the same pop-up menu. Note that the size of the image may become smaller than the original document depending on the document scanned, or part of the image may appear missing.

Example:

When an A5 size image is printed in the center of an A4 size document, the image is output in A5 size.

To output the scanned image in its original size, specify the document size in the [Paper size] pop-up menu.

HINT

In the following cases, place a blank (white) sheet of paper underneath the document when scanning:

- The scanned image is not saved in the correct size (when [Automatic detection] is selected in the [Paper size] pop-up menu of the [Carrier Sheet Settings] window)
- Shadows appear around the edges of the scanned image
- Black lines appear around the edges of a uniquely shaped cutting

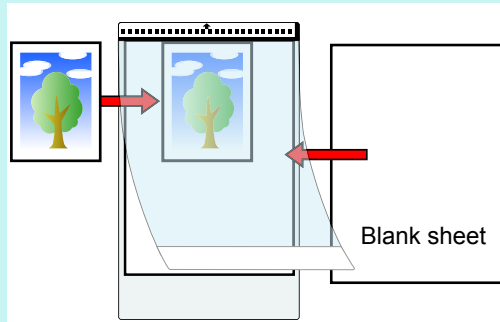

Long Page Scanning

Documents up to 863 mm (34 in.) in length can be scanned.
The following explains how to scan long pages.

1. Load a document in the ScanSnap.

For details about documents that can be loaded, refer to ["Documents for Scanning" \(page 58\)](#).

ATTENTION

- Long page documents should be loaded one sheet at a time in the ADF paper chute (cover).
- When you scan long pages, take note of the following.

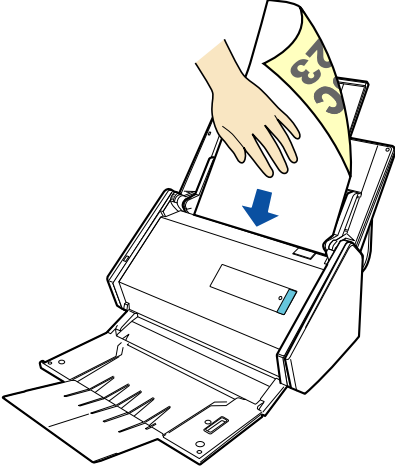
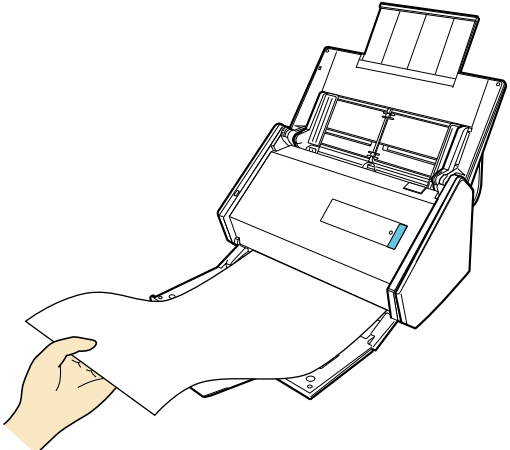
Loading	Ejecting
<p>Hold the document with your hands so that it does not fall out of the ADF paper chute (cover).</p> 	<p>Secure enough space where the documents are ejected from the ScanSnap, and pick up the documents with your hands to prevent them from falling off the unit where the ScanSnap is placed on.</p> 

2. Press the [Scan] button on the ScanSnap for 3 seconds or longer until it flashes in blue.

⇒ Scanning starts.

HINT

When you scan the first page as a long page and continue scanning, the next document is also scanned as long page.

ATTENTION

- When [Excellent] is selected in the [Image quality] pop-up menu of the [Scanning] tab in the ScanSnap setup window, the window below appears and long page scanning is disabled.

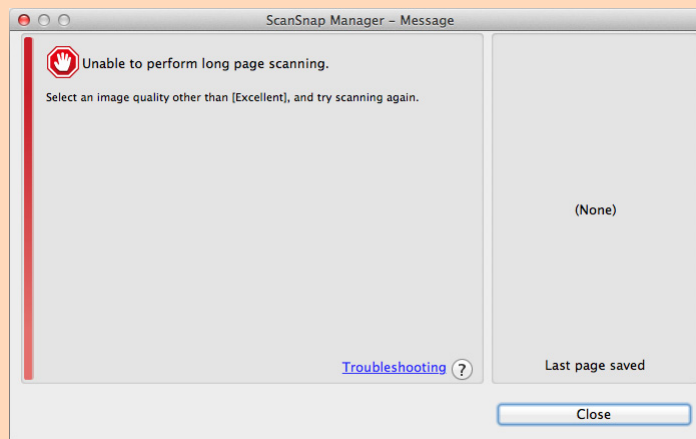

- When you perform a long page scan, the current settings are ignored and the following settings are used:
 - Multifeed Detection: None
 - Paper size: Automatic detection

Saving Scanned Images in Multiple PDF Files

The ScanSnap is able to save scanned image in separate PDF files based on the specified number of pages. For example, you can scan a batch of slips, and save each slip as a PDF file.

To save image data in multiple PDF files, change the settings in the following procedure.

1. Select [Settings] from the ScanSnap Manager menu.

For details about the ScanSnap Manager menu, refer to ["ScanSnap Manager Menu \(Mac OS\)" \(page 39\)](#).

⇒ The ScanSnap setup window appears.

2. In the [File format] pop-up menu in the [File option] tab, select [PDF (*.pdf)], and then click the [Option] button.

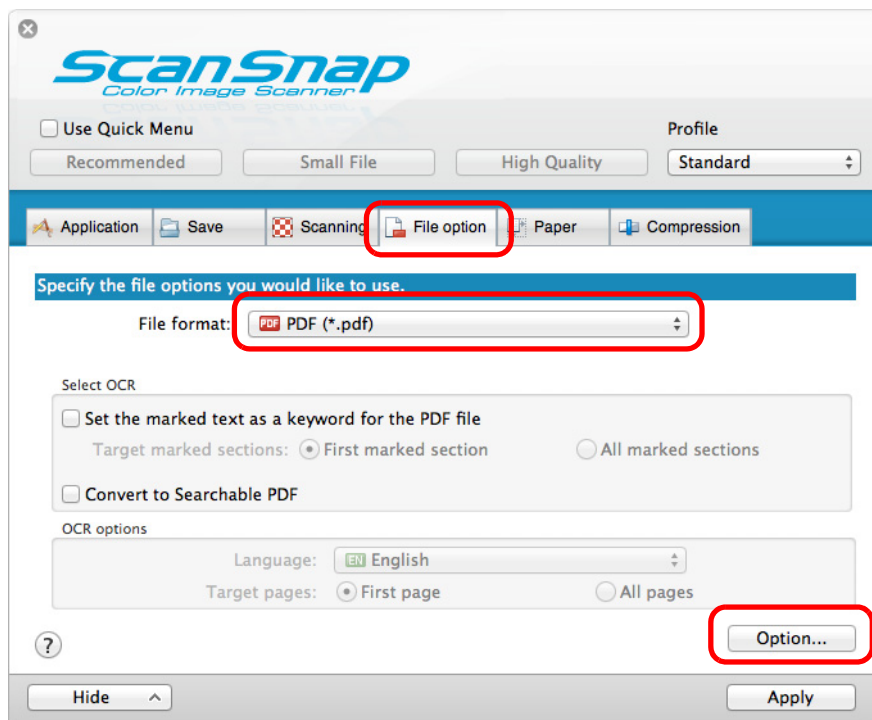

⇒ The [PDF file format option] window appears.

3. Select [Generate one PDF file per (n) page(s)] and enter the number of pages to split.

One PDF is created every time the number of pages specified here has been saved.

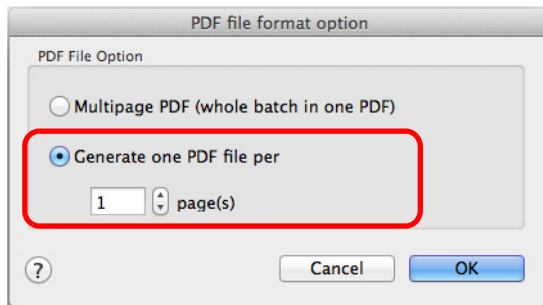

HINT

In duplex mode, two pages (front/back) are created per document.

When you select the [Blank page removal] checkbox in the [Scanning] tab, the number of pages of the original document and the scanned image does not match because blank pages are deleted.

Clear this checkbox when you want to keep the original page number order.

4. Click the [OK] button to close the [PDF file format option] window.

5. Click the [Apply] button in the ScanSnap setup window.

6. Click the [✕] button in the upper left corner to close the ScanSnap setup window.

7. Load a document in the ScanSnap.

For details, refer to "[How to Load Documents](#)" (page 63).

8. Press the [Scan] button on the ScanSnap to start a scan.

⇒ One PDF file is created every time the number of pages specified in step 3. has been scanned.

Creating Searchable PDF Files

The ScanSnap is able to perform text recognition on a scanned image automatically and create a searchable PDF file.

HINT

Searchable PDF files can also be created by using [Searchable PDF Converter]. You can also use [Searchable PDF Converter] later to convert files that were created with the ScanSnap to searchable PDF files. The process can be performed when your computer is idle, which allows you to efficiently create multiple searchable PDF files. For details, refer to "[Creating Searchable PDF Files](#)" (page 308).

To create searchable PDF files, change the settings in the following procedure.

1. Select [Settings] from the ScanSnap Manager menu.

For details about the ScanSnap Manager menu, refer to "[ScanSnap Manager Menu \(Mac OS\)](#)" (page 39).

⇒ The ScanSnap setup window appears.

2. In the [File format] pop-up menu in the [File option] tab, select [PDF (*.pdf)].

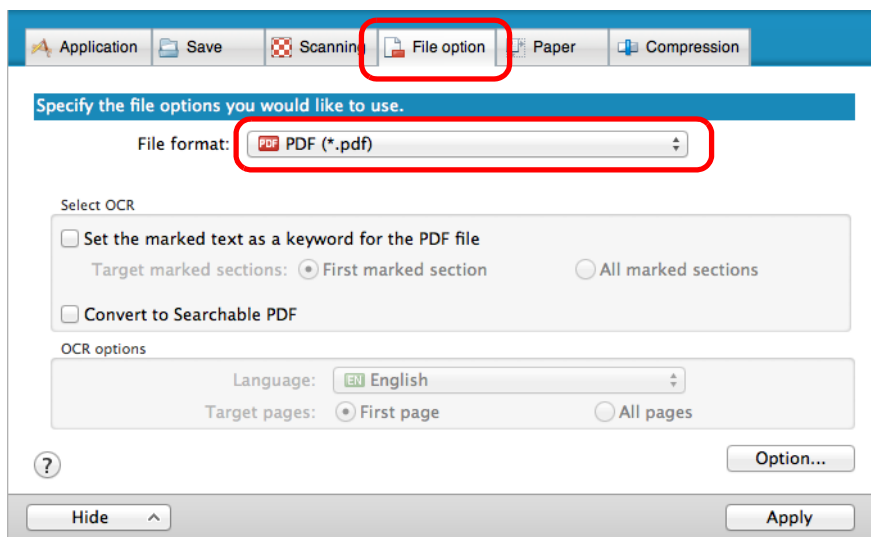

HINT

It is recommended that you select [Better] or [Best] for [Image quality] in the [Scanning] tab of the ScanSnap setup window.

3. Select the [Convert to Searchable PDF] checkbox.

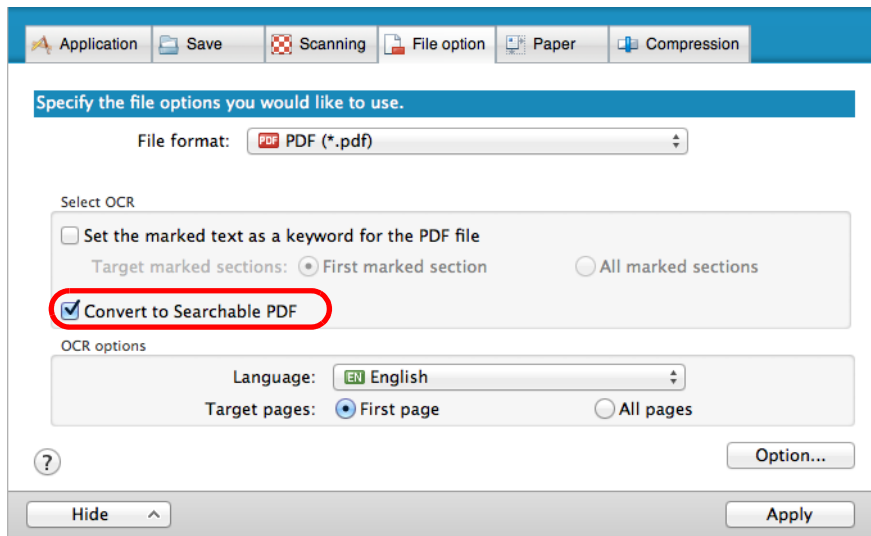

⇒ The following message appears.

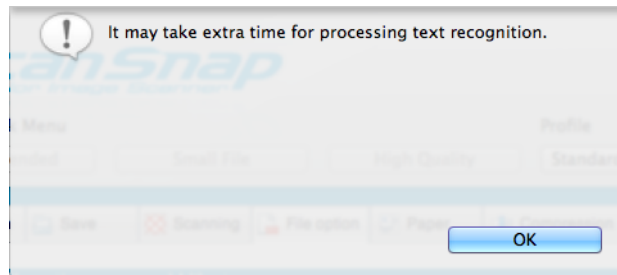

4. Click the [OK] button to close the message.

5. Specify the text recognition option.

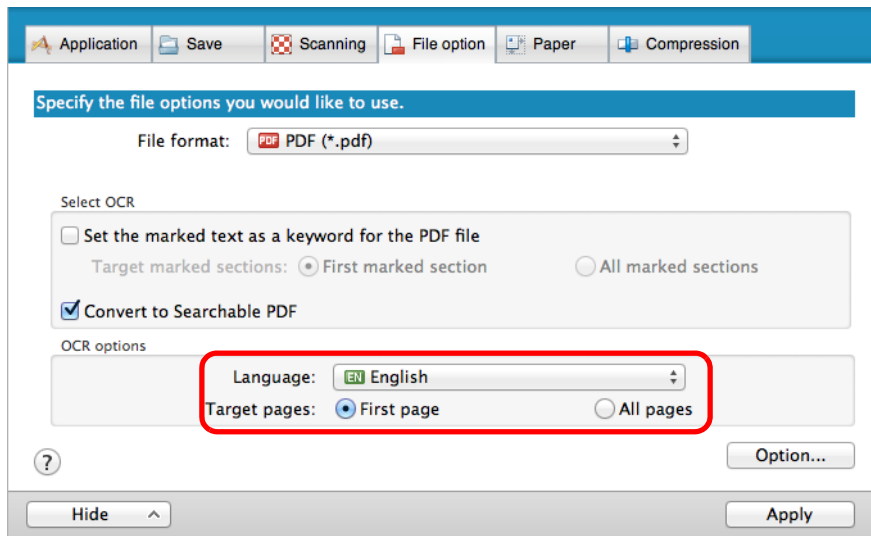

- Language
Select the language. Japanese, English, French, German, Italian, Spanish, Chinese (simplified), Chinese (traditional), Korean, Russian, and Portuguese can be selected.
- Target pages
Select [All pages] to perform text recognition for all pages and [First page] for just the first page.

6. Click the [Apply] button in the ScanSnap setup window.

7. Click the [✕] button in the upper left corner to close the ScanSnap setup window.

8. Load a document in the ScanSnap.

For details, refer to ["How to Load Documents" \(page 63\)](#).

9. Press the [Scan] button on the ScanSnap to start a scan.

⇒ Text recognition is performed on the scanned image and a searchable PDF file is created.

ATTENTION

- It may take extra time to process text recognition depending on your computer system environment when you enable this setting in step 3.
- Scanned images of the following types of documents (characters) may not be recognized correctly.
In that case, better results in text recognition may be achieved by changing the setting for [Color mode] or specifying a higher resolution in [Image quality].
 - Documents including handwritten characters
 - Documents with small characters scanned at a low resolution
 - Skewed documents
 - Documents written in languages other than the specified language
 - Documents including texts written in italic characters
 - Documents containing characters with superscripts/subscripts and complicated mathematical expressions
 - Documents with characters on an unevenly colored background
e.g. Shaded characters
 - Documents with many decorated characters
e.g. Decorated characters (embossed/outlined)
 - Documents with characters on a patterned background
e.g. Characters overlapping illustrations and diagrams
 - Documents with many characters contacting underlines or borders
- It may take extra time to perform text recognition on the following documents:
 - Documents with complex layouts
 - Documents with information other than text
e.g. Text on a shaded background
- If bleed-through reduction is enabled, the recognition rate may be lowered. In that case, disable it in the following procedure.
Select [Settings] → [Scanning] tab → [Option] button from the ScanSnap Manager menu to show the [Scanning mode option] window. Clear the [Reduce bleed-through] checkbox.
- Vertical text can be searched with Adobe Acrobat, but not with Spotlight or Preview.

Setting Keywords in PDF Files

HINT

You can convert files created with the ScanSnap to searchable PDF files by using [Searchable PDF Converter]. For details, refer to the ScanSnap Manager Help.

If the document is black & white, character strings (e.g. page heading, title) can be set as keywords and used for a PDF file search.

Mark a character string to be set as a keyword with a water-based highlight pen so that the character string is completely covered.

When you perform a scan, the marked character strings are recognized and set as keywords for the PDF file.

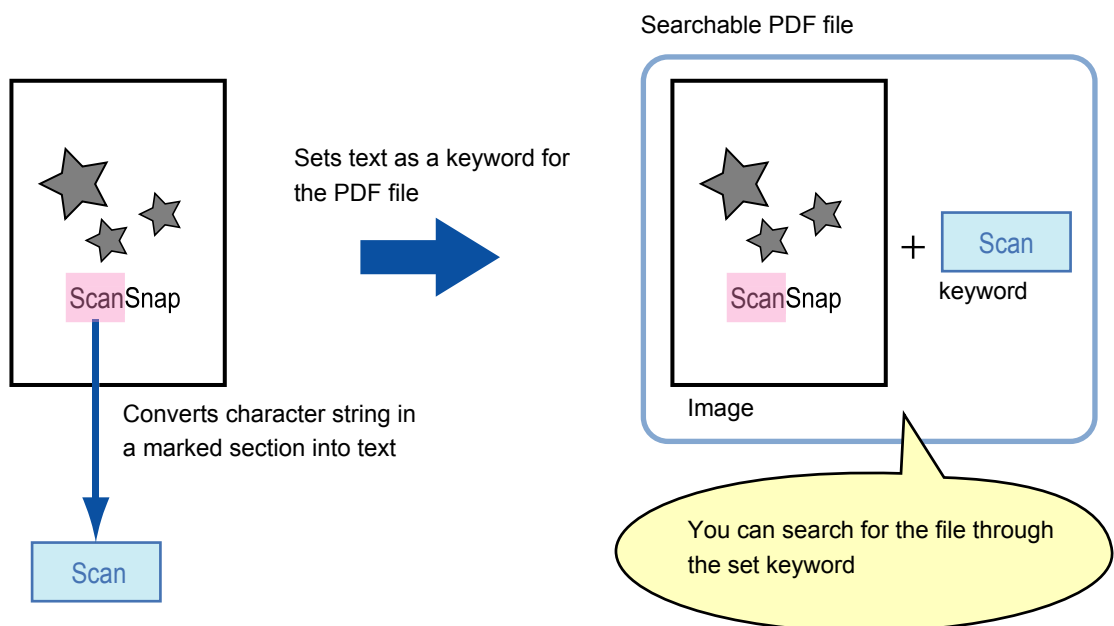

Mark black & white documents in the following way:



- Any regular highlight pen can be used.

The following shows the colors and thickness recommended for highlight pens:

Pink	Yellow	Blue	Green

- Mark a straight line over a single character string.
- The supported range of a marked section is as follows:
Minimum: 3 mm (short side) × 10 mm (long side)
Maximum: 20 mm (short side) × 150 mm (long side)
- Use only one color per page for marking.

- Make sure to cover the entire character string when marking it. Mark sections so that the entire section is evenly colored.

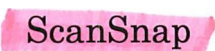
Good example:	Bad example 1: (does not cover the entire section)	Bad example 2: (unevenly colored)
		

- Do not mark more than ten sections per page.

ATTENTION

- It is recommended that you use a blue or a green highlight pen for marking. When you use colors such as pink or yellow for marking, the marked sections may not be recognized as keywords.
- Use a blue highlight pen for documents with dark background colors such as newspapers. Marked sections may not be detected when a color other than blue is used.
- For the following documents, marked sections cannot be recognized and set as keywords:
 - Color documents such as catalogues or pamphlets
 - Documents in which two or more colors are used for marking
 - Documents containing colors other than for marking (pens other than highlight pens are used or the document is stained)
 - Documents with too many marked sections on a single page
- The following types of marked character strings cannot be set as keywords:
 - The size of the marked section is outside the supported range
 - The marking is irregular (e.g. skewed)
 - Multiple marked sections are too close to each other
 - The color of the highlight pen is too pale or the color has faded

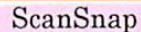

- When you mark more than one character string, make sure to leave a gap of at least 5 mm between the marked sections. Marked sections that are too close to each other may be detected as one marked section.
- In the following case, character strings surrounding marked sections may be set as keywords: Marked section overlaps the line above and below
- In the following cases, unmarked character strings may be set as keywords:
 - Color documents such as catalogues or pamphlets
 - Documents with color text, diagrams, pictures, tables and lines
 - Documents containing sections framed by a highlight pen
 - Stained documents

HINT

- Increase the resolution when you have trouble setting the keywords correctly.
- Keywords set for a PDF file can be checked [Document Properties] of Adobe Acrobat / Adobe Reader or Preview [Inspector].

Change the settings in the following procedure to automatically set keywords for PDF files.

1. Select [Settings] from the ScanSnap Manager menu.

For details about the ScanSnap Manager menu, refer to ["ScanSnap Manager Menu \(Mac OS\)" \(page 39\)](#).

⇒ The ScanSnap setup window appears.

2. In the [File format] pop-up menu in the [File option] tab, select [PDF (*.pdf)].

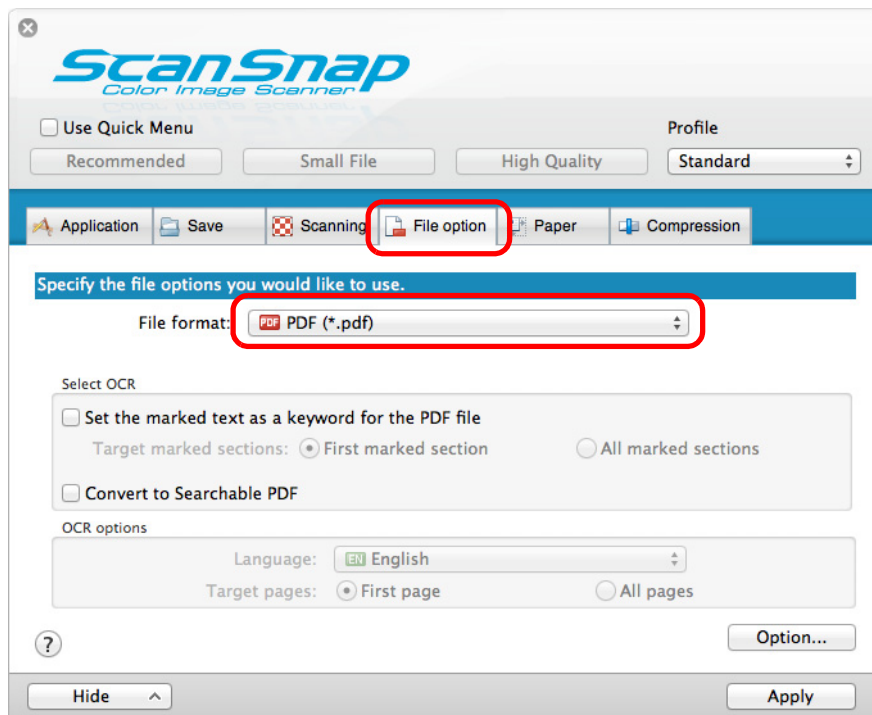

HINT

It is recommended that you select [Better] or [Best] for [Image quality] in the [Scanning] tab of the ScanSnap setup window.

3. Select the [Set the marked text as a keyword for the PDF file] checkbox.

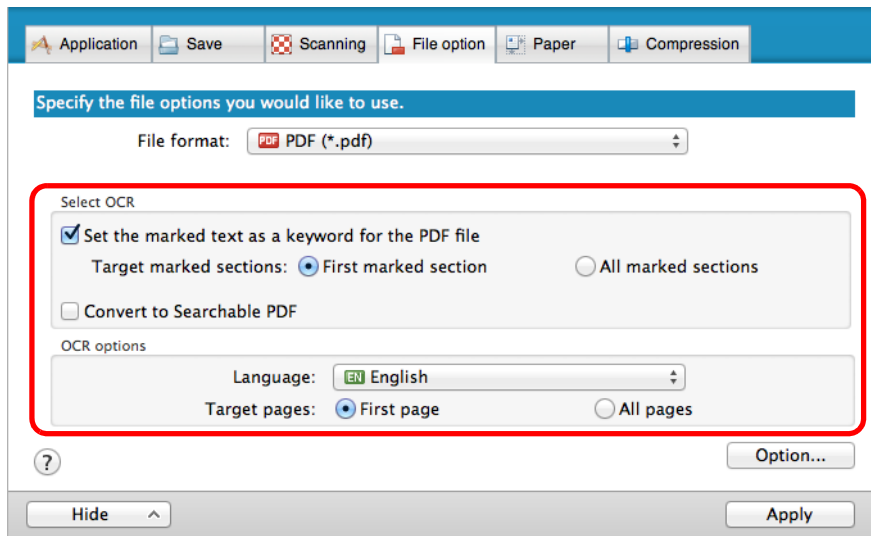

- Target marked sections

Select [First marked section] to perform text recognition and set a keyword for the PDF file only for the character strings in the first marked section, and [All marked sections] for all marked sections.

ATTENTION

Do not select [First marked section] when the text orientation of your document is vertical.

HINT

The following explanation is for when you select [First marked section]:

- Select this button to set a character string such as a title of a document as a keyword for the PDF file.

Example: When only the title of a document is marked, the marked character string is set as a keyword for the PDF file, and the PDF file becomes searchable by the title character string.

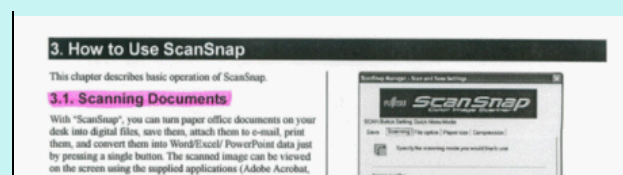

- When multiple marked sections exist in line, the marked character string closest to the top of the document is set as a keyword.

Example: In the following case, the character string in marked section B, which is higher than marked section A, is set as a keyword.

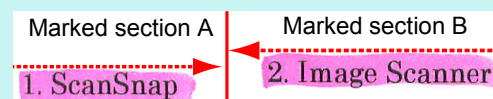

- Language
Select the language. Japanese, English, French, German, Italian, Spanish, Chinese (simplified), Chinese (traditional), Korean, Russian, and Portuguese can be selected.
- Target pages
Select [First page] to perform text recognition and set a keyword for the PDF file only for the first page, and [All pages] for all pages.

4. Click the [Apply] button.

5. Click the [✕] button in the upper left corner to close the ScanSnap setup window.

6. Load a document in the ScanSnap.

For details, refer to "[How to Load Documents](#)" (page 63).

7. Press the [Scan] button on the ScanSnap to start a scan.

⇒ Text recognition is performed on marked character strings and a PDF file is created with the keywords added.

ATTENTION

- It may take extra time to process text recognition depending on your computer system environment when you enable this setting in step 3.
- Scanned images of the following types of documents (characters) may not be recognized correctly.
In that case, better results in text recognition may be achieved by specifying a higher resolution in [Image quality].
 - Documents including handwritten characters
 - Documents with small characters scanned at a low resolution
 - Skewed documents
 - Documents written in languages other than the specified language
 - Documents including texts written in italic characters
 - Documents containing characters with superscripts/subscripts and complicated mathematical expressions
 - Documents with characters on an unevenly colored background
e.g. Shaded characters
 - Documents with many decorated characters
e.g. Decorated characters (embossed/outlined)
 - Documents with characters on a patterned background
e.g. Characters overlapping illustrations and diagrams
 - Documents with many characters contacting underlines or borders
- It may take extra time to perform text recognition on the following documents:
 - Documents with complex layouts
 - Documents with information other than text
e.g. Text on a shaded background

- If bleed-through reduction is enabled, the recognition rate may be lowered, and the marker may be erased or lightened. In that case, disable it in the following procedure.
Select [Settings] → [Scanning] tab → [Option] button from the ScanSnap Manager menu to show the [Scanning mode option] window. Clear the [Reduce bleed-through] checkbox.
- If the same character string is marked several times in the document, the same keyword is added multiple times in the PDF file.
- Total length of all the keywords can be up to 255 characters.
- When you check keywords in Adobe Acrobat or Adobe Reader, the added keywords may be displayed with a set of quotation marks (e.g. "ABC").

Saving Two Files or Pages into One Double-Page Spread Image

With Page Merger, you can merge two JPEG files, two single-page PDF files, or two pages of a multipage PDF file vertically or horizontally. The merged file or page is saved as a single double-page spread image.

For details about functions and operations, refer to the ScanSnap Manager Help.

Configuring ScanSnap Manager

This section explains how to set scan and Quick Menu settings, automatic linkage with applications, scanning progress status, and windows displayed during scanning.

How to Configure Scan Settings

You can configure ScanSnap Manager scan settings depending on your intended use of the scanned images. Scan settings can be configured using the ScanSnap setup window.

You can configure scan settings for the following scanning methods.

- Basic Scanning Methods
Scanning using the Quick Menu ([page 286](#))
- Convenient Scanning Methods
Scanning using a profile ([page 369](#))

Configure scan settings in the following procedure.

1. Select [Settings] from the ScanSnap Manager menu.

For details about the ScanSnap Manager menu, refer to "[ScanSnap Manager Menu \(Mac OS\)](#)" ([page 39](#)).

⇒ The ScanSnap setup window appears.

HINT

You can also open the ScanSnap setup window by pressing simultaneously the [command ()] and [S] keys on the keyboard. This operation is only enabled when ScanSnap Manager is active (when "ScanSnap Manager" is displayed in the menu bar).

2. Click the [Detail] button to switch to the detail view mode.

Example: ScanSnap setup window when scanning using the Quick Menu.

Outline view

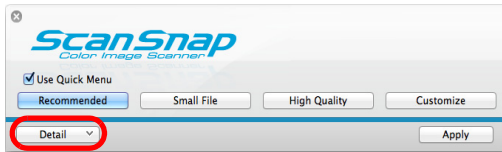

Detail view

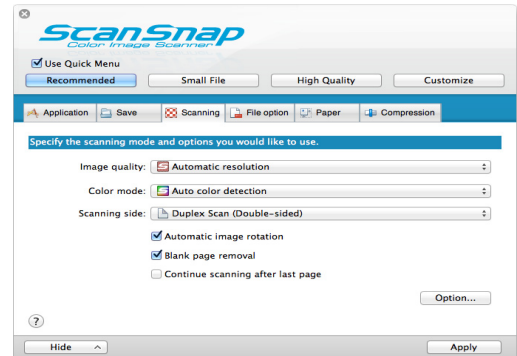

HINT

The ScanSnap setup window retains the display status from the last time the ScanSnap was used. For example, if it was closed in detail view mode, the window is displayed in detail view mode next time you open it.

3. Set the scan settings in each tab.

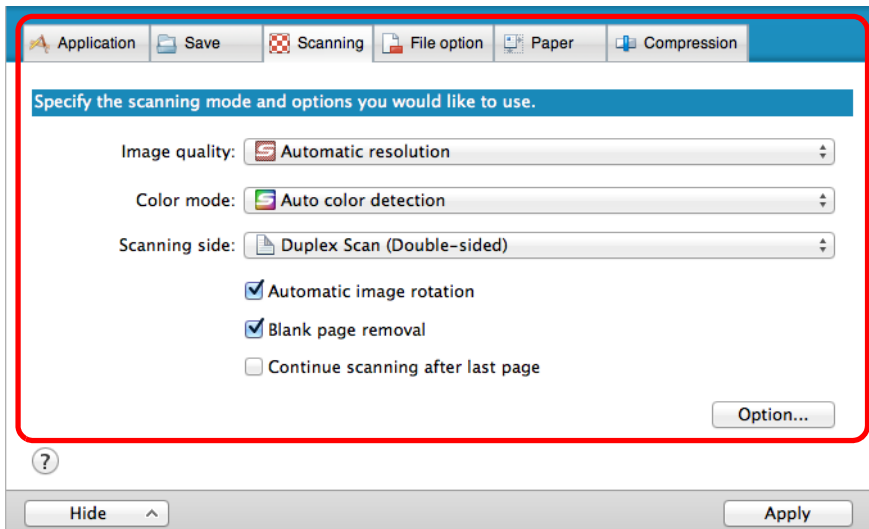

For details about each tab, refer to the ScanSnap Manager Help.

ATTENTION

Scan settings vary depending on the scanning method. For details about items that can be set, refer to "Setting Items by Scanning Method" (page 468).

4. Click the [Apply] button in the ScanSnap setup window.

⇒ Scan settings are changed.

- When you use the Quick Menu, scan settings for the [Customize] button are changed.
- When you use a profile, scan settings for the currently selected profile are changed.

HINT

If you press the [Scan] button on the ScanSnap while the ScanSnap setup window is displayed, the ScanSnap setup window closes and scanning starts. Scan settings that you have changed are saved and documents are scanned by these settings.

Note that when other windows are open, scanning does not start even if you press the [Scan] button on the ScanSnap unless open windows are closed.

Quick Menu Settings

This section explains the Quick Menu.

You can change the Quick Menu's display mode and the order in which the applications are displayed.

HINT

- For details about how to display the Quick Menu, refer to ["Scanning" \(page 288\)](#).
- For details about applications displayed in the Quick Menu, refer to ["Using ScanSnap with the Quick Menu" \(page 291\)](#).

Quick Menu

The Quick Menu displays applications that can be linked.



Applications that are newly added to the Quick Menu are indicated by the  mark.

HINT

You can freely add applications to the Quick Menu. For details, refer to the ScanSnap Manager Help.

Changing Display Mode

The following two modes are available in the Quick Menu:

- [Favorites] mode
Shows only the applications specified as favorites. When you set often-used applications as favorites and show them in [Favorites] mode, you can quickly and conveniently find the applications. For details about how to specify favorites, refer to ["Favorite Applications" \(page 428\)](#).
- [All Applications] mode
Shows all applications available in the Quick Menu.

By default, the Quick Menu is displayed in [Favorites] mode which includes all applications. To switch the display mode, click [Show All Applications] or [Show Favorites] in the Quick Menu.

HINT

The Quick Menu retains the last displayed status. For example, when you close the Quick Menu in [All Applications] mode, it will open in [All Applications] mode next time.

Changing Display Order

You can change the order in which applications are displayed in the Quick Menu. The procedure is as follows.

1. Click in the Quick Menu.

For details about how to display the Quick Menu, refer to ["Scanning" \(page 288\)](#).



⇒ The [Applications to Show/Hide] window appears.

2. Specify the order in which applications are displayed in the Quick Menu.

Application are displayed in the Quick Menu in the same order as they are listed in the [Applications to Show/Hide] window.

Drag an application to change its order.

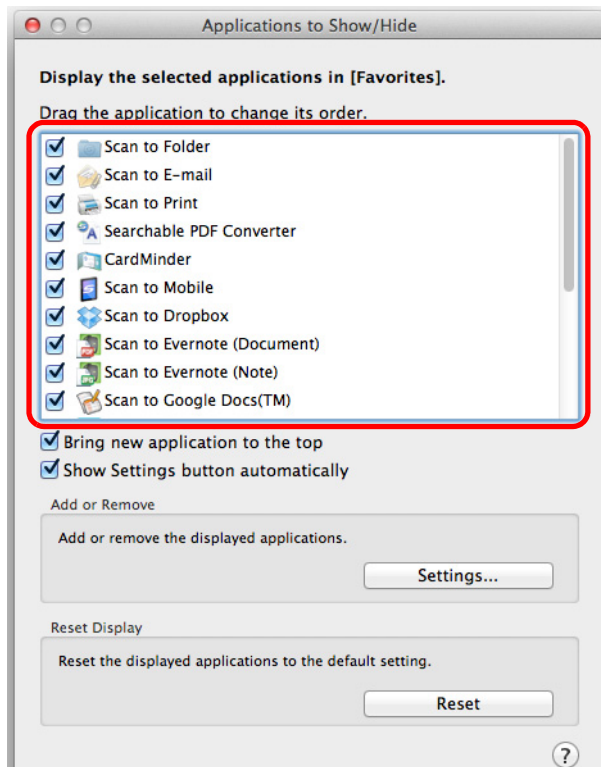

HINT

When you click the [Reset] button in the [Reset Display] window, the following return to their defaults.

- Order of applications displayed in the Quick Menu
- Favorites setting

The applications are displayed in the order shown below in the Quick Menu and in the application list of the [Applications to Show/Hide] window.

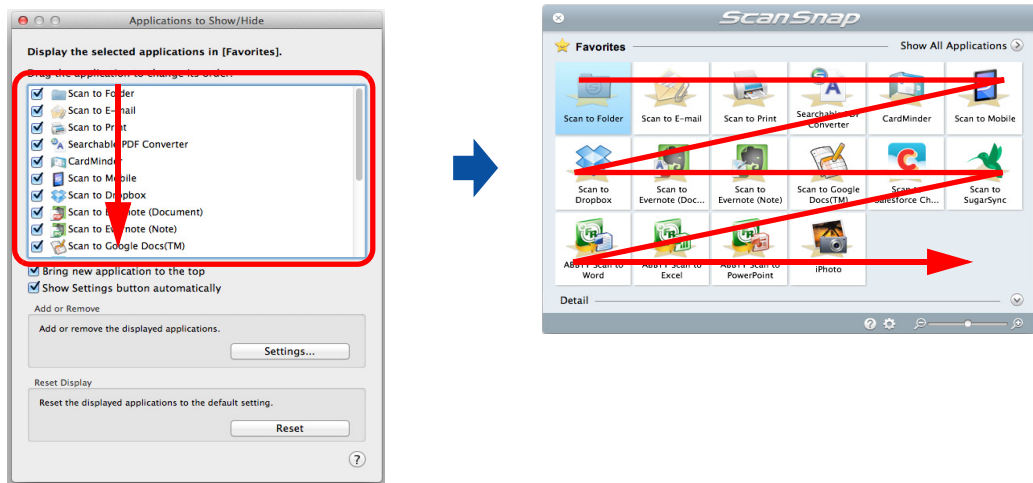

3. Click the [ⓧ] button in the upper left corner to close the [Applications to Show/Hide] window.

⇒ The order in which applications are displayed in the Quick Menu is changed.

Favorite Applications

You can set often-used applications as favorites in order to select them from the Quick Menu easily.

1. Click [Show All Applications] in the Quick Menu.

⇒ The Quick Menu switches to [All Applications] mode.

2. Click an application that you want to set as a favorite while pressing the [control] key on the keyboard, and click [Add to Favorites] in the displayed menu.

⇒ The application is set as a favorite.

A check mark is placed next to [Add to Favorites] and a star is displayed behind the application icon.

HINT

- By default, all applications are set as favorites. To switch the favorites setting, clear the check mark for [Add to Favorites].
- You can also set favorite applications in the [Applications to Show/Hide] window.

Recommended Applications

Depending on the size of the scanned document, ScanSnap Manager shows the recommended application.

Example:

When you scan a document of business card size, CardMinder is shown as recommended application.



You can show or hide the recommended applications by clicking [Show Recommended] or [Hide Recommended] on the Quick Menu.

Automatic Linkage with Applications

When one of the following applications is active (application menu appears in the menu bar), scanning documents by pressing the [Scan] button on the ScanSnap automatically starts the linkage between ScanSnap Manager and the application even when the Quick Menu is enabled.

Applications that can automatically link with ScanSnap Manager are as follows:

- CardMinder
Scanned image is displayed in CardMinder.
- Scan to Mobile
Scanned image is sent to a mobile device.

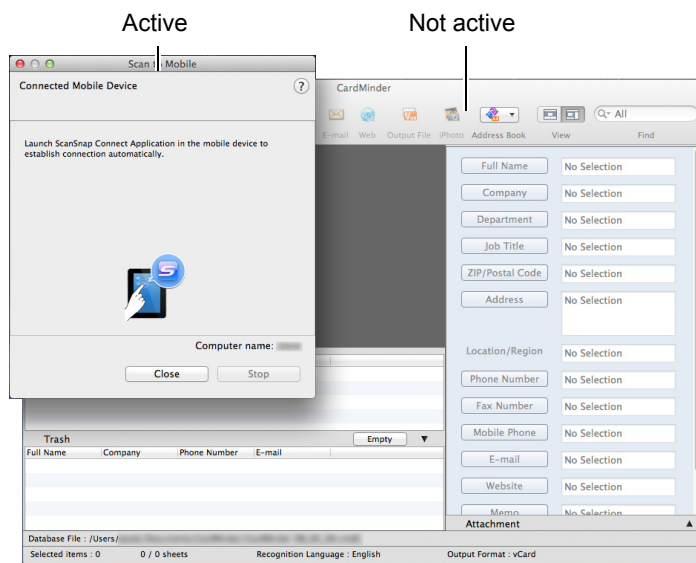

The example above shows ScanSnap Manager automatically linking with Scan to Mobile when Scan to Mobile window is in front (active).

ATTENTION

For CardMinder

- When CardMinder is active, scanning is performed with the current settings. If there are some settings that are not supported by CardMinder, the default settings are used.
For details about CardMinder default settings, refer to the ScanSnap Manager Help.
- While CardMinder is active, ScanSnap Manager automatically links with CardMinder when the document is of business card size. When documents of other sizes are scanned, ScanSnap Manager and CardMinder are not automatically linked, and the following error message appears.

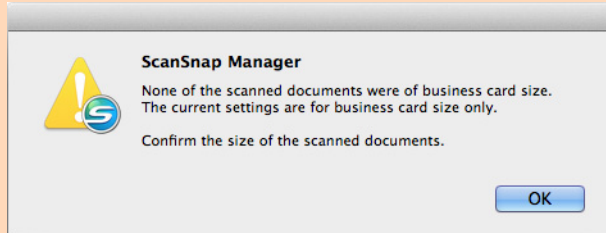

HINT

To disable automatic linkage, select [Do not link automatically] in the [Automatic Linkage] tab of the [ScanSnap Manager - Preferences] window.

ScanSnap's Communication Status

If you turn the ScanSnap ON/OFF or connect the ScanSnap to a wireless LAN when ScanSnap Manager is running, a notification appears and displays the communication status of the ScanSnap.

When the ScanSnap is ON

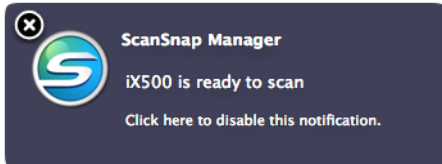

(When a USB cable is used for connection)

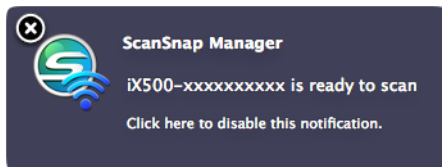

(When a wireless LAN is used for connection)

HINT

When you use automatic connection for the ScanSnap that had been connected to a wireless LAN before, if the password for the ScanSnap to be connected has been changed, the notification shown below appears.

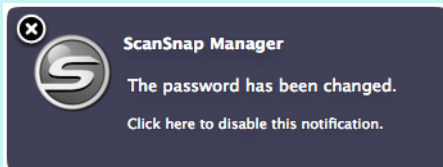

When the ScanSnap is OFF

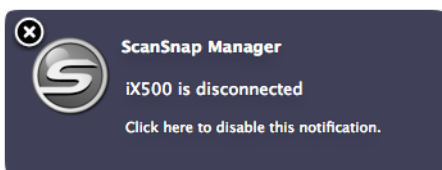

HINT

To disable notifications of the ScanSnap's communication status, click the notification, and in the [Status Display] tab of the [ScanSnap Manager - Preferences] window, clear the [Notify of the communication status] checkbox.

When the ScanSnap will be automatically turned off soon

When the time until auto power-off is specified, the notification appears 5 minutes before the ScanSnap turns off.

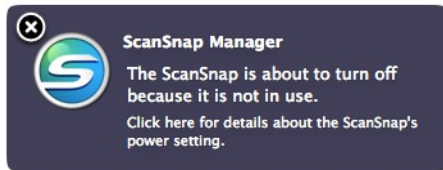

When connected to a mobile device via wireless LAN

When the ScanSnap and a mobile device are connected via wireless LAN, communication with ScanSnap Manager is disconnected, and the pop-up balloon notifies you of the communication status.

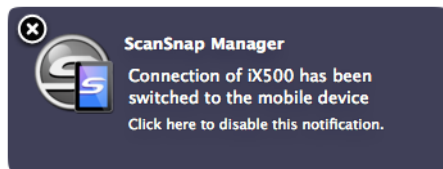

HINT

With the ScanSnap and the mobile device already connected via wireless LAN, if you log into the computer to which the ScanSnap is connected, this is notified by pop-up balloon.

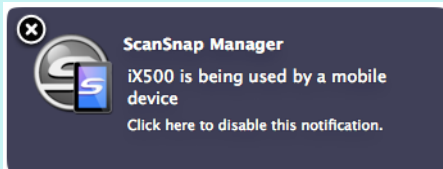

Receiving or hiding the ScanSnap's communication status notifications

You can specify whether or not to receive notifications of the ScanSnap's communication status.

Configure the setting in the following procedure.

1. Select [Help] → [Preferences] from the ScanSnap Manager menu.

For details about the ScanSnap Manager menu, refer to "[ScanSnap Manager Menu \(Mac OS\)](#)" (page 39).

⇒ The [ScanSnap Manager - Preferences] window appears.

2. In the [Status Display] tab, either select or clear the [Notify of the communication status] checkbox.

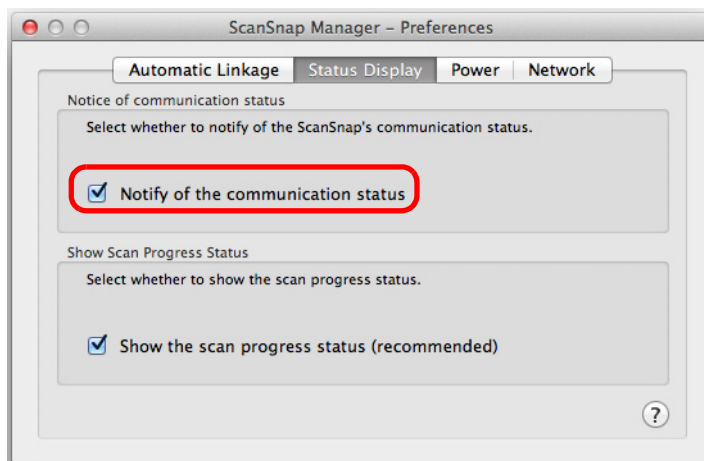

If you select the [Notify of the communication status] checkbox, you will be notified of the communication status in conjunction with the ScanSnap being turned ON/OFF. If you clear the [Notify of the communication status] checkbox, you will not be notified of the communication status.

3. Click the [ⓧ] button in the upper left corner to close the [ScanSnap Manager - Preferences] window.

Showing the Scanning Progress

When scanning starts, the [ScanSnap Manager - Image scanning and file saving] window appears.

The [ScanSnap Manager - Image scanning and file saving] window consists of the following:

- Scan status
- Scan settings
- Save completed
- Preview

Note that you can stop scanning by clicking the [Stop] button in the [ScanSnap Manager - Image scanning and file saving] window.

For details about how to stop scanning, refer to ["Stopping the Scan" \(page 290\)](#).

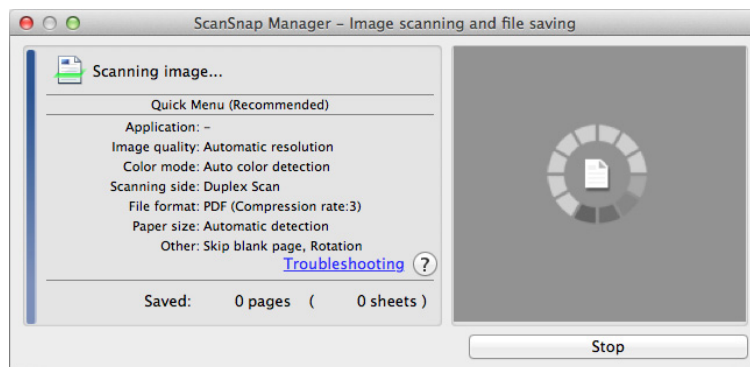

The [ScanSnap Manager - Image scanning and file saving] window closes automatically after saving the scanned image of the last page scanned.

HINT

If the [Continue scanning after last page] checkbox is selected in the [Scanning] tab of the ScanSnap setup window, you must click the [Finish Scanning] button, and then close the [ScanSnap Manager - Image scanning and file saving] window.

Hiding the Scanning Progress Status

You can hide the [ScanSnap Manager - Image scanning and file saving] window in the following procedure.

1. Select [Help] → [Preferences] from the ScanSnap Manager menu.

For details about the ScanSnap Manager menu, refer to "[ScanSnap Manager Menu \(Mac OS\)](#)" (page 39).

⇒ The [ScanSnap Manager - Preferences] window appears.

2. In the [Status Display] tab, clear the [Show the scan progress status (recommended)] checkbox.

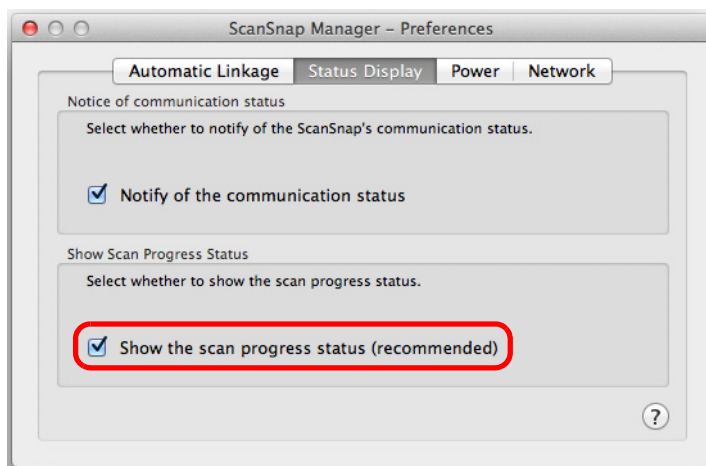

3. Click the [⏻] button in the upper left corner to close the [ScanSnap Manager - Preferences] window.

⇒ The [ScanSnap Manager - Image scanning and file saving] window is hidden from next scanning on.

HINT

When the scanning progress status window is not displayed, the current number of pages saved is indicated on the ScanSnap Manager icon  in the Dock.

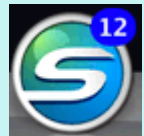

Troubleshooting

For details about how to resolve problems such as removing jammed documents, refer to "Troubleshooting" in the ScanSnap Manager Help.

Windows

Select [Help] → [Troubleshooting] in the Right-Click Menu.

Mac OS

Select [Help] → [Troubleshooting] in the ScanSnap Manager menu.

Daily Care



This chapter explains about the cleaning materials and how to clean the ScanSnap.

ATTENTION
The bottom part of the ScanSnap may become hot when the ScanSnap is being used but this does not affect ScanSnap operation or cause any physical harm. Be careful not to drop the ScanSnap when carrying it.

Cleaning Materials..... 439
Cleaning the Outside of the ScanSnap 440
Cleaning the Inside of the ScanSnap 441

Cleaning Materials

Cleaning materials and their part numbers are as below.

Product Name	Part No.	Unit	Note
Cleaner F1 	PA03950-0352	1 bottle	Size: 100 ml
Cleaning Wipe (*1) 	PA03950-0419	1 pack	24 packets
Lint-free dry cloth (*2)	Commercially available	-	-

*1 : The cleaning wipes are wet tissues that have been soaked with cleaner F1. In place of this product, you can use a cloth soaked with cleaner F1.

*2 : Any lint-free cloth can be used.

To obtain these products, contact your FUJITSU dealer or an authorized FUJITSU scanner service provider.

For more details, refer to the following Web page:

<http://scansnap.fujitsu.com/>

Cleaning the Outside of the ScanSnap

Clean the outside of the ScanSnap, the ADF paper chute (cover), the ADF top section, and the stacker in the following procedure.

How to perform cleaning

1. Unplug the cables from the ScanSnap.
2. Clean the outside of the ScanSnap with a dry cloth, or a cloth moistened with Cleaner F1/mild detergent.

ATTENTION

- Never use paint thinner or any other organic solvents.
- Be careful not to get any moisture or water inside the scanner during cleaning.
- It may take a long time for Cleaner F1 to dry if an excessive amount is used. Moisten the cloth with moderate quantity. Wipe off the cleaner completely to leave no residue on the cleaned parts.

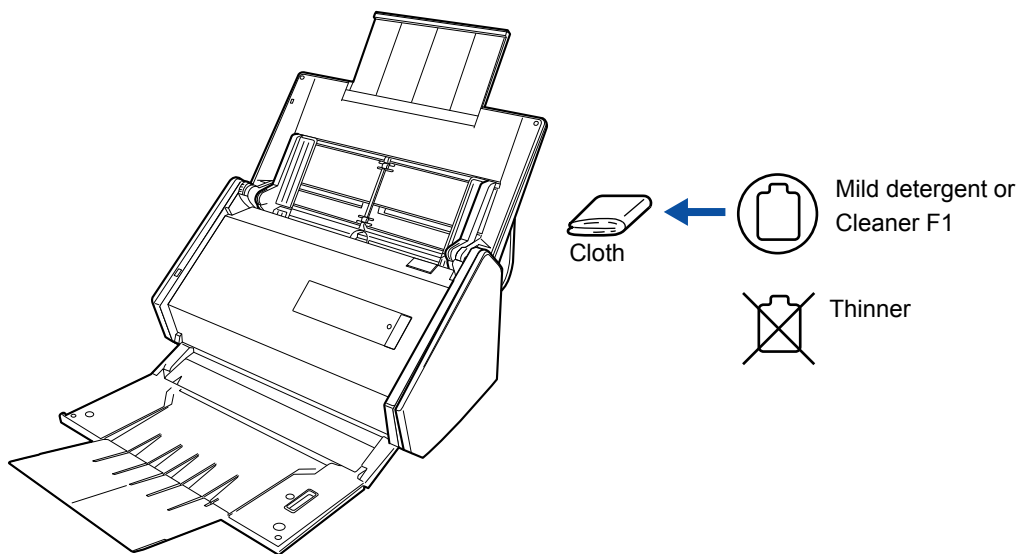

Cleaning the Inside of the ScanSnap

Scanning continuously may cause dust and paper dust to accumulate inside the ScanSnap and result in scanning error.

As a guideline, the inside of the ScanSnap should be cleaned every 1,000 sheets scanned. Note that this guideline varies depending on the types of documents you scan. For instance, it may be necessary to clean the scanner more frequently when you scan documents on which the toner is not sufficiently fused.

HINT

Check the number of sheets scanned in the following procedure.

Windows

Select [Check consumable status] in the Right-Click Menu to display the [ScanSnap Manager - Check consumable status] dialog box, and then see [Total Page Count].

Mac OS

Select [Check consumable status] in the ScanSnap Manager menu to display the [ScanSnap Manager - Check consumable status] window, and then see [Total Page Count].



- Before you perform cleaning, you must turn off the ScanSnap and unplug the cables to avoid the risk of fire or electric shock.
- To avoid injuries, do not place internal parts of the scanner (e.g. break roller, pick roller) anywhere within reach of small children.
- Do not use aerosol spray or spray that contains alcohol to clean the scanner. Paper dust and other dust blown up by strong air from the spray may enter inside of the scanner which may cause scanner failure or malfunction.
Also note that sparks generated by static electricity may cause a fire.
- The glass inside the scanner becomes very hot when the ScanSnap is being used.
Unplug the cables from the ScanSnap and wait for at least 15 minutes before cleaning.

How to perform cleaning

1. Clean the following locations:

- Brake roller
- Idler roller
- Glass
- Pick roller
- Ultrasonic sensor

1. Unplug the cables from the ScanSnap.

2. Pull the ADF release tab to open the ADF top section.

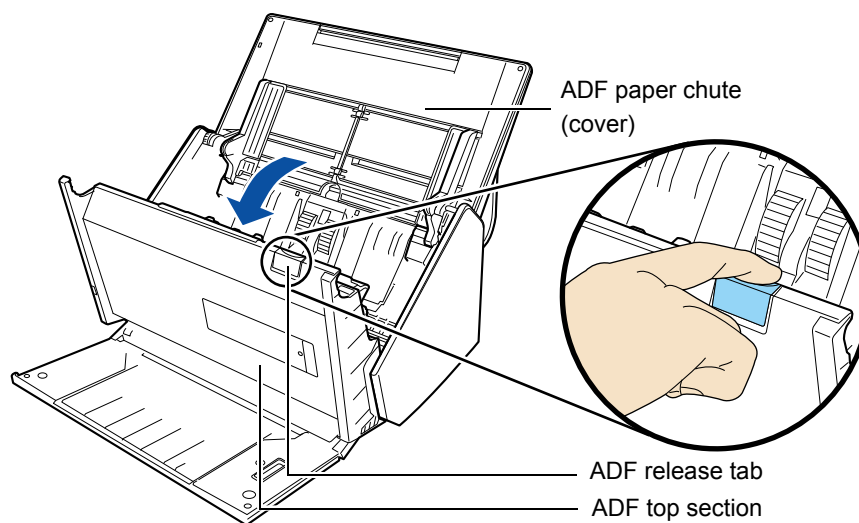

3. Clean the following locations with a cloth moistened with Cleaner F1.

ATTENTION

- Do not use water or mild detergent to clean the inside of the ScanSnap.
- It may take a long time for Cleaner F1 to dry if an excessive amount is used. Moisten the cloth with a moderate quantity.
Wipe off the cleaner completely to leave no residue on the cleaned parts.
- Be careful when cleaning not to catch the cloth in the document detection sensor.

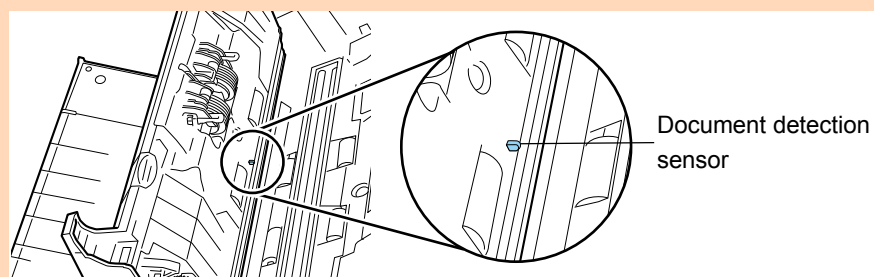

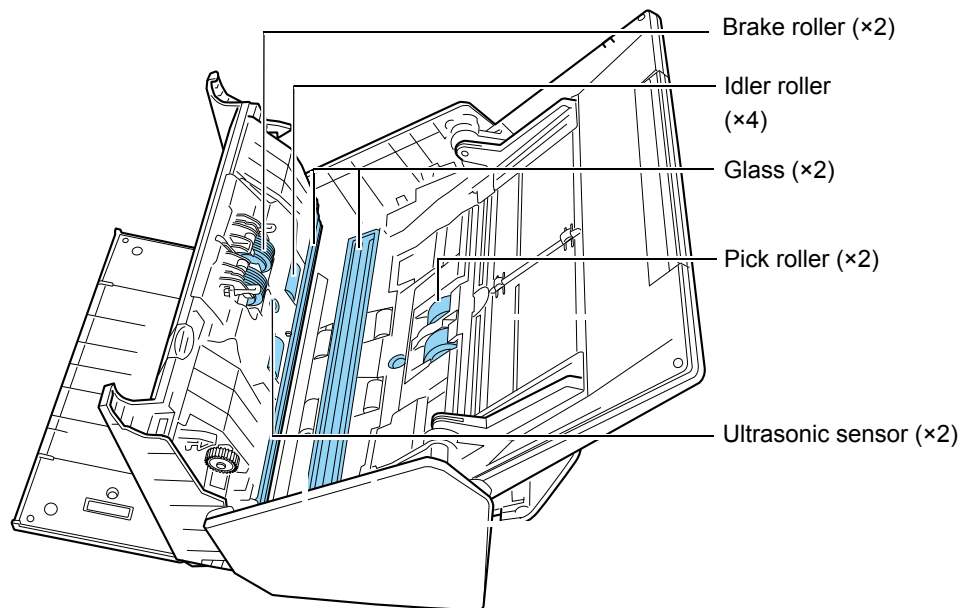

- Brake roller (x2)

Remove the brake rollers from the ScanSnap to clean.

For details on how to remove the brake rollers, refer to ["Replacing the Roller Set" \(page 450\)](#).

Gently wipe the dirt and dust off from along the slots on the surface of the brake rollers. Be careful not to damage the surface of the rollers.

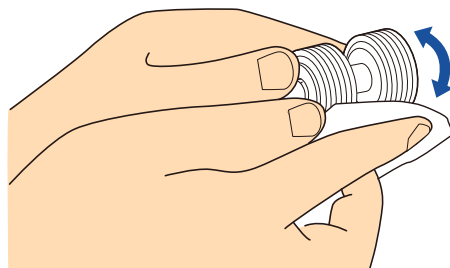

- Idler roller (x4)

Gently wipe the dirt and dust off the rollers as you rotate them manually. Be careful not to damage the surface of the rollers. Make sure that they are cleaned properly because residue on the roller will affect the feeding performance.

- Glass (x2)

Gently wipe the dirt and dust off the surface of the glass sections. Make sure that it is cleaned properly because dirty glass can cause vertical lines to appear in the scanned image.

- Pick roller (x2)

Gently wipe the dirt and dust off from along the slots on the surface of the roller as you rotate it manually. Be careful not to damage the surface of the roller. Make sure that it is cleaned properly because residue on the roller will affect the feeding performance.

- Ultrasonic sensor (×2)

Gently wipe the dirt and dust off the surface of the ultrasonic sensors. If you have trouble wiping the ultrasonic sensors with the cloth, use a cotton swab.

2. Clean the feed roller and eject roller.

1. Connect the power cable, and press the [Scan] button for 3 seconds with the ADF top section open.

ATTENTION

Connect the power cable only when cleaning the feed rollers and eject rollers.

2. Clean the feed roller and the eject roller with a cloth moistened with Cleaner F1.

ATTENTION

- Do not use water or mild detergent to clean the inside of the ScanSnap.
- It may take a long time for Cleaner F1 to dry if an excessive amount is used. Moisten the cloth with a moderate quantity.
Wipe off the cleaner completely to leave no residue on the cleaned parts.

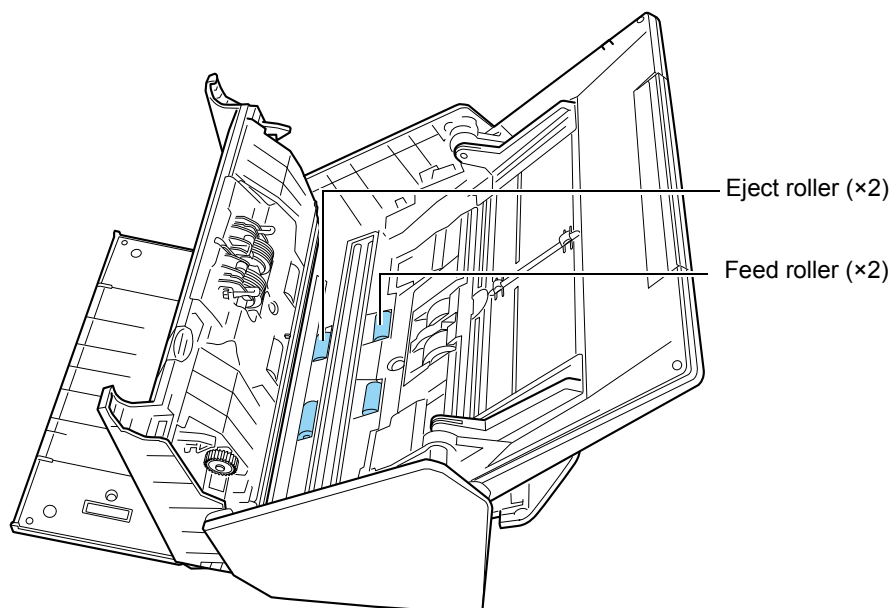

- Feed roller (×2)/Eject roller (×2)

Press the [Scan] button to rotate the rollers. Gently wipe the dirt and dust off while taking care not to damage the surface of the rollers. Make sure that they are cleaned properly because residue on the rollers will affect the feeding performance.

HINT

Pressing the [Scan] button seven times will rotate the feed rollers and the eject rollers one revolution.

3. Close the ADF top section.

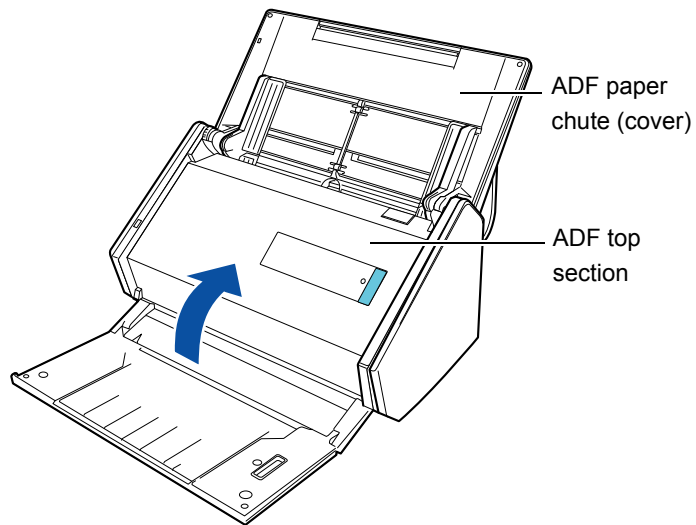

⇒ It clicks when it returns to its original position.

ATTENTION

Confirm that the ADF top section is completely closed.
Otherwise, paper jams or other feeding errors, or image faults may occur.

Consumables

This chapter explains about the consumable part numbers, replacement cycles and how to replace the consumables.



- Before you replace the consumables, you must turn off the ScanSnap and unplug the cables to avoid the risk of fire or electric shock.
- To avoid injuries, do not place internal parts of the scanner (e.g. break roller, pick roller) anywhere within reach of small children.

ATTENTION

The bottom part of the ScanSnap may become hot when the ScanSnap is being used but this does not affect ScanSnap operation or cause any physical harm. Be careful not to drop the ScanSnap when carrying it.

Part Numbers and Replacement Cycle of Consumables 447
Replacing the Roller Set 450

Part Numbers and Replacement Cycle of Consumables

The following table shows the part numbers of the consumables and the suggested replacement cycles.

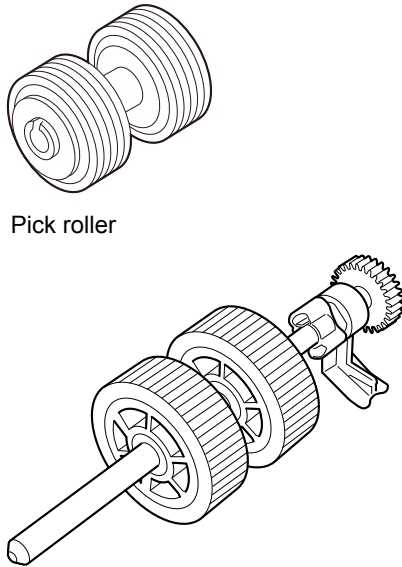
No.	Product Name	Part No.	Suggested replacement cycle
1	Roller Set <ul style="list-style-type: none"> ● Brake roller  <ul style="list-style-type: none"> ● Pick roller 	PA03656-0001	200,000 sheets or one year

Note that the suggested replacement cycles are guidelines for using A4 (80 g/m² [20 lb]) wood-free paper, as these cycles vary depending on the type of documents scanned. Only use the specified consumables.

To purchase the consumables, contact your FUJITSU dealer or an authorized FUJITSU scanner service provider.

For more details, refer to the following Web page:

<http://scansnap.fujitsu.com/>

You can check the status on each consumable part in the following procedure.

Windows

1. Select [Check consumable status] from the Right-Click Menu.

For details about the Right-Click Menu, refer to ["Right-Click Menu \(Windows\)"](#) (page 37).

⇒ The [ScanSnap Manager - Check consumable status] dialog box appears.

2. Check the status of each consumable.

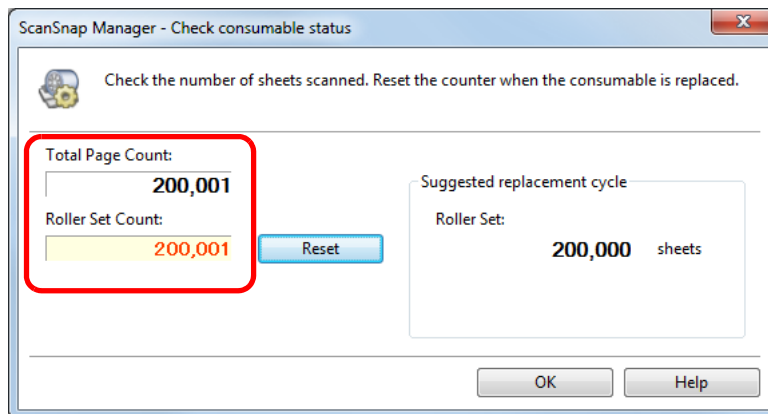

⇒ Refer to [Suggested replacement cycle] as a guideline and replace the consumables.

Mac OS

1. Select [Check consumable status] from the ScanSnap Manager menu.

For details about the ScanSnap Manager menu, refer to ["ScanSnap Manager Menu \(Mac OS\)"](#) (page 39).

⇒ The [ScanSnap Manager - Check consumable status] window appears.

2. Check the status of each consumable.

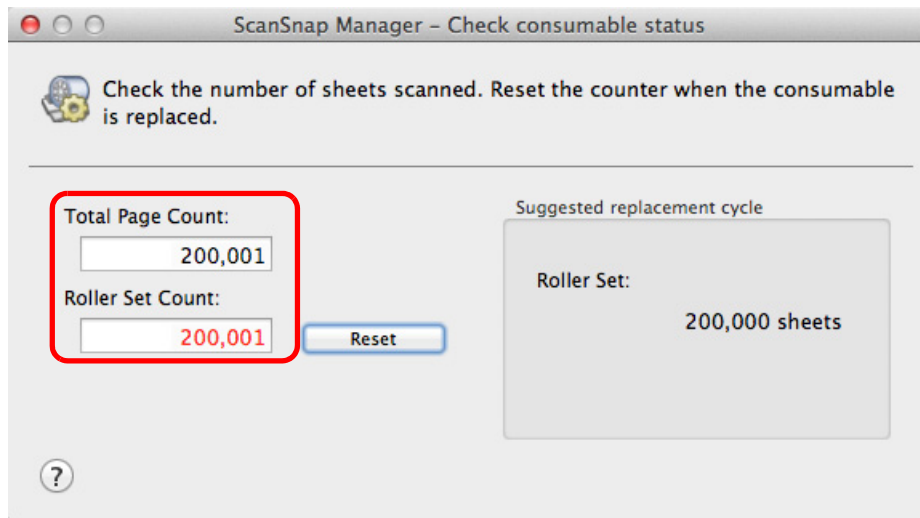

⇒ Refer to [Suggested replacement cycle] as a guideline and replace the consumables.

Replacing the Roller Set

The Roller Set is made up of the brake roller and the pick roller. The procedure for replacing each roller is as follows.

- 1. Unplug the power cable from the ScanSnap.**
- 2. Remove the documents from the ADF paper chute (cover).**
- 3. Pull the ADF release tab to open the ADF top section.**

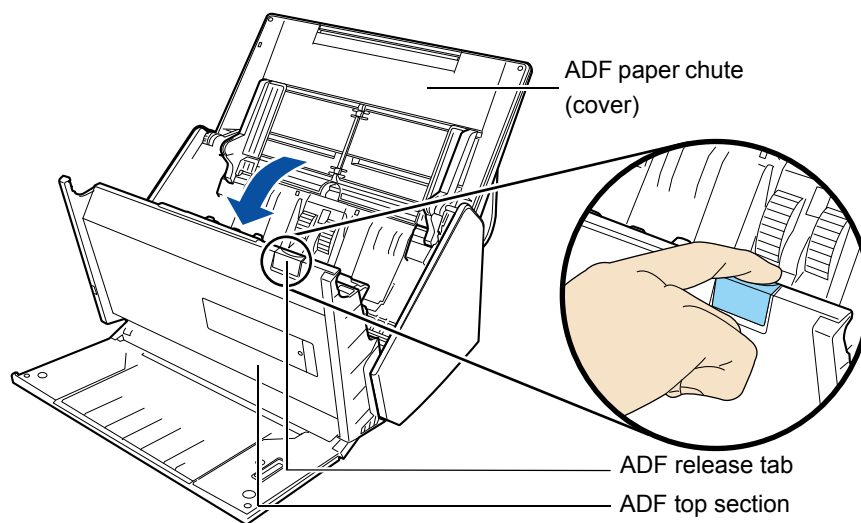

4. Replace the brake roller.

- 1. Open the cover.**

Hold both ends of the cover, and open it in the direction of the arrow.

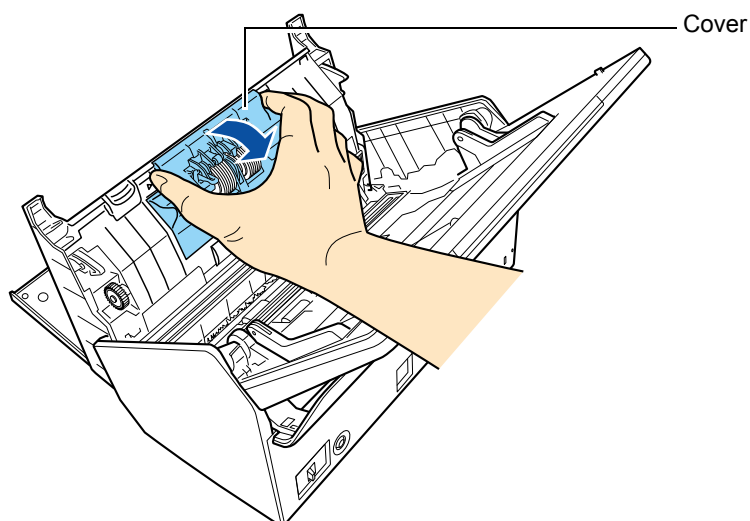

2. Remove the brake roller shaft.

Lift the right side of the roller first, then pull out the shaft from the slot on the left.

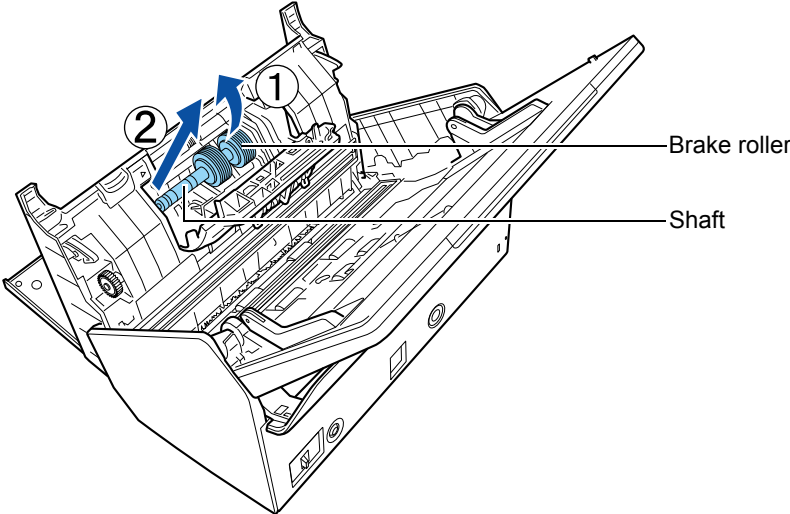

3. Remove the brake roller from its shaft.

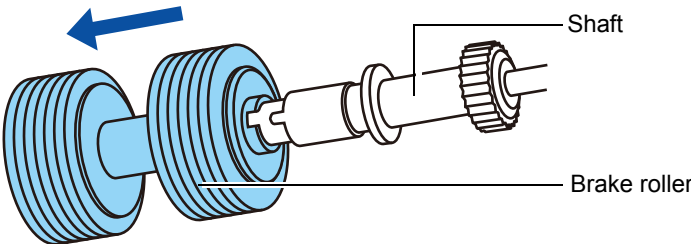

4. Attach a new brake roller on the shaft.

Insert the protrusion on the shaft into the slot.

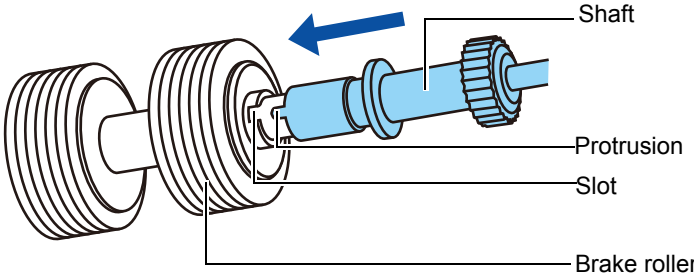

5. Install the brake roller with its shaft.

Fit the left end of the shaft in the slot, then install the rest of the shaft in place.

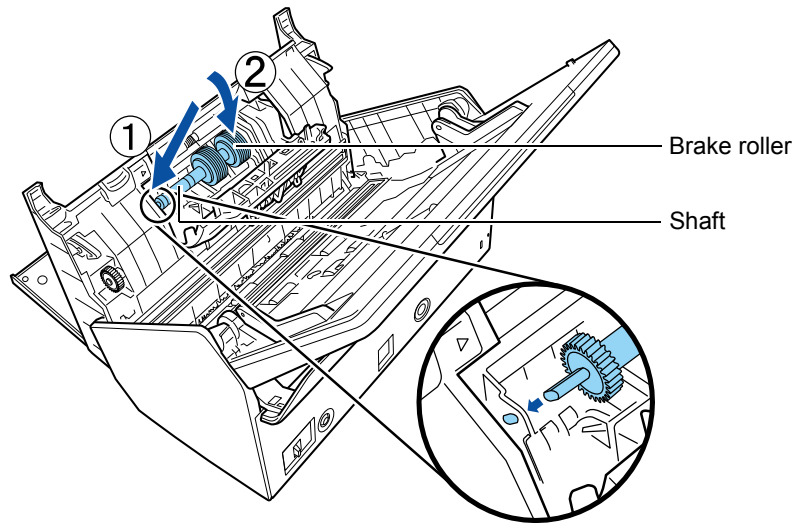

6. Close the cover.

ATTENTION

Confirm that the shaft is attached properly. Otherwise, paper jams or other feeding errors may occur.

5. Replace the pick roller.

1. Open the sheet guide.

Slide the side guides all the way, and pull the sheet guide open from the dip.

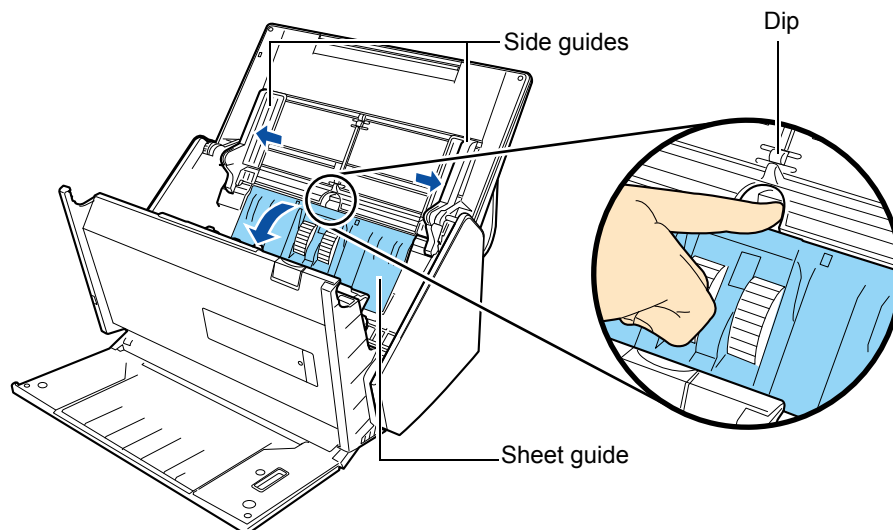

2. Rotate the bushing on the shaft.

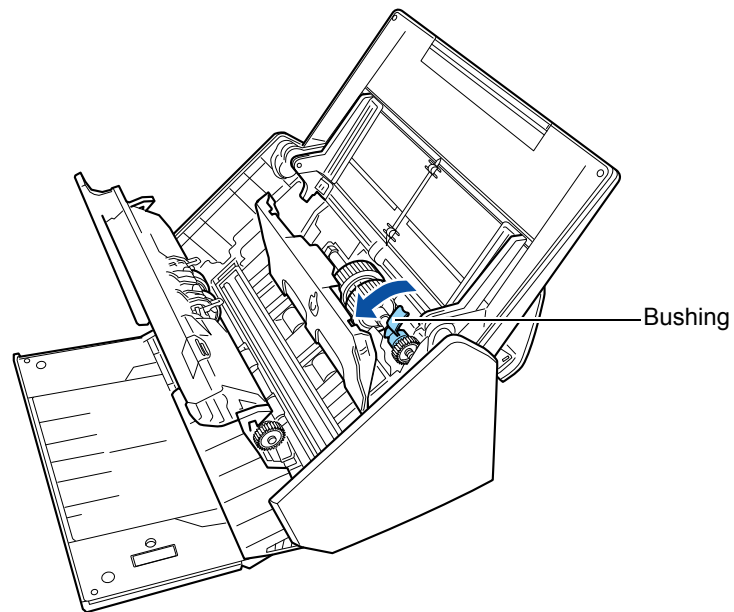

3. Remove the pick roller.

Gently lift the right side of the shaft (about 5 mm), move it towards the right, and then pull it out.

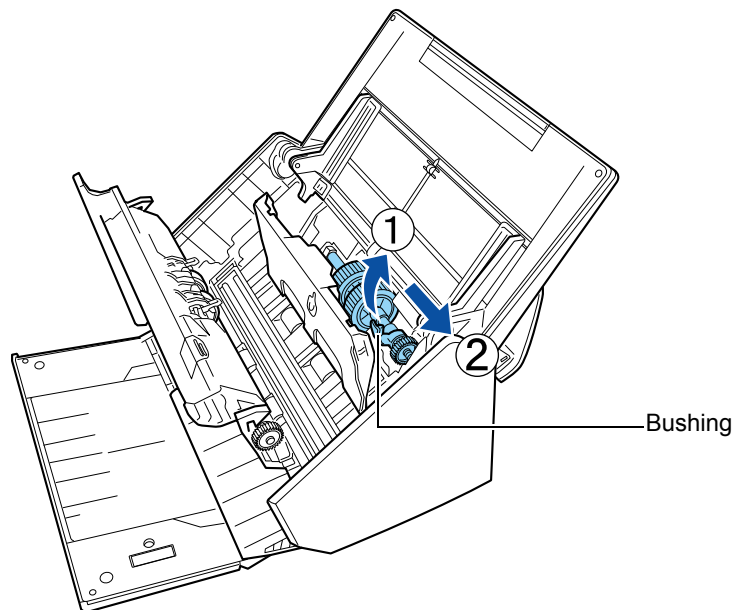

ATTENTION

Be careful not to touch the gear near the bushing on the shaft as it contains grease.

4. Install a new pick roller on the ScanSnap.

Insert the left end of the shaft into the slot, and lower the other end gradually.

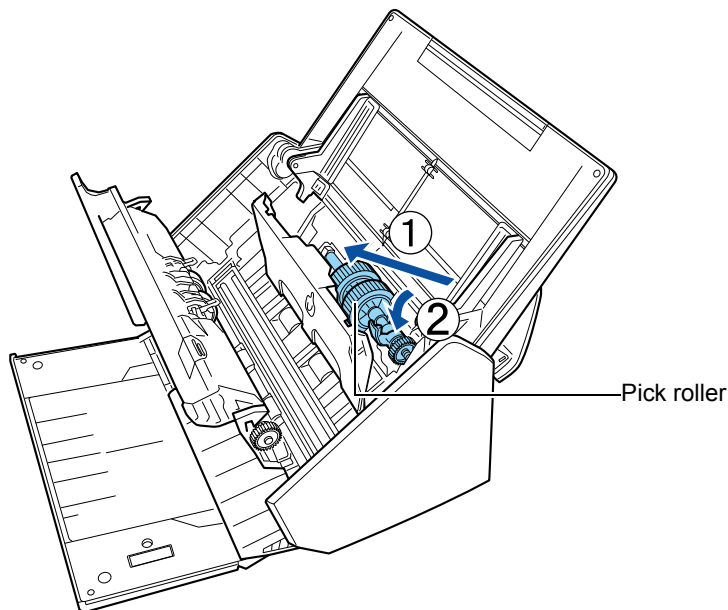

5. Rotate the bushing to lock the shaft.

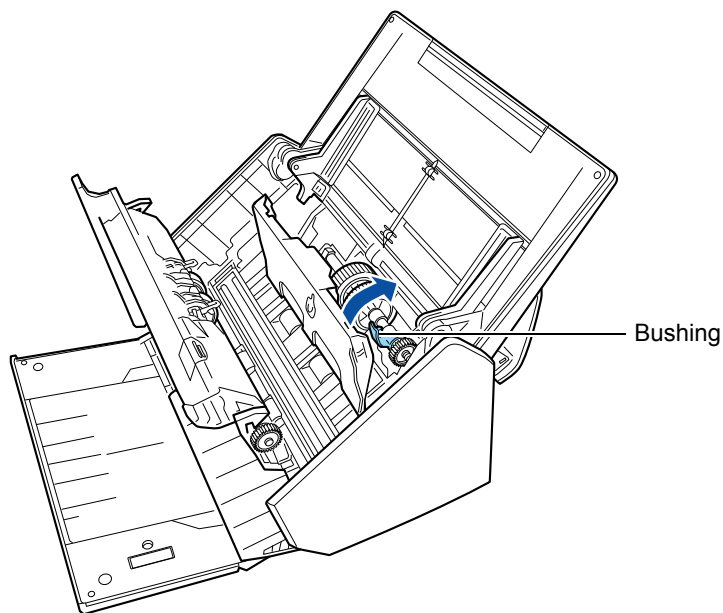

ATTENTION

Confirm that the pick roller is installed properly. Otherwise, paper jams or other feeding errors may occur.

6. Close the sheet guide.

Make sure that both ends of the sheet guide are locked firmly.

6. Close the ADF top section.

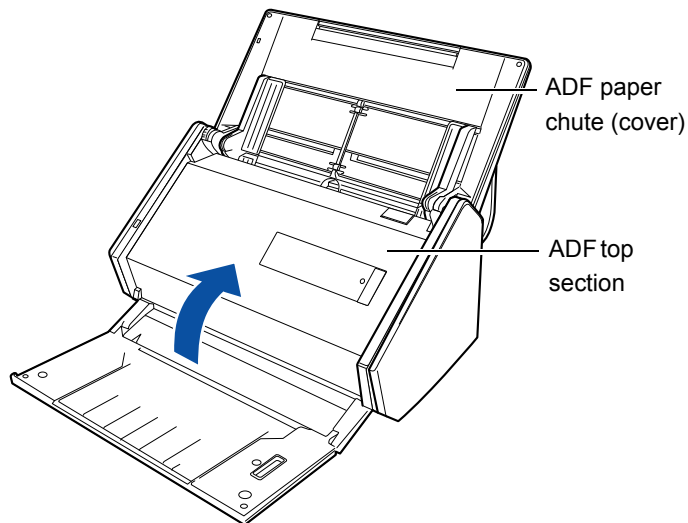

⇒ It clicks when it returns to its original position.

7. Connect the power cable, and turn on the ScanSnap.

8. Reset the Roller set counter.

Windows

1. Select [Check consumable status] from the Right-Click Menu.

For details about the Right-Click Menu, refer to ["Right-Click Menu \(Windows\)"](#) (page 37).

⇒ The [ScanSnap Manager - Check consumable status] dialog box appears.

2. Click the [Reset] button for [Roller Set Count].

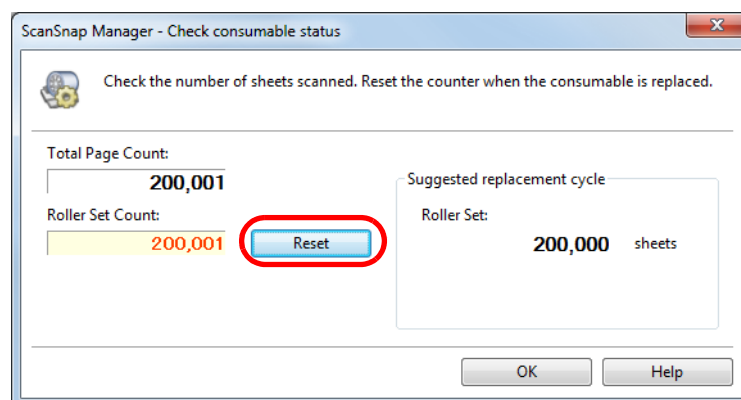

⇒ A confirmation message appears.

3. Click the [Yes] button.

⇒ The counter turns "0".

Mac OS

1. Select [Check consumable status] from the ScanSnap Manager menu.
For details about the ScanSnap Manager menu, refer to "[ScanSnap Manager Menu \(Mac OS\)](#)" (page 39).
⇒ The [ScanSnap Manager - Check consumable status] window appears.
2. Click the [Reset] button for [Roller Set Count]

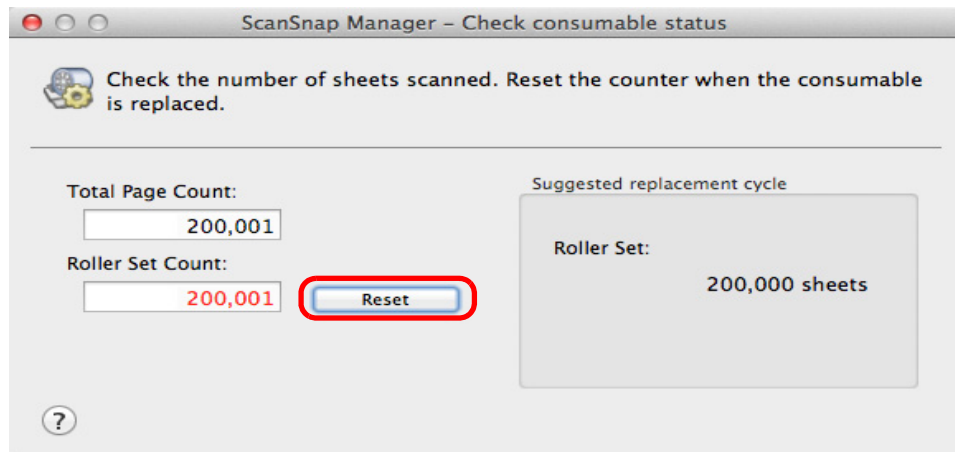

- ⇒ A confirmation message appears.
3. Click the [Yes] button.
⇒ The counter turns "0".

Appendix

This appendix explains how to update ScanSnap Manager, how to uninstall the software, about settings that differ by the scanning method, how to purchase/clean the Carrier Sheet and the ScanSnap installation specifications.

ScanSnap Online Update.....	458
Uninstalling the Software	460
Setting Items by Scanning Method.....	468
Purchasing/Cleaning the Carrier Sheet.....	476
Wireless LAN Specifications.....	478
Installation Specifications	479

ScanSnap Online Update

ScanSnap Online Update allows you to obtain the latest programs for ScanSnap related software free of charge from our download server.

It is recommended that you keep your program updated to enhance security, operability and functions.

The ScanSnap related software is as follows:

- ScanSnap Manager
- ScanSnap Organizer
- CardMinder
- ScanSnap Online Update

ScanSnap Online Update checks the download server periodically.

When the latest version of ScanSnap is available, ScanSnap Online Update notifies you with the following methods.



Pop-up balloon appears.

To install the update, click on the pop-up balloon and follow the instructions on the dialog box that appears.



Update list appears.

Follow the instructions on the window that appears and install the update.

For details, refer to the ScanSnap Online Update Help.

ATTENTION

To run the online update for ScanSnap Manager, you need to have access to the Internet.

HINT

For details about updates of the software bundled with the ScanSnap, visit the following web page:

<http://scansnap.fujitsu.com/g-support/en/>

You can also check from ScanSnap Manager whether a newer version of the program is available and run the update.

**ATTENTION**

Log on as a user with Administrator privileges.

1. In the Right-Click Menu, click [Help] → [Online Update].

For details about the Right-Click Menu, refer to "[Right-Click Menu \(Windows\)](#)" (page 37).

⇒ ScanSnap Online Update checks whether a newer version of ScanSnap Manager is available. Proceed with the update as you follow the instructions.

For details, refer to the ScanSnap Online Update Help.

**1. Select [Help] → [Online Update] from the ScanSnap Manager menu.**

For details about the ScanSnap Manager menu, refer to "[ScanSnap Manager Menu \(Mac OS\)](#)" (page 39).

⇒ ScanSnap Online Update checks whether a newer version of ScanSnap Manager is available. Proceed with the update as you follow the instructions.

For details, refer to the ScanSnap Online Update Help.

Uninstalling the Software

This section explains how to uninstall the software bundled with the ScanSnap. For details about installation, refer to ["Installing the Software" \(page 68\)](#).

Uninstalling in Windows

This section explains how to uninstall the following software:

- ScanSnap Manager
- ScanSnap Organizer
- CardMinder
- ABBYY FineReader for ScanSnap
- Evernote for Windows
- Scan to Microsoft SharePoint

HINT

If all of the following software is uninstalled, ScanSnap Online Update is also uninstalled at the same time:

- ScanSnap Manager
- ScanSnap Organizer
- CardMinder

The procedure is as follows.

- 1. Turn on the computer and log on as a user with Administrator privileges.**
- 2. Exit all running software.**
- 3. Select [Start] menu → [Control Panel] → [Uninstall a program] under [Programs]. (For Windows 8, right-click the Start screen, and select [All apps] on the app bar → [Control Panel] under [Windows System] → [Uninstall a program] under [Programs].)**

⇒ The [Uninstall or change a program] dialog box appears with a list of currently installed software.

4. Select the software to uninstall.

- To uninstall ScanSnap Manager
Select **[ScanSnap Manager]**.
- To uninstall ScanSnap Organizer
Select **[ScanSnap Organizer]**.
- To uninstall CardMinder
Select **[CardMinder]**.
- To uninstall ABBYY FineReader for ScanSnap
Select **[ABBYY FineReader for ScanSnap(TM) 5.0]**.
- To uninstall Evernote for Windows
Select **[Evernote]**.
- To uninstall Scan to Microsoft SharePoint
Select **[Scan to Microsoft SharePoint]**.

HINT

To uninstall more than one software, repeat steps 4. to 6. for each software.

5. Click the [Uninstall] button.

⇒ A confirmation message appears.

6. Click the [Yes] button

⇒ The software is uninstalled.

ATTENTION

- Screen displays may vary slightly depending on the operating system that you are using. In that case, follow the instructions by the operating system.
Example:
 - [Programs and Features]
In Windows XP: [Add or Remove Programs]
 - [Uninstall] button
In Windows XP: [Remove] button
- If you cannot successfully uninstall the following software, select [Manuals] → [Troubleshooting (installation)] in the [ScanSnap Setup] dialog box and refer to Troubleshooting (installation).
 - ScanSnap Manager
 - ScanSnap Organizer
 - CardMinder

Uninstalling in Mac OS

This section explains how to uninstall the following software:



- ScanSnap Manager (→ [page 462](#))
- CardMinder (→ [page 464](#))
- ABBYY FineReader for ScanSnap (→ [page 465](#))
- ScanSnap Online Update (→ [page 466](#))
- ABBYY FineReader Express Edition for Mac (→ [page 467](#))
- Evernote for Mac (→ [page 467](#))

ScanSnap Manager

- 1. Turn on the computer and log in as a user with Administrator privileges.**
- 2. From the sidebar in Finder, select [Applications] → [ScanSnap] → [Sub], and then double-click [ScanSnap Uninstaller].**
 - ⇒ The [ScanSnap Uninstaller] window appears, displaying the [Welcome to ScanSnap Uninstaller] screen.
- 3. Click the [Continue] button.**
 - ⇒ The [Read Me] screen appears.
- 4. Read [Read Me], and then click the [Uninstall] button.**
 - ⇒ An authentication window appears.
- 5. Enter the user name and password for a user with Administrator privileges, and click the [OK] button.**
 - ⇒ Uninstallation starts. When the uninstallation is complete, the [Uninstall Succeeded] screen appears.
- 6. Click the [Close] button.**

HINT

If ScanSnap Manager has been configured as a login item with a user account other than the current one, remove it in the following procedure:

1. Log in under the user account where ScanSnap Manager is set as a login item.
2. From the Apple () menu, select [System Preferences].
 - ⇒ The [System Preferences] window appears.
3. Select [Users & Groups] ([Accounts] on Mac OS X v10.6).
 - ⇒ The [Users & Groups] window ([Accounts] window on Mac OS X v10.6) appears.
4. From [Current User] ([My Account] on Mac OS X v10.6), select the currently logged-in user.
5. Select the [Login Items].
 - ⇒ A list of login items appears.
6. From this list, select [ScanSnap Manager].
7. Click the [] button under the list.
 - ⇒ ScanSnap Manager is removed from the list.
8. Close the [Users & Groups] window ([Accounts] window on Mac OS X v10.6).

CardMinder

1. Turn on the computer and log in as a user with Administrator privileges.
2. Exit CardMinder if it is running.
3. From the sidebar in Finder, select [Applications] → [CardMinder], and drag the [CardMinder] folder into the Trash.
4. Empty the Trash.

⇒ The [CardMinder] folder is deleted.

HINT

To delete the database, drag the database file into the Trash.

The default storage location is as follows:

From the sidebar in Finder, select [Documents] → [CardMinder] → [CardMinderDB.cxdb].

ABBYY FineReader for ScanSnap

- 1. Turn on the computer and log in as a user with Administrator privileges.**
- 2. Exit ABBYY FineReader for ScanSnap if it is running.**
- 3. From the sidebar in Finder, select [Applications] → [ABBYY FineReader for ScanSnap], and drag the [ABBYY FineReader for ScanSnap] folder into the Trash.**
- 4. Empty the Trash.**
 - ⇒ The [ABBYY FineReader for ScanSnap] folder is deleted.

ScanSnap Online Update

HINT

Before uninstalling ScanSnap Online Update, check that the following software has not been installed.

- ScanSnap Manager
- CardMinder

- 1. Turn on the computer and log in as a user with Administrator privileges.**
- 2. From the sidebar in Finder, select [Applications] → [ScanSnap Online Update] → [Sub], and then double-click [AOUUninstaller].**
 - ⇒ The [ScanSnap Online Update Uninstaller] window appears, displaying the [Welcome to ScanSnap Online Update Uninstaller] window.
- 3. Click the [Continue] button.**
 - ⇒ The [Read Me] screen appears.
- 4. Read [Read Me], and then click the [Uninstall] button.**
 - ⇒ An authentication window appears.
- 5. Enter the user name and password for a user with Administrator privileges, and click the [OK] button.**
 - ⇒ Uninstallation starts. When the uninstallation is complete, the [Uninstall Succeeded] screen appears.

ABBYY FineReader Express Edition for Mac

1. Turn on the computer and log in as a user with Administrator privileges.
2. Exit ABBYY FineReader Express Edition for Mac if it is running.
3. From the sidebar in Finder, select [Applications] → [ABBYY FineReader Express], and drag [ABBYY FineReader Express] into the Trash.
4. Empty the Trash.
⇒ [ABBYY FineReader Express] is deleted.

Evernote for Mac

1. Turn on the computer and log in as a user with Administrator privileges.
2. Exit Evernote if it is running.

If the Evernote icon () is displayed on the status menu of the menu bar, click the icon and select [Quit] from the menu that appears.
3. From the sidebar in Finder, select [Applications] → [Evernote], and drag the [Evernote] into the Trash.
4. Empty the Trash.
⇒ The [Evernote] is deleted.

Setting Items by Scanning Method

Setting items that you can configure in the ScanSnap setup dialog box/window differ depending on a scanning method. You can select a scanning method in accordance with the usage.

- Profile (→[page 468](#))
- Application (→[page 469](#))
- Save (→[page 470](#))
- Scanning (→[page 471](#))
- File option (→[page 473](#))
- Paper (→[page 474](#))
- Compression (→[page 475](#))

OK and NA in the tables indicate the following:

OK: Available

NA: Not available

For details about setting items and default settings, refer to the ScanSnap Manager Help.

Profile

Profile button

Setting Item	Quick Menu	Profile	 ScanSnap Folder
Recommended	OK	NA	NA
Small File	OK	NA	NA
High Quality	OK	NA	NA
Customize	OK	NA	NA

Profile

Setting Item	Quick Menu	Profile	 ScanSnap Folder
Profile Management	NA	OK	NA

Application

Application



Setting Item	Quick Menu	Profile	ScanSnap Folder
None (Scan to File)	NA	OK	NA
Adobe(R) Acrobat(R)	NA	OK	NA
Adobe(R) Reader(R)	NA	OK	NA
Scan to CardMinder	NA	OK	NA
ScanSnap Organizer	NA	OK	NA
ABBYY Scan to Excel(R)	NA	OK	NA
ABBYY Scan to PowerPoint(R)	NA	OK	NA
ABBYY Scan to Word	NA	OK	NA
ABBYY Scan to Searchable PDF	NA	OK	NA
Scan to Folder	NA	OK	NA
Scan to E-mail	NA	OK	NA
Scan to Picture Folder	NA	OK	NA
Scan to Print	NA	OK	NA
Scan to Rack2-Filer Smart	NA	OK	NA
Scan to Magic Desktop	NA	OK	NA
Scan to SharePoint	NA	OK	NA
Scan to Dropbox	NA	OK	NA
Scan to Evernote (Note)	NA	OK	NA
Scan to Evernote (Document)	NA	OK	NA
Scan to Google Docs(TM)	NA	OK	NA
Scan to Mobile	NA	OK	NA
Scan to Salesforce Chatter	NA	OK	NA
Scan to SugarSync	NA	OK	NA



Setting Item	Quick Menu	Profile
None (Scan to File)	NA	OK
Adobe Acrobat Pro, Adobe Acrobat Professional or Adobe Acrobat Standard	NA	OK
Adobe Reader	NA	OK
Preview	NA	OK
Scan to Folder	NA	OK
Scan to E-mail	NA	OK
Scan to Print	NA	OK
Searchable PDF Converter	NA	OK
CardMinder	NA	OK
Scan to Mobile	NA	OK
Scan to Dropbox	NA	OK
Scan to Evernote (Document)	NA	OK
Scan to Evernote (Note)	NA	OK
Scan to Google Docs(TM)	NA	OK
Scan to Salesforce Chatter	NA	OK
Scan to SugarSync	NA	OK
ABBYY Scan to Word	NA	OK
ABBYY Scan to Excel(R)	NA	OK
ABBYY Scan to PowerPoint(R)	NA	OK
ABBYY Scan to Searchable PDF	NA	OK
iPhoto	NA	OK

Save



Setting Item	Quick Menu	Profile	 ScanSnap Folder
Image saving folder	OK	OK	OK
File Name Format	OK	OK	OK
Rename file after scanning	NA	OK	NA

Scanning

Image quality

Setting Item	Quick Menu	Profile	 ScanSnap Folder
Automatic resolution	OK	OK	OK
Normal (Color/Gray: 150 dpi, B&W: 300 dpi)	OK	OK	OK
Better (Color/Gray: 200 dpi, B&W: 400 dpi)	OK	OK	OK
Best (Color/Gray: 300 dpi, B&W: 600 dpi)	OK	OK	OK
Excellent (Color/Gray: 600 dpi, B&W: 1200 dpi)	OK	OK	OK

Color mode

Setting Item	Quick Menu	Profile	 ScanSnap Folder
Auto color detection	OK	OK	OK
Color	OK	OK	OK
Gray	OK	OK	OK
B&W	OK	OK	OK
 Color high compression	NA	OK	OK

Scanning side

Setting Item	Quick Menu	Profile	 ScanSnap Folder
Duplex Scan	OK	OK	OK
Simplex Scan	OK	OK	OK

Automatic image rotation

Setting Item	Quick Menu	Profile	 ScanSnap Folder
Automatic image rotation	OK	OK	OK



Blank page removal

Setting Item	Quick Menu	Profile	 ScanSnap Folder
Blank page removal	OK	OK	OK

Continue scanning after last page

Setting Item	Quick Menu	Profile	 ScanSnap Folder
Continue scanning after last page	OK	OK	OK

Option

Setting Item	Quick Menu	Profile	 ScanSnap Folder
Reduce bleed-through	OK	OK	OK
Brightness (black & white only)	OK	OK	OK
Increase text contrast	OK	OK	OK
Deskew by text on document	OK	OK	OK
 Place document face up	OK	OK	OK

File option

File format

Setting Item	Quick Menu	Profile	 ScanSnap Folder
PDF (*.pdf)	OK	OK	OK
JPEG (*.jpg)	OK	OK	OK

Set the marked text as a keyword for the PDF file

Setting Item	Quick Menu	Profile	 ScanSnap Folder
First marked section	OK	OK	OK
All marked sections	OK	OK	OK

Convert to Searchable PDF

Setting Item	Quick Menu	Profile	 ScanSnap Folder
Convert to Searchable PDF	OK	OK	OK



Language

Setting Item	Quick Menu	Profile	 ScanSnap Folder
Language	OK	OK	OK

Target pages

Setting Item	Quick Menu	Profile	 ScanSnap Folder
First page	OK	OK	OK
All pages	OK	OK	OK

Option

Setting Item	Quick Menu	Profile	 ScanSnap Folder
Multipage PDF (whole batch in one PDF)	OK	OK	OK
Generate one PDF file per (n) page(s)	OK	OK	OK
 Output in PDF/A-1b	OK	OK	OK
 Set a password for PDF file	NA	OK	OK

Paper

Paper size

Setting Item	Quick Menu	Profile	 ScanSnap Folder
Automatic detection	OK	OK	OK
A4 (210 × 297 mm)	OK	OK	OK
A5 (148 × 210 mm)	OK	OK	OK
A6 (105 × 148 mm)	OK	OK	OK
B5 (JIS) (182 × 257 mm)	OK	OK	OK
B6 (JIS) (128 × 182 mm)	OK	OK	OK
Post card (100 × 148 mm)	OK	OK	OK
Business card (90 × 55 mm, 55 × 90 mm)	OK	OK	OK
Letter (8.5 × 11 in. (216 × 279.4 mm))	OK	OK	OK
Legal (8.5 × 14 in. (216 × 355.6 mm))	OK	OK	OK

Customize

Setting Item	Quick Menu	Profile	 ScanSnap Folder
Customize	OK	OK	OK

Carrier Sheet Settings

Setting Item	Quick Menu	Profile	 ScanSnap Folder
Carrier Sheet Settings	OK	OK	OK

Multifeed

Setting Item	Quick Menu	Profile	 ScanSnap Folder
None	OK	OK	OK
Check Length	OK	OK	OK
Check Overlapping [Ultrasonic]	OK	OK	OK

Compression**Compression rate**

Setting Item	Quick Menu	Profile	 ScanSnap Folder
1 to 5	OK	OK	OK

Purchasing/Cleaning the Carrier Sheet

The Carrier Sheet can be used to scan documents that are larger than A4/Letter size, photographs and clippings.

This section explains about how to purchase/clean the Carrier Sheet.

Purchasing the Carrier Sheet

The product name and part number of the Carrier Sheet are as follows.

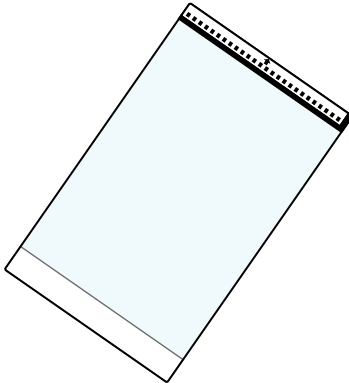
Product Name	Qty.	Part No.
ScanSnap Carrier Sheets 	5 sheets	PA03360-0013

The Carrier Sheet should be replaced approximately every 500 scans. However, replace it if damage or dirt is noticeable.

To purchase the Carrier Sheet, contact your FUJITSU dealer or an authorized FUJITSU scanner service provider.

For more details, refer to the following Web page:

<http://scansnap.fujitsu.com/>

Cleaning the Carrier Sheet

As you keep using the Carrier Sheet, dirt and dust will accumulate on the surface and the inside.

Clean the Carrier Sheet regularly because it may result in scanning errors.

How to perform cleaning

Gently wipe the dirt and dust off the surface and the inside of the Carrier Sheet with a cloth moistened with Cleaner F1/mild detergent.

ATTENTION

- Do not use paint thinner or any other organic solvents.
- Do not use force to rub against the Carrier Sheet because it may be damaged or deformed.
- Be careful not to leave any crease on the Carrier Sheet.
- After cleaning the inside of the Carrier Sheet with a cloth moistened with Cleaner F1/mild detergent, make sure that it is completely dry before closing the Carrier Sheet.
- The Carrier Sheet should be replaced approximately every 500 scans.

Wireless LAN Specifications

The following table summarizes the wireless LAN specifications of the ScanSnap.

Model name	iX500
Observed standards	IEEE802.11b / IEEE802.11g / IEEE802.11n
Frequency (*1)	2.412 GHz to 2.462 GHz / 2.412 GHz to 2.472 GHz
Channels (*1)	1 to 11 ch / 1 to 13 ch
Transfer speed (standard)	IEEE802.11b Max.: 11 Mbps IEEE802.11g Max.: 54 Mbps IEEE802.11n Max.: 72.2 Mbps (Only supports 20 MHz bandwidth) (*2)
Communication mode	Infrastructure mode (*3)
Communication distance (predicted)	Indoors, 50 m (Recommended: indoors, within 25 m) (*4)
Security	WPA-PSK (TKIP/AES), WPA2-PSK (TKIP/AES), WEP (64-bit/128-bit)
Easy installation	WPS 2.0 supported (button / PIN code) (*5)

*1 : Values depend on your country.

*2 : The values indicated on these standards are the maximum value, and do not indicate actual communication speed.

*3 : To use the wireless function, you need a wireless access point that supports the same standards.

*4 : The specifications may vary based on the connected wireless access point and the surrounding environment.

*5 : You need a wireless access point that supports the WPS function.

Installation Specifications

The following table summarizes the installation specifications of the ScanSnap.

Item		Specification
Outer dimensions (Width × Depth × Height)		Min.: 292 × 159 × 168 (mm) / 11.50 × 6.26 × 6.61 (in.) (when the ADF paper chute (cover) is closed) Max.: 292 × 484 × 293(mm) / 11.50 × 19.06 × 11.54 (in.) (when the ADF paper chute (cover) is open and the extension is extended)
Weight		3.0 kg (approx. 6.62 lb)
Input power	Voltage	100 to 240 V
	Phase	Single phase
	Frequency range	50/60 Hz
Power consumption	With USB connected	During operation: 20 W or less During standby: 1.6 W or less
	With wireless LAN connected	During operation: 20 W or less During standby: 2.5 W or less
Temperature/ humidity allowable ranges	Temperature	During operation: 5 to 35°C / 41 to 95°F During standby: -20 to 60°C / -4 to 140°F During storage/transportation: -20 to 60°C / -4 to 140°F
	Humidity	During operation: 20 to 80% During standby: 8 to 95% During storage/transportation: 8 to 95%

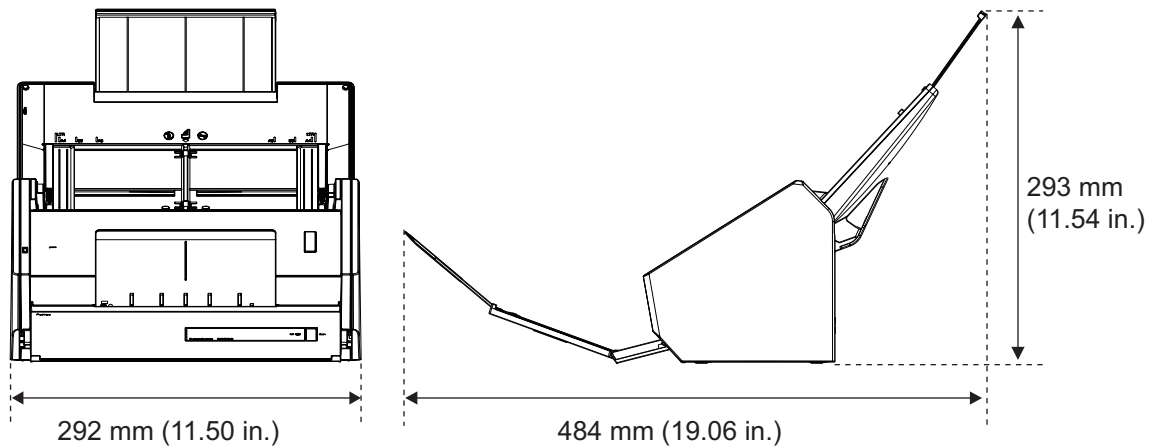

About Maintenance

Contact your FUJITSU scanner dealer or an authorized FUJITSU scanner service provider for repairs on this product.

For more details, refer to the following Web page:

<http://imagescanner.fujitsu.com/warranty.html>

ATTENTION

For safety reasons, never attempt repairs by yourself.

Index

A

ABBYY FineReader Express Edition	
for Mac	70
ABBYY FineReader for ScanSnap	69
Windows	78
Mac OS	98
ABBYY Scan to Excel(R)	190, 361
ABBYY Scan to PowerPoint(R)	190, 361
ABBYY Scan to Word	190, 361
adding profiles	
Windows	204
Mac OS	370
ADF paper chute (cover)	32, 33
ADF release tab	33
ADF top section	33
Adobe Acrobat XI Standard	70
attach to e-mail	
Windows	137
Mac OS	299
automatic linkage	
Windows	276
Mac OS	430

B

brake roller	447
--------------------	-----

C

CardMinder	69
Windows	78, 129
Mac OS	98, 319
Carrier Sheet	476
Windows	240, 245
Mac OS	397, 402

Cleaner F1	439
------------------	-----

Cleaning

Carrier Sheet	477
cleaning materials	439
inside of the ScanSnap	441
outside of the ScanSnap	440
Cleaning Wipe	439
color high compression	226
configuring ScanSnap Manager	
Windows	268
Mac OS	421
consumables	447
copy	
Windows	142
Mac OS	304
correct skewed character strings	
Windows	231
Mac OS	388

D

deleting blank pages	
Windows	228
Mac OS	385
deleting profiles	
Windows	212
Mac OS	378
documents for scanning	58
Dropbox for Mac	70, 106
Dropbox for Windows	70, 83

E

Evernote for Mac	69, 108
Evernote for Windows	69, 85

-
- extension 33
- F**
- features of the ScanSnap 23
- G**
- generate one PDF file per (n) page(s)
- Windows 251
 - Mac OS 408
- H**
- how to load documents 63
- how to perform a scan 42
- Windows 114, 203, 216
 - Mac OS 286, 369
- I**
- install 68
- iPhoto 367
- K**
- keyword
- Windows 256
 - Mac OS 414
- L**
- Left-Click Menu 203
- M**
- Magic Desktop 150
- Magic Desktop trial version 70
- marker
- Windows 256
 - Mac OS 414
- O**
- Online Update 458
- operating system
- Windows 71
 - Mac OS 74
- P**
- PDF/A file 262
- pick roller 447
- power connector 34
- power ON 45
- print
- Windows 142
 - Mac OS 304
- [Print] Window 306
- Profile menu 369
- Q**
- Quick Menu 41
- Windows 119, 271
 - Mac OS 291, 424
- R**
- Rack2-Filer Smart 146
- Rack2-Filer Smart trial version 70
- reduction of image bleed-through
- Windows 234
 - Mac OS 391
- renaming profiles
- Windows 210
 - Mac OS 376
- replacing the Roller set 450
- Right-Click Menu 37
- Roller set 447
- S**
- [Scan] button 33
- Scan to Dropbox
- Windows 162
 - Mac OS 334

-
- Scan to E-mail
 - Windows 139
 - Mac OS..... 301
 - Scan to Evernote (Document)
 - Windows 167
 - Mac OS..... 339
 - Scan to Evernote (Note)
 - Windows 171
 - Mac OS..... 343
 - Scan to Folder
 - Windows 132
 - Mac OS..... 296
 - Scan to Google Docs(TM)
 - Windows 174
 - Mac OS..... 345
 - Scan to Magic Desktop 151
 - Scan to Microsoft SharePoint..... 70, 90
 - Scan to Mobile
 - Windows 156, 158
 - Mac OS..... 324, 326, 329
 - Scan to Picture Folder 200
 - Scan to Print
 - Windows 143
 - Mac OS..... 305
 - Scan to Rack2-Filer Smart..... 148
 - Scan to Salesforce Chatter
 - Windows 178
 - Mac OS..... 350
 - Scan to SharePoint 197
 - Scan to SugarSync
 - Windows 185
 - Mac OS..... 356
 - scanning color documents in black & white or gray mode
 - Windows 224
 - Mac OS..... 383
 - ScanSnap Folder 216
 - ScanSnap Manager..... 69
 - Windows 78
 - Mac OS..... 98
 - ScanSnap Manager menu 39
 - ScanSnap Online Update 69
 - Windows 78
 - Mac OS 98
 - ScanSnap Organizer 69, 78, 126
 - ScanSnap password 52, 54
 - [ScanSnap Setup] dialog box 76
 - ScanSnap setup dialog box..... 268, 269
 - ScanSnap setup window..... 421, 422
 - [ScanSnap] window 96
 - ScanSnap Wireless Setup Tool 52
 - ScanSnap's communication status
 - Windows 280
 - Mac OS 432
 - searchable PDF file
 - Windows 253
 - Mac OS 312, 313, 410
 - security cable slot 34
 - shared folder
 - Windows 131
 - Mac OS 295
 - showing the scanning progress status
 - Windows 283
 - Mac OS 435
 - side guide..... 33
 - simplex scan
 - Windows 222
 - Mac OS 381
 - sleep mode..... 48
 - SugarSync Manager for Mac..... 70, 111
 - SugarSync Manager for Windows 70, 88
 - system requirements
 - Windows 71
 - Mac OS 74
- T**
- trial software 92
 - turning ON/OFF..... 47, 49

U

uninstalling	
Windows	460
Mac OS.....	462
USB connector	34

W

Wi-Fi indicator	33
Wi-Fi switch.....	34
wireless LAN	42, 44, 50
wireless LAN connection	
computer to the ScanSnap	54
mobile device to the ScanSnap.....	55
wireless access point to the ScanSnap ...	52
WPS button.....	34

ScanSnap iX500 Operator's Guide
P3PC-4202-03ENZO
Issue date: July 2013
Issued by: PFU LIMITED

- The contents of this manual are subject to change without notice.
- PFU LIMITED assumes no liability for incidental or consequential damages arising from the use of this product, and any claims by a third party.
- Copying of the contents of this manual, in whole or in part, as well as the scanner applications is prohibited under the copyright law.