

INSTRUCTION MANUAL



METODO
IPERESPRESSO



GENERAL OPERATING RULES

Carefully read the instruction manual and warranty limitations

The machine must be connected to a grounded power outlet. The machine must be kept clean by frequently washing the grid, the drip tray, the capsule holder, the tank, the steam knob

EXTREMELY IMPORTANT: never immerse the machine in water or put it in the dishwasher. The water contained in the tank must be replaced regularly. Do not use the machine if the tank is empty

After changing the water, insert the water tank into the machine, making sure that it is completely inserted

*It is recommended to remove calcium deposits at least every two months using a decalcification agent made especially for espresso machines according to instructions in the **DECALCIFICATION** chapter*

The boiler is fitted with a valve that maintains constant pressure, for this reason some water may drip from the capsule holder

table of contents

■ MACHINE PARTS	30
■ IMPORTANT SAFEGUARDS	32
USING THE ESPRESSO MACHINE	32
INSTALLATION OF THE ESPRESSO MACHINE	32
CLEANING THE ESPRESSO MACHINE	33
IN CASE OF MALFUNCTIONING	33
IMPROPER USE OF THE ESPRESSO MACHINE	33
■ INSTALLATION AND START-UP OF ESPRESSO MACHINE	34
■ TURNING ON/OFF	35
■ MAKING COFFEE	36
■ MAKING CAPPUCCINO	38
■ MAKING HOT WATER	40
■ PREPARING COFFEE AFTER GENERATING STEAM	41
■ DECALCIFICATION	42
■ CLEANING AND MAINTENANCE	44
■ TECHNICAL DATA	45
■ RECOMMENDATIONS	45
■ TROUBLESHOOTING	46
■ WARRANTY LIMITATIONS	48

machine parts

- A** ON/OFF SWITCH
(lights up when the machine is on)
- B** COFFEE SWITCH ON/OFF
(lights up when temperature is ok)
- C** STEAM SWITCH (lights up if activated)
- D** TEMPERATURE DISPLAY coffee ok -
steam ok - water tank empty
- E** "METODO IPERESPRESSO"
CAPSULE HOLDER
- F** BREWING UNIT
- G** STEAM ARM
- H** STEAM TIP
- I** DRIPTRAY FULL INDICATOR
- L** STEAM KNOB
- M** DRIP TRAY

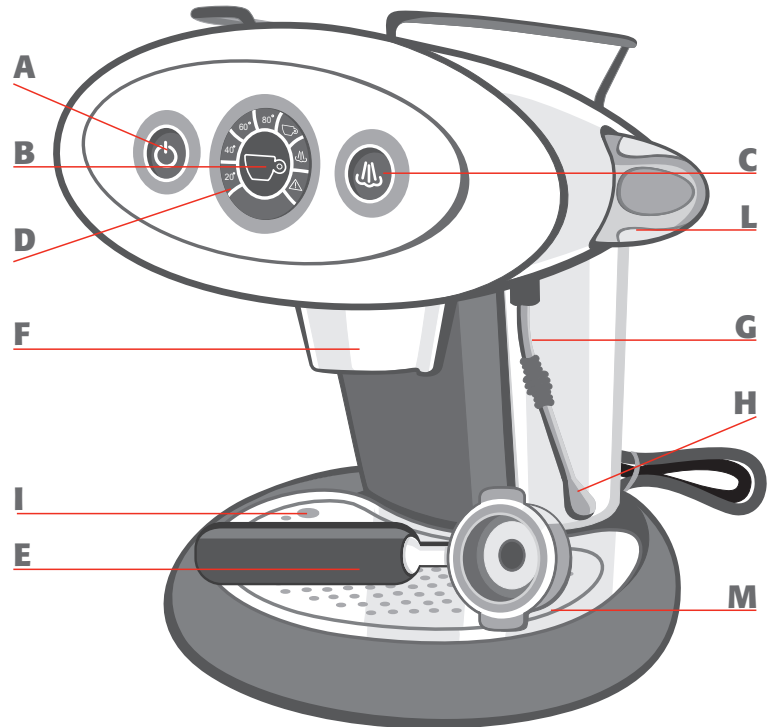

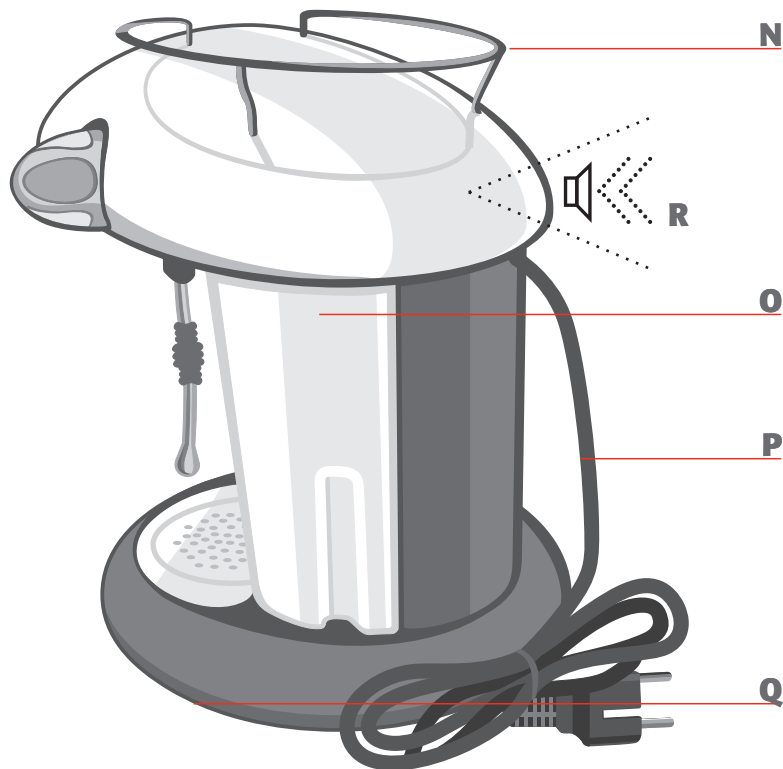

- N** CUP HOLDER
- O** WATER TANK
- P** POWER CORD
- Q** DATA PLATE (below)
- R** ALARM if active indicates machine is on or there is an irregular functioning

IMPORTANT SAFEGUARDS

When using your coffee maker, basic safety precautions should always be followed, including the followed to reduce the risk of fire, electric shock, and/or injury to persons including the following:

1. Read all instructions
2. Do not touch hot surfaces. Use handles or knobs
3. To protect against electric shock, do not place cord, plug, or appliance in water or other liquid
4. Close supervision is necessary when any appliance is used by or near children
5. Unplug from the outlet when not in use and before cleaning. Allow to cool before putting on or taking off parts, and before cleaning the appliance
6. Do not operate any appliance with a damaged cord or plug or after the appliance malfunctions, or has been damaged in any manner. Return appliance to an authorised service facility for examination, repair or adjustment
7. The use of accessory attachments not recommended by the appliance manufacturer may result in fire, electric shock or injury to persons
8. Do not use outdoors
9. Do not let cord hang over edge of table or counter, or touch hot surfaces
10. Do not place on or near a hot gas or electric burner, or in a heated oven
11. Always attach plug to appliance first, then plug cord into the wall outlet. To disconnect, turn any control to the off position, then remove plug from wall outlet
12. Do not use appliance for other than intended use
13. Save these Instructions

USING THE ESPRESSO MACHINE

- This appliance is intended for household use only. Any other use is to be considered improper and therefore dangerous

- Unplug the appliance from the power socket when the appliance is not in use

- Do not touch hot surfaces. Use handles and switches

- This machine is manufactured to "make espresso coffee" and to "warm up beverages": use care to prevent scalding due to water jets or any improper use of the machine

- The appliance must not be used by children

- The appliance must be used solely by adults in no altered psycho-physical conditions

- Use the appliance indoors only and away from atmospheric agents

- To protect against fire, electric shock or personal injury do not immerse the cord, the plug or the body of the machine in water or any other liquid

- Do not use the appliance for purposes other than its intended use

- Do not place the appliance on electrical or gas burners nor inside a hot oven

- The appliance must be turned on only when the machine is used. It must then be turned off by pressing the ON/OFF switch  and the plug must be disconnected from the power socket

- Before unplugging the appliance make sure that the ON/OFF switch  is off and not lit up **1**

- Using attachments not recommended by the manufacturer may result in fire, electric shock, or personal injury

- Do not let the cord hang over tables or countertops

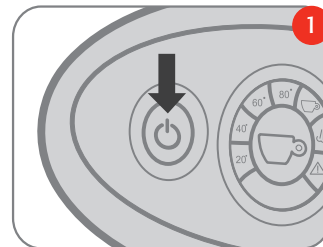

INSTALLATION OF THE ESPRESSO MACHINE

- Read the instructions carefully
- Do not install the machine in an area where the temperature may reach or be lower than **0°C/30°F** (if water freezes, the appliance may be damaged) and higher than **40°C/140°F**
- Check that electric voltage corresponds to the requirements indicated in the data plate on the machine. Connect the machine only to a grounded power socket with minimum voltage of **6 A** if power required is **230 Vac** and **12 A** if power required is **120 Vac**
- If the plug and the socket are not compatible, have the plug replaced by qualified personnel
- Place the appliance on a countertop away from water taps and sinks
- After removing the packaging, check that the appliance is intact before installation

CLEANING THE ESPRESSO MACHINE

- Unplug the machine from the power supply before cleaning the appliance
- Before unplugging the machine check that the ON/OFF switch  is off and not lit up **I**
- Wait for the appliance to be cold before cleaning
- Clean the body and attachments with a wet cloth and then wipe with a dry cloth. Do not use detergents
- Do not expose the machine to extended water jets or partial or full immersion in water

IN CASE OF MALFUNCTIONING

- Do not use the appliance if the cord or plug are damaged or if the appliance shows signs of malfunctioning or if it has been damaged in any way. Return the appliance to the nearest authorized dealer for checks or repairs
- If the power cord is damaged, it must be replaced by the manufacturer or a certified assistance center
- In case of faults or malfunctioning, turn off the appliance and do not tamper with it. For repairs contact a Technical Assistance Center authorised by the manufacturer and request the use of original spare parts only. Failure to comply with these instructions may compromise safe operation of the machine and will not be covered by warranty

IMPROPER USE OF THE ESPRESSO MACHINE

- This appliance is intended for household use only. Any other use is to be regarded as improper
- The manufacturer is not liable for accidents caused by lack of or non conformity to existing legislation on grounding requirements
- The manufacturer is not liable for possible damage caused by improper, incorrect or unreasonable use

WARNING: SAVE THESE INSTRUCTIONS

installation and start-up of espresso machine

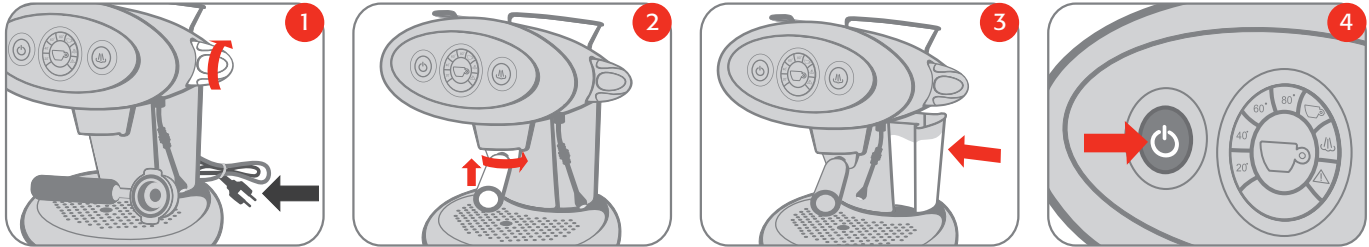

Before connecting the appliance to a power supply, carefully read the safeguards listed in the previous chapter

Check that the steam knob is closed and the machine is disconnected from the power supply **1**

Twist the capsule holder firmly in place **2**

Remove the tank, wash it, fill it with cold water and put it back in place making sure it is positioned correctly **3**

Connect the machine to a power socket

To turn on the machine press switch  until it lights up **4**

If necessary the boiler filling system activates automatically

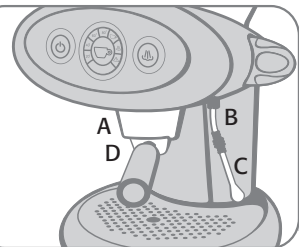

It is recommended to keep the original packaging (at least for the duration of the warranty period) in case the machine needs to be shipped to an Assistance Center for repairs

WARNING:

When the machine is in use, contact with the brewing unit **A**, the steam arm **B** and **C**, and the metal part of the capsule holder **D** may cause scalding

turning on/off

Adjust the water level in tank by adding cold water **1**

To turn on the machine press switch  until it lights up **2**

If necessary the boiler filling system activates automatically

The icons in the top display light up to indicate the increase of the temperature in the boiler **3**

After a few minutes the machine signals that operating temperature has been reached by lighting up the coffee switch  and emitting a short beep **4**

If the triangular icon  lights up and the beep is intermittent, refer to the **TROUBLESHOOTING** section

NOTE: Before using the machine for the first time or after a long period of inactivity, it is suggested to flush it out a few times without the capsule **5**

To turn off the machine, press switch  until the front display turns off. It is recommended not to unplug the machine when the machine is on **6**

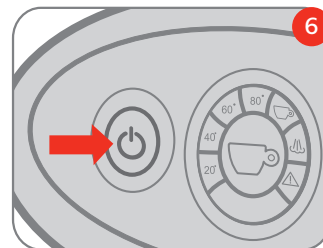
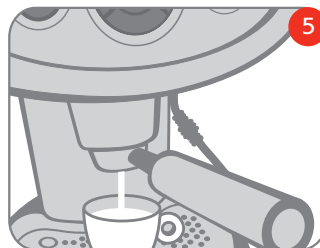
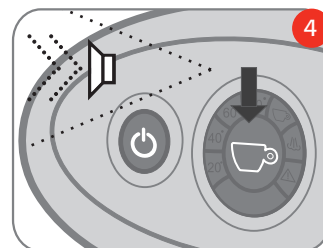
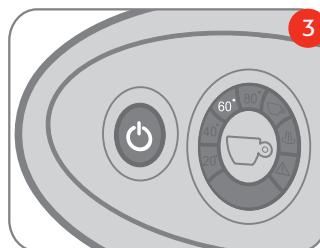
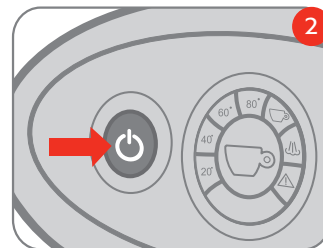
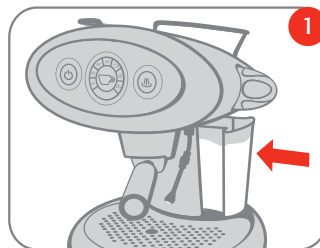

making coffee

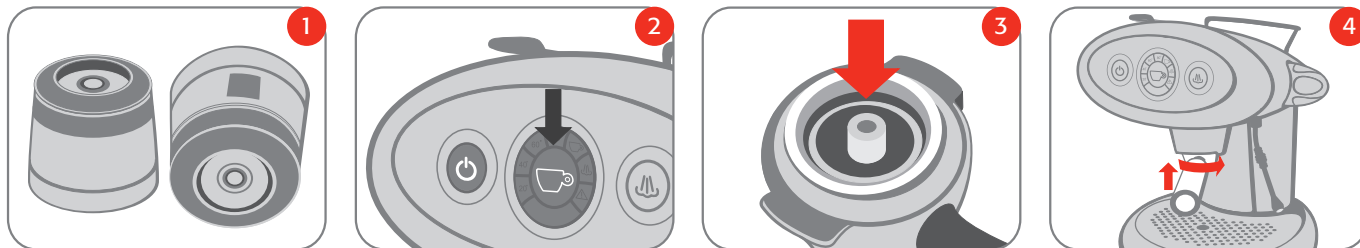

The X7 machine is designed to function exclusively with “Metodo lperespresso” capsules **1**

Dosing is performed automatically by the machine

To change the quantity of coffee in the cup and set a new value, press the coffee switch **5** until you have obtained the desired quantity, then release the switch

It is possible to eliminate the automatic dosage function, following the instructions above, keeping the delivery button pressed until the machine itself blocks the delivery, then release the button

To set the automatic dosage again, follow the instructions at the beginning

The automatic dosage can be avoided by pressing the delivery button 5 for longer than 3 seconds; to stop delivery press button 5 again

Check that the coffee switch  is lit up **2**

Twist the capsule holder, insert a capsule **3**, re-position the capsule holder in the brewing unit and twist it to the right until it is locked in place **4**

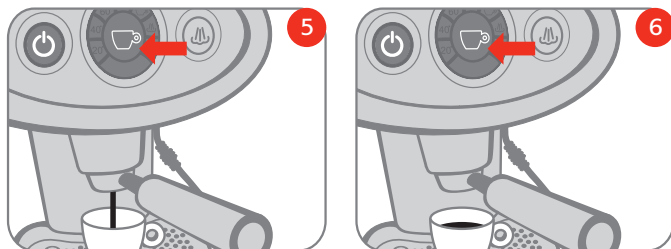

Press the coffee switch  to start making coffee **5**

Coffee dispensing will stop automatically once the set quantity is obtained, to stop dispensing before the set quantity is obtained press the coffee switch **6** again

Remove the capsule from the capsule holder and repeat the steps above for each cup

The brewing cycle consists of a first phase called "pre-infusion" (short injection of water in the capsule followed by a pause) lasting about 3 seconds and a second phase for brewing

WARNING:

- For safety reasons, brewing stops automatically after approx. 1 minute
- Do not use distilled or demineralised water to make coffee. It may compromise the proper functioning of the machine
- Remember to empty and clean the drip tray regularly
- Remember to replace the water in the tank frequently

making cappuccino

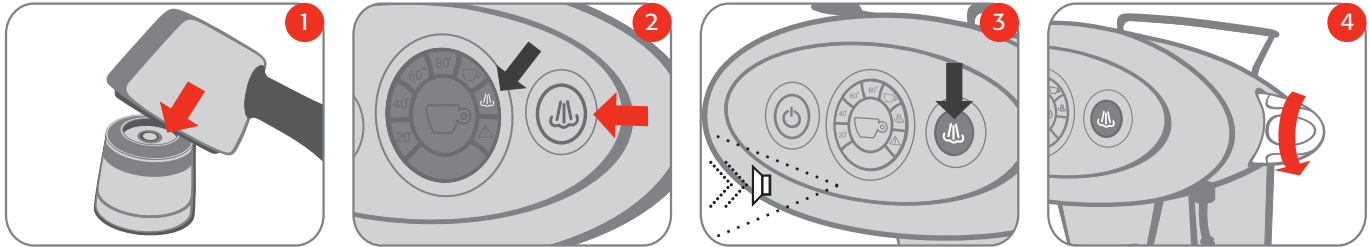

The machine is fitted with a steam arm to froth milk and prepare one or more cappuccinos

Prepare one or more coffees following the steps outlined below

Froth the milk as follows:

Remove the capsule from the unit **1**

Press the steam switch  **2**; the steam icon located on the central display lights up to indicate the machine is warming up

Wait for the steam switch  to light up **3** (machine ready) followed by a short beep

Take fresh milk from the refrigerator and pour it in a pitcher (preferably metal)

Turn the steam knob **4** counterclockwise, allow any residual water to exit the nozzle until steam is produced and close the steam knob by turning it clockwise

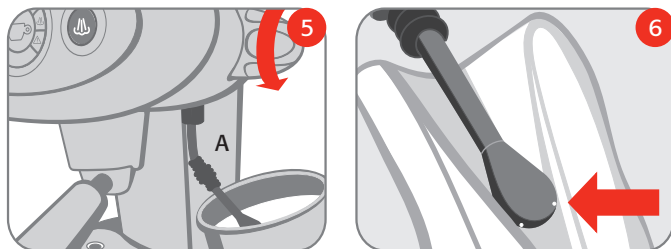

Immerse the steam arm in the milk **5**, turn the steam knob counterclockwise and wait for the milk to froth

Close the steam knob by turning it clockwise

Pour the froth and the milk in the cups containing coffee

Clean the steam arm with care to remove milk residue with a cloth and turn knob to open, releasing some steam to remove milk residue from the inside of the steam arm **6**

WARNING:

- Contact with steam and the steam arm A may cause serious scalding
- Do not turn on the steam knob when the machine is cold and the nozzle is immersed in water
- When generating steam for extended periods of time the automatic boiler filling system repeatedly activates the pump for brief intervals
- If the steam is not used for a few minutes, the machine automatically returns to the coffee position
- After a prolonged delivery of steam, which in the 120 V version can last up to 8 minutes at most, in order to prevent overheating, only the coffee preparation could remain operative. This happens if, when the steam button is pressed, the machine does not light up the steam icon situated on the circular crown, but makes the coffee icon flash
- When heating and functioning in steam mode, the boiler in the machine heats up and may generate slight releases of steam from the bottom capsule holder: therefore avoid keeping extremities or other body parts near the coffee dispensing area to prevent scalding

making hot water

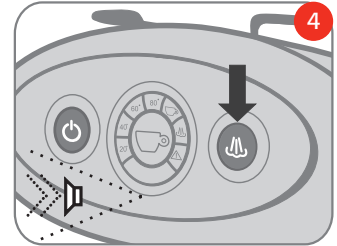
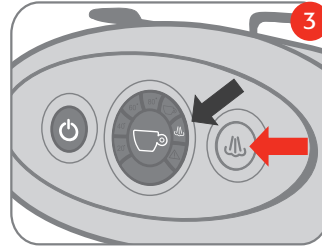
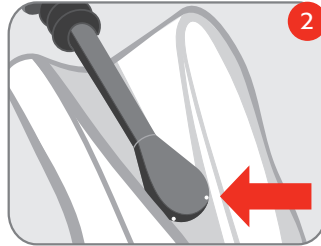
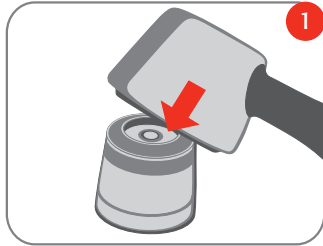

The steam arm fitted to the machine can also heat up water

Remove the capsule from the unit **1** and any milk residue from the steam arm **2**

Press the steam switch ; the steam icon on the front display lights up to indicate that the machine is heating up **3**

Wait for the steam switch  to light up (machine ready) followed by a short beep **4**

Fill a metal pitcher with the desired quantity of water to be heated

Immerse the steam arm in the water and open the steam knob by turning it counterclockwise **5**;
close the steam knob by turning it clockwise after reaching the desired temperature **6**

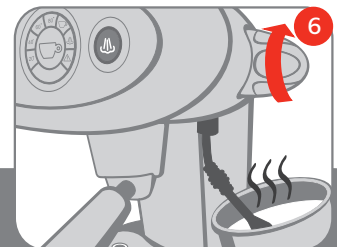
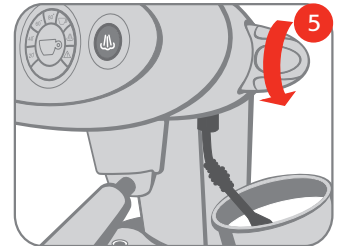

WARNING:

When heating and functioning in steam mode, the boiler in the machine heats up and may generate slight releases of steam from the bottom capsule holder: therefore avoid keeping extremities or other body parts near the coffee dispensing area to prevent scalding

preparing coffee after generating steam

It is very important to avoid preparing an espresso immediately after generating steam because the water heated by the boiler is too hot and may compromise the taste of coffee

For this reason the coffee switch is inactive when the temperature inside the boiler is too high (coffee switch **1** off)

To return to coffee making, press the coffee switch  and wait for the switch to light up **2**; during the cooling phase (approx. 10 minutes), the cup icon on the temperature display lights up

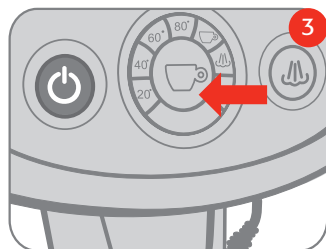
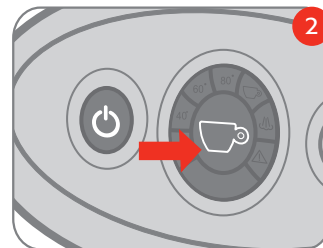
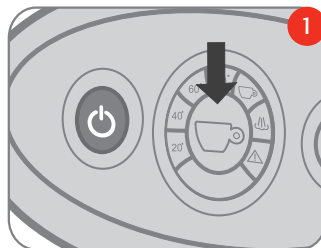

To resume coffee making in a shorter period of time (approx. 1 minute) follow these instructions:

Press the coffee switch  **3**

Press the coffee switch  **3**

Place a pitcher under the steam arm; turn on the steam knob counterclockwise to generate steam until the machine emits a short beep and the coffee switch lights up **4**

Close the steam knob by turning it clockwise **5**; the machine is ready to make an espresso **6**

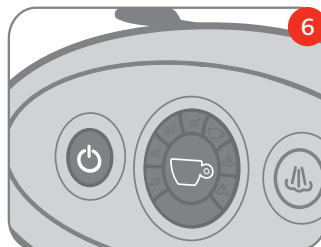
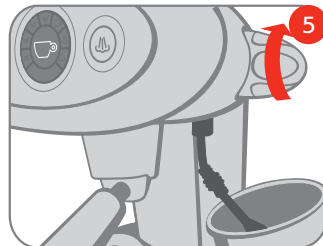
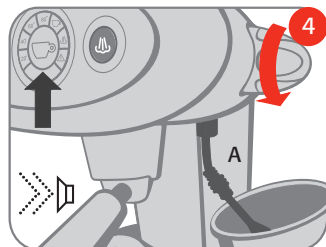

decalcification

The machine keeps track of its overall use and based on the quantity of coffee or steam delivered may require a decalcifying cycle, signaled by the flashing of the triangular icon (1 flash every 2 seconds) **A**

The machine is equipped with an automatic program for optimum cleaning and removal of calcium residue from the inside of the machine

To perform the cleaning program it is advisable to use the decalcifying agent supplied with the machine **B**

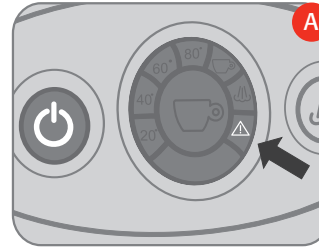

Starting the procedure:

Fill the tank with 1 liter of water (up to the MAX level) **1**; pour in the decalcifying product supplied with the machine; wait for it to dissolve

Remove the capsule and the holder, place an empty container with a capacity of at least 1 Lt under the delivery unit **2**

Press the coffee switch ☐ and the steam switch ☐ simultaneously for at least 5 seconds **3**; the coffee switch ☐ and the triangular icon ☐ start flashing **4**

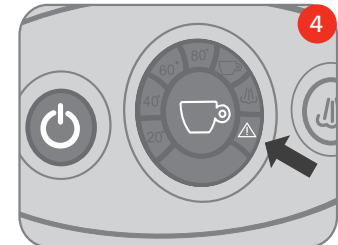
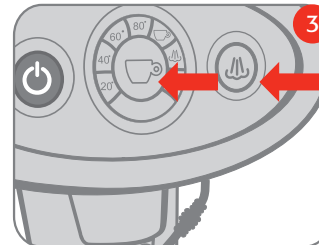
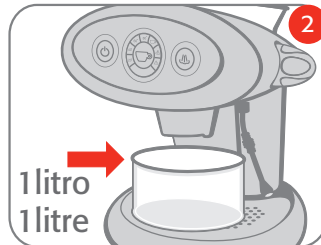
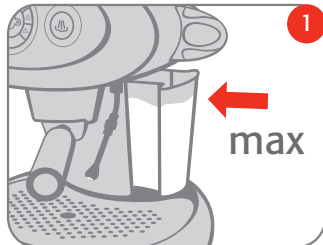

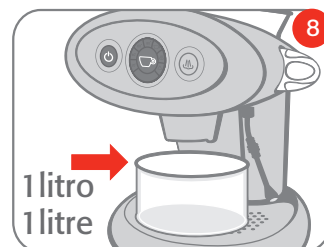
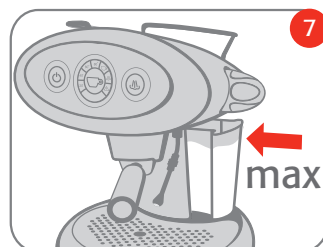
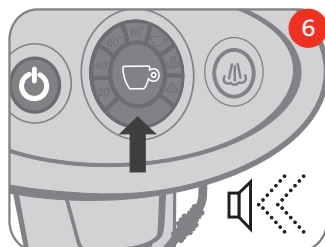
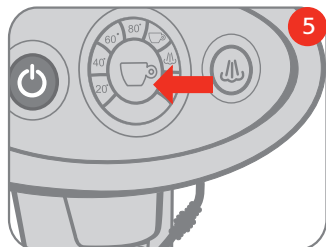

Press the coffee switch  to start the decalcification cycle the coffee switch  turns off **5**

The machine automatically starts performing washing cycles at set intervals

At the end of the automatic decalcification cycle, lasting approx. a half hour, the machine emits a beep and the coffee switch  starts flashing again **6**

Remove and empty the tank; wash it and fill it with 1 lt of fresh water (up to the MAX level) **7**; empty the container and place it under the delivery unit **8**

Press the coffee switch to start the rinsing cycle; the coffee switch  turns off **9**

The machine starts delivering water at set intervals lasting a few minutes

At the end of the rinsing cycle the triangular icon stops flashing and the machine emits beep **10**

Empty the container

The machine is ready to be used

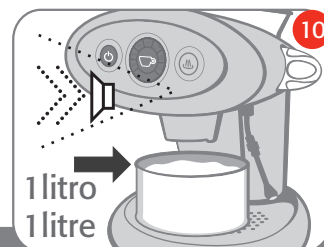
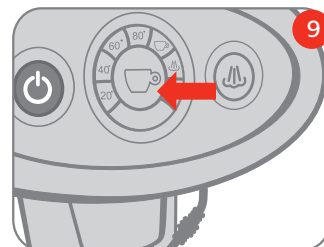

WARNING:

- Should a power outage occur while performing the decalcification procedure, it will be necessary to repeat the procedure from the start
- If the decalcification procedures are not performed, calcium may cause malfunctioning not covered by the warranty
- It is advisable to use our decalcification agent **B**
- Do not use vinegar, lye, salt, formic acid because they may damage the machine

cleaning and maintenance

To ensure correct functioning and a high quality standard, it is advisable to clean the machine regularly and with care

Operations to be performed when the machine is cold and disconnected from the power supply:

- O** cleaning the water tank
- G** cleaning the steam arm and removing milk residue from the arm
- E** cleaning the capsule holder
- M** cleaning the grid
- S** cleaning the driptray

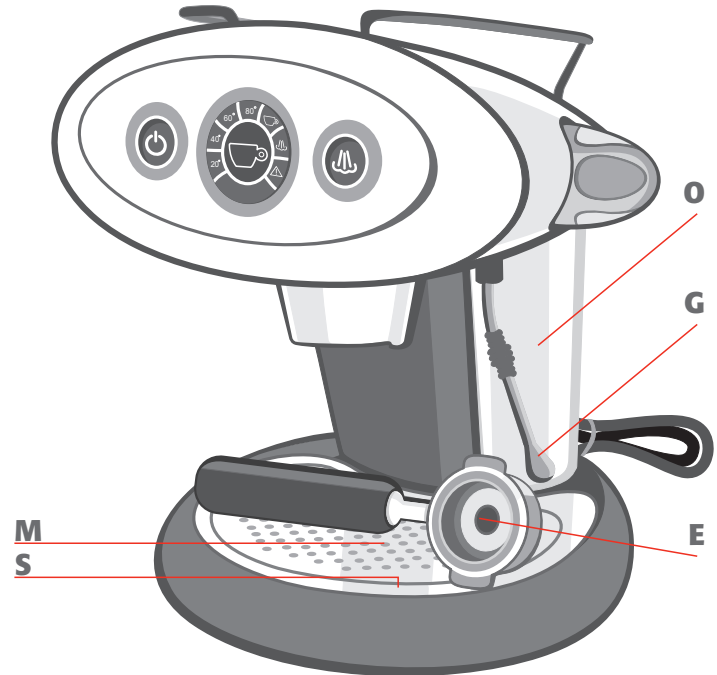

WARNING:

- Do not clean the machine with aggressive detergents (methanol, methyl chloride, acetone, aromatic hydrocarbons) that may damage the surfaces
- Before performing clearing and maintenance procedures, unplug the machine from the power socket

technical data

Casing: polycarbonate

Internal boiler: brass

Tank: 1.2 liters

Pump: 15 bar

Solenoid valve

Electronic card with the following functions:

- automatic dosage of coffee delivery
- high precision temperature control (coffee and steam)
- boiler water level control and refill
- decalcification indicator
- boiler temperature indicator
- acoustic alarm
- automatic decalcification program

Steam arm

Top cup warmer

Weight without packaging: 6 Kg

Voltage: 230 V, 50 Hz (EU); 120 V, 60 Hz (USA)

Power: 1050 W (EU); 1100 W (USA)

The manufacturer reserves the right to make changes or improvements without notice

recommendations

To enjoy a high quality espresso, remember to:

- Change the water in the tank and empty the drip tray at least once a week
- Use water with low calcium content to reduce deposits inside the machine
- Use the cup warmer

PROBLEM

SOLUTION

<p>The machine is on but switch  does not light up A</p>	<ul style="list-style-type: none"> - Check that the machine is connected to a power supply; check the safety switches of your home power supply system
<p>No coffee comes out</p>	<ul style="list-style-type: none"> - Fill the tank, make sure it is securely inserted - Make sure the steam knob is completely closed - Remove the capsule holder from the unit - Wait until coffee switch is lit (machine is ready to make coffee) - Put a cup under the brewing unit and press coffee switch - Let water run for a few seconds - Press coffee switch again to stop flow - Put in a new capsule in the capsule holder and turn capsule holder firmly into place (turn handle to the Stop E position) and then try to make coffee again B
<p>I turn the knob but the machine does not generate steam Steam is generated but milk does not froth</p>	<p>Case a) If the temperature display steam icon D is on, wait for the steam icon C to light up</p> <p>Case b) If the temperature display steam icon D is off, press the steam switch and wait for the steam switch to light up (heating)</p> <p>Case c) The steam nozzle could be obstructed: turn off the machine; wait for the machine to cool (at least one hour); remove any obstruction from the holes of the steam nozzle G</p>
<p>Water leaks from the unit when making coffee</p>	<ul style="list-style-type: none"> - Check that the capsules are for household use (the top of the capsule is the same colour as the bottom) and not for professional use (the top of the capsule is transparent) - Insert a new capsule in the capsule holder twist the holder in position until locked in place E and make coffee B
<p>Rapid beeping and triangular icon is flashing</p>	<p>Perform the following operations:</p> <ul style="list-style-type: none"> - Turn off the machine - Fill the water tank - Place a pitcher under the steam nozzle and open the steam knob - Turn on the machine wait approx. 10 seconds - Close the steam knob wait for the coffee switch to light up
<p>Triangular icon is flashing slowly</p>	<ul style="list-style-type: none"> - Perform decalcification cycle
<p>Water leaks from inside the machine</p>	<ul style="list-style-type: none"> - Turn off the machine; disconnect the appliance from the power supply

Contact
Assistance

PROBLEM

SOLUTION

The water tank leaks after it has been filled

- Empty the water tank, press the transparent rubber washer of the connection valve inside the tank firmly into place

After having pressed the steam button, the machine does not light up the steam icon situated on the circular crown which shows the preparation phase, but the coffee icon flashes

- The machine needs to cool down after a prolonged delivery of steam; wait a few minutes and the machine will begin working again

Coffee drips from capsule before extraction starts

- Some dripping during the first few seconds of extraction is normal

*Contact
Assistance*

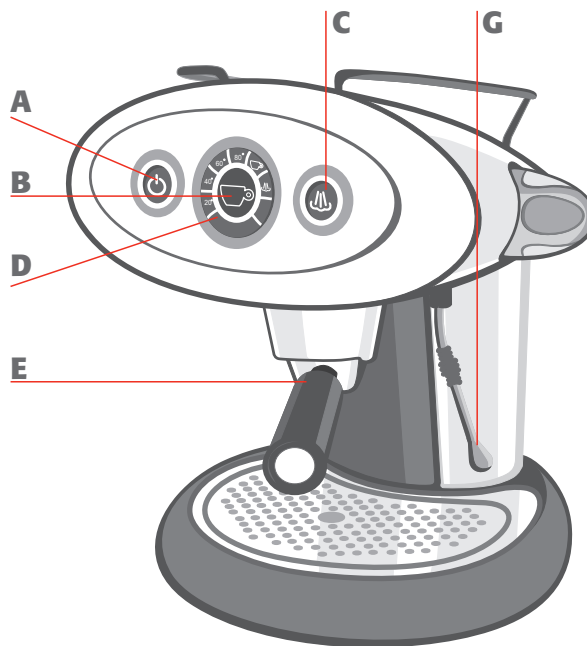

warranty limitations

The warranty does not cover damage caused by:

- Damage caused by calcium or by a lack of periodical decalcification
- Damage caused by operation with a voltage that differs from the one indicated on the plate
- Damage caused by improper use or use that is not compliant with the instructions
- Damage caused by internal modifications

Furthermore the warranty does not cover repair costs on machines previously handled by non authorised assistance centers, which will be entirely charged to the client

Lastly:

- Do not place the driptray in the dishwasher
- Keep the internal bottom of the tank holding column always dry

Failure to observe these instructions may cause problems to the body of the machine not covered by the warranty

WARNING:

It is advisable to keep the original packaging (at least for the duration of the warranty period) to ship the machine to the assistance centers for repair

Any damage caused by transport without adequate packaging will not be covered by the warranty



The WEEE symbol used on this product means that it can not be disposed of with other domestic waste and must be collected separately.

Consumers now have the opportunity to hand-in their used appliance free of charge on a 1:1 basis when they purchase a new product. For further information regarding the used appliance collection points, please contact the town of residence, the local waste disposal service or nearest retailer. Consumers are responsible for disposing of used appliances according to current laws and the non-compliance thereof will attract fines and criminal sanctions. The correct disposal of these products will contribute to protecting the environment and natural resources as well as human health. Disposal of used electric and electronic appliances for private individuals in the EU. The WEEE symbol used for this product indicates that it is not to be disposed of with other household waste and should be disposed of separately. Private consumers have the opportunity to hand in their used appliance free of charge on a 1:1 basis when they purchase a new product. For further information regarding the used appliance collection points, please contact the local authority in your town of residence, the local waste disposal service or the nearest retailer where the product was purchased. Consumers are responsible for disposing of used appliances according to current laws and non-compliance thereof may be sanctioned. The correct disposal of this product will contribute to protecting the environment, natural resources and human health.



