

USER MANUAL

ProLite

LCD Monitor

ENGLISH

ProLite B2480HS
ProLite E2480HS

Thank you very much for choosing the iiyama LCD monitor.
We recommend that you take a few minutes to read carefully through this brief but comprehensive manual before installing and switching on the monitor. Please keep this manual in a safe place for your future reference.





Dear user, we congratulate you on the purchase of your iiyama LCD.

For details on warranty and locally used pixel policies that apply directly after installation of your product please check the iiyama website.

To report a fault, please contact your local support centre found at www.iiyama.com/service

Things to check before you call the iiyama information line

- | if the power cable is connected securely and turned on?
- | if the display has been turned on?
- | if the signal cable is connected securely and the correct input selected?
- | if the computer has been restarted with the display connected?
- | if the graphics card is correctly installed with the latest drivers possible?
- | if the correct native resolution has been selected via 'Display Properties'?
- | If the R/G/B signal configuration is correct?
- | if the displays On Screen Menu is shown?
- | if the correct brightness and contrast settings have been set?
- | if given display tolerances and compatibility have been considered?
- | if via the On Screen Menu you have performed a Factory Reset/Recall?

Before reporting the screen defect, please prepare the following information/evidence:

- | model number *
- | purchase receipt and serial number *
- | name and address for collection
- | telephone/fax number, for availability during the day
- | convenient collection date (date, time)
- | short description of the defect

Important Note:

If there is no fault found in the collected equipment after inspection, the transferring party shall incur charges for transport and administration.

If you have checked all of the above and there is still no picture, call our information line for assistance in your country.

* see the identification plate on the back of the case.

Congratulations!

This display is designed for both you and the planet!



The display you have just purchased carries the TCO Certified label. This ensures that your display is designed, manufactured and tested according to some of the strictest quality and environmental requirements in the world. This makes for a high performance product, designed with the user in focus that also minimizes the impact on the climate and our natural environment.

TCO Certified is a third party verified program, where every product model is tested by an accredited impartial test laboratory. TCO Certified represents one of the toughest certifications for displays worldwide.

Some of the Usability features of the TCO Certified for displays:

- Visual ergonomics for good image quality is tested to ensure top performance and reduce sight and strain problems. Important parameters are luminance, contrast, resolution, black level, gamma curve, colour and luminance uniformity and colour rendering
- Products are tested according to rigorous safety standards at impartial laboratories
- Electric and magnetic fields emissions as low as normal household background levels
- Low acoustic noise emissions (When applicable)

Some of the Environmental features of the TCO Certified for displays:

- The brand owner demonstrates corporate social responsibility and has a certified environmental management system (EMAS or ISO 14001)
- Very low energy consumption both in on- and standby mode minimize climate impact
- Restrictions on chlorinated and brominated flame retardants, plasticizers, plastics and heavy metals such as cadmium, mercury and lead (RoHS compliance)
- Both product and product packaging is prepared for recycling
- The brand owner offers take-back options

The requirements can be downloaded from our web site. The requirements included in this label have been developed by TCO Development in co-operation with scientists, experts, users as well as manufacturers all over the world. Since the end of the 1980s TCO has been involved in influencing the development of IT equipment in a more user-friendly direction. Our labeling system started with displays in 1992 and is now requested by users and IT-manufacturers all over the world. About 50% of all displays worldwide are TCO certified.

For more information, please visit
www.tcodevelopment.com



Technology for you and the planet

CE MARKING DECLARATION OF CONFORMITY

This LCD monitor complies with the requirements of the EC Directive 2004/108/EC "EMC Directive", 2006/95/EC "Low Voltage Directive" and 2009/125/EC "ErP Directive".

The electro-magnetic susceptibility has been chosen at a level that gives correct operation in residential areas, business and light industrial premises and small-scale enterprises, inside as well as outside of the buildings. All places of operation are characterised by their connection to the public low voltage power supply system.

IYYAMA CORPORATION: Breguetlaan 8, 1438BC Oude Meer The Netherlands

An approved power cord greater or equal to H05VVH, 3G, 0.75mm² must be used.

For displays with glossy bezels the user should consider the placement of the display as the bezel may cause disturbing reflections from surrounding light and bright surfaces.



We recommend recycling of used product. Please contact your dealer or iiyama service center. Recycle information is obtained via the Internet, using the address:
<http://www.iiyama.com>

You can access the Web page of different countries from there.

- We reserve the right to change specifications without notice.
- All trademarks used in this user manual are the property of their respective owners.
- As an ENERGY STAR® Partner, iiyama has determined that this product meets the ENERGY STAR® guidelines for energy efficiency.

TABLE OF CONTENTS

FOR YOUR SAFETY	1
SAFETY PRECAUTIONS	1
SPECIAL NOTES ON LCD MONITORS	3
CUSTOMER SERVICE	3
CLEANING	3
BEFORE YOU OPERATE THE MONITOR	4
FEATURES	4
CHECKING THE CONTENTS OF THE PACKAGE	4
WALL MOUNTING	5
FITTING AND REMOVAL OF BASE : ProLite B2480HS	6
FITTING AND REMOVAL OF BASE : ProLite E2480HS	7
CONTROLS AND CONNECTORS : ProLite B2480HS	8
CONTROLS AND CONNECTORS : ProLite E2480HS	9
CONNECTING YOUR MONITOR : ProLite B2480HS	10
CONNECTING YOUR MONITOR : ProLite E2480HS	11
COMPUTER SETTING	12
ADJUSTING THE HEIGHT AND THE VIEWING ANGLE :	
ProLite E2480HS	12
ADJUSTING THE HEIGHT AND THE VIEWING ANGLE :	
ProLite B2480HS	13
PANEL ROTATION : ProLite B2480HS	13
OPERATING THE MONITOR	14
ADJUSTMENT MENU CONTENTS	15
SCREEN ADJUSTMENTS	21
POWER MANAGEMENT FEATURE	24
TROUBLE SHOOTING	25
RECYCLING INFORMATION	26
APPENDIX	27
SPECIFICATIONS : ProLite B2480HS	27
SPECIFICATIONS : ProLite E2480HS	28
DIMENSIONS : ProLite B2480HS	29
DIMENSIONS : ProLite E2480HS	29
COMPLIANT TIMING	30

FOR YOUR SAFETY

SAFETY PRECAUTIONS

WARNING

STOP OPERATING THE MONITOR IF YOU ARE AWARE OF ANY PROBLEMS

If you notice any abnormal phenomena such as smoke, strange sounds or fumes, unplug the monitor and contact your dealer or iiyama service center immediately. Further use may be dangerous and can cause fire or electric shock.

NEVER REMOVE THE CABINET

High voltage circuits are inside the monitor. Removing the cabinet may expose you to the danger of fire or electric shock.

DO NOT PUT ANY OBJECT INTO THE MONITOR

Do not put any solid objects or liquids such as water into the monitor. In case of an accident, unplug your monitor immediately and contact your dealer or iiyama service center. Using the monitor with any object inside may cause fire, electric shock or damage.

INSTALL THE MONITOR ON A FLAT, STABLE SURFACE

The monitor may cause an injury if it falls or is dropped.

DO NOT USE THE MONITOR NEAR WATER

Do not use where water may be splashed or spilt onto the monitor as it may cause fire or electric shock.

OPERATE UNDER THE SPECIFIED POWER SUPPLY

Be sure to operate the monitor only with the specified power supply. Use of an incorrect voltage will cause malfunction and may cause fire or electric shock.

PROTECT THE CABLES

Do not pull or bend the power cable and signal cable. Do not place the monitor or any other heavy objects on the cables. If damaged, the cables may cause fire or electric shock.

ADVERSE WEATHER CONDITIONS

It is advisable not to operate the monitor during a heavy thunder storm as the continual breaks in power may cause malfunction. It is also advised not to touch the plug in these circumstances as it may cause electric shock.

CAUTION

INSTALLATION LOCATION

Do not install the monitor where sudden temperature changes may occur, or in humid, dusty or smoky areas as it may cause fire, electric shock or damage. You should also avoid areas where the sun shines directly on the monitor.

DO NOT PLACE THE MONITOR IN A HAZARDOUS POSITION

The monitor may topple and cause injury if not suitably located. Please also ensure that you do not place any heavy objects on the monitor, and that all cables are routed such that children may not pull the cables and possibly cause injury.

MAINTAIN GOOD VENTILATION

Ventilation slots are provided to keep the monitor from overheating. Covering the slots may cause fire. To allow adequate air circulation, place the monitor at least 10 cm (or 4 inches) from any walls. Do not remove the tilt stand when operating the monitor. Ventilation slots on the back of the cabinet will be blocked and the monitor may overheat if the stand is removed. This may cause fire or damage. Operating the monitor on its back, side, upside down or on a carpet or any other soft material may also cause damage.

DISCONNECT THE CABLES WHEN YOU MOVE THE MONITOR

When you move the monitor, turn off the power switch, unplug the monitor and be sure the signal cable is disconnected. If you do not disconnect them, it may cause fire or electric shock.

UNPLUG THE MONITOR

If the monitor is not in use for a long period of time it is recommended that it is left unplugged to avoid accidents.

HOLD THE PLUG WHEN DISCONNECTING

To disconnect the power cable or signal cable, always pull it by the plug. Never pull on the cable itself as this may cause fire or electric shock.

DO NOT TOUCH THE PLUG WITH WET HANDS

Pulling or inserting the plug with wet hands may cause electric shock.

WHEN YOU INSTALL THE MONITOR ON YOUR COMPUTER

Be sure the computer is strong enough to hold the weight of the monitor, otherwise, you may damage your computer.

CAREFUL! PROTECT YOUR HANDS AND FINGERS

- Be careful not to hurt your fingers or hands when you change the height or the angle.
- Injury can occur if care is not taken to avoid finger contact with the displays base when adjusting the height. (Just for height adjustable model.)

DO NOT USE THE MONITOR FOR 24-HOURS CONTINUOUSLY

The monitor is not designed to work for 24-hours continuously, do not use the monitor for 24-hours continuously.

OTHERS

ERGONOMIC RECOMMENDATIONS

To eliminate eye fatigue, do not operate the monitor against a bright background or in a dark room. For optimal viewing comfort, the monitor should be just below eye level and 40-60 cm (16-24 inches) away from your eyes. When using the monitor over a prolonged time, a ten minute break every hour is recommended as looking at the screen continuously can cause eye strain.

SPECIAL NOTES ON LCD MONITORS

The following symptoms are normal with LCD monitors and do not indicate a problem.

- NOTE**
- When you first turn on the LCD monitor, the picture may not fit in the display area because of the type of computer that is used. In this case, adjust the picture position to the correct position.
 - Due to the nature of the backlight, the screen may flicker during initial use. Turn off the Power Switch and then turn it on again to make sure the flicker disappears.
 - You may find slightly uneven brightness on the screen depending on the desktop pattern you use.
 - Due to the nature of the LCD screen, an afterimage of the previous screen may remain after switching the image, when the same image is displayed for hours. In this case, the screen can be recovered slowly by changing the image or turning off the Power Switch for some hours.
 - Contact your dealer or iiyama service center for the backlight replacement when the screen is dark, flickering or not lighting up. Never attempt to replace it by yourself.

CUSTOMER SERVICE

- NOTE**
- If you have to return your unit for service and the original packaging has been discarded, please contact your dealer or iiyama service center for advice or replacement packaging.

CLEANING

- WARNING**
- If you drop any materials or liquids such as water into the monitor when cleaning, unplug the power cable immediately and contact your dealer or iiyama service center.

- CAUTION**
- For safety reasons, turn off the power switch and unplug the monitor before you clean it.

- NOTE**
- To protect the LCD panel, do not scratch or rub the screen with a hard object.
 - Never use any of the following strong solvents. These will damage the cabinet and the LCD screen.

Thinner	Spray-type cleaner
Benzine	Wax
Abrasive cleaner	Acid or Alkaline solvent

- Touching the cabinet with any product made from rubber or plastic for a long time may cause degeneration or loss of paint on the cabinet.

CABINET Stains can be removed with a cloth lightly moistened with a mild detergent solvent. Then wipe the cabinet with a soft dry cloth.

LCD Periodic cleaning with a soft dry cloth is recommended.

SCREEN Don't use tissue paper etc. because these will damage the LCD screen.

BEFORE YOU OPERATE THE MONITOR

FEATURES

- ◆ Supports Resolutions up to 1920 × 1080
- ◆ High Contrast 1000:1 (Typical), Adv. Contrast Function Available / Brightness 300cd/m² (Typical) / Quick Response Time 5ms (Typical), 2ms (Gray to Gray)
- ◆ Digital Character Smoothing
- ◆ Automatic Set-up
- ◆ Stereo Speakers
2 × 2W Stereo Speakers
- ◆ Plug & Play VESA DDC2B Compliant
Windows[®] 95/98/2000/Me/XP/Vista/7 Compliant
- ◆ Power Management (ENERGY STAR[®] VESA DPMS Compliant)
- ◆ Ergonomic Design TCO Certified
- ◆ VESA Mounting Standard (100mm×100mm) Compliant
- ◆ Keyhole for Security Lock

CHECKING THE CONTENTS OF THE PACKAGE

The following accessories are included in your package. Check to see if they are enclosed with the monitor. If anything is missing or damaged, please contact your local iiyama dealer or regional iiyama office.

- | | | |
|--|----------------------|-----------------------|
| ■ Power Cable* ¹ | ■ D-Sub Signal Cable | ■ DVI-D Signal Cable |
| ■ Audio Cable | ■ Stand-Base | ■ Stand* ² |
| ■ Screw for stand fixing* ³ | ■ Cable Holder | ■ Safety Guide |
| ■ Quick Start Guide | | |

CAUTION

*¹ The rating of the Power Cable enclosed in 120V area is 10A/125V. If you are using a power supply higher than this rating, then a power cable with a rating of 10A/250V must be used. However, all guarantees and warranties are void for any problems or damage caused by a power cable not supplied by iiyama.

*² Accessory for ProLite E2480HS.

*³ Accessory for ProLite B2480HS.

WALL MOUNTING

WARNING

- When you use with the wall mounting, in consideration of thickness of the mounting stage, tighten the M4 Screw with washer which "L" length is 7mm to fasten the monitor. Using the screw longer than this may cause electric shock or damage because it may contact with the electrical parts inside the monitor.
- Please check if the wall or ceiling can support the weight of the monitor before mounting it.

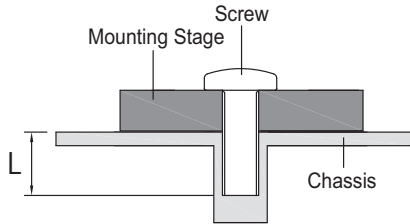

FITTING AND REMOVAL OF BASE : ProLite B2480HS

CAUTION

- Put the monitor on a stable surface. The monitor may cause injury or damage if it falls or is dropped.
- Do not give a strong impact to the monitor. It may cause damage.
- Unplug the monitor before removal or installation to avoid electric shock or damage.

<Installation>

- ① Put a piece of soft cloth on the table beforehand to prevent the monitor from being scratched. Lay the monitor flat on a table with front face down.
- ② Install the Stand-Base to the Monitor.
- ③ Fix the Monitor to the Stand by the screw firmly and the push-down knob.
- ④ Place the Cable Holder.

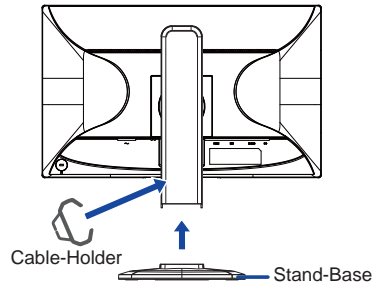
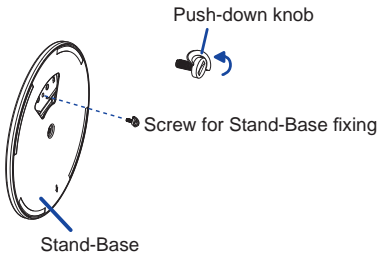

<Remove>

- ① Put a piece of soft cloth on the table beforehand to prevent the monitor from being scratched. Lay the monitor flat on a table with front face down.
- ② Pull up the knob, then remove the screws and the Stand-Base.

FITTING AND REMOVAL OF BASE : ProLite E2480HS

- CAUTION**
- Put the monitor on a stable surface. The monitor may cause injury or damage if it falls or is dropped.
 - Do not give a strong impact to the monitor. It may cause damage.
 - Unplug the monitor before removal or installation to avoid electric shock or damage.

<Installation>

- ① Put a piece of soft cloth on the table beforehand to prevent the monitor from being scratched. Lay the monitor flat on a table with front face down.
- ② Hold the monitor and push the Stand until it clicks and is secure.
- ③ Hold the monitor and push the Stand-Base until it clicks and is secure.
- ④ Insert the Cable Holder into Hole.

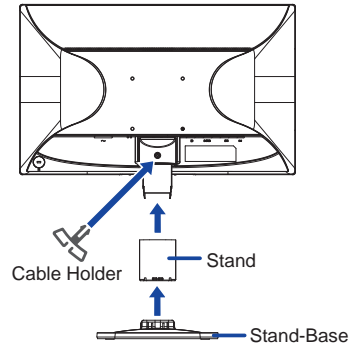

<Removal>

- ① Put a piece of soft cloth on the table beforehand to prevent the monitor from being scratched. Lay the monitor flat on a table with front face down.
- ② Press and hold the hooks inside, and pull the Stand-Base.
- ③ There are two locks inside of the Stand, unlock them by thin stick and pull the Stand away from the monitor.

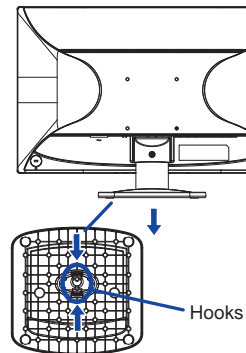
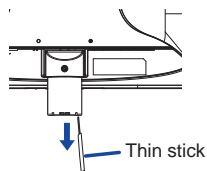

CONTROLS AND CONNECTORS : ProLite B2480HS



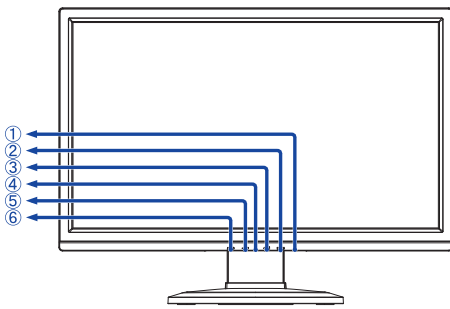

ENGLISH

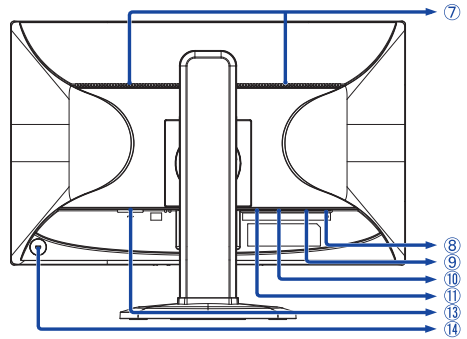

<Front>



<Back>



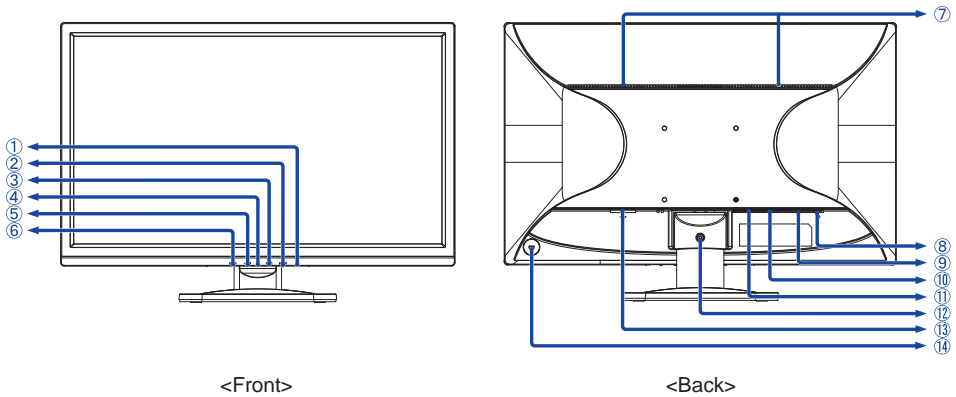

- ① Power Switch ()
- ② Menu Button (MENU)
- ③ + / Volume Button (+ / )
- ④ Power Indicator
 - NOTE** Blue: Normal operation
 - Orange: Power Management
- ⑤ - / ECO Button (- / )
- ⑥ Auto Button (AUTO)
- ⑦ Speakers
- ⑧ Audio Connector ()
- ⑨ D-SUB mini 15pin Connector (D-SUB)
- ⑩ DVI-D 24pin Connector (DVI)
- ⑪ HDMI Connector (HDMI)
- ⑬ AC Connector (AC IN)
- ⑭ Keyhole for Security Lock

NOTE You can fasten a security lock and cable to prevent the monitor from being removed without your permission.

CONTROLS AND CONNECTORS : ProLite E2480HS



ENGLISH

- ① Power Switch ()
- ② Menu Button (MENU)
- ③ + / Volume Button (+ / )
- ④ Power Indicator
 - NOTE** Blue: Normal operation
 - Orange: Power Management
- ⑤ - / ECO Button (- / )
- ⑥ Auto Button (AUTO)
- ⑦ Speakers
- ⑧ Audio Connector ()
- ⑨ D-SUB mini 15pin Connector (D-SUB)
- ⑩ DVI-D 24pin Connector (DVI)
- ⑪ HDMI Connector (HDMI)
- ⑫ Installation hole of Cable Holder
- ⑬ AC Connector (AC IN)
- ⑭ Keyhole for Security Lock

NOTE You can fasten a security lock and cable to prevent the monitor from being removed without your permission.

CONNECTING YOUR MONITOR : ProLite B2480HS

- ① Ensure that both the computer and the monitor are switched off.
- ② Connect the computer to the monitor with the signal cable.
- ③ Connect the monitor to the audio equipment with the Audio Cable for computer when using the audio features.
- ④ Connect the Power Cable to the monitor first and then to the power supply.
- ⑤ Turn on your monitor and computer.

NOTE

- The signal cables used for connecting the computer and monitor may vary with the type of computer used. An incorrect connection may cause serious damage to both the monitor and the computer. The cable supplied with the monitor is for a standard connector. If a special cable is required please contact your local iiyama dealer or regional iiyama office.
- For connection to Macintosh computers, contact your local iiyama dealer or regional iiyama office for a suitable adaptor.
- Make sure you tighten the finger screws at each end of the signal cable.
- The Class I pluggable equipment Type A must be connected to protective earth.
- The socket-outlet shall be installed near the equipment and shall be easily accessible.

[Example of Connection]

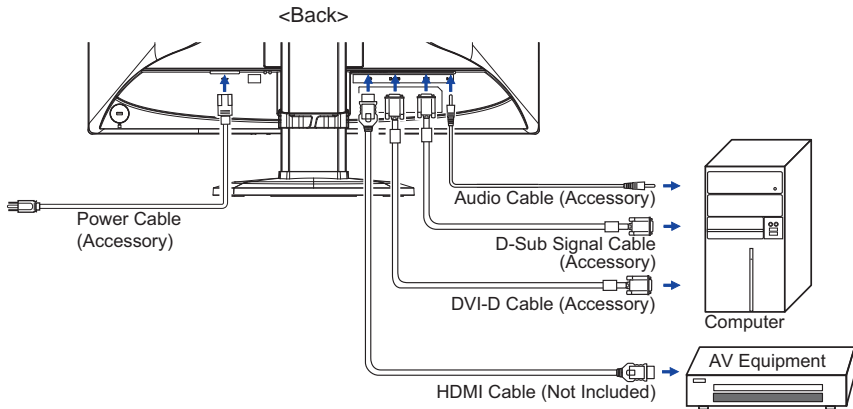

[Collect Cables]

- ① Put the cables through the cable holder.
- ② Collect cables at the back of the stand.

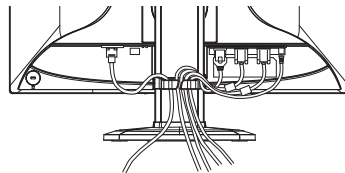

CONNECTING YOUR MONITOR : ProLite E2480HS

- ① Ensure that both the computer and the monitor are switched off.
- ② Connect the computer to the monitor with the signal cable.
- ③ Connect the monitor to the audio equipment with the Audio Cable for computer when using the audio features.
- ④ Connect the Power Cable to the monitor first and then to the power supply.
- ⑤ Turn on your monitor and computer.

- NOTE**
- The signal cables used for connecting the computer and monitor may vary with the type of computer used. An incorrect connection may cause serious damage to both the monitor and the computer. The cable supplied with the monitor is for a standard connector. If a special cable is required please contact your local iiyama dealer or regional iiyama office.
 - For connection to Macintosh computers, contact your local iiyama dealer or regional iiyama office for a suitable adaptor.
 - Make sure you tighten the finger screws at each end of the signal cable.
 - The Class I pluggable equipment Type A must be connected to protective earth.
 - The socket-outlet shall be installed near the equipment and shall be easily accessible.

[Example of Connection]

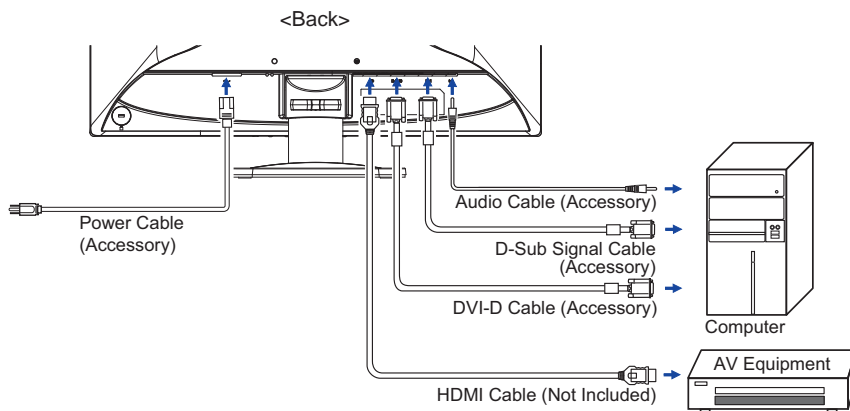

[Collect Cables]

- ① Put the cables through the cable holder.
- ② Collect cables at the back of the stand.

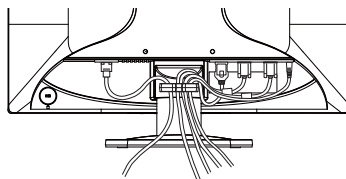

COMPUTER SETTING

■ Signal Timing

Change to the desired signal timing listed on page 30: COMPLIANT TIMING.

■ Windows 95/98/2000/Me/XP/Vista/7 Plug & Play

The iiyama LCD monitor complies with DDC2B of VESA standard. The Plug & Play function runs on Windows 95/98/2000/Me/XP/Vista/7 by connecting the monitor to DDC2B compliant computer with the Signal Cable supplied.

For installation on Windows 95/98/2000/Me/XP: The monitor Information File for iiyama monitors may be necessary for your computer and obtained via the Internet, using the address:

<http://www.iiyama.com>

NOTE

- For additional information on how to download the driver for your touch screen monitor, please access the internet site noted above.
- Monitor Drivers are not required in most cases for Macintosh or Unix operating systems. For further information, please contact your computer dealer first for advice.

ADJUSTING THE HEIGHT AND THE VIEWING ANGLE : ProLite E2480HS

- For optimal viewing it is recommended to look at the full face of the monitor.
- Hold the stand so that the monitor does not topple when you change the monitor's angle.
- You are able to adjust the monitor's angle up to 21° upward, 4° downward.
- In order to ensure a healthy and relaxed body position when using the monitor at visual display workstations, it is recommended that the adjusted tilt angle should not exceed 10 degrees. Adjust the monitor's angle to your own preference.

NOTE

- Do not touch the LCD screen when you change the height or the angle. It may cause damage or break the LCD screen.
- Careful attention is required not to catch your fingers or hands when you change the height or the angle.

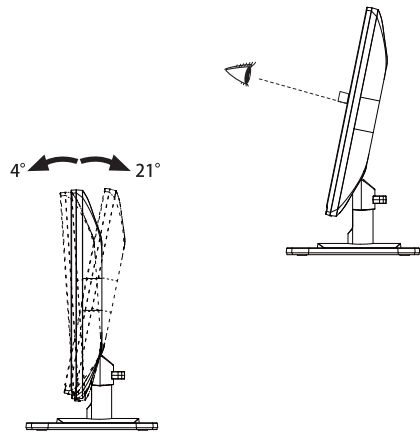

ADJUSTING THE HEIGHT AND THE VIEWING ANGLE : ProLite B2480HS

- For optimal viewing it is recommended to position yourself directly opposite to the full face of the monitor, then adjust the monitor's height and angle to your own preference.
- Hold the panel so that the monitor does not topple when you change the monitor's height or angle.
- You are able to adjust the monitor's height up to 130mm, angle up to 160 degrees right and left, 22 degrees upward and 5 degrees downward.

- NOTE**
- Do not touch the LCD screen when you change the height or the angle. It may cause damage or break the LCD screen.
 - Careful attention is required not to catch your fingers or hands when you change the height or the angle.
 - Injury can occur if care is not taken to avoid finger contact with the displays base when adjusting the height.

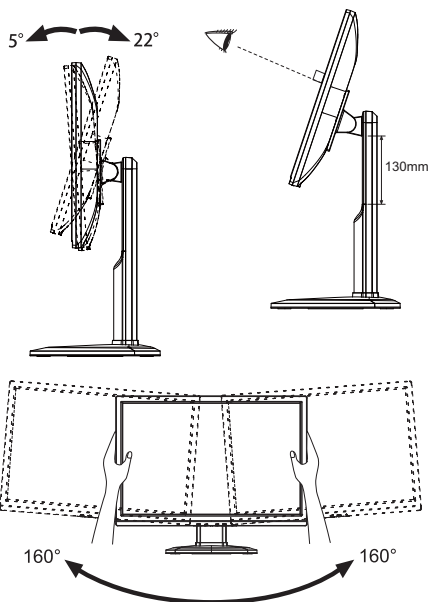
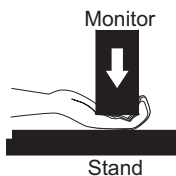

PANEL ROTATION : ProLite B2480HS

- ① Adjust the mother's height.
- ② Rotate the panel 90 degrees.
Portrait: Turn clockwise.
Landscape: Turn counter clockwise.

- NOTE**
- Attempting to rotate without fully extending upward may cause damage to stand.
 - Video card for portrait display will be required for rotating the image on the screen.

- ③ Adjust the monitor's angle to your preference.

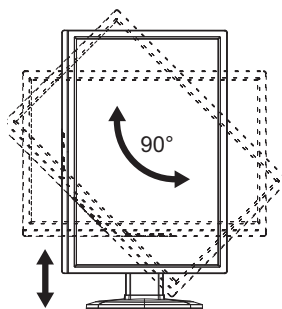

OPERATING THE MONITOR

To create the best picture, your iiyama LCD monitor has been preset at the factory with the COMPLIANT TIMING shown on page 30. You are also able to adjust the picture by following the button operation shown below. For more detailed adjustments, see page 21 for SCREEN ADJUSTMENTS.

- 1 Press the MENU Button to start the On Screen Display feature. There are additional Menu items which can be switched by using the + / - Buttons.

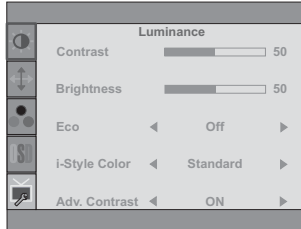

- 2 Select the Menu item which contains the adjustment icon relating to the adjustment you want to make. Press the MENU Button. Then, use the + / - Buttons to highlight the desired adjustment icon.
- 3 Press the MENU Button again. Use the + / - Buttons to make the appropriate adjustment or setting.
- 4 Press the AUTO Button to leave the menu, and the settings you just made would be automatically saved.

For example, to correct for vertical position, select Menu item of Image Setup and then press the MENU Button. Then, select V.Position by using the + / - Buttons.

An adjustment page appears after you press the MENU Button. Then, use the + / - Buttons to change the vertical position settings. The vertical position of the overall display should be changing accordingly while you are doing this.

Press the AUTO Button lastly, it ends, all changes are saved in the memory.

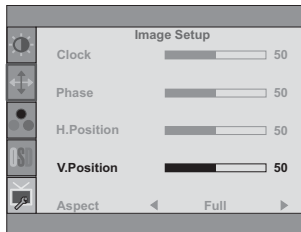

NOTE

- When button operations are aborted during adjustment, On-Screen Display disappears when the time set for the Timeout has passed. Also, the AUTO button can be used to return previous menu and turn off the On-Screen Display.
- Any changes are automatically saved in the memory when the On Screen Display disappears. Turning off the power should be avoided while using the Menu.
- Adjustments for H. / V. Position, Clock and Phase are saved for each signal timing. Except for these adjustments, all other adjustments have only one setting which applies to all signal timings.

ADJUSTMENT MENU CONTENTS

Adjustment Item		Problem / Option		Button to Press
Contrast		Too dull		+
		Too intense		-
Brightness *		Too dark		+
		Too bright		-
Eco	Direct	Off	Normal	
		Mode1	Brightness of back-light is reduced.	
		Mode2	Brightness of back-light is reduced more than Mode1.	
		Mode3	Brightness of back-light is reduced more than Mode2.	
i-Style Color		Standard	For general windows environment and monitor default setting.	
		Text	For text editing and viewing in a word processing environment.	
		Internet	For internet environment.	
		Game	For PC game environment.	
		Movie	For movie and video environment.	
Adv. Contrast		Sports	For sport environment.	
		On	Increased Contrast Ratio	
		Off	Typical Contrast Ratio	
<p>NOTE Adv. Contrast adjusts brightness according to the image, and improve the contrast ratio during movie playing. Contrast, Brightness, sRGB, Eco and i-Style Color cannot be adjusted and selected while Adv. Contrast is active.</p>				

* Adjust the Brightness when you are using the monitor in a dark room and feel the screen is too bright.

Direct

You can skip the Menu items and display an adjustment scale directly by using the following button operations.

- ECO: Press the - Button when the Menu is not displayed.

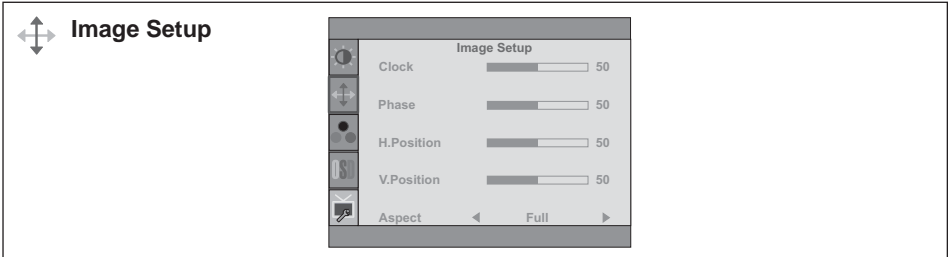

Adjustment Item	Problem / Option	Button to Press
Clock* ^{1,2}	Too narrow	<input type="button" value="+"/>
	Too wide	<input type="button" value="-"/>
Phase* ^{1,2}	To correct flickering text or lines	<input type="button" value="+"/> <input type="button" value="-"/>
H. Position* ²	Too left	<input type="button" value="+"/>
	Too right	<input type="button" value="-"/>
V. Position* ²	Too low	<input type="button" value="+"/>
	Too high	<input type="button" value="-"/>
Aspect	Full	Expansion display
	Aspect	Expansion display of Aspect



*¹ See page 21 for SCREEN ADJUSTMENTS.

*² Only Analog Input.

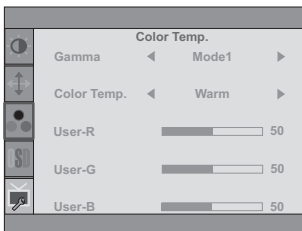

Color Temp.





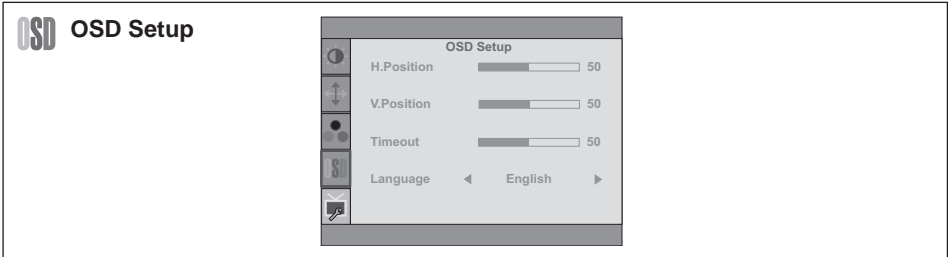

Adjustment Item	Problem / Option		Button to Press
Gamma	Mode1	Normal	
	Mode2	High contrast	
	Mode3	Dark	
Color Temp.	User	User-R	Too weak  <input data-bbox="1004 483 1063 516" type="button" value="+"/>
		User-G	
		User-B	Too strong  <input data-bbox="1004 516 1063 548" type="button" value="-"/>
	Warm	Greenish white	
	Normal	Yellowish white	
	Cool	Bluish white	
sRGB	sRGB		

NOTE

- sRGB is an international standard which defines and unifies the difference of color appearance between equipment.
- You can not adjust the Brightness, Contrast, Gamma and Eco during sRGB mode because those settings are locked.

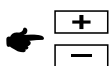

Adjustment Item	Problem / Option		Button to Press	
H.Position	OSD is too left OSD is too right		 <input data-bbox="981 397 1040 422" type="button" value="+"/>  <input data-bbox="981 430 1040 454" type="button" value="-"/>	
V.Position	OSD is too low OSD is too high		 <input data-bbox="981 487 1040 511" type="button" value="+"/>  <input data-bbox="981 519 1040 544" type="button" value="-"/>	
Timeout	You can set the OSD display duration time between 5 and 60 seconds.		 <input data-bbox="981 576 1040 600" type="button" value="+"/> <input data-bbox="981 609 1040 633" type="button" value="-"/>	
Language	English	English	Portuguese	Portuguese
	Deutsch	German	简体中文	Simplified Chinese
	Français	French	Русский	Russian
	Español	Spanish	日本語	Japanese
	Italiano	Italian		

Adjustment Item		Problem / Option	Button to Press
Reset	Yes	Factory-preset data is restored.	
	No	Return to Menu.	
Signal Select Direct	Auto	Select the signal input automatically.	
	D-SUB	Select the Analog input.	
	DVI	Select the Digital (DVI) input.	
	HDMI	Select the Digital (HDMI) input.	
NOTE		At selected the AUTO, it will automatically be selected when just one source is available. If there are more input sources available and you select one of them, the AUTO option is not available. If multiple inputs are connected, the monitor may not recover the last one used after turning it off and on again. It is only possible when you set a specific source.	
HDMI audio* ¹	HDMI	Select the HDMI input.	
	LINE IN	Select the LINE IN input.	
Over Drive* ²	Off / -2 / -1 / 0 / +1 / +2	It will improve the gray level response time of the LCD panel. A higher level results in a faster response time.	
Information		Displays information regarding the current input signal coming from the graphic card in your computer.	NOTE See your graphic card user guide for more information about changing the resolution and refresh.

*¹ Suitable for HDMI input only.

*² When Over Drive is activated, some level of image retention will be caused.

Direct

You can skip the Menu items and display an adjustment scale directly by using the following button operations.

- Signal Select: Press the AUTO button when the Menu is not displayed, it shows following Menu.
You can then select input source press the AUTO button and press the MENU button.



Direct

You can skip the Menu items and display an adjustment scale directly by using the following button operations.

- Volume: Press the + Button when the Menu is not displayed.

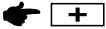
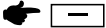
Adjustment Item	Problem / Option	Button to Press
Volume	Too soft Too loud	 

- Auto Adjust: Press and hold the Auto Button for 3-4 seconds when the Menu is not displayed.

Only Analog Input

Adjustment Item	Problem / Option	Button to Press
Auto Adjust *	Adjust H. / V. Position, Clock and Phase automatically.	

* For best results, use the Auto Adjust in conjunction with the adjustment pattern. See page 21 for SCREEN ADJUSTMENTS.

- Lock Mode:

<OSD>

Hold the MENU button and turn on the monitor when the monitor is power-off, it will lock/unlock the OSD Key Lock function.

<Power/OSD>

Pressing and holding the MENU button for 10 seconds when Menu is not displayed, will lock/unlock the Power/OSD Key Lock function.

SCREEN ADJUSTMENTS

Adjust the image by following the procedure below to get the desired picture when selecting Analog input.

- The screen adjustments described in this manual are designed to set image position and minimize flicker or blur for the particular computer in use.
- The monitor is designed to provide the best performance at resolution of 1920 × 1080, but can not provide the best at resolutions of less than 1920 × 1080 because the picture is automatically stretched to fit the full screen. It is recommended to operate at resolution of 1920 × 1080 in normal use.
- Displayed text or lines will be blurred or irregular in thickness when the picture is stretched due to the screen enlargement process.
- It is preferable to adjust the image position and frequency with the monitor controls, rather than the computer software or utilities.
- Perform adjustments after a warm-up period of at least thirty minutes.
- Additional adjustments may be required after the Auto Image Adjust depending on the resolution or signal timing.
- The Auto Image Adjust may not work correctly when displaying the picture other than the screen adjustment pattern. In this case, manual adjustments are required.

There are two ways to adjust the screen. One way is automatic adjustment for Position, Clock and Phase. The other way is performing each adjustment manually.

Perform the Auto Image Adjust first when the monitor is connected to a new computer, or resolution is changed. If the screen has a flicker or blur, or the picture does not fit in the display area after performing the Auto Image Adjust, manual adjustments are required. Both adjustments should be made by using the screen adjustment pattern (Test.bmp) obtained via the IYAMA web site (<http://www.iiyama.com>).

Adjust the image by following the procedure below to get the desired picture.

This manual explains adjustment under Windows 95/98/2000/Me/XP/Vista/7.

- ① **Display the picture at the optimum resolution.**
- ② **Enter the Test.bmp (screen adjustment pattern) to wallpaper.**

NOTE

- Consult the appropriate documentation for doing this.
- Test.bmp is made at resolution of 1280 × 1024. Set the display position to center in the wallpaper setting dialogue box. If you use Microsoft® PLUS! 95/98 cancel the setting of "Stretch desktop wallpaper to fit the screen".

[Adjustment pattern]

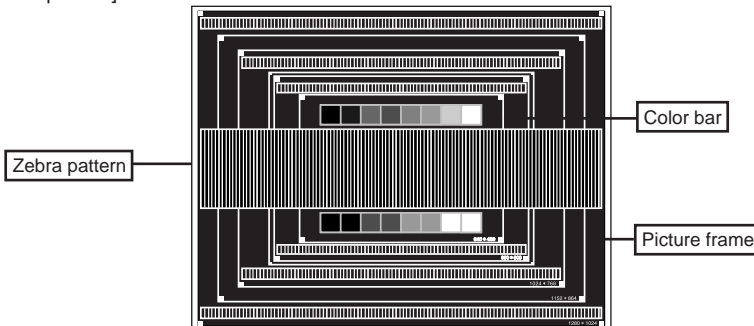

- ③ Pressing and holding of the ▼ Button for about 2 seconds. (Auto Image Adjust)
- ④ Adjust the image manually by following procedure below when the screen has a flicker or blur, or the picture does not fit in the display area after performing the Auto Image Adjust.
- ⑤ Adjust the V.Position so that the top and bottom of the picture frame will fit to the display area.

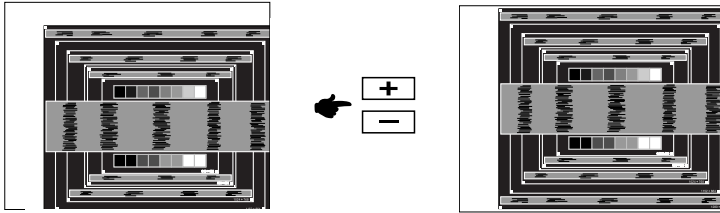

- ⑥ 1) Adjust the H.Position so that the left side of the picture frame will move to the left edge of the display area.

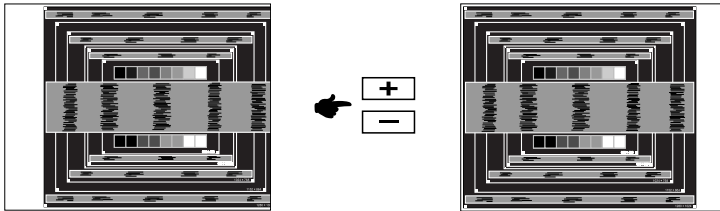

- 2) Stretch the right side of the picture frame to the right edge of the display area by adjusting the Clock.

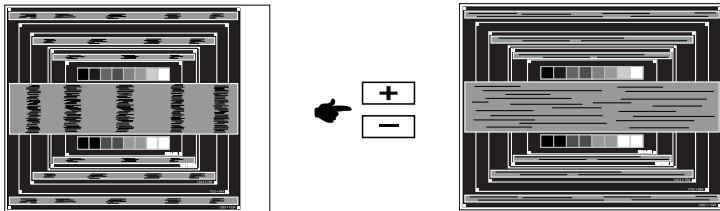
**NOTE**

- When the left side of the picture frame moves apart from the left edge of the display area during the Clock adjustment, adjust steps 1) and 2).
- Another way to make the Clock adjustment is to correct the vertical wavy lines in the zebra pattern.
- The picture may flicker during the Clock, H.Position and V.Position adjustment.
- In case the picture frame is bigger or smaller than the data display area after the Clock adjustment, repeat steps from ③.

⑦ Adjust the Phase to correct horizontal wavy noise, flicker or blur in the zebra pattern.

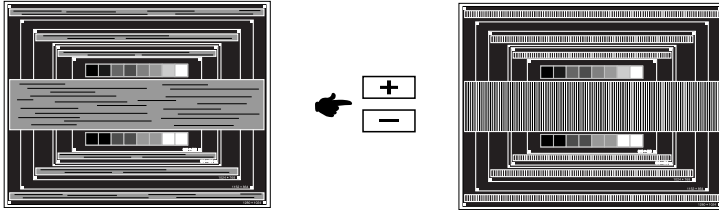

NOTE

- In case the strong flicker or blurs remain on a part of the screen, repeat steps ⑥ and ⑦ because the Clock may not be adjusted correctly. If the flicker or blurs still remain, set the refresh rate of computer to low (60Hz) and repeat steps from ③ again.
- Adjust the H.Position after the Phase adjustment if the horizontal position moves during the adjustment.

⑧ Adjust the Brightness and Color to get the desired picture after you complete the Clock and Phase adjustments.

Put back your favorite wallpaper.

POWER MANAGEMENT FEATURE

The power management feature of this product complies with power saving requirement of ENERGY STAR® and VESA DPMS. When activated, it automatically reduces unnecessary power consumption of the monitor when your computer is not in use.

To use the feature, the monitor needs to be connected to a VESA DPMS compliant computer. There is a power management step the monitor takes as described below. The power management function, including any timer settings is configured by the operating system. Check your operating system manual for information on how this can be configured.

■ Power Management Mode

When the H-sync signal / V-sync signal / H and V sync signals from the computer are off, the monitor enters into Power Management Mode which reduces the power consumption to less than 1W. The screen becomes dark, and the power indicator turns to orange. From Power Management Mode, the image reappears in several seconds when either the keyboard or the mouse are touched again.

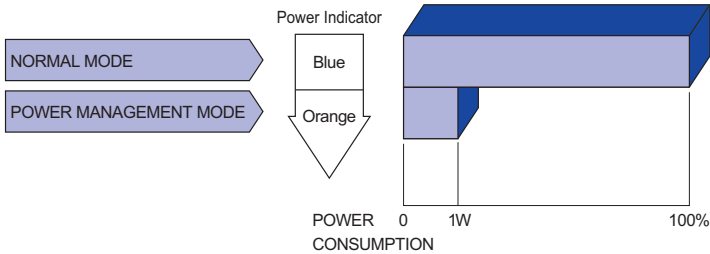

NOTE

- Even when using the power management mode, the monitor consumes electricity. Turn off the Power Switch whenever the monitor is not in use, during the night and weekends, to avoid unnecessary power consumption.
- It is possible that the video signal from the computer may be on while the H or V sync signal is missing. In this instance, the POWER MANAGEMENT feature may not work properly.

TROUBLE SHOOTING

If the monitor fails to operate correctly, please follow the steps below for a possible solution.

1. Perform the adjustments described in OPERATING THE MONITOR, depending on the problem you have. If the monitor does not get a picture, skip to 2.
2. Consult the following items if you cannot find an appropriate adjustment item in OPERATING THE MONITOR or if the problem persists.
3. If you are experiencing a problem which is not described below or you cannot correct the problem, discontinue using the monitor and contact your dealer or iiyama service center for further assistance.

Problem	Check
<p>① The picture does not appear. (Power indicator does not light up.) (Power indicator is blue.) (Power indicator is orange.)</p>	<p><input type="checkbox"/> The Power Cable is firmly seated in the socket. <input type="checkbox"/> The Power Switch is turned ON. <input type="checkbox"/> The AC socket is live. Please check with another piece of equipment. <input type="checkbox"/> If the blank screen saver is in active mode, touch the keyboard or the mouse. <input type="checkbox"/> Increase the Contrast and/or Brightness. <input type="checkbox"/> The computer is ON. <input type="checkbox"/> The Signal Cable is properly connected. <input type="checkbox"/> The signal timing of the computer is within the specification of the monitor. <input type="checkbox"/> If the monitor is in power management mode, touch the keyboard or the mouse. <input type="checkbox"/> The computer is ON. <input type="checkbox"/> The Signal Cable is properly connected. <input type="checkbox"/> The signal timing of the computer is within the specification of the monitor.</p>
<p>② The screen is not synchronized.</p>	<p><input type="checkbox"/> The Signal Cable is properly connected. <input type="checkbox"/> The signal timing of the computer is within the specification of the monitor. <input type="checkbox"/> The video output level of the computer is within the specification of the monitor.</p>
<p>③ The screen position is not in the center.</p>	<p><input type="checkbox"/> The signal timing of the computer is within the specification of the monitor.</p>
<p>④ The screen is too bright or too dark.</p>	<p><input type="checkbox"/> The video output level of the computer is within the specification of the monitor.</p>
<p>⑤ The screen is shaking.</p>	<p><input type="checkbox"/> The power voltage is within the specification of the monitor. <input type="checkbox"/> The signal timing of the computer is within the specification of the monitor.</p>

Problem**Check**

- | | |
|---------------------------------------|--|
| ⑥ No sound. | <input type="checkbox"/> The audio equipment (computer etc.) is ON. |
| | <input type="checkbox"/> The Audio Cable is properly connected. |
| | <input type="checkbox"/> The Volume is turned up. |
| | <input type="checkbox"/> The audio output level of the audio equipment is within the specification of the monitor. |
| ⑦ The sound is too loud or too quiet. | <input type="checkbox"/> The audio output level of the audio equipment is within the specification of the monitor. |
| ⑧ A strange noise is heard. | <input type="checkbox"/> The Audio Cable is properly connected. |

RECYCLING INFORMATION

For better environment protection please don't dispose your monitor.
Please visit our web site: www.iiyama.com/recycle for monitor recycling.

APPENDIX

Design and specifications are subject to change without prior notice.

SPECIFICATIONS : ProLite B2480HS

Size Category	23.6"	
LCD Panel	Panel technology	TN
	Size	Diagonal: 23.6" (60.0cm)
	Pixel pitch	0.2715mm H x 0.2715mm V
	Brightness	300cd/m ² (Typical)
	Contrast ratio	1000 : 1 (Typical), Adv. Contrast Function Available
	Viewable angle	Right / Left: 85 degrees each, Up / Down: 80 degrees each (Typical)
	Response time	5ms (Black, White, Black, Typical), 2ms (Gray to Gray)
Display Colours	Approx.16.7M	
Sync Frequency	Analog: Horizontal: 24.0-80.0kHz, Vertical: 56-75Hz Digital: Horizontal: 30.0-80.0kHz, Vertical: 56-75Hz	
Maximum Resolution	1920 x 1080, 2.1 MegaPixels	
Input Connector	D-Sub mini 15 pin, DVI-D 24 pin, HDMI	
Plug & Play	VESA DDC2B™	
Input Sync Signal	Separate sync: TTL, Positive or Negative	
Input Video Signal	Analog: 0.7Vp-p (Standard), 75Ω, Positive Digital: DVI (Digital Visual Interface Standard Rev.1.0) compliance Digital: HDMI	
Input Audio Connector	ø 3.5mm mini jack (Stereo)	
Input Audio Signal	1.0Vrms maximum	
Speakers	2W x 2 (Stereo speakers)	
Maximum Screen Size	521.28mm W x 293.22mm H / 20.5" W x 11.5" H	
Power Source	100-240VAC, 50/60Hz, 1.5A	
Power Consumption*	22W typical, Power management mode: 1W maximum	
Dimensions / Net Weight	571.5 x 427.0 - 557.0 x 244.5mm / 22.5 x 16.8 - 21.9 x 9.6" (WxHxD) 6.1kg / 13.4lbs	
Tilt Angle	Upward: 22 degrees, Downward: 5 degrees, Left/Right: 160 degrees each	
Environmental Considerations	Operating: Temperature 5 to 35°C / 41 to 95°F Humidity 10 to 80% (No condensation) Storage: Temperature -20 to 60°C / -4 to 140°F Humidity 5 to 85% (No condensation)	
Approvals	TCO Certified, CE, TÜV-GS, CU, ENERGY STAR®	

NOTE * Audio equipment is not connected.

SPECIFICATIONS : ProLite E2480HS

ENGLISH

Size Category	23.6"	
LCD Panel	Panel technology	TN
	Size	Diagonal: 23.6" (60.0cm)
	Pixel pitch	0.2715mm H x 0.2715mm V
	Brightness	300cd/m ² (Typical)
	Contrast ratio	1000 : 1 (Typical), Adv. Contrast Function Available
	Viewable angle	Right / Left: 85 degrees each, Up / Down: 80 degrees each (Typical)
	Response time	5ms (Black, White, Black, Typical), 2ms (Gray to Gray)
Display Colours	Approx.16.7M	
Sync Frequency	Analog: Horizontal: 24.0-80.0kHz, Vertical: 56-75Hz Digital: Horizontal: 30.0-80.0kHz, Vertical: 56-75Hz	
Maximum Resolution	1920 x 1080, 2.1 MegaPixels	
Input Connector	D-Sub mini 15 pin, DVI-D 24 pin, HDMI	
Plug & Play	VESA DDC2B™	
Input Sync Signal	Separate sync: TTL, Positive or Negative	
Input Video Signal	Analog: 0.7Vp-p (Standard), 75Ω, Positive Digital: DVI (Digital Visual Interface Standard Rev.1.0) compliance Digital: HDMI	
Input Audio Connector	ø 3.5mm mini jack (Stereo)	
Input Audio Signal	1.0Vrms maximum	
Speakers	2W x 2 (Stereo speakers)	
Maximum Screen Size	521.28mm W x 293.22mm H / 20.5" W x 11.5" H	
Power Source	100-240VAC, 50/60Hz, 1.5A	
Power Consumption*	22W typical, Power management mode: 1W maximum	
Dimensions / Net Weight	571.5 x 401.0 x 213.5mm / 22.5 x 15.8 x 8.4" (WxHxD) 4.3kg / 9.5lbs	
Tilt Angle	Upward: 21 degrees, Downward: 4 degrees	
Environmental Considerations	Operating: Temperature 5 to 35°C / 41 to 95°F Humidity 10 to 80% (No condensation) Storage: Temperature -20 to 60°C / -4 to 140°F Humidity 5 to 85% (No condensation)	
Approvals	TCO Certified, CE, TÜV-GS, CU, ENERGY STAR®	

NOTE

* Audio equipment is not connected.

DIMENSIONS : ProLite B2480HS

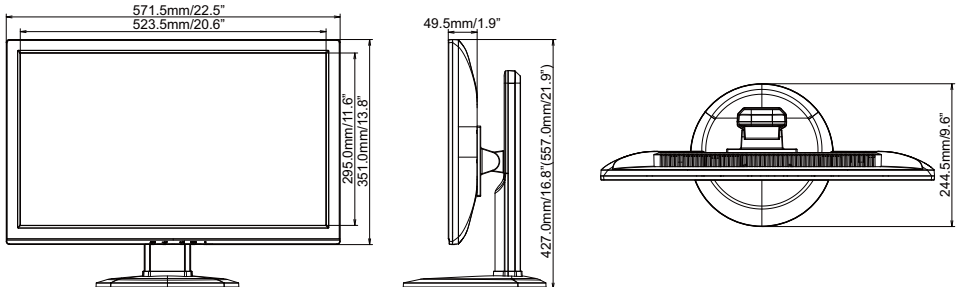

() : Maximum adjustment range

DIMENSIONS : ProLite E2480HS

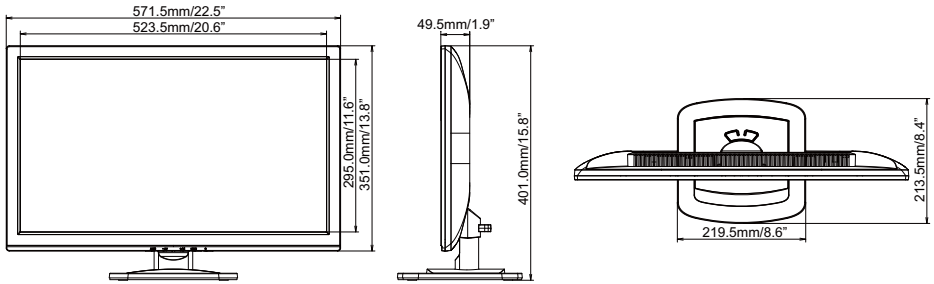

COMPLIANT TIMING

Video Mode		Horizontal Frequency	Vertical Frequency	Dot Clock
VESA	VGA 640 × 480	31.469kHz	59.940Hz	25.175MHz
		37.500kHz	75.000Hz	31.500MHz
		37.861kHz	72.809Hz	31.500MHz
	SVGA 800 × 600	35.156kHz	56.250Hz	36.000MHz
		37.879kHz	60.317Hz	40.000MHz
		46.875kHz	75.000Hz	49.500MHz
	XGA 1024 × 768	48.077kHz	72.188Hz	50.000MHz
		48.363kHz	60.004Hz	65.000MHz
		56.476kHz	70.069Hz	75.000MHz
	SXGA 1280 × 1024	60.023kHz	75.029Hz	78.750MHz
		63.981kHz	60.020Hz	108.000MHz
	WXGA+ 1440 × 900	79.976kHz	75.025Hz	135.000MHz
WSXGA+ 1680 × 1050	55.935kHz	59.887Hz	106.500MHz	
Full HD 1920 × 1080	65.290kHz	60.000Hz	146.250MHz	
Macintosh	640 × 480	66.590kHz	59.930Hz	138.500MHz
	832 × 624	35.000kHz	66.667Hz	30.240MHz
	1024 × 768	49.725kHz	74.500Hz	57.283MHz
PC9801	640 × 400	60.150kHz	74.720Hz	80.000MHz
		24.827kHz	56.424Hz	21.053MHz

*
*
*
***NOTE** * Digital input is not compliant.