

BDS 275/BDS 575/ BDS 277/BDS 577

Blu-ray Disc™ receiver

Owner's Manual

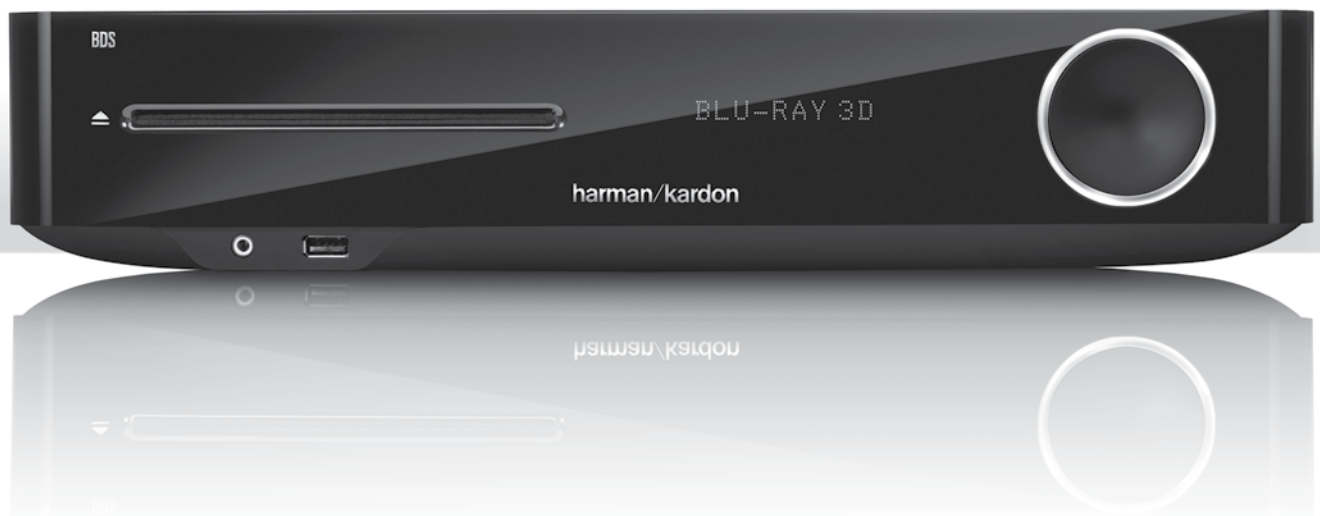

harman/kardon
by HARMAN

Your BDS receiver is designed to be compatible with region management information that is encoded on most Blu-ray Disc recordings and DVD recordings. Your receiver will only play discs that contain region coding for the area where your receiver was shipped and intended for sale:

Area Where Sold	Blu-ray Disc Region Code	DVD Region Code
USA, Canada		
Europe, Middle East		
Korea, S.E. Asia		
Mexico, Latin America		
Australia, New Zealand		
Russia, India		
China		

For example, BDS receivers shipped to and sold in the USA will only play Blu-ray Discs that contain region code A and DVD discs that contain region code 1.

INTRODUCTION	3
VERIFY LINE VOLTAGE BEFORE USING	3
UNPACKING	3
INSTALLATION LOCATION	3
CLEANING	3
MOVING THE RECEIVER	3
SUPPLIED ACCESSORIES	3
RECEIVER FRONT-PANEL CONTROLS	4
RECEIVER REAR-PANEL CONNECTIONS	6
REMOTE CONTROL FUNCTIONS	8
CONNECTIONS	10
PREPARING THE REMOTE CONTROL	13
SETTING UP THE RECEIVER	15
USING THE RECEIVER	20
USING THE DISC PLAYER	22
PLAYING STREAMING MEDIA VIA YOUR HOME NETWORK	23
LISTENING TO YOUR IPOD/IPHONE/IPAD	24
LISTENING TO FM RADIO	24
LISTENING TO AUDIO SOURCES	25
LISTENING TO MEDIA VIA AIRPLAY	25
PLAYING FILES FROM USB DEVICES AND DATA DISCS	25
USING PLAYLISTS	27
TROUBLESHOOTING	28
AUX COMPONENT REMOTE-CONTROL CODE LIST	29
SPECIFICATIONS	37

Introduction

Please register your product on our Web site at www.harmankardon.com.

Note: You'll need the product's serial number. At the same time, you can choose to be notified about our new products and/or special promotions.

Thank You for Choosing Harman Kardon Products!

In the years since Harman Kardon engineers invented the high-fidelity receiver, we have taken to heart this philosophy: Bringing the joy of home entertainment to as many people as possible, adding performance and ease-of-use features that enhance the experience. The BDS series of home entertainment systems offers a complete home entertainment solution with a wealth of listening and viewing options in one sleek receiver.

To get the maximum enjoyment from your new BDS receiver we urge you to read this manual thoroughly and refer back to it as you become more familiar with your new receiver's features and their operation.

If you have any questions about this product, its installation or its operation, please contact your retailer or custom installer, or visit our Web site at www.harmankardon.com.

Verify Line Voltage Before Using

Your BDS receiver has been designed for use with 110 – 240-volt, 50Hz/60Hz AC current and includes a detachable IEC power cable intended for use in the region where the receiver is sold.

Connection to a line voltage other than that for which the unit is intended can create a safety and fire hazard and may damage the unit. If you have any questions about the voltage requirements for your specific model or about the line voltage in your area, contact your dealer before plugging the unit into a wall outlet.

Unpacking

The carton and shipping materials used to protect your new receiver during shipment were specially designed to cushion it from shock and vibration. We suggest that you save the carton and packing materials for use in shipping if you move or if the unit ever needs repair.

To minimize the size of the carton in storage, you may wish to flatten it. You can do it by carefully slitting the tape seams on the carton's bottom and collapsing it. You can store cardboard inserts in the same manner. Packing materials that cannot be collapsed should be saved along with the carton in a plastic bag.

If you do not wish to save the packaging materials, please note that the carton and other sections of the shipping-protection materials are recyclable. Please respect the environment and discard those materials at a local recycling center.

Remove the protective plastic film from the front-panel lens. Leaving the film in place will affect the performance of your remote control.

Installation Location

- To ensure proper operation and to avoid the potential for safety hazards, place the unit on a firm and level surface. When placing the unit on a shelf, be certain that the shelf and any mounting hardware can support the weight of the product.
- Provide proper space both above and below the unit for ventilation. If this product will be installed in a cabinet or other enclosed area, make certain that there is sufficient air movement within the area. Under some circumstances, a fan may be required.
- Do not place the unit directly on a carpeted surface.
- Avoid installation in extremely hot or cold locations or in an area that is exposed to direct sunlight or heating equipment.
- Avoid moist or humid locations.
- Do not obstruct the fan vents on the rear panel or the ventilation slots on the top and sides of the unit or place objects directly over or next to them.
- Do not place the receiver directly on top of a product that generates excessive heat.

- Due to the heat generated by the receiver there is the remote possibility that the rubber padding on the bottom of the unit's feet may leave marks on certain wood or wood-veneer materials. Use caution when placing the unit on soft woods or other materials that heat or heavy objects may damage. Some surface finishes may be particularly sensitive to absorbing such marks, due to a variety of factors beyond Harman Kardon control, including the nature of the finish, cleaning materials used, normal heat and vibration caused by the use of the product, or other factors. Your warranty will not cover this type of damage to furniture, so exercise caution in choosing an installation location for the component and in performing normal maintenance practices.
- Your new Harman Kardon Blu-ray Disc™ receiver requires a broadband Internet connection for streaming capability and BD-Live™ interactivity.

Cleaning

When the receiver gets dirty, wipe it with a clean, soft, dry cloth. If necessary, and only after unplugging the AC power cord, wipe it with a soft cloth dampened with mild soapy water, then a fresh cloth with clean water. Wipe it dry immediately with a dry cloth. NEVER use benzene, aerosol cleaners, thinner, alcohol or any other volatile cleaning agent. Do not use abrasive cleaners, as they may damage the finish of metal parts. Avoid spraying insecticide near the unit.

Moving the Receiver

Before moving the receiver, disconnect any interconnection cords to other components, and disconnect the unit from its AC outlet.

Supplied Accessories

If any of these items are missing, please contact Harman Kardon Customer Service via www.harmankardon.com.

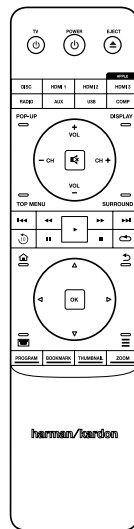

Remote Control

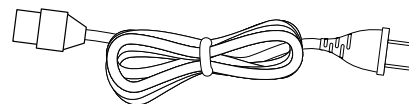

Power Cord
(varies with region)

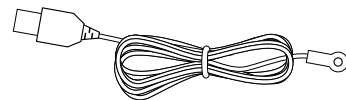

FM Antenna

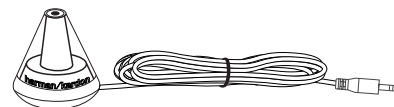

EZ Set/EQ™
Microphone

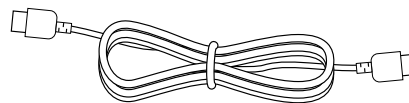

HDMI Cable

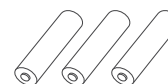

3 X AAA Batteries

Receiver Front-Panel Controls

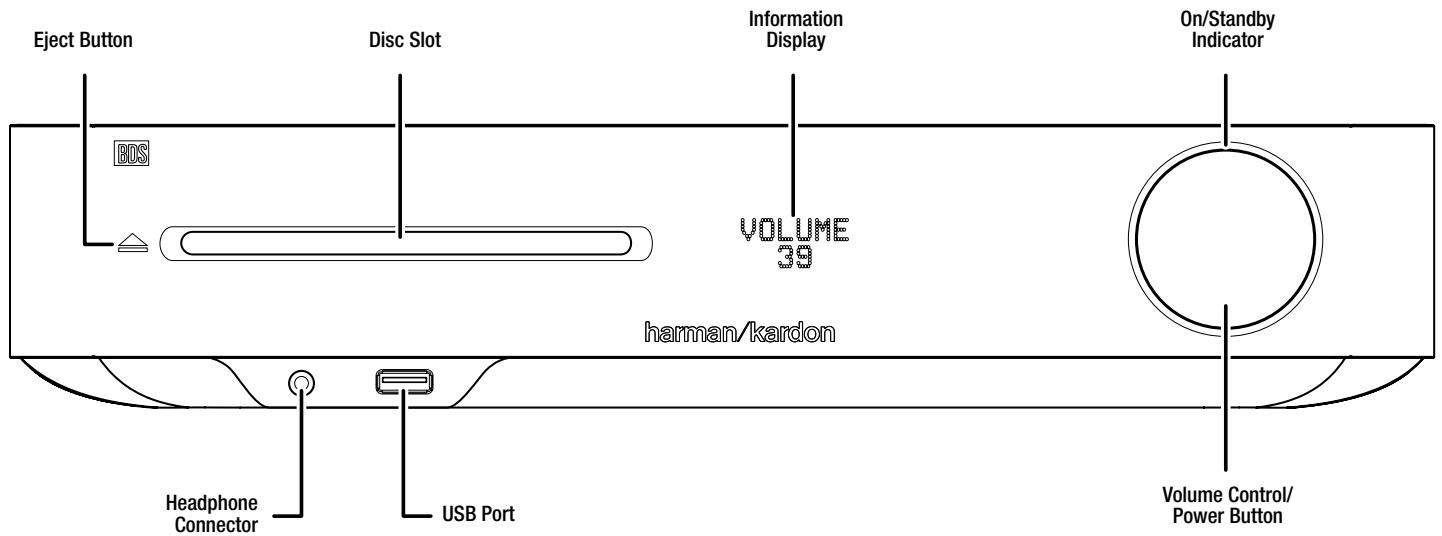

Eject button (appears only when a disc has been inserted): Touch this button to eject a disc from the BDS receiver's built-in disc player. Before touching this button, make sure no objects are blocking the disc-slot opening. NOTE: If you do not remove the ejected disc within 90 seconds, it will automatically re-load back into the disc player for protection.

Disc slot: Insert a compatible disc into the slot. The BDS receiver's disc player will accept 5-inch (12cm) and 3-inch (8cm) discs.

Information display: Various messages appear on this display in response to commands and in order to show the audio/video that is playing, the BDS receiver's settings or other aspects of the BDS receiver's status as described throughout this manual.

On/Standby indicator: This LED surrounds the Volume control. When the BDS receiver is plugged into AC power and its rear-panel Main Power switch is in the On position, the LED turns amber to indicate that the receiver is in Standby mode (ready to be turned on). When you turn the BDS receiver on the LED turns white.

Headphone jack: Insert the 1/8-inch (3.5mm) stereo mini connector from a set of headphones into this jack. NOTE: When a plug is inserted into the Headphone jack, the BDS receiver's speaker outputs automatically mute; the HDMI audio output remains active.

USB port: You can use the USB port to play audio files from an Apple iOS® device connected to the port, and to play MP3 and WMA audio files from a USB device inserted into the port. Insert the connector or device into the USB port oriented so it fits all the way into the port. You may insert or remove the connector or device at any time - there is no installation or ejection procedure.

You can also use the USB port to perform firmware upgrades. If an upgrade for the BDS operating system is released in the future, you will be able to download it to the BDS receiver using this port. Complete instructions will be provided at that time.

IMPORTANT: Do not connect a PC or other USB host/controller to this port, or you may damage both the BDS receiver and the other device. HDD is not supported.

Volume control/Power button:

- Press the disc to toggle the receiver between the On and Standby modes. NOTE: If the receiver goes for 30 minutes without receiving an audio signal or a user command, it will automatically enter the standby mode to conserve electrical power.
- Rotate the disc to change the volume. The volume level will appear on the front-panel Information display and the on-screen display.

IMPORTANT: Do not turn the receiver's Volume control up to or past the point where the audio from the speakers becomes distorted. Doing so can damage the speakers.

Receiver Rear-Panel Connections

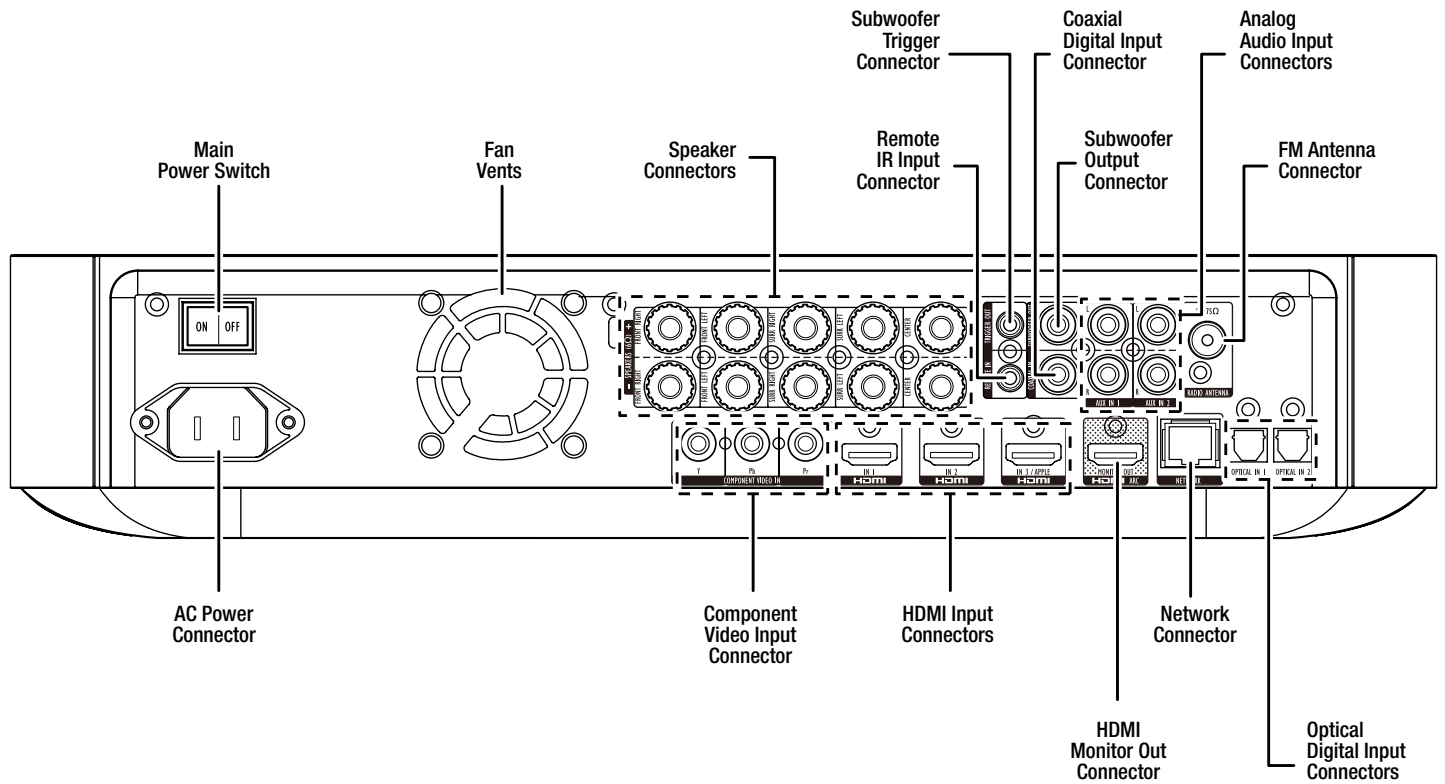

NOTE: See the *Connections* section, on page 10, for detailed information about making connections.

Main Power switch: This mechanical switch turns the BDS receiver's power supply on or off. After you have made and verified all connections (see the *Connections* section, on page 10), set this switch to the "On" position. During normal use you will usually leave this switch set to On; it cannot be turned on or off using the remote control. To conserve energy when you're not going to be using the receiver for an extended period of time, set this switch to "Off."

Fan vents: These vents are used by the receiver's fan to cool the unit. Maintain a clearance of at least three inches (75mm) from the nearest surface to avoid overheating the unit. It is normal for the fan to remain off at most normal volume levels. An automatic temperature sensor turns the fan on only when it is needed.

IMPORTANT NOTE: Never block the fan vents. Doing so could allow the BDS receiver to overheat to dangerous levels.

Speaker connectors: Use the speaker wires supplied with the speakers to connect the satellite and center speakers to the proper terminals.

- BDS 575 and BDS 577 receivers (shown) have connections for five speakers: front left, front right, surround left, surround right and center.
- BDS 275 and BDS 277 receivers (not shown) have connections for two speakers: front left and front right.

See *Connections*, on page 10, for more information.

Subwoofer Trigger connector: This connector provides 12V DC whenever the receiver is on. It can be used to turn on and off other devices such as a powered subwoofer.

Remote IR Input connector: When the IR sensor on the front panel is blocked (such as when the receiver is installed inside a cabinet), connect an optional IR receiver to the Remote IR Input connector.

Coaxial Digital Input connector: Connect the coaxial digital output of an audio-only source component here. The signal may be a Dolby® Digital bitstream, a DTS® bitstream or a standard PCM digital-audio bitstream.

NOTE: Use only one type of digital connection for each source component.

Subwoofer Output connector: Use a mono RCA audio cable to connect this jack to a powered subwoofer's line-level input or LFE jack. See *Connecting a Powered Subwoofer*, on page 10, for more details about making connections.

Analog Audio Input connectors: Use these connectors to connect to an audio-only source devices (such as a tape deck). Do not connect a turntable to these connectors without a phono preamp.

FM Antenna connector: Connect the supplied FM antenna to this terminal.

Optical Digital Input connectors: Connect the optical digital output of an audio-only source component here. The signal may be a Dolby Digital bitstream, a DTS bitstream or a standard PCM digital-audio bitstream.

NOTE: Use only one type of digital connection for each source component.

Network connector: Use a Cat. 5 or Cat. 5E cable (not supplied) to connect the BDS receiver's Network connector to your home network to enjoy streaming content and content from DLNA®-compatible devices that are joined to the network. See *Connect to Your Home Network*, on page 12, for more information.

HDMI® Monitor Out connector: Connect the BDS receiver's HDMI output to your TV's HDMI input. Since the HDMI cable transmits both video and audio to the TV, we recommend that you set the BDS receiver's HDMI audio output to Off in the receiver's Audio menu to take full advantage of your BDS receiver's superior audio performance. If your TV is 3D capable you can watch 3D content in 3D either from the BDS receiver's built-in disc player or from other 3D-capable source devices connected to the BDS receiver's HDMI Input connectors (see below).

The receiver's HDMI Monitor Out connection also contains an Audio Return Channel that carries a digital audio signal from your TV or video display back to the receiver. It allows you to listen to HDMI devices that are connected directly to your TV (such as an Internet connection) without making an additional connection from the device to the BDS receiver.

HDMI Input connectors: You can connect up to three additional source devices that have HDMI connectors to the BDS receiver. The HDMI connection transmits digital audio and video signals between devices, so you do not have to make any additional audio connections for devices you connect via an HDMI connector. The BDS receiver will pass 3D video signals from 3D capable HDMI source devices to the TV via the HDMI Monitor Out connector. See *Connecting Your HDMI Source Devices*, on page 11, for more information.

NOTE: If you have an Apple TV, connect its HDMI output to the BDS receiver's HDMI 3 input. When HDMI 3 is the selected source you can use the BDS remote to control various Apple TV functions. See *Controlling an Apple TV*, on page 15 for more information.

Component Video Input connector: If you have a video source device that has a component video connector (and does not have an HDMI connector), use the component video connector. You will also need to make an audio connection from the device to one of the BDS receiver's audio input connectors. See *Connections*, on page 10, for more information.

AC Power connector: After you have made and verified all other connections, plug the supplied AC power cord into this input and into an unswitched AC outlet.

Remote Control Functions

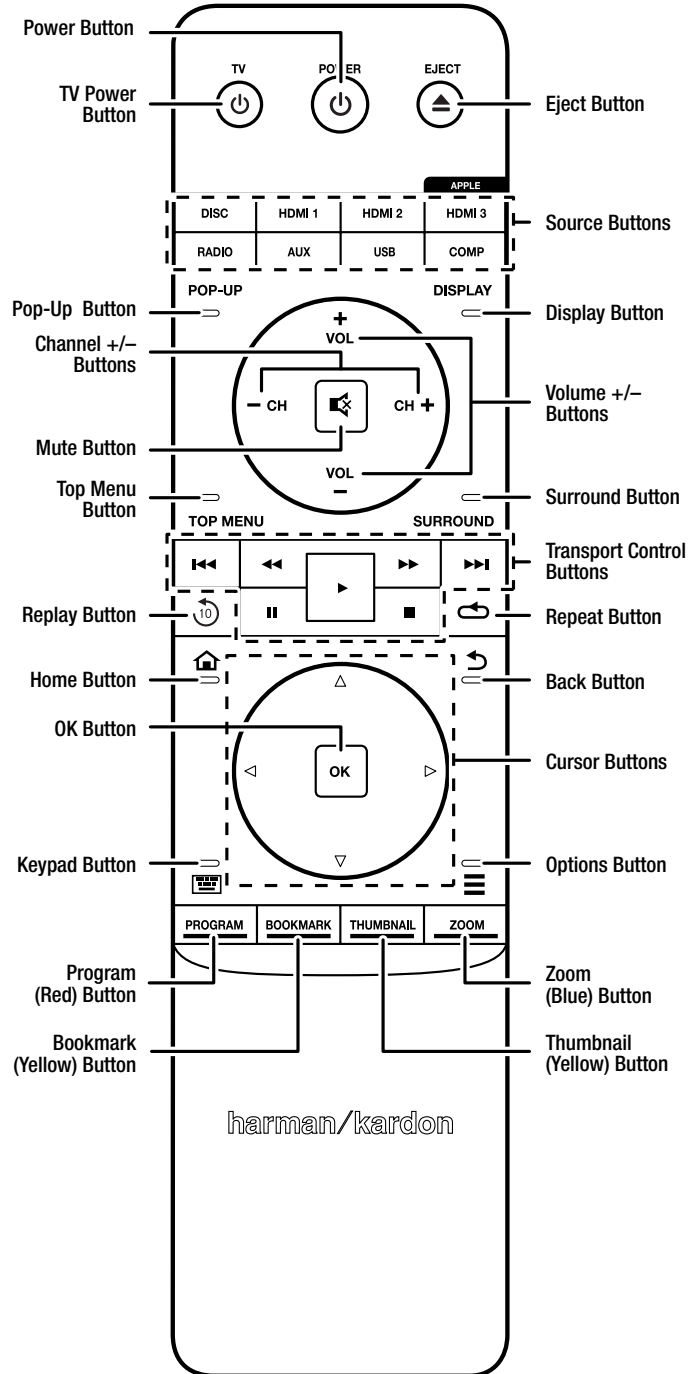

Power button: Pressing this button toggles the BDS receiver between the On and Standby modes. NOTE: If the receiver goes for 30 minutes without receiving an audio signal or a user command, it will automatically enter the standby mode to conserve electrical power.

TV Power button: After you program the remote control, pressing this button turns the TV's power on and off. See *Programming the Remote Control*, on page 13.

Eject button: Press this button to eject a disc from the BDS receiver's built-in disc player. Before pressing this button, make sure no objects are blocking the disc slot opening.

Source buttons: Press one of these buttons to select a source device. This action will also turn on the BDS receiver from the Standby mode.

- The first press of the USB button switches the BDS receiver to the last-used USB port source (USB or iPod). Each successive press cycles between the two sources.
- The first press of the Aux button switches the BDS receiver to the last-used of the following sources: Coaxial Digital, Optical Digital 1, Optical Digital 2, Analog Audio 1, Analog Audio 2, HDMI ARC. Each successive press advances the BDS receiver through those sources.

Pressing the Aux button also places the remote into the auxiliary-component control mode, enabling the remote to use any pre-programmed and/or learned functions. See *Listening to Audio Sources*, on page 25, for more information.

NOTE: You must use the Home menu to select *Bluetooth* and network-based sources (DLNA, YouTube™, Pandora® and Picasa™). See *Using the Receiver*, on page 20, for more information.

Pop-Up button: Pressing this button while playing a Blu-ray Disc recording or DVD displays its disc menu. NOTE: This feature is disc-dependent. Not all DVDs have pop-up menus. If a DVD has no pop-up menu, pressing the Pop-Up button may display the disc menu, depending on how the disc's menu system was authored.

Display button: When you are playing Blu-ray Disc and DVD recordings, pressing this button activates a bar display containing information about the currently-playing disc or program. When you are playing a video or photo slideshow from an inserted USB device, pressing this button displays the Status bar. The button does not function when the BDS receiver is playing material from an iOS device, an auxiliary source or the radio.

Channel +/- buttons: When Radio or Pandora the source selected on the remote control, the Channel +/- buttons select the next higher or lower preset station.

Volume +/- buttons: Press these buttons to increase or decrease the volume of the BDS receiver's speaker outputs. NOTE: The Volume +/- buttons do not change the volume of the HDMI audio output.

IMPORTANT: Do not turn the Volume buttons up to or past the point where the audio from the speakers becomes distorted. Doing so can damage the speakers.

Mute button: Press this button to mute the sound from the BDS receiver's speaker outputs. Press the button again to un-mute the sound. NOTE: The Mute button does not mute the HDMI audio output.

Top Menu button: Displays the top menu of the Blu-ray Disc recording or DVD that is playing. NOTE: This feature is disc-dependent. Not all DVDs have top menus. If the DVD has no top menu, pressing the Top Menu button may display the disc menu, depending on how the disc's menu system was authored. See *Using the Disc Player*, on page 22, for details.

Surround button: Pressing this button cycles through all of the surround-sound modes that are available for the active program. Each press of the Surround button will change to the next mode in line. A pop-up display will appear, showing the modes as you cycle through them. NOTE: Not all surround modes will be available for all programs. See *Surround-Sound Modes*, on page 21, for more information.

Transport Control buttons: These buttons control the BDS receiver's built-in Blu-ray Disc player, iOS and USB devices and streaming sources. When the remote is in the Aux component control mode, they can control functions of the auxiliary component.

Replay button: Press this button to replay the previous 10 seconds of media playing on Blu-ray, CD, USB and data disc.

Repeat button: When the BDS receiver is playing a Blu-ray Disc recording pressing this button cycles through the following repeat modes: Chapter, Title, Off. When the BDS receiver is playing a DVD, pressing this button cycles through the following repeat modes: Chapter, Title, All, Off. When the BDS receiver is playing a CD or listening to media stored on an iPod or USB device, this button cycles through the following repeat modes: Track, All, Off.

Home button: Pressing this button returns the on-screen display to the Home screen from whatever screen is active when the button is pressed.

Back button: Pressing this button exits the current on-screen menu and displays the previous screen.

OK button: Press this button to select the highlighted item on the on-screen menu.

Cursor buttons: Use these buttons to navigate through items on the on-screen menu.

Keypad button: Press this button to display a 10-keypad for entering letters and numbers, such as for network setup, disc track/chapter search, etc.

Options button: Pressing this button displays any available options for the item that is active at the time the button is pressed. When listening to an Aux source, pressing the Options button lets you adjust the audio delay to eliminate "lip sync" errors between the sound and picture when watching video programs with sound playing through one of the receiver's rear-panel audio inputs. See *Listening to Audio Sources*, on page 25, for details.

Program (Red) button: Press this button to create a programmed playback list for the currently-playing disc. See *Programmed Play*, on page 23, for more information.

Zoom (Blue) button: Press the Zoom button to zoom in on or recede from a video image or slide. Use the Navigation buttons to zoom in on different sections of the image. NOTE: This function is disc-dependent for Blu-ray Disc recordings and DVDs. Not all discs can be zoomed in on.

Bookmark (Green) button: Press this button to activate the Bookmark function. See *Bookmark Function*, on page 23, for more information.

Thumbnail (Yellow) button: Press this button while playing a photo slide show to display thumbnail images of all photos in the slide show.

Red, Green, Yellow and Blue buttons: When the BDS receiver is playing a Blu-ray Disc recording, these buttons can activate features and menus that may vary from disc to disc. Refer to the menu instructions for each particular disc for more information. NOTE: These Blu-ray Disc functions may override the Bookmark, Thumbnail, Program and Zoom functions.

Connections

CAUTION: Before making any connections to the BDS receiver, ensure that the receiver's AC cord is unplugged from the receiver and the AC outlet. Making speaker connections with the receiver plugged in and turned on could damage the speakers.

Your BDS receiver has color-coded speaker terminals:

BDS 275/BDS 277

white:	left channel (+)
red:	right channel (+)
black:	(-) on both channels

BDS 575/BDS 577

white:	front left (+)
red:	front right (+)
blue:	surround left (+)
gray:	surround right (+)
green:	center (+)
black:	(-) on all channels

Be sure to connect each speaker identically: (+) on the speaker to (+) on the receiver or amplifier, and (-) on the speaker to (-) on the receiver or amplifier. Miswiring one or more speakers results in thin sound, weak bass and a poor stereo image.

CAUTION: Make sure the (+) and (-) bare wires do not touch each other or any metal object on the receiver's rear panel. Touching wires can cause a short circuit that can damage your receiver or amplifier.

Connecting the Speakers

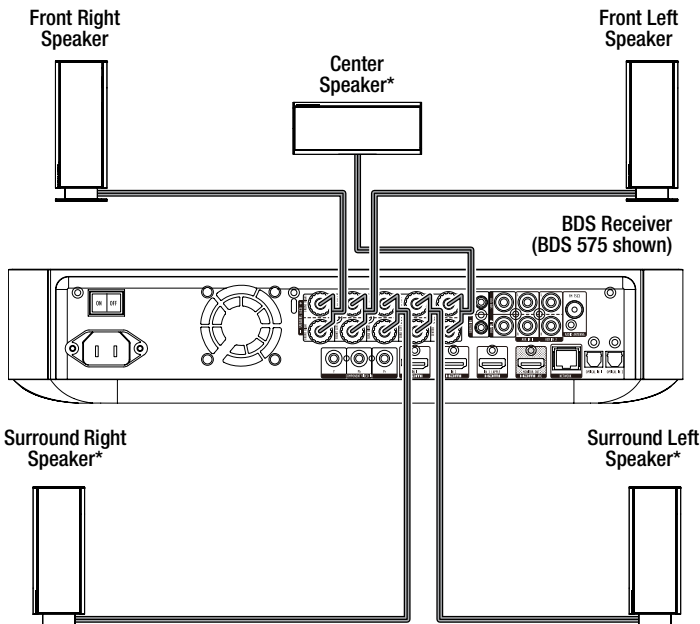

* Used only with BDS 575/BDS 577 receivers

Connecting the Receiver Terminals

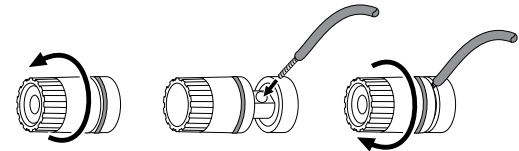

A. Unscrew Cap B. Insert Bare Wire C. Tighten Cap

Connecting a Powered Subwoofer

Use a mono RCA audio cable to connect the BDS receiver's Subwoofer Output connector to your powered subwoofer; consult your subwoofer's user manual for information about making connections to your subwoofer.

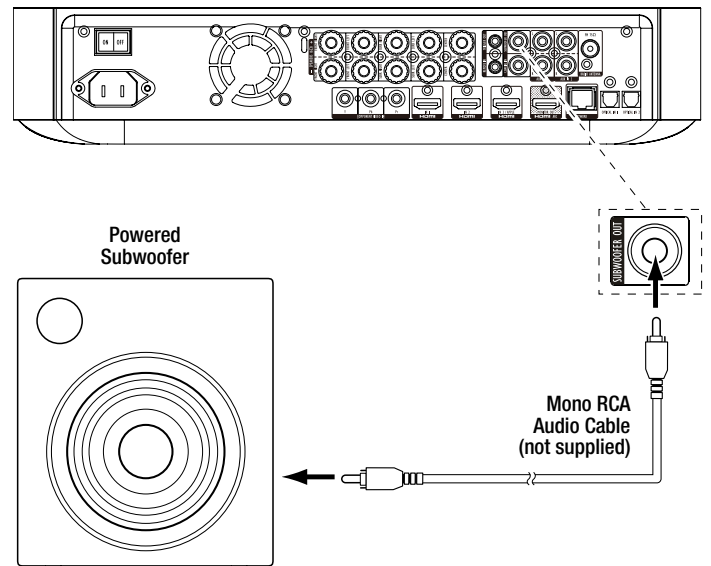

IMPORTANT: Do not plug the subwoofer's AC power cord into an AC outlet at this time.

Connecting the FM Antenna

Connect the supplied antenna to the FM Antenna connector, as shown in the illustration below. Fully extend the antenna wire and move it to different positions until you get the best reception of your favorite stations.

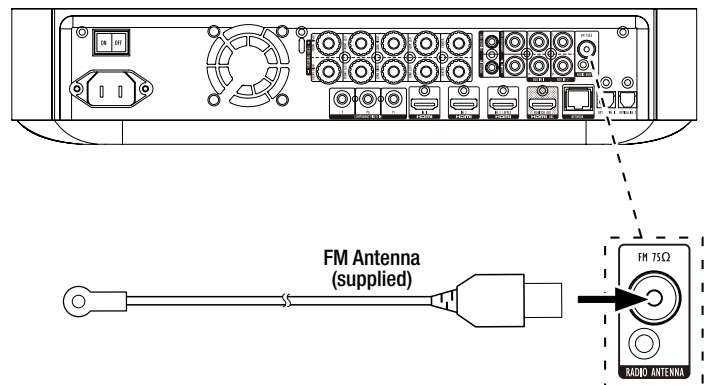

Connecting a TV or Video Display

Use the supplied HDMI cable to connect the BDS receiver's HDMI output to your TV/video display's HDMI input. The BDS receiver is HDMI with 3D and 30/36-bit Deep Color.

NOTE: If you have devices (such as an Internet modem) already connected directly to your TV, you can feed their sound to the BDS receiver via the HDMI Monitor Out connector's Audio Return Channel, and they will not require additional connections to the receiver.

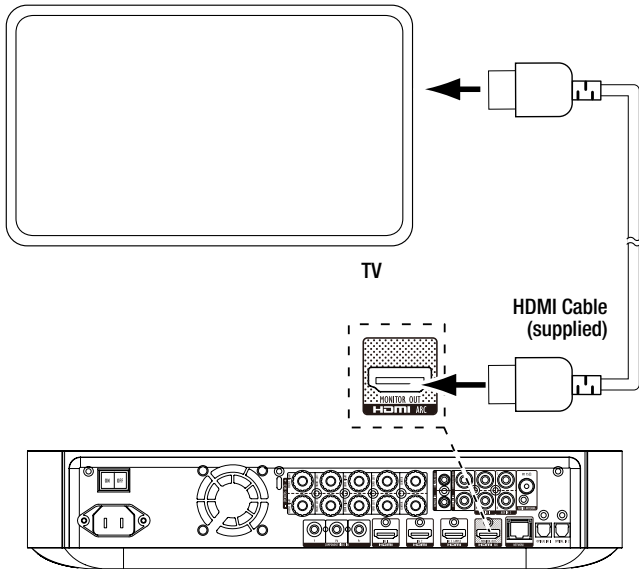

NOTE: The HDMI connection will deliver both video and audio to your TV or video display. We suggest disabling your TV or video display's audio system to take full advantage of your BDS receiver's superior audio reproduction.

Connecting Your HDMI Source Devices

If you have any source devices with HDMI connectors, using them will provide the best possible video and audio performance quality. Since the HDMI cable carries both digital video and digital audio signals, you do not have to make any additional audio connections for devices you connect via an HDMI cable.

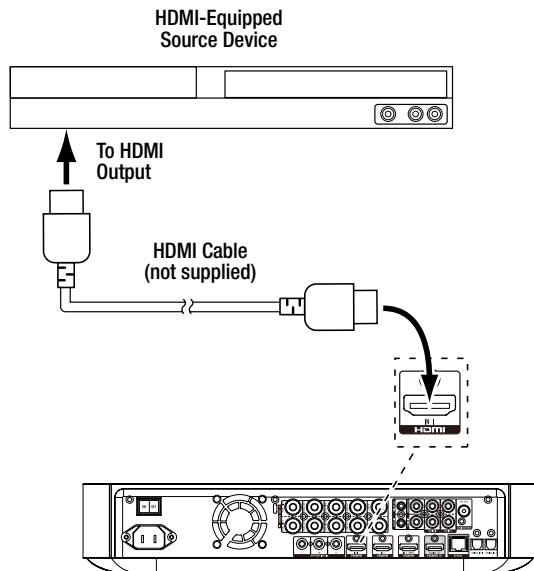

Connecting Your Component Video Source Device

If you have a video source device that has a component video connector (and does not have an HDMI connector), using the component video connector will provide superior video performance. You will also need to make an audio connection from the device to one of the receiver's analog or digital audio input connectors.

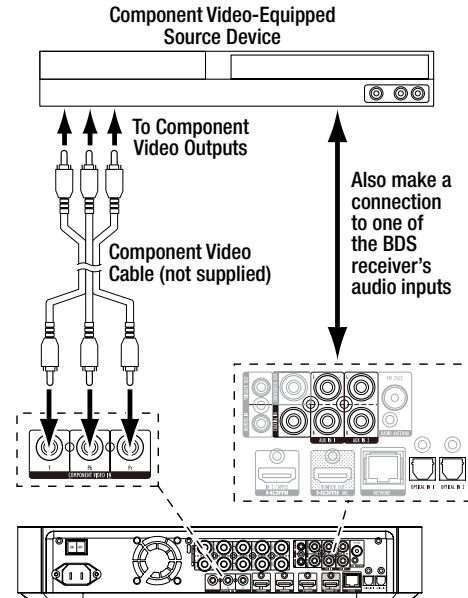

Connecting Your Optical Digital Audio Source Devices

If up to two of your non-HDMI source devices have optical digital outputs, connect them to the receiver's optical digital audio connectors. NOTE: Make only one type of digital connection (HDMI, optical or coaxial) from each device.

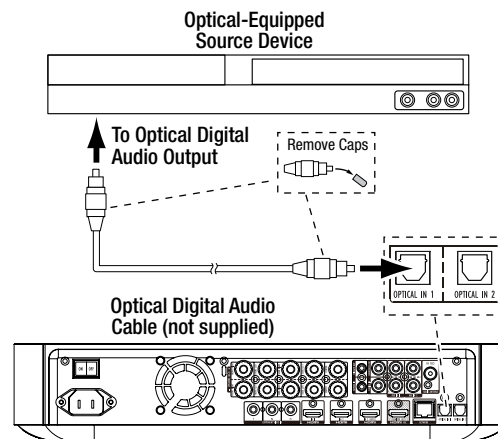

Connecting Your Coaxial Digital Audio Source Device

If one of your non-HDMI source devices has a coaxial digital output, connect it to the receiver's Coaxial Digital Input connector. NOTE: Make only one type of digital connection (HDMI, optical or coaxial) from each device.

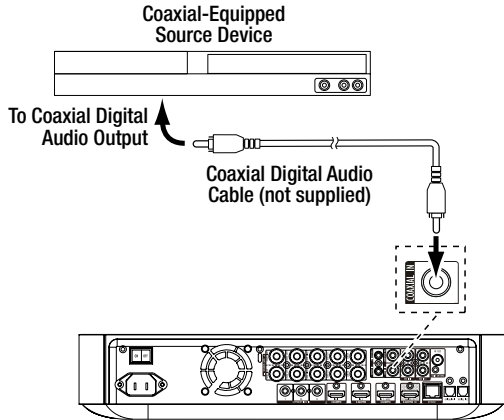

Connecting Your Analog Audio Source Devices

Use the receiver's Aux In connectors for up to two source devices that don't have HDMI or digital audio connectors.

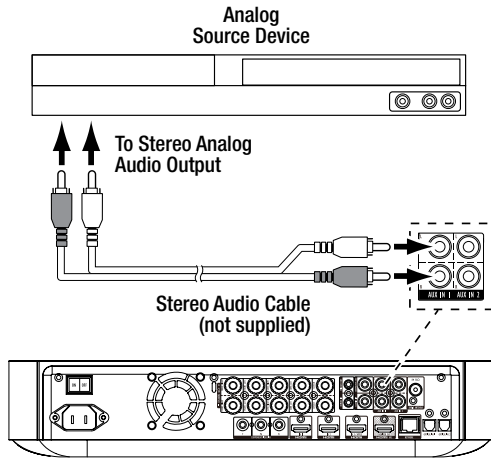

Connecting to Your Home

Use a Cat. 5/5E network cable (not supplied) to connect the BDS receiver's Network connector directly to your home network router, network switch, network modem or Ethernet network wall jack that has Internet access. See *General Settings: Network*, on page 17, for information about joining the BDS receiver with your home network.

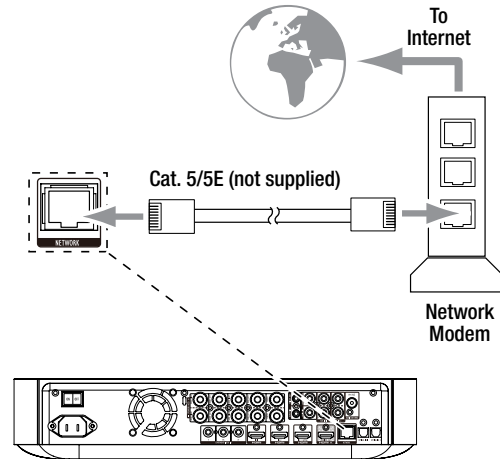

Connect the Subwoofer Trigger Output

If your system has equipment that can be controlled by a DC trigger signal, connect it to the receiver's Subwoofer Trigger connector with a mono 1/8-inch (3.5mm) mini-plug interconnect cable (not supplied). The receiver will supply a 12V DC (100mA) trigger signal at this connection whenever it is powered on.

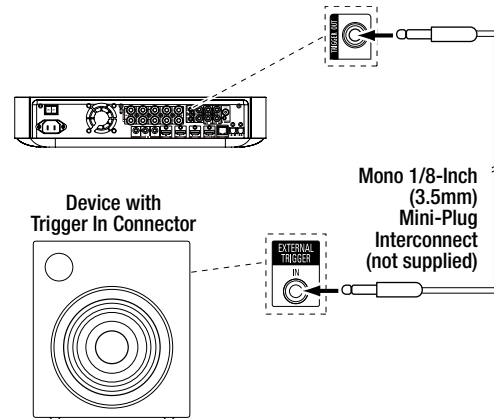

Connect the Remote IR Input

The BDS receiver is equipped with a Remote IR Input connector that lets you remotely control the receiver when you place it inside a cabinet or in a location that is out of the line of sight of the remote control. Connect an external IR receiver, such as the optional Harman Kardon HE 1000, to the receiver's Remote IR Input connector.

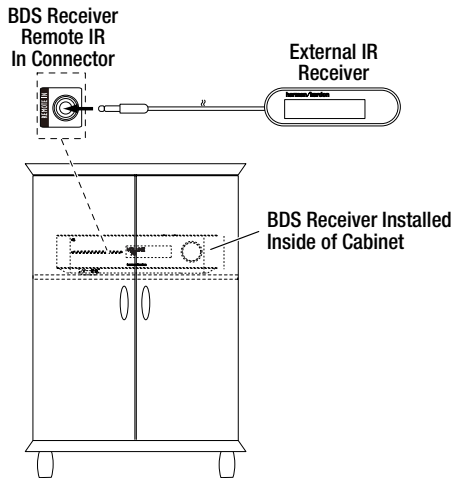

Connecting the AC Power

The BDS receiver comes with a detachable AC power cord. This type of cord makes it easier for you to install and connect all other system wiring to the receiver's rear panel.

NOTES:

- The power requirement for the BDS receiver is 110V – 240V AC, 50/60Hz, 120W (BDS 575/BDS 577) or 90W (BDS 275/BDS 277). Connecting to a power source other than the ones listed may damage the receiver or cause abnormal operation.
- Before connecting the AC power cord to a wall outlet, confirm that you have correctly made all of the speaker connections, video connections and audio-component connections.

Connect the female end of the receiver's detachable power cord to the receiver's AC Power connector. Plug the other end into a working, *unswitched* AC outlet.

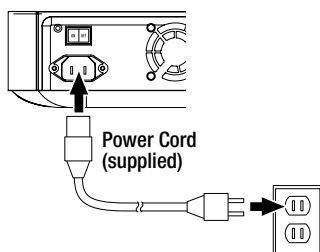

Set the receiver's Main Power switch to the "On" position. The receiver's On/Standby indicator will turn *amber*, indicating that the receiver is in the Standby mode.

Preparing the Remote Control

Installing the Batteries

Your receiver's remote control uses three AAA batteries (supplied). Insert the batteries as shown in the illustration, making sure to observe the correct polarity.

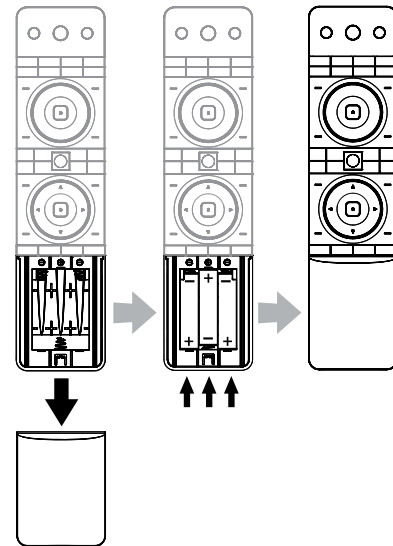

Using the Remote

When using the remote, remember to aim it toward the receiver's front panel. Make sure that no objects, such as furniture, block the remote's view of the receiver. Bright lights, fluorescent lights, and plasma-video displays may interfere with the function of the remote.

- The remote has a range of about 20 feet (6.1m), depending on the lighting conditions.
- You can use the remote at an angle of up to 30° to either side of the BDS receiver.

If the remote seems to operate intermittently, or if pressing a button on the remote does not cause one of the Input buttons to light up, make sure that the batteries are inserted correctly. If the remote still operates intermittently, replace all three batteries with new ones.

Programming the Remote Control

In addition to controlling the BDS receiver, you can program the unit's remote to control one auxiliary (Aux) component. The remote is also capable of learning codes directly from other remotes. This ability allows you to combine learned commands with programmed codes, making the remote capable of controlling more than one Aux component. Typical Aux components would be your TV, a satellite receiver or a cable receiver. The remote will control the Aux component(s) only when the Aux source button has been pressed. Pressing any other source button will put the remote back into the normal BDS receiver control mode.

To Program the Remote to Control an Aux Component:

1. Look up the set-up codes for the component type (for example, TV or cable box) and its brand in the *Aux Component Remote-Control Code List*, starting on page 29.
2. Turn on your auxiliary component.
3. Press and hold the Aux button for three seconds, and then release it.

NOTE: The remote will remain in the programming mode for 20 seconds; you must perform Step 4 within that time period.

- Aim the remote towards the component you just turned on and enter a set-up code number from Step 1, above. Use the *Program* (Red) button for the first digit; the *Bookmark* (Green) button for the second digit; the *Thumbnail* (Yellow) button for the third digit; and the *Zoom* (Blue) button for the last digit. If the code to be entered is "0" you do not need to press the corresponding button; for numbers "1" and above, press the button that number of times. When you have entered all four digits, press the OK button – the component should now turn off.
- Test the BDS remote control for your device using the Power Off/On, Channel Up and Down, FF, REW, Stop, Pause, Play, Skip Forward and Skip Back buttons. If any of the buttons do not perform correctly, repeat the process from Step 1 using the next set-up code number from the list for that manufacturer.
- If the remote control operates correctly in Step 5, press the Aux button once again to store the set-up code number. To confirm that the code has been saved, the LED indicator will blink three times.

Auto Search Method

If you have tried all of the four digit set-up code numbers listed for your device and it still did not turn off, you should use the following *Auto Search Method*.

- Turn on the device you would like the BDS remote to control, either manually or with its own remote control.
- Press and hold down the Aux device button for three seconds; the BDS remote will enter set-up mode. NOTE: The remote will remain in the programming mode for 20 seconds; you must perform Step 3 within that time.
- Select the region you are located in and the type of device that you are programming: For a US TV, do not press any of *Program* (Red), *Bookmark* (Green), *Thumbnail* (Yellow) or *Zoom* (Blue) buttons.
 - For an EU TV, press the *Program* (Red) button one (1) time.
 - For an HDTV, press the *Program* (Red) button two (2) times.
 - For a US cable tuner, press the *Program* (Red) button three (3) times.
 - For an EU cable tuner, press the *Program* (Red) button four (4) times.
 - For a US satellite tuner, press the *Program* (Red) button five (5) times.
 - For an EU satellite tuner, press the *Program* (Red) button six (6) times.
- Point the BDS remote control toward the device and press the Cursor Up button; each button press sends a "Power" signal for one set-up code number. Continuing to press the Cursor Up button will produce a quick scanning of the set-up code numbers. Release the Cursor Up button as soon as the device turns off. If you go past the correct set-up code number, you can return to it by pressing the Cursor Down button, one code number at a time, until the device turns back on.
- Test that the BDS remote control works for your device by pressing the Power Off/On, Channel Up and Down, FF, REW, Stop, Pause, Play, Skip Forward and Skip Back buttons. If any of the buttons do not perform as expected, repeat the set-up from Step 3.
- If the BDS remote control is operating correctly at Step 4, press the Aux Button once again to store the set-up code number. To confirm that the code has been saved, the LED indicator will blink three times.

Programming Individual Button Codes on the Remote:

You can program codes from other component remotes onto the BDS remote's buttons that are shown shaded in the following illustration:



- Press and simultaneously hold down the Aux and the Program (Red) buttons on the BDS remote control for at least three seconds. The remote's Aux button will blink once.
- Place the BDS receiver remote and the remote from which you want it to learn codes head-to-head about 1 inch (2.5cm) apart, with their IR transmitter windows facing one other.
- Press the button on the BDS remote to which you want to teach a command. (The remote will remain in the learning mode for 20 seconds after the button is pushed.)
- Press the button on the other remote that you want to "teach" to the BDS remote. When the IR code has been received and stored, the Aux button's LED will flash three times, and the BDS receiver remote will remain in the learning mode, ready to learn another code. If no IR code is received within 20 seconds, the Aux LED will flash rapidly several times, and the remote will exit the learning mode.
- Repeat Step 3 and Step 4 for each command you want to teach the BDS receiver remote. NOTE: If the Aux button's LED goes out at any time, you will need to begin again from Step 2. until it blinks three times.
- Press the Aux button once, or wait for 20 seconds to cancel learning program mode. NOTE: Any previously stored set-up code will be erased when program mode is activated.

Channel Control "Punch Through" Commands

After programming the remote to control an auxiliary (Aux) component, you can also program it to control the Aux component's channel up/down and transport functions (Play, Pause, etc.) even when the remote is not in the Aux control mode. For example, if the remote is programmed to operate your TV in the Aux control mode, you can also have the TV's channel +/- functions "punch through" and operate even when the remote is in the Disc, Radio or USB control modes, for example. (NOTE: When this feature is active, TV or satellite channel +/- functions will override any existing channel controls set to that mode.)

1. Press and hold the source button for the main device the remote will be operating. The button will light up, go dark and then light up again. Release the button.
2. Select the type of punch-through programming.
 - a) For “punch-through” channel control, press the Channel + button.
 - b) For “punch-through” transport control, press the Play button.
3. Press the Aux button. The original source button will flash to confirm operation.

You can repeat Step 1 – Step 3 for any of the remote’s source buttons (Disc, Radio, etc.).

NOTE: “Punch-through” channel and transport commands will override the existing commands for those buttons in the source modes you program.

To undo “punch-through” programming, follow the same steps as above, but press the same source button in Step 1 and Step 3.

Erasing a Learned Code and Restoring the Original Button Code

1. Press and simultaneously hold down the Aux and Bookmark (Green) buttons on the BDS remote control for at least three seconds. The BDS remote will enter the learning mode after the Aux button LED turns on.
2. Press and release the remote control button that you want to erase. The Aux button’s LED will flash three times.
3. To erase other buttons, press the selected buttons.
4. To exit the erase mode, press Aux button.

Resetting the Remote to Factory Default Condition

1. Press and simultaneously hold down the Aux and Thumbnail (Yellow) buttons on the BDS remote control for at least three seconds.
2. The Aux LED will flash three times and exit learn-erase mode. Note: By erasing all learned codes, all of the BDS remote buttons will return to their original functions.

Controlling an Apple TV

If you have connected an Apple TV to the BDS receiver’s HDMI 3 input, you can also use the BDS remote to control an Apple TV that is streaming audio and video files stored on your home network, or accessing media from an Internet service such as Netflix, as shown in the illustration below.

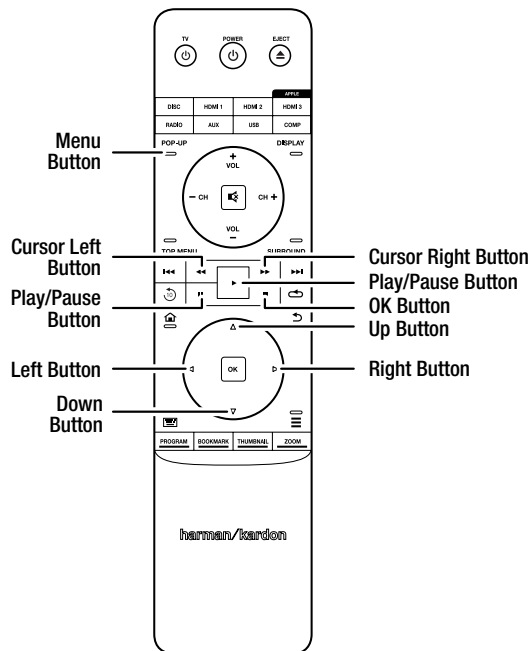

Select any other input source to return the BDS remote to its normal operation.

Using the Remote After it is Programmed

Pressing the remote’s Aux Input button will put the remote into the auxiliary-control mode, and it will control the auxiliary component(s) via the codes you have programmed into it.

To switch the remote back to the BDS receiver-control mode from the auxiliary-control mode, press any of the other Input buttons or the Home button.

Setting Up the Receiver

NOTE: The menu screens shown in this manual are for illustrative purposes and may differ somewhat from the actual displays.

To set up your BDS receiver, you will use the remote to navigate through all of the on-screen menus and to make selections from them.

- Use the Cursor Up/Down buttons to navigate through the menu list. When an item is highlighted, a blue border will appear around it.
- To select a highlighted item, press the OK button. The screen will change depending on your selection.
- To return to the previous screen, press the Previous button.

Initial Setup

When you turn your BDS receiver on for the first time, the on-screen menu will display the Initial Setup screen. The first screen lets you set the language you want the BDS receiver to use.

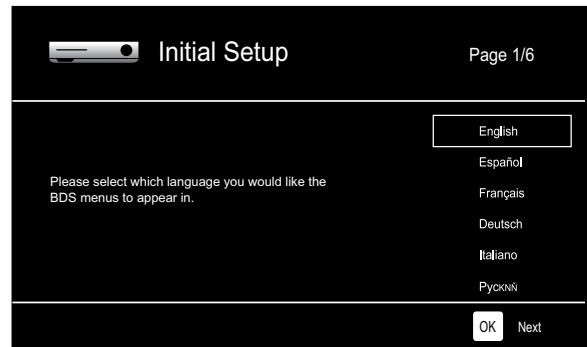

After you set the language, press the OK button and the Initial Setup introduction screen will appear.

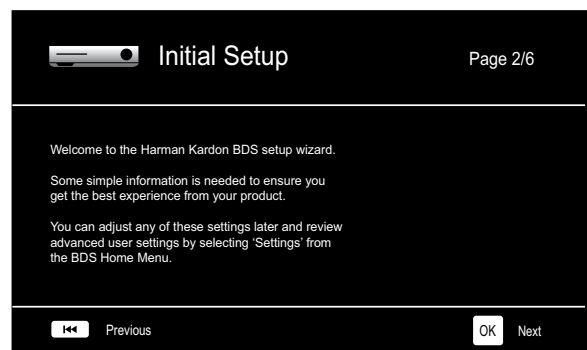

Press the OK button and the TV-resolution screen will appear.



After selecting your TV's highest resolution, press the OK button, and the TV aspect-ratio screen will appear. Note: If you are unsure of your display's highest resolution, select "Auto" and the BDS receiver will select the optimal resolution for you.

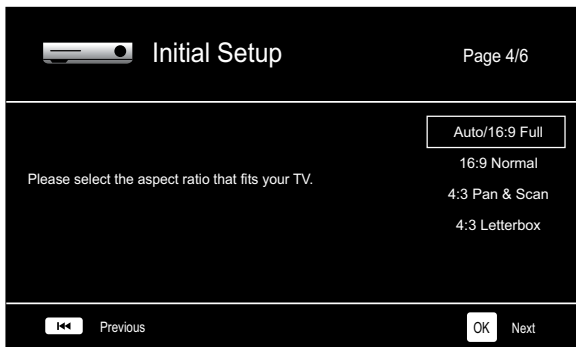

After selecting the aspect ratio that best fits your TV, press the OK button and the Initial Setup speaker package screen will appear.

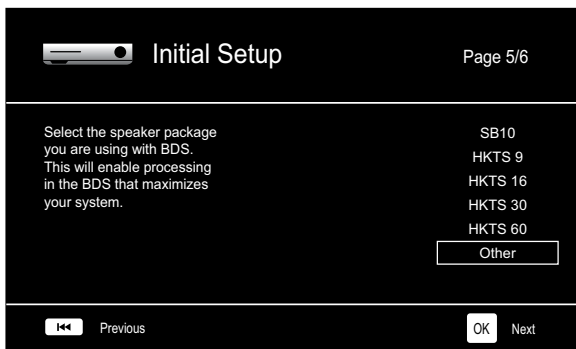

This setting enables processing in the BDS receiver that will maximize your system's audio performance. If you are using a Harman Kardon speaker package with your BDS receiver, select its model number from the list. If you're not using a Harman Kardon speaker package, select "Other."

Press the OK button to save your settings and then press it again to exit the Initial Setup screens.

Settings Menu

Press the "Home" button on the remote control to select the Home Menu. From here you can choose a number of audio and video sources, and access the Settings menu that lets you set up the receiver's various functions. To access the Settings menu, scroll down through the Home Menu's various options using the Cursor Down button until you reach the Settings menu.

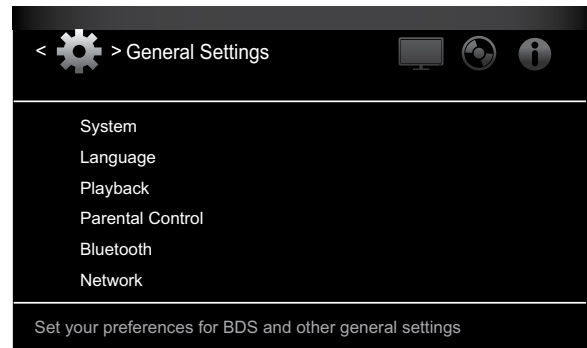

Use the remote's Cursor Left/Right buttons to move from one menu to another, use the Cursor Up/Down buttons to navigate through the lists that appear on the various screens, and use the OK button to select highlighted items. Press the Back button at any time to return to the previous screen.

General Settings

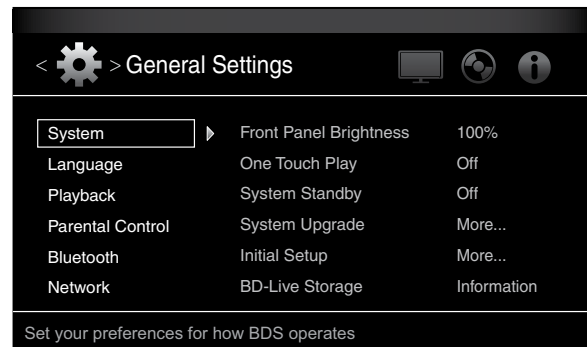

System: The System option allows you to set the following system features:

Front Panel Brightness: This option sets the brightness of the BDS receiver's information Display, from Off/Auto Dim to 100%.

One Touch Play: When this option is set to "On," pressing the Play button on the BDS receiver when a Blu-ray Disc or DVD is inserted will automatically turn on a connected TV and switch it to the input where the BDS receiver is connected. NOTE: The TV must support HDMI CEC (Consumer Electronics Control).

System Standby: When this option is set to "On," putting a connected TV into Standby mode will automatically place the connected BDS receiver into standby mode. NOTE: The TV must support HDMI CEC (Consumer Electronics Control).

System Upgrade: Select this option when you want to install a firmware upgrade for your BDS receiver that you've downloaded from a Harman Kardon Web site or other Harman Kardon source. Such an upgrade can be performed via a USB thumb drive, the Internet (through the BDS receiver's Network connection) or via a CD-ROM disc.

NOTE: We recommend using a USB thumb drive or the Internet connection whenever possible, as upgrading via a CD-ROM disc takes several times longer.

Initial Setup: This option activates the receiver's Initial Setup process (see *Initial Setup*, on page 15).

BD-Live Storage: When you select the BD-Live features from a disc's menu, you may be able to download additional content or other information via the Internet (through the BDS receiver's Network connection) and onto a memory device inserted into the receiver's USB port. This option lets you see how much space is available on the memory device, and lets you delete previously-stored BD-Live content from the device. (See *BD-Live Interactivity*, on page 23, for more details.)

Restore Defaults: This option restores the receiver to its factory-default setting values. NOTE: This procedure deletes all preset FM station settings and restores the parental-control password back to the factory default of 0000.

Language: This setting lets you set the Player Language for the Blu-ray Disc or DVD player and the Disc Menus, the preferred audio language, and the preferred subtitle language. NOTE: If the selected language is not available on the particular disc being played, use the disc's menu to set the language from those available on the disc.

Playback: The Playback option allows you to set the following disc playback features:

Show Angle Icon: This option lets you select whether or not the angle icon will automatically be displayed when a disc with multiple camera angles is played.

Auto Play: This option lets you select whether discs will automatically begin playing when they are inserted into the BDS receiver's disc player.

Show PIP Icon: This option lets you select whether or not the picture-in-picture (PIP) icon will be displayed automatically when a Blu-ray Disc recording with PIP content is played.

Secondary Audio Icon: This option lets you select whether or not the Secondary Audio Icon will automatically be displayed when a Blu-ray Disc recording with secondary audio content is played.

Disc Resume: This option lets you select whether or not a disc that has been ejected while playing will resume play from that location when it is re-inserted into the receiver's disc player.

DivX® VOD DRM: This option displays your receiver's DivX Video-On-Demand Digital Rights Management registration information.

Parental Control: This option lets you set the receiver's parental-control password and the level of parental control you want active. Use the pop-up alphanumeric keypad to enter a new or existing password. NOTE: The default password is 0000.

Bluetooth: The BDS receiver will automatically enter and remain in the *Bluetooth* pairing mode until you pair it with a *Bluetooth* device, which can then stream audio content to the BDS receiver. When you want to pair the BDS receiver with a different *Bluetooth* device, use this setting to force the BDS receiver back into the *Bluetooth* pairing mode so you can pair it with the new device.

Network: This option allows you to set the following network features:

Information: This displays your network's IP, Subnet Mask, Gateway and DNS addresses.

Connection Test: This option tests for a working network connection to the BDS receiver.

IP Setting: This option lets you enter your network settings, either automatically or manually. Unless your network administrator instructs you otherwise, you should use the Auto option.

BD-Live Connection: This option lets you set the receiver's BD-Live connection preferences. "Always Allow" allows downloading of BD-Live content whenever a disc with BD-Live content is played. "Limit" allows downloading only if the disc is officially BD-Live certified. "Prohibited" does not allow any BD-Live access.

Proxy Setting: "Disabled" bypasses any Proxy Host and Proxy Port settings and prevents their selection. "Enabled" allows you to select and set the proxy host and proxy port if your network requires a proxy setting. This option is for advanced users only and, in most cases, should be left set to "Disabled."

Display Settings

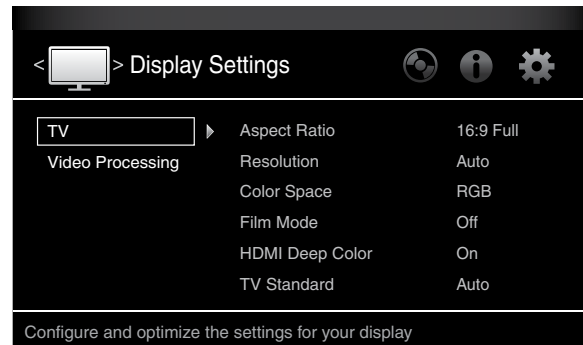

TV: This option allows you to set the following display parameters:

Aspect Ratio: This option lets you select how you want 4:3 programs displayed on a 16:9 TV, or 16:9 programs displayed on a 4:3 TV. "16:9 Full" stretches 4:3 material to fill a 16:9 TV screen. "16:9 Normal" displays 4:3 material on a 16:9 TV with black boxes on either side of the picture, preserving the program's original visual composition without distortion. "4:3 Pan & Scan" zooms in on widescreen material to fill a 4:3 screen. "4:3 Letterbox" displays 16:9 material with black bars above and below the picture, preserving the program's original visual composition without distortion.

Resolution: This option lets you select your TV's highest resolution. "Auto" automatically selects the best resolution for your TV or flat-screen display.

Color Space: This option lets you match the BDS receiver's video output to the color space of the connected TV or video display. Check the documentation for your TV or video display to determine the color space it uses.

Film Mode: If your TV can handle a 1080p 24Hz signal (if it has 1080 resolution and a video-refresh rate that is a whole-number multiple of 24), set Film Mode to "On" to get maximum resolution from Blu-ray disc content mastered at 24 frames per second. If your display cannot handle a 1080p/24Hz signal, set this option to "Off," and the BDS receiver will upconvert 24-frame-per-second film material to the standard video 30Hz refresh rate.

HDMI Deep Color: This option allows you to adjust the resolution of color output to your TV. If your TV accepts Deep Color, this option allows your TV to display an enhanced color palette.

- On: The BDS receiver outputs 36-bit Deep Color if your TV supports it. If your TV does not support 36-bit Deep Color, the receiver will output 30-bit color.
- Off: The BDS receiver does not output Deep Color (color resolution remains at 24 bits).

TV Standard: This option allows you to set the BDS receiver to match your area's television standard. Select NTSC for the USA or PAL for Europe. Select "Auto" to allow the receiver to match the standard of the connected TV automatically.

NOTE: If you use the "Auto" setting, the receiver may skip the first two seconds of PAL DivX content while it switches to the PAL mode. To avoid this, use the PAL setting.

HDMI 3D: This option lets you determine how the BDS receiver will handle HDMI 3D content. If you have connected the receiver to a 3D capable TV, select "Auto" to allow the receiver to play 3D content in 3D automatically. If you have connected the receiver to a TV that is not 3D capable, select "Off" to play 3D content in 2D.

Video Processing: This option allows you to set the BDS receiver's internal video processing.

Video Mode: This setting lets you select a preset video-processing option to optimize the picture for the current program by adjusting the brightness, contrast, color and sharpness:

- Standard: Neutral control settings.
- Vivid: For video games.
- Cinema: For movies and many television broadcasts.
- Custom: This option lets you adjust the picture settings manually. The Brightness, Saturation (color saturation), Hue, Contrast, Sharpness and CTI settings appear as sliders. The default setting for each adjustment is 0. Use the Cursor Left/Right buttons to change each setting's value.

Audio Settings

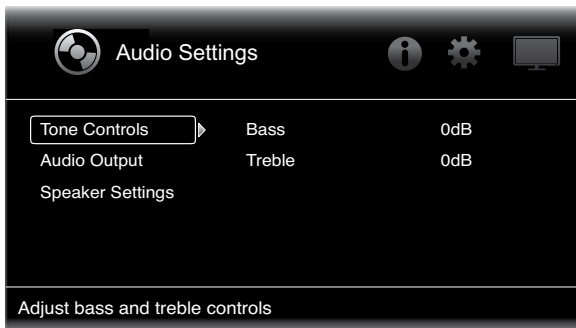

Tone Controls: This option lets you increase or decrease the amount of bass (low frequencies) and treble (high frequencies) in the sound. The adjustment ranges from -10dB to +10dB, in 1dB increments.

Audio Output: This option lets you set the following items:

HDMI Audio Out: In addition to digital video signals, the BDS receiver's HDMI connection also carries digital audio signals.

- PCM: This option outputs a two-channel downmix derived from the program's native audio format via the HDMI output.
- Off: This option turns off the receiver's HDMI audio output. We recommend setting this option to "Off," so you can take full advantage of the superior audio capability of your BDS receiver.

Dynamic Range Control: This setting makes the loud and quiet parts of a movie or music sound closer to the same volume (a process known as compression). Compression lets you turn up the volume so you can hear the quiet parts without the loud parts disturbing other people. NOTE: This feature works only with Dolby Digital programs that have been specially encoded. Three settings are available:

- Off: Never applies compression. Use this setting when the volume may be as loud as you desire.
- On: Always applies compression. Use this setting when you want the volume to be as quiet as possible without making it difficult to hear spoken dialogue.
- Auto: Applies compression based on information encoded within the Dolby Digital bitstream. The receiver will selectively apply compression only during the most dynamic parts of the soundtrack.

Component Audio Input: This setting lets you associate one of the BDS receiver's audio input connections (Coaxial In, Optical In 1, Optical In 2, Aux In 1, Aux In 2) with the Component Video Input. The audio connection you designate here will be active whenever the Component input is selected.

Speaker Settings: This option allows you to set up the receiver to work properly with your loudspeakers. There are three settings:

EzSet/EQ: This option makes the supplied EzSet/EQ microphone automatically detect the capabilities of each connected loudspeaker, and optimize the BDS receiver's performance for your speakers. This will provide excellent results in most installations.

Manual Configuration: This option lets you manually configure the BDS receiver to work with your speakers. Select this option if you wish to set up the receiver for your speakers manually or if you are unable to run EzSet/EQ calibration.

With both options, the first step is to select the configuration of your speaker system:

- 2.0: This configuration consists of left and right main speakers but no subwoofer. Selecting this configuration sends all of the bass to the left and right speakers, so be sure that they are full-range and can handle deep bass.
- 2.1: This configuration consists of left and right main speakers, plus a subwoofer.
- 3.1: This configuration consists of front left, center and front right speakers, plus a subwoofer. (This option is only available on BDS 575 and BDS 577 receivers.)
- 5.1: This configuration consists of front left, front right, center, surround left and surround right speakers, plus a subwoofer. (This option is only available on BDS 575 and BDS 577 receivers.)

Speaker Package: This setting enables processing in the BDS receiver that will maximize your system's audio performance. If you are using one of the listed Harman Kardon speaker packages with your BDS receiver, select its model number from the list. If you're not using one of the listed Harman Kardon speaker packages, select "Other."

EZ Set/EQ: The BDS receiver's EZSet/EQ™ system uses the supplied EzSet/EQ microphone to perform this important step automatically. Before beginning, be sure you have correctly connected your speakers to the BDS receiver. **IMPORTANT: Press the remote's "Disc" input button before performing the EZ Set/EQ procedure. The EZ Set/EQ procedure is only available when the Disc input is selected.**

3. Plug the supplied EzSet/EQ microphone into the BDS receiver's Headphone connector.

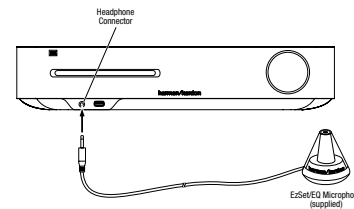

4. Place the microphone at ear height in your main listening position.
5. Select Continue in the EzSet/EQ (Automatic Setup) box that appears.

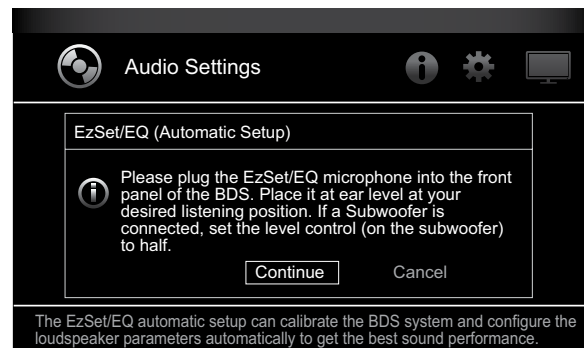

6. Remain silent while the test noise plays through the speakers. As the test noise circulates among the speakers the screen will show which speaker is being tested.

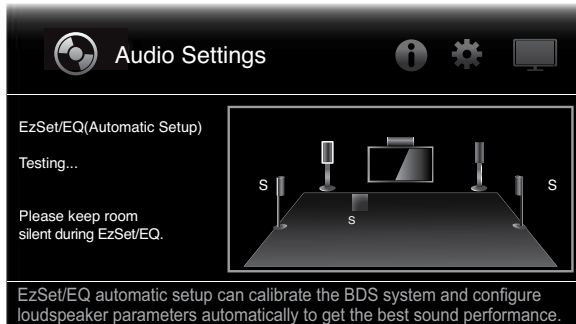

7. When the testing process is completed, the "Testing..." message on the screen will change to "All test done!"
8. Press the Back button to exit the EzSet/EQ test procedure.

NOTE: If the test fails, the "Testing..." message on the screen will change to "Test failed, please make sure all speakers are connected correctly and the room is quiet then try again." Press the Back button, make sure all speakers are correctly connected and perform the test again from Step 6. Make sure that the room remains quiet during the test.

Manual Configuration: After you select your speaker system's configuration, the speaker setup screen will appear:

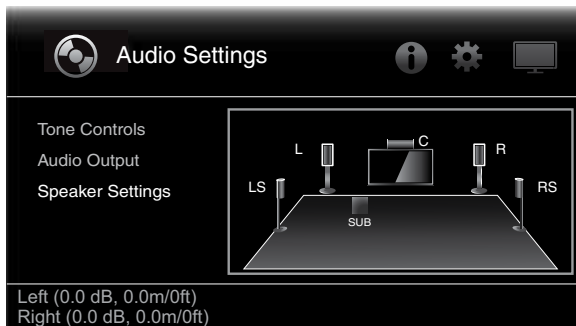

Setting the speaker distances:

1. The front left and front right speakers will be highlighted. Press the OK button. The Level and Distance selection screen will appear.

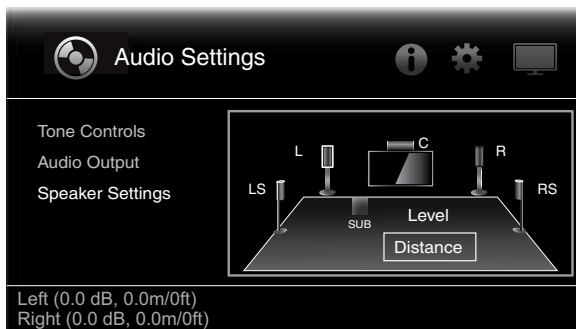

2. Press the Cursor Down button to highlight Distance, and press the OK button. The Distance adjustment bars will appear.

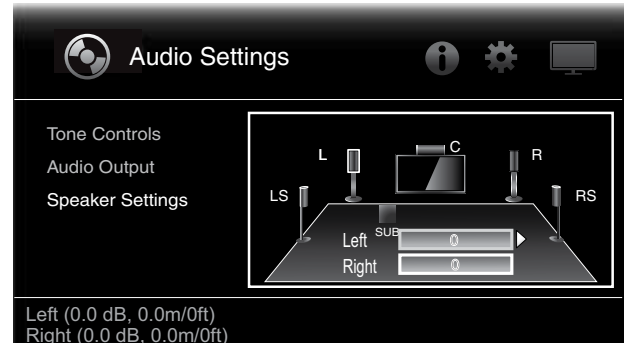

3. Measure the distance from the listening position to each of your system's speakers, including the subwoofer. Write down the distances.
4. Use the Cursor Left and Right buttons to adjust the "L" bar until it shows the distance you measured to the front left speaker (the arrowheads indicate which speaker is being adjusted).
5. Press the Cursor Down button to highlight the "R" bar. Use the Cursor Left and Right buttons to adjust the bar until it shows the distance you measured to the front right speaker.
6. Press the Back button twice to return to the speaker setup screen (the front left and front right speakers will still be highlighted).
7. Press the Cursor Down button. The subwoofer will be highlighted. Press the OK button. The Level and Distance screen will appear.
8. Repeat Steps 2 – 7 for the center speaker, surround speakers and subwoofer.
9. When you have entered the distances to all of your system's speakers, press the Back button repeatedly to return to the Home Menu screen.

NOTE: Leave all the speaker levels set at "0" for now. You will be able to adjust the individual speaker levels once your system is set up and you're playing music or films. See *Adjusting Individual Speaker Volumes*, on page 20.

Information Menu

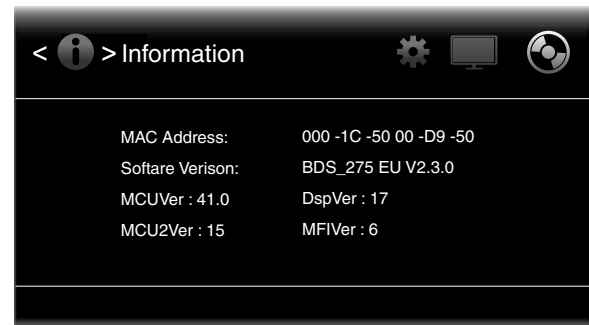

The Information menu will display the receiver's software/firmware version number and the receiver's factory-assigned network MAC address. This screen is for information only and has no user adjustments.

Using the Receiver

NOTE: Before using your new BDS receiver, be sure to set the speaker distances, as explained in *Audio Settings: Speaker Settings*, on page 18.

Home Menu

Press the Home button to display the Home Menu screen:

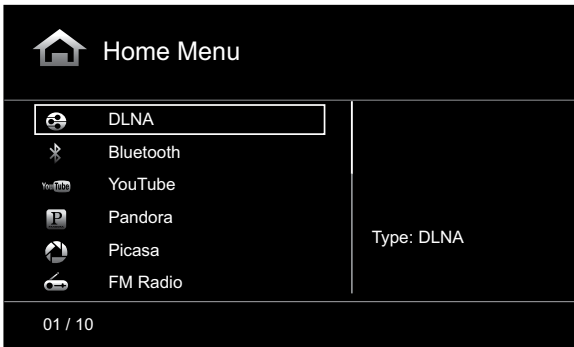

The available sources are listed on the left.

If a disc has been inserted into the receiver's built-in disc slot, it will appear on the list as either "CDDA" (CD), "DVD Video" (DVD) or "Blu-ray Disc." If you have connected an iOS device to the receiver's USB port it will appear on the list as "iPod." If you have inserted a USB device into the receiver's USB port, it will appear on the list as "USB."

NOTE: Digital and analog audio sources connected to the receiver's rear-panel digital and line inputs will not appear on the list but can be selected using the remote's "Aux" Input button (see *Listening to Audio Sources*, on page 25).

To select a source from the list, use the Cursor Up/Down buttons to highlight the desired source, then press the OK button to select it. You can also select a source directly by pressing its Input button on the remote.

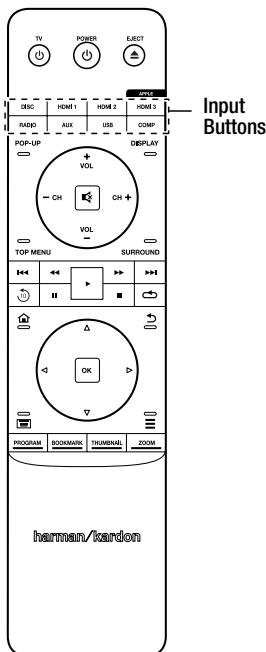

To use the Playlist function, see *Using Playlists*, on page 27.

Adjusting Individual Speaker Volumes

You can adjust the volumes of the system's individual speakers while you're listening to music.

1. Press the Home button and use the Cursor and OK buttons to select Settings. The Settings menu will appear.
2. Select the Audio Settings option. The Audio Settings menu will appear.
3. Select Speaker Settings, then select Manual Configuration, and then select your system's speaker configuration. After you select your system's configuration, the speaker setup screen will appear.

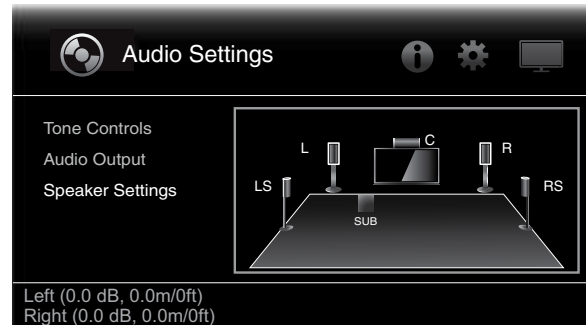

4. The front left and front right speakers will be highlighted. To adjust either of them, press the OK button. To adjust a different speaker, use the cursor buttons to highlight it, and press the OK button. The Level and Distance selection screen will appear.

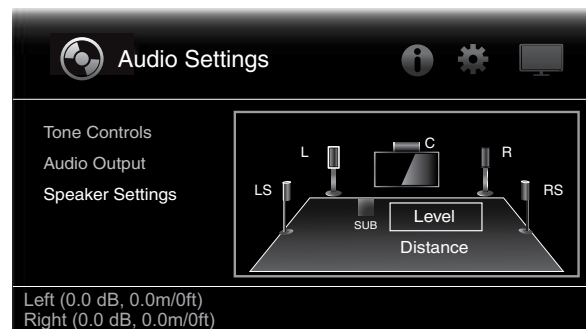

5. Make sure that Level is highlighted, and press the OK button. The Volume adjustment bars will appear.

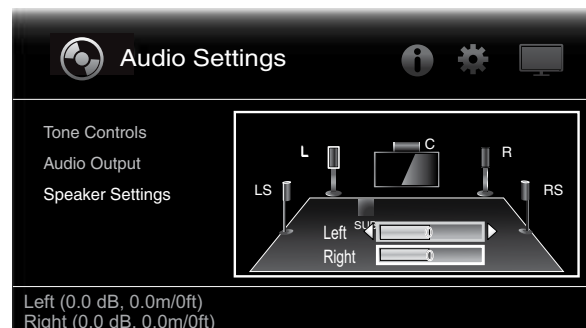

6. Select the speaker you want to adjust, and use the left and right arrow buttons to adjust its volume. You can vary the volume from +10dB to -10dB, in 1dB increments.

7. Press the Back button twice to return to the speaker setup screen (the front left and front right speakers will still be highlighted). To adjust the volume of a different speaker, use the cursor buttons to highlight it and press the OK button. Repeat Steps 5 – 6 for that speaker.
8. When you are finished adjusting the volumes of all of your system's speakers, press the Back button repeatedly to return to the Home Menu screen.

Notes on Setting Speaker Volumes in 5.1-Channel Systems:

While setting your system's individual speaker volume levels is ultimately up to your personal taste, here are some ideas you may find helpful:

- For films and video-music programs, your overall goal should be to create an enveloping, realistic sound field that draws you into the film or music program without drawing your attention away from the action on the screen.
- For multichannel music recordings, some music producers will create a sound field that places the musicians all around you; others will create a sound field that places the musicians in front of you, with more subtle ambience in the surround speakers (as you would experience in a concert hall).
- In most 5.1-channel films, the surround channels are not intended to be as loud or as active as the front channels. Adjusting the surround speakers so they are always as loud as the front channels could make dialogue difficult to understand and will make some sound effects sound unrealistically loud.

Notes on Setting Subwoofer Volume:

- Sometimes the ideal subwoofer volume setting for music is too loud for films, while the ideal setting for films is too quiet for music. When setting the subwoofer volume, listen to both music and films with strong bass content and find a "middle ground" volume level that works for both.
- If your subwoofer always seems too loud or too quiet, you may want to place it in a different location. Placing the subwoofer in a corner will always tend to increase its bass output, while placing it away from any walls or corners will always tend to lessen its bass output.

IMPORTANT: Do not turn the receiver's volume up to or past the point where the audio from the speakers becomes distorted. Doing so can damage the speakers.

Surround-Sound Modes

Your BDS receiver can decode and play audio programs in these native audio formats:

- Dolby Digital
- Dolby Digital Plus
- Dolby TrueHD
- DTS Digital
- DTS-HD™ High Resolution Audio
- DTS-HD Master Audio™
- PCM
- MP3: 32kbps – 320kbps bitrates, including variable bitrate encoding

The audio formats available for any particular program depend on the program and on how you have configured your BDS receiver in the *Audio Settings* menu:

Available Audio Formats

	2.0- and 2.1-Channel Setup Configuration	3.1-Channel Setup Configuration	5.1-Channel Setup Configuration
2.1-Channel Programs	Dolby Virtual Speaker Wide (default)/Dolby Virtual Speaker Reference/Stereo	Dolby PLII Movie (default)/Dolby PLII Music/Dolby Virtual Speaker Wide/Dolby Virtual Speaker Reference/Stereo	Dolby PLII Movie (default)/Dolby PLII Music/Dolby Virtual Speaker Wide/Dolby Virtual Speaker Reference/Stereo
3.1-Channel Programs	Dolby Virtual Speaker Wide (default)/Dolby Virtual Speaker Reference/Stereo	Original (default)/Dolby Virtual Speaker Wide/Dolby Virtual Speaker Reference	Original (default)/Dolby PLII Movie/Dolby PLII Music/Dolby Virtual Speaker Wide/Dolby Virtual Speaker Reference/Stereo
4.1-/5.1-/6.1-Channel Programs	Dolby Virtual Speaker Wide (default)/Dolby Virtual Speaker Reference/Stereo	Dolby Virtual Speaker Wide (default)/Dolby Virtual Speaker Reference/Stereo	Original (default)/Dolby Virtual Speaker Wide/Dolby Virtual Speaker Reference

To switch between the available surround-sound modes for the program currently playing, press the Surround button. Each press of the Surround button will change to the next available mode in line. A pop-up display will appear on the TV, showing the modes as you cycle through them.

Listening Through Headphones

Your BDS receiver's headphone connection accepts a standard 1/8-inch (3.5mm) stereo headphone plug. When you insert the headphone plug into the connector, the receiver's speaker outputs will mute; the HDMI audio output will not mute.

When headphones are connected to the receiver's Headphone jack, pressing the remote's Surround button cycles between these two modes:

- **HARMAN** headphone, which virtualizes a multichannel surround soundtrack down to two channels. This mode retains the soundtrack's original directional cues, allowing you to enjoy an enveloping surround-sound experience on any ordinary pair of stereo headphones.
- **Headphone Bypass**, which downmixes surround-sound programs into normal stereo. This mode does not retain any multichannel directional cues that may be in the original surround-sound program.

Using the Disc Player

Disc Handling Precautions

- To keep the disc clean, handle the disc by its edge. Do not touch the surface.



- Do not stick paper or tape on the disc. If there is glue (or a similar substance) on the disc, remove the substance completely before using the disc.
- Do not expose the disc to direct sunlight or heat sources such as hot air ducts or leave it in a car parked in direct sunlight, as there can be a considerable rise in temperature inside the car.
- After playing, store the disc in its case.
- Do not write on the label side with a ball-point pen or other sharp writing utensils.
- Be careful not to drop or bend the disc.

Disc Cleaning Precautions

- Before playing, clean the disc with a cleaning cloth. Wipe the disc from the center out.
- Do not use solvents such as benzene, thinner, commercially available cleaners or anti-static spray intended for vinyl LPs.

Regional Coding

Your BDS receiver is designed to be compatible with region management information that is encoded on most Blu-ray Disc recordings and DVD recordings. If there is a region code on a disc other than the one your BDS receiver is designed for, it will not play in your BDS receiver.

See the sidebar box on page 2 for complete information about your receiver's region coding.

Copyright

Audio-visual material may consist of copyrighted works that must not be recorded without the permission of the owner of the copyright. Please refer to relevant laws covering copyright protection.

Copy Protection

Your BDS receiver is in compliance with HDCP (High-Definition Copy Protection), and a video display connected via the HDMI output must also be HDCP-compliant.

The BDS receiver supports Rovi copy protection. On Blu-ray Disc recordings and DVD discs that include a copy-protection code, if the contents of the disc are copied using a VCR, the copy-protection code prevents the videotape copy from playing normally.

Supported Disc Formats

The BDS receiver can play the following types of discs (5"/12cm, and 3"/8cm size):

- BD-Video (single-layer or double-layer)
- DVD-Video
- DVD+R/+RW
- DVD-R/-RW
- CDDA (CD digital audio)
- CD-R/RW

NOTE: The compatibility and performance of dual-layer discs is not guaranteed.

Supported Media Codecs

The BDS receiver can play media recorded in the following audio/video codecs:

- MPEG 1, Layer 1
- MPEG 2, Layer 2
- MPEG 2, Layer 3
- H.264
- VC-1
- MP3 (from CD-R/RW, DVD+R/+RW, BD-R/RE and USB)
- JPEG (from CD-R/RW, DVD+R/+RW, BD-R/RE and USB)
- DivX 3.x/4.x/5.x (from CD-R/RW, DVD+R/+RW and USB)

NOTE: Due to differences in the formats of certain discs, some discs may include a mix of features, some of which are not compatible with the disc player. Similarly, although Blu-ray Disc recordings and DVDs are capable of a wide range of features, not every disc includes every capability of its system. For example, although the BDS receiver is compatible with multi-angle discs, the multi-angle feature is possible only when the disc is specially encoded for multiple-angle play. To make certain that a specific feature or soundtrack option is available, please check the options noted on the disc jacket.

The playback capability of recordable discs may vary due to variations in the quality of the disc and the recorder used to create the disc.

Loading and Playing a Disc

Hold the disc horizontally when loading it, and insert it gently into the Disc slot. The disc loading mechanism will take the disc and slide it into the unit.

- Do not load more than one disc into the Disc slot.
- Do not load the disc upside down.

After loading a disc into the player, press the Play button to begin playback.

Use the Play, Pause, Stop, Prev/Step, Next/Step, Search Forward/Slow and Search Reverse/Slow buttons to control disc playback. See *Remote Control Functions*, on page 8, for more information about the functions of these buttons.

Playback Features

Repeat: When you are playing a Blu-ray Disc recording or DVD, pressing the Repeat button cycles through the following repeat modes: Chapter, Title, All, Off. When you are playing a CD, this button cycles through the following repeat modes: Track, All, Off.

A-B Repeat: When playing a Blu-ray Disc recording, or DVD, holding the Repeat button for more than three seconds places the player into the A-B repeat mode. The next short press of the Repeat button sets the "A" repeat point; the second short press sets the "B" repeat point and begins repeating the section of the disc between the two points. Pressing the Back button while the player is in the A-B repeat mode takes the player out of that mode. Note: This feature is disc-dependent. Not all Blu-ray Disc recordings support A-B repeat.

Options: Pressing the Options button displays any available options for the currently-playing disc. Blu-ray Disc options include title, chapter, time display, audio options, angle options, subtitle options, Find, Adjust Lip Sync, Advance and Replay. DVD options include title, chapter, time display, playback modes, audio options, angle options, Find, Adjust Lip Sync, Advance and Replay. Audio CD options include track selection, time display, playback modes, bitrate, instant search and instant replay.

Find option: Selecting the Find option during disc playback activates the search function, allowing you to jump to a specific location on the disc. You can find a location by title, chapter or time. See *Top Menu Button* (on page 23) for more information. NOTE: Not all discs allow searching by title. On these discs, use the disc menu to change titles.

Lip Sync option: This option lets you resynchronize the audio and video signals from a Blu-ray Disc recording or DVD to eliminate a "lip sync" problem. Lip-sync issues can occur when the video portion of a signal undergoes additional processing in the video display. Use the Left/Right Cursor buttons to delay the audio by up to 250ms until it is synchronized with the video. Press the Back button when you're finished. NOTE: This setting will be available only when a Blu-ray Disc or DVD has been inserted into the BDS receiver's disc drive.

Display button: When playing Blu-ray Disc recordings and DVDs, pressing the Display button toggles the information bar on and off.

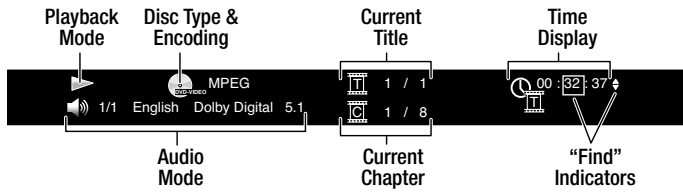

Top Menu button: Pressing this button displays the top menu for the Blu-ray Disc recording or DVD that is currently playing. NOTE: This feature is disc-dependent. Not all DVDs have top menus. If the DVD has no top menu, pressing the Top Menu button may display the disc menu, depending on how the disc's menu system was authored.

Pop-Up button: Pressing this button while playing a Blu-ray Disc recording displays the pop-up menu. (DVDs will display the disc menu.) Note: If the Blu-ray Disc recording does not support a pop-up menu, the disc menu will be displayed.

Bookmark function: The bookmark function lets you mark up to 12 locations on the disc currently playing. Press the Bookmark button to mark the current location on the disc. To clear a bookmarked location, press the Back button. To play the disc from one of your selected bookmark locations, hold the Bookmark button to display the bookmark list. Use the Navigation left/right buttons to select the desired bookmark, and press the OK button to play the disc from that location. NOTE: The bookmark function is disc-dependent. Not all discs allow bookmark operation.

Programmed play: This option lets you create a programmed playlist for a disc. The program function works for CDs, DVDs and some Blu-ray Disc recordings (not all Blu-ray Disc recordings allow programmed play).

1. Press the Program button. The Program screen will appear.

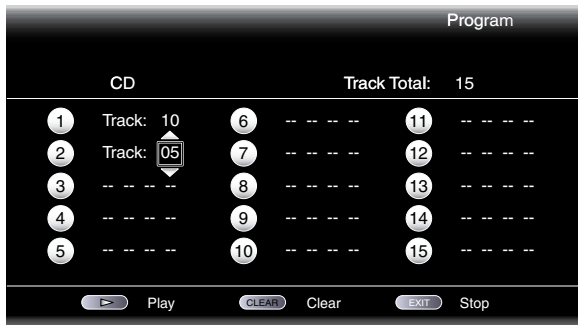

2. Press the OK button and use the Navigation Up/Down buttons to select the title on the disc (Blu-ray Disc/DVD) or track (CD) for your first program entry.
3. Press the right Navigation button and use the Navigation Up/Down buttons to select the chapter for your first program entry (Blu-ray Disc/DVD only).
4. Repeat Steps 2 – 3 for every entry in your programmed list.
5. When you're finished programming your list, press the Play button to play the list. Press the Next/Previous buttons to skip to the next or previous programmed item. NOTE: Pressing a number button during programmed play exits the programmed play mode and skips to the selected chapter or track.

The programmed list will remain active until the list has completed playing. Pressing the Stop button twice or ejecting the disc deletes the programmed list.

BD-Live Interactivity

BD-Live interactivity is available on select Blu-ray Disc recordings. When you select the BD-Live features from a disc's menu, you may be able to download additional content or other information via the Internet (through the Network connection).

If you have difficulty accessing the Internet while using a BD-Live disc, press the Settings button and navigate to the Network Setup menu. Select "Test Connection." If the BDS receiver is able to access the Internet, then the computer server the BD-Live disc is trying to access may be at fault. Check the disc jacket for more information or contact the content provider. If the "Test Connection" function fails, contact your Internet service provider (ISP) to obtain the correct settings for the BDS receiver's IP Configuration menu. If the problem persists, contact your ISP for further assistance.

Playing Music CDs

When the BDS receiver is playing a music CD, the top bar shows the current playback-mode icon, the type of disc, the track currently playing, the number of total tracks on the disc and the time display.



Playing Streaming Media via Your Home Network

Your BDS receiver lets you access media on other devices connected to your home network and enjoy media from on-line streaming services.

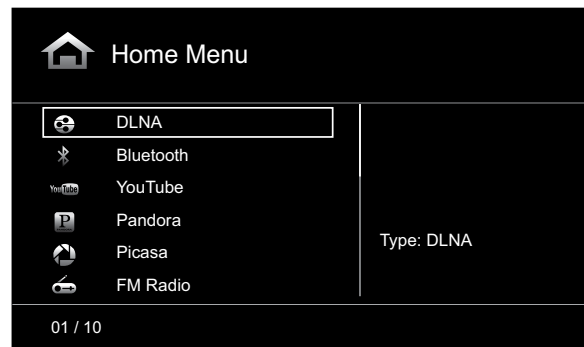

NOTE: The Pandora, Picasa and YouTube services are not available in all regions. Refer to the table below. If the service is not available in your region it will not appear on the OSD input list shown above. (Refer to the list on page 2 to find your Blu-ray/DVD region):

Blu-ray/DVD region

Service	A/1	A/2	A/3	A/4	B/2	B/4	C/5	C/6
Pandora	Yes	No	No	No	No	No	No	No
Picasa	Yes	Yes	Yes	Yes	Yes	Yes	Yes	No
YouTube	Yes	Yes	Yes	Yes	Yes	Yes	Yes	No

Digital Living Network Alliance (DLNA) is a file sharing protocol that creates a bridge between the BDS receiver and other devices on the same network that contain audio and video media. DLNA is supported by PCs that support Windows Media Player, Windows Media Center or Intel Media Server file sharing. Apple computers can also share files via DLNA using Harman Music Manager software, which can be downloaded without charge from www.harmanakardon.com. (Third-party software that enables DLNA file-sharing also is available.)

DLNA lets you watch a movie from your PC on your large-format TV via the BDS receiver, or play an MP3 or WMA audio file stored on your smart phone through the BDS system. You can also surf the Internet to enjoy material from a number of Cloud-based services.

Before you can access files located on other devices via DLNA, each device must first give permission to share files with the BDS receiver. To give file sharing permission on a PC with Windows Media Player:

1. Open Windows Media Player.
2. Open the Library menu and select Media Sharing. The Media Sharing window will appear.
3. Check the "Share My Media" box. An icon for the BDS receiver will appear in the window.
4. Select the BDS icon, select "Allow," then select "OK."

The computer's WMA and MP3 media should now be available to the BDS receiver. To share media on other types of computers, operating systems or media software, check the instructions for the computer, operating system or media player.

To determine which of your network devices allow DLNA media sharing, simply scroll through the BDS receiver's Home Menu and select DLNA; the various network devices will be listed below the main title. Simply click on a device and if it allows file sharing, its file structure will be displayed, allowing you to find the available media.

NOTE: Your BDS receiver is compatible with MP3 and WMA media; no other types of media can be played.

Bluetooth connectivity lets you stream audio wirelessly from a device that has been paired with the BDS receiver.

- After you have paired the BDS receiver with a *Bluetooth* device, you can select "Bluetooth" as the active source from the Home Menu.
- If at any time you begin playing media on a paired *Bluetooth* device the audio stream will automatically break in (the OSD will display a "Bluetooth activated" message) and interrupt the source that is currently playing through the BDS receiver.

With both of the above methods, the *Bluetooth* screen will appear on the OSD.



Use the remote's Transport Control buttons to control playback.

To terminate *Bluetooth* streaming and return to the previously playing source, press the remote's Stop button at any time while the *Bluetooth* screen is displayed.

Playing Media from YouTube. YouTube is an Internet-based service that lets you share videos with friends, family and the world.

Displaying Media from Picasa. Google's Picasa is a Cloud-based subscription service that lets you organize, edit and share your digital images via the Internet and view them on your TV. NOTE: Before you can view content from Picasa you first must set up an account with the service.

Playing Music from Pandora. Available only on BDS receivers sold in the United States, Pandora is a free, personalized Internet radio service that lets you access a wide cross section of musical styles and tastes. NOTE: Before you can stream audio from Pandora you first must set up an account with the service.

Listening to Your iPod/iPhone/iPad

Use your Apple cable (not supplied) to connect your iOS-compatible mobile device to the BDS receiver's front-panel USB port. The iPod icon will appear on the Home Menu. Highlight the "iPod" icon and press the OK button. The BDS receiver's on-screen display (OSD) will show iPod Now Playing screen.

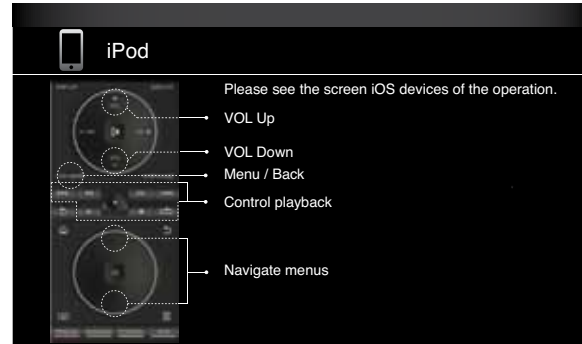

NOTE: The BDS receiver will not play video content stored on an iPod, iPhone or iPad.

In addition to playing content from an iOS-compatible device, buttons on the receiver's remote control will control a number of the iPod/iPhone/iPad functions, as shown on the Now Playing screen.

Pressing the Home button will switch the OSD to the Home screen while you continue to hear the iPod/iPhone/iPad content through your BDS receiver. Pressing the Repeat button will cycle the connected device between Repeat Song, Repeat All, Repeat Off.

Listening to FM Radio

Press the Radio button on the remote control or, if the Home screen is displayed on the OSD, highlight "Radio" and press the OK button. The Radio Now Playing screen will appear on the OSD and the BDS receiver's information display will show the currently tuned-in FM frequency; the bottom line of the display will show the RDS information for the currently tuned station (if available).

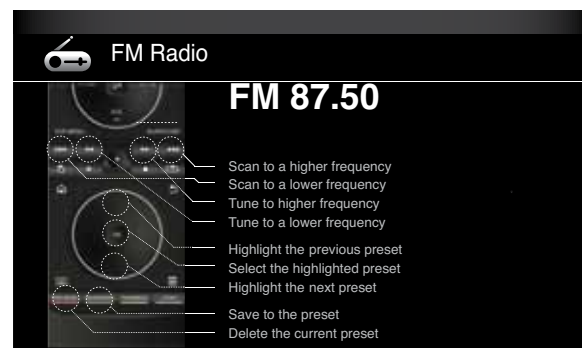

In addition to playing the radio through the receiver, pressing the Radio button places the remote in the radio-control mode, as shown on the Now Playing screen.

Pressing the Home button will switch the OSD to the Home screen while the radio continues to be heard through the BDS receiver. To display the Radio Now Playing screen again, press the Back button.

Listening to Audio Sources

Press the *Aux* button on the remote control. The receiver will switch to the audio input that was selected last. Subsequent presses of the Aux button will advance through the audio inputs in the following order: *Coax In*, *Optical In 1*, *Optical In 2*, *Aux In 1*, *Aux In 2* and *HDMI ARC* (Audio Return Channel). The Aux Input Now Playing screen will appear on the TV or flat-panel display.

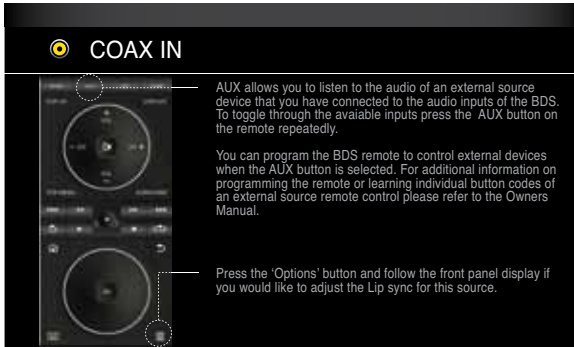

In addition to playing the Aux source through the receiver, pressing the Aux button places the remote in the Aux-control mode. If you programmed the remote to control an auxiliary component (either by entering in a code number or teaching commands to the remote), the remote will now operate according to that programming mode. (See *Programming the Remote Control*, on page 13.)

Lip sync delay: When playing an Aux source, audio and video processing circuitry may create a slight delay between the picture and sound. Pressing the Options button lets you adjust the audio delay to eliminate “lip sync” errors that may occur between the sound and picture in video programs with sound playing through one of the receiver’s rear-panel audio inputs. Use the Cursor Up/Down buttons to increase or decrease the audio delay until the perceived lip-sync errors disappear and the sound and picture are properly synchronized. The amount of audio delay is shown on the receiver’s front-panel Information display.

Listening to Media via AirPlay (BDS 277/BDS 577 only)

If you have connected a BDS 277 or BDS 577 receiver to a network router that has Wi-Fi® capability, you can wirelessly stream audio to it via AirPlay from compatible Apple devices with iOS 4.2 or newer that are joined on the same network, and from computers that have iTunes 10.1 or newer that are joined on the same network. See *Connect to Your Home Network*, on page 12 for information about connecting to your network, and *General Settings: Network*, on page 17 for information about joining your network.

To initiate AirPlay streaming to the BDS receiver:

- To initiate AirPlay streaming from a computer with iTunes, launch iTunes, click on the AirPlay button that appears at the bottom of the computer’s iTunes window, and select “HK BDS” in the pop-up list that appears.

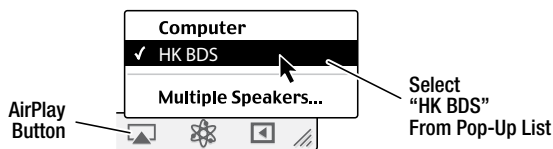

- To initiate AirPlay streaming from an iPod, iPhone or iPad device, tap the AirPlay button on the device’s screen and select “HK BDS” in the speaker-selection list that appears.

The AirPlay audio stream will break in (the OSD will display an “AirPlay activated” message) and interrupt the source that is currently playing through the BDS receiver. The AirPlay screen will appear on the OSD.

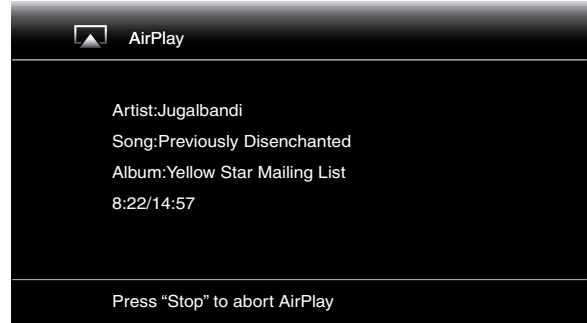

Use the remote’s Transport Control buttons to control playback.

To terminate AirPlay streaming and return to the previously playing source, press the remote’s Stop button at any time while the AirPlay screen is displayed.

Playing Files from USB Devices and Data Discs

Your BDS receiver can play MP3 (up to 320kbps bitrate) audio files, display JPEG photos and show MPEG 1 (layer 1), MPEG 2 (layers 2 and 3), and DivX home theater profile audio/video files stored on a USB device or a CD/DVD data disc.

IMPORTANT: Only media in the FAT32 file system are compatible with your BDS receiver.

To access files on a device inserted into the receiver’s USB port, press the Home button and select USB from the source list on the screen.

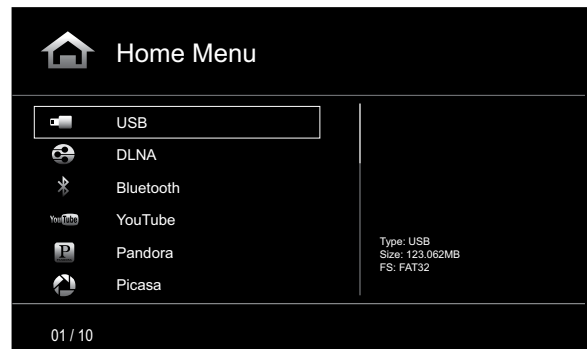

Regardless of the device’s file structure, the screen will first show three individual folders named “Photo,” “Music,” “Video” and “AVCHD (high-definition video files from AVCHD camcorders).” Select the type of media you want to play from these three folders.

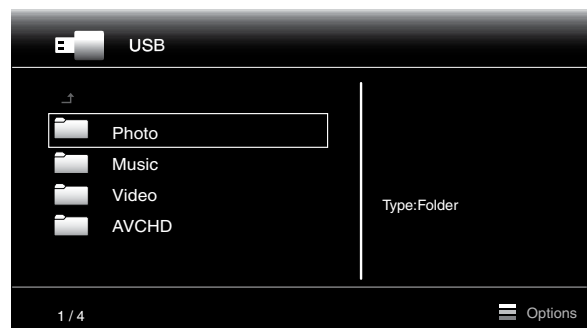

The screen will then show the device's file structure. Selecting a folder will show all files of the selected type of media in the folder. If there are files of the selected type in the device's root directory, they will also be shown.

To move up one directory level, press the Cursor Left button or select the arrow.

Viewing Photos

In the top directory, select "Photo." Select a folder containing photo files and highlight a photo file in the folder. A thumbnail of the highlighted photo will appear on the right of the screen.



Use these remote buttons while viewing photos:

Play button: Press this button to begin a slide show that displays the photos in the current folder or directory level (starting with the highlighted JPEG) for 15 seconds in the order they appear in the folder.

Pause button: Press this button to freeze the current photo on the screen. Press the Play button to resume the slide show.

Stop button: Press to end the slide show and return to the directory.

Next/Step and Previous/Step buttons: Press these buttons to skip to the next or previous photo file in the slide show or directory.

Cursor Up button: Pressing this button while a photo is displayed rotates the photo 180°. Pressing this button while the directory list is displayed highlights the previous item in the directory.

Cursor Down button: Pressing this button while a photo is displayed shows a mirror-image reflection of the photo. Pressing this button while the directory list is displayed highlights the next item in the directory.

Cursor Left button: Pressing this button while a photo is displayed rotates the photo 90° counterclockwise. Pressing this button while the directory list is displayed jumps to the next higher directory level.

Cursor Right button: Pressing this button while a photo is displayed rotates the photo 90° clockwise.

Options button: Pressing this button while a photo is displayed shows the Options menu, which gives you the following options:

- File: Select a file to view.
- Play Mode: View files in their normal order, in random order (until you press the Stop button) or in shuffle order (displays each image in the folder one time in random order, then returns to the directory).
- Slide Show: Select the amount of time you want each slide to be displayed: 5 seconds, 15 seconds or 30 seconds.
- Transition: Select from various types of image-to-image transitions.

Pressing the Options button when a directory is displayed shows the Playlist Options box. See *Using Playlists*, on page 27, for more information.

Thumbnail (Yellow) button: Pressing this button while playing a slide show displays thumbnail images of all photos in the slide show. Use the Cursor and OK buttons to highlight and select images to view.



Zoom (Blue) button: Pressing this button during a slide show freezes an image and zooms in 2x size. Additional presses of the button change the zoom to 3x, 4x, 1/2x, 1/3x and 1/4x size.

Playing Music Files

In the top directory, select "Music." Select a folder containing music files and highlight a music file in the folder. Information about the highlighted file will appear on the right of the screen.

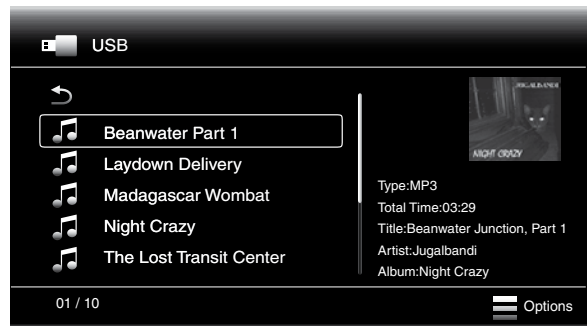

Selecting a music file plays the file. If there are other music files in the folder that follow the selected file, the receiver will play them in the order they appear on the on-screen display. The following screen will appear while music files play:

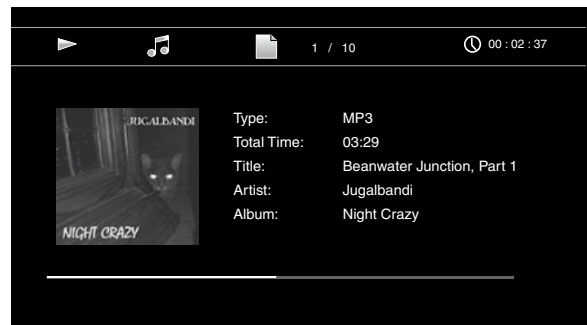

If a selected MP3 file has an album cover-art ID3 tag, the art will be displayed on the screen.

Use the remote's Transport Control buttons to control music-file playback. See *Remote Control Functions*, on page 8, for more information about the functions of these buttons.

When the BDS receiver is playing music files from a USB device or CD data disc, the Repeat and Options functions are slightly different from when they are playing Blu-ray Disc recordings, DVDs and music CDs:

Repeat button: Pressing this button cycles through the following repeat modes: 1 (song), All (folder), Off. The active repeat mode is indicated in the screen's top bar.

Options button: Pressing this button displays any available options for the song currently playing:

- File: Select a song to play.
- Time: Display the track's elapsed time or the track's time remaining.
- Play Mode: Plays songs in their normal order, in random order (until you press the Stop button) or in shuffle order (plays each song in the folder one time in random order, then returns to the directory).
- Bitrate: Shows the bitrate of the song currently playing.
- Advance: Performs a rapid, audible search forward through the song.
- Replay: Each press of the OK button jumps back ten seconds during play.
- Find: Lets you advance to a precise time in the track.

While playing music files from a USB device or data CD, you can also view photos that are on the same media. Press the Home button while the music file is playing, navigate to a folder containing photo files, and select a photo file to begin a slide show.

Playing Videos

In the top directory, select the folder labeled "Video," or the folder labeled "AVCHD." Select a folder containing video files and highlight a video file in the active folder.

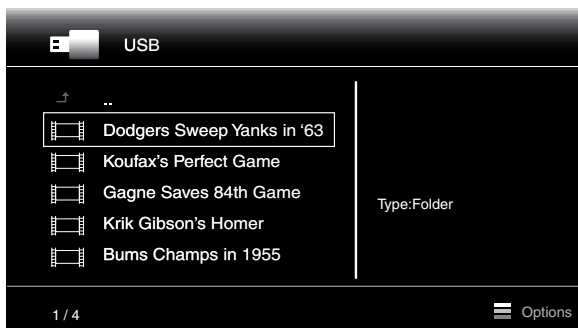

The video will automatically play. If there are other video files in the folder, the BDS receiver will play each one in the order they appear on the on-screen menu.

Use the remote's Transport Control buttons to control video file playback. See *Remote Control Functions*, on page 8, for more information about the functions of these buttons.

When the BDS receiver is playing video files from a USB device or CD data disc, the Repeat and Options functions are slightly different from playing Blu-ray Disc recordings and DVDs:

Repeat button: Pressing this button cycles through the following repeat modes: 1 (current video), All (folder), Off.

Options button: Pressing this button displays any available options for the video that is currently playing File, Title, Chapter, Time, Play Mode, Audio, Subtitle, Code Page, Bitrate, Advance, Replay, Adjust Lip Sync and Find.

Using Playlists

Because USB devices and CD data discs can contain large numbers of playable files, you can create a playlist for each that will make it easier for you to access selected files.

To Create a Playlist:

NOTE: The procedure is the same for a CD data disc playlist and a USB playlist.

1. Press the Home button. The Home menu will appear.
2. Select CD data disc or USB. The Photo, Music and Video folders will appear.
3. Select the type of file you want to create the playlist for. You can create a playlist for each type of file.
4. As you search through the directory structure, when you see a file you want to include in the playlist for that file type, highlight it and press the Options button. The playlist options box will appear.
5. To add the item to the playlist, select "Add to playlist."
6. Repeat Steps 4 – 5 for all items you want to add to the playlist.

To create a playlist for a different file type, repeat Steps 1 – 6, but in Step 3, select a different file type.

To Play a Playlist:

1. Press the Home button. The Home menu will appear.
2. Select Playlist. The Photo/Music/Video screen will appear.
3. Select the file type of the playlist you want to play. The playlist will open.
4. Select the first item in the playlist and press the Play button. The playlist will play.

To repeat the playlist, press the Repeat button. You can repeat one item ("1") or the entire playlist ("All").

Troubleshooting

If your BDS receiver isn't performing the way you think it should, check to see if the problem is covered in this section before calling your Harman Kardon dealer.

Problem	Solution
The receiver won't power up (the On/Standby indicator is not lit):	<ul style="list-style-type: none"> • Check that the receiver's Power cord is properly plugged into the receiver's AC Power connector. • Check that the Power cord is plugged into a working AC outlet. If the outlet is controlled by a switch, make sure the switch is set in the "On" position. • Check that the receiver's Main Power switch (located on the rear panel) is in the "On" position.
Sound plays through the speakers, but there is no TV picture:	<ul style="list-style-type: none"> • Check the HDMI connection between the receiver and the TV. • Check the HDMI connection or Component Video connection between the source device and the BDS receiver. • Check that the TV is turned on and is set to the proper input source. • Unplug the HDMI cable from the TV and plug it back in again.
There is a constant hum in the sound:	<ul style="list-style-type: none"> • Check that all input cables are plugged all the way into their connectors. • Check that all cables are at least 10 ft (3.3m) from fluorescent lights. • Check that all cable connectors are clean. If necessary, wipe them with a cloth slightly moistened with alcohol.
Streaming service (Pandora, Picasa or YouTube) does not appear on the Home Menu.	<ul style="list-style-type: none"> • See the table on page 23 to confirm that the streaming service is available in your region. If the service is not available it will not appear on the Home Menu.
Cannot connect to a streaming service that appears on the Home Menu	<ul style="list-style-type: none"> • Confirm that the BDS receiver is joined in your home network. See <i>General Settings: Network</i>, on page 17 for information about performing a connection test.
Cannot stream media from other networked devices via DLNA	<ul style="list-style-type: none"> • Make sure the networked devices have given permission to share media. See <i>Digital Living Network Alliance (DLNA)</i>, on page 23 for more information.
The disc does not play:	<ul style="list-style-type: none"> • Check that the disc is inserted correctly (label side up). • Check that the disc is the correct type: BD-Video (single-layer or double-layer), DVD-Video, DVD+R/+RW, DVD-R/-RW, CDDA (CD digital audio), CD-R/RW. Other disc types will not play. • Check that the disc surface is clean and not scratched.
There is noise or other interference in the picture while playing a Blu-ray Disc recording or DVD:	<ul style="list-style-type: none"> • Check that the disc surface is clean and not scratched.
The sound and picture are out of sync when playing to an Aux source:	<ul style="list-style-type: none"> • Press the Options button and perform the Lip Sync adjustment to bring the sound and picture into synchronization.
Cannot tune in radio stations:	<ul style="list-style-type: none"> • Check that the FM antenna is correctly connected. • Adjust the antenna's position. If necessary, use a powered FM antenna or an outdoor FM antenna.
The receiver does not respond to remote-control commands:	<ul style="list-style-type: none"> • Replace all three remote-control batteries with fresh ones, and make sure that they are installed with the correct polarity. • Hold the remote closer to the receiver. • Check that the receiver's remote sensor is in the line of sight of the remote control.
The remote does not control programmed components (TV or video):	<ul style="list-style-type: none"> • Check that you have pressed the remote's Aux button before trying to operate the component. • Re-program and/or re-teach the component's commands into the remote.
The ∅ symbol appears on the screen when you press a remote-control button:	<ul style="list-style-type: none"> • The selected function is not permitted at the time the button is pressed.
The receiver does not respond to commands, or it behaves in an erratic way:	<ul style="list-style-type: none"> • Unplug the receiver's Power cord from the AC outlet, wait 30 seconds, then plug it back in.

You can find additional troubleshooting information in the FAQs link on the Support page at www.harmankardon.com.

Aux Component Remote-Control Code List**TV/DVR**

Manufacturer	Code Numbers				
A MARK	0132	0122	1088	1105	
ACER	0143	1167			
ADMIRAL	0192	1105	1088	1023	
ADVENT	0151				
AIWA	0027	1110			
AKAI	0053	1093	1089	1056	1053
	1042	1022	1020	1011	
AKAL	0160	0123			
AKURA	1020				
ALBA	1040	1020			
AMPRO	0164				
ANAM	0122	0112	0109	0106	0045
ANSONIC	1049	1144	1145	1146	1147
	1148				
AOC	0128	0123	0122	0037	0146
	0150				
APEX	0154	2014	2016		
ARC EN CIEL	1059	1056	1024	1019	1017
ARCAM	1017				
ARISTONA	1086	1060	1048	1047	1033
	1025	1023	1022		
ASA	1201	1096	1088	1023	1012
AUDIOVOX	0012	0155			
AUTOVOX	1088	1044	1025		
BANG & OLUFSEN	1088				
BARCO	1202				
BASICLINE	1020				
BAUR	1102	1077	1076	1075	
BEKO	1022				
BENQ	0166	0170	1165		
BLAUPUNKT	0084	1077	1076	1075	1011
BLU:SENS	0174	0178	0185	1098	1109
	1112	1120	1138	1170	1175
BLUE SKY	1144	1148	1149	1150	1151
	1152	1153	1154	1155	1156
	1157	1158			
BRANDT ELECTRONIQUE	1059	1056	1024	1019	1017
BRION VEGA	1203	1088	1023		
BROCKSONIC	0206	0205	0072		

Manufacturer	Code Numbers				
BRUNS	1088	1023			
BUSH	1092	1043	1040	1020	1010
BUSH(UK)	1044				
CANDLE	0128	0123			
CAPEHART	0059				
CELLO	1178	1182			
CENTURION	0171	0123			
CENTURY	1088	1023			
CETRONIC	0045				
CGE	1105				
CIHAN	1032				
CITIZEN	0132	0128	0123	0045	
CLASSIC	0045				
COBY	0104				
COMTEL	1032				
CONCERTO	0128				
CONTEC	0045	1010			
CONTINENTAL EDISON	1059	1056	1024	1019	1017
CORANDO	0172				
CORONADO	0132				
CRAIG	0159	0158	0157	0045	
CROSLEY	1088	1023			
CROWN	0132	0045			
CURTIS MATHES	0128	0123	0132	0080	0082
CXC	0045				
DAEWO	0132	0128	0127	0119	0116
	0114	0111	0108	0106	0105
	0102	0087	0045	1022	
DANSAI	1022				
DAYTRON	0132	0128			
DECCA	1091	1032			
DECCA(UK)	1038				
DEGRAAF	1015				
DELL	0075				
DGM	1190				
DIBOSS	0186				
DIGI LINK	0200				

TV/DVR

Manufacturer	Code Numbers				
DIGIFUSION	1184				
DIGITREX	1192				
DISH NETWORK	0188	2012			
DIXI	1022				
DORIC	1029				
DUMONT	1201	1199	1096	1088	1023
DUMONT-FINLUX	1044	1012			
DYNASTY	0045				
DYNATECH	0063				
DYNATRON	1022	1020			
DYNEX	0014	0083	0107	0189	
ELBE	1211	1105	1095		
ELCIT	1032	1023			
ELECTROGRAPH	0064				
ELECTROHOME	0132	0115			
ELEMENT	0048	0113			
EMERSON	0205 0139 0126	0162 0132 1195	0159 0128 1088	0158 0123 1023	0157 0045
EMOTION	1189				
EPSON	0074				
ERRES	1033	1022			
FENNER	1022				
FERGUSON	1197 1075	1196 1062	1099 1047	1077 1024	1076 1001
FIDELITY	1047				
FIDELITY(UK)	1099				
FINHER	1204				
FINLANDIA	1018				
FINLUX	1201 1012	1199	1096	1088	1044
FIRST LINE	1157 1164	1159 1166	1160 1168	1161 1169	1163
FISHER	1088	1043	1023		
FORGESTONE	1099	1047			
FORMENTI	1088				
FORMENTI-PHOENIX	1088				
FUJITSU	1195	0041	0042	0249	0250
FUNAI	0045	0195	1195		
FUTURETECH	0045				

Manufacturer	Code Numbers				
GATEWAY	0198	0199			
GBC	1043				
GE	0163 0123	0159 0121	0145 0087	0133 0029	0128
GEC(UK)	1061				
GOODMANS	1043	1022	1010	1036	1041
GORENJE	1124 1034				
GRANADA	1104 1010	1033	1029	1022	1018
GRANADA(UK)	1043				
GRUNDIG	0193 1076	0203 1075	1200 1011	1096	1077
GVA	0131				
HAIER	0135	0213	1028		
HALL MARK	0128				
HANNSPREE	1185				
HANSEATIC	1043	1022	1020	1010	
HARMAN KARDON	0201				
HIFIVOX	1080 1017	1059	1056	1024	1019
HINARI	1195	1043	1020	1010	
HISENSE	0137	0140	0216		
HITACHI	0147 1206 1082 1059 1035 1012	0144 1101 1080 1058 1026 1010	0132 1094 1069 1056 1024	0128 1093 1066 1055 1018	0123 1085 1061 1043 1015
HP	0076	0218			
HUMAX 0217	1030				
HYPER	1206				
HYPERION	0073				
HYTEK	0016				
HYUNDAI	0220	0236			
IKASU	1212				
ILO 0009 0056					
INFINITY 0148					
INKEL 0120					
INNO HIT	1068				
INSIGNIA	0099	0107			
INTERFUNK	1104 1023	1088 1022	1056 1020	1033	1024

TV/DVR

Manufacturer	Code Numbers				
INTERVISION	1121 1115	1119 1114	1118 1113	1117 1111	1116
ISIS	1186				
ITT	1100	1092	1046	1040	
ITT-NOKIA	1100	1092	1058	1040	
JBL	0148				
JCPENNY	0145	0132	0128	0123	0115
JENSEN	0019				
JET POINT	1208				
JOHN LEWIS	1193				
JVC	0134 1053	0087 1047	0079 1043	1092 1010	1056
KARCHER	1068	1012			
KATHREIN	1124	1034			
KAWASHO	0173				
KEC	0045				
KENMARK	1183				
KENNEDY	1025				
KENWOOD	0204	0123			
KLEGG	0066				
KLH	0006				
KMC	0132				
KNEISSEL	1105				
KNOLLSYSTEMS	0224				
KOGAN	1180				
KONKA	0225				
KRIESLER	1060 1023	1048 1022	1047	1033	1025
KTV	0162	0132	0123	0045	
LEVEL	1191				
LG(GOLDSTAR)	0132 0002 2004	0128 0013	0122 0086	0110 1022	0101 1073
LINSAR	1187				
LLOYTRON	0173	0172			
LODGENET	0069				
LOEWE	0227	1027			
LOEWE OPTA	1088	1023	1022	1020	
LOGIK	0069	1099	1091	1047	1038
LUMA	1022				

Manufacturer	Code Numbers				
LUXMAN	0128				
LUXOR	1058				
LXI	0148	0145	0077		
M ELECTRONIC	1201				
MAGNADYNE	1088	1023			
MAGNASONIC	0015				
MAGNAVOX	0148 0030 2008	0145 0040 2009	0132 0088 2010	0128 0138 2011	0123 2007
MANESTH	1022				
MARANTZ	0148	0123	0115	1022	
MARELLI	1088				
MARK	1022				
MARKS & SPENCER	1182				
MATSUI	0148 1020	1091 1001	1043	1040	1038
MAXENT	0199				
MEDION	1031				
MEMOREX	0128	0069			
METZ	0084 1023	1088 1011	1077	1076	1075
MGA	0128	0123	0115		
MINERVA	0084 1075	1200 1011	1096	1077	1076
MINTEK	0065				
MISAKI	0195				
MITSUBISHI	0168 0115 1090 1077 1046 1029 1011	0167 0077 1089 1076 1043 1023 1010	0160 1124 1083 1075 1039 1022 1007	0128 1092 1082 1057 1038 1020	0123 1091 1079 1050 1034 1013
MOTOROLA	2005				
MTC	0176	0175			
MURPHY	1021				
NATIONAL	0182 0148	0181 1018	0180	0179	0177
NEC	0125 1043	0123 1010	0121	0115	0010
NECKERMANN	1102	1088	1078	1023	
NEON	1182				
NIKEI	0045				

TV/DVR

Manufacturer	Code Numbers				
NOBLEX	1204	1205			
NOKIA	1100	1092	1046	1040	
NORDMENDE	1094 1056 1009	1093 1053	1080 1024	1069 1019	1059 1017
OKI	1045	1049	1081	1087	1097
OLEVIA	0007				
ONKING	0045				
ONWA	0045				
OPTOMA	0229				
OPTONICA	0077				
ORION	0211 0230 1038	0210 1210	0209 1209	0208 1091	0207 1040
OTTO VERSAND	1207 1076 1010	1102 1075	1092 1043	1078 1022	1077 1020
PANASONIC	0169 1136 1131 1004	0148 1135 1130	0087 1134 1129	0061 1133 1128	1137 1132 1002
PATHE' MARCONI	1059	1056	1024	1019	1017
PHILCO	0148 0045	0132 1105	0128 1088	0123 1023	0115
PHILIPS	0148 0036 1108 1095 1071 1060 1033 1022 1177	0145 0035 1107 1088 1070 1054 1032 1020 1179	0132 0034 1104 1086 1068 1048 1027 1014 1181	0128 0033 1100 1084 1067 1047 1025 1008 1213	0123 0089 1099 1078 1061 1046 1023 1176
PIONEER	0128 1024	0123 1022	0024 1020	1069	1056
POLAROID	0003	0004	0005	0006	0043
PORTLAND	0132	0128	0231		
PROLINE	1209	1020			
PROSCAN	0133				
PROTECH	1022				
PROTON	0165 0008	0132	0128	0122	0059
QUASAR	0087	0032			
QUELLE	1200 1044 1011	1096 1038	1077 1022	1076 1020	1075 1012
RADIO SHACK	0197 0045	0196	0180	0132	0128

Manufacturer	Code Numbers				
RADIOLA	1078 1025	1060 1023	1048 1022	1047	1033
RADIOMARELLI	1088 1022	1083	1082	1029	1023
RBM(UK)	1044				
RCA	0163 0123 2012	0161 0115	0145 0089	0133 0188	0128 2001
REALISTIC	0196	0167	0045		
REDIFFUSION	1083	1082	1029		
REX	1198	1025	1022		
RFT	1127 1122	1126	1125	1124	1123
RTF	1023				
RUNCO	0153	0152	0044	0046	
SAA	0183				
SABA	1094 1059 1017	1093 1056 1009	1088 1024	1080 1023	1069 1019
SALORA	1058	1018			
SAMPO	0128	0123	0059		
SAMSUNG	0226 0022 1204	0145 0020 1068	0132 1226 1022	0128 1208 2003	0124 1205
SANYO	0054 1043	0026 1038	0091 1023	1092 1012	1091 1010
SBR	1086 1033	1084 1022	1061	1047	1046
SCEPTRE	0232				
SCHNEIDER	1196 1047	1086 1033	1078 1025	1060 1023	1048 1022
SCOTT	0132	0128	0045	1195	
SEARS	0145	0132	0128		
SELECO	0078 1022	1199	1198	1105	1025
SHARP	0132 1207	0128 1043	0077 1010	0062	0092
SHERWOOD	0067				
SIEMENS	0084 1011	1077 1010	1076	1075	1015
SIGNATURE	0069				
SINGER	1105	1088	1023		
SINUDYNE	1209	1210			
SOLE	0068	0233			

TV/DVR

Manufacturer	Code Numbers				
SONY	0212	0194	0136	0130	0117
	0031	0028	0060	0093	1106
	1103	1102	1091	1065	1064
	1062	1043	1038	1016	1010
	1006	1172	1173	1174	
SOUND WAVE	1020				
SOUNDESIGN	0128	0045			
SPECTRICON	0122				
SSS	0045				
STERN	1198	1025	1022		
SUNKAI	1210				
SUPERSCAN	0195				
SUPRATECH	1139	1140	1141	1142	1143
SYLVANIA	0148	0145	0128	0123	0025
	0057	0094	0098	0142	
SYMPHONIC	0184	0195			
TANDBERG	1080	1056	1023		
TANDY	0077				
TATUNG	0063	2018			
TCL	0234				
TEAC	0095	0244			
TECHNICS	0181				
TECHWOOD	0128				
TEKNIKA	0132	0128	0123	0115	0069
	0045	1195			
TELEFUNKEN	1069	1059	1056	1024	
TELERENT	0069				
TENSAI	1022				
TERA	0156				
THOMSON	0191	0190	1094	1093	1082
	1080	1074	1072	1069	1059
	1056	1053	1044	1040	1024
	1019	1017	1009	1005	1003
THORN	1099	1047			
THORN-FERGUSON	1196	1197	1201	1103	1102
	1099	1047	1024		
TIVO	0051	0052	1051	1052	2207
	2204				
TMK	0128				
TOSHIBA	0202	0129	0063	0058	0096
	0103	1105	1096	1092	1063
	1044	1043	1042	1037	1010
	1001	1162			

Manufacturer	Code Numbers				
TOTEVISION	0132				
TRISTAR	1099				
TRIUMPH	1199	1044			
TRUTECH	0055				
UHER	1044				
ULTRAVOX	1088	1023			
UNIVERSUM	1201	1102	1077	1076	1075
	1012				
VIDEO CONCEPTS	0160				
VIDEOCON	1188				
VIDIKRON	0235	0253			
VIDTECH	0128				
VIEWSONIC	0011	0038	0047	0254	0255
VIORE	0245	0237			
VISTRON	1194				
VISUAL INNOVATIONS	1183				
VITO	0070				
VIZIO	0001	0002	0049	0050	0246
VOXSON	1088	1023			
WARDS	0148	0132	0128	0069	
WATSON	1077	1076	1075		
WEGA	1088	1043	1010		
WEGA COLOR	1023				
WELTBlick	1022				
WESTINGHOUSE	0017	0018	0023	0060	0100
	1022				
WINBOOK	0071				
WINTERNITZ	1206				
YAMAHA	0128	0123	0238	0239	
YORK	0128				
YUPITERU	0045				
ZANUSSI	1198	1025	1022		
ZENITH	0090	0069	0240	2002	2006
	2019				
ZONDA	0122				

CABLE BOX

Manufacturer	Code Numbers				
ABC	3011	3001			
ALLEGRO	3111				
AMERICAST	3212				
AMINO	3015	4031			
ARCHER	3112				
BELCOR	3113				
BT CABLE	4007				
CABLE STAR	3113	3033			
CABLETIME	4016	4012	4011	4008	
CISCO	3016	3021	4032	4033	
CITIZEN	3111				
CLYDE CABLE VISION	4017				
COLOUR VOICE	3090	3085			
COMCAST	3007 4040	3040	3054	4014	4015
DECAST CANAL	4010				
DIGI LINK	3114				
EAGLE	3186				
EASTERN	3070	3066			
ELECTRICORD	3039				
EMERSON	3112				
FILMNET	4020	4018			
FOXTEL	4019				
FRANCE TELECOM	4021	4013			
GEC	4017				
GENERAL INSTRUMENT	3054	4040			
FOCUS	3116				
FOXTEL	3043				
G.I	3097	3096	3017	3011	3001
GC ELETRONICS	3113				
GEMINI	3060	3032			
GENERAL	3210				
GENERAL INSTRUMENT	3210	3054			
GOODMIND	3112				
HANLIN	3208 3099	3175 3056	3117	3101	3100
HITACHI	3188	3001			
JASCO	3111				

Manufacturer	Code Numbers				
JERROLD	3210 3073 4022	3188 3017 4001	3162 3011	3097 3002	3096 3001
LINSAY	3118				
MACOM	3191				
MAGNAVOX	3068	3019	3017		
MOTOROLA	3022 4035	3023 4036	3021 4038	3031	4034
MOVIE TIME	3039	3035			
NSC	3190	3035			
OAK	3220	3197			
PACE	3179				
PANASONIC	3214	3189	3177	3176	3053
PANTHER	3114				
PHILIPS	3090 4023	3085	3020	3019	3013
PIONEER	3216 3041	3215 3001	3209 4002	3171	3119
POPULAR MECHANIC	3116				
PRELUDE	3120				
PRIMESTAR	3162				
QUEST	3037	4041			
RADIOSHACK	3213	3112	3111		
RCA	3214	3053			
RECOTON	3116				
REGAL	3208	3101	3100	3099	3056
REMBRANT	3032				
SAGEM	4028				
SAMSUNG	3003 4002	3186	3072	4024	4003
SATBOX	4004				
SCIENTIFIC ATLANTA	3222 4026	3221 4025	3203 4006	3183 4005	3038 4039
SEAM	3121				
SIGNATURE	3188	3001			
SPRUCER	3189	3177	3081	3053	
STARCOM	3163	3011	3002		
STARGATE	3120				
TANDY	3024				
TELECAPATION	3028				
TELESERVICE	4011				
TEXSCAN	3036				

CABLE BOX

Manufacturer	Code Numbers				
TFC	3122				
TIMELESS	3123				
TIVO	3029	3030	4029	4030	
TOCOM	3205	3170			
TUDI	4027				
UNITED CABLE	3011	4001			
UNIVERSAL	3113	3042	3039	3034	3033
VIDEOWAY	3211	3124			
VIEWSTAR	3190 3019	3089	3086	3053	3025
VISIOPASS	4009				
WESTMINSTER CABLE	4007				
ZENITH	3219	3211	3125	3065	
ZENTEK	3116				

SATELLITE TUNERS

Manufacturer	Code Numbers				
AIWA	6141				
AKAI	6033				
ALBA	6111	6001			
ALPHASTAR	5172				
ALPHASTAR DBS	5150				
ALPHASTAR DSR	5142				
AMSTRAD	6132				
ANKARO	6121				
ASTRO	6183 6178	6182 6177	6181 6176	6180	6179
BARCOM	6121				
BIRDVIEW	5125				
BLAUPUNKT	6090	6038			
BUSH	6106	6048			
BUSH(UK)	6053				
CANAL	5078	6013			
CANAL DIGITAL	6013				
CANAL PLUS (CANAL+)	6013				
CHANNEL MASTER	5061	5025	5021	5020	
CHAPARRAL	5151	5016	5015		
CITOH	5060				

Manufacturer	Code Numbers				
DIRECTV	5009 6005	5010	5014	6002	6003
DISH NETWORK	5064				
DRAKE	5181	5113	5018	5017	5013
DX ANTENNA	5183	5079	5052	5031	
ECHOSTAR	5185 5153 5008 6025	5184 5152 5038 6028	5178 5097 5040	5177 5095 6047	5163 5064 6021
ELECTRO HOME	5092				
FERGUSON	6124 6063	6111 6053	6106 6052	6067 6048	6064 6045
FINLUX	6010	6009			
FOXTEL	5076	6016			
FTE	6080				
FUBA	6121	6047	6014		
FUJITSU	5034	5029	5024		
GOLDEN INTERSTAR	6020				
GOODMANS	6111				
GRUNDIG	5074 6015	6090	6067	6053	6038
HITACHI	5155	5004	6111	6106	
HOUSTON TRACKER	5163				
HUGHES	5189	5137	5005	5006	
HUMAX	5072	6007			
ITT	6067				
ITT-NOKIA	6067				
JANIEL	5066				
JERROLD	5184	5168	5154		
KATHREIN	5110	6090	6080	6033	6001
KCPI	5080	6037			
KOSMOS	6080				
KYOTO GMI ATLAN	6143				
LEGEND	5153				
LEMON	6174				
LOEWE	6175				
LORENZEN	6174	6165	6164	6163	6161
MACOM	5071	5070	5069	5065	5017
MAGNAVOX	5173	5161			
MARANTZ	6033				
MASPRO	6106	6053			

SATELLITE TUNERS

Manufacturer	Code Numbers				
MEMOREX	5153				
METZ	6090				
MINERVA	6090				
MITSUBISHI	5007	6090			
MOTOROLA	5012	5019			
MULTISTAR	6080				
NEC	6073	6046	6036	6030	
NETA P562	6140				
NEXTWAVE	5123				
NOKIA	6067				
NORSAT	5073	6046			
OPTIMUS	5166				
OTTO VERSAND	6090				
PACE	5187	5028	5043	5082	6124
	6067	6064	6063	6053	6048
	6017	6039			
PACE MSS SERIES	6067				
PANASONIC	5169	5066	5157	5053	6124
	6031				
PANSAT	5120				
PERSONAL CABLE	5118				
PHILIPS	5075	6124	6121	6053	6033
	6032	6019			
PICO	5107				
PREMIERE	5057	6008			
PRESIDENT	5104	5081			
PRIMESTAR	5175	5168	5154	5112	5002
QUADRAL	6173	6172	6171	6170	6169
	6168	6167	6166		
QUELLE	6090				
RADIOLA	6053				
RADIX	6047				
RCA	5190	5165	5139	5001	5158
	5058	5067	6035		
REALISTIC	5180	5049			
SAMSUNG	5142	5022	5026	5045	6132
	6127	6080	6034		
SAT	6127				
SATELLITE SERVICE	5088	5035			
SCIENTIFIC ATLANTA	5039	5056			

Manufacturer	Code Numbers				
SCHNEIDER	6053				
SIEMENS	6090	6038			
SKY	5043	5044	6006	6017	6018
SKY MASTER	6133				
SKYLAB	6121				
SONY	5105	5062	5041	6029	
STAR CHOICE DBS	5159				
STARCAST	5047				
SUPER GUIDE	5123	5027			
TECHNISAT	6047				
TEECOM	5109	5093	5091	5090	5033
	5030				
TELECOM	6041				
TELEFUNKEN	6083				
THORN-FERGUSON	6067	6064	6048	6063	6053
	6052	6045	6023		
TOPFIELD	5063	6011			
TOSHIBA	5023	5162	5161	5160	5126
		5180	5179	5166	5103
		5083	5081	5055	5054
		5050	5049	5048	5032
VIASAT	5077	6012			
VORTEC	6142	6132			
WISI	6127	6047	6026	6027	6022
	6004				
ZEHNDER	6127	6080			
ZENITH	5188	5119	5094	5087	5085
	5084	5059	6044		

Specifications

BDS 577, BDS 575, BDS 277 and BDS 275 Receivers

Audio Section

Continuous average power, stereo model:	65 watts per channel, 20Hz – 20kHz, @ <1.0% THD, both channels driven into 6 ohms
Multichannel power (BDS 575/BDS 577 only):	65 watts per channel, 20Hz – 20kHz, @ <1.0% THD, into 6 ohms
Input sensitivity/impedance (line inputs):	250mV/46k ohms
Signal-to-noise ratio (IHF-A):	-90dB
Frequency response @ 1W (± 0.5 dB):	20Hz – 20kHz

FM Tuner Section

Frequency range:	87.5MHz – 108.0MHz (US and EU)
Usable sensitivity IHF:	>14dBf
Signal-to-noise ratio (mono/stereo):	-60dB/-55dB
Distortion (mono/stereo):	0.3%/0.5%
Stereo separation:	-45dB @ 1kHz
Image rejection:	-70dB
IF rejection:	-80dB

Disc Player Section

Supported disc formats:	5-inch (12cm) or 3-inch (8cm) BD-Video (single-layer or double-layer), DVD-Video, DVD+R/+RW, DVD-R/-RW, CDDA (CD digital audio), CD-R/RW discs
Region code (BD/DVD): Area where sold:	
USA, Canada:	A/1
Europe, Middle East:	B/2
Korea, S. E. Asia:	A/3
Mexico, Latin America:	A/4
Australia, New Zealand:	B/4
Russia, India:	C/5
China:	C/6
Audio formats:	Dolby Digital, Dolby Digital Plus, Dolby TrueHD, DTS Digital, DTS-HD High Resolution Audio, DTS-HD Master Audio, PCM, MP3: 32kbps – 320kbps bitrates, including variable-bitrate encoding
Still-image formats:	JPEG, GIF and PNG
Video signal system:	NTSC (USA) or PAL (EU)
Frequency response:	20Hz – 20kHz ± 0.5 dB
Signal-to-noise ratio:	-90dB (A-weighted)
Dynamic range:	90dB (16-bit)
THD @ 1kHz (DVD/CD):	0.1%
Wow & flutter:	Below measurable limits

Video Section

Television format:	NTSC or PAL (selectable)
HDMI version:	with 3D and 30/36-bit Deep Color

General

Power requirement:	110 – 240V AC, 50/60Hz
Power consumption:	120W maximum (BDS 575/BDS 577), 90W maximum (BDS 275/BDS 277); <1W standby
Dimensions (H x W x D):	3-1/8" x 15-3/4" x 11-1/4" (400mm x 80mm x 285mm)
Weight:	BDS 275 – 7.7 lb (3.5kg); BDS 277/BDS 575/BDS 577 – 7.9 lb (3.6kg)

Depth measurement does not include terminal connections. Height measurement includes feet and chassis.



HARMAN

HARMAN International Industries, Incorporated
8500 Balboa Boulevard, Northridge, CA 91329 USA
516.255.4545 (USA only)

Made in P.R.C.

© 2012 HARMAN International Industries, Incorporated. All rights reserved.

Harman Kardon is a trademark of HARMAN International Industries, Incorporated, registered in the United States and/or other countries. EzSet/EQ is a trademark of HARMAN International Industries, Incorporated. Blu-ray Disc and BD-Live are trademarks of the Blu-ray Disc Association. The *Bluetooth* word mark and logo are registered trademarks and are owned by the *Bluetooth* SIG, Inc., and any use of such marks by HARMAN International Industries, Incorporated, is under license. DIVX: ABOUT DIVX VIDEO: DivX® is a digital video format created by DivX, LLC, a subsidiary of Rovi Corporation. This is an official DivX Certified® device that plays DivX video. Visit divx.com for more information and software tools to convert your files into DivX video. ABOUT DIVX® VIDEO-ON-DEMAND: This DivX Certified® device must be registered in order to play purchased DivX Video-on-Demand (VOD) movies. To obtain your registration code, locate the DivX VOD section in your device setup menu. Go to vod.divx.com for more information on how to complete your registration. DivX®, DivX Certified® and associated logos are trademarks of Rovi Corporation or its subsidiaries and are used under license. DivX Certified® to play DivX® video up to HD 1080p, including premium content. DLNA®, the DLNA Logo and DLNA CERTIFIED® are trademarks, service marks, or certification marks of the Digital Living Network Alliance. DOLBY DIGITAL PLUS TRUE-HD. Manufactured under license from Dolby Laboratories. Dolby and the double-D symbol are registered trademarks of Dolby Laboratories. DTS DIGITAL SURROUND. Manufactured under license under U.S. Patent # s: 5,956,674; 5,974,380; 6,487,535 & other U.S. and worldwide patents issued & pending. DTS, the Symbol and DTS and the Symbol together are registered trademarks, and DTS Digital Surround and the DTS logos are trademarks, of DTS, Inc. Product includes software. © DTS, Inc. All Rights Reserved. HDMI, the HDMI logo, and High-Definition Multimedia Interface are registered trademarks of HDMI Licensing LLC in the United States and other countries. iPhone, iPod and iPad are trademarks of Apple Inc., registered in the U.S. and other countries. iPod, iPhone and

iPad not included. "Made for iPod," "Made for iPhone," and "Made for iPad" mean that an electronic accessory has been designed to connect specifically to iPod, iPhone, or iPad, respectively, and has been certified by the developer to meet Apple performance standards. Apple is not responsible for the operation of this device or its compliance with safety and regulatory standards. Please note that the use of this accessory with iPod, iPhone, or iPad may affect wireless performance. Java, Java Powered and the Java Steaming Coffee Cup logo are trademarks or registered trademarks of Sun Microsystems, Inc., or its subsidiaries in the United States and other countries. Microsoft, Windows and Windows Media are registered trademarks of Microsoft Corporation in the United States and/or other countries.

Pandora is a registered trademark of Pandora Media, Inc.

Picasa is a trademark of Google, Inc.

WMA (Windows Media Audio) is a proprietary file format developed by Microsoft. This item incorporates copy-protection technology that is protected by U.S. patents and other intellectual-property rights of Rovi Corporation. Reverse engineering and disassembly are prohibited.

YouTube is a trademark of Google, Inc.

Part No. HKP4816, Rev. A

harman/kardon
by HARMAN

www.harmankardon.com