

Panasonic®

Operating Instructions & Installation Instructions

Washing Machine
(Domestic use)

Model No.

NA - 148VB6

NA - 128VB6

NA - 147VB6

NA - 127VB6

NA - 147VC6

NA - 127VC6



Read Before Using	02
SAFETY PRECAUTIONS	04
Washing Instructions	18
Optional Functions	28
Maintenance	29
Troubleshooting	33
Installation Instructions	37

Thank you for purchasing this appliance.

- For optimum performance and safety, please read these instructions carefully.
- Before connecting, operating or adjusting this appliance, please read the instructions completely. Please keep this manual for future reference.

ENGLISH

Consider the Environment

Disposing of packaging

The packaging used to protect the washing machine from damage during transportation is all recyclable. For information on recycling, contact your local authority.

Disposal of Old Equipment Only for European Union and countries with recycling systems



This symbol on the products, packaging, and/or accompanying documents means that used electrical and electronic products must not be mixed with general household waste.

For proper treatment, recovery and recycling of old products, please take them to applicable collection points in accordance with your national legislation.

By disposing of them correctly, you will help to save valuable resources and prevent any potential negative effects on human health and the environment. For more information about collection and recycling, please contact your local municipality.

Penalties may be applicable for incorrect disposal of this waste, in accordance with national legislation.

Information on disposal in other countries outside the European Union

This symbol is only valid in the European Union.

If you wish to discard this product, please contact your local authorities or dealer and ask for the correct method of disposal.

Recommended detergent in accordance with the Regulation (EU) No. 1015/2010

Select the appropriate detergent for better results.

- **Standard detergent** for heat-resistant white laundry (Cold - 90 °C)
Programme; "Cotton", "Quick", or "Allergy-care"
- **Detergent for colours without bleach or optical brighteners** for coloured laundry (Cold - 40 °C)
Programme; "Colours", or "Mixed"
- **Detergent for Delicates without optical brighteners** for delicate, fine fabric (Cold - 40 °C)
Programme; "Hand Wash"
- **Detergent for woollens** fabrics (Cold - 40 °C)
Programme; "Wool"
- The available temperature range differs depending on the programme. (P.25)

When using a tumble dryer

To save energy, please select the correct spin speed according to the instruction of your tumble dryer.

This product complies with the directives 2006/95/EC and 2004/108/EC.

Contents

Read Before Using

Consider the Environment	2
SAFETY PRECAUTIONS	4
Checking Your Washing Machine	11
Your washing machine	11
Accessories	11
Before Washing	12
Checking before use	12
Before initial use	12
Preparing the laundry	12
Adding Detergent and Other	
Chemicals	13
Detergent compartment	13
Softener compartment	15
Prewashing compartment	15
Using the Buttons and Dials	16
Buttons and dial	16
Display	17
Unlocking the door	17

Washing Instructions

Washing	18
Setting washing	18
Required time	19
Setting the buzzer	19
Changing settings while washing	19
Selecting the Programme	20
Power and Water Consumption	21
Details of Programmes	24
Washing Delicates	26
Wool and Hand Wash programmes	26
Delicate laundry loads	26
Tips for washing delicates	26
Washing Blankets and	
Bedspreads	27
Programme for Bedding	27
Putting bedding into the drum	27
Optional Functions	28
Extra Rinse	28
Speed/Eco	28
Child lock	28
Preset timer	28
Easy Iron	28

Maintenance

Maintenance	29
Cleaning the outside of the	
appliance	29
Cleaning the door seal and window	29
Cleaning the drain filter	29
Cleaning the drum	30
Cleaning the detergent drawer	30
Cleaning the water supply filter	31
Preventing a frozen water supply	
hose	32

Troubleshooting

Fault Checklist	33
Error Display	36

Installation Instructions

Choosing the Right Location	37
Carrying the appliance	37
The right place for the appliance	37
Set-in installation	37
Moving and Installing	38
Removing the anchor bolts	38
Moving the appliance	38
Levelling the appliance	39
Connecting Hoses and Power	
Supply	40
Hoses and cable lengths	40
Water supply hose	40
Water drain hose	41
Connecting to the power supply	42
Checking after Installation	43
Installation checklist	43
Specifications	44
Product fiche	45

SAFETY PRECAUTIONS

Read and follow these safety precautions.

WARNING

This describes issues which could cause death or serious injury.

General Use

- This appliance can be used by children aged 8 years and above and persons with reduced physical, sensory or mental capabilities or lack of experience and knowledge if they have been given supervision or instruction concerning use of the appliance in a safe way and understand the hazards involved.
Children shall not play with the appliance.
Cleaning and user maintenance shall not be done by children without supervision.
- Children of less than 3 years should be kept away unless continuously supervised.
- Do NOT place a stand or a chair close to the appliance.
Children may be able to reach the control panel or climb onto or into the appliance.

SAFETY PRECAUTIONS

- Turn off the water supply to the appliance if it is not going to be used for a prolonged period, such as during a holiday. This is especially important if there is no drainage around the appliance.
If the water supply is left on, the water pressure may increase and result in a leak.
- Do NOT install the appliance in a damp location or in a location exposed to the weather. This may result in product malfunction or deterioration, electric shock or fire.
- Do NOT spill water directly onto any part of the appliance. This may result in malfunction, electric shock, or fire.
- Keep sources of ignition, such as candles or cigarettes, away from the appliance. They may cause a fire or damage to the appliance.
- Keep flammable materials away from the appliance, for example, gasoline, thinner, alcohol, or clothing soaked with these materials. They may cause an explosion or a fire.

SAFETY PRECAUTIONS

WARNING

Power source and cable

- Unplug the mains lead when cleaning the appliance.
- Check the mains lead and mains plug for damage.
If the mains lead is damaged, it must be replaced by the manufacturer, its service agent or similarly qualified persons to avoid a hazard.
- Do NOT use a mains plug adaptor or extension cable. There is a possibility of overheating which may cause a fire. Use an unused household mains socket, fully rated at AC 220 V to 240 V. If you are not sure, contact a qualified electrician.
- ENSURE the mains plug is fully inserted into the household mains socket. Otherwise, a loose connection may overheat and cause an electric shock or fire.
- Do NOT touch the mains lead or mains plug with wet hands.
Doing so may cause an electric shock.

SAFETY PRECAUTIONS

- Do NOT pull the mains lead but hold the mains plug to unplug the appliance. Otherwise, the mains lead may be damaged, which may lead to an electric shock or fire.

To Prevent Injury

- The appliance should be installed by the manufacturer's dealer or service agent. If the installation, test run and inspection are not carried out following the installation method outlined in these instructions, the manufacturer will not be liable for any accident or damage caused.
- Do NOT dismantle, repair or modify the appliance. The appliance may malfunction, which may result in a fire or an injury. If repairs are needed, contact your local Customer Service Centre.
- Do NOT touch the laundry inside the drum until it has completely stopped, as there is a possibility of injury. Keep children away from the rotating drum.

Read Before Using - 7

SAFETY PRECAUTIONS

CAUTION

This describes issues which could cause injury or damage your belongings.

General Use

- Prior to use, turn on the tap and check the hose and connections for any leaks. Improper connection could cause leaks.
- The new hose-sets supplied with the appliance are to be used and that old hose-sets should not be reused.
- This appliance is only suitable for textiles labelled washing machine washable.
- Do NOT connect to the hot water supply. This appliance works ONLY with cold water.
- Do NOT apply pesticide, hair spray or deodorant to the appliance.

SAFETY PRECAUTIONS

- Do NOT put any electrical equipment, for example, TV, radio or battery charger, on or near the appliance.
- Do NOT put excessive laundry or detergent into the appliance.
This may cause damage to the appliance.
- REMOVE the anchor bolts using a spanner or a similar tool before installing the appliance. The anchor bolts are used to transport the appliance.
If the anchor bolts are not removed, the appliance will vibrate severely during use.

To Prevent Injury

- Do NOT climb onto the appliance.
This may cause injury or damage to the appliance.
- Keep fingers away from the door hinge when opening and closing the door.
- Do NOT slide your hand (or unprotected foot) underneath the appliance when in use.
- When washing at high temperature, be careful not to burn yourself. Drain hose, drum, door glass, and laundry will be hot.

SAFETY PRECAUTIONS

CAUTION

- Check all of the laundry and remove all objects such as nails, pins, coins, clips, metal wires, etc.
They may cause damage to the laundry or the appliance.
- Do NOT use the appliance to wash waterproof sheets or clothing. There is a possibility of excessive vibration or failure during the spin cycle, which may result in an injury, damage to the appliance or a water leak.
- BE CAREFUL when draining hot water out of the drum.
- BE CAREFUL not to get laundry caught in the door seal when the door is closed. This may result in a water leak or damage to the laundry during the wash cycle.

Checking Your Washing Machine

Your washing machine

Detergent drawer
(P.13)

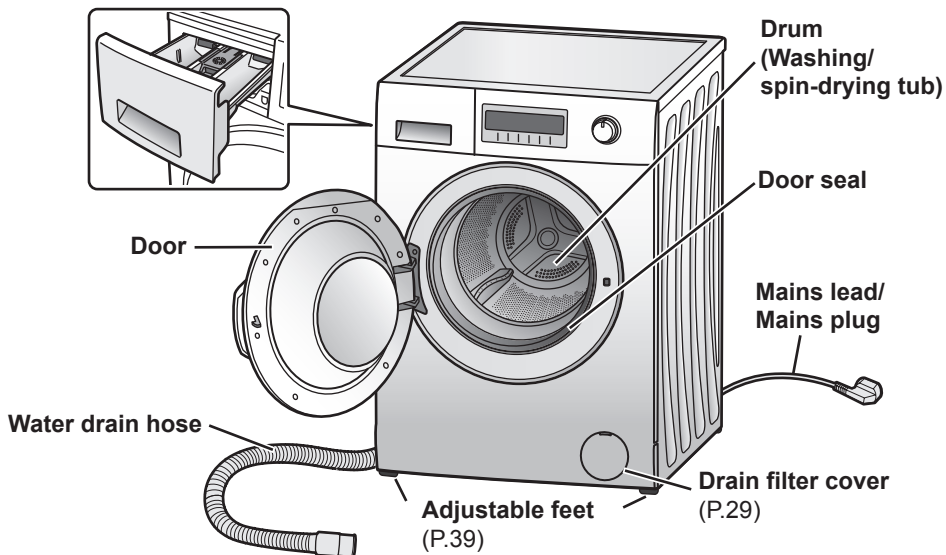

Caution

Do NOT bend the mains lead when the appliance is running.

Accessories

Make sure that all the accessories are supplied with the appliance.

Elbow (P.41)

For fixing the water drain hose



Liquid detergent level plate (P.14)



Cover cap (x4) (P.38-39)



Water supply hose (P.40)

Either one of these hoses is supplied with the appliance.

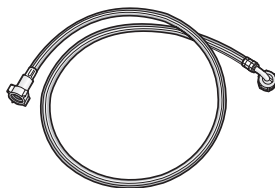

Standard
Hose

Hose with
water supply valve

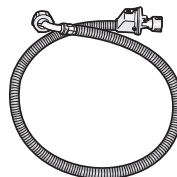

Read Before Using - 11

Before Washing

Checking before use

For the appliance's initial operation or after a prolonged period of non-operation, perform the following procedures:

1. **Secure the water supply hose.**
2. **Turn on the tap.**
3. **Connect the power supply.**
4. **Make sure that the water drain hose is positioned towards a drain.**

For more details, see page 41.

Before initial use

Before using the appliance for the first time, run the 40 °C Cotton programme WITHOUT any detergent or clothing to rinse out residue or moisture.

Note

There may be residual water in the appliance due to the factory inspection prior to shipment. This is not a malfunction.

Preparing the laundry

Sorting the laundry

- Read clothing care labels to sort the laundry into different loads.
- Sort the laundry by colour, type of fabric and how soiled it is. Doing so will help you choose the correct programme and temperature for each wash.
- Clothes that are not colour fast should be washed separately. Wash denim separately.



- You should put bras with metal wires, tights, lace clothing and small items into a laundry net to prevent them or the appliance from being damaged.

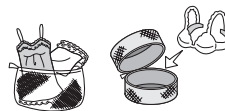

Caution

Do NOT wash water-repellent clothing.

There is a possibility of excessive vibration or failure during the spin-drying cycle that may result in an injury, damage to the appliance or a water leak.

Treating stains

Apply stain remover to stained portions. For dirt and solid stains, wash lightly by hand first.

Checking clothing

- Check that the pockets on clothing do not contain any objects that may damage the clothes or the appliance.

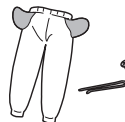

- Tie up any loose strings on the clothing and close zippers. Turn clothing with raised fabrics and zippers inside out. Otherwise, the clothes may be damaged.

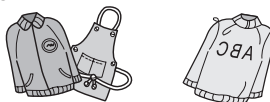

- Remove any hair, animal fur, sand and other materials with a brush before washing.



Note

Do not wash clothes heavily stained with large quantities of vegetable oil or cosmetic oil (aroma oil, etc.). Failure to observe this may result in the door seal swelling, causing the water to overflow and leading to malfunctions.

12 - Read Before Using

Adding Detergent and Other Chemicals

Pull out the detergent drawer and add detergent or softener to the correct compartment. Check the packages for the recommended amounts.

Caution

Do NOT use the appliance when the detergent drawer is removed.

This may result in a water leak.

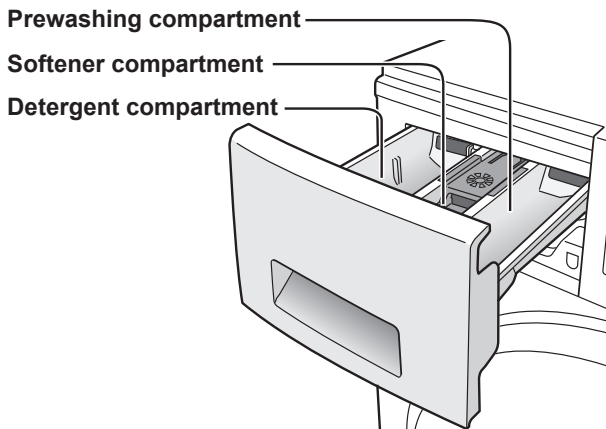

Detergent compartment

The following detergents and additives may be added to this compartment:

- Detergent
- Water softening agent
- Stain remover
- Tub cleaning detergent or bleach

If you use multiple chemicals in this compartment for washing, add them in the following order:

1. Detergent
2. Water softening agent
3. Stain remover

Detergent

Use only detergents that are recommended for fully-automated washing machines. Please use low suds detergents.

When you use a detergent specifically for slightly lower temperature than 20 °C (as low as 15 °C), the 20 °C Wash programme is recommended.

Caution

If the instructions on the package indicate that detergent should be placed in the drum, do NOT put it into the detergent drawer.

These detergents may not flow well and remain in the detergent drawer. Do not overfill with detergent. Failure to observe this may result in the detergent blocking the water supply, causing the water to overflow from the front of the detergent drawer and leading to malfunctions.

Adding Detergent and Other Chemicals

1. Liquid detergent

Note

- Do NOT use liquid detergent with the Prewash function. It may flow away during the prewash.
- Add liquid detergent before you start washing.

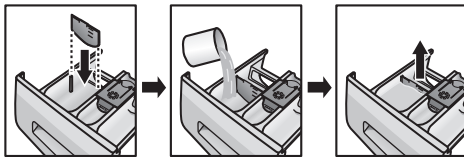

Fit the liquid detergent level plate (included with the accessories) into the detergent compartment and use it as a mark to set the amount of liquid detergent. Make sure to detach the plate before running the programme.

Note

Leaving the liquid detergent level plate in the detergent drawer while the programme is running may result in water leakage, or diminished washing and spinning performance.

For the Wool programme, use mild liquid detergent.

2. Powdered detergent

Detergent reaches the drum only when water flushes through the detergent drawer. Thus, if you have forgotten to add detergent, run the Drain programme. Then, add detergent and start washing again.

To prevent powdered detergent from remaining in the drawer, perform the following:

- Dry the inside of the drawer with a cloth.
- Make sure that the detergent is not lumpy when you add it because this may cause a blockage over time.

14 - Read Before Using

Amount of Detergent

The amount of detergent you should use depends on the following factors:

- How soiled the laundry is
- Amount of the laundry
- Water hardness

The amount of foam varies according to the amount and type of detergent, how soiled the laundry is, and the hardness and temperature of the water.

Water softening agent

If you live in a hard water area, we recommend using a water softening agent. For more details on water hardness, contact your local water authority.

Use of a water softening agent can help reduce the amount of detergent required for each wash and help prevent the formation of limescale deposits, which may damage the appliance.

Adding Detergent and Other Chemicals

Softener compartment

The following additives may be added to this compartment:

- Fabric softener
- Laundry starch

Fabric Softener

To prevent static, add softener before you start washing. It will be automatically added in the final rinse cycle.

Dilute concentrated softeners before you add them. Add up to only 125 ml to the compartment to avoid overflowing.

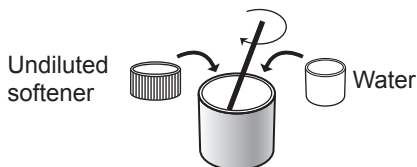

Rinse out the remaining softener with a splash of water or a damp cloth after washing. If it sticks to the compartment, pull out the drawer and clean it out. (P.30-31)

Note

Follow the directions on the softener packages for the appropriate amounts. If too much softener is added, it may remain in the detergent drawer.

Laundry starch

Simply add laundry starch to the softener compartment. It will be automatically added to the clothing in the final rinsing process. Make sure that you do not fill the compartment over the MAX level.

If it is hard to pour, dilute the starch slightly with water before adding it.

Note

After using starch, clean the detergent drawer, particularly the softener cover (P.30-31).

Then, run the Rapid 15 programme WITHOUT detergent to remove any excess starch in the drum.

Prewashing compartment

Detergent for prewashing

Whenever you use the Cotton (Prewash) programme (☁+⏴) always put detergent for the prewash in this compartment.

Using the Buttons and Dials

Model NA-148VB6

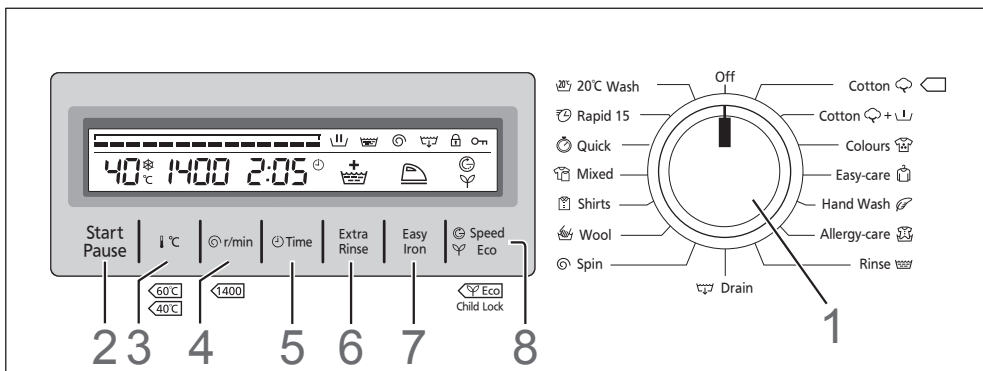

Buttons and dial

1. Programme selection dial

Use this dial to choose the best programme for the laundry. (P.20)

2. Start/Pause button

Press this button to start or pause the wash programme.

3. Temperature button

Press this button to choose water temperatures ranging from cold to 90 °C. (90 °C is available only with the Cotton and the Cotton (Prewash) programmes.) You can choose hotter temperatures for whites, cottons, or soiled laundry.

4. Spin speed button

Press this button to choose the spin speed for the programme you have selected.

The maximum spin speed of models are as follows.

- 148VB6, 147VB6 and 147VC6:
1400 r/min
- 128VB6, 127VB6 and 127VC6:
1200 r/min

5. Time button

Press this button to preset the time for when the programme starts. (P.28)

6. Extra Rinse

Press this button to select the Extra Rinse function. (P.28)

7. Easy Iron button

Press this button to select the Easy Iron function. (P.28)

8. Speed/Eco and Child Lock button

- Press this button to select the Speed/Eco function. (P.28)
- Press and hold this button for 5 seconds to set the child lock. The controls will be locked. Perform the same operation to release the child lock. (P.28)

Using the Buttons and Dials

Display



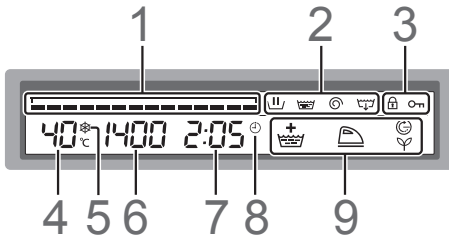

Model NA-148VB6





1. Time bar indicator

The number of displayed bars increases with time.

2. Process indicator

- This indicator shows the current process of the programme. The process consists of wash , rinse , and spin .
-  is displayed only when in the Drain programme.
- The light turns off when the programme is finished.

3. Lock indicator

-  is displayed if the door is locked.
-  is displayed if the child lock is activated. (P.28)

4. Temperature indicator

5. Cold setting indicator

This indicator is displayed when you turn on the Cold setting.

6. Spin speed indicator





7. Remaining time indicator

This indicator shows the approximate time until the programme finishes. For example, '2:05' means 2 hours and 5 minutes.

8. Time indicator

This indicator is displayed if the time for when the programme is to start has been preset.

9. Optional functions indicator

These indicators are displayed when the corresponding functions have been programmed. The option functions that display here are the Extra Rinse , Easy Iron , Eco , and Speed  functions.

Unlocking the door

The door automatically locks while in use and the  symbol is shown in locked state. A click will be heard when the door locks or unlocks.

Note

- If the appliance is switched off with the door locked, or if there is a power interruption, the door will unlock after 1 or 2 minutes.

Press the Start/Pause button to unlock the door during operation.

In the following cases, the door can't be unlocked even if operations are paused.

- During spin-drying
- When the water level is beyond a certain level

Note

- To unlock the door, set the programme selection dial to Off, and then select a programme. (ex. Cotton)

Caution

If the door needs to be unlocked mid-programme, make sure that water from the drum does not overflow onto the floor.

Water and soap suds may come out of the door and the door opening. If so, use a towel to soak them up.

Washing

Setting washing

Model NA-148VB6

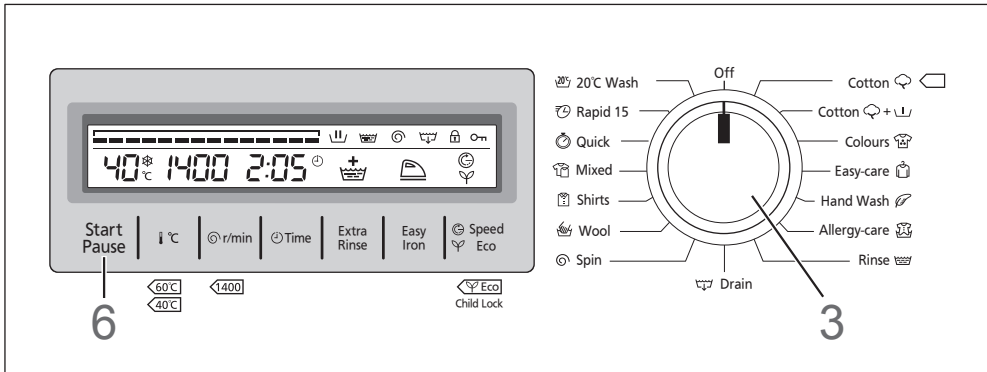

1. Open the door and put the laundry into the drum.

For details about preparing and sorting the laundry, see pages 12 and 20.

Caution

- **Make sure to place the laundry within the drum so that it does not get caught in the door. Failure to observe this may result in damage to the door seal, leading to malfunctions.**
- **Do NOT overload the drum.** This may cause excessive vibration or damage to the appliance.

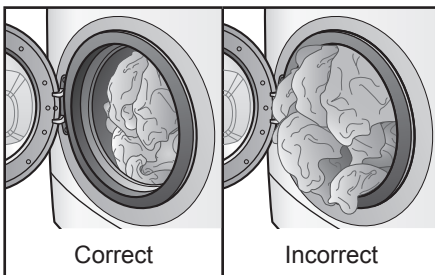

Note

When loading a large amount of laundry, make sure to evenly distribute the laundry throughout the drum.

2. Close the door.

3. Turn the programme selection dial in either direction to switch on the appliance and select the programme.

The programme time will be displayed. For more details about each programme, see pages 24-25.

20°C Wash programme

By using the cold water of 20 °C, this programme achieves the same cleaning strength as that for 40 °C programme (except for greasy filth).

Spin programme

With the Spin programme, the operation starts from the drain process whether there is water in the drum or not. After the water drains out to a preset level, the spin process starts.

4. Select optional functions.

For more details about available functions and settings for each programme, see pages 24-25.

5. Add detergent to the detergent drawer.

(P.13-15)

6. Press the Start button.

The appliance starts supplying water after draining.

Note

- Whenever you start washing, the process display flashes to show which function is in progress.
- Before any programme is started, the appliance first drains out any water.



The buzzer will sound and “END” will flash on the display when the programme has finished, and the door will unlock immediately.

Caution

After a high temperature wash, be careful to not burn yourself when handling the laundry or touching the inside of the drum.

Note

- If the detergent is not completely removed from the laundry by using the basic programme, use the Extra Rinse function.
- If the load is big, the laundry may stick to the inside of the drum. This is normal.
- Leave the appliance door open to allow the drum to dry out after removing the laundry.
- Remove the laundry and rearrange where necessary. Do not leave it in the drum too long after the programme ends to prevent colour transfer.

Required time

Required time depends on the programme and temperature setting.

- Actual time may differ slightly from the displayed time.
- The displayed time includes the time needed for the water to fill up and to drain out, thus they vary depending on water pressure, drainage and amount of laundry.
- If the laundry in the drum needs to be balanced, eg to facilitate smooth spinning, the time will be extended.

Setting the buzzer

To turn on or turn off the buzzer which sounds when the programme has finished, follow these instructions.

Simultaneously press and hold the Temperature and Time buttons for at least 3 seconds.

The buzzer setting will be turned off after a beep is heard.











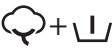



The buzzer setting will be turned on after two beeps are heard.

Changing settings while washing

After washing has started, the programme, temperature, spin speed, preset time, Extra Rinse, Easy Iron and Speed/Eco function cannot be changed.













To change the programme, temperature, spin speed, preset time, Extra Rinse, Easy Iron and Speed/Eco function settings, turn the appliance off and then on again.

Selecting the Programme

Programme	Description	148VB6 128VB6 Max load	147VB6 127VB6 147VC6 127VC6 Max load
 Cotton	Daily wash for cotton, linen and cotton blends.	8 kg	7 kg
 Cotton (Prewash)	Cotton programme with prewash process for heavily soiled laundry	8 kg	7 kg
 Colours	Colour-fast wash for cotton and cotton blend items.	4 kg	3.5 kg
 Easy-care	Gentle wash for cotton, linen and synthetic fibres.	4 kg	3.5 kg
 Hand Wash	Gentle wash for hand wash clothes.	2 kg	2 kg
 Allergy-care	Cycle to remove allergens.	4 kg	3.5 kg
 Rinse	Rinses washed laundry.	8 kg	7 kg
 Drain	Drains water from the drum.	—	—
 Spin	Spin-dries washed laundry.	8 kg	7 kg
 Wool	Gentle wash for hand and machine washable wool and wool blend clothes preventing clothes shrinkage.	2 kg	2 kg
 Shirts	Washing for collar and cuff grime of shirts and blouses, prevents creasing.	2 kg	2 kg
 Mixed	Mixed load for washing various fabrics such as cotton, linen and synthetic fibres	3.5 kg	3.5 kg
 Quick	Quick wash for lightly soiled cotton and linen blends.	4 kg	3.5 kg
 Rapid 15	15 min. full rapid wash for a small amount of lightly soiled items.	2 kg	2 kg
 20°C Wash	Low energy, low temp. wash for lightly soiled cotton and linen blends.	4 kg	3.5 kg

20 - Washing Instructions













Power and Water Consumption

Programme	Temperature	Load (kg)	Power consumption (kWh) ²⁾	Water consumption (L) ²⁾	Time ²⁾
			148VB6 128VB6	148VB6 128VB6	148VB6 128VB6
 Cotton	40 °C	8	0.92	60	2:05
 Cotton + Eco function	40 °C ¹⁾	4	0.71	41	2:50
	60 °C ¹⁾	8	0.95	51	3:20
		4	0.77	41	2:55
 Cotton (Prewash)	40 °C	8	0.98	70	2:23
 Colours	40 °C	4	0.91	52	1:45
 Easy-care	40 °C	4	0.60	55	1:25
 Hand Wash	30 °C	2	0.32	68	1:30
 Allergy-care	60 °C	4	3.08	87	3:20
 Wool	30 °C	2	0.10	50	0:40
 Shirts	40 °C	2	0.60	45	1:25
 Mixed	30 °C	3.5	0.46	55	1:25
 Quick	40 °C	4	0.48	38	1:08
 Rapid 15	30 °C	2	0.10	30	0:15
 20°C Wash	20 °C	4	0.31	42	1:40

1) Results calculated based on the maximum spin speed comply with EN 60456.

2) The power, water consumption, and time indicated in the table may vary depending on variations in pressures, water hardness and temperatures, room temperatures, types and amounts of laundry, voltage fluctuations and functions to be used.

Power and Water Consumption













Programme	Temperature	Load (kg)	Power consumption (kWh) ²⁾	Water consumption (L) ²⁾	Time ²⁾
			147VB6 127VB6	147VB6 127VB6	147VB6 127VB6
 Cotton	40 °C	7	0.93	60	2:05
 Cotton + Eco function	40 °C ¹⁾	3.5	0.64	39	2:40
	60 °C ¹⁾	7	0.83	47	3:20
		3.5	0.68	39	2:50
 Cotton (Prewash)	40 °C	7	0.98	69	2:23
 Colours	40 °C	3.5	1.00	52	1:45
 Easy-care	40 °C	3.5	0.61	47	1:25
 Hand Wash	30 °C	2	0.29	57	1:30
 Allergy-care	60 °C	3.5	2.96	82	3:15
 Wool	30 °C	2	0.11	45	0:40
 Shirts	40 °C	2	0.60	44	1:25
 Mixed	30 °C	3.5	0.32	60	1:25
 Quick	40 °C	3.5	0.48	38	1:08
 Rapid 15	30 °C	2	0.10	30	0:15
 20°C Wash	20 °C	3.5	0.27	42	1:40

1) Results calculated based on the maximum spin speed comply with EN 60456.

2) The power, water consumption, and time indicated in the table may vary depending on variations in pressures, water hardness and temperatures, room temperatures, types and amounts of laundry, voltage fluctuations and functions to be used.

22 - Washing Instructions











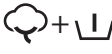



Power and Water Consumption

Programme	Temperature	Load (kg)	Power consumption (kWh) ²⁾	Water consumption (L) ²⁾	Time ²⁾
			147VC6 127VC6	147VC6 127VC6	147VC6 127VC6
 Cotton	40 °C	7	0.82	62	2:05
 Cotton + Eco function	40 °C ¹⁾	3.5	0.65	41	2:40
	60 °C ¹⁾	7	1.05	54	3:25
		3.5	0.72	41	2:45
 Cotton (Prewash)	40 °C	7	0.97	72	2:23
 Colours	40 °C	3.5	0.96	56	1:45
 Easy-care	40 °C	3.5	0.62	48	1:25
 Hand Wash	30 °C	2	0.41	56	1:31
 Allergy-care	60 °C	3.5	2.72	85	3:15
 Wool	30 °C	2	0.13	50	0:40
 Shirts	40 °C	2	0.64	44	1:25
 Mixed	30 °C	3.5	0.30	62	1:25
 Quick	40 °C	3.5	0.42	36	1:08
 Rapid 15	30 °C	2	0.10	32	0:15
 20°C Wash	20 °C	3.5	0.26	45	1:40

1) Results calculated based on the maximum spin speed comply with EN 60456.

2) The power, water consumption, and time indicated in the table may vary depending on variations in pressures, water hardness and temperatures, room temperatures, types and amounts of laundry, voltage fluctuations and functions to be used.

Details of Programmes

Programme	Auto setting				
	Temperature	Number of rinses	Spin speed		Approximate 148VB6 128VB6
			128VB6 127VB6 127VC6	148VB6 147VB6 147VC6	
 Cotton	40 °C	2	1200	1400	2:05
 Cotton (Prewash)	40 °C	2	1200	1400	2:23
 Colours	40 °C	2	1200	1400	1:45
 Easy-care	40 °C	2	800	800	1:25
 Hand Wash	30 °C	2	600	600	1:30
 Allergy-care	60 °C	4	800	800	3:20
 Rinse	Cold	3	1200	1400	0:36
 Drain	—	—	—	—	0:03
 Spin	—	—	1200	1400	0:15
 Wool	30 °C	3	600	600	0:40
 Shirts	40 °C	2	600	600	1:25
 Mixed	30 °C	2	800	800	1:25
 Quick	40 °C	2	1200	1400	1:08
 Rapid 15	30 °C	1	800	800	0:15
 20°C Wash	20 °C	2	1200	1400	1:40

24 - Washing Instructions

Details of Programmes

			Manual setting			Option functions		
time			Temperature	Spin speed		Extra Rinse ¹⁾	Easy Iron	Speed/Eco ¹⁾
	147VB6 127VB6	147VC6 127VC6		128VB6 127VB6 127VC6	148VB6 147VB6 147VC6			
	2:05	2:05	Cold - 90 °C	0 - 1200	0 - 1400	✓	✓	✓
	2:23	2:23	Cold - 90 °C	0 - 1200	0 - 1400	✓	✓	✓
	1:45	1:45	Cold - 40 °C	0 - 1200	0 - 1400	✓	✓	✓
	1:25	1:25	Cold - 60 °C	0 - 800	0 - 800	✓	✓	✓
	1:30	1:31	Cold - 30 °C	0 - 600	0 - 600	✓	—	—
	3:15	3:15	Cold - 60 °C	0 - 800	0 - 800	—	✓	—
	0:36	0:36	Cold	0 - 1200	0 - 1400	—	✓	—
	0:03	0:03	—	—	—	—	—	—
	0:15	0:15	—	400 - 1200	400 - 1400	—	✓	—
	0:40	0:40	Cold - 40 °C	0 - 600	0 - 600	✓	—	—
	1:25	1:25	Cold - 60 °C	0 - 600	0 - 600	✓	✓	✓
	1:25	1:25	Cold - 30 °C	0 - 800	0 - 800	✓	✓	—
	1:08	1:08	Cold - 60 °C	0 - 1200	0 - 1400	✓	✓	—
	0:15	0:15	Cold - 30 °C	0 - 800	0 - 800	—	✓	—
	1:40	1:40	Cold - 20 °C	0 - 1200	0 - 1400	✓	✓	—

1) You cannot simultaneously select the Extra Rinse and Speed/Eco functions.

Washing Instructions - 25

Washing Delicates

Wool and Hand Wash programmes

The drum spins gently in these programmes.

For details, see pages 18-19.

Delicate laundry loads

Wool programme: 2 kg or less

Hand Wash programme: 2.5kg or less

Approximate weights

- Wool sweater: 400 g



- Silk blouse: 200 g



- Trousers: 400 g

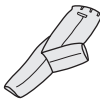

Hanging the laundry

- Hang out white or light-coloured wool and nylon items away from direct heat or sunlight.
- After washing, lay out wool and nylon clothes, and return them to their normal shape before hanging in the shade. This will help to reduce the ironing time.
- Hang wool items with creases smoothed out, or spread them out to dry.

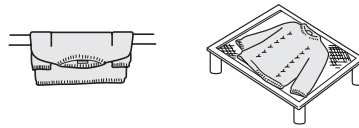

- Use hangers for shirts, blouses and trousers. Wrap a towel around the hanger to approximate the clothing's shoulder width so that it will retain its shape as it dries.



Tips for washing delicates

Putting laundry in the drum

Pile items one on top of each other.

Detergents

- For wool items, use a mild liquid detergent. Other detergents may damage the clothes.
- With Wool and Hand Wash programmes, you may need to use the Extra Rinse function to remove excess detergent from the laundry. (P.28)

If clothing shrinks in the wash

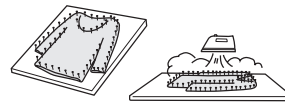

Spread the item out to its original size on an ironing board. Use dress pins to hold the size and shape. Then, use an iron to steam it and leave it to dry.



Washing Blankets and Bedspreads

Programme for Bedding

When you wash the bedding, Mixed + Extra Rinse is recommended.

- Make sure that the label of each item to be washed shows either the wash or hand-wash symbol (, ).
- Wash only one blanket at a time.

Washable

- 100 % synthetic fibre blankets – up to 3 kg
- 100 % synthetic fibre futons and 100 % cotton blankets – up to 1.5 kg (single bed size)
- Sheets
- Bedspreads
- 100 % synthetic fibre undersheets

Non-washable

- 100 % wool blankets
- Long-piled blankets
- Electric blankets (including cover)

Putting bedding into the drum

1. Fold down the blanket or bedspread into a quarter of their original size.

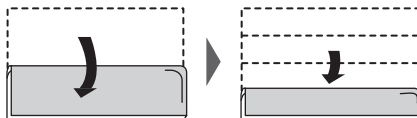

2. Put the blanket or bedspread into the drum.

Fold it while putting it into the drum.

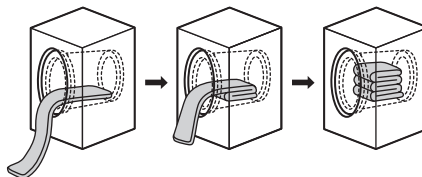

Both ends of the blanket should face the rear of the drum.

Caution

Do NOT roll the blanket or bedspread into balls, or haphazardly fold them.

This may cause excessive vibration and damage the laundry or the appliance.

Note

Avoid using blanket nets. They prevent the laundry from spinning properly.



Optional Functions

Extra Rinse

You can rinse your laundry more thoroughly with an extra rinsing process.

Speed/Eco

You can shorten wash cycles or conserve energy.

Function	Description
Normal Wash	Normal wash cycle
Speed 	This function requires less time for washing and is suitable for lightly soiled laundry.
Eco 	Washing consumes less energy.

Child lock

When the child lock is activated, the controls are locked. This prevents children from changing the wash settings or playing with the appliance.

Activating/deactivating child lock

1. Switch on the appliance.
2. Press and hold the Speed/Eco button for at least 5 seconds.
The  symbol light up to show that the child lock is activated.
3. To deactivate, hold down the Speed/Eco button again for 5 seconds (please ignore three beeps heard), and keep Speed/Eco button pressed until it unlocks.

Preset timer

Time function is available to preset the time for the programme to start.

Note

Do NOT use detergent which does not dissolve thoroughly with the preset function because the detergent may cake up before the wash starts and does not flow out.

Setting a preset time

Set a preset time after you have selected the programmed and optional functions. (P.18)

1. **Continuously press the Time button until the desired preset time is displayed.**
2. **Press the Temperature button or the Extra Rinse button to set the preset time.**
The countdown has not started.
 - To cancel the preset time
Press the Time button.
 - To change the preset time
Press the Time button, then redo the setting from step 1.
3. **Press the Start/Pause button to activate the countdown.**
 - To cancel the preset time
Turn the programme selection dial to 'Off'. (All settings will be cancelled.)
 - To change the preset time
Turn the programme selection dial to 'Off'. After reselecting the programme and optional functions, redo the setting from step 1.

Easy Iron

This function makes ironing easier by spin-drying your laundry more gently (at 1000 r/min or less).

- After the programme has finished, the laundry is rotated intermittently for up to 5 minutes or until the door is opened.
- Reducing wrinkles helps to unravel tangled laundry.

Cleaning the outside of the appliance

Clean the outside of the appliance with a soft cloth and mild detergent, for example, kitchen detergent, and soapy water.

Warning

- Do NOT splash water over the appliance.
- Do NOT use cream cleansers, thinners, nor products containing alcohol or paraffin oil.

Cleaning the door seal and window

After each wash, perform the following:

- Remove any objects from the door seal.
- Wipe the window and seal to remove lint and stains.

If lint builds up, it can cause leaks.

Cleaning the drain filter

We recommend cleaning the drain filter once a month. The filter will have lint buildup, which may interrupt drainage water flow.

1. Switch off and unplug the appliance.
2. Remove the drain filter cover using the supplied liquid detergent level plate.
Then, place a container underneath it to collect the drainage.

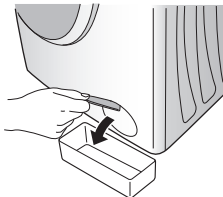

3. Carefully turn the drain filter anticlockwise to unscrew it.
More water may drain out.
This is normal.

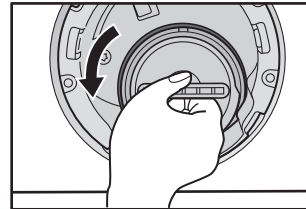

4. Then, remove the drain filter.

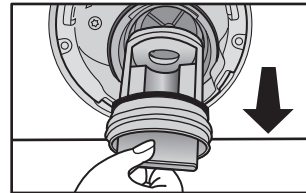

5. Remove any lint and debris.
6. Replace the drain filter and drain filter cover.
Reinsert the drain filter. Then turn it clockwise until it touches the stopper.

Caution

Do not remove the drain filter if there is water inside the drum, such as during operation. If you do, a large volume of water (possibly scalding water) will pour out.

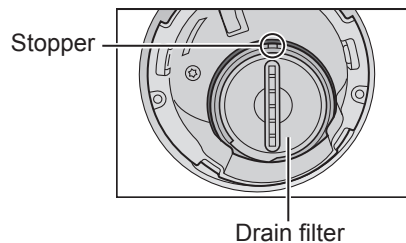

Maintenance

Cleaning the drum

If you keep using cold water in the appliance, bacteria may build up inside the drum and emit an odour. You can avoid this by running the 90 °C Cotton programme once a month.

(When using a scale remover, follow the manufacturer's instructions.)

Caution

Viruses and bacteria are not killed in water temperature of 40 °C. Pathogens can spread via the mingling of clothes and thus transmit diseases.

Pathogens die at a temperature of at least 60 °C.

Note

Do NOT put laundry or laundry detergent into the appliance during cleaning.

If you use tub cleaning detergent or bleach, put it into the detergent drawer before starting the wash. The appropriate amount to be used is approximately 30 ml. (P.13)

Cleaning the detergent drawer

Detergent residue soon builds up if the detergent drawer is not cleaned regularly. Detergent buildup may develop mould.

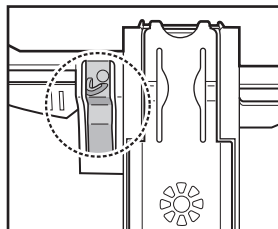

1. Pull out the detergent drawer.

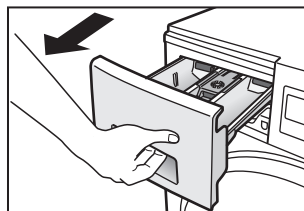

2. Remove the detergent drawer by pulling it out while pressing down on the tab as shown in the figure below.

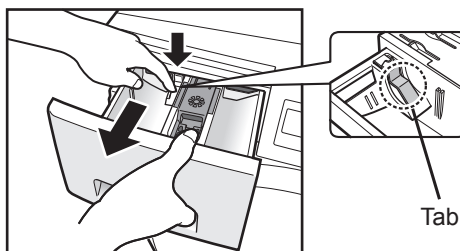

- Put your finger on the tab near the front of the softener cover and pull it up to remove it from the detergent drawer.

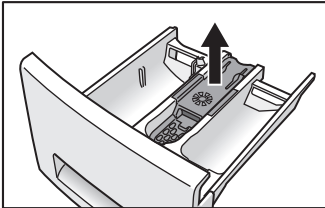

- Wash out the detergent residue with water. Use a cloth to wipe the water from the appliance.
- Replace the softener cover.
- Reinsert the detergent drawer while pressing down on the tab as shown in the figure below.

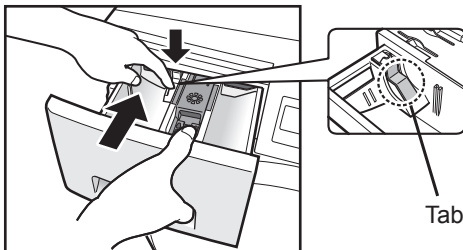

Cleaning the water supply filter

Clean the filter if water is not supplied properly.

- Turn the tap off.
- Switch on the appliance.
- Select the Cotton programme, and then press the Start button. Drainage begins when the appliance is started.
- After 2 minutes, switch off the appliance. Water has drained out of the water supply hose.
- Disconnect the water supply hose from the appliance.
- Clean the filter, which is on the rear of the appliance.

Use a small brush, for example, a toothbrush.

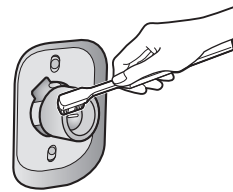

- If the unit is supplied with the hose fitted with a water supply valve, turn off the tap supplying water to the appliance, disconnect the hose from the tap and then clean the filter on the hose in the same way.

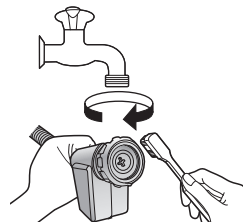

- Reconnect the water supply hose. Tighten the plastic joint firmly.
- Turn on the tap and then check for leaks.

Maintenance

Preventing a frozen water supply hose

If the appliance is delivered in freezing weather conditions, after setting up, leave it at room temperature for 24 hours before using. This will ensure that the water supply hose does not become clogged up with ice.

If your water supply hose freezes, perform the following procedures:

- 1. Wrap warm towels around the joints of the water supply hose.**

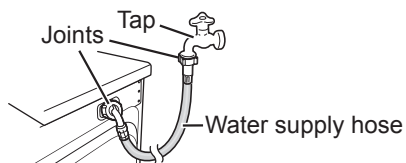

- 2. Add 2 to 3 litres of warm water to the drum.**



- 3. Run the Drain programme.
(P.18)**

Fault Checklist

Problem		Cause
Washing machine	Buttons do not work.	<ul style="list-style-type: none"> - The programme, temperature, spin speed, preset time, Extra Rinse, Easy Iron or Speed/Eco function settings cannot be changed while washing is in progress. - Child lock may be activated. (P.28)
	Door does not open.	<ul style="list-style-type: none"> - Door lock may be activated. (P.17) - The water temperature or level may be too high. (P.17)
	Unusual odour	<ul style="list-style-type: none"> - Rubber parts may give off a smell when you start using the appliance, but the smell will go away over time. You can wash the drum by running the 90 °C programme. (P.30)
Wash	No water going into the appliance.	<ul style="list-style-type: none"> - The water tap may be turned off. - The water supply hose may be frozen. (P.32) - The water supply may be disrupted. - The water supply filter may be clogged. (P.31)
	There is only a small amount of water.	<ul style="list-style-type: none"> - If you have paused the washing and then restart it, the appliance may drain out some water. Do NOT pour water in through the door.
	Water builds up during the wash process.	<ul style="list-style-type: none"> - This is normal; water is automatically supplied if the amount of water has decreased. For heavy loads, the water may fill up repeatedly.
Rinse/Spin	No water flows into the appliance during the rinse process.	<ul style="list-style-type: none"> - Before rinsing, the appliance spins to drain out remaining water. The water will fill up after that.
	Rinsing begins before the spin process finishes.	<ul style="list-style-type: none"> - After washing, excess foam may remain, so the water is drained out and refilled to wash it away. This feature is called foam detection.
	During spin-dry, the drum stops and rotates several times.	<ul style="list-style-type: none"> - This is normal; the appliance has detected that the load is not balanced and is trying to re-distribute the clothes within the drum to correct it.
	Foam and water remain in the door or door seal.	<ul style="list-style-type: none"> - Although some foam and water may remain depending upon the state of the laundry and the amount of detergent used, rinse performance is unaffected.
	The spin process repeatedly starts and stops.	<ul style="list-style-type: none"> - This is normal; intermittent spinning of the tub helps the spin process to operate quietly. - The laundry may be too light. If so, add one or two bath towels.
	The laundry is still wet after the spin process finishes.	<ul style="list-style-type: none"> - The unit detected an out of balance load but was not able to correct it automatically. - If the laundry is too light, add one or two bath towels. - If the laundry gets tangled up, untangle it.

Troubleshooting - 33

Fault Checklist

Problem		Cause
Detergent and foam	There is no foam or hardly any foam.	<ul style="list-style-type: none"> - The amount of foam varies, depending on the temperature, level and softness of the water. - You may have put powdered detergent directly into the drum; you must put it in the detergent drawer. - You may not be using enough detergent. - You may be using a reduced-foam type of detergent. - Heavily soiled laundry and larger loads of laundry may reduce the amount of foam.
	There is a lot of foam.	<ul style="list-style-type: none"> - The amount of foam varies, depending on the temperature, level and softness of the water. - You may have used too much detergent. - The type of detergent you are using may cause excess foam.
	Fabric softener overflows.	<ul style="list-style-type: none"> - The softener may have exceeded the MAX level of the detergent drawer. (P.15) - You may have spilt the liquid when closing the detergent drawer too strongly.
	After the wash has finished, powdered detergent residue remains.	<ul style="list-style-type: none"> - You may have put powdered detergent directly into the drum; you must put it in the detergent drawer.

Fault Checklist

Problem		Cause
Time	The displayed remaining time changes.	- The remaining time is estimated and corrected continually. Thus, the time displayed may change.
Noise	There is an unusual noise or vibration.	- There may be metal items in the drum. - The anchor bolts may not have been removed. (P.38) - The appliance may be on a sloping or unstable surface. If none of the above is the cause, contact your local Customer Service Centre.
	There is noise when the water drains out.	- This is normal; it is noise generated by the operation of the drain pump.
	Noise increases during high spin speed.	- This is normal; Motor noise increases gradually with the spin speed.
	There are noises during washing or rinsing.	- This is normal; They are noises from the pump that circulates washing or rinsing water. (148VB6, 128VB6, 147VB6 and 127VB6)
Others	The electricity supply cuts out while the appliance is on.	- The appliance stops operating. When power is restored, it resumes operation from the point that it had stopped.
	A circuit breaker trips and the electricity supply is cut.	- The appliance stops operating. When the breaker is reset, it resumes operation from the point that it had stopped. However, we recommend that the reason that caused the breaker to trip is found and steps taken to solve it.
	The water supply is disrupted.	- When the water is supplied again, it may be impure at first. You have to disconnect the water supply hose and drain away the impure water through the tap. Make sure that the water supply hose has been reconnected before using the appliance.
	The display is not clear.	- The appliance may be in a brightly lit or sunlit area.

Error Display

Error	What to do
E01 Door is open	Make sure that the door is closed properly.
E02 Unable to supply water	Check for any of the following problems. <ul style="list-style-type: none">- The tap is closed.- The water pipe or hose is frozen.- The water supply has been disrupted.- The water supply filter is clogged. (P.31)
E03 Unable to drain	Check the drain hose for any of the following problems. <ul style="list-style-type: none">- There is a clog in the hose.- The hose tip is immersed in water.- It extends with joints.- The water is frozen. Clean the drain filter if it clogs up. (P.29)
E04 Overflow	Check for any of following problems. <ul style="list-style-type: none">- The water supply valve has failed.- The water supply valve triac has failed. Switch off and unplug the appliance. Shut off the tap and contact your local Customer Service Centre.

To restart operation after an error message appears, set the programme selection dial to Off, and then select a programme and start the operation.

Choosing the Right Location

Carrying the appliance

The appliance must be carried by 2 or more people.



Start by tilting the appliance backwards. The appliance should be carried by two people, one on each side holding it from the bottom.

The right place for the appliance

Make sure that there is enough space for the appliance and that openings on the base are not obstructed by a carpet.

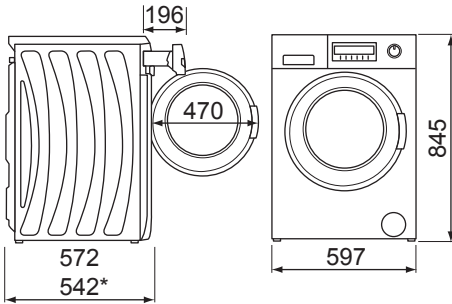

Dimension in millimetres

* for NA-147VB6, 127VB6, 147VC6 and 127VC6

Caution

- Install the appliance on a flat, stable surface to avoid excessive vibration and noise.
If the floor is not flat and stable, contact your local Customer Service Centre.
- Do NOT install the appliance on a carpet or similar type of flooring.
- Do NOT install the appliance in direct sunlight or in a place where temperatures reach freezing.
- Do NOT let metallic portions of the appliance come into contact with metal sinks or other appliances.

Set-in installation

- You need a space of at least 60 cm wide. Provide at least 2 mm of clearance on both sides and at least 5 mm of clearance both on the top and the back of the appliance.
- The counter above the appliance must be firmly fixed to the adjoining cupboards.

Caution

Do NOT install the appliance set-in with the cover panel removed.

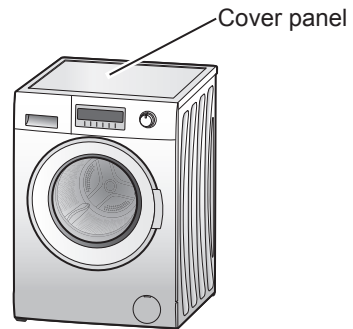

Moving and Installing

Removing the anchor bolts

Four anchor bolts keep the interior of the appliance in place while the appliance is being moved. Remove them before installation, using a spanner. Follow the instructions below.

Note

The anchor bolts must be removed before the appliance is operated. They may cause excessive vibration.

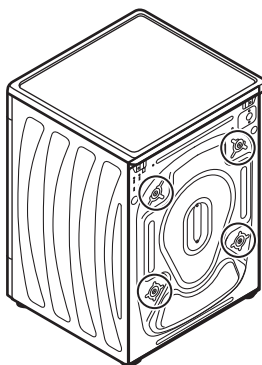

1. Use a spanner to loosen the four bolts.

Rotate the bolts anti-clockwise.

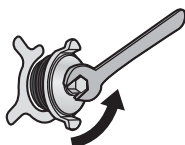

2. Pull the bolts out horizontally.

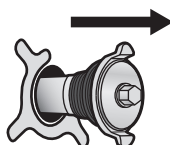

3. Attach each cover cap (included with the accessories) over each bolt hole.

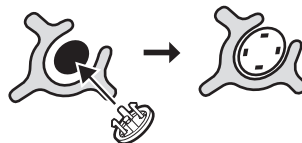

Note

- Make sure that you store the anchor bolts because they are used when transporting the appliance. If the appliance is passed on to another person, make sure to give the anchor bolts to that person.
- Make sure the cover caps are attached. Failure to observe this may result in water entering the washing machine, leading to malfunctions.

Moving the appliance

Note

Make sure to install the anchor bolts in the appliance.

Before you move the appliance

- Shut the tap and run the appliance to drain the water. Drain remaining water from the drain filter. (P.29)
- Depressurize and remove the water supply hose.
- Disconnect the power cable.
- Install the anchor bolts. (P.39)

Moving and Installing

Installing the anchor bolts

1. Remove each cover cap.

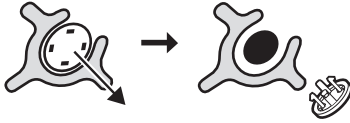

2. Insert each anchor bolt.

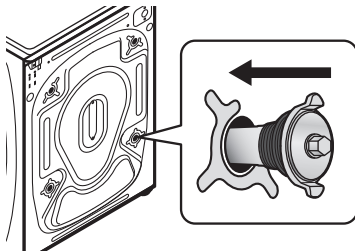

3. Tighten each bolt with a spanner.

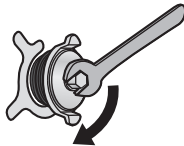

Levelling the appliance

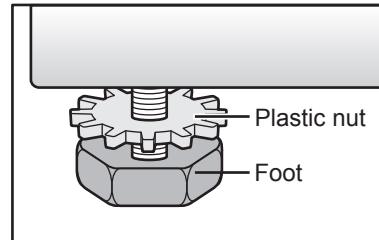

1. Loosen the plastic nut on each foot by turning it clockwise.
2. Adjust each foot by turning it clockwise or anticlockwise.
3. Use a spirit level to make sure that the appliance is properly levelled.
4. Tighten each plastic nut by turning it anticlockwise.

Caution

- Make sure that all plastic nuts are tightened securely and the feet are still securely bolted to the appliance.
If they are unbolted, the appliance will move around.
- Do NOT put cardboard, wood or similar materials under the appliance to compensate for unevenness.
- Be careful not to destabilize the appliance when cleaning the floor.

Connecting Hoses and Power Supply

Follow the instructions in this section to prevent water leaks. If you are unsure, ask a service agent to connect the hoses.

Hoses and cable lengths

Left side connections

Right side connections

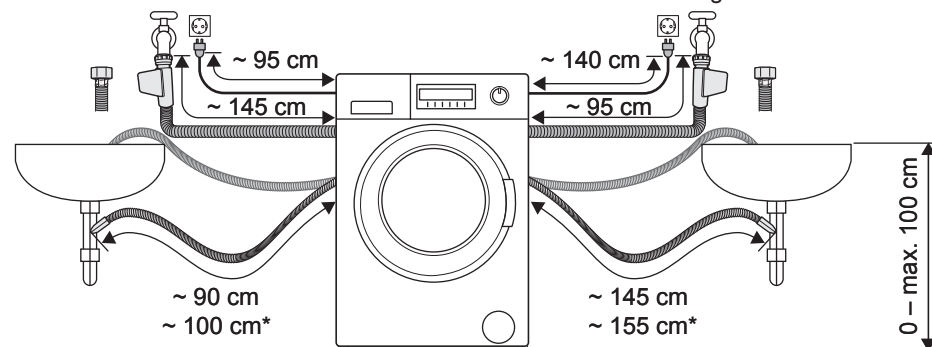

* for NA-147VB6, 127VB6, 147VC6 and 127VC6

Water supply hose

Caution

- Do NOT connect the water supply hose to a combination tap.
- Do NOT twist, squash, modify, or cut the hose.

- Optimum mains water pressure is 0.1 - 1.0 MPa. If the water pressure exceeds this value, install a pressure reducing valve.
- Waterflow from the tap should be more than 5 L/min.

Connecting the water supply hose

1. Attach one end of the hose to the water inlet on the back of the appliance and tighten the joint by hand.

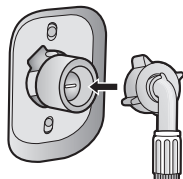

2. Attach the other end of the hose to the tap and tighten it the same way.

- Standard hose

Make sure the filter is inside the hose.

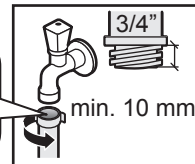

- Hose with water supply valve

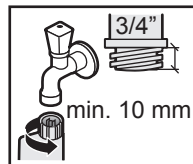

3. Open the tap slowly and make sure that there are no leaks around the joints.

The joints are subject to water pressure.

Connecting Hoses and Power Supply

Leak-proof System

The appliance is installed with a system that is designed to prevent water leaks. The system includes the following components:

1) Aquastop system

If a water leak is detected in the water inlet hose, the system stops supplying water automatically. This system is only functions with hoses with water supply valves.

2) Overflow detection

If water in the appliance increases to a certain level, this function stops the water supply and activates the drain pump.

Water drain hose

Caution

- Do NOT twist, pull out, or bend the drain hose.
- Do NOT use joints to extend the water drain hose.

Draining to a sink or wash-basin

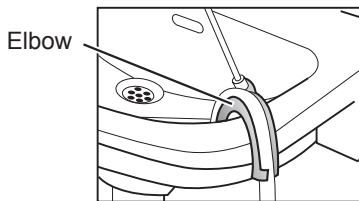

Caution

- The water drain hose must be removed from the hook on the rear side of the appliance before the appliance is operated.

If the water drain hose is close to the appliance, the hose may come in contact with the appliance and generate noise during the spin cycle because of vibrations.

- Secure the water drain hose so that it will not come out of the basin.
- Do NOT block the drain outlet of the basin. Make sure that drainage into the drain is sufficient.
- Do NOT let the tip of the water drain hose dip into the drained water. This can cause water to flow back into the appliance.

Draining to a drain hose

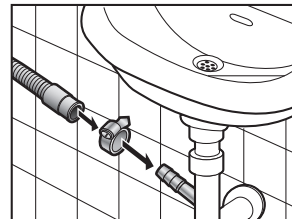

Connecting Hoses and Power Supply

Connecting to the power supply

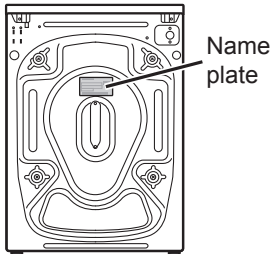

Caution

- The name plate indicates the rated power that the appliance needs. Make sure that the power supply specifications in your residence match the information mentioned here. The information on the power supply specifications are also mentioned on page 44 of these instructions.
- If the product is not correctly grounded, the user will be liable for any damage incurred.

Checking after Installation

Installation checklist

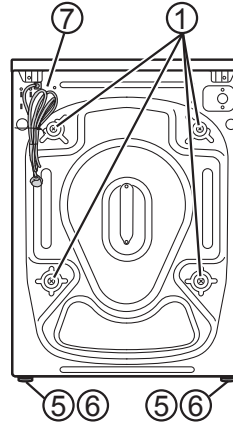
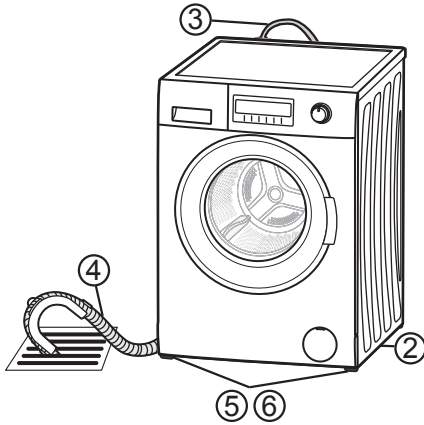

- 1) Anchor bolts
Have you removed them and attached the cover caps properly?
- 2) Location
Is the appliance on a flat, stable surface?
Does it run without vibrating?
- 3) Water supply hose
Is it free from leaks?
Is the water supply normal?
- 4) Water drain hose
Is it free from leaks?
Does it drain normally?
- 5) Adjustable feet
Are they bolted securely to the appliance?
- 6) Feet cushions
Are they standing flat?
If the appliance is not level, there may be abnormal sounds when water is drained out.
- 7) Power supply
Is the household dedicated mains socket fully rated at AC 220 V to 240 V?

Specifications

		NA-148VB6 NA-128VB6	NA-147VB6 NA-127VB6	NA-147VC6 NA-127VC6
Rated voltage		220 - 240 V		
Rated frequency		50 Hz		
Maximum energy rated power input		2200 W		
Heating energy rated power input		2000 W		
Product weight		77 kg	73 kg	72 kg
Maximum mass of dry cloth		8 kg	7 kg	7 kg
Product dimensions	Height	845 mm		
	Width	597 mm		
	Depth	572 mm	542 mm	542 mm
Water consumption		Refer to "Power and Water Consumption".		
Pressure of tap water		0.1 - 1 MPa		

Product fiche

(EU)No.1061/2010

Supplier's name			Panasonic		
Supplier's model identifier			NA-148VB6 NA-128VB6	NA-147VB6 NA-127VB6	NA-147VC6 NA-127VC6
Rated capacity of Cotton programme	kg		8	7	7
Energy efficiency class ¹⁾ A+++ (most efficient) : EEI<46 A++ : 46≤EEI<52			A+++	A+++	A++
Annual energy consumption ²⁾		kWh/year	194	162	195
<p>1) The energy efficiency class of a household washing machine shall be determined on the basis of its Energy Efficiency Index (EEI).</p> <p>2) Energy consumption in kWh per year, based on 220 standard washing cycles for Cotton + Eco programmes at 60 °C and 40 °C at full and partial load, and the consumption of the low-power modes. The actual energy consumption will depend on how the appliance is used.</p>					
Energy consumption (Cotton + Eco option programme)	60 °C at full load	kWh	0.95	0.83	1.05
	60 °C at partial load	kWh	0.77	0.68	0.72
	40 °C at partial load	kWh	0.71	0.64	0.65
Power consumption	Off-mode	W	<0.5	<0.5	<0.5
	Left on-mode	W	<1.0	<1.0	<1.0
Weighted annual water consumption ³⁾		L/year	9900	9240	10346
<p>3) Water consumption in litres per year, based on 220 standard washing cycles for Cotton + Eco programmes at 60 °C and 40 °C at full and partial load. The actual water consumption will depend on how the appliance is used.</p>					
Spin-drying efficiency class on a scale from G (least efficient) to A (most efficient)			B	B	B
Maximum spin speed		r/min	NA-148VB6, 147VB6 and 147VC6: 1400 NA-128VB6, 127VB6 and 127VC6: 1200		
Remaining moisture content		%	53	53	53
<p>The standard 60 °C and 40 °C Cotton programme with Eco option are the standard washing programmes to which the information in the label and the fiche relates. These programmes are suitable to clean normally soiled cotton laundry and are the most efficient programmes in terms of combined energy and water consumption.</p>					
Programme time ⁴⁾ (Cotton + Eco option programme)	60 °C at full load	min	200	200	205
	60 °C at partial load	min	175	170	165
	40 °C at partial load	min	170	160	160
Airborne accoustical noise emissions	Wash	dB	58	58	58
	Spin	dB	NA-148VB6, 147VB6 and 147VC6: 76 NA-128VB6, 127VB6 and 127VC6: 74		
4) In minutes and rounded to the nearest minute					
Freestanding appliance			Yes		



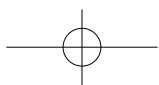
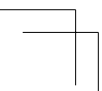
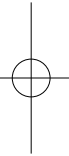
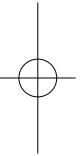
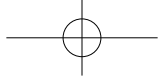
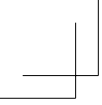

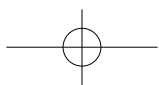
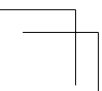
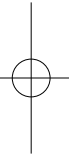
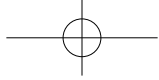
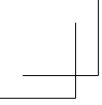

Installation Instructions - 45





Setting of the course for the energy consumption values

By the following procedures the energy consumption values for the standard programmes can be realised. These programmes "Cotton 60 °C" or "Cotton 40 °C" are the standard programmes in accordance with the EU Regulations 1061/2010 and 1015/2010. Those programmes are suitable to clean normally soiled cotton laundry and are the most efficient programmes in terms of combined energy and water consumptions for washing that type of cotton laundry.

1.  **Set the dial to Cotton.**
2.  **Choose Eco function. (P.28)**
3.  or  **Choose maximum spin speed. (P.25)**
4.  or  **Choose water temperature of 60 °C/40 °C.**

- The actual water temperature may differ from the declared cycle temperature.

Panasonic Corporation
Web Site: <http://panasonic.net>

© Panasonic Corporation 2015

Printed in Turkey
March 2015
W9901-9JG00