

SAMSUNG

HW-J450

User manual

Wireless Audio - Soundbar

Imagine the possibilities

Thank you for purchasing this Samsung product.
To receive a more complete service, please register your product at
www.samsung.com/register

FEATURES

TV SoundConnect

TV SoundConnect lets you listen to audio from your TV on your Soundbar via a Bluetooth connection and lets you control the sound.

HDMI

HDMI transmits video and audio signals simultaneously, and provides a clearer picture. The unit is also equipped with the ARC function which lets you listen to sound from your TV through the Soundbar via an HDMI cable. This function is only available if you connect the unit to an ARC compliant TV.

SURROUND SOUND

The **SURROUND SOUND** feature adds depth and spaciousness to your listening experience.

Wireless Subwoofer

Samsung's wireless module does away with cables running between the main unit and the subwoofer. Instead, the subwoofer connects to a compact wireless module that communicates with the main unit.

Special Sound Effects

You can select different Sound Effects - STANDARD (Original Sound)/MUSIC / VOICE / SPORTS / CINEMA / NIGHT MODE - depending on the type of content you want to enjoy.

Multi-function Remote Control

You can use the supplied remote control to control various operations with the simple press of a button.

USB Host Support

You can connect and play music files from external USB storage devices such as MP3 players, USB flash memory, etc. using the Soundbar's USB HOST function.

Bluetooth Function

You can connect a Bluetooth device to the Soundbar and enjoy music with high quality stereo sound, all without wires!

Using Samsung Audio Remote App

To control the product with your Smart Device via the Samsung Audio Remote app, download the Samsung Audio Remote App by accessing the app through Google Play store.

LICENSES



Manufactured under license from Dolby Laboratories. Dolby and the double-D symbol are trademarks of Dolby Laboratories.



For DTS patents, see <http://patents.dts.com>. Manufactured under license from DTS Licensing Limited. DTS, the Symbol, & DTS and the Symbol together are registered trademarks, and DTS 2.0 Channel is a trademark of DTS, Inc. © DTS, Inc. All Rights Reserved.





HDMI

The terms HDMI and HDMI High-Definition Multimedia Interface, and the HDMI Logo are trademarks or registered trademarks of HDMI Licensing LLC in the United States and other countries.

SAFETY INFORMATION

SAFETY WARNINGS

TO REDUCE THE RISK OF ELECTRIC SHOCK, DO NOT REMOVE THE COVER (OR BACK).
NO USER-SERVICEABLE PARTS ARE INSIDE. REFER SERVICING TO QUALIFIED SERVICE PERSONNEL.

	CAUTION RISK OF ELECTRIC SHOCK DO NOT OPEN			This symbol indicates "dangerous voltage" inside the product that presents a risk of electric shock or personal injury.
				This symbol indicates important instructions accompanying the product.

WARNING : To reduce the risk of fire or electric shock, do not expose this appliance to rain or moisture.

CAUTION : TO PREVENT ELECTRIC SHOCK, MATCH WIDE BLADE OF PLUG TO WIDE SLOT, FULLY INSERT.

- This apparatus shall always be connected to a AC outlet with a protective grounding connection.
- To disconnect the apparatus from the mains, the plug must be pulled out from the mains socket, therefore the mains plug shall be readily operable.

CAUTION

- Do not expose this apparatus to dripping or splashing. Do not put objects filled with liquids, such as vases on the apparatus.
- To turn this apparatus off completely, you must pull the power plug out of the wall socket. Consequently, the power plug must be easily and readily accessible at all times.

Wiring the Main Power Supply Plug (UK Only)

IMPORTANT NOTICE

The mains lead on this equipment is supplied with a moulded plug incorporating a fuse. The value of the fuse is indicated on the pin face of the plug and if it requires replacing, a fuse approved to BS1362 of the same rating must be used. Never use the plug with the fuse cover removed. If the cover is detachable and a replacement is required, it must be of the same colour as the fuse fitted in the plug. Replacement covers are available from your dealer. If the fitted plug is not suitable for the power points in your house or the cable is not long enough to reach a power point, you should obtain a suitable safety approved extension lead or consult your dealer for assistance. However, if there is no alternative to cutting off the plug, remove the fuse and then safely dispose of the plug. Do not connect the plug to a mains socket as there is a risk of shock hazard from the bared flexible cord. Never attempt to insert bare wires directly into a mains socket. A plug and fuse must be used at all times.

IMPORTANT

The wires in the mains lead are coloured in accordance with the following code:- BLUE = NEUTRAL BROWN = LIVE As these colours may not correspond to the coloured markings identifying the terminals in your plug, proceed as follows:- The wire coloured BLUE must be connected to the terminal marked with the letter N or coloured BLUE or BLACK. The wire coloured BROWN must be connected to the terminal marked with the letter L or coloured BROWN or RED.

WARNING : DO NOT CONNECT EITHER WIRE TO THE EARTH TERMINAL WHICH IS MARKED WITH THE LETTER E OR BY THE EARTH SYMBOL , OR COLOURED GREEN OR GREEN AND YELLOW.

PRECAUTIONS

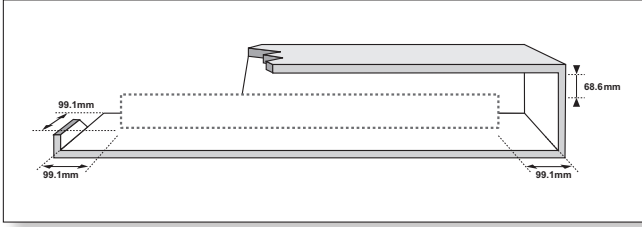

Ensure that the AC power supply in your house complies with the power requirements listed on the identification sticker located on the back of your product. Install your product horizontally, on a suitable base (furniture), with enough space around it for ventilation 7~10 cm. Make sure the ventilation slots are not covered. Do not place the unit on amplifiers or other equipment which may become hot. This unit is designed for continuous use. To fully turn off the unit, disconnect the AC plug from the wall outlet. Unplug the unit if you intend to leave it unused for a long period of time.

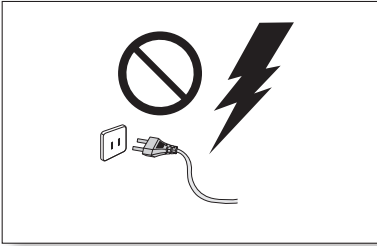

During thunderstorms, disconnect the AC plug from the wall outlet. Voltage peaks due to lightning could damage the unit.

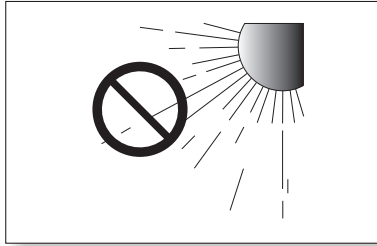

Do not expose the unit to direct sunlight or other heat sources.

This could lead to overheating and cause the unit to malfunction.

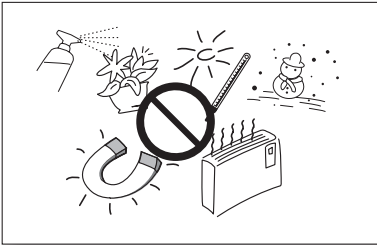

Protect the product from moisture (i.e. vases), and excess heat (e.g. a fireplace) or equipment creating strong magnetic or electric fields. Disconnect the power cable from the AC supply if the unit malfunctions. Your product is not intended for industrial use. It is for personal use only.

Condensation may occur if your product has been stored in cold temperatures. If transporting the unit during the winter, wait approximately 2 hours until the unit has reached room temperature before using.

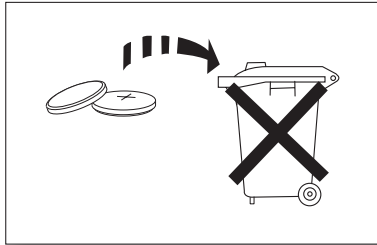

The batteries used with this product contain chemicals that are harmful to the environment. Do not dispose of batteries in the general household trash. A warning that batteries (battery pack or batteries installed) shall not be exposed to excessive heat such as sunshine, fire or the like. Do not short circuit, disassemble, or overheat the batteries. Danger of explosion if battery is incorrectly replaced. Replace only with the same or equivalent type.

CONTENTS

2 FEATURES

- 2 Licenses

3 SAFETY INFORMATION

- 3 Safety Warnings
- 4 Precautions

6 GETTING STARTED

- 6 Before reading the User's Manual
- 6 What's Included

7 DESCRIPTIONS

- 7 Top/Front Panel
- 8 Rear Panel

9 REMOTE CONTROL

- 9 Remote Control Buttons and Functions

11 CONNECTIONS

- 11 Installing the Wall Mount
- 12 Detaching the Wall Mount
- 12 Installing the bracket without referring to the Wall-mount Installation Guide
- 13 Connecting the Wireless Subwoofer
- 15 Connecting an External Device using an HDMI cable
- 16 Connecting an External Device using Audio (analogue) cable or Optical (digital) cable

17 FUNCTIONS

- 17 Input Mode
- 17 ARC (HDMI OUT)
- 18 Bluetooth
- 20 Using Samsung Audio Remote App
- 21 TV SoundConnect
- 22 USB
- 23 Software update

24 TROUBLESHOOTING

25 APPENDIX

- 25 Specifications



- Figures and illustrations in this User Manual are provided for reference only and may differ from actual product appearance.
- An administration fee may be charged if either
(a) an engineer is called out at your request and there is no defect with the product (i.e. where the user manual has not been read).
(b) you bring the unit to a repair centre and there is no defect with the product (i.e. where the user manual has not been read).
- You will be informed of the administration fee amount before a technician visits.

GETTING STARTED

BEFORE READING THE USER'S MANUAL

Note the following terms before reading the user manual.

► Icons used in this manual

Icon	Term	Definition
	Caution	Indicates a situation where a function does not operate or settings may be canceled.
	Note	Indicates tips or instructions on the page that help you operate a function.

► Safety Instructions and Troubleshooting

- 1) Be sure to familiarise yourself with the Safety Instructions before using this product. (See page 3)
- 2) If a problem occurs, check Troubleshooting. (See page 24)







► Copyright

©2015 Samsung Electronics Co.,Ltd.

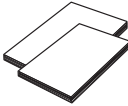
All rights reserved; no part of this user's manual may be reproduced or copied without the prior written permission of Samsung Electronics Co.,Ltd.

WHAT'S INCLUDED

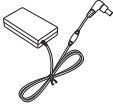
Check for the supplied accessories shown below.

		
Remote Control / Lithium Battery (3V : CR2032)	User Manual / Quick Guide	(Wall Mount L: 1EA) (Wall Mount R: 1EA) Bracket-Wall Mount
		
Wall Mount Guide	(Holder-screw1: 2EA) (Holder-screw2: 2EA) Holder-Screw	Power Cord:2EA
		
DC Adapter	Optical cable	USB Cable



- The appearance of the accessories may differ slightly from the illustrations above.
- Use the dedicated USB cable to connect external USB devices to the unit.

DESCRIPTIONS

TOP/FRONT PANEL

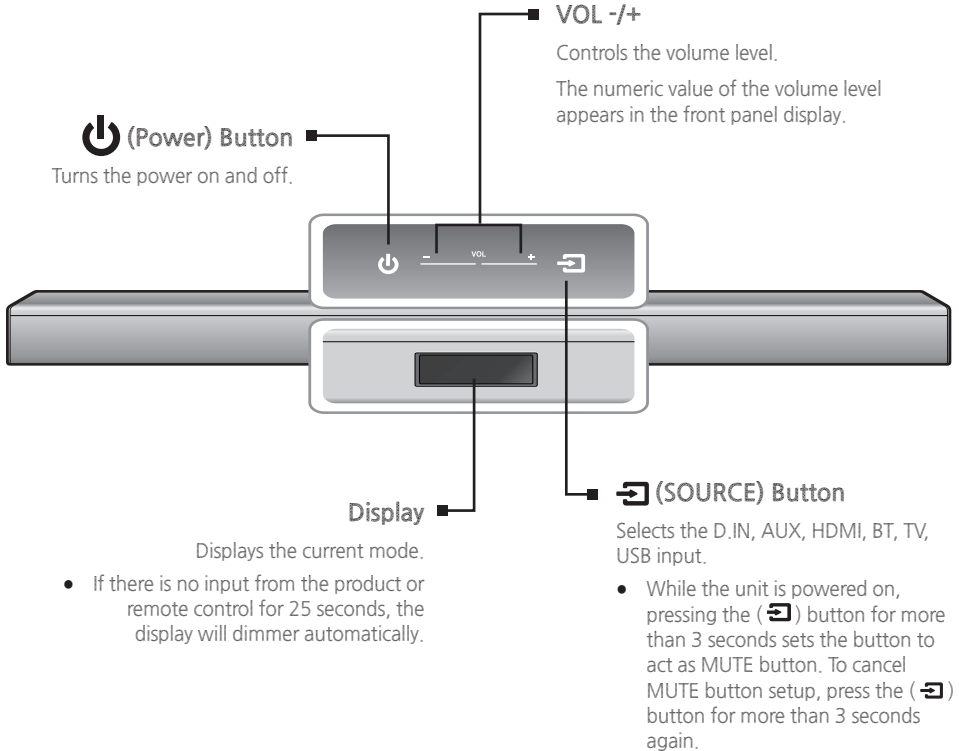

- When you turn on this unit, there will be a 4 to 5 second delay before it produces sound.
- If you want to enjoy the sound only from the Soundbar, you must turn off the TV's speakers in the Audio Setup menu of your TV. Refer to the owner's manual supplied with your TV.

REAR PANEL

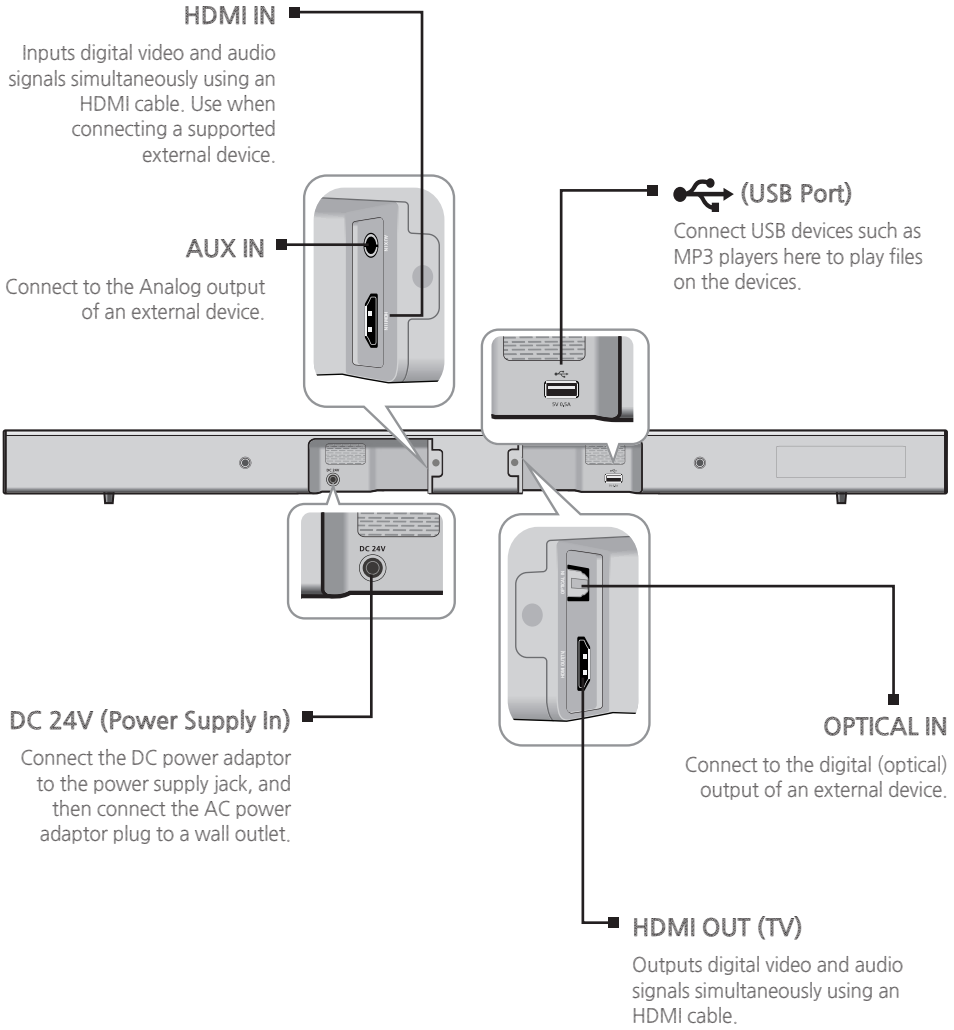

- !**
- When disconnecting the power cable of the AC power adaptor from the wall outlet, pull the plug. Do not pull the cable.
 - Do not connect this unit or other components to an AC outlet until all connections between components are complete.

REMOTE CONTROL

REMOTE CONTROL BUTTONS AND FUNCTIONS

SOURCE
Press to select a source connected to the Soundbar.

MUTE
You can turn the volume down to 0 with the push of a button. Press again to restore the sound to the previous volume level.

REPEAT
Press to set the REPEAT function during music playback from a USB device.
OFF-REPEAT : Cancels Repeat Playback.
TRACK-REPEAT : Repeatedly play a track.
ALL-REPEAT : Repeatedly play all tracks.
RANDOM-REPEAT : Plays tracks in random order. (A track that has already been played may be played again.)

Skip Forward
If there is more than one file on the device you are playing, and you press the ►►► button, the next file is selected.

SOUND CONTROL (*Use the ◀◀◀, ▶▶▶ buttons to adjust level.)
Press to select **TREBLE**, **BASS**, or **AUDIO SYNC**. Then, use the ◀◀◀, ▶▶▶ buttons to adjust the Treble, Bass volume from -6 to +6.
If the Soundbar is connected to a digital TV and the video appears out of sync with the audio, press the **SOUND CONTROL** button to sync the audio with the video. Use the ◀◀◀, ▶▶▶ buttons to set the audio delay between 0 ms and 300 ms. In USB mode, TV mode, and BT mode, the Audio Sync function may not work.
Press and hold the **SOUND CONTROL** button for about 5 seconds to adjust the sound for each frequency band. 150Hz, 300Hz, 600Hz, 1.2KHz, 2.5KHz, 5KHz and 10KHz are selectable and each can be adjusted to a setting between -6 and +6.

AUTO POWER
Auto Power Link: Synchronizes the Soundbar to a connected Optical source via the Optical jack so it turns on automatically when you turn on your TV.
(Auto Power Link : Default OFF, ON-Anynet+ / OFF-POWER LINK or OFF-Anynet+ / ON-POWER LINK). The Anynet+ function lets you control the Soundbar with the remote from an Anynet+ compatible Samsung TV. The Soundbar must be connected to the TV via an HDMI cable.
* Anynet+: Press the **AUTO POWER** button to turn the Anynet+ function on or off.

WOOFER (*Use the ◀◀◀, ▶▶▶ button to adjust volume)
You can control the woofer volume.
Press the ◀◀◀, ▶▶▶ button to increase or decrease the subwoofer volume. You can select SW (-12, -6, -5, -4, -3, -2, -1, 0, +1, +2, +3, +4, +5, +6).



- Soundbar is a Samsung proprietary name.
- Operate the TV using the TV's remote control.

POWER
Turns the Soundbar on and off.

VOLUME
Adjusts the volume level of the unit.

Play/Pause
Press the ►|| button to pause playing the file temporarily.
Press the ►|| button again to play the selected file.

Skip Back
If there is more than one file on the device you are playing, and you press the ◀◀ button, the previous file is selected.

SOUND EFFECT
You can select different sound modes - **STANDARD, MUSIC, VOICE, SPORTS, CINEMA, and NIGHT MODE** - depending on the type of sources you want to enjoy.
Press the **SOUND EFFECT** button on the remote control.
Select the **STANDARD** mode if you want to enjoy the original sound.
* Night Mode
This will regulate and stabilize the volume level against a drastic volume change caused by a channel change or scene transition.

Bluetooth POWER
Press the **Bluetooth POWER** button on the remote to turn the Bluetooth POWER on function on and off.
See pages 19 and 21 for details.

SOUND
Press the **SOUND** button on the remote to add depth and spaciousness to the sound.
Press the **SOUND** on the remote control.
Each time the button is pressed, the selection changes as follows :
ON-SURROUND SOUND → OFF-SURROUND SOUND

► **Installing the Battery in the Remote Control**

1. Use a suitable coin to turn the remote control's battery cover counterclockwise to remove it as shown in the figure above.
2. Insert a 3V lithium battery. Keep the positive (+) pole facing up when inserting the battery. Put the battery cover on and align the '●' marks side by side as shown in the figure above.
3. Use a suitable coin to turn the remote control battery cover clockwise as far as it will go to fix it in place.

CONNECTIONS

INSTALLING THE WALL MOUNT

You can use the wall mount bracket to mount this unit on a wall.

► Installation Precautions

- Install on a vertical wall only.
- For the installation, avoid a location with high temperature or humidity, or a wall that cannot sustain the weight of the set.
- Check the strength of the wall. If the wall is not strong enough to support the unit, reinforce the wall or install the unit on a different wall that can support the unit's weight.
- Purchase and use the fixing screws or anchors appropriate for the kind of wall you have (plaster board, iron board, wood, etc.). If possible, fix the support screws into wall studs.
- Purchase wall mounting screws according to the type and thickness of the wall you will mount the Soundbar on.
 - Diameter : M5
 - Length: L 35 mm or longer recommended

- Connect cables from the unit to external devices before you install it on the wall.
- Make sure the unit is turned off and unplugged before you install it. Otherwise, it may cause an electric shock.

1. Place the installation guide against the wall surface.
 - The installation guide must be level.
 - Install at least 5 cm below the TV, if the TV is mounted on the wall.
2. Mark the location where the screws will go through on the wall using a pen, and then remove the installation guide.
3. Fasten the wall mounts and screws to the marked locations.
 - The left and right mounts are different shapes.
4. Secure the two holder screws to the screw holes on the back of the Soundbar's main body, one on the left and one on the right.
5. Insert the USB cable into the back of the Soundbar before installing it on the wall.
6. Set the holder screws on the back of the Soundbar into the grooves of the wall mount. For safe installation, make sure to push the holder screws all the way to the bottom of the grooves.

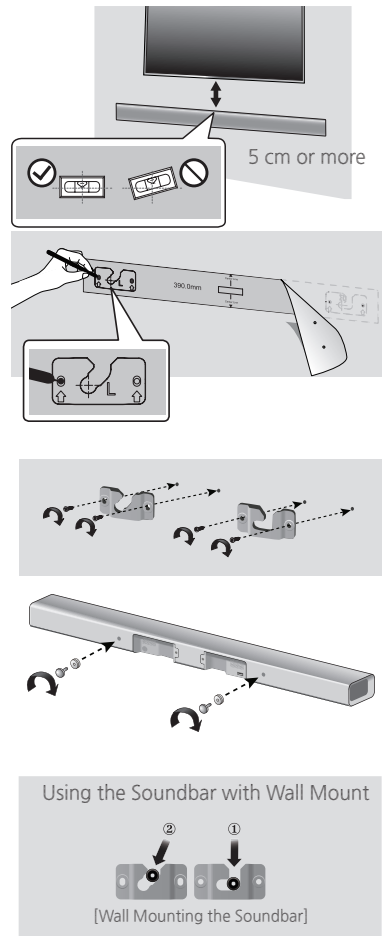

DETACHING THE WALL MOUNT

1. Pull the Soundbar upwards as shown in the figure to separate it from the wall mount.

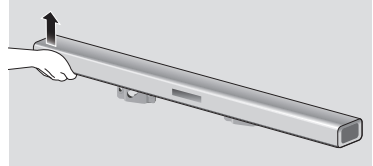

Using the Soundbar with Wall Mount

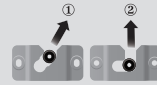

[Detaching the Soundbar from the Wall Mount]



- Do not hang onto the installed unit and avoid striking or dropping the unit.
- Secure the unit firmly to the wall so that it does not fall off. If the unit falls off, it may cause an injury or damage the product.
- When the unit is installed on a wall, please make sure that children do not pull any of the connecting cables, as it may cause it to fall.
- For the optimal performance of a wall mount installation, install the speaker system at least 5 cm below the TV, if the TV is mounted on the wall.
- For your safety, if you do not mount the unit on the wall, install it on a secure, flat surface where it is unlikely to fall.

INSTALLING THE BRACKET WITHOUT REFERRING TO THE WALL-MOUNT INSTALLATION GUIDE

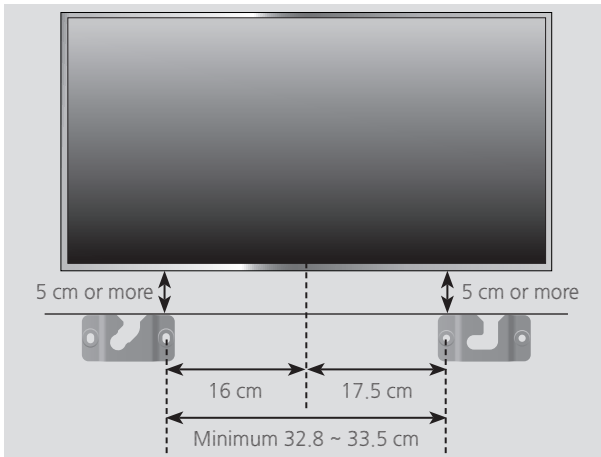

1. Place the "Wall Mount L" on the desired wall surface while paralleled to the floor as shown above, and fix a screw through the hole on its right end.
2. Place the "Wall Mount R" on the desired wall surface while paralleled to the floor as shown above, and fix a screw through the hole on its left end.
 - If Wall Mount L/R are to be mounted beneath the TV, check their fixing hole positions in steps 1 and 2, so that they are aligned appropriately to the center of the TV's bottom.
3. Fix screws through the rest of holes.

CONNECTING THE WIRELESS SUBWOOFER

The Subwoofer's linking ID is preset at the factory and the main unit and subwoofer should link (connect wirelessly) automatically when the main unit and subwoofer are turned on. If the Link indicator () does not light when the main unit and subwoofer are turned on, please set the ID by following the procedure below.

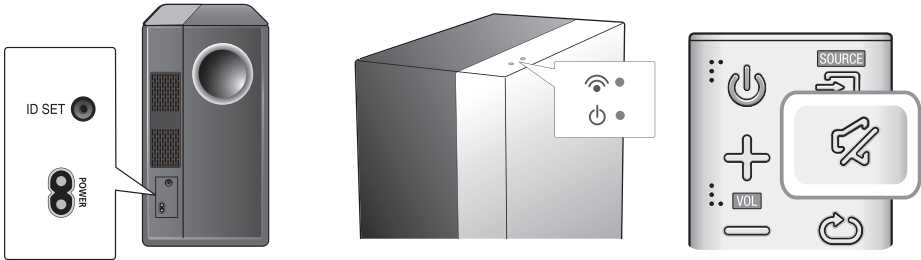

1. Plug the power cords of the main unit and subwoofer into an AC wall outlet.
2. Press the **ID SET** button on the back of the subwoofer with a small, pointed object for 5 seconds.
 - The **STANDBY** indicator is turned off and the **LINK** indicator (Blue LED) blinks quickly.
3. While the main unit is powered off (in **STANDBY** mode), press and hold the **MUTE** () on the remote control for 5 seconds.
4. The **ID SET** message appears on the Soundbar's display.
5. To finalize the link, turn the main unit's power on while the subwoofer's Blue LED blinks.
 - The main unit and the subwoofer should now be linked (connected).
 - The Link indicator (Blue LED) on the subwoofer should be on.
 - If the Link indicator is not solid blue, the linking process has failed. Turn off the main unit and start again from Step 2.
 - You can enjoy better sound from the wireless subwoofer by selecting a Sound Effect. (See page 10)



- Before moving or installing the product, be sure to turn off the power and disconnect the power cord.
 - If the main unit is powered off, the wireless subwoofer will be in standby mode and the STANDBY LED on the upper side will come on after the Link indicator (Blue LED) blinks for 30 seconds.
 - If you use a device that uses the same frequency (2.4GHz) as the Soundbar near the Soundbar, interference may cause some sound interruption.
 - The transmission distance of the wireless signal between the main unit and subwoofer is about 10 m, but may vary depending on your operating environment.
If a steel-concrete or metallic wall is between the main unit and the wireless subwoofer, the system may not operate at all, because the wireless signal cannot penetrate metal.
 - If the main unit doesn't make a wireless connection, follow steps 1-5 to re-set the connection between the main unit and wireless subwoofer.
-



- The wireless receiving antenna is built into the wireless subwoofer. Keep the unit away from water and moisture.
 - For optimal listening performance, make sure that the area around the wireless subwoofer location is clear of any obstructions.
-

CONNECTING AN EXTERNAL DEVICE USING AN HDMI CABLE

HDMI is the standard digital interface for connecting to such TVs, projectors, DVD players, Blu-ray players, set top boxes, and more.

Because HDMI transmits the highest quality digital signal, you can enjoy superior video and audio - as it was originally created at the digital source.

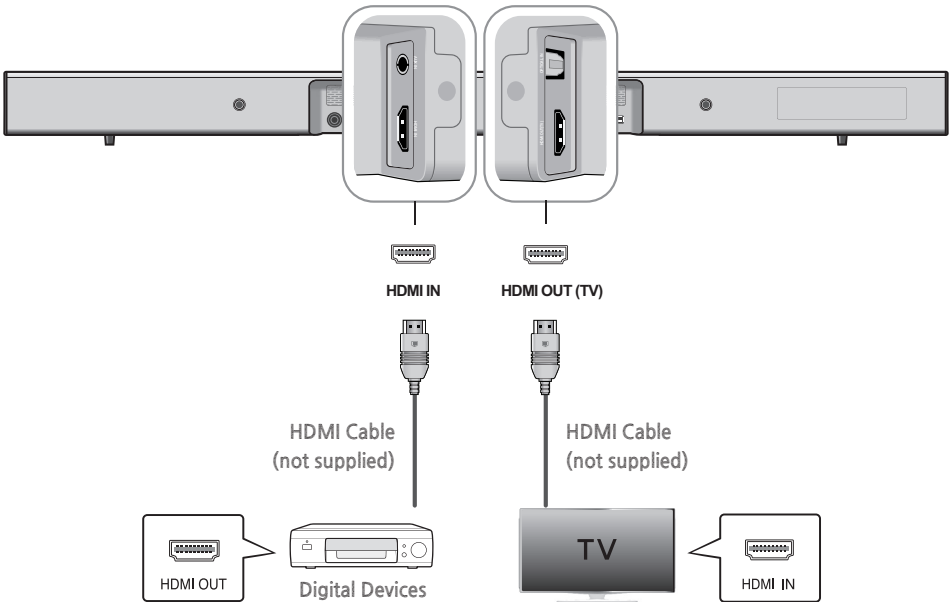

HDMI IN

Connect an HDMI cable (not supplied) from the **HDMI IN** jack on the back of the product to the HDMI OUT jack on your digital device.

and,

HDMI OUT (TV)

Connect an HDMI cable (not supplied) from the **HDMI OUT (TV)** jack on the back of the product to the HDMI IN jack on your TV.



- HDMI is an interface that enables the digital transmission of video and audio data with just a single connector.

ARC (HDMI OUT)

The ARC function allows digital audio to output via the **HDMI OUT (ARC)** port.

It can be enabled only when the Soundbar is connected to a TV that supports the ARC function.



- Anynet+ must be turned on.
- This function is not available if the HDMI cable does not support ARC.

CONNECTING AN EXTERNAL DEVICE USING AUDIO (ANALOGUE) CABLE OR OPTICAL (DIGITAL) CABLE

This unit comes equipped with one optical in digital jack and one audio Analogue in jack, giving you two ways to connect it to a TV.

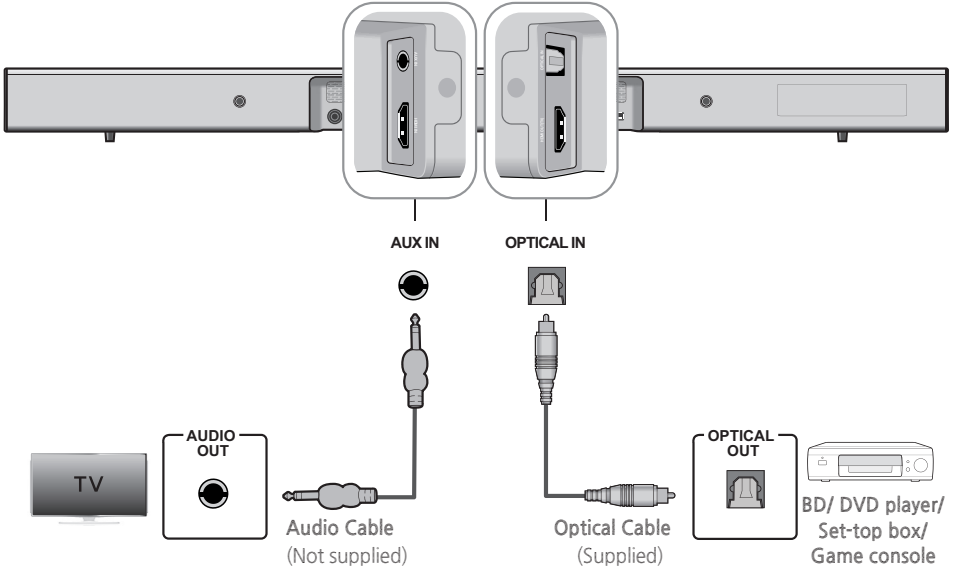

AUX IN

Connect **AUX IN** (Audio) on the main unit to the **AUDIO OUT** jack of the TV or Source Device. Change the function to **AUX**.

or,

OPTICAL IN



Connect **OPTICAL IN** (Audio) on the main unit to the **OPTICAL OUT** jack of the TV or Source Device. Change the function to **D.IN**.



- Do not connect the power cord of this product or your TV to the wall outlet until all connections between components are complete.
- Before moving or installing this product, be sure to turn off the power and disconnect the power cord.

FUNCTIONS

INPUT MODE

Press the  button on the main unit's top panel or the  (SOURCE) button on the remote control to select the mode you want.



Input mode	Display
Optical Digital input	D.IN
AUX input	AUX
HDMI input	HDMI
BLUETOOTH mode	BT
TV SoundConnect	TV
USB mode	USB



The unit turns off automatically in the following situations.

- D.IN/HDMI/BT/TV/USB Mode
 - If there is no audio signal for 25 minutes.
- AUX Mode
 - If the AUX cable is disconnected for 25 minutes.
 - In Auto Power Down ON mode, if there is no KEY input for 8 hours when the AUX cable is connected.
 - To turn the Auto Power Down function ON or OFF, press and hold the  button for 5 seconds. OFF/ ON-AUTO POWER DOWN appears on the display.

ARC (HDMI OUT)

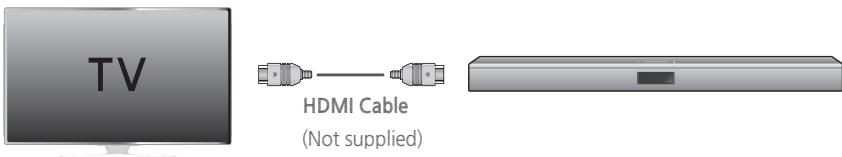
ARC (Audio Return Channel) transfers digital audio signal to the HDMI OUT (ARC) port.



1. Connect the TV supporting ARC to the Soundbar with an HDMI cable.
2. Turn on the TV, and turn on the Soundbar's Anynet+.
3. Press the  button on the main unit's top panel or the  (SOURCE) button on the remote control to select the **D.IN** mode.



- If the HDMI cable does not support ARC feature, ARC may not work properly.
- To turn off the ARC function, turn Anynet+ off.



BLUETOOTH

You can connect a Bluetooth device to the Soundbar and enjoy music with high quality stereo sound, all without wires!

► To connect the Soundbar to a Bluetooth device

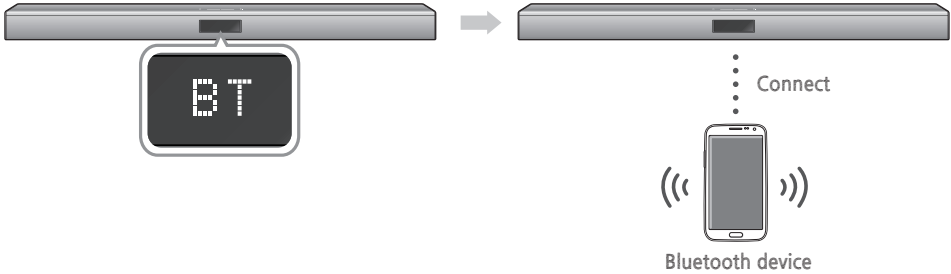
Check if the Bluetooth device supports the Bluetooth compliant stereo headset function.



- Press the  button on the main unit's top panel or the  (SOURCE) button on the remote control to select the BT mode.
 - You will see **BT READY** on the front display of the Soundbar.
- Select the Bluetooth menu on the Bluetooth device you want to connect. (Refer to the Bluetooth device's user manual.)
- Select the Stereo headset menu on the Bluetooth device.
 - You will see a list of scanned devices.
- Select "[Samsung] Soundbar J-Series" from the list.
 - When the Soundbar is connected to the Bluetooth device, it will display **[Bluetooth device name] → BT** on the front display.
 - The device name can only be displayed in English. An underline " _ " will be displayed if the name is not in English.
 - If the Bluetooth device has failed to pair with the Soundbar, delete the previous "[Samsung] Soundbar J-Series" found by the Bluetooth device and have it search for the Soundbar again.
- Play music on the connected device.
 - You can listen to the music playing on the connected Bluetooth device over the Soundbar.
 - In BT mode, the Play/Pause/Next/Prev functions are not available. However, these functions are available in Bluetooth devices supporting AVRCP.



- If asked for PIN code when connecting a Bluetooth device, enter <0000>.
- Only one Bluetooth device can be paired at a time.
- The Bluetooth connection will be terminated when you turn the Soundbar off.
- The Soundbar may not perform Bluetooth search or connection correctly under the following circumstances:
 - If there is a strong electrical field around the Soundbar.
 - If several Bluetooth devices are simultaneously paired with the Soundbar.
 - If the Bluetooth device is turned off, not in place, or malfunctions.
 - Note that such devices as microwave ovens, wireless LAN adaptors, fluorescent lights, and gas stoves use the same frequency range as the Bluetooth device, which can cause electric interference.
- The Soundbar supports SBC data (44.1kHz, 48kHz).
- Connect only to a Bluetooth device that supports the A2DP (AV) function.
- You cannot connect the Soundbar to a Bluetooth device that supports only the HF (Hands Free) function.
- Once paired the device, on D.IN/AUX/HDMI/USB mode, select "[Samsung] Soundbar J-Series" from the list will automatically change to BT mode.

▶ Bluetooth POWER on (Bluetooth POWER)

When the Bluetooth Power On function is on and the Soundbar is turned off, if a previously paired Bluetooth device tries to pair with the Soundbar, the Soundbar turns on automatically.

1. Press the **Bluetooth POWER** on the remote while the Soundbar is turned on.
2. ON-Bluetooth POWER appears on the Soundbar's display.



- Available only if the Soundbar is listed among the Bluetooth device's paired devices. (The Bluetooth device and the Soundbar must have been previously paired at least once.)
- Soundbar will appear in the Bluetooth device's searched devices list only when the Soundbar is displaying [BT READY].
- In the TV SoundConnect mode, the Soundbar cannot be paired to another Bluetooth device.

▶ To disconnect the Bluetooth device from the Soundbar

You can disconnect the Bluetooth device from the Soundbar. For instructions, see the Bluetooth device's user manual.

- The Soundbar will be disconnected.
- When the Soundbar is disconnected from the Bluetooth device, the Soundbar will display **BT DISCONNECTED** on the front display.

▶ To disconnect the Soundbar from the Bluetooth device

Press the  (SOURCE) button on the remote control or the  button on the product's top panel to switch from BT to another mode or turn off the Soundbar.

- The connected Bluetooth device will wait a certain amount of time for a response from the Soundbar before terminating the connection. (Disconnection time may differ, depending on the Bluetooth device)



- In Bluetooth connection mode, the Bluetooth connection will be lost if the distance between the Soundbar and the Bluetooth device exceeds 5m.
- The Soundbar automatically turns off after 25 minutes in the Ready state.

More About Bluetooth

Bluetooth is a technology that enables Bluetooth-compliant devices to interconnect easily with each other using a short wireless connection.

- A Bluetooth device may cause noise or malfunction, depending on usage, when:
 - A part of your body is in contact with the receiving/transmitting system of the Bluetooth device or the Soundbar.
 - It is subject to electrical variation from obstructions caused by a wall, corner, or office partition.
 - It is exposed to electrical interference from same frequency-band devices including medical equipment, microwave ovens, and wireless LANs.
- Pair the Soundbar with the Bluetooth device while they are close together.
- The further the distance between the Soundbar and Bluetooth device, the worse the quality is. If the distance exceeds the Bluetooth operational range, the connection is lost.
- In poor reception areas, the Bluetooth connection may not work properly.
- The Bluetooth connection only works when it is close to the unit. The connection will be automatically cut off if the Bluetooth device is out of range. Even within range, the sound quality may be degraded by obstacles such as walls or doors.
- This wireless device may cause electric interference during its operation.

USING SAMSUNG AUDIO REMOTE APP

Install Samsung Audio Remote App

To control the product with your Smart Device via the Samsung Audio Remote app, download the Samsung Audio Remote App by accessing the app through Google Play store.

Market search :
Samsung Audio Remote



Accessing the Samsung Audio Remote App

After you install the Samsung Audio Remote app, follow the instructions in the app.

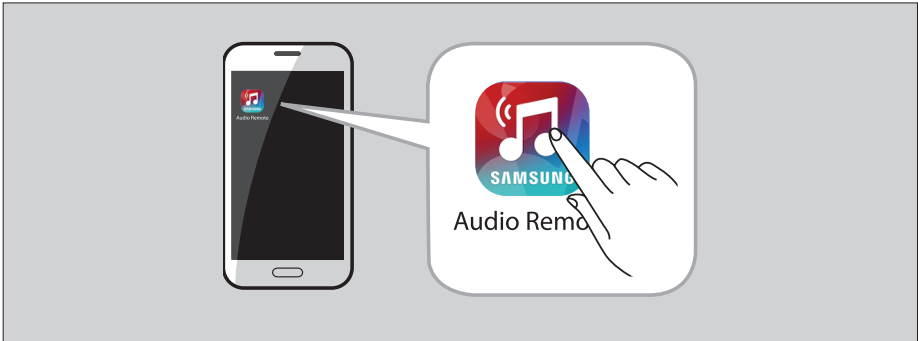

- The APP function only supports Android mobile phone devices running Android OS 3.0 or later.

TV SOUNDCONNECT

You can enjoy TV sound through your Soundbar when it is connected to a Samsung TV that supports the TV SoundConnect function.

► Connecting a TV to the Soundbar



1. Turn on the TV and Soundbar.
 - Turn on the menu of the TV.
 - Move to Speaker Settings on "Sound" tab.
 - Set the "Add New Device" menu to "On".
2. Press the button on the main unit's top panel or the (SOURCE) button on the remote control to select the TV mode.
3. On the TV, a message asking whether to enable the TV SoundConnect function. "[Samsung] Soundbar" is displayed on the TV screen.
4. Select <Yes> to finish connecting the TV and Soundbar by TV remote control.



- Switching the Soundbar's mode from TV to another mode automatically terminates TV SoundConnect.
- To connect the Soundbar to another TV, the existing connection must be terminated.
- Terminate the connection to the existing TV, and then press the button on the remote control for 5 seconds to connect to another TV.



- The TV SoundConnect (SoundShare) function is supported by some Samsung TVs released from 2012 on. Check whether your TV supports the TV SoundConnect (SoundShare) function before you begin. (For further information, refer to the TV's user manual.)
- If your Samsung TV was released before 2014, check the SoundShare setting menu.

- If the distance between the TV and Soundbar exceeds 5 m, the connection may not be stable or the audio may stutter. If this occurs, relocate the TV or Soundbar so that they are within operational range, and then re-establish the TV SoundConnect connection.



- TV SoundConnect Operational Ranges:
 - Recommended pairing range: within 50 cm
 - Recommended operational range: within 5 m
- The **Play/Pause**, **Next**, **Prev** buttons are not operable in TV SoundConnect mode.

► Using the Bluetooth POWER On function

The Bluetooth POWER On function is available after you have successfully connected the Soundbar to a Bluetooth compatible TV using TV SoundConnect. When the Bluetooth POWER On function is ON, turning the connected TV on or off will turn the Soundbar's power on and off as well.

1. Connect the TV to your Soundbar using the TV SoundConnect function.
2. Press the **Bluetooth POWER** button on the Soundbar remote. "ON/OFF-BLUETOOTH POWER" appears on the Soundbar's display.
 - ON-BLUETOOTH POWER : The Soundbar turns on and off when you turn the TV on or off.
 - OFF-BLUETOOTH POWER : The Soundbar only turns off when you turn the TV off.





- This function is supported by some Samsung TVs released from 2013 on.

USB

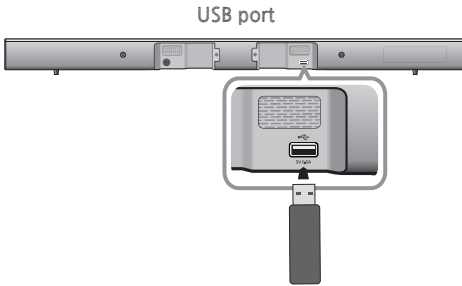
You can play music files located on USB storage devices through the Soundbar.



1. Connect the USB device to the USB port of the product.
2. Press the  button on the main unit's top panel or the  (SOURCE) button on the remote control to select the **USB** mode.
3. **USB** appears on the display screen.
 - The Soundbar connection to the USB device is complete.
 - The Soundbar automatically turns off (Auto Power Off) if no USB device has been connected for more than 25 minutes.

- Do not connect multiple storage devices to the product via a multi-card reader. It may not operate properly.
- Digital camera PTP protocols are not supported.
- Do not remove the USB device while it is transferring files.
- DRM-protected music files (MP3, WMA) from commercial web sites cannot be played.
- External HDDs are not supported.
- Mobile phone devices are not supported.
- File Format Type Compatibility list:

► Before you connect a USB device

Be aware of the following:

- If the file name of a folder on a USB device exceeds 10 characters, it is not displayed on the Soundbar's display.
- This product may not be compatible with certain types of USB storage media.
- The Soundbar supports the FAT16 and FAT32 file systems.
 - The NTFS file system is not supported.
- Connect USB devices directly to the USB port of the product. Otherwise, you may encounter a USB compatibility problem.

Format	Codec	Sampling Rate	Bitrate
*.mp3	MPEG 1 Layer2	16KHz ~ 48KHz	80kbps~320kbps
	MPEG 1 Layer3		
	MPEG 2 Layer3		
	MPEG 2.5 Layer3		
*.wma	Wave_Format_MSAudio1	16KHz ~ 48KHz	56kbps~128kbps
	Wave_Format_MSAudio2		
*.aac	AAC	16KHz ~ 96KHz	48kbps~320kbps
	AAC-LC	16KHz ~ 96KHz	128kbps~192kbps
	HE-AAC	24KHz ~ 96KHz	48kbps~64kbps
*.wav	-	16KHz ~ 48KHz	up to 3000kbps
*.ogg	OGG 1.1.0	16KHz ~ 48KHz	50kbps~500kbps
*.flac	FLAC 1.1.0,	16KHz ~ 96KHz	up to 3000kbps
	FLAC 1.2.1		

SOFTWARE UPDATE

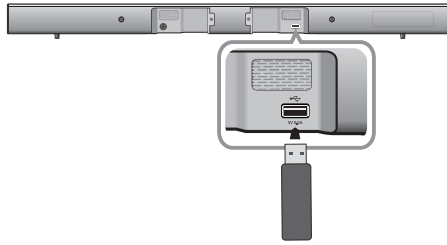

Samsung may offer updates for the Soundbar's system firmware in the future.

If an update is offered, you can update the firmware by connecting a USB device with the firmware update stored on it to the USB port on your Soundbar.

Note that if there are multiple update files, you must load them onto the USB device singly and use them to update the firmware one file at a time.

Please visit Samsung.com or contact the Samsung call center to receive more information about downloading updates files.



- The product has the DUAL BOOT function, if the firmware fails to update, you can update the firmware again.



- Insert a USB device containing the firmware update into the USB port on the main unit.
- Updating firmware may not work properly if audio files supported by the Soundbar are stored in the USB storage device.
- Do not disconnect the power or remove the USB device while updates are being applied. The main unit will turn off automatically after completing the firmware update.
- After reset, all settings are reset to their factory default settings. We recommend you write down your settings so that you can easily reset them after the update. Note that updating firmware resets subwoofer connection too. If connection to the subwoofer is not established automatically after resetting, refer to page 13. If the firmware fails to update, we recommend formatting the USB device in FAT16 and trying again.
- Once the software update is completed, turn off the product and then press and hold the (▶||) button on the remote control for more than 5 seconds. "INIT" appears on the display and the unit is powered off. The update is complete.
- Do not format the USB device in the NTFS format. The Soundbar does not support the NTFS file system.
- Depending on the manufacturer, some USB devices may not be supported.

TROUBLESHOOTING

Before requesting service, please check the following.

The unit will not turn on.	
• Is the power cord plugged into the outlet?	→ Connect the power plug to the outlet.
A function does not work when the button is pressed.	
• Is there static electricity in the air?	→ Disconnect the power plug and connect it again.
Sound is not produced.	
• Is the Mute function on?	→ Press the Mute button to cancel the function.
• Is the volume set to minimum?	→ Adjust the Volume.
The remote control does not work.	
• Are the batteries drained?	→ Replace with new batteries.
• Is the distance between the remote control and main unit too far?	→ Move closer to the unit.
The TV SoundConnect (TV pairing) failed.	
• Does your TV support TV SoundConnect?	→ TV SoundConnect is supported by some Samsung TVs released from 2012 on. Check your TV to see if it supports TV SoundConnect.
• Is your TV firmware the latest version?	→ Update your TV with the latest firmware.
• Does an error occur when connecting?	→ Contact the Samsung call center.
• Reset the TV MODE and connect again.	→ Press and hold the ► button for 5 seconds to reset the TV SoundConnect connection.
The red LED on the subwoofer blinks and the subwoofer is not producing sound.	
• Your subwoofer may not be connected to the main body of the product.	→ Try to connect your subwoofer again. (See Page 13)
The subwoofer drones and vibrates noticeably.	
• Try to adjust the vibration of your subwoofer.	→ Press the WOOFER button on your remote control to adjust its value (between SW-12 and SW+6).

APPENDIX

SPECIFICATIONS

Model name	HW-J450		
GENERAL	USB		5V/0.5A
	Weight	Main Unit	1.62 kg
		Subwoofer	4.6 kg
	Dimensions (W x H x D)	Main Unit	957.5 x 59.5 x 66.5 mm
		Subwoofer	179 x 361 x 299.5 mm
	Operating Temperature Range		+5 °C to +35 °C
	Operating Humidity Range		10 % to 75 %
AMPLIFIER	Rated Output Power	Main Unit	80W/CH, 3 OHM, THD = 10%, 1kHz
		Subwoofer	140W, 3 OHM, THD = 10%, 70Hz
	S/N Ratio (Analogue Input)		65 dB
	Separation (1kHz)		65 dB

- * S/N ratio, distortion, separation, and usable sensitivity are based on measurements using AES (Audio Engineering Society) guidelines.
- * Nominal specification
 - Samsung Electronics Co., Ltd reserves the right to change the specifications without notice.
 - Weight and dimensions are approximate.
 - For the power supply and Power Consumption, refer to the label attached to the product.

※ Open Source License Notice

- For further information on Open Sources used in this product, please visit the website:
<http://opensource.samsung.com>
- To send inquiries and requests regarding open sources, contact Samsung via Email
(oss.request@samsung.com).



Hereby, Samsung Electronics, declares that this equipment is in compliance with the essential requirements and other relevant provisions of Directive 1999/5/EC.

The original Declaration of Conformity may be found at <http://www.samsung.com>, go to Support > Search Product Support and enter the model name.

This equipment may be operated in all EU countries.



Contact SAMSUNG WORLD WIDE

If you have any questions or comments relating to Samsung products, please contact the SAMSUNG customer care Centre.

Area	Contact Centre ☎	Web Site
Europe		
AUSTRIA	0800 - SAMSUNG (0800 - 7267864)	www.samsung.com/at/support
BELGIUM	02-201-24-18	www.samsung.com/be/support (Dutch) www.samsung.com/be_fr/support (French)
BOSNIA	051 331 999	www.samsung.com/support
BULGARIA	07001 33 11 , sharing cost	www.samsung.com/bg/support
CROATIA	062 726 786	www.samsung.com/hr/support
CZECH	800 - SAMSUNG (800-726786)	www.samsung.com/cz/support
DENMARK	70 70 19 70	www.samsung.com/dk/support
FINLAND	030-6227 515	www.samsung.com/fi/support
FRANCE	01 48 63 00 00	www.samsung.com/fr/support
GERMANY	0180 6 SAMSUNG bzw. 0180 6 7267864* (*0,20 €/Anruf aus dem dt. Festnetz, aus dem Mobilfunk max. 0.60 €/Anruf)	www.samsung.com/de/support
CYPRUS	8009 4000 only from landline, toll free	
GREECE	80111-SAMSUNG (80111 726 7864) only from land line (+30) 210 6897691 from mobile and land line	www.samsung.com/gr/support
HUNGARY	0680SAMSUNG (0680-726-786) 0680PREMIUM (0680-773-648)	http://www.samsung.com/hu/support
ITALIA	800-SAMSUNG (800.7267864)	www.samsung.com/it/support

Area	Contact Centre ☎	Web Site
LUXEMBURG	261 03 710	www.samsung.com/support
MONTENEGRO	020 405 888	www.samsung.com/support
SLOVENIA	080 697 267 090 726 786	www.samsung.com/si/support
NETHERLANDS	0900-SAMSUNG (0900-7267864) (€ 0,10/Min)	www.samsung.com/nl/support
NORWAY	815 56480	www.samsung.com/no/support
POLAND	0 801-172-678* lub +48 22 607-93-33 ** * (całkowity koszt połączenia jak za 1 impuls według taryfy operatora) ** (koszt połączenia według taryfy operatora)	www.samsung.com/pl/support
PORTUGAL	808 20 7267	www.samsung.com/pt/support
ROMANIA	08008 SAMSUNG (08008 726 7864) TOLL FREE No.	www.samsung.com/ro/support
SERBIA	011 321 6899	www.samsung.com/rs/support
SLOVAKIA	0800 - SAMSUNG(0800-726 786)	www.samsung.com/sk/support
SPAIN	0034902172678	www.samsung.com/es/support
SWEDEN	0771 726 7864 (SAMSUNG)	www.samsung.com/se/support
SWITZERLAND	0848 726 78 64 (0848-SAMSUNG)	www.samsung.com/ch_fr/support (German) www.samsung.com/fr/support (French)
U.K	0330 SAMSUNG (7267864)	www.samsung.com/uk/support
EIRE	0818 717100	www.samsung.com/ie/support
LITHUANIA	8-800-777777	www.samsung.com/lt/support
LATVIA	8000-7267	www.samsung.com/lv/support
ESTONIA	800-7267	www.samsung.com/ee/support



[Correct disposal of batteries in this product]

(Applicable in countries with separate collection systems)

This marking on the battery, manual or packaging indicates that the batteries in this product should not be disposed of with other household waste at the end of their working life. Where marked, the chemical symbols Hg, Cd or Pb indicate that the battery contains mercury, cadmium or lead above the reference levels in EC Directive 2006/66.

If batteries are not properly disposed of, these substances can cause harm to human health or the environment.

To protect natural resources and to promote material reuse, please separate batteries from other types of waste and recycle them through your local, free battery return system.



Correct Disposal of This Product
(Waste Electrical & Electronic Equipment)

(Applicable in countries with separate collection systems)

This marking on the product, accessories or literature indicates that the product and its electronic accessories (e.g. charger, headset, USB cable) should not be disposed of with other household waste at the end of their working life. To prevent possible harm to the environment or human health from uncontrolled waste disposal, please separate these items from other types of waste and recycle them responsibly to promote the sustainable reuse of material resources.

Household users should contact either the retailer where they purchased this product, or their local government office, for details of where and how they can take these items for environmentally safe recycling.

Business users should contact their supplier and check the terms and conditions of the purchase contract. This product and its electronic accessories should not be mixed with other commercial wastes for disposal.

