



# TX-RZ900/TX-RZ800

## AV RECEIVER

[The Basic Manual](#) includes information needed when starting up and also instructions for frequently used operations. [The Advanced Manual](#) has more detailed information and advanced settings.

# Basic Manual

### CONTENTS

Front Panel.....	3		
Display.....	4		
Rear Panel.....	5		
<b>Step 1: Connections.....</b>	<b>6</b>		
1 Connecting speakers.....	6		
• Speaker layout.....	6		
• Height speaker types.....	7		
• Instructions on how to connect speakers.....	8		
2 Connecting the TV and players.....	9		
• HDMI cable connection.....	9		
• Connecting Components without HDMI.....	10		
3 Other connections.....	11		
<b>Step 2: Initial Setup.....</b>	<b>12</b>		
1 AccuEQ Room Calibration.....	12		
2 Source Connection.....	13		
3 Remote Mode Setup.....	14		
4 Network Connection.....	14		
<b>Step 3: Playing Back.....</b>	<b>16</b>		
1 Basic operations.....	16		
• Remote controller parts name.....	16		
2 Network Functions.....	17		
3 AirPlay®.....	17		
4 BLUETOOTH® function.....	18		
5 AM/FM Radio.....	18		
6 Multi-zone.....	19		
• Making Multi-zone Connection.....	19		
• Performing Multi-zone Playback.....	20		
7 Quick Setup menu.....	21		
8 Other useful functions.....	22		
Troubleshooting.....	23		
Specifications.....	24		
Table of display resolutions.....	25		
Resolutions supported by HDMI.....	25		
Supplied Accessories.....	Back cover		



# Features

## TX-RZ900/TX-RZ800:

- Equipped with 7 ch amplifier
- Supports playback in Dolby Atmos format and has Dolby Surround listening mode
- Supports playback in DTS:X format and has DTS Neural:X listening mode
- THX Select2 Plus certified
- Equipped with 4K compatible HDMI IN/OUT jacks
- Equipped with 2 HDMI output jacks
- Supports the HDMI Standby Through function which allows transmission from players to the TV in standby state
- Supports HDCP2.2 (supported by HDMI IN1 to IN5/ HDMI OUT MAIN/SUB)
- Supports ARC (Audio Return Channel)
- Supports variety of network functions such as Internet Radio, DLNA, AirPlay, etc.
- Supports Wi-Fi and BLUETOOTH®
- Bi-Amping capability
- A/V Sync Function to correct deviation of audio and video
- Multi-zone function (Zone 2 and Zone 3) which allows you to play something in the main room while enjoying a different source in a separate room (Video and audio can also be output to Zone 2 through HDMI)
- Music Optimizer™ for compressed digital music files
- Phase Matching Bass System
- Automatic speaker setup available using supplied calibrated microphone (AccuEQ Room Calibration)
- Supports playback of MP3, WMA, WMA Lossless, FLAC, WAV, Ogg Vorbis, Apple Lossless, DSD, Dolby TrueHD via network and USB storage device (the supported formats will differ depending on the use environment)

## TX-RZ900:

- The two front channels have parallel push-pull circuits for reproducing powerful bass
- Equipped with a high-class toroidal transformer as an independent power source for the audio circuitry



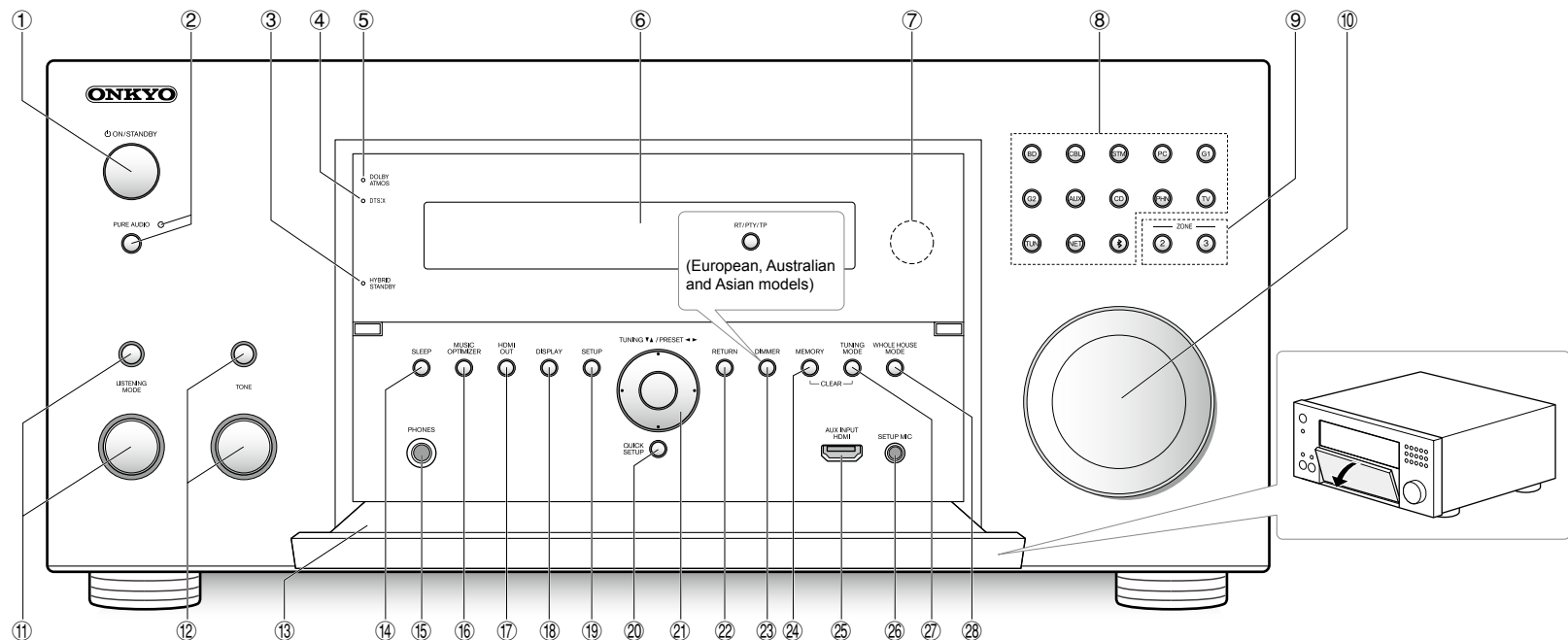

### Front Panel

- ① **ON/STANDBY button:** Turns the unit on or into standby mode.
- ② **PURE AUDIO button and indicator:** The display and analog video circuits are turned off to switch the unit to PURE AUDIO mode and provide purer sound.
- ③ **HYBRID STANDBY indicator:** Lights if the unit enters standby mode when the HDMI Standby Through, USB Power Out at Standby, Network Standby or BLUETOOTH Wakeup function is enabled.
- ④ **DTS:X indicator:** Lights when playing DTS:X.
- ⑤ **DOLBY ATMOS indicator:** Lights when playing Dolby Atmos.
- ⑥ **Display**
- ⑦ **Remote control sensor:** Receives signals from the remote controller.

- ⑧ **Input selector buttons:** Switches the input to be played. Each button is assigned to the following jacks.

Button	Jack	Button	Jack
BD	BD/DVD	G2	GAME 2
CBL	CBL/SAT	AUX	AUX
STM	STRM BOX	CD	CD
PC	PC	PHN	PHONO
G1	GAME 1	TV	TV

- Use the TUN button for AM/FM radio, the NET button for network features such as Internet radio and USB playback, and the  $\mathcal{B}$  button for BLUETOOTH features.
- The assigned jacks can be changed. For how to make settings, see "1. Input/Output Assign" in "Advanced Settings (Setup Menu)" in the Advanced Manual.

- ⑨ **ZONE2/3 button:** Controls the multi-zone function.
- ⑩ **MASTER VOLUME:** Allows you to adjust the volume.
- ⑪ **LISTENING MODE button/dial:** Allows you to select the listening mode. Press the button repeatedly to select a category from "MOVIE/TV", "MUSIC", "GAME", then turn the dial to change the mode.
- ⑫ **TONE button/dial:** Adjusts the high tone and low tone. Press the button repeatedly to select the item to adjust from "Bass", "Treble" and "Phase Matching Bass", and turn the dial to adjust.
- ⑬ **Front flap**
- ⑭ **SLEEP button:** Allows you to specify a time period after which the unit enters standby automatically.
- ⑮ **PHONES jack:** Stereo headphones with a standard plug are connected.



- ⑮ **MUSIC OPTIMIZER button:** Turns on/off the MUSIC OPTIMIZER function that improves the quality of the compressed audio.
- ⑯ **HDMI OUT button:** Allows you to select the HDMI jack to output video signals.
- ⑰ **DISPLAY button:** Switches the information on the display.
- ⑱ **SETUP button:** Used when making settings.
- ⑲ **QUICK SETUP button:** Displays the Quick Setup menu that allows you to quickly access the frequently used setting items including sound quality adjustment.
- ⑳ **Cursor buttons, TUNING▼▲ button, PRESET◀▶ button and ENTER button:** Moves the cursor and confirms the selection. When listening to AM/FM broadcasting, tune in to the station with TUNING▼▲ or select the registered station with PRESET◀▶.
- ㉑ **RETURN button:** Returns the display to the previous state.
- ㉒ **DIMMER button (North American models):** Switches the brightness of the display.
- ㉒ **RT/PTY/TP button (European, Australian and Asian models):** Can be used when receiving the station transmitting text information.
- ㉓ **MEMORY button:** Registers a radio station.
- ㉔ **AUX INPUT HDMI jack:** A HD camera or such other device is connected.
- ㉕ **SETUP MIC jack:** The supplied speaker setup microphone is connected.
- ㉖ **TUNING MODE button:** Switches the tuning mode.
- ㉗ **WHOLE HOUSE MODE button:** Enables the WHOLE HOUSE MODE function to play the same source in all the multi-zone connected rooms.

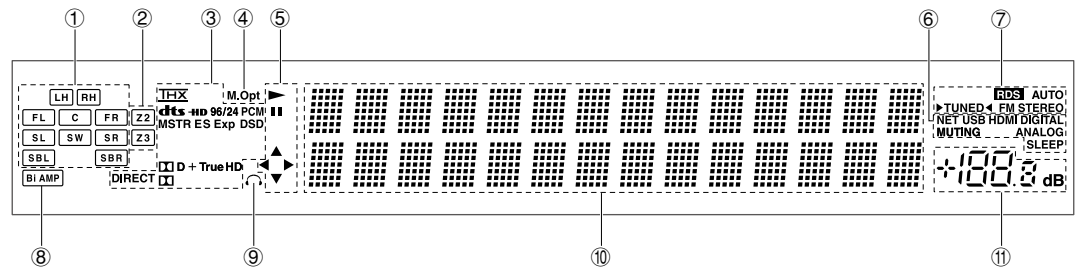

### Display

- ① Speaker/Channel display: Displays the output channel that corresponds to the selected listening mode.
- ② Z2/ Z3: Lights when the output to Zone 2/ Zone 3 is set to on.
- ③ Lights according to the type of input digital audio signals and the listening mode.
- ④ Stays lit when Music Optimizer is enabled.
- ⑤ Lights when playing NET or USB.
- ⑥ "NET": Lights when "NET" input is selected and the unit is connected to the network. It will flash if the connection is not correct.  
"USB": Lights when input is "NET" and USB is connected and selected. It will flash if the connection is not correct.  
"HDMI": Lights when HDMI signals are input and the HDMI input is selected.  
"DIGITAL": Lights when digital signals are input and the digital input is selected.  
"MUTING": Flashes when muting is on.  
"ANALOG": Lights when analog signals are input and the analog input is selected or when HDMI and digital signal inputs are not assigned.  
"SLEEP": Lights when the sleep timer is set.
- ⑦ Lights in the following conditions.  
"RDS" (European, Australian and Asian models): Receiving RDS broadcasting.  
"AUTO": Tuning mode is auto.  
"▶TUNED◀": Receiving AM/FM radio. ▶◀ flashes while tuning is automatically performed.  
"FM STEREO": Receiving FM stereo.
- ⑧ "Bi AMP": Using bi-amp.
- ⑨ Stays lit when headphones are connected.
- ⑩ Displays various information of the input signals. Pressing DISPLAY displays the type of input digital signals and the listening mode.
- ⑪ Shows the volume level.



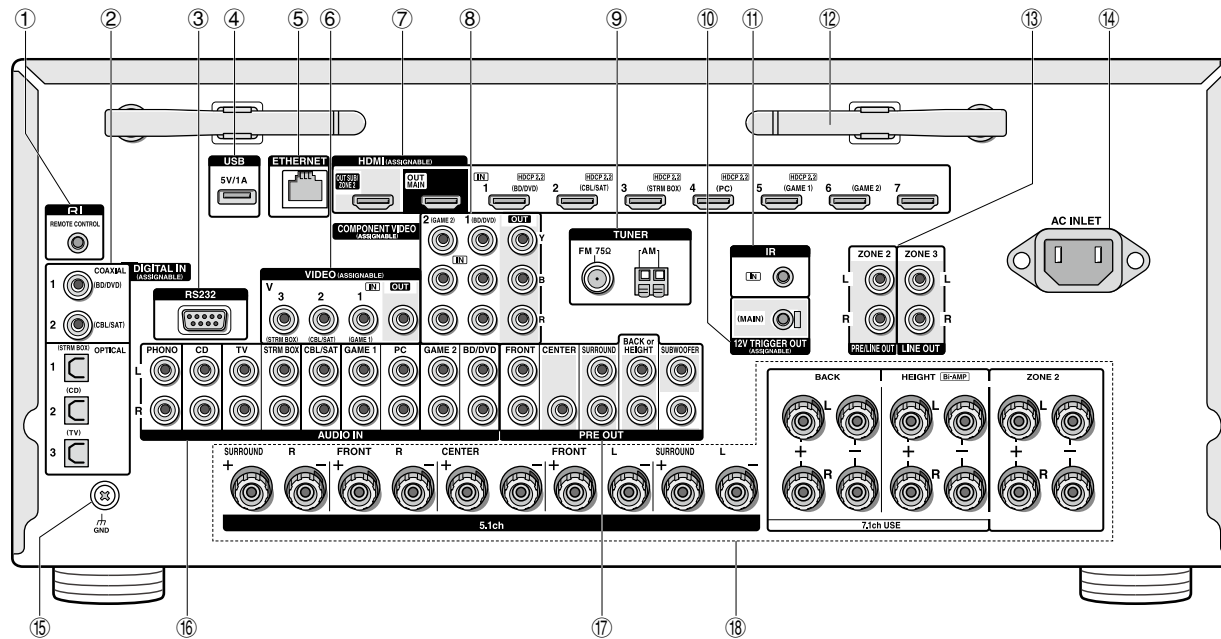

## Rear Panel

- ① **RI REMOTE CONTROL jack:** An Onkyo product with RI jack can be connected and synchronized with this unit.
- ② **DIGITAL IN COAXIAL/OPTICAL jacks:** Digital audio signals are input.
- ③ **RS232 port:** Connected to the home control system. (\*)
- ④ **USB port:** A USB storage device is connected so that music files stored in it can be played. Connect a USB device with a USB cable to supply it with power.
- ⑤ **ETHERNET port:** Used for LAN connection
- ⑥ **VIDEO IN/OUT jacks:** Composite video input/output jacks.
- ⑦ **HDMI IN/OUT jacks:** Digital video signals and audio signals are transmitted between the unit and the connected devices.
- ⑧ **COMPONENT VIDEO IN/OUT jacks:** Component video input/output jacks.
- ⑨ **TUNER AM/FM(75Ω) terminal:** The supplied antennas are connected.
- ⑩ **12V TRIGGER OUT MAIN jack:** Allows you to connect a device with 12V trigger input jack to enable link operation between the device and the unit. (\*)
- ⑪ **IR IN jack:** Connected to the multiroom remote control kit. (\*)
- ⑫ **Wireless antenna:** Used for Wi-Fi connection or when using a BLUETOOTH enabled device. Adjust their angles according to the connection status.
- ⑬ **PRE/LINE OUT ZONE 2 jack, LINE OUT ZONE 3 jack:** Audio output jack connected to the power amplifier and pre-main amplifier for multi-zone playback in a separate room.
- ⑭ **AC INLET:** The supplied power cord is connected.
- ⑮ **GND terminal:** The ground wire of the turntable is connected.
- ⑯ **AUDIO IN jacks:** Analog audio signals are input.
- ⑰ **PRE OUT jacks:** A power amplifier or subwoofer with built-in amplifier is connected.
- ⑱ **Speaker terminals:** Speakers are connected. To use the Multi-zone function, connect the speakers in the separate room to the ZONE2 speaker terminals.

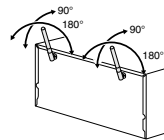

\* Special devices or cable connections are necessary to use the ③, ⑩ and ⑪ functions. Contact the specialized stores for more information.



# Step 1: Connections

## 1 Connecting speakers

### Speaker layout

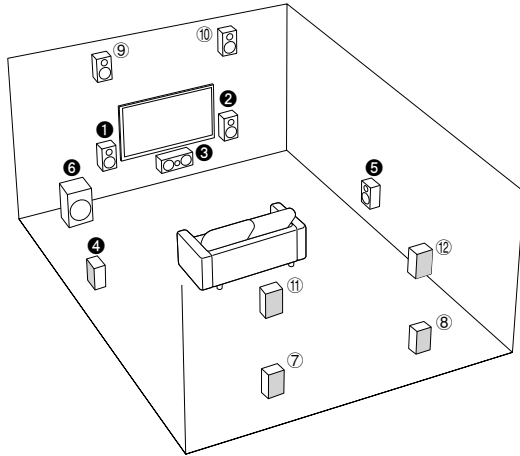

**Important:** The power cord must be connected only after all other connections are completed.

- ❶ ❷ Front speakers
- ❸ Center speaker
- ❹ ❺ Surround speakers
- ❻ Subwoofer
- ❼ ❽ Back speakers
- ❾ ❿ Height speakers (Front High)
- ⓫ ⓬ Height speakers (Rear High)

• 5.1 ch: ❶❷❸❹❺❻

• 7.1 ch: ❶❷❸❹❺❻+❼❽, or

❶❷❸❹❺❻+❾❿, or

❶❷❸❹❺❻+⓫⓬

• To enjoy the Dolby Atmos listening mode, height speakers or back speakers need to be installed. There are a variety of height speakers apart from this type. See the next section "Height speaker types" for details.

### Characteristics of speaker types

❶❷ output front stereo sound and ❸ outputs center sound such as dialogs and vocals. ❹❺ create back sound field. ❻ reproduces bass sounds and creates rich sound field.

Connecting ❼❽, ❾❿, or ⓫⓬ speakers enables playback in 7.1 ch configuration.

❼❽ (back) speakers improve sense of envelopment created by back sound field as well as seamlessness of back sounds, providing more natural sound experiences in the sound field. ❾❿ and ⓫⓬ (height) speakers produce surround effects on a height plane. Note that this unit can perform optimal sound field processing for the type of height speakers actually installed and registered in Initial Setup.

You can connect both back speakers and height speakers at the same time, but you can only output audio from one of these at a time. When connected at the same time, you can switch speakers to prioritize in the Quick Setup menu that appears when you press the Q button on the remote controller (Speaker Layout function). For details, see "7 Quick Setup menu" of "Step 3: Playing Back".

- The speaker setting is 7.1 channels at the time of purchase. You can change it manually or by using automatic speaker setting.
- To use the multi-zone function, see "6 Multi-zone" in "Step 3: Playing Back".

**Important:** Connect speakers with 4  $\Omega$  to 16  $\Omega$  impedance. You have to change the setting if any of the speakers have 4  $\Omega$  or more to less than 6  $\Omega$  impedance. Using a speaker with less impedance than the setting may result in failure. You can set up by viewing the guidance displayed on the TV screen. Select the item with the cursor buttons of the remote controller and press ENTER to confirm your selection. To return to the previous screen, press RETURN. Press RCV and then SETUP on the remote controller. Select "2. Speaker" - "Configuration" - "Speaker Impedance" and change the default value from "6ohms" to "4ohms".



Step 1: Connections

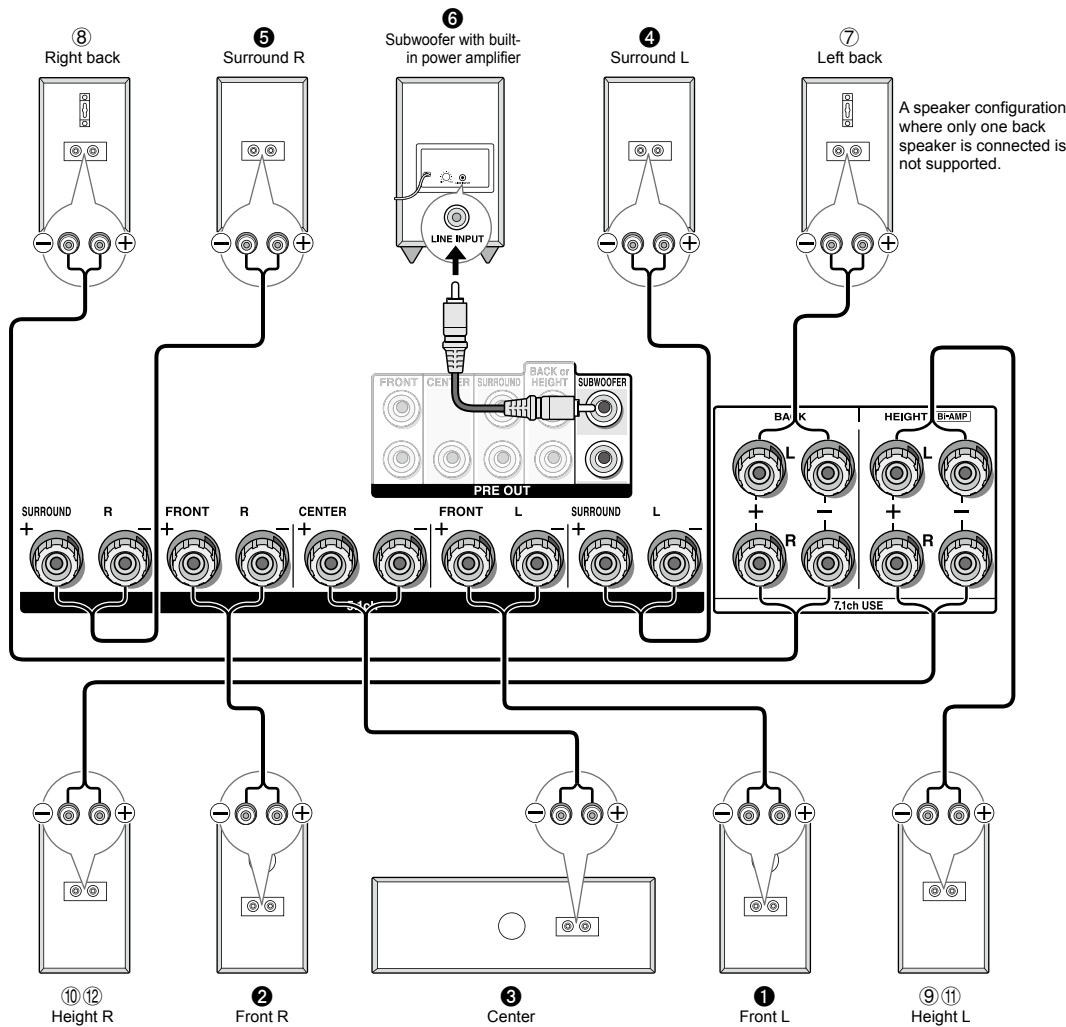

Make correct connection between the unit's jacks and speaker's jacks (+ to + and - to -).

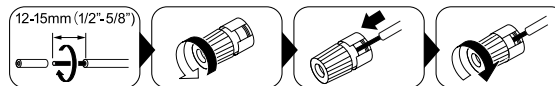

Height speaker types

Installing speakers in ceiling

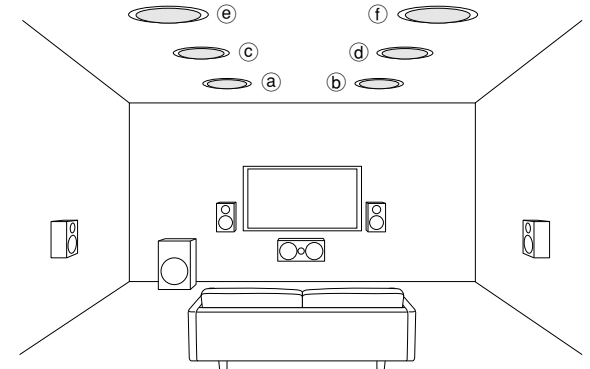

- Ⓐ Ⓑ Top front
- Ⓒ Ⓓ Top middle
- Ⓔ Ⓕ Top Rear

Ceiling speakers, etc. are used for maximizing effects in Dolby Atmos or Dolby Surround listening mode. Install Top Front speakers so that they are positioned at a point between directly above the listening position and directly above the front speakers. Install Top Middle speakers so they are directly above the listening position. Install Top Rear speakers so they are positioned at a point between directly above the listening position and directly above the back speakers. You can select ⒶⒷ, ⒸⒹ, or ⒺⒻ on this unit. For connection with the unit, use the HEIGHT speaker terminals.

- Dolby Laboratories recommends placing the speakers as described in "Installing speakers in ceiling" to obtain the best Dolby Atmos effect.



### Using Dolby Enabled Speakers

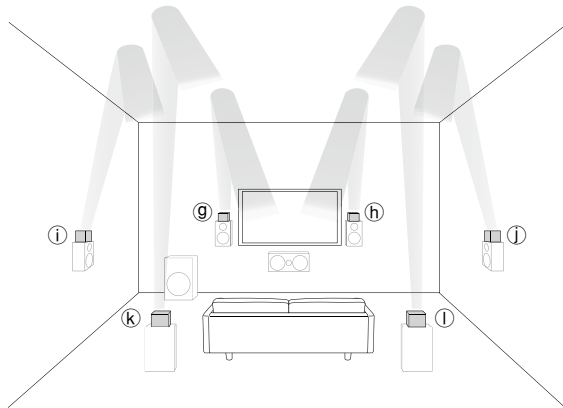

- ⓐ ⓓ Dolby Enabled Speaker (Front)
- ⓑ ⓔ Dolby Enabled Speaker (Surround)
- Ⓚ Ⓦ Dolby Enabled Speaker (Back)

A Dolby Enabled Speaker is specially designed to be used as a Height speaker. There are two types of Dolby Enabled Speakers; types placed on top of other speakers such as front speakers and surround speakers (\*), and types that are integrated with the normal speakers. Dolby Enabled Speakers placed with their diaphragms facing toward the ceiling create higher effect in the Dolby Atmos and Dolby Surround listening modes by providing sounds echoing off the ceiling. You can select ⓐⓓ, ⓑⓔ, or ⓀⓌ on this unit. For connection with the unit, use the HEIGHT speaker terminals.

\* You can put ⓀⓌ on top of back speakers, but even if you connect both back speakers and ⓀⓌ speakers at the same time, you can only output audio from one of these at a time.

When playing Dolby Atmos, the speakers required depend on how you have setup your back speakers or height speakers. The following shows speaker combinations.

Connection pattern	Back or Height	Front		
		Center	Surround	Surround
1	Back	ⓐ	ⓑ	Ⓚ
2	Front High	ⓐ	ⓑ	Ⓚ
3	Rear High	ⓐ	ⓑ	Ⓚ
4	Top Front	ⓐ	ⓑ	Ⓚ
5	Top Middle	ⓐ	ⓑ	Ⓚ
6	Top Rear	ⓐ	ⓑ	Ⓚ
7	Dolby Enabled Speaker (Front)	ⓐ	ⓑ	Ⓚ
8	Dolby Enabled Speaker (Surround)	ⓐ	ⓑ	Ⓚ
9	Dolby Enabled Speaker (Back)	ⓐ	ⓑ	Ⓚ

ⓐRequired ○Optional \*Connection of a subwoofer is optional.

### Instructions on how to connect speakers

Cut and remove the plastic coating from the end of the speaker cable, twist the core and connect it to the terminal. Make correct connection between the unit's jacks and speaker's jacks (+ to + and - to -) for each channel. If connection is wrong, a bass sound may become poor due to reverse phase. Up to two subwoofers with built-in power amplifier can be connected to the SUBWOOFER jacks. Set the cut-off filter selection switch of the subwoofer to DIRECT. If the subwoofer does not have a cut-off filter selection switch but has a cut-off frequency adjusting dial, turn it to the maximum frequency. If your subwoofer does not have built-in power amplifier, you can connect a power amplifier between the unit and the subwoofer.

- Short-circuiting the + cable and - cable or contacting the cable core to the rear panel of the unit may cause failure. Also do not connect two or more cables to one speaker terminal or one speaker to several terminals.

### Step 1: Connections

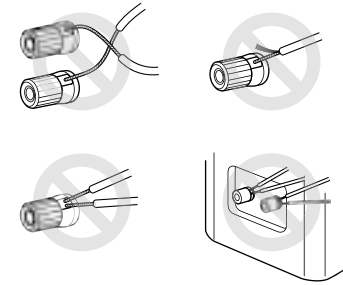

**When using commercially available banana plugs:** tighten the speaker terminals to the end and then insert the banana plugs. Do not insert the core of speaker cable directly into the hole for banana plug of speaker terminal. (North American model)

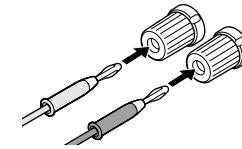



## 2 Connecting the TV and players

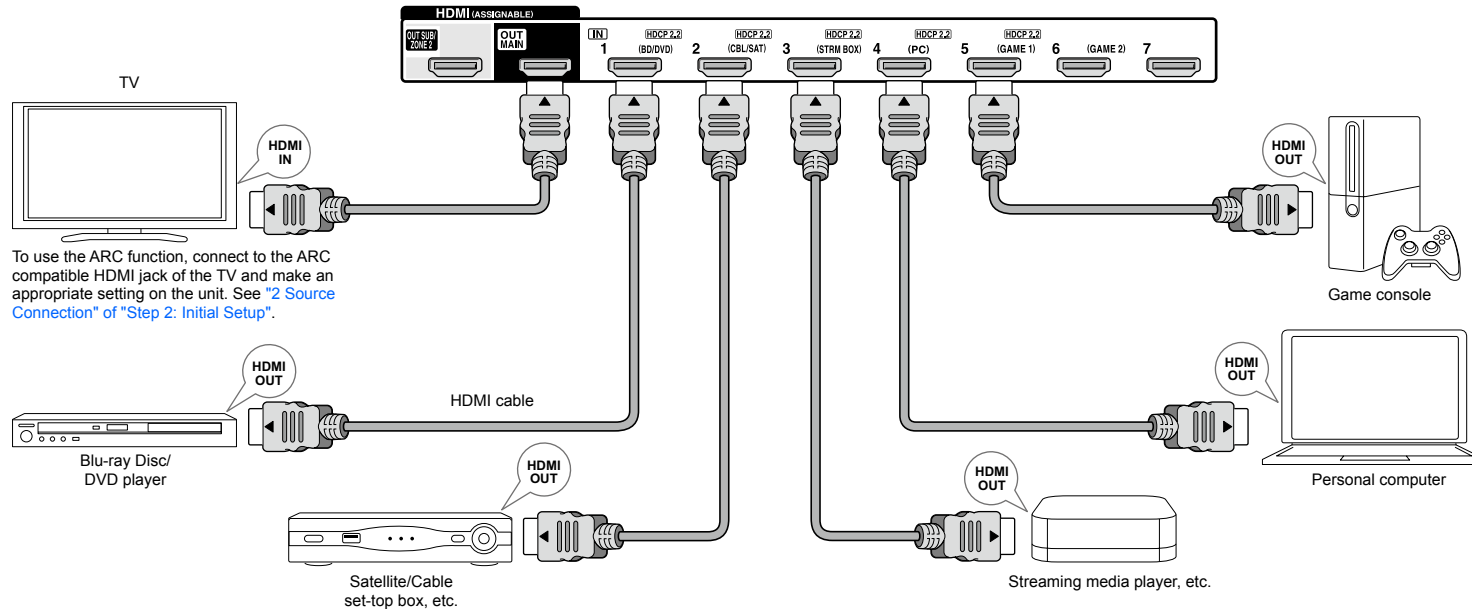

### HDMI cable connection

Refer to the above figure and connect the player to the HDMI jack on the back of this unit. For example, connect a Blu-ray Disc Player to the HDMI IN1 (BD/DVD) jack. To play the player, press the INPUT SELECTOR button on the remote controller with the same name as the jack to which you connected the player so that the input on the unit is selected.

To connect the TV and the unit, connect the HDMI OUT MAIN jack of the unit and the HDMI IN jack of the TV using an HDMI cable. With this connection, it becomes possible to display the setting screen of the unit on the TV or transmit video/audio signals from the player to the TV. If your TV supports ARC (Audio Return Channel), it is possible to play the TV sound with the AV receiver's

speakers with this connection only. If your TV does not support ARC, you need, in addition to the HDMI OUT MAIN jack connection, a digital optical cable connection between the digital audio out optical jack of the TV and the DIGITAL IN OPTICAL jack of the unit or an analog audio cable connection between the audio output jack of the TV and the AUDIO IN TV jack of the unit.

### ● Audio connection with a TV not supporting ARC

\* Select an appropriate connection for your TV.

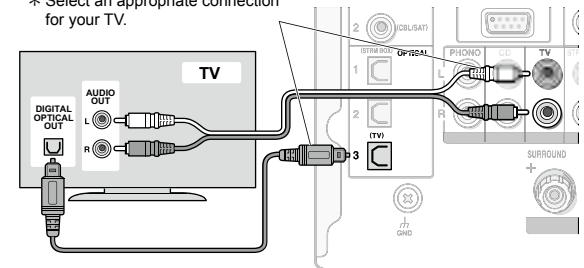

The unit supports the HDMI Standby Through function that allows transmission from players to the TV even if the unit is in standby. You have to modify the settings to enable the input selection link with CEC (Consumer Electronics



Step 1: Connections

Control) compliant device, connection with ARC compatible TV, and HDMI Standby Through function. See "2 Source Connection" of "Step 2: Initial Setup".

- Another TV can be connected to the HDMI OUT SUB jack. In this case, press the HDMI OUT button on the main unit several times to display "SUB" or "MAIN+SUB" and select the output method. You have to modify the settings to enable the CEC functions, such as ARC, for the TV connected to the HDMI OUT SUB jack. Set "Step 3: Playing Back" - "7 Quick Setup menu" - "Control TV" to "SUB".
- To enjoy HDCP2.2 protected video, connect the player to one of the HDMI IN1 to IN5 jacks and connect the HDMI output jack on this unit and to a HDCP2.2 compatible HDMI input jack on the TV. You will be unable to view images protected by HDCP2.2 if your TV does not have a HDCP2.2 compatible input jack.
- To play 4K or 1080p video, use a high speed HDMI cable or high speed HDMI with Ethernet cable.

**Connecting Components without HDMI**

If your AV component does not have HDMI jack, use an available jack of your component for cable connection with this unit.

\* It is possible to change assignment of the input jacks and input selector buttons. For how to make settings, see "1. Input/Output Assign" in "Advanced Settings (Setup Menu)" in the Advanced Manual.

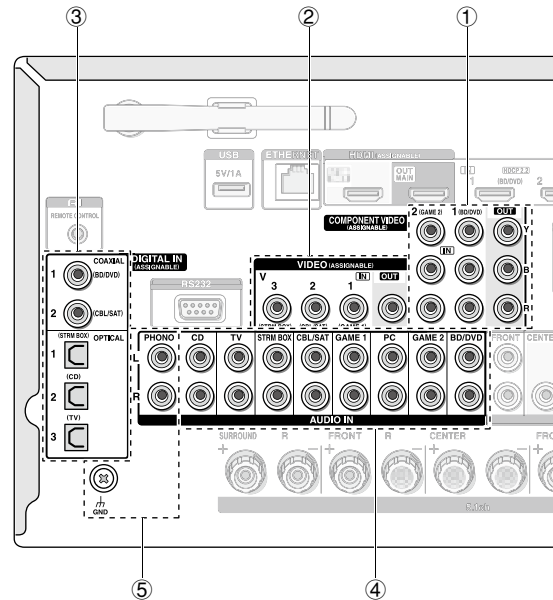

■ Video signal connection

The unit has a video upconversion function. For details, see the next section.

- ① A TV with component video input jacks or a player with component video output jacks can be connected.
  - \* Only images input through the COMPONENT VIDEO IN jacks can be output through the COMPONENT VIDEO OUT jacks.

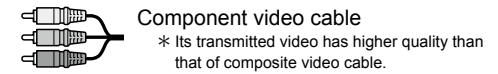

- ② A TV with composite video input jacks or a player with composite video output jacks can be connected.
  - \* Only images input through the VIDEO IN jack (composite) can be output through the VIDEO OUT jack.



■ Audio signal connection

- ③ A player with a digital audio out jack can be connected.

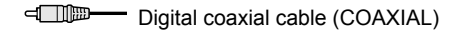
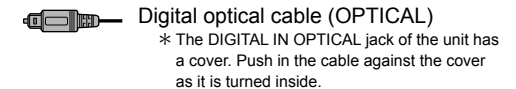

- ④ A player with analog audio out jacks can be connected. When using jacks ① and ② for video input, connect to the audio input jacks corresponding to the jacks connected at ① and ②. (For example, when video input connection is to the ① BD/DVD jack, the audio input connection should also be to the ④ BD/DVD jacks.)

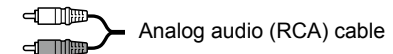

- ⑤ Connect a turntable that uses an MM type cartridge and does not have a built-in audio equalizer. If the connected turntable has a built-in audio equalizer, connect it to the ④ analog audio input jack.
  - \* If it uses an MC type cartridge, install an audio equalizer compatible with MC type cartridge between the unit and the turntable by connecting it to the ④ analog audio input jack. For details, refer to the turntable's instruction manual.
  - \* If the turntable has a ground wire, connect it to the GND terminal of this unit. If connecting the ground wire increases noise, disconnect it.



## Step 1: Connections

**Video upconversion function**

Video signals input to the VIDEO IN jack or the COMPONENT VIDEO IN jacks will be upconverted to HDMI signals and then output from the HDMI output jack.

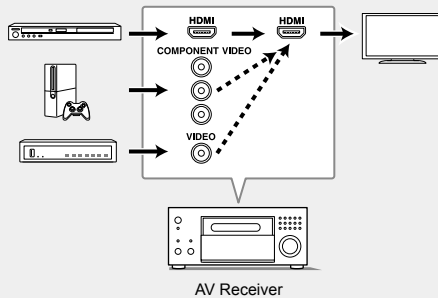

- \* When you upconvert video signals input to the COMPONENT VIDEO IN jacks and output them from the HDMI OUT jack, set the output resolution of the player to 480i or 576i. If the input has 480p/576p or higher resolution, a message prompting you to change the resolution setting will appear. If your player does not support 480i or 576i output, use the VIDEO IN jack.
- \* If multiple video signal inputs are put into one input system, HDMI signal output is prioritized.

**3 Other connections****AM/FM antenna connections**

Connect the antennas to listen to AM/FM broadcast. When listening to the broadcast for the first time, adjust the antenna position and orientation to get the best reception.

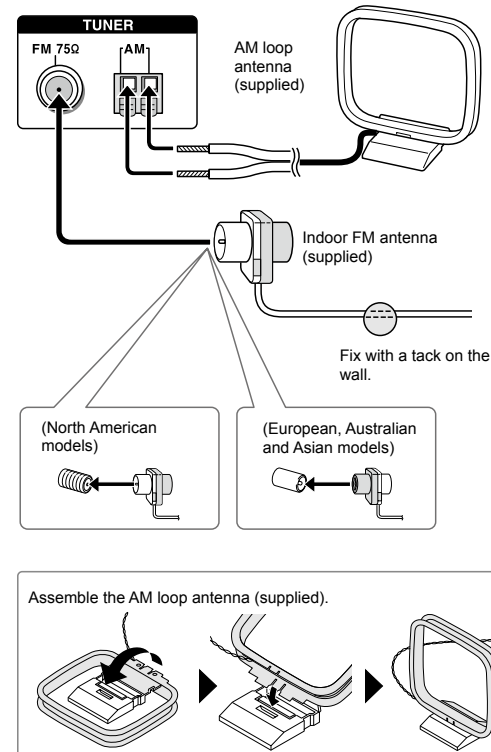
**Network connection**

You can enjoy Internet radio, DLNA, and AirPlay by connecting the unit to LAN. The unit can be connected to the router with an Ethernet cable or to the wireless LAN router with Wi-Fi connection. In case of wired connection, connect the LAN cable to the ETHERNET port. See "4 Network Connection" of "Step 2: Initial Setup" for Wi-Fi settings.

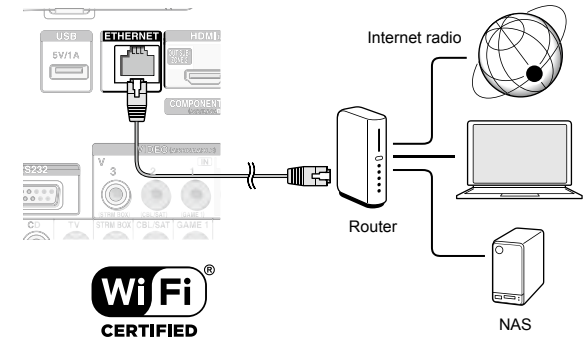
**Headphones connection**

Connect stereo headphones with a standard plug (1/4 inch or  $\phi$  6.3 mm) to the PHONES jack on the front panel. Sound from the speakers will be off while you are using the headphones.

- If you selected any other listening mode than Pure Audio, Stereo, Mono and Direct, connecting headphones will switch the listening mode to Stereo.

**Power cord**

This model includes a removable power cord. Connect the power cord to AC INLET of the unit and then connect to the outlet. Always disconnect the outlet side first when disconnecting the power cord. When the unit is turned on, a large instantaneous current may flow affecting functionality of the computer and other devices, so it is recommended to use a separate outlet.



# Step 2: Initial Setup

"Initial Setup" automatically starts on the television when you first turn the unit on.

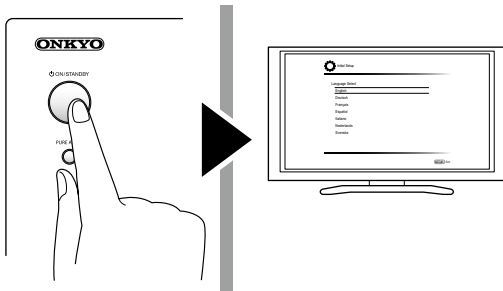

Settings proceed in the following order:

## 1 AccuEQ Room Calibration

- Automatic calibration for optimum speaker settings

## 2 Source Connection

- Checking that each input source is connected correctly
- HDMI link function settings

## 3 Remote Mode Setup

- Settings required to operate other AV Components with the Remote Controller

## 4 Network Connection

- Checking network connections
- Wi-Fi settings

\* **Firmware update notification:** If the unit is connected via LAN and there is firmware update available, the "Firmware Update Available" message will appear. To execute updating, select "Update Now" with the cursor buttons of the remote controller and press ENTER. When "Completed!" appears, press  $\odot$  ON/STANDBY on the main unit to turn the unit into standby mode. Then updating will be completed. (The unit automatically turns itself into standby mode after about 3 minutes even if you don't press  $\odot$  ON/STANDBY, and updating will be complete.)

### Before Start

Setup is performed as a series of responses to questions asked by the unit. Select the item with the cursors of the remote controller and press ENTER to confirm your selection. To return to the previous screen, press RETURN.

- Switch the input on the TV to that assigned to the unit.

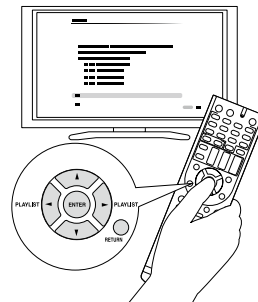

Select the language first. Next, a summary of the initial settings is displayed. Select "Yes" in this screen and press ENTER on the remote controller.

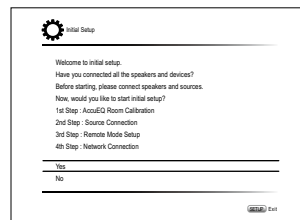

**Re-doing initial setup:** If you terminate the procedure on the way or change the setting made in the initial setup and want to call up the setup wizard again, press RCV and then SETUP on the remote controller, select "8. Miscellaneous" - "Initial Setup", and press ENTER.

## 1 AccuEQ Room Calibration

The test tone coming from each speaker will be measured to enable setting of the number of speakers, volume level, each speaker's optimum crossover frequencies, and distance from the primary listening position, and also enable correction of distortion caused by the room acoustic environment.

- You cannot return to the previous screen during speaker setup, even if you press RETURN.

### 1. Place the speaker setup microphone.

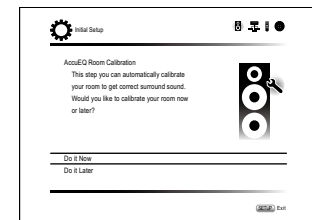

When the above screen is displayed, before starting the procedure, place the supplied speaker setup microphone at the measurement position  $\star$  by referring to the following figure.

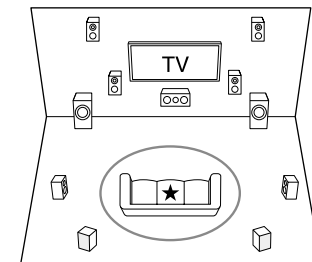

$\bigcirc$  : Listening area  $\star$  : Measurement position with microphone



## Step 2: Initial Setup

- \* Correct measurement will not be possible if the microphone is held by hand. Measurement is not possible if headphones are being used.
- \* The subwoofer sound may not be detected since it is extremely low frequencies. Set the subwoofer volume to around the half of its maximum volume.
- \* Measurement may be interrupted if there is ambient noise or radio frequency interference. If this occurs, close the window and turn off the home appliance and fluorescent light.

- After placing the microphone at the measurement position, select "Do it Now" with the cursors and press ENTER.
- When "Please plug microphone that came in a box with AV receiver" is displayed, connect the microphone to the SETUP MIC jack of the unit.

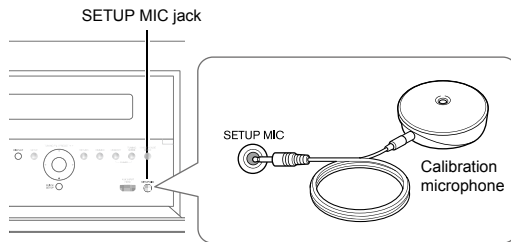

- Set the speakers you have connected and the type of Height Speakers.

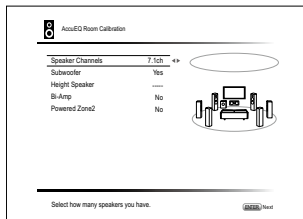

When the screen above is displayed, set the items with the cursors on the remote controller. The image on the screen changes as you choose the number of channels in "Speaker Channels", so refer to it when performing the settings. After completing all the settings, press ENTER on the remote controller.

After this, follow the guidance displayed on the TV screen.

- When the cursor is on an item, the content of the item will be shown in the lower part of the screen.

- The test tones sound from the connected speakers and automatic speaker setting starts. Measurement will be made three or more times for each speaker. It takes several minutes to be completed. Keep the room as quiet as possible during measurement. If any of the speakers do not produce the test tone, check for disconnection.
  - During measurement, each speaker outputs the test tones at a high volume. Be careful of sound leak that may disturb your neighbors, or be careful not to frighten young children.
- When the measurement is completed, the measurement result is displayed. Press ◀/▶ on the remote controller to check the settings. Press ENTER with "Save" selected. To have the settings reflected for all the speakers, select "On (All Channels)" in the next screen and press ENTER on the remote controller.
  - Select "On (Except Front Left / Right)" to disable just the front speakers.
  - If there is an error message, follow the on-screen instruction to remove the error cause. If the subwoofer was not detected, turn the volume of the subwoofer up to maximum and then select "Retry".

**About THX playback**

THX recommends setting the speakers manually if you use THX-certified speakers or playing back with THX listening modes.

- THX recommends setting the crossover frequency to "80Hz(THX)" manually.
- Due to the electrical complexities and the interaction with the room, you may notice irregular results when setting the level or distance of each speaker. If this happens, THX recommends setting the speakers and the subwoofer manually.

- When "Please unplug setup microphone." is displayed, disconnect the microphone.

**2 Source Connection**

You can check the connections for each of the inputs and configure the HDMI link function.

- When the Source Connection start screen is displayed, select "Yes, Continue" with the cursors and press ENTER.

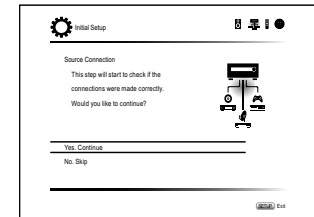

- Select the desired input to check the connection and press ENTER. Start playback of the selected device. If connection is correct, video/audio of the input source selected on the unit will be played.
- After checking the connection, select "Yes" with the cursors and press ENTER.
  - If you select "No" and press ENTER, the error cause will be displayed. Follow the guidance to remove the error cause and check the connection again.
- Select "Yes" with the cursors and press ENTER on the remote controller to check the connection of other inputs or select "No, Done Checking" and press ENTER to skip. If you select "Yes", you will return to the screen of step 2. If you select "No, Done Checking", you will proceed to step 5.
- Settings for the CEC link function. To enable the HDMI link function with CEC compatible equipment, select "Yes", then select "Yes" again in the next screen.



Step 2: Initial Setup

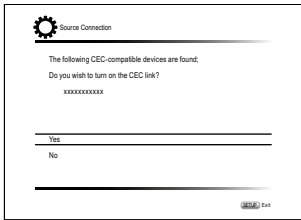

If you select "Yes", the connection with ARC compatible TV and HDMI Standby Through function will be set to "On" and enabled.

### 3 Remote Mode Setup

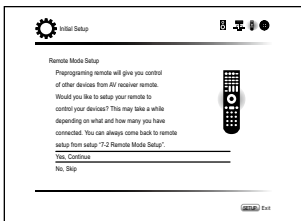

You can enable operation of the other components using the remote controller of the unit. When the Remote Mode Setup start screen is displayed, select "Yes, Continue" with the cursors and press ENTER on the remote controller. Follow the guidance to select the desired REMOTE MODE button and in the keyboard screen, enter the first three characters of the brand name of the device you are going to program and search for the remote control code. The guidance will also explain how to set the remote controller.

## 4 Network Connection



You can check the network connection and make the Wi-Fi setting. When the Network Connection start screen is displayed, select "Yes" with the cursors and press ENTER on the remote controller. If you select "Wired" in the next screen, you can view the LAN cable connection status. To make the Wi-Fi setting, select "Wireless", press ENTER on the remote controller and follow the sections below.

#### Make the following preparations.

Wi-Fi connection requires an access point such as wireless LAN router (\*). Write down the SSID and password (key) of the access point if they are shown in the label of the main body. If the access point has an automatic setting button (may be called differently according to the manufacturer), you can set up without inputting the password. For how to use the automatic setting button of the access point, refer to its instruction manual.

\* The unit supports Wi-Fi connection with 2.4 GHz access point.

#### 1. Select the method of Wi-Fi connection with the cursors and press ENTER.

**Scan Networks:** Search for an access point such as a wireless LAN router from this unit.

**Use iOS Device (iOS7 or later):** If you are using an iOS device, you can connect easily with Wi-Fi just by sharing the iOS device's Wi-Fi settings with this unit.

#### ■ If you selected "Scan Networks"

#### 2. Select the SSID of the access point to be connected with the cursor buttons and press ENTER.

When the SSID of the access point appears on the TV screen, select the desired access point.

- If you changed the initial setting of the access point to skip password entry, step 3 is unnecessary.
- If you changed the initial setting of the access point to hide the SSID, see "When the access point is not displayed".

#### 3. Select and set the authentication method.

The "Enter Password" screen may be displayed automatically if the wireless LAN router does not have an automatic setting button.

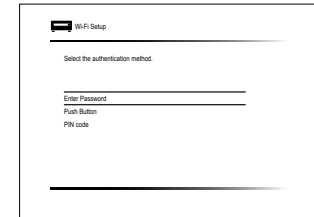

When this screen is displayed, select and set one of the three authentication methods: "Enter Password", "Push Button" and "PIN code". See below for details of and how to set each method.

**Enter Password:** Enter the password of the access point to establish connection.

- ① Select "Enter Password" with the cursor buttons and press ENTER.
- ② Enter the password (\*) on the keyboard screen, select "OK" with the cursor buttons and press ENTER.
  - \* Select "A/a" and press ENTER to toggle between upper and lower case. Select "←" or "→" and press ENTER to move the cursor to the selected direction. Select and press ENTER to delete the character at the left of the cursor position. To select whether to mask the password with "\*" or display it in plain text, press D on the remote control. Press +10 on the remote controller to switch between upper and lower case. Press CLR to delete all the input characters.
- ③ If the security method of the access point to be connected is WEP, select "Default Key ID", and press ENTER.



## Step 2: Initial Setup

**Push Button:** Use the automatic setting button of the access point to establish connection.

- ① Select "Push Button" with the cursor buttons and press ENTER.
- ② Hold down the automatic setting button of the access point for the necessary seconds, select "OK" with the cursor buttons and press ENTER.

**PIN code:** Select this method when the automatic setting button of the access point is beyond the reach. Select "PIN code" with the cursor buttons and press ENTER to display the 8-digit PIN code. Register the displayed PIN code to the access point, select "OK" with the cursor buttons and press ENTER. For how to register the PIN code to the access point, refer to its instruction manual.

#### 4. Select "Yes, Start to Check" in the network connection confirmation screen.

##### When the access point is not displayed

Select "Other..." with the ► cursor on the remote controller and press ENTER to display the keyboard screen. Input the SSID and password. Make the following settings according to the router setting.

##### ■ WPA/WPA2 method

Select "WPA" or "WPA2" in "Security Method", and press ENTER.

##### ■ WEP method

Select "WEP" in "Security Method" and select "Default Key ID", and press ENTER.

- If encryption setting has not been made on the wireless LAN router, select "None" in "Security Method", and press ENTER.

##### ■ When "Use iOS Device (iOS7 or later) is selected

2. On the iOS device, go to "Settings"->"Wi-Fi" and turn on the setting, then select this unit in "SETUP NEW AIRPLAY SPEAKER".
3. Tap "Next".
4. Select "Yes, Start to Check" in the network connection confirmation screen.

#### \* Privacy policy

A confirmation screen asking you to agree to the privacy policy is displayed during network setting. Select "Yes" and press ENTER to indicate agreement.

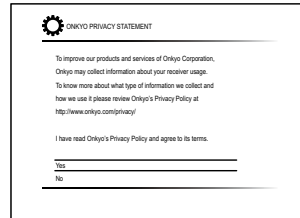

#### ■ If connection is successful

"Successfully Connected" is displayed on the screen.

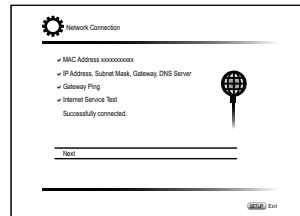

If this is not displayed, try doing the setting again. If "Push Button" connection with the wireless LAN router does not work, try "Enter Password".

#### ■ Terminating initial setup

After finishing the initial setup, keep "Finished" selected and press ENTER on the remote controller. Connection and setting of the unit is now complete.

#### Audio output of connected players

To enjoy digital surround sound including Dolby Digital and DTS, audio output should be set to "Bitstream output" on the connected Blu-ray Disc Player or other device. Depending on the settings on the Blu-ray Disc Player there may be cases when Dolby TrueHD, Dolby Atmos, and DTS-HD Master Audio audio is not output according to the format of the source. In this case, in the Blu-ray Disc Player settings try setting "BD video supplementary sound" (or secondary sound) to "Off". Change the listening mode after changing the setting to confirm.



# Step 3: Playing Back

## 1 Basic operations

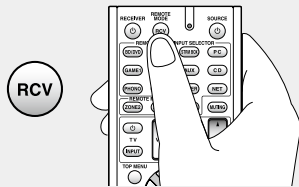

● **To control the unit:** The remote controller of this unit has the remote mode function for controlling other devices. You cannot control this unit when the remote controller is in the remote mode other than RECEIVER mode (for controlling this unit). Be sure to press the ①RCV button to select the RECEIVER mode before starting operation.

### 1. Turning the power on.

Press ② **RECEIVER** on the remote controller to turn the power on.

- Switch the input on the TV to that assigned to the unit. Use the TV's remote controller.

### 2. Select the input on the unit.

Press the ③ **INPUT SELECTOR** button with the same name as the jack used for connection. For example, press the BD/DVD button to play the player connected to the BD/DVD jack. Press TV to listen the TV's sound.

- Input will automatically be selected if the TV or player is CEC compliant and connected to the unit with HDMI cable.

### 3. Select the desired listening mode.

After pressing ①RCV, press the ⑦ listening mode buttons to switch the mode so that you can enjoy different listening modes.

### 4. Adjust the volume with ⑩ VOL.

## Remote controller parts name

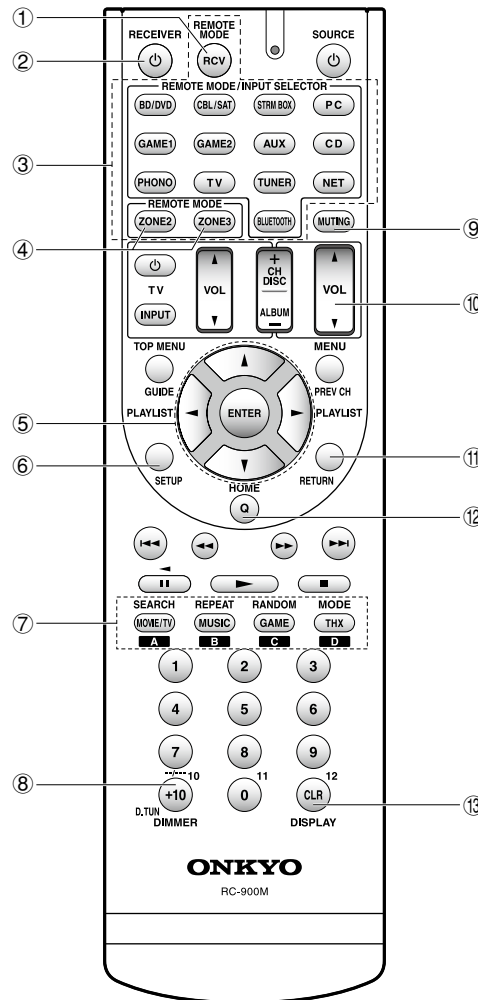

- ① **RCV button:** Switches the remote controller to the mode for operating this unit.
- ② **RECEIVER button:** Turns the unit on or into standby mode.
- ③ **REMOTE MODE/INPUT SELECTOR buttons:** Switches the input to be played. Each button is assigned to the following jacks.

Button	Jack	Button	Jack
BD/DVD	BD/DVD	GAME 2	GAME 2
CBL/SAT	CBL/SAT	AUX	AUX
STRM BOX	STRM BOX	CD	CD
PC	PC	PHONO	PHONO
GAME 1	GAME 1	TV	TV

- Use the TUNER button for AM/FM radio, the NET button for network features such as Internet radio and USB playback, and the button for BLUETOOTH features.
  - After registering a particular remote control code to a button, you can switch the remote control mode to operate other equipment by pressing that button.
- ④ **ZONE2, ZONE3 buttons:** For use when the unit is connected with a pre-main amplifier and speakers in a separate room and sound is played there.
  - ⑤ **Cursor buttons and ENTER button:** Moves the cursor and confirms the selection.
  - ⑥ **SETUP button:** Displays the screen for making various settings for this unit.
  - ⑦ **Listening mode buttons:** Allows you to select the listening mode.
    - MOVIE/TV button:** You can select a listening mode suitable for movies and TV programs.
    - MUSIC button:** You can select a listening mode suitable for music.
    - GAME button:** You can select a listening mode suitable for games.
    - THX button:** You can select a THX listening mode.
      - For details on the listening modes, see the Advanced Manual.
  - ⑧ **DIMMER button:** Switches the brightness of the display.





## Step 3: Playing Back

- ⑨ **MUTING button:** Temporarily mutes audio. Press again to cancel muting.
- ⑩ **VOLUME buttons:** Allows you to adjust the volume. This button also cancels the muting.
- ⑪ **RETURN button:** Returns the display to the previous state.
- ⑫ **Q button:** Displays the Quick Setup menu that allows you to quickly access the frequently used setting items including sound quality adjustment.
- ⑬ **DISPLAY button:** Switches the information on the display.

## 2 Network Functions

You can enjoy sources such as Internet radio by connecting the unit to a network. For details on the operation, see the Advanced Manual.

- The operations described in this section are not displayed on the TV when the OSD (the feature to show information such as setting menus on the TV) language is set to "Chinese". Operate by confirming the display on the main unit. (European, Australian and Asian models)

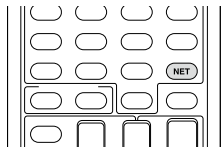

Press NET on the remote controller to display the NET TOP screen on the TV. Select the item with the cursors of the remote controller and press ENTER to confirm your selection. To return to the previous screen, press RETURN.

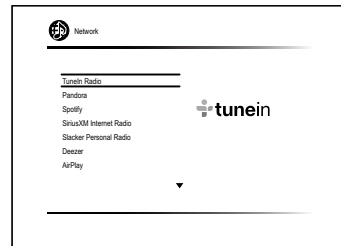

### Internet Radio services

The unit comes preset with Internet radio services such as Tuneln Radio. After selecting the desired service, follow the on-screen instructions, using the cursors to select radio stations and programs, then press ENTER to play.

- Network services or contents may become unavailable if the service provider terminates its service.
- Available services may vary depending on your area of residence.

### DLNA

You can play music files stored in the PC or NAS device connected to the network. Select the server with the cursors, select the desired music file and press ENTER to start playback.

- This unit needs to be connected to the same router as a computer or NAS device.

### Home media

You can play music files in a shared folder on the PC or NAS device connected to the network. Select the server with the cursors, select the desired music file and press ENTER to start playback.

- This unit needs to be connected to the same router as a computer or NAS device.

### USB

Play music files on a USB storage device. Connect the USB storage device to the USB jack on the rear of the unit, select the desired folder or music file with the cursors, and press ENTER to confirm and start playback.

## 3 AirPlay®

You can enjoy the audio from iPhone®, iPod touch®, iPad® and PCs with iTunes.

**Important:** The iOS device or PC needs to be connected to the network through the same router as this unit.

### Playing music files from an iPhone, iPod touch, or iPad

Update the OS version on your iOS device to the latest version before connecting it to this unit.

1. Press NET on the remote controller.
2. Tap the AirPlay icon on the iPhone, iPod touch, or iPad, select this unit from the list of devices displayed, and click "Done".

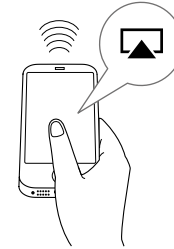

- The AirPlay icon is displayed in the control center under iOS 7 and later. To display the control center, swipe from the bottom of the screen of the iOS device.
- If the AirPlay icon is not displayed, confirm that this unit and the iOS device are both connected to the router correctly.

3. Playing music files from an iPhone, iPod touch, or iPad.

### Playing music files from a computer

- AirPlay is compatible with iTunes 10.2 or later.

1. Press NET on the remote controller.
2. Switch on your computer and start iTunes.



3. Click the AirPlay icon in iTunes and select this unit from the list of devices displayed.

4. Playing iTunes music files.

- If "6. Hardware"-"Power Management"-"Network Standby" is set to "On" in the Setup menu, then once AirPlay starts, this unit switches on automatically and the "NET" input source can be selected. Even if this setting is "Off", if the unit is already on then the "NET" input source can be selected.
- Information such as the name of the track is displayed on the unit's display during AirPlay playback.
- Due to the characteristics of AirPlay wireless technology, the sound produced on this unit may slightly be behind the sound played on the AirPlay-enabled device.
- There may be some differences in how operations are performed depending on the iOS or iTunes version.
- OSD are not displayed when the OSD language is set to "Chinese". Operate by confirming the display on the main unit. (European, Australian and Asian models)

**Volume:** The volume of this unit and the AirPlay-enabled device are linked. Take care that the volume doesn't become too loud when you adjust the volume on the AirPlay-enabled device. You may damage the unit or the speakers. Stop play on the AirPlay-enabled device immediately if the volume becomes too loud at any point.

## 4 BLUETOOTH® function

You can wirelessly enjoy music files stored in a smartphone or other BLUETOOTH enabled device. The coverage area is 48 feet (15 meters).

- Note that connection is not always guaranteed with all BLUETOOTH enabled devices.

### ■ Pairing

Pairing is necessary when connecting the BLUETOOTH enabled devices for the first time. Before starting the

procedure, learn how to enable the BLUETOOTH setting function and to connect with other devices on the BLUETOOTH enabled device.

1. Press BLUETOOTH on the remote controller.

The unit begins pairing and "Now Pairing..." is displayed.

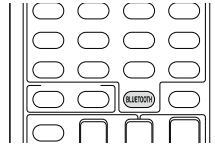

2. While "Now Pairing..." is on the display, complete connection on the BLUETOOTH enabled device in the nearby area within about 2 minutes.

If the name of this unit is displayed on the BLUETOOTH enabled device's display, select this unit. Pairing will end after a short time.

- If a password is requested, enter "0000".
- You can pair with another BLUETOOTH enabled device by pressing and holding the BLUETOOTH button while "Now Pairing..." is on the display. This unit can store the data of up to eight paired devices.

### ■ Playing BLUETOOTH enabled devices

If the unit is on and the BLUETOOTH enabled device is connected, the input will be automatically switched to BLUETOOTH. Play music in this state.

- It may take about a minute until connection is established when the unit is on since the BLUETOOTH function takes some time to start up.
- If the volume setting on the BLUETOOTH enabled device is low, the sound will not be output from this unit.
- Due to the characteristics of BLUETOOTH wireless technology, the sound produced on this unit may slightly be behind the sound played on the BLUETOOTH enabled device.
- OSD are not displayed when the OSD language is set to "Chinese". Operate by confirming the display on the main unit. (European, Australian and Asian models)

## 5 AM/FM Radio

The Basic Manual explains the method using automatic tuning. For manual tuning, see the Advanced Manual.

1. Press the TUN button on the main unit several times to select either "AM" or "FM".

2. Press TUNING MODE on the unit, so that the "AUTO" indicator on the display lights.

3. Press TUNING ▲/▼ on the unit.

The automatic tuning to a radio station starts. Searching stops when one is tuned. When tuned into a radio station, the "▶TUNED◀" indicator on the display lights. The "FM STEREO" indicator lights if the radio station is an FM radio station.

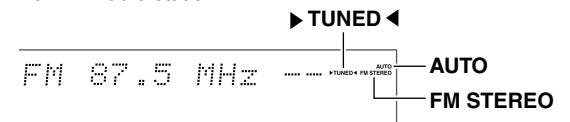

Actual display varies depending on the country or region

**Registering a radio station:** You can register up to 40 of your favorite AM/FM radio stations.

1. Tune into the AM/FM radio station you want to register.
  2. Press MEMORY on the unit so that the preset number on the display flashes.
  3. Repeatedly press PRESET ◀▶ on the unit to select a number between 1 and 40 while the preset number is flashing (about 8 seconds).
  4. Press MEMORY again on the main unit to register the station.  
When registered, the preset number stops flashing. To select a preset radio station, press PRESET ◀▶ on the main unit or CH +/- on the remote controller.
- To delete a registered preset station, press the PRESET ◀▶ button on the main unit, select the preset number you want to delete, then while holding down the MEMORY button, press the TUNING MODE button. When deleted, the number on the display goes off.



Step 3: Playing Back

**AM/FM frequency step setting**

It may be necessary for you to change the frequency step to tune the radio in your area. Change the step with the following procedure. Note that when this setting is changed, all radio presets are deleted.

1. After pressing RCV on the remote controller, press SETUP.
2. Select "6. Hardware" with the cursor and press ENTER.
3. Select "Tuner" with the cursor and press ENTER.
4. Select "AM/FM Frequency Step" (North American models) or "AM Frequency Step" (European, Australian and Asian models) with the cursor and select the frequency step for your area.

## 6 Multi-zone

You can listen to audio in a room (called Zone 2 or Zone 3) other than the one where this unit is located (called the main room). You can also output video and audio to a TV in the separate room (Zone 2) via HDMI.

**■ Sources you can playback**

- External players (\*1)
- NET (\*2)
- BLUETOOTH
- AM/FM Radio

- \*1 In Zone 2, you can play equipment connected to any of the HDMI IN1 to IN5 jacks, DIGITAL IN COAXIAL/OPTICAL jacks, or AUDIO IN jacks. Note that only analog or 2-channel PCM audio signals can be played and that some players require audio output setting. Only players connected to the AUDIO IN jack by analog connection can be played in Zone 3.
- \*2 DSD and Dolby TrueHD audio cannot be played in Zone 2/Zone 3.

**Making Multi-zone Connection**

There are the following three methods of connection. Simultaneous playback in all zones is also possible.

- a. Connecting a TV in a separate room
- b. Connecting with an integrated amplifier or power amplifier in a separate room
- c. Connecting with speakers in a separate room

**■ a. Connecting a TV in a separate room**

You can play video and audio of the HDMI connected player on the TV in a separate room. With an HDMI cable, connect between the HDMI OUT SUB/ZONE 2 jack of the unit and the HDMI IN jack of the TV in a separate room.

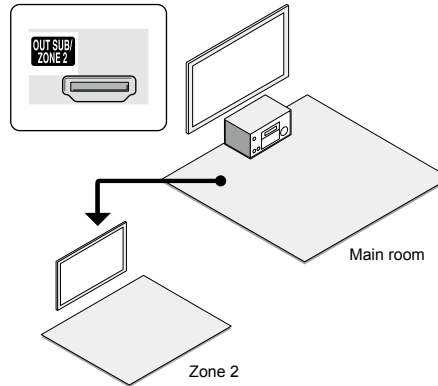

**Settings are required:** Press RCV and then SETUP on the remote controller, select "1. Input/Output Assign" - "TV Out" and set the "Zone 2 HDMI" setting to "Use".

- The information for a connected device can be displayed on the TV screen in a separate room. Press the ZONE2 button on the remote controller to select Zone 2 and press DISPLAY.
- Adjust the volume on the TV in the separate room.

**■ b. Connecting with an integrated amplifier or power amplifier in a separate room**

It is possible to play 2 ch source in a separate room while 7.1 ch source is being played in the main room. Connect the PRE/LINE OUT ZONE2 jacks or LINE OUT ZONE3 jacks of the unit and the line-in jacks of the integrated amplifier in a separate room with an RCA cable.

**Settings are required to listen to HDMI input audio in Zone 2:** Press RCV and then SETUP on the remote controller, select "1. Input/Output Assign" - "TV Out" and set the "Zone 2 HDMI" setting to "Use".

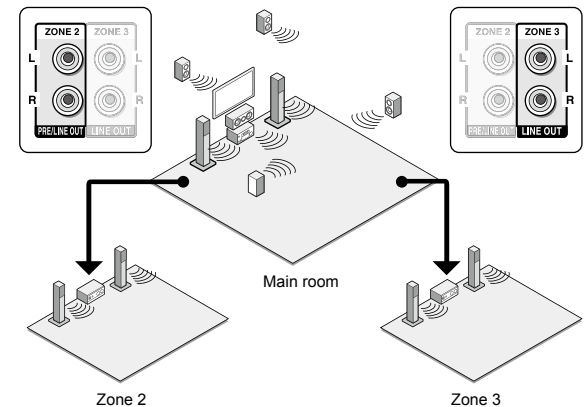

Zone 2 audio can be adjusted with both the unit and the pre-main amplifier used in the separate room. Zone 3 audio should be adjusted with the pre-main amplifier used in the separate room.

**Settings are required to adjust audio in Zone 2 using this unit:** Press RCV and then SETUP on the remote controller, select "3. Audio Adjust" - "Multi Zone" and set the "Zone 2 Out" setting to "Variable". Be sure to make this setting if you connect a power amplifier. If you do not, the volume output may be big enough to cause damage.



## Step 3: Playing Back

**c. Connecting with speakers in another room**

Connect the speakers in another room to the ZONE2 speaker terminals of the unit using speaker cables. Note that 5.1 ch will be the maximum (\*) in the main room during Zone 2 playback. No sound will be output from the back speakers and height speakers.

\* In this case, the Dolby Atmos listening mode cannot be selected.

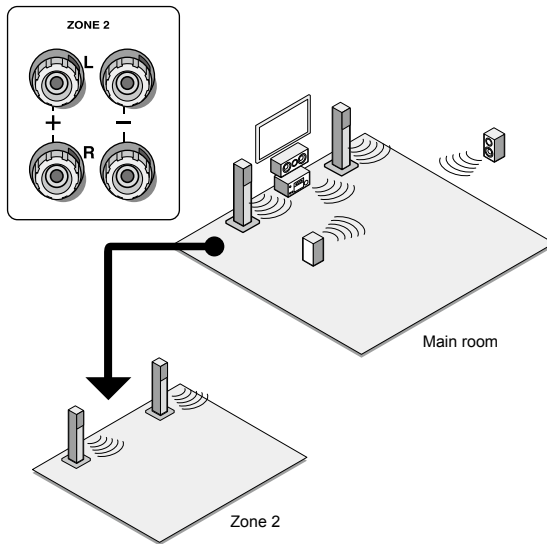

**These settings are required:** After connecting the speakers, press RCV and then SETUP on the remote controller, select "2. Speaker" - "Configuration" and set "Powered Zone 2" to "Yes".

**Settings are required to listen to HDMI input audio in Zone 2:** Press RCV and then SETUP on the remote controller, select "1. Input/Output Assign" - "TV Out" and set the "Zone 2 HDMI" setting to "Use".

**Performing Multi-zone Playback**

It is possible to perform playback in the main room and a separate room at the same time, for example by playing the Blu-ray Disc player in the main room where the unit is placed while playing Internet radio in a separate room. It is also possible to perform playback only in a separate room.

- With external players, it is possible to play the same source or different sources in the main room and separate room.
- With "NET" and "BLUETOOTH", you cannot select different inputs for the main room and separate room. For example, if "NET" has been selected in the main room and then "BLUETOOTH" is selected as playback source in the separate room, the input in the main room will change to "BLUETOOTH" accordingly. Furthermore, you cannot select separate network services for the main room and a separate room with the "NET" input.
- When listening to AM/FM broadcasting, you cannot select different stations for the main room and separate room. Therefore broadcasting of the same station will be heard in the both rooms.
- If you have connected the same player by HDMI in the main room and in a separate room, input to this unit (the main room) will be 2-channel PCM.

**Playing Back**

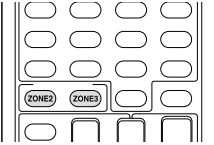
1. **Press ZONE2 or ZONE3 on the remote controller, point the remote controller at the main unit and press  $\odot$ RECEIVER.** "Z2" or "Z3" lights on the main unit display and the multi-zone function is enabled. (Zone 2 or Zone 3 is now on.)
- 
2. **Press ZONE2 or ZONE3 again on the remote controller and press INPUT SELECTOR of the input to be played in a separate room.**
    - If you turn the unit to standby during multi-zone playback, the Z2/Z3 indicators are dimmed and the

playback mode is switched to playback in a separate room only. Performing steps 1 and 2 while the unit is in standby also switches the playback mode to playback in a separate room only. To play the same source in the main room and separate room, hold down ZONE2 or ZONE3 for approximately 3 seconds.

**To control on the main unit:** press ZONE2 or ZONE3 and within 8 seconds, press the input selector button of the source to be played in the other room. To play the same source in the main room and separate room, press ZONE2 or ZONE3 twice.

**To adjust the audio in Zone 2**

To adjust the volume, press ZONE2 on the remote controller and then adjust with VOL $\blacktriangle$ /VOL $\blacktriangledown$ . You can also temporarily mute sound by pressing MUTE. To control on the main unit, press ZONE2 and within 8 seconds, adjust with the MASTER VOLUME control.

To adjust the sound quality, press ZONE2 on the main unit and press TONE several times to display "Bass", "Treble" or "Balance" on the main unit display, then turn the dial to adjust.

**To turn off the function**

After pressing ZONE2 or ZONE3 on the remote controller, press  $\odot$ RECEIVER. To control on the main unit, press ZONE2 or ZONE3 and press  $\odot$ ON/STANDBY.

- Power consumption in standby mode increases when the multi-zone function is being used.
- If Zone 2 or Zone 3 is turned on when the listening mode of the main room is Pure Audio, it will automatically switch to the Direct listening mode.
- While using the multi-zone function, the RI linked system function (link between Onkyo components) is disabled.
- Pressing INPUT SELECTOR on the remote controller while you are using the remote controller for Zone 2 or Zone 3 will switch the controlled target to the main room. To control Zone 2 or Zone 3 again, press the ZONE2 or ZONE3 button to enter the Zone control mode.



## Step 3: Playing Back

**WHOLE HOUSE MODE:** If you press WHOLE HOUSE MODE while playback is being performed in the main room, the WHOLE HOUSE MODE is turned on, "Z2" and "Z3" on the display light at the same time and the playback sources of all the rooms are switched to the same source at once.

- The sources that can be played in Zone 2 can be played in all rooms.
- This function cannot be used if headphones are connected or audio is output from the speakers of the TV.

## 7 Quick Setup menu

You can perform common settings on the television screen while playing.

### 1. Press Q on the remote controller.

The Quick Setup menu is displayed on the connected TV's screen.



### 2. Select the items with the cursors on the remote controller and then press ENTER.

- To return to the previous screen, press RETURN.

### 3. Select the content with the cursors of the remote controller.

■ **Listening Mode:** Select the listening mode from the categories of "MOVIE/TV", "MUSIC", "GAME" and "THX". After selecting, press ENTER button to confirm.

- It cannot be set when audio is played from the TV's speakers.

■ **Audio:** You can perform various audio settings including audio quality and speaker level adjustment.

- You cannot select this item when audio is output from the TV's speakers.

**Bass, Treble:** Adjust volume of the front speaker.

- It cannot be set if the listening mode is Pure Audio, Direct or THX.

**Phase Matching Bass:** Suppress phase shift in the midrange to enhance bass sound. Thus smooth and powerful bass sound can be obtained.

- It cannot be set if the listening mode is Pure Audio, Direct or THX.

**Center Level, Subwoofer Level:** Adjust the speaker level while listening to the sound. The adjustment you made will be reset to the previous status when you turn the unit to standby mode.

- Changes may not be possible depending on the speaker settings.
- This setting is not possible during MUTING or when using headphones.

**Speaker Layout:** Select the speakers to prioritize when back speakers and height speakers are connected at the same time.

- Changes may not be possible depending on the speaker settings.

**A/V Sync:** If the video is behind the audio, you can delay the audio to offset the gap. Different settings can be set for each input selector.

- It cannot be set if the listening mode is Pure Audio or Direct.

**AccuEQ Room Calibration:** Enable or disable the settings made by automatic speaker setting. If this is to be enabled, then normally you should select "On (All Ch)", and to disable just the front speakers you should select "On (ex. L/R)". The setting can be separately set to each input selector.

- This setting cannot be selected if the automatic speaker setting has not been performed.
- It cannot be set if headphones are connected or the listening mode is Pure Audio or Direct.

**Equalizer:** Select "Preset1" to "Preset3" configured in "2. Speaker" - "Equalizer Settings" in the Setup menu. The same sound field setting is applied all ranges when set to "Off".

- It cannot be set if the listening mode is Pure Audio or Direct.

**Music Optimizer:** Improve the quality of the compressed audio. Playback sound of lossy compressed files such as MP3 will be improved. The setting can be separately set to each input selector.

- The setting is effective in the signals of 48 kHz or less. The setting is not effective in the bitstream signals.
- It cannot be set if the listening mode is Pure Audio or Direct.

**Late Night:** Make small sounds to be easily heard. It is useful when you need to reduce the volume while watching a movie late night. You can enjoy the effect only with Dolby Digital, Dolby Digital Plus, Dolby TrueHD, and DTS sources.

- Turning the unit to standby mode will set the setting to "Off". In case of Dolby TrueHD, the setting will be set to "Auto".
- The setting cannot be used in the following cases.
  - If "3. Audio Adjust" - "Dolby" - "Loudness Management" in the Setup menu is set to "Off" when playing Dolby Digital Plus or Dolby TrueHD
  - When the input signal is DTS and "Dialog Control" is other than 0 dB

**Re-EQ, Re-EQ(THX):** Adjust the soundtrack that was processed to enhance its treble, in order to make it suitable for home theater.

- This function can be used in the following listening modes: Dolby Digital, Dolby Digital Plus, Dolby TrueHD, Multichannel, DTS, DTS-ES, DTS 96/24, DTS-HD High Resolution Audio, DTS-HD Master Audio, and DTS Express.
- In Re-EQ(THX), the following listening modes can be used: THX Cinema, THX Surround EX, and THX Select2 Cinema.



## Step 3: Playing Back

**Center Spread:** Adjust the width of the sound field of the front channel when playing in the Dolby Surround listening mode.

To spread the width of the sound field to the left and right, set to "On". To concentrate sound in the center, set to "Off".

- Depending on the speaker settings, this becomes "Off".

**Dialog Control:** You can increase the dialog portion of the audio in 1 dB steps up to 6 dB so that you can make dialog easier to hear over background noise.

- This cannot be set for content other than DTS:X.
- The effect may not be selectable with some content.

#### ■ HDMI :

**HDMI OUT:** Select the HDMI OUT jack to be used for output.

**Control TV:** Set whether to enable the CEC link function for TVs connected through one of the HDMI OUT MAIN or SUB jacks.

#### ■ Information:

**Audio:** Displays the audio input source, format, number of channels, sampling frequency, listening mode, and number of output channels.

**Video:** Displays information such as the video input source, resolution, color space, color depth, 3D information, aspect ratio, and output.

**Tuner:** Displays information such as the band, frequency, and preset number. This is displayed only when "TUNER" is selected as the input source.

## 8 Other useful functions

### To adjust the sound quality

It is possible to enhance or moderate the bass and treble of front speakers. Press TONE on the main unit several times to select the desired setting from "Bass", "Treble" and "Phase Matching Bass", and turn the TONE dial to adjust.

- This cannot be set if the listening mode is Pure Audio,

Direct, or THX.

**"Bass":** Allows you to enhance or moderate the bass.

**"Treble":** Allows you to enhance or moderate the treble.

**"Phase Matching Bass":** Allows you to keep the clear midrange and effectively enhance the bass.

### Checking the Input Format

Press DISPLAY on the remote controller several times to switch the display of the main unit in order of:

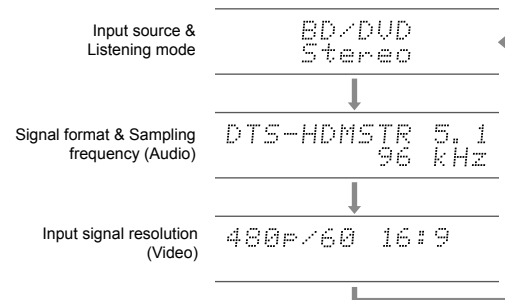

- If "Dolby D 5.1" is displayed in Signal format, the Dolby Digital 5.1 ch signals are being input. When listening to AM/FM radio, the band, frequency and preset number are displayed.

### Playing Audio and Video from Separate Sources

It is possible to play audio and video from different sources. For example, you can play audio from the CD player and video from the BD/DVD player. In this case, press BD/DVD on the remote controller and then CD. Then start playback on the BD/DVD player and CD player. This function is effective when an input with audio only has been selected (CD, NET, BLUETOOTH, TUNER, and PHONO in the initial setting). (※)

- ※ When NET or BLUETOOTH is selected, press either the NET or BLUETOOTH button then press MODE on the remote controller.



# Others

## Troubleshooting

### Before starting the procedure

Problems may be solved by simply turning the power on/off or disconnecting/connecting the power cord, which is easier than working on the connection, setting and operating procedure. Try the simple measures on both the unit and the connected device. If the problem is that the video or audio is not output or the HDMI linked operation does not work, disconnecting/connecting the HDMI cable may solve it. When reconnecting, be careful not to wind the HDMI cable since if wound the HDMI cable may not fit well. After reconnecting, turn off and on the unit and the connected device.

### The AV receiver turns off unexpectedly.

- The AV receiver will automatically enter standby mode when Auto Standby or Sleep Timer is set and launched.
- The protective circuit function may have been activated. If this has occurred, "AMP Diag Mode" appears on the display when the unit is turned on again, and the unit enters diagnostic mode. If the results of the diagnosis is that there is no problem, the "AMP Diag Mode" display disappears and you can use the unit normally again. If "CHECK SP WIRE" appears on the display, the speaker cables may be short-circuited. Make sure bare speaker wires are not touching each other or the back panel of the unit, then turn the unit on again. If "NG" is displayed, immediately unplug the power cord from the wall outlet and contact your Onkyo dealer.

### There's no sound, or it's very quiet.

- A wrong input selector button has been selected. Select a correct input for the player. Also check that muting is not on.
- Not all listening modes use all speakers.

### There's no picture.

- A wrong input selector button has been selected.
- Video input through analog jacks is not displayed if the listening mode is Pure Audio.
- To display video from the connected player on the TV screen while the unit is in standby, you need to enable HDMI Standby Through function.
- When the TV image is blurry or unclear, power code off

connection cables of the unit may have interfered. In that case, keep distance between TV antenna cable and cables of the unit.

- If you connect a player supporting HDCP2.2, be sure to connect it to one of the HDMI IN1 to IN5 jacks of the unit.

### Video and audio are out of synch

- Video may be delayed relative to audio depending on the settings and connections with your television. Adjust in "Step 3: Playing Back", "7 Quick Setup menu", "A/V Sync".

### Cannot play digital surround

- To enjoy digital surround sound including Dolby Digital and DTS, audio output should be set to "Bitstream output" on the connected Blu-ray Disc Player or other device.

### Cannot output audio such as Dolby Atmos according to the format of the source.

- If you cannot output formats such as Dolby TrueHD, Dolby Atmos, or DTS-HD Master Audio according to the format of the source, in the Blu-ray Disc Player settings try setting "BD video supplementary sound" (or secondary sound) to "Off". Change the listening mode for each source after changing the setting to confirm.

### HDMI control does not function correctly.

- Set the CEC link function of the unit to on. It is also necessary to make the HDMI linked system setting on the TV. See the TV's instruction manual for details.

### Cannot access to network.

- Try plugging/unplugging the unit or the wireless LAN router or check their power-on status. This will work well in many cases.
- If the desired wireless LAN router is not in the access point list, it may be set to hide SSID or the ANY connection may be off. Change the setting and try again.

## Resetting the unit

Resetting the unit to the status at the time of shipment may solve the problem. If the measures above do not solve the problem, reset the unit with the following procedure. If you reset the unit status, your preferences will be reset to the defaults. Note them down before starting reset.

### How to reset:

1. While holding down CBL on the main unit (note that step 2 must be performed with this button pressed down)
2. Press **ON/STANDBY** on the main unit ("Clear" appears on the display and the unit returns to standby)
  - Do not unplug the power cord until "Clear" disappears from the display.

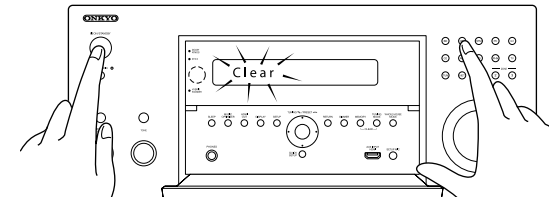

2. Press **ON/STANDBY**.

1. While holding down the CBL button

### How to reset the remote controller:

1. While holding down RCV on the remote controller, press **Q** until the remote indicator stays lit (about 3 seconds).
2. Within 30 seconds, press **RCV** again.

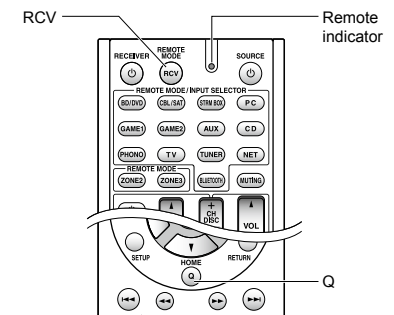

## Specifications

### Amplifier Section

#### Rated Output Power (North American)

With 8 ohm loads, both channels driven, from 20-20,000 Hz; rated 140 watts (TX-RZ900)/135 watts (TX-RZ800) per channel minimum RMS power, with no more than 0.08% total harmonic distortion from 250 milliwatts to rated output.

Surround Mode Output Power (\*)  
(6 ohms, 1 kHz THD 0.9%) 200 W (TX-RZ900)/185 W (TX-RZ800) per channel

\* Reference output for each speakers.  
Depending on the source and the listening mode settings, there may be no sound output.

#### Rated Output Power (Others)

7 ch × 200 W (TX-RZ900)/185 W (TX-RZ800) at 6 ohms, 1 kHz, 1 ch driven of 1% (IEC)

#### Maximum Effective Output Power

7 ch × 235 W (TX-RZ900)/215 W (TX-RZ800) at 6 ohms, 1 kHz, 1 ch driven (JEITA) (Asian)

#### Dynamic Power (\*)

\* IEC60268-Short-term maximum output power

320 W (TX-RZ900)/300 W (TX-RZ800) (3 Ω, Front)

270 W (TX-RZ900)/250 W (TX-RZ800) (4 Ω, Front)

160 W (TX-RZ900)/150 W (TX-RZ800) (8 Ω, Front)

#### THD+N (Total Harmonic Distortion+Noise)

0.08% (20 Hz - 20 kHz, half power)

#### Input Sensitivity and Impedance

200 mV/47 kΩ (LINE, 1 kHz 100 W/8 Ω)

3.5 mV/47 kΩ (PHONO MM)

#### Rated RCA Output Level and Impedance

1 V/470 Ω (PRE OUT)

1 V/470 Ω (SUBWOOFER PRE OUT)

100 mV/2.2 kΩ (ZONE2 LINE OUT)

1 V/2.2 kΩ (ZONE2 PRE OUT)

#### Phono Overload

70 mV (MM 1 kHz 0.5% Direct)

#### Frequency Response

5 Hz - 100 kHz/+1 dB, -3 dB (Direct mode)

#### Tone Control Characteristics

±10 dB, 20 Hz (BASS)

±10 dB, 20 kHz (TREBLE)

#### Signal to Noise Ratio

106 dB (LINE, IHF-A)

80 dB (PHONO MM, IHF-A)

#### Speaker Impedance

4 Ω - 16 Ω or 6 Ω - 16 Ω

### Video Section

#### Signal Level

1.0 Vp-p/75 Ω (Component Y)

0.7 Vp-p/75 Ω (Component Pb/Cb, Pr/Cr)

1.0 Vp-p/75 Ω (Composite)

#### Component Video Frequency Response

5 Hz - 100 MHz/+0 dB, -3 dB

#### Corresponding maximum resolution

480i/576i (Component to HDMI)

720p/1080i (Component to Component)

### Tuner Section

#### FM Tuning Frequency Range

87.5 MHz - 107.9 MHz (North American)

87.5 MHz - 108.0 MHz, RDS (Others)

#### AM Tuning Frequency Range

522/530 kHz - 1611/1710 kHz

#### Preset Channel

40

### Network Section

#### Ethernet LAN

10BASE-T/100BASE-TX

#### Wireless LAN

IEEE 802.11 b/g/n standard

(Wi-Fi® standard)

2.4 GHz band:

1 - 11 ch (North American)

10 - 11 ch (Spain)

10 - 13 ch (France)

1 - 13 ch (Others)

(Wi-Fi® standard)

### BLUETOOTH Section

#### Communication system

BLUETOOTH Specification version 2.1 +EDR (Enhanced Data Rate)

#### Maximum communication range

Line of sight approx. 15 m (\*)

#### Frequency band

2.4 GHz band

#### Modulation method

FHSS (Freq Hopping Spread Spectrum)

#### Compatible BLUETOOTH profiles

A2DP 1.2 (Advanced Audio Distribution Profile)

AVRCP 1.3 (Audio Video Remote Control Profile)

#### Supported Codecs

SBC

#### Transmission range (A2DP)

20 Hz - 20,000 Hz (Sampling frequency 44.1 kHz)

\* The actual range will vary depending on factors such as obstacles between devices, magnetic fields around a microwave oven, static electricity, cordless phone, reception sensitivity, antenna's performance, operating system, software application, etc.

### General

#### Power Supply

120 V AC, 60 Hz (North American)

220 - 240 V AC, 50/60 Hz (Others)

#### Power Consumption

8.5 A (TX-RZ900)/7.8 A (TX-RZ800) (North American)

840 W (TX-RZ900)/720 W (TX-RZ800) (Others)

0.15 W (Stand-by, North American)

0.2 W (Stand-by, Others)

2.7 W (Network Standby)

95 W (TX-RZ900)/90 W (TX-RZ800) (No-sound)

#### Dimensions (W × H × D)

435 mm × 201.5 mm × 433.5 mm

17-1/8" × 7-15/16" × 17-1/16"

#### Weight

18.0 kg (39.7 lbs.) (TX-RZ900)/17.0 kg (37.5 lbs.) (TX-RZ800)

#### • HDMI

##### Input

IN1 (BD/DVD, HDCP2.2), IN2 (CBL/SAT, HDCP2.2), IN3 (STRM BOX, HDCP2.2), IN4 (PC, HDCP2.2), IN5 (GAME1, HDCP2.2), IN6 (GAME2), IN7, AUX INPUT HDMI (front)

##### Output

OUT MAIN, OUT SUB/ZONE2

#### Video Resolution

4K 60 Hz (RGB/YCbCr4:4:4/YCbCr4:2:2, 24bit)

#### Audio Format

Dolby Atmos, Dolby TrueHD, Dolby Digital Plus, Dolby Digital, DTS:X, DTS-HD Master Audio, DTS-HD High Resolution Audio, DTS 96/24, DTS-ES, DTS, DTS Express, Multichannel PCM (up to 8ch)

#### Supported

3D, Audio Return Channel, Deep Color, x.v.Color™, LipSync, CEC, 4K, Extended Colorimetry (sYCC601, Adobe RGB, Adobe YCC601), Content Type, 3D Dual View, 21:9 Aspect Ratio Video Format

#### • Video Inputs

##### Component

IN1 (BD/DVD), IN2 (GAME2)

##### Composite

IN1 (GAME1), IN2 (CBL/SAT), IN3 (STRM BOX)

#### • Video Outputs

##### Component

OUT

##### Composite

OUT

#### • Audio Inputs

##### Digital

OPTICAL 1 (STRM BOX), 2 (CD), 3 (TV)

COAXIAL 1 (BD/DVD), 2 (CBL/SAT)

##### Analog

BD/DVD, GAME2, PC, GAME1, CBL/SAT, STRM BOX, TV, CD, PHONO

#### • Audio Outputs

##### Analog

ZONE2 PRE/LINE OUT

ZONE3 LINE OUT

PRE OUT (FRONT L/R, CENTER, SURROUND L/R, BACK or HEIGHT L/R, 2 SUBWOOFER)

##### Speaker Outputs

FRONT L/R, CENTER, SURROUND L/R, BACK L/R, HEIGHT or Bi-AMP L/R, ZONE2 L/R

##### Phones

PHONES (Front, ø 6.3)

#### • Others

Setup Mic 1 (Front)

RS232 1

RI REMOTE CONTROL 1

USB 1 (Ver. 1.1, 5 V/1 A)

Ethernet 1

IR IN 1

12V TRIGGER OUT 1 (MAIN, 100 mA)

#### Multi language on-screen display

(North American) English, German, French, Spanish, Italian, Dutch, Swedish

(Others) English, German, French, Spanish, Italian, Dutch, Swedish, Russian, Chinese (\*)

\* OSD are not displayed when input is "NET" or "BLUETOOTH".

Operate by confirming the display on the main unit.

Specifications and features are subject to change without notice.





### Table of image resolutions

Refer to the following table for information about the image formats and resolutions output by this unit in response to input signals

Input	Output	HDMI						
		4K	1080p/24	1080p	1080i	720p	480p/576p	480i/576i
HDMI	4K	✓						
	1080p/24		✓					
	1080p			✓				
	1080i				✓			
	720p					✓		
	480p/576p						✓	
	480i/576i							✓
Component	1080p							
	1080i							
	720p							
	480p/576p							
Composite	480i/576i							✓

### Resolutions supported by HDMI

#### ■ HDMI IN1 to IN5 (when using in the main room)

Copyright protection technology	Display resolution	Frame rate	Color space	Color Depth	Remarks
HDCP1.4 HDCP2.2	720 × 480i	60 Hz	RGB/YCbCr4:4:4/ YCbCr4:2:2	8/10/12/16 bit	With YCbCr4:2:2, only 12 bit Color Depth is supported.
	720 × 576i	50 Hz			
	720 × 480p	60 Hz			
	720 × 576p	50 Hz			
	1920 × 1080i	50/60 Hz			
	1280 × 720p	24/25/30/50/60 Hz			
	1680 × 720p	24/25/30/50/60 Hz			
	1920 × 1080p	24/25/30/50/60 Hz			
	2560 × 1080p	24/25/30 Hz			
		50/60 Hz			
	4K (3840 × 2160p)	24/25/30 Hz	RGB/YCbCr4:4:4	8/10/12/16 bit	
			YCbCr4:2:2	12 bit	
		50/60 Hz	RGB/YCbCr4:4:4	8bit	
			YCbCr4:2:2	12 bit	
	4K SMPTE (4096 × 2160p)	24/25/30 Hz	RGB/YCbCr4:4:4	8/10/12/16 bit	
			YCbCr4:2:2	12 bit	
		50/60 Hz	RGB/YCbCr4:4:4	8 bit	
			YCbCr4:2:2	12 bit	
2560 × 1080p	50/60 Hz	RGB/YCbCr4:4:4	8/10/12/16 bit		
		YCbCr4:2:0	8 bit		

#### ■ HDMI IN1 to IN5 (when using in Zone 2)

Copyright protection technology	Display resolution	Frame rate	Color space	Color Depth	Remarks
HDCP1.4 HDCP2.2	720 × 480i	60 Hz	RGB/YCbCr4:4:4/ YCbCr4:2:2	8/10/12/16 bit	With YCbCr4:2:2, only 12 bit Color Depth is supported.
	720 × 576i	50 Hz			
	720 × 480p	60 Hz			
	720 × 576p	50 Hz			
	1920 × 1080i	50/60 Hz			
	1280 × 720p	24/25/30/50/60 Hz			
	1680 × 720p	24/25/30/50/60 Hz			
	1920 × 1080p	24/25/30/50/60 Hz			
	2560 × 1080p	24/25/30 Hz			
		50/60 Hz			
	4K (3840 × 2160p)	24/25/30 Hz	RGB/YCbCr4:4:4	8 bit	
			YCbCr4:2:2	12 bit	
	4K SMPTE (4096 × 2160p)	24/25/30 Hz	RGB/YCbCr4:4:4	8 bit	
			YCbCr4:2:2	12 bit	
2560 × 1080p	50/60 Hz	RGB/YCbCr4:4:4	8/10/12 bit		
		YCbCr4:2:2	12 bit		

#### ■ HDMI IN6, IN7, Front

Copyright protection technology	Display resolution	Frame rate	Color space	Color Depth	Remarks
HDCP1.4	720 × 480i	60 Hz	RGB/YCbCr4:4:4/ YCbCr4:2:2	8/10/12/16 bit	With YCbCr4:2:2, only 12 bit Color Depth is supported.
	720 × 576i	50 Hz			
	720 × 480p	60 Hz			
	720 × 576p	50 Hz			
	1920 × 1080i	50/60 Hz			
	1280 × 720p	24/25/30/50/60 Hz			
	1680 × 720p	24/25/30/50/60 Hz			
	1920 × 1080p	24/25/30/50/60 Hz			
	2560 × 1080p	24/25/30 Hz			
		50/60 Hz			
	4K (3840 × 2160p)	24/25/30 Hz	RGB/YCbCr4:4:4	8 bit	
			YCbCr4:2:2	12 bit	
	4K SMPTE (4096 × 2160p)	24/25/30 Hz	RGB/YCbCr4:4:4	8 bit	
			YCbCr4:2:2	12 bit	
	2560 × 1080p	50/60 Hz	RGB/YCbCr4:4:4	8/10/12/16 bit	
			YCbCr4:2:0	8 bit	



## Precautions

### For U.S. Models

#### FEDERAL COMMUNICATIONS COMMISSION DECLARATION OF CONFORMITY

This device complies with part 15 of the FCC Rules. Operation is subject to the following two conditions:

- (1) this device may not cause interference, and
- (2) this device must accept any interference, including interference that may cause undesired operation of the device.

Product Name: AV Receiver  
 Model Number: TX-RZ900/TX-RZ800  
 Responsible Party Name: Onkyo U.S.A. Corporation  
 Address: 18 PARK WAY, UPPER SADDLE RIVER,  
 NEW JERSEY 07458, USA  
 Phone: 1-800-229-1687

### For European Models

#### Declaration of Conformity

We declare, under our sole responsibility, that this product complies with the standards:

- Safety
- Limits and methods of measurement of radio disturbance characteristics
- Limits for harmonic current emissions
- Limitation of voltage changes, voltage fluctuations and flicker
- RoHS Directive, 2011/65/EU



- Hereby, Onkyo Corporation, declares that this TX-RZ900/TX-RZ800 is in compliance with the essential requirements and other relevant provisions of Directive 1999/5/EC.
- С настоящето, Onkyo Corporation, декларира, че TX-RZ900/TX-RZ800 е в съответствие със съществените изисквания и другите приложими разпоредби на Директива 1999/5/EC.
- Onkyo Corporation tímto prohlašuje, že TX-RZ900/TX-RZ800 splňuje základní požadavky a všechna příslušná ustanovení Směrnice 1999/5/ES.
- Undertegnede Onkyo Corporation erklærer herved, at følgende udstyr TX-RZ900/TX-RZ800 overholder de væsentlige krav og øvrige relevante krav i direktiv 1999/5/EF.
- Hiermit erklärt Onkyo Corporation, dass sich das Gerät TX-RZ900/TX-RZ800 in Übereinstimmung mit den grundlegenden Anforderungen und den übrigen einschlägigen Bestimmungen der Richtlinie 1999/5/EG befindet.
- Käesolevaga kinnitab Onkyo Corporation seadme TX-RZ900/TX-RZ800 vastavust direktiivi 1999/5/EÜ põhinõuetele ja nimetatud direktiivist tulenevatele teistele asjakohastele sätetele.
- ΜΕ ΤΗΝ ΠΑΡΟΥΣΑ Ο ΚΑΤΑΣΚΕΥΑΣΤΗΣ Onkyo Corporation ΔΗΛΩΝΕΙ ΟΤΙ ΤΑ ΜΟΝΤΕΛΑ TX-RZ900/TX-RZ800 ΣΥΜΜΟΡΦΟΝΕΤΑΙ ΠΡΟΣ ΤΙΣ ΟΥΣΙΩΔΕΙΣ ΑΠΑΙΤΗΣΕΙΣ ΚΑΙ ΤΙΣ ΛΟΙΠΕΣ ΣΧΕΤΙΚΕΣ ΔΙΑΤΑΞΕΙΣ ΤΗΣ ΟΔΗΓΙΑΣ 1999/5/ΕΚ
- Por la presente, Onkyo Corporation, declara que este TX-RZ900/TX-RZ800 cumple con los requisitos esenciales y otras exigencias relevantes de la Directiva 1999/5/EC.

- Par la présente, Onkyo Corporation déclare que l'appareil TX-RZ900/TX-RZ800 est conforme aux exigences essentielles et aux autres dispositions pertinentes de la directive 1999/5/CE.
- Con la presente Onkyo Corporation dichiara che questo TX-RZ900/TX-RZ800 è conforme ai requisiti essenziali ed alle altre disposizioni pertinenti stabilite dalla direttiva 1999/5/CE.
- Ar šo Onkyo Corporation deklarē, ka TX-RZ900/TX-RZ800 atbilst Direktīvas 1999/5/EK būtiskajām prasībām un citiem ar to saistītajiem noteikumiem.
- Šiuo Onkyo Corporation deklaruoją, kad šis TX-RZ900/TX-RZ800 atitinka esminius reikalavimus ir kitas 1999/5/EB Direktyvos nuostatas.
- A Onkyo Corporation ezzennel kijelenti, hogy a TX-RZ900/TX-RZ800 típusú berendezés teljesíti az alapelvű követelményeket és más 1999/5/EK irányelvben meghatározott vonatkozó rendelkezéseket.
- Hierbij verklaart Onkyo Corporation dat het toestel I TX-RZ900/TX-RZ800 in overeenstemming is met de essentiële eisen en de andere relevante bepalingen van richtlijn 1999/5/EG.
- Niniejszym Onkyo Corporation deklaruje że TX-RZ900/TX-RZ800 jest zgodny z zasadniczymi wymaganiami i innymi właściwymi postanowieniami Dyrektywy 1999/5/EC.
- Eu, Onkyo Corporation, declaro que o TX-RZ900/TX-RZ800 cumpre os requisitos essenciais e outras provisões relevantes da Directiva 1999/5/EC.
- Prin prezenta, Onkyo Corporation, declară că aparatul TX-RZ900/TX-RZ800 este în conformitate cu cerințele esențiale și cu alte prevederi pertinente ale Directivei 1999/5/CE.
- Onkyo Corporation tímto vyhlasuje, že TX-RZ900/TX-RZ800 a splňa základné požiadavky a všetky príslušné ustanovenia Smernice 1999/5/ES.
- Onkyo Corporation izjavlja, da je ta TX-RZ900/TX-RZ800 v skladu z bistvenimi zahtevami in drugimi relevantnimi določili direktive 1999/5/ES.
- Onkyo Corporation vakuuttaa täten että TX-RZ900/TX-RZ800 tyyppinen laite on direktiivin 1999/5/EY oleellisten vaatimusten ja sitä koskevien direktiivin muiden ehtojen mukainen.
- Härmed förklarar Onkyo Corporation att denna TX-RZ900/TX-RZ800 följer de väsentliga kraven och andra relevanta stadgar i Direktiv 1999/5/EC.
- Hér með lýsir Onkyo Corporation því yfir að varan TX-RZ900/TX-RZ800 er í samræmi við grunnkröfur og aðrar kröfur sem gerðar eru í tilskipun 1999/5/EC.
- Onkyo Corporation erklærer herved at denne TX-RZ900/TX-RZ800 er i overensstemmelse med væsentlige krav og andre relevante bestemmelser i direktiv 1999/5/EC.
- Ovime Onkyo Corporation, potvrđuje da je TX-RZ900/TX-RZ800 u suglasnosti sa osnovnim zahtjevima i ostalim relevantnim odredbama Direktive 1999/5/EC.



## License and Trademark Information



Manufactured under license from Dolby Laboratories. Dolby, Dolby Atmos, Dolby Surround, Surround EX and the double-D symbol are trademarks of Dolby Laboratories.



For DTS patents, see <http://patents.dts.com>. Manufactured under license from DTS, Inc. DTS, the Symbol, DTS in combination with the Symbol, the DTS-HD logo, and DTS-HD Master Audio are registered trademarks or trademarks of DTS, Inc. in the United States and/or other countries. © DTS, Inc. All Rights Reserved.



Manufactured under license from THX Ltd. THX and the THX logo are registered in the U.S. and other jurisdictions. All rights reserved. Surround EX is a trademark of Dolby Laboratories. Used with permission. U.S. Pat. nos. 7,254,239 & 7,593,533 & 7,974,425 & 8,452,028 & 8,509,457 Taiwan Pat. I238671 European Pat. 1,360,874

### THX Select2 Plus

Before any home theater component can be THX Select2 Plus certified, it must pass a rigorous series of quality and performance tests. Only then can a product feature the THX Select2 Plus logo, which is your guarantee that the Home Theater products you purchase will give you superb performance for many years to come. THX Select2 Plus requirements define hundreds of parameters, including power amplifier performance, and integrated amplifier performance and operation for both digital and analog domains. THX Select2 Plus receivers also feature proprietary THX technologies (e.g., THX Mode) which accurately translate movie soundtracks for home theater playback.

Re-Equalization and the "Re-EQ" logo are trademarks of THX Ltd.



The terms HDMI and HDMI High-Definition Multimedia Interface, and the HDMI Logo are trademarks or registered trademarks of HDMI Licensing LLC in the United States and other countries.



The Wi-Fi CERTIFIED Logo is a certification mark of the Wi-Fi Alliance®.



AirPlay, iPad, iPhone, and iPod touch are trademarks of Apple Inc., registered in the U.S. and other countries.



iPad Air and iPad mini are trademarks of Apple Inc.

"Made for iPod", "Made for iPhone" and "Made for iPad" mean that an electronic accessory has been designed to connect specifically to iPod, iPhone, or iPad, respectively, and has been certified by the developer to meet Apple performance standards. Apple is not responsible for the operation of this device or its compliance with safety and regulatory standards.

Please note that the use of this accessory with iPod, iPhone or iPad may affect wireless performance.

AirPlay works with iPhone, iPad, and iPod touch with iOS 4.3.3 or later, Mac with OS X Mountain Lion or later, and PC with iTunes 10.2.2 or later.

Apple, Apple TV and Safari are trademarks of Apple Inc., registered in the U.S. and other countries.



The BLUETOOTH® word mark and logos are registered trademarks owned by Bluetooth SIG, Inc. and any use of such marks by Onkyo Corporation is under license. Other trademarks and trade names are those of their respective owners.

Onkyo Corporation does not guarantee BLUETOOTH compatibility between the AV receiver and all BLUETOOTH enabled devices. For compatibility between the AV receiver and another device with BLUETOOTH technology, consult the device's documentation and dealer. In some countries, there may be restrictions on using BLUETOOTH devices. Check with your local authorities.



SIRIUS, XM and all related marks and logos are trademarks of Sirius XM Radio Inc. and its subsidiaries. All rights reserved.

DLNA®, the DLNA Logo and DLNA CERTIFIED® are trademarks, service marks, or certification marks of the Digital Living Network Alliance.

This product is protected by certain intellectual property rights of Microsoft. Use or distribution of such technology outside of this product is prohibited without a license from Microsoft.

Windows and the Windows logo are trademarks of the Microsoft group of companies.

QR Code is a registered trademark of DENSO WAVE INCORPORATED.

"x.v.Color" and "x.v.Color" logo are trademarks of Sony Corporation.

DSD and the Direct Stream Digital logo are trademarks of Sony Corporation.

MPEG Layer-3 audio coding technology licensed from Fraunhofer IIS and Thomson.

AccuEQ, Music Optimizer, RIHD and WRAT are trademarks of Onkyo Corporation.

"All other trademarks are the property of their respective owners."

## DISCLAIMER

Through this device you are able to link to other services or websites

which are not under the control of any company which has designed, manufactured or distributed/have distributed this device, and its affiliates (collectively, "Company"). We have no control over the nature, content and availability of those services. The inclusion of any links does not necessarily imply a recommendation or endorse the views expressed within them.

All information, content and services available through this device belong to third parties and are protected by copyright, patent, trademark and/or other intellectual property laws of applicable countries.

The information, content and services provided through this device are for your personal, noncommercial use only. Any information, content or services may not be used in any manner other than previously approved by the appropriate content owner or service provider.

You may not modify, copy, republish, translate, exploit, create derivative works, upload, post, transmit, sell or distribute in any manner any information, content or services available through this device, unless expressly permitted by the appropriate copyright, patent, trademark and/or other intellectual property owner, including, without limitation, content owner or service provider.

THE CONTENT AND SERVICES AVAILABLE THROUGH THIS DEVICE ARE PROVIDED "AS IS".

COMPANY DOES NOT WARRANT INFORMATION, CONTENT OR SERVICES SO PROVIDED, EITHER EXPRESSLY OR IMPLIEDLY, FOR ANY PURPOSE.

COMPANY EXPRESSLY DISCLAIMS ANY WARRANTIES, EXPRESS OR IMPLIED, INCLUDING BUT NOT LIMITED TO, WARRANTIES OF TITLE, NON-INFRINGEMENT, MERCHANTABILITY OR FITNESS FOR A PARTICULAR PURPOSE.

Company makes no representation or warranty of any kind, express or implied, about the completeness, accuracy, validity, legality, reliability, suitability or availability with respect to the information, content or services available through this device. Company shall not be liable, whether in contract or tort, including negligence and strict liability, for any direct, indirect, special, incidental or consequential damages or any other damages arising out of, or in connection with, any information contained in, or as a result of the use of any content or service by you or any third party, even if Company has been advised of the possibility of such damages, nor shall Company be liable for any third party claims against users of this device or any third party.

In no event shall Company be responsible nor liable for, without limiting the generality of the foregoing, any interruption or suspension of any information, content or service available through this device. Company is neither responsible nor liable for customer service related to the information, content and services available through this device. Any question or request for service relating to the information, content or services should be made directly to the appropriate content owners and services providers.



## GNUライセンス

### Important Notice Regarding Software

The software package installed in this product includes software licensed to Onkyo Corporation (hereinafter, called "Onkyo") directly or indirectly by third party developers. Please be sure to read this notice regarding such software.

### Notice Regarding GNU GPL/GPL-applicable Software

This product includes the following software that is covered by GNU General Public License (hereinafter, called "GPL") or by GNU Lesser General Public License (hereinafter, called "LGPL"). Onkyo notifies you that, according to the attached GPL/GPL, you have right to obtain, modify, and redistribute software source code for the listed software.

### ソフトウェアに関する重要なお知らせ

本製品に掲載されるソフトウェアには、オンキョー株式会社（以下「弊社」とします）が第三者より間接的又は間接的に使用の許諾を受けたソフトウェアが含まれております。これらのソフトウェアに関する本お知らせを必ずご一読くださいますようお願い申し上げます。

### GNU GPL/LGPL 適用ソフトウェアに関するお知らせ

本製品には、以下のGNU General Public License（以下「GPL」とします）またはGNU Lesser General Public License（以下「LGPL」とします）の適用を受けるソフトウェアが含まれております。

お客様は添付のGPL/LGPLに従いこれらのソフトウェアソースコードの入手、改変、再配布の権利があることをお知らせいたします。

#### Package List パッケージリスト

libc	iClibc	busybox
libgcc	libstdc++	binutils
compat-wireless	wpa_supplicant	dnsmasq
libcov	bluez	dbus
iperf	faad	

これらのソースコードのご提供に関しましては、コールセンターにお問い合わせください。  
なお、ソースコードの中身についてのお問い合わせはご遠慮ください。

## GNU LESSER GENERAL PUBLIC LICENSE

### Version 2.1, February 1999

Copyright (C) 1991, 1999 Free Software Foundation, Inc. 59 Temple Place, Suite 330, Boston, MA 02111-1307 USA Everyone is permitted to copy and distribute verbatim copies of this license document, but changing it is not allowed. [This is the first released version of the Lesser GPL. It also counts as the successor of the GNU Library Public License, version 2, hence the version number 2.1.]

### Preamble

The licenses for most software are designed to take away your freedom to share and change it. By contrast, the GNU General Public Licenses are intended to guarantee your freedom to share and change free software—to make sure the software is free for all its users.

This license, the Lesser General Public License, applies to some specially designated software packages—typically libraries—of the Free Software Foundation and other authors who decide to use it. You can use it too, but we suggest you first think carefully about whether this license or the ordinary General Public License is the better strategy to use in any particular case, based on the explanations below.

When we speak of free software, we are referring to freedom of use, not price. Our General Public Licenses are designed to make sure that you have the freedom to distribute copies of free software (and charge for this service if you wish); that you receive source code or can get it if you want it; that you can change the software and use pieces of it in new programs; and that you are informed that you can do these things.

To protect your rights, we need to make restrictions that forbid distributors to deny you these rights or to ask you to surrender these rights. These restrictions translate to certain responsibilities for you if you distribute copies of the library or if you modify it. For example, if you distribute copies of the library, whether gratis or for a fee, you must give the recipients all the rights that we give you. You must make sure that they, too, receive or can get the source code. If you link other code with the library, you must provide complete object files to the recipients, so that they can relink them with the library after making changes to the library and recompiling it. And you must show them these terms so they know their rights.

We protect your rights with a two-step method: (1) we copyright the library, and (2) we offer you this license, which gives you legal permission to copy, distribute and/or modify the library. To protect each distributor, we want to make it very clear that there is no warranty for the free library. Also, if the library is modified by someone else and passed on, the recipients should know that what they have is not the original version, so that the original author's reputation will not be affected by problems that might be introduced by others.

Finally, software patents pose a constant threat to the existence of any free program. We wish to make sure that a company cannot effectively restrict the users of a free program by obtaining a restrictive license from a patent holder. Therefore, we insist that any patent license obtained for a version of the library must be consistent with the full freedom of use specified in this license. Most GNU software, including some libraries, is covered by the ordinary GNU General Public License. This license, the GNU Lesser General Public License, applies to certain designated libraries, and is quite different from the ordinary General Public License. We use this license for certain libraries in order to permit linking those libraries into non-free programs.

When a program is linked with a library, whether statically or using a shared library, the combination of the two is legally speaking a combined work, a derivative of the original library. The ordinary General Public License therefore permits such linking only if the entire combination fits its criteria of freedom. The Lesser General Public License permits more lax criteria for linking other code with the library.

We call this license the "Lesser" General Public License because it does Less to protect the user's freedom than the ordinary General Public License. It also provides other free software developers Less of an advantage over competing non-free programs. These disadvantages are the reason we use the ordinary General Public License for many libraries. However, the Lesser license provides advantages in certain special circumstances.

For example, on rare occasions, there may be a special need to encourage the widest possible use of a certain library, so that it becomes a de-facto standard. To achieve this, non-free programs must be allowed to use the library. A more frequent case is that a free library does the same job as widely used non-free libraries. In this case, there is little to gain by limiting the free library to free software only, so we use the Lesser General Public License.

In other cases, permission to use a particular library in non-free programs enables a greater number of people to use a large body of free software. For example, permission to use the GNU C Library in non-free programs enables many more people to use the

whole GNU operating system, as well as its variant, the GNU/Linux operating system.

Although the Lesser General Public License is Less protective of the users' freedom, it does ensure that the user of a program that is linked with the Library has the freedom and the wherewithal to run that program using a modified version of the Library. The precise terms and conditions for copying, distribution and modification follow. Pay close attention to the difference between a "work based on the library" and a "work that uses the library". The former contains code derived from the library, whereas the latter must be combined with the library in order to run.

### TERMS AND CONDITIONS FOR COPYING, DISTRIBUTION AND MODIFICATION

0. This License Agreement applies to any software library or other program which contains a notice placed by the copyright holder or other authorized party saying it may be distributed under the terms of this Lesser General Public License (also called "this License"). Each license is addressed as "you".

A "library" means a collection of software functions and/or data prepared so as to be conveniently linked with application programs (which use some of those functions and data) to form executables.

The "Library", below, refers to any such software library or work which has been distributed under these terms. A "work based on the Library" means either the Library or any derivative work under copyright law: that is to say, a work containing the Library or a portion of it, either verbatim or with modifications and/or translated straightforwardly into another language. (Hereinafter, translation is included without limitation in the term "modification".)

"Source code" for a work means the preferred form of the work for making modifications to it. For a library, complete source code means all the source code for all modules it contains, plus any associated interface definition files, plus the scripts used to control compilation and installation of the library.

Activities other than copying, distribution and modification are not covered by this License; they are outside its scope. The act of running a program using the Library is not restricted, and output from such a program is covered only if its contents constitute a work based on the Library (independent of the use of the Library in a tool for writing it). Whether that is true depends on what the Library does and what the program that uses the Library does.

1. You may copy and distribute verbatim copies of the Library's complete source code as you receive it, in any medium, provided that you conspicuously and appropriately publish on each copy an acknowledgment of receipt of this copyright notice and disclaimer of warranty; keep intact all the notices that refer to this License and to the absence of any warranty; and distribute a copy of this License along with the Library.

You may charge a fee for the physical act of transferring a copy, and you may at your option offer warranty protection in exchange for a fee.

2. You may modify your copy or copies of the Library or any portion of it, thus forming a work based on the Library, and copy and distribute such modifications or your work under the terms of Section 1 above, provided that you also meet all of these conditions:

- The modified work must itself be a software library.
- You must cause the files modified to carry prominent notices stating that you changed the files and the date of any change.
- You must cause the whole of the work to be licensed at no charge to all third parties under the terms of this License.
- If a facility in the modified Library refers to a function or a table of data to be supplied by an application program that uses the facility, other than an argument passed when the facility is invoked, then you must make a good faith effort to ensure that, in the event an application does not supply such function or table, the facility still operates, and performs whatever part of its purpose remains meaningful.

(For example, a function in a library to compute square roots has a purpose that is entirely well-defined independent of the application. Therefore, Subsection 2d requires that any application-supplied function or table used by this function must be optional: if the application does not supply it, the square root function must still compute square roots.)

These requirements apply to the modified work as a whole. If identifiable sections of that work are not derived from the Library, and can be reasonably considered independent and separate works in themselves, then this License, and its terms, do not apply to those sections; they are treated as separate works. But when you distribute the same sections as part of a whole which is a work based on the Library, the distribution of the whole must be on the terms of this License, whose permissions for other licensees extend to the entire whole, and thus to each and every part regardless of who wrote it.

Thus, it is not the intent of this section to claim rights or contest your rights to work written entirely by you; rather, the intent is to exercise the right to control the distribution of derivative or collective works based on the Library.

In addition, the mere aggregation of another work not based on the Library with the Library (or with a work based on the Library) on a volume of a storage or distribution medium does not bring the other work under the scope of this License.

3. You may opt to apply the terms of the ordinary GNU General Public License instead of this License to a given copy of the Library. To do this, you must alter all the notices that refer to this License, so that they refer to the ordinary GNU General Public License, version 2, instead of to this License. (If a newer version than version 2 of the ordinary GNU General Public License has appeared, then you can specify that version instead if you wish.)

Do not make any other change in these notices.

4. This option is intended to allow you to provide a separate copy of the Library, which you can distribute under the terms of the ordinary GNU General Public License, version 2, instead of to this License. (If a newer version than version 2 of the ordinary GNU General Public License has appeared, then you can specify that version instead if you wish.)

5. A program that contains no derivative of any portion of the Library, but is designed to work with the Library by being compiled or linked with it, is called a "work that uses the Library". Such a work, in isolation, is not a derivative work of the Library, and therefore falls outside the scope of this License.

However, linking a "work that uses the Library" with the Library creates an executable that is a derivative of the Library (because it contains portions of the Library), rather than a "work that uses the Library". The executable is therefore covered by this License. Section 6 states terms for distribution of such executables.

When a "work that uses the Library" uses material from a header file that is part of the Library, the object code for the work may be a derivative work of the Library even though the source code is not. Whether this is true is especially significant if the work can be linked without the Library, or if the work is itself a library. The threshold for this to be true is not precisely defined by law. If such an object file uses only numerical parameters, data structure layouts and accessors, and small macros and small inline functions (ten lines or less in length), then the use of the object file is unrestricted, regardless of whether it is legally a derivative work. (Executables containing this object code plus portions of the Library will still fall under Section 6.)

Otherwise, if the work is a derivative of the Library, you may distribute the object code for the work under the terms of Section 6. Any executables containing that work also fall under Section 6, whether or not they are linked directly with the Library itself.

6. As an exception to the Sections above, you may also combine or link a "work that uses the Library" with the Library to produce a work containing portions of the Library, and distribute that work under terms of your choice, provided that the terms permit modification of the work for the customer's own use and reverse engineering for debugging such modifications.

You must give prominent notice with each copy of the work that the Library is used in it and that the Library and its use are

covered by this License. You must supply a copy of this License. If the work during execution displays copyright notices, you must include the copyright notice for the Library among them, as well as a reference directing the user to the copy of this License. Also, you must do one of these things:

- Accompany the work with the complete corresponding machine-readable source code for the Library including whatever changes were used in the work (which must be distributed under Sections 1 and 2 above); and, if the work is an executable linked with the Library, with the complete machine-readable "work that uses the Library", as object code and/or source code, so that the user can modify the Library and then link to produce a modified executable. (It is understood that the user who changes the contents of definitions files in the Library will not necessarily be able to recompile the application to use the modified definitions.)
- Use a suitable shared library mechanism for linking with the Library. A suitable mechanism is one that (1) uses at run time a copy of the library already present on the user's computer system, rather than copying library functions into the executable, and (2) will operate properly with a modified version of the library, if the user installs one, as long as the modified version is interface-compatible with the version that the work was made with.
- Accompany the work with a written offer, valid for at least three years, to give the same user the materials specified in Subsection 6a, above, for a charge no more than the cost of performing this distribution.
- If distribution of the work is made by offering access to copy from a designated place, offer equivalent access to copy the above specified materials from the same place.
- Verify that the user has already received a copy of these materials or that you have already sent this user a copy.

For an executable, the required form of the "work that uses the Library" must include any data and utility programs needed for reproducing the executable from it. However, as a special exception, the materials to be distributed need not include anything that is normally distributed (in either source or binary form) with the major components (compiler, kernel, and so on) of the operating system on which the executable runs, unless that component itself accompanies the executable.

It may happen that this requirement contradicts the license restrictions of other proprietary libraries that do not normally accompany this operating system. Such a contradiction means you cannot use both them and the Library together in an executable that you distribute.

7. You may place library facilities that are a work based on the Library side-by-side in a single library together with other library facilities not covered by this License, and distribute such a combined library, provided that the separate distribution of the work based on the Library and of the other library facilities is otherwise permitted, and provided that you do these two things:

- Accompany the combined library with a copy of the same work based on the Library, uncombined with any other library facilities. This must be distributed under the terms of the Sections above.
- Give prominent notice with the combined library of the fact that part of it is a work based on the Library, and explaining where to find the accompanying uncombined form of the same work.

8. You may not copy, modify, sublicense, link with, or distribute the Library except as expressly provided under this License. Any attempt otherwise to copy, modify, sublicense, link with, or distribute the Library is void, and will automatically terminate your rights under this License. However, parties who have received copies, or rights, from you under this License will not have their licenses terminated so long as such parties remain in full compliance.

9. You are not required to accept this License, since you have not signed it. However, nothing else grants you permission to modify or distribute the Library or its derivative works. These actions are prohibited by law if you do not accept this License. Therefore, by modifying or distributing the Library (or any work based on the Library), you indicate your acceptance of this License to do so, and all its terms and conditions for copying, distributing or modifying the Library or works based on it.

10. Each time you redistribute the Library (or any work based on the Library), the recipient automatically receives a license from the original licensor to copy, distribute, link with or modify the Library subject to these terms and conditions, then as a consequence you may not impose any further restrictions on the recipient's exercise of the rights granted herein. You are not responsible for enforcing compliance by third parties with this License.

11. If, as a consequence of a court judgment or allegation of patent infringement or for any other reason (not limited to patent issues), conditions are imposed on you (whether by court order, agreement or otherwise) that contradict the conditions of this License, they do not excuse you from the conditions of this License. If you cannot distribute so as to satisfy simultaneously your obligations under this License and any other pertinent obligations, then as a consequence you may not distribute the Library at all. For example, if a patent license would not permit royalty-free redistribution of the Library by all those who receive copies directly or indirectly through you, then the only way you could satisfy both it and this License would be to refrain entirely from distribution of the Library.

If any portion of this section is held invalid or unenforceable under any particular circumstance, the balance of the section is intended to apply, and the section as a whole is intended to apply in other circumstances.

12. If the distribution and/or use of the Library is restricted in certain countries either by patents or by copyrighted interfaces, the original copyright holder who places the Library under this License may add an explicit geographical distribution limitation excluding those countries, so that distribution is permitted only in or among countries not thus excluded. In such case, this License incorporates the limitation as if written in the body of this License.

13. The Free Software Foundation may publish revised and/or new versions of the Lesser General Public License from time to time. Such new versions will be similar in spirit to the present version, but may differ in detail to address new problems or concerns.

Each version is given a distinguishing version number. If the Library specifies a version number of this License which applies to it and "any later version", you have the option of following the terms and conditions either of that version or of any later version published by the Free Software Foundation. If the Library does not specify a license version number, you may choose any version ever published by the Free Software Foundation.

14. If you wish to incorporate parts of the Library into other free programs whose distribution conditions are incompatible with these, write to the author to ask for permission. For software which is copyrighted by the Free Software Foundation, write to the Free Software Foundation; we sometimes make exceptions for this. Our decision will be guided by the two goals of preserving the free status of all derivatives of our free software and of promoting the sharing and reuse of software generally.

**NO WARRANTY**

**15. BECAUSE THE LIBRARY IS LICENSED FREE OF CHARGE, THERE IS NO WARRANTY FOR THE LIBRARY, TO THE EXTENT PERMITTED BY APPLICABLE LAW. EXCEPT WHEN OTHERWISE STATED IN WRITING THE COPYRIGHT HOLDERS AND/OR OTHER PARTIES PROVIDE THE LIBRARY "AS IS" WITHOUT WARRANTY OF ANY KIND, EITHER EXPRESSED OR IMPLIED, INCLUDING, BUT NOT LIMITED TO, THE IMPLIED WARRANTIES OF MERCHANTABILITY AND FITNESS FOR A PARTICULAR PURPOSE. THE ENTIRE RISK AS TO THE QUALITY AND PERFORMANCE OF THE LIBRARY IS WITH YOU. SHOULD THE LIBRARY PROVE DEFECTIVE, YOU ASSUME THE**



COST OF ALL NECESSARY SERVICING, REPAIR OR CORRECTION. IN NO EVENT UNLESS REQUIRED BY APPLICABLE LAW OR AGREED TO IN WRITING WILL ANY COPYRIGHT HOLDER, OR ANY OTHER PARTY WHO MAY MODIFY AND/OR REDISTRIBUTE THE LIBRARY AS PERMITTED ABOVE, BE LIABLE TO YOU FOR DAMAGES, INCLUDING ANY GENERAL, SPECIAL, INCIDENTAL OR CONSEQUENTIAL DAMAGES ARISING OUT OF THE USE OR INABILITY TO USE THE LIBRARY (INCLUDING BUT NOT LIMITED TO LOSS OF DATA OR DATA BEING RENDERED INACCURATE OR LOSSES SUSTAINED BY YOU OR THIRD PARTIES OR A FAILURE OF THE LIBRARY TO OPERATE WITH ANY OTHER SOFTWARE), EVEN IF SUCH HOLDER OR OTHER PARTY HAS BEEN ADVISED OF THE POSSIBILITY OF SUCH DAMAGES.

## END OF TERMS AND CONDITIONS

### How to Apply These Terms to Your New Libraries

If you develop a new library, and you want it to be of the greatest possible use to the public, we recommend making it free software that everyone can redistribute and change. You can do so by permitting redistribution under these terms (or, alternatively, under the terms of the ordinary General Public License).

To apply these terms, attach the following notices to the library. It is safest to attach them to the start of each source file to most effectively convey the exclusion of warranty, and each file should have at least the "copyright" line and a pointer to where the full notice is found.

-one line to give the library's name and an idea of what it does >

Copyright (C) <year> <name of author>

This library is free software; you can redistribute it and/or modify it under the terms of the GNU Lesser General Public License as published by the Free Software Foundation; either version 2.1 of the License, or (at your option) any later version.

This library is distributed in the hope that it will be useful, but WITHOUT ANY WARRANTY; without even the implied warranty of MERCHANTABILITY or FITNESS FOR A PARTICULAR PURPOSE. See the GNU Lesser General Public License for more details.

You should have received a copy of the GNU Lesser General Public License along with this library; if not, write to the Free Software Foundation, Inc., 59 Temple Place, Suite 330, Boston, MA 02111-1307, USA

Also add information on how to contact you by electronic and paper mail.

You should also get your employer (if you work as a programmer) or your school, if any, to sign a "copyright disclaimer" for the library, if necessary. Here is a sample; alter the names:

Yoodyne, Inc., hereby disclaims all copyright interest in the library 'Frob' (a library for tweaking knobs) written by James Random Hacker.

signature of Ty Coon, 1 April 1990

Ty Coon, President of Vice

That's all there is to it.

GNU GENERAL PUBLIC LICENSE

Version 2, June 1991

Copyright (C) 1989, 1991 Free Software Foundation, Inc. 59 Temple Place - Suite 330, Boston, MA 02111-1307, USA

Everyone is permitted to copy and distribute verbatim copies of this license document, but changing it is not allowed.

Preamble

The licenses for most software are designed to take away your freedom to share and change it. By contrast, the GNU General Public License is intended to guarantee your freedom to share and change free software—to make sure the software is free for all its users. This General Public License applies to most of the Free Software Foundation's software and to any other program whose authors commit to using it. (Some other Free Software Foundation software is covered by the GNU Library General Public License instead.) You can apply it to your programs, too.

When we speak of free software, we are referring to freedom, not price. Our General Public Licenses are designed to make sure that you have the freedom to distribute copies of free software (and not charge for this service if you wish), that you receive source code or can get it if you want it, that you can change the software or use pieces of it in new free programs; and that you know you can do these things.

To protect your rights, we need to make restrictions that forbid anyone to deny you these rights or to ask you to surrender the rights. These restrictions translate to certain responsibilities for you if you distribute copies of the software, or if you modify it. For example, if you distribute copies of such a program, whether gratis or for a fee, you must give the recipients all the rights that you have. You must make sure that they, too, receive or can get the source code. And you must show them these terms so they know their rights.

We have your rights with two steps: (1) copyright the software, and (2) offer you this license which gives you legal permission to copy, distribute and/or modify the software.

Also, for each author's protection and ours, we want to make certain that everyone understands that there is no warranty for this free software. If the software is modified by someone else and passed on, we want its recipients to know that what they have is not the original, so that any problems introduced by others will not reflect on the original authors' reputations.

Finally, any free program is threatened constantly by software patents. We wish to avoid the danger that redistributors of a free program will individually obtain patent licenses, in effect making the program proprietary. To prevent this, we have made it clear that any patent must be licensed for everyone's free use or not licensed at all.

The precise terms and conditions for copying, distribution and modification follow.

TERMS AND CONDITIONS FOR COPYING, DISTRIBUTION AND MODIFICATION

This license applies to any program or other work which contains a notice placed by the copyright holder stating it may be distributed under the terms of this General Public License. The "Program", below, refers to any such program or work, and a "work based on the Program" means either the Program or any derivative work under copyright law: that is to say, a work containing the Program or a portion of it, either verbatim or with modifications and/or translated into another language. (Hereinafter, translation is included without limitation in the term "modification".) Each licensee is addressed as "you".

Activities other than copying, distribution and modification are not covered by this License; they are outside its scope. The act of running the Program is not restricted, and the output from the Program is covered only if its contents constitute a work based on the Program (independent of having been made by running the Program). Whether that is true depends on what the Program does.

You may copy and distribute verbatim copies of the Program's source code as you receive it, in any medium, provided that you conspicuously and appropriately publish on each copy an appropriate copyright notice and disclaimer of the Program a copy of this License along with the Program.

You may charge a fee for the physical act of transferring a copy, and you may at your option offer warranty protection in exchange for a fee.

You may modify your copy or copies of the Program or any portion of it, thus forming a work based on the Program, and copy and distribute such modifications or work under the terms of Section 1 above, provided that you also meet all of these conditions:

a) You must cause the modified files to carry prominent notices stating that you changed the files and the date of any change.

b) You must cause any work that you distribute or publish, that in whole or in part contains or is derived from the Program or any part thereof, to be licensed as a whole to all third parties under the terms of this License.

c) If the modified program normally reads commands interactively when run, you must cause it, when started running for such interactive use in the most ordinary way, to print or display an announcement including an appropriate copyright notice and a notice that there is no warranty (or, if you provide a warranty, that that users may redistribute the program under these conditions, and telling the user how to view a copy of this License. (Exception: If the Program itself is

interactive but does not normally print such an announcement, your work based on the Program is not required to print an announcement.)

These requirements apply to the modified work as a whole. If identifiable sections of that work are not derived from the Program, and can be reasonably considered independent and separate works in themselves, then this License, and its terms, do not apply to those sections when you distribute them as separate works. But when you distribute the same sections as part of a whole which is a work based on the Program, the distribution of the whole must be on the terms of this License, whose permissions for other licenses extend to the entire whole, and thus to each and every part regardless of who wrote it.

Thus, it is not the intent of this section to claim rights or contest your rights to work written entirely by you; rather, the intent is to exercise the right to control the distribution of derivative or collective works based on the Program.

In addition, mere aggregation of another work not based on the Program with the Program (or with a work based on the Program) on a volume of a storage or distribution medium does not bring the other work under the scope of this License.

You may copy and distribute the Program (or a work based on it, under Section 2) in object code or executable form under the terms of Sections 1 and 2 above provided that you also do one of the following:

a) Accompany it with the complete corresponding machine-readable source code, which must be distributed under the terms of Sections 1 and 2 above on a medium customarily used for software interchange; or

b) Accompany it with a written offer, valid for at least three years, to give any third party, for a charge no more than your cost of physically performing source distribution, a complete machine-readable copy of the corresponding source code, to be distributed under the terms of Sections 1 and 2 above on a medium customarily used for software interchange; or,

c) Accompany it with the information you received as to the offer to distribute corresponding source code. (This alternative is allowed only for noncommercial distribution and only if you received the program in object code or executable form with such an offer, in accord with Subsection b) above.)

The source code for a work means the preferred form of the work for making modifications to it. For an executable work, complete source code means all the source code for all modules it contains, plus any associated interface definition files, plus the scripts used to control compilation and installation of the executable. However, as a special exception, the source code distributed need not include anything that is normally distributed (in either source or binary form) with the major components (compiler, kernel, and so on) of the operating system on which the executable runs, unless that component itself accompanies the executable.

If distribution of executable or object code is made by offering access to copy from a designated place, then offering equivalent access to copy the source code from the same place counts as distribution of the source code, even though third parties are not compelled to copy the source along with their copy.

You may not copy, modify, sublicense, or distribute the Program except as expressly provided under this License. Any attempt otherwise to copy, modify, sublicense or distribute the Program is void, and will automatically terminate your rights under this License. However, parties who have received copies, or rights, from you under this License will not have their licenses terminated so long as such parties remain in full compliance.

You are not required to accept this License, since you have not signed it. However, nothing else grants you permission to modify or distribute the Program or its derivative works. These actions are prohibited by law if you do not accept this License. Therefore, by modifying or distributing the Program (or any work based on the Program), you indicate your acceptance of this License to do so, and all its terms and conditions for copying, distributing or modifying the Program or works based on it.

Each time you redistribute the Program (or any work based on the Program), the recipient automatically receives a license from the original licensor to copy, distribute or modify the Program subject to these terms and conditions. You may not impose any further restrictions on the recipients' exercise of the rights granted herein. You are not responsible for enforcing compliance by third parties to this License.

If, as a consequence of a court judgment or allegation of patent infringement or for any other reason (not limited to patent issues), conditions are imposed on you (whether by court order, agreement or otherwise) that contradict the conditions of this License, they do not excuse you from the conditions of this License. If you cannot distribute so as to satisfy simultaneously your obligations under this License and any other pertinent obligations, then as a consequence you may not distribute the Program at all. For example, if a patent license would not permit royalty-free redistribution of the Program by all those who receive copies directly or indirectly through you, then the only way you could satisfy both it and this License would be to refrain entirely from distribution of the Program.

If any portion of this section is held invalid or unenforceable under any particular circumstance, the balance of the section is intended to apply and the section as a whole is intended to apply in other circumstances.

It is not the purpose of this section to induce you to infringe any patents or other property rights claims or to contest validity of any such claims; this section has the sole purpose of protecting the integrity of the free software distribution system, which is implemented by public license practices. Many people have made generous contributions to the wide range of software distributed through that system in reliance on consistent application of that system; it is up to the author/donor to decide if he or she is willing to distribute software through any other system and a licensee cannot impose that choice.

This section is intended to make thoroughly clear what is believed to be a consequence of the rest of this License.

If the distribution and/or use of the Program is restricted in certain countries either by patents or by copyrighted interfaces, the original copyright holder who places the Program under this License may add explicit geographical distribution limitation excluding those countries, so that distribution is permitted only in or among countries not thus excluded. In such case, this License incorporates the limitation as if written in the body of this License.

The Free Software Foundation may publish revised and/or new versions of the General Public License from time to time. Such new versions will be similar in spirit to the present version, but may differ in detail to address new problems or concerns. Each version is given a distinguishing version number. If the Program specifies a version number of this License which applies to it and "any later version", you have the option of following the terms and conditions either of that version or of any later version published by the Free Software Foundation. If the Program does not specify a version number of this License, you may choose any version ever published by the Free Software Foundation.

If you wish to incorporate parts of the Program into other free programs whose distribution conditions are different, write to the author to ask for permission. For software which is copyrighted by the Free Software Foundation, write to the Free Software Foundation; we sometimes make exceptions for this. Our decision will be guided by the two goals of preserving the free status of all derivatives of our free software and of promoting the sharing and reuse of software generally.

NO WARRANTY  
BECAUSE THE PROGRAM IS LICENSED FREE OF CHARGE, THERE IS NO WARRANTY FOR THE PROGRAM, TO THE EXTENT PERMITTED BY APPLICABLE LAW. EXCEPT WHEN OTHERWISE STATED IN WRITING THE COPYRIGHT HOLDERS AND/OR OTHER PARTIES PROVIDE THE PROGRAM "AS IS" WITHOUT WARRANTY OF ANY KIND, EITHER EXPRESSED OR IMPLIED, INCLUDING, BUT NOT LIMITED TO, THE IMPLIED WARRANTIES OF MERCHANTABILITY AND FITNESS FOR A PARTICULAR PURPOSE. THE ENTIRE RISK AS TO THE QUALITY AND PERFORMANCE OF THE PROGRAM IS WITH YOU. SHOULD THE PROGRAM PROVE DEFECTIVE, YOU ASSUME THE COST OF ALL NECESSARY SERVICING, REPAIR OR CORRECTION.

IN NO EVENT UNLESS REQUIRED BY APPLICABLE LAW OR AGREED TO IN WRITING WILL ANY COPYRIGHT HOLDER, OR ANY OTHER PARTY WHO MAY MODIFY AND/OR REDISTRIBUTE THE PROGRAM AS PERMITTED ABOVE, BE LIABLE TO YOU FOR DAMAGES, INCLUDING ANY GENERAL, SPECIAL, INCIDENTAL OR CONSEQUENTIAL DAMAGES ARISING OUT OF THE USE OR INABILITY TO USE THE PROGRAM (INCLUDING BUT NOT LIMITED TO LOSS OF DATA OR DATA BEING RENDERED INACCURATE OR LOSSES SUSTAINED BY YOU OR THIRD PARTIES OR A FAILURE OF THE PROGRAM TO OPERATE WITH ANY OTHER PROGRAMS), EVEN IF SUCH HOLDER OR OTHER PARTY HAS BEEN ADVISED OF THE POSSIBILITY OF SUCH DAMAGES.

END OF TERMS AND CONDITIONS

How to Apply These Terms to Your New Programs

If you develop a new program, and you want it to be of the greatest possible use to the public, the best way to achieve this is to make it free software which everyone can redistribute and change under these terms.

To do so, attach the following notices to the program. It is safest to attach them to the start of each source file to most effectively

convey the exclusion of warranty; and each file should have at least the "copyright" line and a pointer to where the full notice is found.

-one line to give the program's name and an idea of what it does >

Copyright (C) <year> <name of author>

This program is free software; you can redistribute it and/or modify it under the terms of the GNU General Public License as published by the Free Software Foundation; either version 2 of the License, or (at your option) any later version.

This program is distributed in the hope that it will be useful, but WITHOUT ANY WARRANTY; without even the implied warranty of MERCHANTABILITY or FITNESS FOR A PARTICULAR PURPOSE. See the GNU General Public License for more details.

You should have received a copy of the GNU General Public License along with this program; if not, write to the Free Software Foundation, Inc., 59 Temple Place - Suite 330, Boston, MA 02111-1307, USA.

Also add information on how to contact you by electronic and paper mail.

If the program is interactive, make it output a short notice like this when it starts in an interactive mode: Gnomovision version 69, Copyright (C) year name of author Gnomovision comes with ABSOLUTELY NO WARRANTY; for details type 'show w'. This is free software, and you are welcome to redistribute it under certain conditions; type 'show c' for details.

The hypothetical commands 'show w' and 'show c' should show the appropriate parts of the General Public License. Of course, the commands you use may be called something other than 'show w' and 'show c'; they could even be mouse-clicks or menu items—whatever suits your program.

You should also get your employer (if you work as a programmer) or your school, if any, to sign a "copyright disclaimer" for the program, if necessary. Here is a sample; alter the names:

Yoodyne, Inc., hereby disclaims all copyright interest in the program "Gnomovision" (which makes passes at compilers) written by James Hacker.

<signature of Ty Coon>, 1 April 1989

Ty Coon, President of Vice

This General Public License does not permit incorporating your program into proprietary programs. If your program is a subroutine library, you may consider it more useful to permit linking proprietary applications with the library. If this is what you want to do, use the GNU Library General Public License instead of this License.

Notice Regarding Third-party Software

This product includes the following software that is directly or indirectly licensed to Onkyo by third-party developers.

1. bfish-sk
2. ixml
3. libcurl
4. libFLAC
5. libjpeg
6. libogg
7. libpng
8. libvorbis
9. libz
10. OpenSSL
11. popl
12. RSA Data Security, Inc. MD5 Message-Digest Algorithm
13. thtpd 2.25b
14. zlib
15. Apple Lossless
16. Boost
17. Expat
18. FastDelegate
19. Tremolo
20. ntp
21. Mersenne Twister
22. cURL
23. c-ares
24. LZ4

In response to requests from the copyright owners of each piece of software, Onkyo notifies you of the following:

Important Notice Regarding Other Third-Party Software

This product includes the following software licensed to Onkyo Corporation directly or indirectly by third party developers:

1. bfish-sk
2. ixml
3. libcurl
4. libFLAC
5. libjpeg
6. libogg
7. libpng
8. libvorbis
9. ntp
10. OpenSSL
11. popl
12. RSA Data Security, Inc. MD5 Message-Digest Algorithm
13. thtpd 2.25b
14. zlib
15. Apple Lossless
16. Boost
17. Expat
18. FastDelegate
19. Tremolo
20. Mersenne Twister
21. cURL
22. c-ares
23. LZ4

In response to requests from the copyright owners of each piece of software, Onkyo notifies you of the following:

- (1) bfish-sk
- Copyright (c) 2007 Samuel KABAK
- Permission is hereby granted, free of charge, to any person obtaining a copy of this software and associated documentation files (the "Software"), to deal in the Software without restriction, including without limitation the rights to use, copy, modify, merge, publish, distribute, sublicense, and/or sell copies of the Software, and to permit persons to whom the Software is furnished to do so, subject to the following conditions:
- The above copyright notice and this permission notice shall be included in all copies or substantial portions of the Software.
- THE SOFTWARE IS PROVIDED "AS IS", WITHOUT WARRANTY OF ANY KIND, EXPRESS OR IMPLIED, INCLUDING



BUT NOT LIMITED TO THE WARRANTIES OF MERCHANTABILITY, FITNESS FOR A PARTICULAR PURPOSE AND NONINFRINGEMENT. IN NO EVENT SHALL THE AUTHORS OR COPYRIGHT HOLDERS BE LIABLE FOR ANY CLAIM, DAMAGES OR OTHER LIABILITY, WHETHER IN AN ACTION OF CONTRACT, TORT OR OTHERWISE, ARISING FROM, OUT OF OR IN CONNECTION WITH THE SOFTWARE OR THE USE OR OTHER DEALINGS IN THE SOFTWARE.

Redistribution and use in source and binary forms, with or without modification, are permitted provided that the following conditions are met:

- Redistributions of source code must retain the above copyright notice, this list of conditions and the following disclaimer.
- Redistributions in binary form must reproduce the above copyright notice, this list of conditions and the following disclaimer in the documentation and/or other materials provided with the distribution.

Neither the name of Intel Corporation nor the names of its contributors may be used to endorse or promote products derived from this software without specific prior written permission. THIS SOFTWARE IS PROVIDED BY THE COPYRIGHT HOLDERS AND CONTRIBUTORS "AS IS" AND ANY EXPRESS OR IMPLIED WARRANTIES, INCLUDING, BUT NOT LIMITED TO, THE IMPLIED WARRANTIES OF MERCHANTABILITY AND FITNESS FOR A PARTICULAR PURPOSE ARE DISCLAIMED. IN NO EVENT SHALL INTEL OR CONTRIBUTORS BE LIABLE FOR ANY DIRECT, INDIRECT, INCIDENTAL, SPECIAL, EXEMPLARY, OR CONSEQUENTIAL DAMAGES (INCLUDING, BUT NOT LIMITED TO, PROCUREMENT OF SUBSTITUTE GOODS OR SERVICES; LOSS OF USE, DATA, OR PROFITS, OR BUSINESS INTERRUPTION) HOWEVER CAUSED AND ON ANY THEORY OF LIABILITY, WHETHER IN CONTRACT, STRICT LIABILITY, OR TORT (INCLUDING NEGLIGENCE OR OTHERWISE) ARISING IN ANY WAY OUT OF THE USE OF THIS SOFTWARE, EVEN IF ADVISED OF THE POSSIBILITY OF SUCH DAMAGE.

**(3) liburl  
COPYRIGHT AND PERMISSION NOTICE**  
Copyright (c) 1996 - 2007, Daniel Stenberg, <daniel@haxx.se>.  
All rights reserved.

Permission to use, copy, modify, and distribute this software for any purpose with or without fee is hereby granted, provided that the above copyright notice and this permission notice appear in all copies. THE SOFTWARE IS PROVIDED "AS IS", WITHOUT WARRANTY OF ANY KIND, EXPRESS OR IMPLIED, INCLUDING

BUT NOT LIMITED TO THE WARRANTIES OF MERCHANTABILITY, FITNESS FOR A PARTICULAR PURPOSE AND NONINFRINGEMENT. IN NO EVENT SHALL THE AUTHORS OR COPYRIGHT HOLDERS BE LIABLE FOR ANY CLAIM, DAMAGES OR OTHER LIABILITY, WHETHER IN AN ACTION OF CONTRACT, TORT OR OTHERWISE, ARISING FROM, OUT OF OR IN CONNECTION WITH THE SOFTWARE OR THE USE OR OTHER DEALINGS IN THE SOFTWARE.

Except as contained in this notice, the name of a copyright holder shall not be used in advertising or otherwise to promote the sale, use or other dealings in this Software without prior authorization of the copyright holder.

**(4) libLAC  
Copyright (C) 2000,2001,2002,2003,2004,2005,2006,2007 Josh Coalition**  
Redistribution and use in source and binary forms, with or without modification, are permitted provided that the following conditions are met:

- Redistributions of source code must retain the above copyright notice, this list of conditions and the following disclaimer.

Redistributions in binary form must reproduce the above copyright notice, this list of conditions and the following disclaimer in the documentation and/or other materials provided with the distribution.  
Neither the name of the Xiph.org Foundation nor the names of its contributors may be used to endorse or promote products derived from this software without specific prior written permission. THIS SOFTWARE IS PROVIDED BY THE COPYRIGHT HOLDERS AND CONTRIBUTORS "AS IS" AND ANY EXPRESS OR IMPLIED WARRANTIES, INCLUDING, BUT NOT LIMITED TO, THE IMPLIED WARRANTIES OF MERCHANTABILITY AND FITNESS FOR A PARTICULAR PURPOSE ARE DISCLAIMED. IN NO EVENT SHALL THE FOUNDATION OR CONTRIBUTORS BE LIABLE FOR ANY DIRECT, INDIRECT, INCIDENTAL, SPECIAL, EXEMPLARY, OR CONSEQUENTIAL DAMAGES (INCLUDING, BUT NOT LIMITED TO, PROCUREMENT OF SUBSTITUTE GOODS OR SERVICES; LOSS OF USE, DATA, OR PROFITS, OR BUSINESS INTERRUPTION) HOWEVER CAUSED AND ON ANY THEORY OF LIABILITY, WHETHER IN CONTRACT, STRICT LIABILITY, OR TORT (INCLUDING NEGLIGENCE OR OTHERWISE) ARISING IN ANY WAY OUT OF THE USE OF THIS SOFTWARE, EVEN IF ADVISED OF THE POSSIBILITY OF SUCH DAMAGE.

**(5) libapeg**  
The authors make NO WARRANTY or representation, either express or implied, with respect to this software, its quality, accuracy, merchantability, or fitness for a particular purpose. This software is provided "AS IS", and you, its user, assume the entire risk as to its quality and accuracy.  
This software is copyright (C) 1991-1998, Thomas G. Lane.

All Rights Reserved except as specified below.

Permission is hereby granted to use, copy, modify, and distribute this software (or portions thereof) for any purpose, without fee, subject to these conditions:

If any part of the source code for this software is distributed, then this README file must be included, with this copyright and no-warranty notice unaltered; and any additions, deletions, or changes to the original files must be clearly indicated in accompanying documentation.  
If only executable code is distributed, then the accompanying documentation must state that "this software is based in part on the work of the Independent JPEG Group".

Permission for use of this software is granted only if the user accepts full responsibility for any undesirable consequences; the authors accept NO LIABILITY for damages of any kind.  
These conditions apply to any software derived from or based on the IJG code, not just to the unmodified library. If you use our work, you ought to acknowledge us.

Permission is NOT granted for the use of any IJG author's name or company name in advertising or publicity relating to this software or products derived from it. This software may be referred to only as "the Independent JPEG Group's software".  
We specifically permit and encourage the use of this software as the basis of commercial products, provided that all warranty or liability claims are assumed by the product vendor.

ansi2znr.c is included in this distribution by permission of L. Peter Deutsch, sole proprietor of its copyright holder, Aladdin Enterprises of Menlo Park, CA. ansi2znr.c is NOT covered by the above copyright and conditions, but instead by the usual distribution terms of the Free Software Foundation; principally, that you must include source code if you redistribute it. (See the file ansi2znr.c for full details.) However, since ansi2znr.c is not needed as part of any program generated from the IJG code, this does not limit you more than the foregoing paragraphs do.

The Unix configuration script "configure" was produced with GNU Autoconf. It is copyright by the Free Software Foundation but is freely distributable. The same holds for its supporting scripts (config.guess, config.sub, ltconfig, ltmain.sh). Another support script, install-sh, is copyright by M.I.T. but is also freely distributable.

It appears that the arithmetic coding option of the JPEG spec is covered by patents owned by IBM, AT&T, and Mitsubishi. Hence arithmetic coding cannot legally be used without obtaining one or more licenses. For this reason, support for arithmetic coding has been removed from the free JPEG software.  
(Since arithmetic coding provides only a marginal gain over the unpatented Huffman mode, it is unlikely that very many implementations will support it.) So far as we are aware, there are no patent restrictions on the remaining code.  
The IJG distribution formerly included code to read and write GIF files. To avoid entanglement with the Unisys LZW patent, GIF reading support has been removed altogether, and the GIF writer has been simplified to produce "uncompressed GIFs". This

technique does not use the LZW algorithm; the resulting GIF files are larger than usual, but are readable by all standard GIF decoders.

We are required to state that "The Graphics Interchange Format(c) is the Copyright property of ompuServe Incorporated. GIF(sm) is a Service Mark property of CompuServe Incorporated."

**(6) libogg  
Copyright (c) 2002, Xiph.org Foundation**  
Redistribution and use in source and binary forms, with or without modification, are permitted provided that the following conditions are met:

- Redistributions of source code must retain the above copyright notice, this list of conditions and the following disclaimer.
- Redistributions in binary form must reproduce the above copyright notice, this list of conditions and the following disclaimer in the documentation and/or other materials provided with the distribution.

Neither the name of the Xiph.org Foundation nor the names of its contributors may be used to endorse or promote products derived from this software without specific prior written permission. THIS SOFTWARE IS PROVIDED BY THE COPYRIGHT HOLDERS AND CONTRIBUTORS "AS IS" AND ANY EXPRESS OR IMPLIED WARRANTIES, INCLUDING, BUT NOT LIMITED TO, THE IMPLIED WARRANTIES OF MERCHANTABILITY AND FITNESS FOR A PARTICULAR PURPOSE ARE DISCLAIMED. IN NO EVENT SHALL THE FOUNDATION OR CONTRIBUTORS BE LIABLE FOR ANY DIRECT, INDIRECT, INCIDENTAL, SPECIAL, EXEMPLARY, OR CONSEQUENTIAL DAMAGES (INCLUDING, BUT NOT LIMITED TO, PROCUREMENT OF SUBSTITUTE GOODS OR SERVICES; LOSS OF USE, DATA, OR PROFITS, OR BUSINESS INTERRUPTION) HOWEVER CAUSED AND ON ANY THEORY OF LIABILITY, WHETHER IN CONTRACT, STRICT LIABILITY, OR TORT (INCLUDING NEGLIGENCE OR OTHERWISE) ARISING IN ANY WAY OUT OF THE USE OF THIS SOFTWARE, EVEN IF ADVISED OF THE POSSIBILITY OF SUCH DAMAGE.

**(7) libpng  
COPYRIGHT NOTICE, DISCLAIMER, and LICENSE:**  
If you modify libpng you may insert additional notices immediately following this sentence.  
This code is released under the libpng license.  
libpng versions 1.2.6, August 15, 2004, through 1.4.0, January 3, 2010, are Copyright (c) 2004, 2006-2007 Glenn Randers-Pehrson, and are distributed according to the same disclaimer and license as libpng-1.2.5 with the following individual added to the list of Contributing Authors:

Simon-Pierre Cadieux  
Eric S. Raymond  
Gilles Vollant  
and with the following additions to the disclaimer:  
There is no warranty against interference with your enjoyment of the library or against infringement. There is no warranty that our efforts or the library will fulfill any of your particular purposes or needs. This library is provided with all faults, and the entire risk of satisfactory quality, performance, accuracy, and effort is with the user.  
libpng versions 0.97, January 1998, through 1.0.6, March 20, 2000, are Copyright (c) 1998, 1999 Glenn Randers-Pehrson, and are distributed according to the same disclaimer and license as libpng-0.96, with the following individuals added to the list of Contributing Authors:

Tom Lane  
Glenn Randers-Pehrson  
Willem van Schaik  
libpng versions 0.89, June 1996, through 0.96, May 1997, are Copyright (c) 1996, 1997 Andreas Dilger Distributed according to the same disclaimer and license as libpng-0.88, with the following individuals added to the list of Contributing Authors:  
John Bowler  
Kevin Bracey  
Sam Bushell  
Magnus Holmgren  
Greg Roeloffs  
Tom Tanner  
libpng versions 0.5, May 1995, through 0.88, January 1996, are Copyright (c) 1995, 1996 Guy Eric Stalham, Group 42, Inc.

For the purposes of this copyright and license, "Contributing Authors" is defined as the following set of individuals:  
Andreas Dilger  
Dave Martindale  
Guy Eric Stalham  
Paul Schmidt  
Tim Wegner  
The PNG Reference Library is supplied "AS IS". The Contributing Authors and Group 42, Inc. disclaim all warranties, expressed or implied, including, without limitation, the warranties of merchantability and of fitness for any purpose. The Contributing Authors and Group 42, Inc. assume no liability for direct, indirect, incidental, special, exemplary, or consequential damages, which may result from the use of the PNG Reference Library, even if advised of the possibility of such damage.

Permission is hereby granted to use, copy, modify, and distribute this source code, or portions hereof, for any purpose, without fee, subject to the following restrictions:  
The origin of this source code must not be misrepresented.  
Altered versions must be plainly marked as such and must not be misrepresented as being the original source.  
This Copyright notice may not be removed or altered from any source or altered source distribution.

The Contributing Authors and Group 42, Inc. specifically permit, without fee, and encourage the use of this source code as a component to supporting the PNG file format in commercial products. If you use this source code in a product, acknowledgment is not required but would be appreciated.

**(8) libvorbis  
Copyright (c) 2002-2004 Xiph.org Foundation**  
Redistribution and use in source and binary forms, with or without modification, are permitted provided that the following conditions are met:

- Redistributions of source code must retain the above copyright notice, this list of conditions and the following disclaimer.
- Redistributions in binary form must reproduce the above copyright notice, this list of conditions and the following disclaimer in the documentation and/or other materials provided with the distribution.

Neither the name of the Xiph.org Foundation nor the names of its contributors may be used to endorse or promote products derived from this software without specific prior written permission. THIS SOFTWARE IS PROVIDED BY THE COPYRIGHT HOLDERS AND CONTRIBUTORS "AS IS" AND ANY EXPRESS OR IMPLIED WARRANTIES, INCLUDING, BUT NOT LIMITED TO, THE IMPLIED WARRANTIES OF MERCHANTABILITY AND FITNESS FOR A PARTICULAR PURPOSE ARE DISCLAIMED. IN NO EVENT SHALL THE FOUNDATION OR CONTRIBUTORS BE LIABLE FOR ANY DIRECT, INDIRECT, INCIDENTAL, SPECIAL, EXEMPLARY, OR CONSEQUENTIAL DAMAGES (INCLUDING, BUT NOT LIMITED TO, PROCUREMENT OF SUBSTITUTE GOODS OR SERVICES; LOSS OF USE, DATA,

OR PROFITS, OR BUSINESS INTERRUPTION) HOWEVER CAUSED AND ON ANY THEORY OF LIABILITY, WHETHER IN CONTRACT, STRICT LIABILITY, OR TORT (INCLUDING NEGLIGENCE OR OTHERWISE) ARISING IN ANY WAY OUT OF THE USE OF THIS SOFTWARE, EVEN IF ADVISED OF THE POSSIBILITY OF SUCH DAMAGE.

**(9) ntp**  
This file is automatically generated from html/copyright.html  
**Copyright Notice**  
Ilg "Clone me" says Dolly sheepishly  
Last update: 20:31 UTC Saturday, January 06, 2007  
The following copyright notice applies to all files collectively called the Network Time Protocol Version 4 distribution. Unless specifically declared otherwise in an individual file, this notice applies as if the text was explicitly included in the file.  
Copyright (c) David L. Mills 1992-2007

Permission to use, copy, modify, and distribute this software and its documentation for any purpose with or without fee is hereby granted, provided that the above copyright notice appears in all copies and that both the copyright notice and this permission notice appear in supporting documentation, and that the name University of Delaware not be used in advertising or publicity pertaining to distribution of the software without specific, written prior permission. The University of Delaware makes no representations about the suitability of this software for any purpose. It is provided "as is" without express or implied warranty. The following individuals contributed in part to the Network Time Protocol Distribution Version 4 and are acknowledged as authors of this work.

[1]Mark Andrews <mik\_andrews@isc.org> Leitch atomic clock controller  
[2]Bernd Altmeier <altmeier@altssoft.de> hopti Eclipton serial line and PCI-bus devices  
[3]Vraj Bais <vbais@mailman1.intel.com> and [4]Clayton Kirkwood <kirkwood@striderfm.intel.com> port to WindowsNT 3.5  
[5]Michael Barone <michael.barone@lmco.com> GPSVME fixes  
[6]Jean-Francois Boudreau <Jean-Francois.Boudreau@viagenie.qc.ca> IPv6 support  
[7]Karl Barry <kar@owl.hq.leaf.com> syslog file option  
[8]Greg Brackley <greg.brackley@bigfoot.com> Major release of WINNT port. Clean up recvuf and isignal code into separate module.  
[9]Marc Brett <Marc.Brett@westge.com> Magnavox GPS clock driver  
[10]Piete Brooks <Piete.Brooks@cd.cam.ac.uk> MSF clock driver, Trimble PARSE support  
[11]Reg Clemens <reg@dwf.com> Oncore driver (Current maintainer)  
[12]Steve Clift <clift@ml.csiro.au> OMEGA clock driver  
[13]Casey Coles <casey@cscc.co.za> >ixWorks (Tomato) port and help with target configuration  
[14]Sven Dietrich <svendietrich@trimble.com> Palisade reference clock driver, NT ad, residuals, integrated Greg's Winnt port.  
[15]John A. Dundas III <dundas@salt.jpl.nasa.gov> Apple AUX port  
[16]Torsten Duwe <duwe@immd4.informatik.uni-erlangen.de> Linux port  
[17]Dennis Ferguson <dennis@mrbl.comet.ca> foundation code for NTP Version 2 as specified in RFC-1119  
[18]John Hay <jhay@icomtek.csiro.au> IPv6 support and testing  
[19]Glen Holling <glen@herald.usak.ca> GOES clock driver  
[20]Mike Iglesias <miglesias@uci.edu> DEC Alpha port  
[21]Jim Jagielski <jim@jagucho.gsc.nasa.gov> AUX port  
[22]Jeff Johnson <jbj@chatham.usdesign.com> massive prototyping overhaul  
[23]Hans Lambermont <Hans.Lambermont@nti.origin-it.com> or [24]H. Lambermont@chello.nl ntpswep  
[25]Paul-Henning Kamp <phk@FreeBSD.ORG> Oncore driver (Original author)  
[26]Frank Kasziel [27]sander [at] ntp [dot] org> PARSE <GENERIC> driver (>14 reference clocks), STREAMS modules for PARSE, support scripts, syslog cleanup, dynamic interface handling  
[28]William L. Jones <jones@hermes.chpc.utexas.edu> RS6000 AIX modifications, HPUX modifications  
[29]Dave Katz <dkatz@cisco.com> RS6000 AIX port  
[30]Craig Leres <leres@ee.tli.gov> 4.4BSD port, ppsclock, MagnavoxGPS clock driver  
[31]George Lindholm <linholm@qucs.ubc.ca> SunOS 5.1 port  
[32]Louis A. Mammos <louj@umd.edu> MD5-based authentication  
[33]Lars H. Mathiesen <mathorin@dku.dk> adaptation of foundation code for Version 3 as specified in RFC-1305  
[34]Danny Mayer <mayer@ntp.org>Network UI, Windows Port, Code Maintenance  
[35]David L. Mills <mills@udel.edu> Version 4 foundation: clock classification, authentication, precision kernel; clock drivers: Spectracom, Austron, Arbitr, Heath, ATOM, ACTS, KSI/Odette; audio clock drivers: CHU, WWW/H. IRIG  
[36]Wolfgang Moeller <moeller@gwdg1.dnet.gwdg.de> VMS port  
[37]Jeffrey Mogil <mogil@qsl.usa.de.com> ntpsec utility  
[38]Tom Moore <tmoore@feyel.daytona.fl.com> 1386 svr4 port  
[39]Kamal A Mostafa <kamal@whence.com> SCO OpenServer port  
[40]Derek Mulcahy <derek@toybox.demon.co.uk> and [41]Damon Hart-Davis <d@hd.org> ARCRON MSF clock driver  
[42]Rainer Pruy <Rainer.Pruy@informatik.uni-erlangen.de> monitoring/trap scripts, statistics file handling  
[43]Diroe Richards <dirdoe@z3k3.dec.com> Digital UNIX V4.0 port  
[44]Wlfredo Sanchez <wsanchez@apple.com> added support for NetInfo  
[45]Nick Sawyer <nmapple@quack.ku.dk> SunOS streams modules  
[46]Jack Sasportas <sjack@innovativenternet.com> Saved A Lot of space on the stuff in the html/pci/ subdirectory  
[47]Ray Schintzler <rschntz@unipress.com> Unxware1 port  
[48]Michael Shields <shields@tembel.org> USNO clock driver  
[49]Jeff Shenman <jss@pebbles.jpl.nasa.gov> Datum PTS clock driver  
[50]Harlan Stern <stern@jgics.com> GNU automake/autocfg makeover, various other bits (see the ChangeLog)

[51]Keneth Stone <ken@gdsd.hp.com> HPUX port  
[52]Ajit Tharagaran <ajit@ee.udel.edu> IP multicast/anycast support  
[53]Tomoaki TSURUOKA <tsuruoka@nrc.fukuioka-u.ac.jp> TRAX clock driver  
[54]Paul A. Vixie <vixie@vix.com> TrueTime GPS driver, generic TrueTime clock driver  
[55]Ulrich Windl <Ulrich.Windl@rz.uni-regensburg.de> corrected and validated HTML documents according to the HTML DTD

mailto: mark\_andrews@isc.org  
mailto: altmeier@altssoft.de  
mailto: vbais@mailman1.intel.com  
mailto: kirkwood@striderfm.intel.com  
mailto: michael.barone@lmco.com  
mailto: Jean-Francois.Boudreau@viagenie.qc.ca  
mailto: karl@owl.hq.leaf.com  
mailto: greg.brackley@bigfoot.com  
mailto: Marc.Brett@westge.com  
mailto: Piete.Brooks@cd.cam.ac.uk  
mailto: reg@dwf.com  
mailto: clift@ml.csiro.au  
mailto: casey@cscc.co.za  
mailto: Sven.Dietrich@trimble.COM  
mailto: dundas@salt.jpl.nasa.gov  
mailto: duwe@immd4.informatik.uni-erlangen.de  
mailto: dennis@mrbl.comet.ca



mailto: jhay@icomtek.csr.co.za  
 gjem@herald.usask.ca  
 mailto: iglesias@uci.edu  
 mailto: jagubox@gsc.nasa.gov  
 mailto: jbj@chatham.usdesign.com  
 mailto: Hans.Lambermon@nl.origin-it.com  
 mailto: H.Lambermon@chelo.nl  
 mailto: ph@FreeBSD.ORG  
 http://www.informatik.uni-erlangen.de/%7ekardel  
 mailto: kardel(at)ntp(dot)org  
 mailto: jones@hermes.chpc.utexas.edu  
 mailto: dkatz@cisco.com  
 mailto: leres@ee.lib.gov  
 mailto: lindholm@ucs.ubc.ca  
 mailto: louie@ni.umd.edu  
 mailto: thorinn@dku.dk  
 mailto: mayer@ntp.org  
 mailto: mills@udel.edu  
 mailto: moeller@gwdgv1.dnet.gwdg.de  
 mailto: mofu@nec.dec.com  
 mailto: Tmoore@fevel.daytonoh.ncr.com  
 mailto: kamal@whence.com  
 mailto: derek@toybox.demon.co.uk  
 mailto: d@hd.org  
 mailto: Rainer.Fruy@informatik.uni-erlangen.de  
 mailto: draco@4d.com  
 mailto: wsanchez@apple.com  
 mailto: mrappe@quack.kfu.com  
 mailto: jack@innovativeinternet.net  
 mailto: schnitz@unipress.com  
 mailto: shields@tembel.org  
 mailto: pebbles.ji@nasa.gov  
 mailto: harlan@pfc.com  
 mailto: ken@sdd.hp.com  
 mailto: ajl@ee.udel.edu  
 mailto: tsuruoka@nc.fukuoaka-u.ac.jp  
 mailto: via@viv.com  
 mailto: Ulrich.Wind@rz.uni-regensburg.de  
 (10) OpenSSL  
 LICENSE ISSUES  
 =====  
 The OpenSSL toolkit stays under a dual license, i.e. both the conditions of the OpenSSL License and the original SSLeay license apply to the toolkit. See below for the actual license texts. Actually both licenses are BSD-style Open Source licenses. In case of any license issues related to OpenSSL, please contact openssl-core@openssl.org.  
 OpenSSL License  
 =====  
 Copyright (c) 1998-2007 The OpenSSL Project. All rights reserved.  
 Redistribution and use in source and binary forms, with or without modification, are permitted provided that the following conditions are met:

Redistributions of source code must retain the above copyright notice, this list of conditions and the following disclaimer.  
 Redistributions in binary form must reproduce the above copyright notice, this list of conditions and the following disclaimer in the documentation and/or other materials provided with the distribution.  
 All advertising materials mentioning features or use of this software must display the following acknowledgment:  
 "This product includes software developed by the OpenSSL Project for use in the OpenSSL Toolkit. (http://www.openssl.org)"  
 The names "OpenSSL Toolkit" and "OpenSSL Project" must not be used to endorse or promote products derived from this software without prior written permission. For written permission, please contact openssl-core@openssl.org.  
 Products derived from this software may not be called "OpenSSL" nor may "OpenSSL" appear in their names without prior written permission of the OpenSSL Project.  
 Redistributions of any form whatsoever must retain the following acknowledgment:  
 "This product includes software developed by the OpenSSL Project for use in the OpenSSL Toolkit (http://www.openssl.org)"  
 THIS SOFTWARE IS PROVIDED BY THE OpenSSL PROJECT "AS IS" AND ANY EXPRESSED OR IMPLIED WARRANTIES, INCLUDING, BUT NOT LIMITED TO, THE IMPLIED WARRANTIES OF MERCHANTABILITY AND FITNESS FOR A PARTICULAR PURPOSE ARE DISCLAIMED. IN NO EVENT SHALL THE OpenSSL PROJECT OR ITS CONTRIBUTORS BE LIABLE FOR ANY DIRECT, INDIRECT, INCIDENTAL, SPECIAL, EXEMPLARY, OR CONSEQUENTIAL DAMAGES (INCLUDING, BUT NOT LIMITED TO, PROCUREMENT OF SUBSTITUTE GOODS OR SERVICES; LOSS OF USE, DATA, OR PROFITS; OR BUSINESS INTERRUPTION) HOWEVER CAUSED AND ON ANY THEORY OF LIABILITY, WHETHER IN CONTRACT, STRICT LIABILITY, OR TORT (INCLUDING NEGLIGENCE OR OTHERWISE) ARISING IN ANY WAY OUT OF THE USE OF THIS SOFTWARE, EVEN IF ADVISED OF THE POSSIBILITY OF SUCH DAMAGE.  
 =====  
 This product includes cryptographic software written by Eric Young (eay@cryptsoft.com). This product includes software written by Tim Hudson (tjh@cryptsoft.com).  
 Original SSLeay License  
 =====  
 Copyright (C) 1995-1998 Eric Young (eay@cryptsoft.com) All rights reserved.  
 This package is an SSL implementation written by Eric Young (eay@cryptsoft.com).  
 The implementation was written so as to conform with Netscape's SSL.  
 This library is free for commercial and non-commercial use as long as the following conditions are aheared to. The following conditions apply to all code found in this distribution, be it the RC4, RSA, lhash, DES, etc., code; not just the SSL code. The SSL documentation included with this distribution is covered by the same copyright terms except that the holder is Tim Hudson (tjh@cryptsoft.com).  
 Copyright remains Eric Young's, and as such any Copyright notices in the code are not to be removed.  
 If this package is used in a product, Eric Young should be given attribution as the author of the parts of the library used.  
 This can be in the form of a textual message at program startup or in documentation (online or textual) provided with the package.  
 Redistribution and use in source and binary forms, with or without modification, are permitted provided that the following conditions are met:

Redistributions of source code must retain the copyright notice, this list of conditions and the following disclaimer.  
 Copyright notices in the code are not to be removed.  
 If this package is used in a product, Eric Young should be given attribution as the author of the parts of the library used.  
 This can be in the form of a textual message at program startup or in documentation (online or textual) provided with the package.  
 Redistribution and use in source and binary forms, with or without modification, are permitted provided that the following conditions are met:

Redistributions of source code must retain the copyright notice, this list of conditions and the following disclaimer.

Redistributions in binary form must reproduce the above copyright notice, this list of conditions and the following disclaimer in the documentation and/or other materials provided with the distribution.  
 All advertising materials mentioning features or use of this software must display the following acknowledgment: "Eric Young (eay@cryptsoft.com)"  
 The word "cryptographic" can be left out if the routines from the library being used are not cryptographic related :-).  
 If you include any Windows specific code (or a derivative thereof) from the apps directory (application code) you must include an acknowledgment: "This product includes software written by Tim Hudson (tjh@cryptsoft.com)"  
 THIS SOFTWARE IS PROVIDED BY ERIC YOUNG "AS IS" AND ANY EXPRESS OR IMPLIED WARRANTIES, INCLUDING, BUT NOT LIMITED TO, THE IMPLIED WARRANTIES OF MERCHANTABILITY AND FITNESS FOR A PARTICULAR PURPOSE ARE DISCLAIMED. IN NO EVENT SHALL THE AUTHOR OR CONTRIBUTORS BE LIABLE FOR ANY DIRECT, INDIRECT, INCIDENTAL, SPECIAL, EXEMPLARY, OR CONSEQUENTIAL DAMAGES (INCLUDING, BUT NOT LIMITED TO, PROCUREMENT OF SUBSTITUTE GOODS OR SERVICES; LOSS OF USE, DATA, OR PROFITS; OR BUSINESS INTERRUPTION) HOWEVER CAUSED AND ON ANY THEORY OF LIABILITY, WHETHER IN CONTRACT, STRICT LIABILITY, OR TORT (INCLUDING NEGLIGENCE OR OTHERWISE) ARISING IN ANY WAY OUT OF THE USE OF THIS SOFTWARE, EVEN IF ADVISED OF THE POSSIBILITY OF SUCH DAMAGE.  
 =====  
 (11) popt  
 Copyright (c) 1998 Red Hat Software  
 Permission is hereby granted, free of charge, to any person obtaining a copy of this software and associated documentation files (the "Software"), to deal in the Software without restriction, including without limitation the rights to use, copy, modify, merge, publish, distribute, sublicense, and/or sell copies of the Software, and to permit persons to whom the Software is furnished to do so, subject to the following conditions:  
 The above copyright notice and this permission notice shall be included in all copies or substantial portions of the Software.  
 THE SOFTWARE IS PROVIDED "AS IS" WITHOUT WARRANTY OF ANY KIND, EXPRESS OR IMPLIED, INCLUDING BUT NOT LIMITED TO THE WARRANTIES OF MERCHANTABILITY, FITNESS FOR A PARTICULAR PURPOSE AND NONINFRINGEMENT. IN NO EVENT SHALL THE X CONSORTIUM BE LIABLE FOR ANY CLAIM, DAMAGES OR OTHER LIABILITY, WHETHER IN AN ACTION OF CONTRACT, TORT OR OTHERWISE, ARISING FROM, OUT OF OR IN CONNECTION WITH THE SOFTWARE OR THE USE OR OTHER DEALINGS IN THE SOFTWARE.  
 Except as contained in this notice, the name of the X Consortium shall not be used in advertising or otherwise to promote the sale, use or other dealings in this Software without prior written authorization from the X Consortium.  
 (12) RSA Data Security, Inc. MD5 Message-Digest Algorithm  
 Copyright (C) 1991-2, RSA Data Security, Inc. Created 1991. All rights reserved.  
 License to copy and use this software is granted provided that it is identified as "RSA Data Security, Inc. MD5 Message-Digest Algorithm" in all material mentioning or referencing this software or this function.  
 License is also granted to make and use derivative works provided that such works are identified as "derived from the RSA Data Security, Inc. MD5 Message-Digest Algorithm" in all material mentioning or referencing the derived work.  
 RSA Data Security, Inc. makes no representations concerning either the merchantability of this software or the suitability of this software for any particular purpose. It is provided "as is" without express or implied warranty of any kind.  
 These notices must be retained in any copies of any part of this documentation and/or software.  
 (13) httpd 2.25b  
 Copyright c 2000 by Jef Poskanzer <jef@mail.acme.com>. All rights reserved.  
 Redistribution and use in source and binary forms, with or without modification, are permitted provided that the following conditions are met:

Redistributions of source code must retain the above copyright notice, this list of conditions and the following disclaimer.  
 Redistributions in binary form must reproduce the above copyright notice, this list of conditions and the following disclaimer in the documentation and/or other materials provided with the distribution.  
 THIS SOFTWARE IS PROVIDED BY THE AUTHOR AND CONTRIBUTORS "AS IS" AND ANY EXPRESS OR IMPLIED WARRANTIES, INCLUDING, BUT NOT LIMITED TO, THE IMPLIED WARRANTIES OF MERCHANTABILITY AND FITNESS FOR A PARTICULAR PURPOSE ARE DISCLAIMED. IN NO EVENT SHALL THE AUTHOR OR CONTRIBUTORS BE LIABLE FOR ANY DIRECT, INDIRECT, INCIDENTAL, SPECIAL, EXEMPLARY, OR CONSEQUENTIAL DAMAGES (INCLUDING, BUT NOT LIMITED TO, PROCUREMENT OF SUBSTITUTE GOODS OR SERVICES; LOSS OF USE, DATA, OR PROFITS; OR BUSINESS INTERRUPTION) HOWEVER CAUSED AND ON ANY THEORY OF LIABILITY, WHETHER IN CONTRACT, STRICT LIABILITY, OR TORT (INCLUDING NEGLIGENCE OR OTHERWISE) ARISING IN ANY WAY OUT OF THE USE OF THIS SOFTWARE, EVEN IF ADVISED OF THE POSSIBILITY OF SUCH DAMAGE.  
 (14) zlib  
 zlib.h -- interface of the 'zlib' general purpose compression library version 1.1.4, March 11th, 2002  
 Copyright (C) 1995-2000 Jean-loup Gailly and Mark Adler  
 This software is provided 'as-is', without any express or implied warranty. In no event will the authors be held liable for any damages arising from the use of this software.  
 Permission is granted to anyone to use this software for any purpose, including commercial applications, and to alter it and redistribute it freely, subject to the following restrictions:  
 1. The origin of this software must not be misrepresented; you must not claim that you wrote the original software. If you use this software in a product, an acknowledgment in the product documentation would be appreciated but is not required.  
 2. Altered source versions must be plainly marked as such, and must not be misrepresented as being the original software.  
 3. This notice may not be removed or altered from any source distribution.  
 Jean-loup Gailly Mark Adler  
 jloup@zip.org m Adler@alumni.callech.edu  
 The data format used by the zlib library is described by RFCs (Request for Comments) 1950 to 1952 in the files ftp://ds.internic.net/rfc/rfc1950.txt (zlib format), rfc1951.txt (deflate format) and rfc1952.txt (gzip format).  
 (15) Apache License  
 Apache License  
 Version 2.0, January 2004  
 http://www.apache.org/licenses/  
 TERMS AND CONDITIONS FOR USE, REPRODUCTION, AND DISTRIBUTION

Definitions.  
 "License" shall mean the terms and conditions for use, reproduction, and distribution as defined by Sections 1 through 9 of this document.  
 "Licensor" shall mean the copyright owner or entity authorized by the copyright owner that is granting the License.  
 "Legal Entity" shall mean the union of the acting entity and all other entities that control, are controlled by, or are under common control with that entity. For the purposes of this definition, "control" means (i) the power, direct or indirect, to cause the direction or management of such entity, whether by contract or otherwise, or (ii) ownership of fifty percent (50%) or more of the outstanding shares, or (iii) beneficial ownership of such entity.

Redistributions of source code must retain the copyright notice, this list of conditions and the following disclaimer.  
 Copyright notices in the code are not to be removed.  
 If this package is used in a product, Eric Young should be given attribution as the author of the parts of the library used.  
 This can be in the form of a textual message at program startup or in documentation (online or textual) provided with the package.  
 Redistribution and use in source and binary forms, with or without modification, are permitted provided that the following conditions are met:

Redistributions of source code must retain the copyright notice, this list of conditions and the following disclaimer.

"You" (or "Your") shall mean an individual or Legal Entity exercising permissions granted by this License.

"Source" form shall mean the preferred form for making modifications, including but not limited to software source code, documentation source, and configuration files.

"Object" form shall mean any form resulting from mechanical transformation or translation of a Source form, including but not limited to compiled object code, generated documentation, and conversions to other media types.

"Work" shall mean the work of authorship, whether in Source or Object form, made available under the License, as indicated by a copyright notice that is included in or attached to the work (an example is provided in the Appendix below).

"Derivative Works" shall mean any work, whether in Source or Object form, that is based on (or derived from) the Work and for which the editorial revisions, annotations, elaborations, or other modifications represent, as a whole, an original work of authorship. For the purposes of this License, Derivative Works shall not include works that remain separate from, or merely link (or bind by name) to the interfaces of, the Work and Derivative Works thereof.

"Contribution" shall mean any work of authorship, including the original version of the Work and any modifications or additions to that Work or Derivative Works thereof, that is intentionally submitted to Licensor for inclusion in the Work by the copyright owner or by an individual or Legal Entity authorized to submit on behalf of the copyright owner. For the purposes of this definition, "submitted" means any form of electronic, verbal, or written communication sent to the Licensor or its representatives, including but not limited to communication on electronic mailing lists, source code control systems, and issue tracking systems that are managed by, or on behalf of, the Licensor for the purpose of discussing and improving the Work, but excluding communication that is conspicuously marked or otherwise designated in writing by the copyright owner as "Not a Contribution."

"Contributor" shall mean Licensor and any individual or Legal Entity on behalf of whom a Contribution has been received by Licensor and subsequently incorporated within the Work.

Grant of Copyright License.

Subject to the terms and conditions of this License, each Contributor hereby grants to You a perpetual, worldwide, non-exclusive, non-charge, royalty-free, irrevocable copyright license to reproduce, prepare Derivative Works of, publicly display, publicly perform, sublicense, and distribute the Work and such Derivative Works in Source or Object form.

Grant of Patent License.

Subject to the terms and conditions of this License, each Contributor hereby grants to You a perpetual, worldwide, non-exclusive, non-charge, royalty-free, irrevocable (except as stated in this section) patent license to make, have made, use, offer to sell, sell, import, and otherwise transfer the Work, where such license applies only to those patent claims licensable by such Contributor that are necessarily infringed by their Contribution(s) alone or by combination of their Contribution(s) with the Work to which such Contribution(s) was submitted. If You institute patent litigation against any entity (including a cross-claim or counterclaim in a lawsuit) alleging that the Work or a Contribution incorporated within the Work constitutes direct or contributory patent infringement, then any patent licenses granted to You under this License for that Work shall terminate as of the date such litigation is filed.

Redistribution.

You may reproduce and distribute copies of the Work or Derivative Works thereof in any medium, with or without modifications, and in Source or Object form, provided that You meet the following conditions:

You must give any other recipients of the Work or Derivative Works a copy of this License; and

You must cause any modified files to carry prominent notices stating that You changed the files; and

You must retain, in the Source form of any Derivative Works that You distribute, all copyright, patent, trademark, and attribution notices from the Source form of the Work, excluding those notices that do not pertain to any part of the Derivative Works; and if the Work includes a "NOTICE" text file as part of its distribution, then any Derivative Works that You distribute must include a readable copy of the attribution notices contained within such NOTICE file, excluding those notices that do not pertain to any part of the Derivative Works, in at least one of the following places: within a NOTICE text file distributed as part of the Derivative Works; within the Source form or documentation, if provided along with the Derivative Works; or, within a display generated by the Derivative Works, if and wherever such third-party notices normally appear. The contents of the NOTICE file are for informational purposes only and do not modify the License. You may add Your own attribution notices within Derivative Works that You distribute, alongside or as an addendum to the NOTICE text from the Work, provided that such additional attribution notices cannot be construed as modifying the License.

You may add Your own copyright statement to Your modifications and may provide additional or different license terms and conditions for use, reproduction, or distribution of Your modifications, or for any such Derivative Works as a whole, provided Your use, reproduction, and distribution of the Work otherwise complies with the conditions stated in this License.

Submission of Contributions.

Unless You explicitly state otherwise, any Contribution intentionally submitted for inclusion in the Work by You to the Licensor shall be under the terms and conditions of this License, without any additional terms or conditions. Notwithstanding the above, nothing herein shall supersede or modify the terms of any separate license agreement you may have executed with Licensor regarding such Contributions.

Trademarks.

This License does not grant permission to use the trade names, trademarks, service marks, or product names of the Licensor, except as required for reasonable and customary use in describing the origin of the Work and reproducing the content of the NOTICE file.

Disclaimer of Warranty.

Unless required by applicable law or agreed to in writing, Licensor provides the Work (and each Contributor provides its Contributions) on an "AS IS" BASIS, WITHOUT WARRANTIES OR CONDITIONS OF ANY KIND, either express or implied, including, without limitation, any warranties or conditions of TITLE, NON-INFRINGEMENT, MERCHANTABILITY, or FITNESS FOR A PARTICULAR PURPOSE. You are solely responsible for determining the appropriateness of using or redistributing the Work and assume any risks associated with Your exercise of permissions under this License.

Limitation of Liability.



In no event and under no legal theory, whether in tort (including negligence), contract, or otherwise, unless required by applicable law (such as deliberate and grossly negligent acts) or agreed to in writing, shall any Contributor be liable to You for damages, including any direct, indirect, special, incidental, or consequential damages of any character arising as a result of this License or out of the use or inability to use the Work (including but not limited to damages for loss of goodwill, work stoppage, computer failure or malfunction, or any and all other commercial damages or losses), even if such Contributor has been advised of the possibility of such damages.

#### Accepting Warranty or Additional Liability.

While redistributing the Work or Derivative Works thereof, You may choose to offer, and charge a fee for, acceptance of support, warranty, indemnity, or other liability obligations and/or rights consistent with this License. However, in accepting such obligations, You may act only on Your own behalf and on Your sole responsibility, not on behalf of any other Contributor, and only if You agree to indemnify, defend, and hold each Contributor harmless for any liability incurred by, or claims asserted against, such Contributor by reason of your accepting any such warranty or additional liability.

#### END OF TERMS AND CONDITIONS

#### APPENDIX: How to apply the Apache License to your work.

To apply the Apache License to your work, attach the following boilerplate notice, with the fields enclosed by brackets [ ] replaced with your own identifying information. (Don't include the brackets!) The text should be enclosed in the appropriate comment syntax for the file format. We also recommend that a file or class name and description of purpose be included on the same "printed page" as the copyright notice for easier identification within third-party archives.

Copyright © 2011 Apple Inc. All rights reserved.

Licensed under the Apache License, Version 2.0 (the "License"); you may not use this file except in compliance with the License. You may obtain a copy of the License at

<http://www.apache.org/licenses/LICENSE-2.0>

Unless required by applicable law or agreed to in writing, software distributed under the License is distributed on an "AS IS" BASIS, WITHOUT WARRANTIES OR CONDITIONS OF ANY KIND, either express or implied. See the License for the specific language governing permissions and limitations under the license.

(16) Boost

<http://www.boost.org/>

Boost Software License - Version 1.0 - August 17th, 2003

Permission is hereby granted, free of charge, to any person or organization obtaining a copy of the software and accompanying documentation covered by this license (the "Software") to use, reproduce, display, distribute, execute, and transmit the Software, and to prepare derivative works of the Software, and to permit third-parties to whom the Software is furnished to do so, all subject to the following:

The copyright notices in the Software and this entire statement, including the above license grant, this restriction and the following disclaimer, must be included in all copies of the Software, in whole or in part, and all derivative works of the Software, unless such copies or derivative works are solely in the form of machine-executable object code generated by a source language processor.

THE SOFTWARE IS PROVIDED "AS IS", WITHOUT WARRANTY OF ANY KIND, EXPRESS OR IMPLIED, INCLUDING BUT NOT LIMITED TO THE WARRANTIES OF MERCHANTABILITY, FITNESS FOR A PARTICULAR PURPOSE, TITLE AND NON-INFRINGEMENT. IN NO EVENT SHALL THE COPYRIGHT HOLDERS OR ANYONE DISTRIBUTING THE SOFTWARE BE LIABLE FOR ANY DAMAGES OR OTHER LIABILITY, WHETHER IN CONTRACT, TORT OR OTHERWISE, ARISING FROM, OUT OF OR IN CONNECTION WITH THE SOFTWARE OR THE USE OR OTHER DEALINGS IN THE SOFTWARE.

(17) Expat

<http://www.exploit.com/xml/egpat.html>

Expat License. Copyright (c) 1998, 1999, 2000 That Open Source Software Center Ltd

Permission is hereby granted, free of charge, to any person obtaining a copy of this software and associated documentation files (the "Software"), to deal in the Software without restriction, including without limitation the rights to use, copy, modify, merge, publish, distribute, sublicense, and/or sell copies of the Software, and to permit persons to whom the Software is furnished to do so, subject to the following conditions:

The above copyright notice and this permission notice shall be included in all copies or substantial portions of the Software. THE SOFTWARE IS PROVIDED "AS IS", WITHOUT WARRANTY OF ANY KIND, EXPRESS OR IMPLIED, INCLUDING BUT NOT LIMITED TO THE WARRANTIES OF MERCHANTABILITY, FITNESS FOR A PARTICULAR PURPOSE AND NON-INFRINGEMENT. IN NO EVENT SHALL THE AUTHORS OR COPYRIGHT HOLDERS BE LIABLE FOR ANY CLAIM, DAMAGES OR OTHER LIABILITY, WHETHER IN AN ACTION OF CONTRACT, TORT OR OTHERWISE, ARISING FROM, OUT OF OR IN CONNECTION WITH THE SOFTWARE OR THE USE OR OTHER DEALINGS IN THE SOFTWARE.

(18) FastDelegat

<http://www.codeproject.com/KB/cpp/FastDelegate.aspx>

THE WORK (AS DEFINED BELOW) IS PROVIDED UNDER THE TERMS OF THIS SOURCE PROJECT OPEN LICENSE ("LICENSE"). THE WORK IS PROTECTED BY COPYRIGHT AND/OR OTHER APPLICABLE LAW. ANY USE OF THE WORK OTHER THAN AS AUTHORIZED UNDER THIS LICENSE OR COPYRIGHT LAW IS PROHIBITED.

BY EXERCISING ANY RIGHTS TO THE WORK PROVIDED HEREIN, YOU ACCEPT AND AGREE TO BE BOUND BY THE TERMS OF THIS LICENSE. THE AUTHOR GRANTS YOU THE RIGHTS CONTAINED HEREIN IN CONSIDERATION OF YOUR ACCEPTANCE OF SUCH TERMS AND CONDITIONS. IF YOU DO NOT AGREE TO ACCEPT AND BE BOUND BY THE TERMS OF THIS LICENSE, YOU CANNOT MAKE ANY USE OF THE WORK.

Definitions.

- "Articles" means, collectively, all articles written by Author which describes how the Source Code and Executable Files for the Work may be used by a user.
- "Author" means the individual or entity that offers the Work under the terms of this License.
- "Derivative Work" means a work based upon the Work or upon the Work and other pre-existing works.
- "Executable Files" refers to the executables, binary files, configuration and any required data files included in the Work.
- "Publisher" means the provider of the website, magazine, CD-ROM, DVD or other medium from or by which the Work is obtained by You.
- "Source Code" refers to the collection of source code and configuration files used to create the Executable Files.
- "Standard Version" refers to such a Work if it has not been modified, or has been modified in accordance with the consent of the Author, such consent being in the full discretion of the Author.
- "Work" refers to the collection of files distributed by the Publisher, including the Source Code, Executable Files, binaries, data files, documentation, whitepapers and the Articles.

i. "You" is you, an individual or entity wishing to use the Work and exercise your rights under this License.

Fair Use/Fair Use Rights. Nothing in this License is intended to reduce, limit, or restrict any rights arising from fair use, fair dealing, first sale or other limitations on the exclusive rights of the copyright owner under copyright law or other applicable laws, License Grant. Subject to the terms and conditions of this License, the Author hereby grants You a worldwide, royalty-free, non-exclusive, perpetual (for the duration of the applicable copyright) license to exercise the rights in the Work as stated below:

- You may use the standard version of the Source Code or Executable Files in Your own applications.
- You may apply bug fixes, portability fixes and other modifications obtained from the Public Domain or from the Author. A Work modified in such a way shall still be considered the standard version and will be subject to this License.
- You may (excluding the modify Your copy of this License (including the Articles)) in any way to create a Derivative Work, provided that You insert a prominent notice in each changed file stating how, when and where You changed that file.
- You may distribute the standard version of the Executable Files and Source Code or Derivative Work in aggregate with other (possibly commercial) programs as part of a larger (possibly commercial) software distribution.
- The Articles discussing the Work published in any form by the author may not be distributed or republished without the Author's consent. The author retains copyright to any such Articles. You may use the Executable Files and Source Code pursuant to this License but you may not repost or republish or otherwise distribute or make available the Articles, without the prior written consent of the Author.

Any subroutines or modules supplied by You and linked into the Source Code or Executable Files this Work shall not be considered part of this Work and will not be subject to the terms of this License.

Patent License. Subject to the terms and conditions of this License, each Author hereby grants to You a perpetual, worldwide, non-exclusive, no-charge, royalty-free, irrevocable (except as stated in this section) patent license to make, have made, use, import, and otherwise transfer the Work.

Restrictions. The license granted in Section 3 above is expressly made subject to and limited by the following restrictions:

- You agree not to remove any of the original copyright, patent, trademark, and attribution notices and associated disclaimers that may appear in the Source Code or Executable Files.
- You agree not to advertise or in any way imply that this Work is a product of Your own.
- The name of the Author may not be used to endorse or promote products derived from the Work without the prior written consent of the Author.
- You agree not to sell, lease, or rent any part of the Work. This does not restrict you from including the Work or any part of the Work inside a larger software distribution that itself is being sold. The Work by itself, though, cannot be sold, leased or rented.
- You may distribute the Executable Files and Source Code only under the terms of this License, and you must include a copy of, or the Uniform Resource Identifier for, this License with every copy of the Executable Files and Source Code you distribute and ensure that anyone receiving such Executable Files and Source Code agrees that the terms of this License apply to such Executable Files and/or Source Code. You may not offer or impose any terms on the Work that alter or restrict the terms of this License or the recipients' exercise of the rights granted hereunder. You may not sublicense the Work. You must keep intact all notices that refer to this License and to the disclaimer of warranties. You may not distribute the Executable Files or Source Code with any technological measures that control access or use of the Work in a manner inconsistent with the terms of this License.
- You agree not to use the Work for illegal, immoral or improper purposes, or on pages containing illegal, immoral or improper material. The Work is subject to applicable export laws. You agree to comply with all such laws and regulations that may apply to the Work after Your receipt of the Work.

Representations, Warranties and Disclaimer: THIS WORK IS PROVIDED "AS IS", "WHERE IS" AND "AS AVAILABLE", WITHOUT ANY EXPRESS OR IMPLIED WARRANTIES OR CONDITIONS OR GUARANTEES. YOU, THE USER, ASSUME ALL RISK IN ITS USE, INCLUDING COPYRIGHT INFRINGEMENT, PATENT INFRINGEMENT, SUITABILITY, ETC. AUTHOR EXPRESSLY DISCLAIMS ALL EXPRESS, IMPLIED OR STATUTORY WARRANTIES OR CONDITIONS, INCLUDING WITHOUT LIMITATION, WARRANTIES OR CONDITIONS OF MERCHANTABILITY, MERCHANTABLE QUALITY OR FITNESS FOR A PARTICULAR PURPOSE, OR ANY WARRANTY OF TITLE OR NON-INFRINGEMENT, OR THAT THE WORK (OR ANY PORTION THEREOF) IS CORRECT, USEFUL, BUG-FREE OR FREE OF VIRUSES. YOU MUST PASS THIS DISCLAIMER ON WHENEVER YOU DISTRIBUTE THE WORK OR DERIVATIVE WORKS.

Indemnity. You agree to defend, indemnify and hold harmless the Author and the Publisher from and against any claims, suits, losses, damages, liabilities, costs, and expenses (including reasonable legal or attorneys' fees) resulting from or relating to any use of the Work by You.

Limitation on Liability. EXCEPT TO THE EXTENT REQUIRED BY APPLICABLE LAW, IN NO EVENT WILL THE AUTHOR OR THE PUBLISHER BE LIABLE TO YOU ON ANY LEGAL THEORY FOR ANY SPECIAL, INCIDENTAL, CONSEQUENTIAL, PUNITIVE OR EXEMPLARY DAMAGES ARISING OUT OF THIS LICENSE OR THE USE OF THE WORK OR OTHERWISE, EVEN IF THE AUTHOR OR THE PUBLISHER HAS BEEN ADVISED OF THE POSSIBILITY OF SUCH DAMAGES.

Termination.

a. This License and the rights granted hereunder will terminate automatically upon any breach by You of any term of this License. Individuals or entities who have received Derivative Works from You under this License, however, will not have their licenses terminated provided such individuals or entities remain in full compliance with those licenses. Sections 1, 2, 6, 7, 8, 9, 10 and 11 will survive any termination of this License.

b. If you bring a copyright, trademark, patent or any other infringement claim against any contributor over infringements you claim are made by the Work, your license from such contributor to the Work ends automatically.

c. Subject to the above terms and conditions, this License is perpetual (for the duration of the applicable copyright in the Work). Notwithstanding the above, the Author reserves the right to release the Work under different license terms or to stop distributing the Work at any time, provided, however that any such election will not serve to withdraw this License (or any other license that has been, or is required to be, granted under the terms of this License), and this License will continue in full force and effect unless terminated as stated above.

Publisher. The parties hereby confirm that the Publisher shall not, under any circumstances, be responsible for and shall not have any liability in respect of the subject matter of this License. The Publisher makes no warranty whatsoever in connection with the Work and shall not be liable to You or any party on any legal theory for any damages whatsoever, including without limitation any general, special, incidental or consequential damages arising in connection to this license. The Publisher reserves the right to cease making the Work available to You at any time without notice.

Miscellaneous

- This License shall be governed by the laws of the location of the head office of the Author or if the Author is an individual, the laws of location of the principal place of residence of the Author.
  - If any provision of this License is invalid or unenforceable under applicable law, it shall not affect the validity or enforceability of the remainder of the terms of this License, and without further action by the parties to this License, such provision shall be reformed to the minimum extent necessary to make such provision valid and enforceable.
  - Term or provision of this License shall be deemed waived and no breach consented to unless such waiver or consent shall be in writing and signed by the party to be charged with such waiver or consent.
  - This License constitutes the entire agreement between the parties with respect to the Work licensed herein. There are no understandings, agreements or representations with respect to the Work specified herein. The Author shall not be bound by any additional provisions that may appear in any communication from You. This License may not be modified without the mutual written agreement of the Author and You.
- (19) Tremolo  
<http://ws.clo.org/pinknoise/tremolo>  
Copyright (C) 2002-2009 Xiph.org Foundation Changes Copyright (C) 2009-2010 Robin Watts for Pinknoise Productions Ltd  
Redistribution and use in source and binary forms, with or without modification, are permitted provided that the following conditions are met:

- Redistributions of source code must retain the above copyright notice, this list of conditions and the following disclaimer.

- Redistributions in binary form must reproduce the above copyright notice, this list of conditions and the following disclaimer in the documentation and/or other materials provided with the distribution.

- Neither the name of the Xiph.org Foundation nor the names of its contributors may be used to endorse or promote products derived from this software without specific prior written permission.

THIS SOFTWARE IS PROVIDED BY THE COPYRIGHT HOLDERS AND CONTRIBUTORS "AS IS" AND ANY EXPRESS OR IMPLIED WARRANTIES, INCLUDING, BUT NOT LIMITED TO, THE IMPLIED WARRANTIES OF MERCHANTABILITY AND FITNESS FOR A PARTICULAR PURPOSE ARE DISCLAIMED. IN NO EVENT SHALL THE FOUNDATION OR CONTRIBUTORS BE LIABLE FOR ANY DIRECT, INDIRECT, INCIDENTAL, SPECIAL, EXEMPLARY, OR CONSEQUENTIAL DAMAGES (INCLUDING, BUT NOT LIMITED TO, PROCUREMENT OF SUBSTITUTE GOODS OR SERVICES; LOSS OF USE, DATA, OR PROFITS; OR BUSINESS INTERRUPTION) HOWEVER CAUSED AND ON ANY THEORY OF LIABILITY, WHETHER IN CONTRACT, STRICT LIABILITY, OR TORT (INCLUDING NEGLIGENCE OR OTHERWISE) ARISING IN ANY WAY OUT OF THE USE OF THIS SOFTWARE, EVEN IF ADVISED OF THE POSSIBILITY OF SUCH DAMAGE.

(20) Tremor

<http://wiki.xiph.org/index.php/Tremor>

Copyright (c) 2002, Xiph.org Foundation

Redistribution and use in source and binary forms, with or without modification, are permitted provided that the following conditions are met:

- Redistributions of source code must retain the above copyright notice, this list of conditions and the following disclaimer.

- Redistributions in binary form must reproduce the above copyright notice, this list of conditions and the following disclaimer in the documentation and/or other materials provided with the distribution.

- Neither the name of the Xiph.org Foundation nor the names of its contributors may be used to endorse or promote products derived from this software without specific prior written permission.

THIS SOFTWARE IS PROVIDED BY THE COPYRIGHT HOLDERS AND CONTRIBUTORS "AS IS" AND ANY EXPRESS OR IMPLIED WARRANTIES, INCLUDING, BUT NOT LIMITED TO, THE IMPLIED WARRANTIES OF MERCHANTABILITY AND FITNESS FOR A PARTICULAR PURPOSE ARE DISCLAIMED. IN NO EVENT SHALL THE FOUNDATION OR CONTRIBUTORS BE LIABLE FOR ANY DIRECT, INDIRECT, INCIDENTAL, SPECIAL, EXEMPLARY, OR CONSEQUENTIAL DAMAGES (INCLUDING, BUT NOT LIMITED TO, PROCUREMENT OF SUBSTITUTE GOODS OR SERVICES; LOSS OF USE, DATA, OR PROFITS; OR BUSINESS INTERRUPTION) HOWEVER CAUSED AND ON ANY THEORY OF LIABILITY, WHETHER IN CONTRACT, STRICT LIABILITY, OR TORT (INCLUDING NEGLIGENCE OR OTHERWISE) ARISING IN ANY WAY OUT OF THE USE OF THIS SOFTWARE, EVEN IF ADVISED OF THE POSSIBILITY OF SUCH DAMAGE.

(21) Mersenne Twister

<http://www.math.sci.hiroshima-u.ac.jp/~m-mat/MTM2002/CODES/Mt19937.c>

Copyright (C) 1997 - 2002, Makoto Matsumoto and Takaji Nishimura.

All rights reserved.

Redistribution and use in source and binary forms, with or without modification, are permitted provided that the following conditions are met:

Redistributions of source code must retain the above copyright notice, this list of conditions and the following disclaimer. Redistributions in binary form must reproduce the above copyright notice, this list of conditions and the following disclaimer in the documentation and/or other materials provided with the distribution.

This names of its contributors may not be used to endorse or promote products derived from this software without specific prior written permission.

THIS SOFTWARE IS PROVIDED BY THE COPYRIGHT HOLDERS AND CONTRIBUTORS "AS IS" AND ANY EXPRESS OR IMPLIED WARRANTIES, INCLUDING, BUT NOT LIMITED TO, THE IMPLIED WARRANTIES OF MERCHANTABILITY AND FITNESS FOR A PARTICULAR PURPOSE ARE DISCLAIMED. IN NO EVENT SHALL THE COPYRIGHT OWNER OR CONTRIBUTORS BE LIABLE FOR ANY DIRECT, INDIRECT, INCIDENTAL, SPECIAL, EXEMPLARY, OR CONSEQUENTIAL DAMAGES (INCLUDING, BUT NOT LIMITED TO, PROCUREMENT OF SUBSTITUTE GOODS OR SERVICES; LOSS OF USE, DATA, OR PROFITS; OR BUSINESS INTERRUPTION) HOWEVER CAUSED AND ON ANY THEORY OF LIABILITY, WHETHER IN CONTRACT, STRICT LIABILITY, OR TORT (INCLUDING NEGLIGENCE OR OTHERWISE) ARISING IN ANY WAY OUT OF THE USE OF THIS SOFTWARE, EVEN IF ADVISED OF THE POSSIBILITY OF SUCH DAMAGE.

(22) eURL

<http://curl.haxx.se>

COPYRIGHT AND PERMISSION NOTICE

Copyright (c) 1996 - 2011, Daniel Stenberg <daniel@haxx.se> All rights reserved.

Permission to use, copy, modify, and distribute this software for any purpose with or without fee is hereby granted, provided that the above copyright notice and this permission notice appear in all copies.

THE SOFTWARE IS PROVIDED "AS IS", WITHOUT WARRANTY OF ANY KIND, EXPRESS OR IMPLIED, INCLUDING BUT NOT LIMITED TO THE WARRANTIES OF MERCHANTABILITY, FITNESS FOR A PARTICULAR PURPOSE AND NON-INFRINGEMENT OF THIRD PARTY RIGHTS. IN NO EVENT SHALL THE AUTHORS OR COPYRIGHT HOLDERS BE LIABLE FOR ANY CLAIM, DAMAGES OR OTHER LIABILITY, WHETHER IN AN ACTION OF CONTRACT, TORT OR OTHERWISE, ARISING FROM, OUT OF OR IN CONNECTION WITH THE SOFTWARE OR THE USE OR OTHER DEALINGS IN THE SOFTWARE.

Except as contained in this notice, the name of a copyright holder shall not be used in advertising or otherwise to promote the sale, use or other dealings in this Software without prior written authorization of the copyright holder.

(23) o-res

<http://o-res.haxx.se>

Copyright 1998 by the Massachusetts Institute of Technology.

Permission to use, copy, modify, and distribute this software and its documentation for any purpose and without fee is hereby granted, provided that the above copyright notice appear in all copies and that both that copyright notice and this permission notice appear in supporting documentation, and that the name of M.I.T. not be used in advertising or publicity pertaining to distribution of the software without specific, written prior permission. M.I.T. makes no representations about the suitability of this software for any purpose. It is provided "as is" without express or implied warranty.

(24) LZ4

Copyright (c) 2011-2014, Yann Collet All rights reserved.

Redistribution and use in source and binary forms, with or without modification, are permitted provided that the following conditions are met:

\* Redistributions of source code must retain the above copyright notice, this list of conditions and the following disclaimer. \* Redistributions in binary form must reproduce the above copyright notice, this list of conditions and the following disclaimer in the documentation and/or other materials provided with the distribution.

THIS SOFTWARE IS PROVIDED BY THE COPYRIGHT HOLDERS AND CONTRIBUTORS "AS IS" AND ANY EXPRESS OR IMPLIED WARRANTIES, INCLUDING, BUT NOT LIMITED TO, THE IMPLIED WARRANTIES OF MERCHANTABILITY AND FITNESS FOR A PARTICULAR PURPOSE ARE DISCLAIMED. IN NO EVENT SHALL THE COPYRIGHT HOLDER OR CONTRIBUTORS BE LIABLE FOR ANY DIRECT, INDIRECT, INCIDENTAL, SPECIAL, EXEMPLARY, OR CONSEQUENTIAL DAMAGES (INCLUDING, BUT NOT LIMITED TO, PROCUREMENT OF SUBSTITUTE GOODS OR SERVICES; LOSS OF USE, DATA, OR PROFITS; OR BUSINESS INTERRUPTION) HOWEVER CAUSED AND ON ANY THEORY OF LIABILITY, WHETHER IN CONTRACT, STRICT LIABILITY, OR TORT (INCLUDING NEGLIGENCE OR OTHERWISE) ARISING IN ANY WAY OUT OF THE USE OF THIS SOFTWARE, EVEN IF ADVISED OF THE POSSIBILITY OF SUCH DAMAGE.















## Supplied Accessories

-  Indoor FM antenna --- (1)
-  AM loop antenna --- (1)
-  Remote controller (RC-900M) --- (1)  
Batteries (AA/R6) --- (2)
-  Power cord --- (1)
-  Speaker setup microphone --- (1)

\* The number in parenthesis indicates the quantity. On packaging, the letter at the end of the product name indicates the color.

## How to use the remote controller

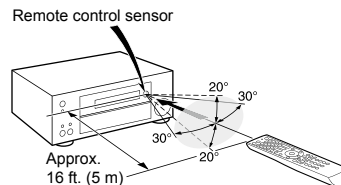
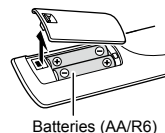

- \* If you do not use the remote controller for a long time, remove the batteries to prevent leakage.
- \* Note that keeping consumed batteries inside may cause corrosion resulting in damage of the remote controller.

# ONKYO

**Onkyo Corporation**  
Kitahama Chuo Bldg, 2-2-22 Kitahama, Chuo-ku,  
OSAKA 541-0041, JAPAN  
<http://www.onkyo.com/>

### The Americas

**Onkyo U.S.A. Corporation**  
18 Park Way, Upper Saddle River, N.J. 07458, U.S.A.  
For Dealer, Service, Order and all other Business Inquiries:  
Tel: 201-785-2600 Fax: 201-785-2650  
<http://www.us.onkyo.com/>

For Product Support Team Only:  
1-800-229-1687  
<http://www.us.onkyo.com/>

### Europe

**Onkyo Europe Electronics GmbH**  
Liegnitzerstrasse 6, 82194 Groebenzell, GERMANY  
Tel: +49-8142-4401-0 Fax: +49-8142-4208-213  
<http://www.eu.onkyo.com/>

### Onkyo Europe Electronics GmbH (UK Branch)

Anteros Building, Odyssey Business Park, West End Road,  
South Ruislip, Middlesex, HA4 6QQ United Kingdom  
Tel: +44 (0)871-200-1996 Fax: +44 (0)871-200-1995

### China

**Onkyo China Limited (Hong Kong)**  
Unit 1033, 10/F, Star House, No 3, Salisbury Road,  
Tsim Sha Tsui Kowloon, Hong Kong.  
Tel: 852-2429-3118 Fax: 852-2428-9039  
<http://www.hk.onkyo.com/>

### Onkyo China PRC (Mainland)

302, Building 1, 20 North Chaling Rd., Xuhui District,  
Shanghai, China 200032,  
Tel: 86-21-52131366 Fax: 86-21-52130396  
<http://www.cn.onkyo.com/>

### Asia, Oceania, Middle East, Africa

Please contact an Onkyo distributor referring to Onkyo  
SUPPORT site.

<http://www.intl.onkyo.com/support/>

The above-mentioned information is subject to change  
without prior notice.

Visit the Onkyo web site for the latest update.

SN 29402034

(C) Copyright 2015 Onkyo Corporation Japan. All rights reserved. Onkyo has the Privacy Policy. You can review it at [<http://www.onkyo.com/privacy/>].



\* 2 9 4 0 2 0 3 4 \*

F1506-0





# TX-RZ900/TX-RZ800

AV RECEIVER

[The Basic Manual](#) includes information needed when starting up and also instructions for frequently used operations. [The Advanced Manual](#) has more detailed information and advanced settings.

## Advanced Manual

### CONTENTS

<b>Details on AM/FM reception</b>	<b>2</b>	<b>Operating Music Files with the Remote Controller</b>	<b>16</b>	Blu-ray Disc player/DVD player/DVD recorder operation	57
Tuning into a Radio Station	2	About the Remote Controller	16	VCR/PVR operation	57
Presetting an AM/FM Radio Station	3	Remote Controller Buttons	16	Satellite receiver / Cable receiver operation	58
Using RDS (European, Australian and Asian models)	3	Icons Displayed during Playback	16	CD player operation	58
<b>Playing Music Files on a USB Storage Device</b>	<b>5</b>	<b>Using the Listening Modes</b>	<b>17</b>	Cassette tape deck operation	59
<b>Listening to Internet Radio</b>	<b>6</b>	Selecting Listening Mode	17	To operate CEC-compatible components	59
About Internet Radio	6	Listening Mode Types	17	<b>Advanced Connections</b>	<b>60</b>
TuneIn Radio	6	Selectable Listening Modes	20	Connecting Bi-amp Speakers	60
Pandora®—Getting Started (U.S., Australia and New Zealand only)	7	Checking the Input Format	33	Connecting Dipole Speakers	60
Spotify	8	<b>Advanced Settings (Setup Menu)</b>	<b>34</b>	Connecting a Power Amplifier	60
SiriusXM Internet Radio (North American only)	8	How to Set	34	<b>Connecting and Operating Onkyo RI Components</b>	<b>61</b>
Slacker Personal Radio (North American only)	9	1. Input/Output Assign	35	About RI Function	61
Registering Other Internet Radios	10	2. Speaker	38	RI Connection and Setting	61
<b>Playing Music with DLNA</b>	<b>12</b>	3. Audio Adjust	44	iPod®/iPhone® Operation	62
About DLNA	12	4. Source	46	<b>Control Function between the Unit and External Component</b>	<b>63</b>
Configuring the Windows Media® Player	12	5. Listening Mode Preset	47	<b>Firmware Update</b>	<b>64</b>
DLNA Playback	12	6. Hardware	48	About Firmware Update	64
Controlling Remote Playback from a PC	13	7. Remote Controller	54	Updating the Firmware via Network	64
<b>Playing Music Files in a Shared Folder</b>	<b>14</b>	8. Miscellaneous	54	Updating the Firmware via USB	65
About Shared Folder	14	<b>Operating Other Components with the Remote Controller</b>	<b>55</b>	<b>Troubleshooting</b>	<b>67</b>
Setting PC	14	Functions of REMOTE MODE Buttons	55	<b>Reference Information</b>	<b>73</b>
Playing from a Shared Folder	14	Programming Remote Control Codes	55		
		TV operation	56		



## Details on AM/FM reception

### Tuning into a Radio Station

#### ■ Tuning automatically

1. Press TUN on the main unit several times to select either "AM" or "FM".



2. Press TUNING MODE so that the "AUTO" indicator on the display lights.

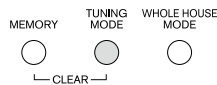

3. Press TUNING▼▲ to start automatic tuning.

- Searching automatically stops when a station is found. When tuned into a radio station, the "▶ TUNED◀" indicator on the display lights. When tuned into an FM radio station, the "FM STEREO" indicator lights.
- No sound is output while the "▶ TUNED◀" indicator is off.

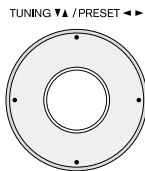

**When the signal from an FM radio station is weak:** Radio wave may be weak depending on the building structure and environmental conditions. In that case, perform the manual tuning procedure as explained in the next section, "Tuning manually", to manually select the desired station.

#### ■ Tuning manually

1. Press TUN on the main unit several times to select either "AM" or "FM".



2. Press TUNING MODE so that the "AUTO" indicator on the display goes off.

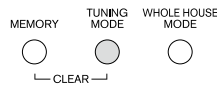

3. Press TUNING▼▲ to select the desired radio station.

- The frequency changes by 1 step each time you press the button. The frequency changes continuously if the button is held down and stops when the button is released. Tune by looking at the display.

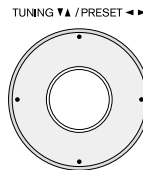

**To return to automatic tuning:** Press TUNING MODE on the main unit again. The unit automatically tunes into a radio station. Normally "AUTO" should be displayed.

#### ■ Tuning to the frequency directly

It allows you to directly enter the frequency of the radio station you want to listen to.

1. Press TUNER on the remote controller several times to select either "AM" or "FM".

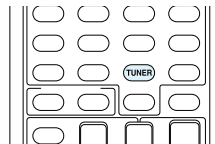

### Details on AM/FM reception

2. Press D.TUN.

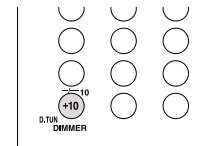

3. Using the number buttons, enter the frequency of the radio station within 8 seconds.

- To enter 87.5 (FM), for example, press 8, 7, 5, or 8, 7, 5, 0. If you entered the wrong number, press D.TUN and enter the correct one.

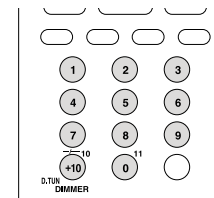

## Presetting an AM/FM Radio Station

It allows you to register up to 40 of your favorite AM/FM radio stations. Registering radio stations in advance allows you to tune into your radio station of choice directly.

### Registration Procedure

1. Tune into the AM/FM radio station you want to register.
2. Press MEMORY on the unit so that the preset number on the display flashes.

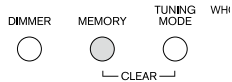

3. Press PRESET ◀▶ several times to select a number between 1 and 40 while the preset number is flashing (about 8 seconds).

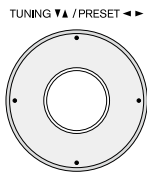

4. Press MEMORY again to register the station.
  - When the station is registered, the preset number stops flashing.
  - Repeat this procedure for all of your favorite AM/FM radio stations.

### Selecting a Preset Radio Station

1. Press CH +/- on the remote controller to select a preset number.
  - Alternatively you can press PRESET ◀▶ on the main unit. You can also select by directly entering the preset number with the number buttons on the remote controller.

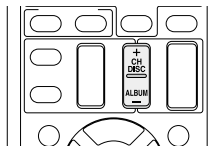

### Deleting a Preset Radio Station

1. Press CH +/- on the remote controller to select the preset number to delete.

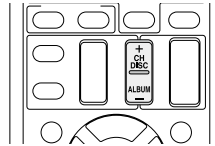

2. Press and hold MEMORY on the main unit and press TUNING MODE to delete the preset number.
  - When deleted, the number on the display goes off.

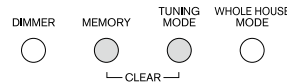

## Using RDS (European, Australian and Asian models)

RDS stands for Radio Data System and is a method of transmitting data in FM radio signals.

- RDS works only in areas where RDS broadcasts are available.
- In some cases, the text information appeared on the display is not identical to the content transmitted by the RDS station. Furthermore, unexpected characters may be displayed when the unit receives unsupported characters. However, this is not a malfunction.
- If the signal from an RDS station is weak, the RDS data may be displayed continuously or not at all.

**PS (Program Service):** Tuning into a radio station distributing Program Service information displays the radio station name. Pressing DISPLAY displays the frequency for 3 seconds.

**RT (Radio Text):** Tuning into a radio station transmitting Radio Text information displays text on the display of the unit.

**PTY (Program Type):** Allows you to search for RDS stations by program type.

**TP (Traffic Program):** Allows you to search for radio stations transmitting traffic information.

### Displaying Radio Text (RT)

1. Press RT/PTY/TP on the main unit once.
  - The Radio Text (RT) is displayed scrolling across the display. "No Text Data" is displayed when no text information is available.

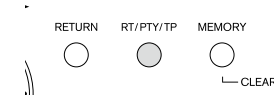

### Searching by Type (PTY)

1. Press RT/PTY/TP on the main unit twice.
  - The current program type appears on the display.

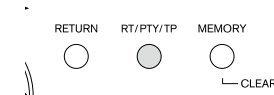

2. Press PRESET ◀▶ to select the type of program to search for.

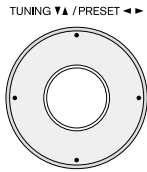

- The following RDS station types are displayed:

None  
 News (News reports)  
 Affairs (Current affairs)  
 Info (Information)  
 Sport  
 Educate (Education)  
 Drama  
 Culture  
 Science (Science and technology)  
 Varied  
 Pop M (Pop music)  
 Rock M (Rock music)  
 Easy M (Middle of the road music)  
 Light M (Light classics)  
 Classics (Serious classics)  
 Other M (Other music)  
 Weather  
 Finance  
 Children (Children's programmes)  
 Social (Social affairs)  
 Religion  
 Phone In  
 Travel  
 Leisure  
 Jazz (Jazz music)  
 Country (Country music)  
 Nation M (National music)  
 Oldies (Oldies music)  
 Folk M (Folk music)  
 Document (Documentary)

3. Press ENTER to search the radio stations of the selected type.

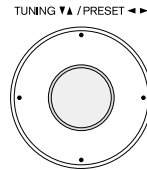

4. When such a radio station is found, the indication on the display flashes. Then, press ENTER again.
- If no stations are found, the message "Not Found" is displayed.

#### ■ Listening to Traffic Information (TP)

1. Press RT/PTY/TP on the main unit three times.
- "[TP]" will be displayed if traffic information is transmitted by the radio station you are tuned in. "TP" only is displayed if no traffic information is available.

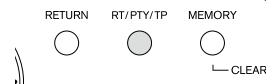

2. Press ENTER to search a radio station distributing traffic information.

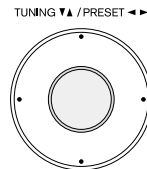

3. When a radio station is found, searching stops and traffic information is received.
- "Not Found" is displayed if no radio station distributing traffic information is found.





## Playing Music Files on a USB Storage Device

- **Operation:** You can set up by viewing the guidance displayed on the TV screen (OSD). Select the item with the cursor buttons of the remote controller and press ENTER to confirm your selection. To return to the previous screen, press RETURN.
- (European, Australian and Asian models) If the OSD language is set to Chinese, the operations in this section are not displayed on the TV. Operate by looking at the display on the main unit. Note that the display on the main unit does not support the display of Chinese characters. Characters that cannot be displayed are replaced with asterisks (\*).

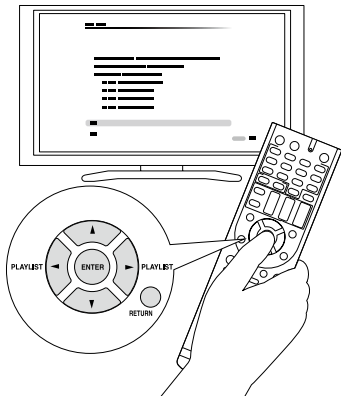

### ■ Playing Back

1. Plug your USB storage device with the music files into the USB port on the rear of the unit.

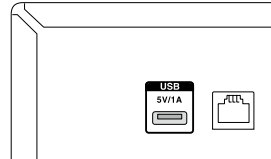

2. Press NET on the remote controller to display the NET TOP screen.

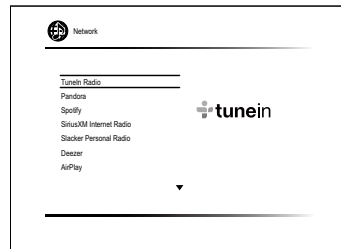
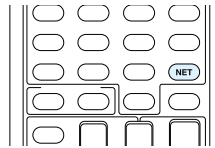

3. Select "USB" with the cursors and press ENTER.
  - If the "USB" indicator on the display flashes, check whether the USB storage device is plugged in properly.
  - Do not unplug the USB storage device while "Connecting..." is on the display. This may cause data corruption or malfunction.
4. Press ENTER again in the next screen. The list of folders and music files on the USB storage device are displayed. Select the folder with the cursors and press ENTER to confirm your selection.

### Playing Music Files on a USB Storage Device

5. With the cursors, select the music file to play, and then press ENTER or ► to start playback.

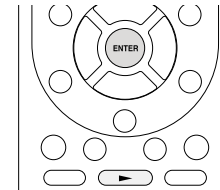

- The USB port of this unit conforms with the USB 1.1 standard. The transfer speed may be insufficient for some content you play, which may cause some interruption in sound.



## Listening to Internet Radio

## Listening to Internet Radio

## About Internet Radio

The unit comes preset with Internet radio stations such as TuneIn Radio for you to enjoy these services, just by connecting the unit to the Internet.

- Network services or contents may become unavailable if the service provider terminates its service.

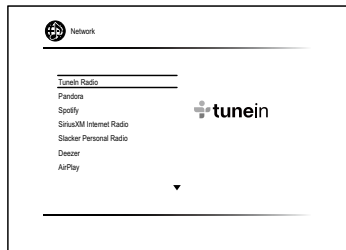

## TuneIn Radio

With more than 70,000 radio stations and 2 million on-demand programs registered, TuneIn Radio is a service where you can enjoy music, sports and news from all over the world.

- **Operation:** You can set up by viewing the guidance displayed on the TV screen (OSD). Select the item with the cursor buttons of the remote controller and press ENTER to confirm your selection. To return to the previous screen, press RETURN.
- (European, Australian and Asian models) If the OSD language is set to Chinese, the operations in this section are not displayed on the TV. Operate by looking at the display on the main unit. Note that the display on the main unit does not support the display of Chinese characters. Characters that cannot be displayed are replaced with asterisks (\*).

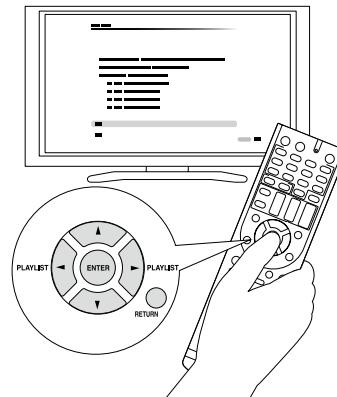

## Playing Back

1. Press NET on the remote controller to display the NET TOP screen.

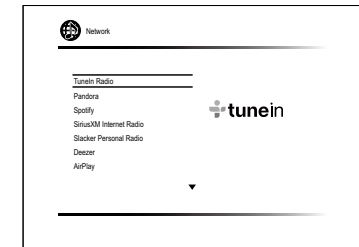
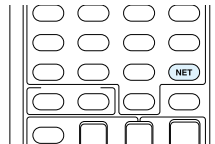

2. Select "TuneIn Radio" with the cursors and press ENTER to display the TuneIn Radio top screen.
3. With the cursors, select a radio station or program and press ENTER to start playing.

## Regarding the TuneIn Radio Menu

To display the TuneIn menu, press MENU or ENTER while playing a radio station. Selecting the corresponding menu item with the cursors and pressing ENTER allows you to perform the following operations:

**Add to My Presets:** Registers the radio station or program being broadcast in "My Presets". Once registered, "My Presets" is displayed in the level under TuneIn Radio. To play, select the program from "My Presets".

**Remove from My Presets:** Deletes a radio station or program from your "My Presets" within TuneIn Radio.

**Report a problem:** Reports a problem or interactively solves a problem related to TuneIn Radio.

**View Schedule:** Displays the radio station or program schedule.

**Clear recents:** Clears all radio stations and programs from the "Recents" within TuneIn Radio. (This menu is displayed only when a radio station or program inside the "Recents" is being played.)

**Add to My Favorites:** Registers the radio station or program being broadcast in "My Favorites". "My Favorites" are displayed in the level under the one displayed when you press NET. To play, select the program from "My Favorites".



## Listening to Internet Radio

### ■ Regarding the TuneIn Radio Account

Creating an account on the TuneIn Radio website (tunein.com) and logging in it from the unit allows you to automatically add radio stations and programs to your "My Presets" on the unit as you follow them on the website. "My Presets" are displayed in the level under TuneIn Radio. To display a radio station registered in "My Presets", you must log into TuneIn Radio from the unit. To log in, select "Login" - "I have a TuneIn account" in the "TuneIn Radio" top list on the unit, and then enter your user name and password.

- If you associate the device on My Page within the TuneIn Radio website using the registration code obtained by selecting "Login" - "Login with a registration code" on the unit, you can log in without entering the user name and password.

### Pandora®—Getting Started (U.S., Australia and New Zealand only)

Pandora is a free, personalized Internet radio service that plays the music you know and helps you discover music you'll love.

- **Operation:** You can set up by viewing the guidance displayed on the TV screen (OSD). Select the item with the cursor buttons of the remote controller and press ENTER to confirm your selection. To return to the previous screen, press RETURN.
- (European, Australian and Asian models) If the OSD language is set to Chinese, the operations in this section are not displayed on the TV. Operate by looking at the display on the main unit. Note that the display on the main unit does not support the display of Chinese characters. Characters that cannot be displayed are replaced with asterisks (\*).

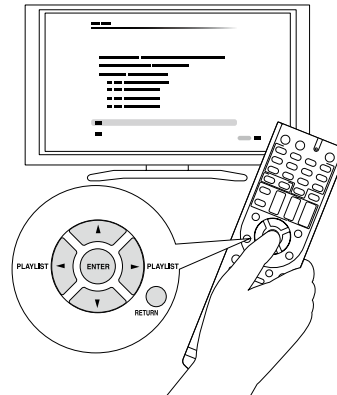

### ■ Playing Back

1. Press NET on the remote controller to display NET TOP screen.

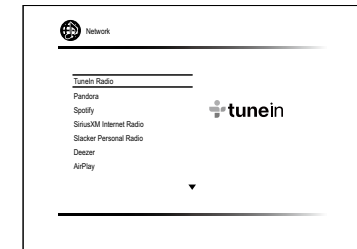
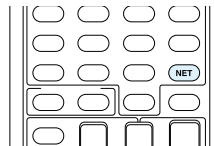

2. With the cursors on the remote controller, select "Pandora", and then press ENTER.
3. Use ▲/▼ to select "I have a Pandora Account" or "I'm new to Pandora" and then press ENTER. If you are new to Pandora select "I'm new to Pandora". You will see an activation code on your TV screen. Please write down this code. Go to an Internet connected computer and point your browser to [www.pandora.com/onkyo](http://www.pandora.com/onkyo). Enter your activation code and then follow the instructions to create your Pandora account and your personalized Pandora stations. You can create your stations by entering your favorite tracks and artists when prompted. After you have created your account and stations you can return to your Onkyo receiver and press ENTER to begin listening to your personalized Pandora. If you have an existing Pandora account, you can add your Pandora account to your Onkyo receiver by selecting "I have a Pandora Account" and logging in with your email and password.
  - If you want to use multiple user accounts, see "Using Multiple Accounts". Login can be made from the "Users" screen.
4. To play a station, use ▲/▼ to select the station from your station list, and then press ENTER. Playback starts and the playback screen appears.

### ■ Create a New Station

Enter the name of a track, artist, or genre and Pandora will create a unique radio station for you based on the musical qualities of that track, artist, or genre.

**I like this track:** Give a track "thumbs-up" and Pandora will play more music like it.

**I don't like this track:** Give a track "thumbs-down" and Pandora will ban that track from the current station.



**Why is this track playing?:** Discover some of the musical attributes that Pandora uses to create your personal radio stations.

**I'm tired of this track:** If you are tired of a track, you can put the track to sleep and Pandora will not play it for one month.

**Create station from this artist:** Creates a radio station from this artist.

**Create station from this track:** Creates a radio station from this track.

**Delete this station:** This will permanently delete a station from your Pandora account. All of your thumbs feedback will be lost should you choose to re-create the station with the same track or artist.

**Rename this station:** Lets you rename the current radio station.

**Bookmark this artist:** Pandora will bookmark your favorite artist for your profile on [www.pandora.com](http://www.pandora.com).

**Bookmark this track:** Pandora will bookmark the current track and allow you to buy them all from Amazon or iTunes in one step!

**Add to My Favorites:** Adds a station to My Favorites list.

## PANDORA

PANDORA, the PANDORA logo, and the Pandora trade dress are trademarks or registered trademarks of Pandora Media, Inc. Used with permission.

## Spotify

This unit is compatible with Spotify Connect. To enable Spotify Connect, install the Spotify application on your smartphone or tablet and create a Spotify premium account.

- The unit and smartphone or tablet must be connected to the same router.
- Refer to the following for the procedures for configuring Spotify:  
[www.spotify.com/connect/](http://www.spotify.com/connect/)
- The Spotify software is subject to third party licenses found here:  
[www.spotify.com/connect/third-party-licenses](http://www.spotify.com/connect/third-party-licenses)

### ■ Playing Back

Just by clicking the Connect icon in the playback screen of the Spotify application and selecting this unit, you can automatically turn this unit on (auto power on function), switch input to the NET position, and start playback of high-quality streaming from Spotify. To enable the auto power on function, make sure the "Network Standby" setting item in this unit's Setup is "On".

### ■ Notes for using the multi-zone function

- To enjoy Spotify music in a separate room, select Zone 2/Zone 3, and manually select "NET" as the input of the separate room. Also select this unit in the Spotify application.
- You can adjust the volume in the Spotify app only when either outputting to Zone 2 when "Zone 2 Out" is set to "Variable" and you have connected a pre-main amplifier, or when you have connected to the speakers in the separate room. In other cases, adjust the volume on the audio equipment placed in a separate room.
- To enjoy Spotify music in the main room after playing it in a separate room, select "NET" as the input of the main room.



## SiriusXM Internet Radio (North American only)

If you want to listen to the service, you must subscribe. To subscribe go to [www.siriusxm.com/internetradio](http://www.siriusxm.com/internetradio) with your computer. When you subscribe, you will be provided with a username and password which has to be entered into the AV receiver. To use SiriusXM Internet Radio, you must have your AV receiver connected to the Internet. Using the remote control, follow these steps:

- **Operation:** You can set up by viewing the guidance displayed on the TV screen (OSD). Select the item with the cursor buttons of the remote controller and press ENTER to confirm your selection. To return to the previous screen, press RETURN.
- (European, Australian and Asian models) If the OSD language is set to Chinese, the operations in this section are not displayed on the TV. Operate by looking at the display on the main unit. Note that the display on the main unit does not support the display of Chinese characters. Characters that cannot be displayed are replaced with asterisks (\*).

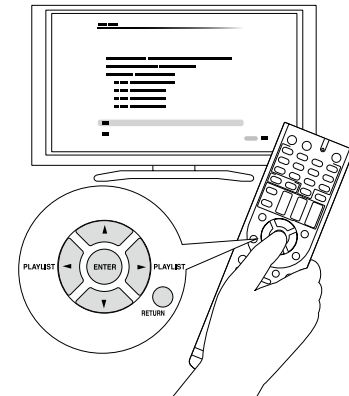

## ■ Playing Back

1. Press NET on the remote controller to display NET TOP screen.

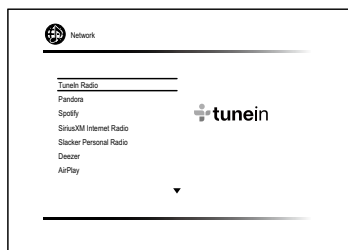
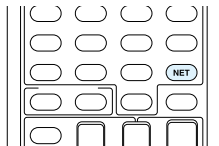

2. With the cursors on the remote controller, select "SiriusXM Internet Radio", and then press ENTER.
3. Select "Sign In", and then press ENTER. If you have an existing SIRIUS account, you can sign in by selecting "Sign In". Enter your user name and password in the next keyboard screen, or in Web Setup. If you do not know your username or password, call Sirius XM at (888) 539-7474 for assistance.
  - If you want to use multiple user accounts, see "Using Multiple Accounts". Login can be made from the "Users" screen.

### Using the keyboard screen

- ① Use ▲/▼/◀/▶ and ENTER to enter your user name and password.
- ② Select "OK".
- ③ Press ENTER. The "Confirm your entries" screen appears.
- ④ Press ENTER. "Please wait..." appears and then "SiriusXM Internet Radio" screen appears which displays the category available for selection.
4. Use ▲/▼ to select the category and then press ENTER. The channel list screen for the selected category appears.
5. Use ▲/▼ to select the desired channel and then press ENTER. The playback screen for the selected channel appears and you can listen to SiriusXM Internet Radio. You can

control the tracks with the buttons on the remote control. Enabled buttons: ▶, ■, ◀◀, ▶▶

**Add to My Favorites:** Adds a channel to My Favorites list.

**Add to Presets:** Adds the currently playing station to presets list.

**Delete from Presets:** Deletes the currently playing station from presets list.

## ((SiriusXM))

SiriusXM Internet Radio subscriptions are sold separately and are governed by the Sirius Terms and Conditions (see [www.sirius.com](http://www.sirius.com)). Be sure to read this agreement before you purchase your subscription.

Sirius, XM and all related marks and logos are trademarks of Sirius XM Radio Inc. and its subsidiaries. All rights reserved.

## Slacker Personal Radio (North American only)

• **Operation:** You can set up by viewing the guidance displayed on the TV screen (OSD). Select the item with the cursor buttons of the remote controller and press ENTER to confirm your selection. To return to the previous screen, press RETURN.

- (European, Australian and Asian models) If the OSD language is set to Chinese, the operations in this section are not displayed on the TV. Operate by looking at the display on the main unit. Note that the display on the main unit does not support the display of Chinese characters. Characters that cannot be displayed are replaced with asterisks (\*).

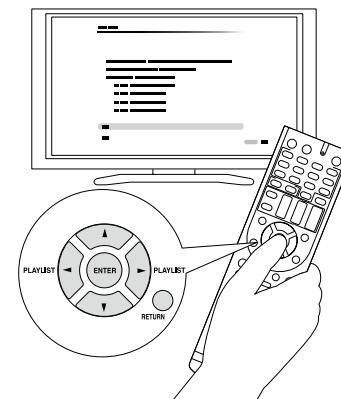

## ■ Playing Back

1. Press NET on the remote controller to display NET TOP screen.

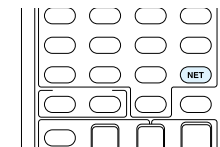

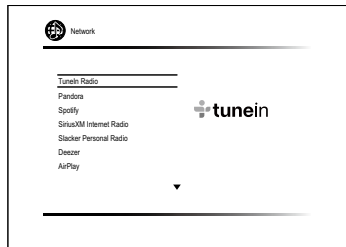

2. With the cursors on the remote controller, select "Slacker Personal Radio", and then press ENTER.
3. If you do not have an account, create one on the Slacker website ([www.slacker.com](http://www.slacker.com)) with your computer. If you already have a Slacker account, select "Sign in to your account" and then press ENTER. The keyboard screen appears. You can enter information from the remote control or the keys on the main unit.
4. If there are no mistakes in the information you have entered, use ▲/▼/◀/▶ to select "OK" then press ENTER. An account information confirmation screen appears.
5. If you do not have an account, select "Access without Sign In" and press ENTER to use a restricted version of the service. Note that use will be restricted.
  - If you want to use multiple user accounts, see "Using Multiple Accounts". Login can be made from the "Users" screen.
6. Use ▲/▼ to select a menu item and then press ENTER. To sign out, use ▲/▼ to select "Sign out" from this screen and then press ENTER.
7. Use ▲/▼ to select a station and then press ENTER or ▶ to start playback from the station. The playback screen appears.
8. You can control the tracks with the buttons on the remote control.  
Enabled buttons: ▶, ||, ■, ▶▶

**Rate Song as Favorite:** Stores information to server, making it more likely that the song will be played again.

**Ban Song:** Stores information to server, making it less likely that the song will be played again.

**Ban Artist:** Stores information to server, making it less likely that the songs from this artist will be played again.

**Mark Favorite:** Adds the currently playing station to your favorites.

**Unmark Favorite:** Deletes the currently playing station from your favorites.

**Add song to Library:** Adds the currently playing track to your library.

**Delete song from Library:** Deletes the currently playing track from your library.

**Add to My Favorites:** Adds a station or song to My Favorites list.

**Using Multiple Accounts:** The AV receiver supports multiple user accounts, which means you can freely switch between several logins. After registering user accounts, login is performed from the "Users" screen. Press MENU while the Users screen is displayed. "Add new user", "Remove this user" menu appear. You can either store a new user account, or delete an existing one.

- Some of the services do not allow the use of multiple user accounts.
- You can store up to 10 user accounts.
- To switch between accounts you must first log out from the current account, and log in again on the "Users" screen.

## Registering Other Internet Radios

To listen to other Internet radio program, register the program in the "My Favorites" list as described in the next section. "My Favorites" are displayed in the level under the one displayed when you press NET.

- You can register up to 40 Internet radio stations.
- The unit supports Internet radio stations stored in the following formats: PLS (URL ending in .pls), M3U (URL ending in .m3u) and RSS (URL ending in rss/rd/xfml). Depending on the data type and playback format, there may be some you cannot play.
- Available services may vary depending on your area of residence.
- **Operation:** You can set up by viewing the guidance displayed on the TV screen (OSD). Select the item with the cursor buttons of the remote controller and press ENTER to confirm your selection. To return to the previous screen, press RETURN.
- (European, Australian and Asian models) If the OSD language is set to Chinese, the operations in this section are not displayed on the TV. Operate by looking at the display on the main unit. Note that the display on the main unit does not support the display of Chinese characters. Characters that cannot be displayed are replaced with asterisks (\*).

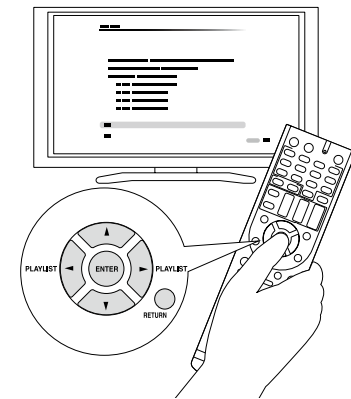

## Registration Procedure

**Before Performing any Operation:** The name and URL of the radio station that you want to add are required for



Listening to Internet Radio

registration. Check the specifications before use.

1. Press NET on the remote controller to display the NET TOP screen.

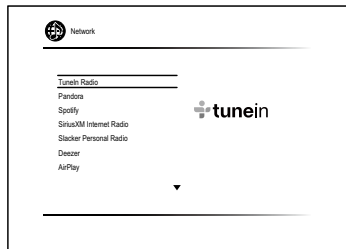
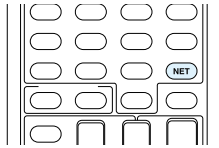

2. Select "My Favorites" with the cursors and press ENTER to display the "My Favorites" list screen.
3. With the cursors, select a blank area of "My Favorites" and press MENU to display the menu screen.

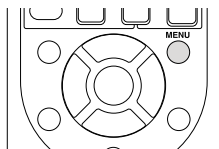

4. Select "Create new station" with the cursors and press ENTER to display the keyboard screen.
5. Enter the name and URL of the radio station to add.
  - Select "A/a" and press ENTER to toggle between upper and lower case. Select "←" or "→" and press ENTER to move the cursor to the selected direction. Select "⊠" and press ENTER to delete one character to the left of the cursor position.

■ Registering a Station with PC

**Before Performing any Operation:** The name and URL of the radio station that you want to add are required for registration. Check the specifications before use. Also,

make sure this unit and a computer are connected to the same router.

1. Press RCV on the remote controller.
  - Always press RCV first to change the remote controller to RECEIVER mode (the mode to operate this unit) since its mode may be changed to operate another component.

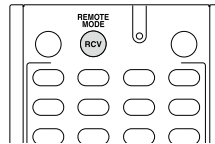

2. Press SETUP to display the Setup menu.

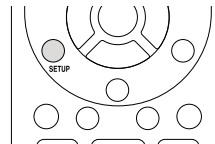

3. With the cursors, select "6. Hardware" - "Network" - "IP Address" to display the IP address.
  - Take note of the IP address since you will need it later.
4. Open the Internet browser on your PC or smartphone and enter the IP address of the unit in the URL field.
  - When using Internet Explorer, you can alternatively select "Open" in the "File" menu to enter the IP address.
  - Information of the unit is displayed on the browser. ("WEB Setup")
5. Click "★" tab, then enter the name and URL of the Internet radio station.
6. Click "Save" to register the entered Internet radio station in "My Favorites".

- To rename the registered radio station:** Select the radio station in the "My Favorites" list and press MENU to display the menu screen. Select "Rename this station" with the cursors and press ENTER to display the keyboard screen. Rename the station as desired.
- Radio stations can be renamed also from "WEB Setup".

■ Playing a Registered Radio Station

1. Press NET on the remote controller to display the NET TOP screen.

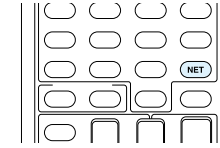

2. Select "My Favorites" with the cursors and press ENTER to display the registered Internet radio stations.
3. With the cursors, select a radio station and press ENTER to start playing.

■ Deleting a Registered Radio Station

1. Press NET on the remote controller to display the NET TOP screen.

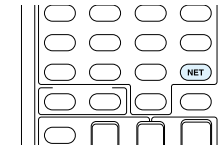

2. Select "My Favorites" with the cursors and press ENTER to display the registered Internet radio stations.
3. With the cursors, select the radio station to delete and press MENU to display the menu screen.

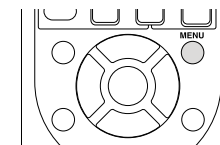

4. With the cursors, select "Delete from My Favorites", and then press ENTER. A confirmation screen will appear.
5. With the cursors, select "OK", and then press ENTER to delete the radio station.
  - Select "Back" to return to the previous screen.
  - Radio stations can be deleted also from "WEB Setup".



## Playing Music with DLNA

### About DLNA

Digital Living Network Alliance (DLNA) can be referred to as a technology standard or the industry group to develop the technology standard to interconnect and use AV components, computers and other devices in a home network. This unit allows you to use DLNA to play music files stored on a computer or a hard disk connected to your home network (NAS device). Make sure this unit and a computer or NAS device are connected to the same router.

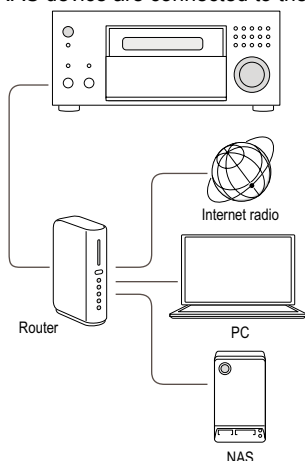

- To stream a music file, you need a NAS device with DLNA server functions or a PC where a player (e.g., Windows Media® Player 11 or Windows Media® Player 12) with DLNA server functions is installed. To enable streaming with Windows Media® Player 11 or Windows Media Player® 12, you must first configure the settings.

### Configuring the Windows Media® Player

#### ■ Windows Media® Player 11

- Turn on your PC and start Windows Media® Player 11.
- In the "Library" menu, select "Media Sharing" to display a dialog box.
- Select the "Share my media" check box, and then click "OK" to display the compatible devices.
- Select this unit, and then click "Allow".
  - When it is clicked, the corresponding icon is checked.
- Click "OK" to close the dialog.
  - Depending on the version of Windows Media® Player, the names of the items you need to select may differ from the explanation here.

#### ■ Windows Media® Player 12

- Turn on your PC and start Windows Media® Player 12.
- In the "Stream" menu, select "Turn on media streaming" to display a dialog box.
  - If media streaming is already turned on, select "More streaming options..." in the "Stream" menu to list players in the network, and then go to step 4.
- Click "Turn on media streaming" to list players in the network.
- Select this unit in "Media streaming options" and check that it is set to "Allow".
- Click "OK" to close the dialog.
  - Depending on the version of Windows Media® Player, the names of the items you need to select may differ from the explanation here.

### DLNA Playback

- Operation:** You can set up by viewing the guidance displayed on the TV screen (OSD). Select the item with the cursor buttons of the remote controller and press ENTER to confirm your selection. To return to the previous screen, press RETURN.
- (European, Australian and Asian models) If the OSD language is set to Chinese, the operations in this section are not displayed on the TV. Operate by looking at the display on the main unit. Note that the display on the main unit does not support the display of Chinese characters. Characters that cannot be displayed are replaced with asterisks (\*).

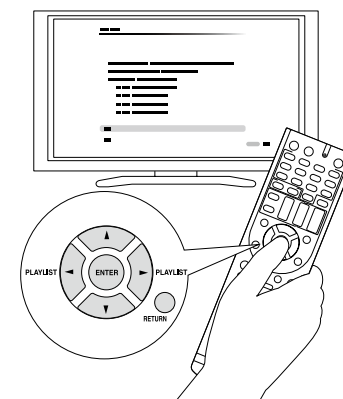

#### ■ Playing Back

- Start the server (Windows Media® Player 11, Windows Media® Player 12, or NAS device) containing the music files to play.
- Press NET on the remote controller to display the NET TOP screen.
  - If the "NET" indicator on the display flashes, the unit is not properly connected to the network. Check the connection.





## Playing Music with DLNA

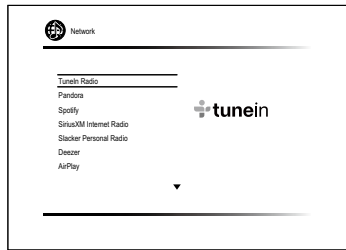
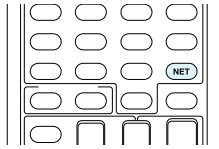

3. Select "DLNA" with the cursors and press ENTER.
4. Select the target server with the cursors and press ENTER to display the items list screen.
  - Searching does not work in servers that do not support search functions.
  - The unit cannot access pictures and videos stored on servers.
  - Contents stored on the server may not be displayed depending on the server sharing settings.
5. With the cursors, select the music file to play, and then press ENTER or ► to start playback.
  - If "No Item." is displayed, check whether the network is properly connected.

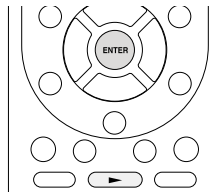

### Controlling Remote Playback from a PC

You can use this unit to play music files stored on your PC by operating the PC inside your home network. The unit supports remote playback with Windows Media® Player 12. To use the remote playback function with Windows Media® Player 12, Windows Media® Player 12 must be configured in advance.

- Using a DLNA-compatible controller (such as an Android application), you can select a music file stored on Windows Media® Player 12 and stream to this unit by operating the controller. For information on how to remotely play using the controller, refer to the controller's instruction manual.

#### ■ Setting PC

1. Turn on your PC and start Windows Media® Player 12.
2. In the "Stream" menu, select "Turn on media streaming" to display a dialog box.
  - If media streaming is already turned on, select "More streaming options..." in the "Stream" menu to list players in the network, and then go to step 4.
3. Click "Turn on media streaming" to list players in the network.
4. Select this unit in "Media streaming options" and check that it is set to "Allow".
5. Click "OK" to close the dialog box.
6. Open the "Stream" menu and check that "Allow remote control of my Player..." is checked.
  - Depending on the version of Windows Media® Player, the names of the items you need to select may differ from the explanation here.

#### ■ Remote playback

1. Turn on the power of the unit.
2. Turn on your PC and start Windows Media® Player 12.
3. Select and right-click the music file to play with Windows Media® Player 12.
  - To remotely play a music file on another server, open the target server from "Other Libraries" and select the music file to play.
4. Select this unit in "Play to" to open the "Play to" window of Windows Media® Player 12 and start playback on the unit.

- Operations during remote playback are possible from the "Play to" window on the PC. The playback screen is displayed on the TV connected to the HDMI output of the unit. If your PC is running on Windows® 8, click "Play to", and then select this unit.
5. Adjust the volume using the volume bar on the "Play to" window.
    - Sometimes, the volume displayed on the remote playback window may differ from that appeared on the display of the unit.
    - When the volume is adjusted from the unit, the value is not reflected in the "Play to" window.
    - This unit cannot play music files remotely in the following conditions.
      - It is using a network service.
      - It is playing a music file on a USB storage device.
  - Depending on the version of Windows Media® Player, the names of the items you need to select may differ from the explanation here.



## Playing Music Files in a Shared Folder

### About Shared Folder

A shared folder is configured in a network device such as a PC or NAS (hard disk connected to your home network) for access from other users.

You can play music files in a shared folder on your PC or NAS connected to the same home network as that of the unit. To play music files in a shared folder, you must first configure Windows® 8 or Windows® 7. Make sure the unit and PC or NAS device are connected to the same router.

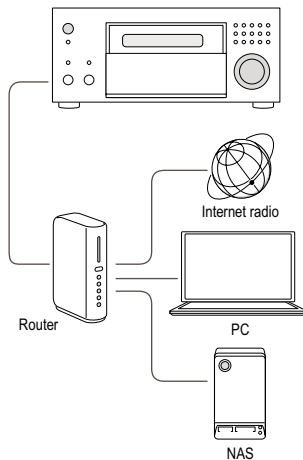

- The sharing options must be configured and a shared folder created on the PC in advance.
- For information on how to configure the NAS device and create a shared folder, refer to the NAS device's instruction manual.

### Setting PC

#### ■ Configuring the Sharing Options

1. Select "Choose home group and sharing options" on the "Control Panel".
  - If the menu is not displayed, check whether "View by" is set to "Category".
2. Select "Change advanced sharing settings".
3. Check whether the following radio buttons are selected in "Home or Work":
  - "Enable network discovery"
  - "Turn on file and printer sharing"
  - "Turn on sharing so anyone with network access can read and write files in the Public folders."
  - "Turn off password protected sharing"
4. Select "Save Changes" and click "OK" on the dialog box.

#### ■ Creating a Shared Folder

1. Select and right-click the folder to share.
2. Select "Properties".
3. Select "Advanced Sharing" on the "Sharing" tab.
4. Select the "Share this folder" check box and click "OK".
5. Select "Share" for "Network File and Folder Sharing".
6. Select "Everyone" from the pull-down menu. Click "Add", and then "Share".
  - To set user name and password to a shared folder, set "Permissions" in "Advanced Sharing" on the "Sharing" tab.
  - Check whether a workgroup is set.

### Playing Music Files in a Shared Folder

#### Playing from a Shared Folder

- **Operation:** You can set up by viewing the guidance displayed on the TV screen (OSD). Select the item with the cursor buttons of the remote controller and press ENTER to confirm your selection. To return to the previous screen, press RETURN.
- (European, Australian and Asian models) If the OSD language is set to Chinese, the operations in this section are not displayed on the TV. Operate by looking at the display on the main unit. Note that the display on the main unit does not support the display of Chinese characters. Characters that cannot be displayed are replaced with asterisks (\*).

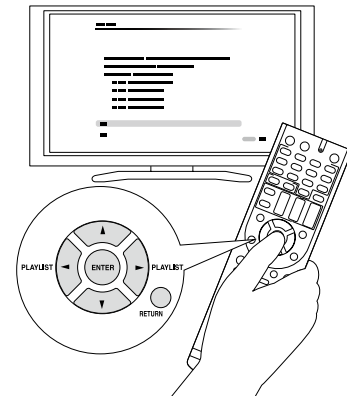

#### ■ Playing Back

1. Press NET on the remote controller to display the NET TOP screen.
  - If the "NET" indicator on the display flashes, the unit is not properly connected to the network. Check the connection.

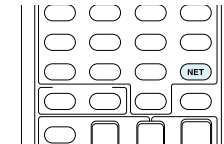

Playing Music Files in a Shared Folder

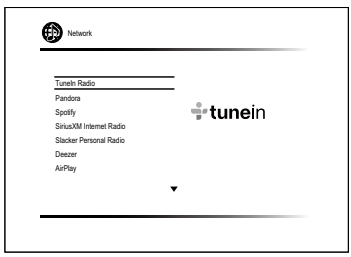

2. With the cursors, select "Home Media", and then press ENTER.
3. With the cursors, select the target server, and then press ENTER.
  - You can check the server name of your PC from the PC properties.
4. With the cursors, select the target shared folder, and then press ENTER.
5. If a username and password is required, enter the necessary login information.
  - The login information is the account information set at the time of creating the shared folder.
  - Once entered, the login information will be remembered from the next time onward.
6. With the cursors, select the music file to play, and then press ENTER or ► to start playback.

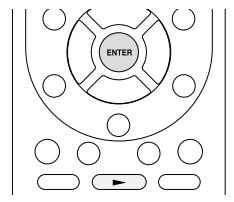

## Operating Music Files with the Remote Controller

### About the Remote Controller

The remote controller of this unit allows you to play music files stored on USB storage devices, Internet radio, PCs and NAS devices on your home network, as well as on BLUETOOTH-enabled devices. It also allows you to view information of the music file being played and perform various other operations.

- Available buttons may vary depending on the service and device to play.
- Some buttons cannot be used with BLUETOOTH-enabled devices. Furthermore, the BLUETOOTH-enabled devices must support the AVRCP profile. Some devices may not be operated, even when they support AVRCP profile.

### Remote Controller Buttons

1. Press INPUT SELECTOR (NET, or BLUETOOTH) appropriate for the input source on the remote controller.

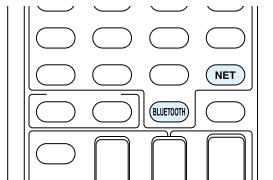

2. Operate the remote controller by referring to the name and function of each of the buttons.

En-16

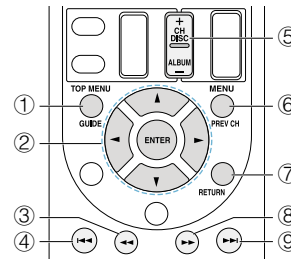

- 1 **TOP MENU**: This button displays the top menu for each media or server.
- 2 **▲/▼, ENTER**: These buttons navigate through items and activate the selected item.  
◀/▶: These buttons allow you to navigate to other pages when the list continues on other pages.
- 3 **◀◀**: This button fast-reverses the current track. This button is not operable from 10 seconds before the playback ends.
- 4 **◀◀◀**: This button plays the current track from the beginning. Pressing this button twice plays the previous track.
- 5 **+/-**: Moves the cursor up or down on the Internet radio stations list in "My Favorites".
- 6 **MENU**: This button displays the menu of each Internet radio service.
- 7 **RETURN**: This button returns to the previous screen.
- 8 **▶▶▶**: This button fast-forwards the current track. This button is not operable from 10 seconds before the playback ends.
- 9 **▶▶▶▶**: This button plays the next track.

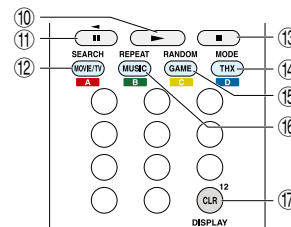

- 10 **▶**: This button starts the playback.
- 11 **||**: This button pauses the playback.
- 12 **SEARCH**: This button toggles between the playback screen and list screen during playback.
- 13 **■**: This button stops the playback.

### Operating Music Files with the Remote Controller

- 14 **MODE**: This button displays the video from the input selected in "Video Select". Each press of the button displays or turns off the video. You can change the display position of the OSD by pressing ENTER while the video is displayed on the screen.
  - These buttons are disabled when the OSD language is set to Chinese. (European, Australian and Asian models)
- 15 **RANDOM**: This button performs random playback.
- 16 **REPEAT**: This button replays the track(or tracks). Pressing this button repeatedly cycles through the repeat modes.
- 17 **DISPLAY**: This button changes the displayed track information during playback. Pressing this button when the list screen is displayed toggles the screen to playback.
  - BLUETOOTH-enabled devices: Usable buttons are ▶, ◀◀◀, ◀◀, ||, ▶▶, ▶▶▶, and ■.

### Icons Displayed during Playback

Icons are displayed on the display during music file playback. The meaning of each icon is as follows:

- 📁: Folder
- 🎵: Track
- ♯: Play
- ⏸: Pause
- ⏩: Fast-forward
- ⏪: Fast-reverse
- ♯: Artist
- 📁: Album
- 10: Repeat one track
- 📁: Repeat within a folder
- 🔄: Repeat
- ♻: Shuffle



## Using the Listening Modes

### Selecting Listening Mode

The listening modes allow you to select the best sound effect for your input source.

1. After pressing RCV on the remote controller, press one of the following four buttons.

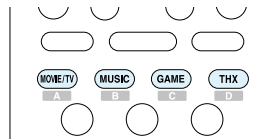

2. Press the selected button repeatedly to switch the modes displayed on the display of the unit.
  - Set the listening mode of your choice by listening to the actual sound.

Dolby D

For details on the listening modes see "Listening Mode Types". For listening modes selectable with each button, refer to "Selectable Listening Modes".

### Listening Mode Types

The unit allows you to enjoy audio in a variety of listening modes. This section lists the types of listening modes available on the unit and describes their functions.

#### ■ Future listening mode update

A future firmware update is planned to enable the unit to support playback in DTS:X audio format. For this reason, the available listening modes will vary depending on the firmware version.

Versions before the release of an update with support for the DTS:X audio format

- Neo:6 Cinema and Neo:6 Music are available.

Versions that support the DTS:X audio format

- DTS:X and DTS Neural:X are available. (Neo:6 Cinema and Neo:6 Music become unavailable after the update.)

#### In alphabetical order

##### ■ AllCh Stereo

Ideal for background music, this mode fills the entire listening area with stereo sound.

##### ■ Direct

In this mode, audio from the input source is output as-is. For example, if a 2 ch source from a music CD is input, the output will be stereo, or if Dolby Digital signal is input, the sound field will be controlled in accordance with the number of channels present.

##### ■ Dolby Atmos

Introduced first in the cinema, Dolby Atmos brings a revolutionary sense of dimension and immersion to the Home Theater experience. Dolby Atmos is an adaptable and scalable object based format that reproduces audio as independent sounds (or objects) that can be accurately positioned and move dynamically throughout the 3 dimensional listening space during playback. A key ingredient of Dolby Atmos is the introduction of a height plane of sound above the listener.

##### ■ Dolby D (Dolby Digital)

Mode suitable for playing sources recorded in Dolby Digital.

- This listening mode can be selected only if your Blu-ray Disc/DVD player is digitally connected to the unit or the player's output setting is bitstream.

##### ■ Dolby D+ (Dolby Digital Plus)

Mode suitable for playing sources recorded in Dolby Digital Plus.

- This listening mode can be selected only if your Blu-ray Disc/DVD player is digitally connected to the unit or the player's output setting is bitstream.

##### ■ Dolby Surround

Dolby surround is a next generation surround technology that intelligently up mixes stereo; 5.1 and 7.1 content for playback through your surround speaker system. Dolby surround is compatible with traditional speaker layouts, as well as Dolby Atmos enabled playback systems that employ in-ceiling speakers or products with Dolby speaker technology.

##### ■ Dolby TrueHD

Mode suitable for playing sources recorded in Dolby TrueHD.

- This listening mode can be selected only if your Blu-ray Disc/DVD player is digitally connected to the unit or the player's output setting is bitstream.

##### ■ DSD

Mode suitable for playing sources recorded in DSD.

- This unit supports DSD signals input through HDMI IN. However, depending on the connected player, better sound is possible when output from the PCM output of the player.
- This listening mode can be selected only if your Blu-ray Disc/DVD player's output setting is DSD.

##### ■ DTS

Mode suitable for playing sources recorded in DTS.

- This listening mode can be selected only if your Blu-ray Disc/DVD player is digitally connected to the unit or the player's output setting is bitstream.



**■ DTS 96/24**

Mode suitable for playing sources recorded in DTS 96/24. With 96 kHz sampling rate and 24-bit resolution, it provides superior fidelity.

- Depending on the settings, this listening mode becomes DTS.
- This listening mode can be selected only if your Blu-ray Disc/DVD player is digitally connected to the unit or the player's output setting is bitstream.

**■ DTS Express**

Mode suitable for playing sources recorded in DTS Express.

- This listening mode can be selected only if your Blu-ray Disc/DVD player is digitally connected to the unit or the player's output setting is bitstream.

**■ DTS-HD HR (DTS-HD High Resolution Audio)**

Mode suitable for playing sources recorded in DTS-HD High Resolution Audio.

- This listening mode can be selected only if your Blu-ray Disc/DVD player is digitally connected to the unit or the player's output setting is bitstream.

**■ DTS-HD MSTR (DTS-HD Master Audio)**

Mode suitable for playing sources recorded in DTS-HD Master Audio.

- This listening mode can be selected only if your Blu-ray Disc/DVD player is digitally connected to the unit or the player's output setting is bitstream.

**■ DTS Neo:6**

This mode expands any 2 ch source for 5.1 ch multichannel surround playback. It offers full-bandwidth on all channels, with great independence between the channels. There are two variants for this mode: one ideal for movies and another ideal for music.

- **Neo:6 Cinema:** Use this mode with any 2 ch movie.
- **Neo:6 Music:** Use this mode with any 2 ch music source.

**■ DTS Neural:X**

Neural:X enables upmixing of legacy content such as mono, stereo, 5.1 or 7.1ch to many higher speaker count including the layout using elevated channels set for DTS:X playback.

**■ DTS:X**

This mode is for use with DTS sources. DTS:X is DTS's next-generation object-based surround sound technology that includes height to deliver a fully-immersive listening experience to your living room.

**■ ES Discrete (DTS-ES Discrete)**

This mode is for use with DTS-ES Discrete sources and enables 6.1 ch or 7.1 ch playback using back channel. Completely discrete seven channels will improve spatial imaging and enable 360-degree sound localization producing a sound crossing between the surround channels.

- This listening mode can be selected only if your Blu-ray Disc/DVD player is digitally connected to the unit or the player's output setting is bitstream.
- Use on the DVD with DTS ES logo, particularly on the software containing DTS-ES Matrix soundtrack.

**■ ES Matrix (DTS-ES Matrix)**

This mode is for use with DTS-ES Matrix soundtrack and enables 6.1 ch or 7.1 ch playback using matrix-encoded back channel.

- This listening mode can be selected only if your Blu-ray Disc/DVD player is digitally connected to the unit or the player's output setting is bitstream.
- Use on the CD, DVD or LD with DTS ES logo, particularly on the software containing DTS-ES Matrix soundtrack.

**■ Full Mono**

In this mode, all speakers output the same sound in mono, so the sound you hear is the same regardless of where you are within the listening room.

**■ Game-Action**

In this mode, sound localization is distinct with emphasis on bass.

**■ Game-Rock**

In this mode, sound pressure is emphasized to heighten live feel.

**■ Game-RPG**

In this mode, the sound has a dramatic feel with a similar atmosphere to Orchestra mode.

**■ Game-Sports**

Suitable for audio source with much reverberation.

**■ Mono**

Use this mode when watching an old movie with a mono soundtrack, or use it to separately reproduce soundtracks in two different languages recorded in the left and right channels of some movies. It is also suitable for DVDs or other sources containing multiplexed audio.

**■ Multich (Multichannel)**

Mode suitable for playing sources recorded in PCM multichannel.

**■ Orchestra**

Suitable for classical or operatic music. This mode emphasizes the surround channels in order to widen the stereo image, and simulates the natural reverberation of a large hall.

**■ Pure Audio**

This mode reproduces the original sound accurately. Since the audio from the input source is output without surround sound processing and the display and video circuitry are turned off, possible noise sources are minimized for a realistic audio reproduction.

- This mode cannot be selected when Zone 2 or Zone 3 is active. Activating Zone 2 or Zone 3 when this mode is selected automatically switches to the Direct listening mode.

**■ Stereo**

In this mode, sound is output from the front left and right speakers and subwoofer.



### ■ Studio-Mix

Suitable for rock or pop music, Listening to music in this mode creates a lively sound field with a powerful acoustic image, like being at a club or rock concert.

### ■ T-D (Theater-Dimensional)

In this mode, you can enjoy a virtual playback of multichannel surround sound even with only two or three speakers. This works by controlling how sounds reach the listener's left and right ears.

### ■ THX

Founded by George Lucas, THX develops stringent standards that ensure movies are reproduced in movie theaters and home theaters just as the director intended. THX Modes carefully optimize the tonal and spatial characteristics of the soundtrack for reproduction in the home-theater environment. They can be used with 2-channel matrixed and multichannel sources. Back speaker output depends on the source material and the selected listening mode.

- The THX mode can finely adjust the acoustic and spatial characteristics of the soundtrack for the best reproduction of home theater sound. It will work on 2 ch source and multichannel source. Back speaker sound will differ depending on the source and selected listening mode.
- **THX Cinema:** THX Cinema mode corrects theatrical soundtracks for playback in a home theater environment. In this mode, THX Loudness Plus is configured for cinema levels and Re-EQ, Timbre Matching, and Adaptive Decorrelation are active.
- **THX Games:** THX Games mode is meant for spatially accurate playback of game audio, which is often mixed similarly to movies but in a smaller environment. THX Loudness Plus is configured for game audio levels, with Timbre Matching active.
- **THX Music:** THX Music mode is tailored for listening to music, which is typically mastered at significantly higher levels than movies. In this mode, THX Loudness Plus is configured for music playback and only Timbre Matching is active.

- **THX S2 Cinema (THX Select2 Cinema):** THX Select2 Cinema mode plays 5.1 movie using 7.1 ch giving you the best possible movie watching experience. In this mode, THX ASA processing blends the side surround speakers and back surround speakers providing the optimal mix of ambient and directional surround sounds.
- **THX S2 Games (THX Select2 Games):** For the replay of multichannel game audio, the THX Select2 Games mode should be selected. In this mode, THX ASA processing is applied to the surround channels of all 5.1 encoded game sources such as PCM, DTS, and Dolby Digital. This accurately places all game audio surround information creating a full 360 degree playback environment. THX Select2 Games is unique as it gives you a smooth transition of audio in all points of the surround field.
- **THX S2 Music (THX Select2 Music) :** For the replay of multichannel music, the THX Select2 Music should be selected. In this mode, THX ASA processing is applied to the surround channels of all 5.1 encoded music sources such as DTS, Dolby Digital, DVD-Audio, etc. to provide a wide and stable rear soundstage.
- **THX Surr EX (THX Surround EX) :** This mode expands 5.1-channel sources for 7.1- channel playback. It's especially suited to Dolby Digital EX sources. THX Surround EX, also known as Dolby Digital Surround EX, is a joint development between Dolby Laboratories and THX Ltd.

### ■ TV Logic

Suitable for TV shows produced in a TV studio. This mode enhances the surround effects to the entire sound to give clarity to voices and create a realistic acoustic image.

### ■ Unplugged

Suitable for acoustic instruments, vocals and jazz. This mode emphasizes the front stereo image, giving the impression of being right in front of the stage.

### ■ Reference

#### Dialogue Normalization

Dialogue Normalization (DialogNorm) is a feature of Dolby Digital, which is used to keep the programs at the same average listening level so the user does not have to change the volume control between Dolby Digital, Dolby Digital Plus and Dolby TrueHD programs. When playing back software which has been encoded in Dolby Digital, Dolby Digital Plus and Dolby TrueHD, sometimes you may see a brief message in the front panel display which will read "DialogNorm: X dB" (X being a numeric value). The display is showing how the program level relates with THX calibration level. If you want to play the program at calibrated theatrical levels, you may wish to adjust the volume. For example, if you see the following message: "DialogNorm: + 4 dB" in the front panel display, to keep the overall output level at THX calibrated loudness, just turn down the volume control by 4dB. However, unlike a movie theater where the playback loudness is preset, you can choose your preferred volume setting for best enjoyment.

#### THX Cinema Processing

THX is an exclusive set of standards and technologies established by the world-renowned film production company Lucasfilm Ltd. THX grew from George Lucas' personal desire to make your experience of the film soundtrack in both movie theaters and in your home theater as faithful as possible to what the director intended. Movie soundtracks are mixed in special environments called dubbing stages and are designed to be played back in movie theaters with similar equipment and conditions. Most of those soundtracks are remixed using flat response loudspeakers similar to those used in the small home theater environment before being transferred onto Blu-ray Discs, DVD, etc. THX engineers developed patented technologies to accurately translate the sound from the movie theater environment into the home, correcting the tonal and spatial errors that occur. On this product, when the THX indicator is on, THX features are automatically added in Cinema modes (e.g. THX Cinema, THX Surround EX).

#### Timbre Matching

The human ear changes our perception of a sound depending on the direction from which the sound is coming. In a movie theater, there is an array of surround speakers so that the surround information is all around you. In a home theater, you may only have two speakers located to the side of your head. In this case, the Timbre



## Using the Listening Modes

Matching feature filters the information going to the surround speakers so that they more closely match the tonal characteristics of the sound coming from the front speakers. This ensures seamless panning between the front and surround speakers.

**Adaptive Decorrelation**

In a movie theater, a large number of surround speakers help create an enveloping surround sound experience. If a home theater only has two sidewall surround speakers, the surround speakers may sound similar to headphones lacking spaciousness and envelopment. Surround sounds will also collapse toward the closet speaker as you move away from the middle seating position. Adaptive Decorrelation slightly changes one surround channel's time and phase relationship with respect to the other surround experience as in a movie theater using only two speakers.

**ASA (Advanced Speaker Array)**

ASA is a proprietary THX technology which processes the audio on the two side and two back surround speakers for the optional surround sound experience. When you set up your home theater system using eight speaker outputs (Left, Center, Right, Surround Right, Back Right, Back Left, Surround Left, and Subwoofer), be sure to go to the THX Audio Setup screen and choose the setting that closely corresponds to the back speaker spacing. This will reoptimize the surround sound field. ASA is used in three modes: THX Select2 Cinema, THX Select2 Music and THX Select2 Games.

**Selectable Listening Modes**

Listening modes that can be selected with the listening mode buttons will differ depending on the input signal format and actual speaker configuration. Also note that depending on the player settings and content, some listening modes may not be available for selecting.

- Listening modes available when headphones are connected are: Pure Audio, Mono, Direct, and Stereo.

**Future listening mode update**

A future firmware update is planned to enable the unit to support playback in DTS:X audio format. For this reason, the available listening modes will vary depending on the firmware version.

Versions before the release of an update with support for the DTS:X audio format

- Neo:6 Cinema and Neo:6 Music are available.

Versions that support the DTS:X audio format

- DTS:X and DTS Neural:X are available. (Neo:6 Cinema and Neo:6 Music become unavailable after the update.)

**MOVIE/TV button**

You can select a mode suitable for movies and TV programs.

Input Format	Listening Mode
Analog	Direct
	Mono
	Dolby Surround
	Neo:6 Cinema <sup>*1</sup>
	DTS Neural:X
	THX Cinema <sup>*2</sup>
	TV Logic <sup>*3</sup>
	AllCh Stereo <sup>*4</sup>
Full Mono <sup>*4</sup>	
T-D	

<sup>\*1</sup> Center speaker or surround speakers need to be installed.

<sup>\*2</sup> Surround speakers need to be installed.

<sup>\*3</sup> Surround speakers or height speakers need to be installed.

<sup>\*4</sup> Center speaker, surround speakers or height speakers need to be installed.

Input Format	Listening Mode
PCM	Direct
	Mono
	Dolby Surround
	Neo:6 Cinema <sup>*1</sup>
	DTS Neural:X
	THX Cinema <sup>*2</sup>
	TV Logic <sup>*3</sup>
	AllCh Stereo <sup>*4</sup>
Full Mono <sup>*4</sup>	
T-D	

<sup>\*1</sup> Center speaker or surround speakers need to be installed.

<sup>\*2</sup> Surround speakers need to be installed.

<sup>\*3</sup> Surround speakers or height speakers need to be installed.

<sup>\*4</sup> Center speaker, surround speakers or height speakers need to be installed.





Using the Listening Modes

Input Format	Listening Mode
Multich PCM	Direct
	Mono
	Multich* <sup>1</sup>
	Dolby Surround
	DTS Neural:X
	THX Cinema* <sup>2</sup>
	THX S2 Cinema* <sup>3</sup>
	THX Surr EX* <sup>3</sup>
	TV Logic* <sup>4</sup>
	AllCh Stereo* <sup>5</sup>
	Full Mono* <sup>5</sup>
	T-D

\*<sup>1</sup> Center speaker or surround speakers need to be installed.

\*<sup>2</sup> Surround speakers need to be installed.

\*<sup>3</sup> Back speakers need to be installed. Can be selected when the input format is 5.1 ch.

\*<sup>4</sup> Surround speakers or height speakers need to be installed.

\*<sup>5</sup> Center speaker, surround speakers or height speakers need to be installed.

Input Format	Listening Mode
DSD	Direct
	Mono
	DSD* <sup>1</sup> * <sup>2</sup>
	Dolby Surround
	Neo:6 Cinema* <sup>3</sup>
	DTS Neural:X
	THX Cinema* <sup>4</sup>
	THX S2 Cinema* <sup>5</sup>
	THX Surr EX* <sup>5</sup>
	TV Logic* <sup>6</sup>
	AllCh Stereo* <sup>7</sup>
	Full Mono* <sup>7</sup>
T-D	

\*<sup>1</sup> Cannot be selected when the input format is monaural or 2 ch.

\*<sup>2</sup> Center speaker or surround speakers need to be installed.

\*<sup>3</sup> Can only be selected when the input format is 2 ch and a center speaker or surround speakers are installed.

\*<sup>4</sup> Surround speakers need to be installed.

\*<sup>5</sup> Back speakers need to be installed. Can be selected when the input format is 5.1 ch.

\*<sup>6</sup> Surround speakers or height speakers need to be installed.

\*<sup>7</sup> Center speaker, surround speakers or height speakers need to be installed.

Input Format	Listening Mode
Dolby Atmos <ul style="list-style-type: none"> <li>The listening mode of Dolby Digital Plus or Dolby TrueHD can be selected if back speakers or height speakers are not connected.</li> </ul>	Direct
	Mono
	Dolby Atmos
	TV Logic
	AllCh Stereo
	Full Mono
	T-D

Input Format	Listening Mode
Dolby D	Direct
	Mono
	Dolby D* <sup>1</sup> * <sup>2</sup>
	Dolby Surround
	Neo:6 Cinema* <sup>3</sup>
	DTS Neural:X
	THX Cinema* <sup>4</sup>
	THX S2 Cinema* <sup>5</sup>
	THX Surr EX* <sup>5</sup>
	TV Logic* <sup>6</sup>
AllCh Stereo* <sup>7</sup>	
Full Mono* <sup>7</sup>	
T-D	

\*<sup>1</sup> Cannot be selected when the input format is monaural or 2 ch.

\*<sup>2</sup> Center speaker or surround speakers need to be installed.

\*<sup>3</sup> Can only be selected when the input format is 2 ch and a center speaker or surround speakers are installed.

\*<sup>4</sup> Surround speakers need to be installed.

\*<sup>5</sup> Back speakers need to be installed. Can be selected when the input format is 5.1 ch.

\*<sup>6</sup> Surround speakers or height speakers need to be installed.

\*<sup>7</sup> Center speaker, surround speakers or height speakers need to be installed.



Using the Listening Modes

Input Format	Listening Mode
Dolby D+	Direct
	Mono
	Dolby D+ <sup>*1 *2</sup>
	Dolby Surround
	Neo:6 Cinema <sup>*3</sup>
	DTS Neural:X
	THX Cinema <sup>*4</sup>
	THX S2 Cinema <sup>*5</sup>
	THX Surr EX <sup>*5</sup>
	TV Logic <sup>*6</sup>
	AllCh Stereo <sup>*7</sup>
	Full Mono <sup>*7</sup>
T-D	

<sup>\*1</sup> Cannot be selected when the input format is monaural or 2 ch.

<sup>\*2</sup> Center speaker or surround speakers need to be installed.

<sup>\*3</sup> Can only be selected when the input format is 2 ch and a center speaker or surround speakers are installed.

<sup>\*4</sup> Surround speakers need to be installed.

<sup>\*5</sup> Back speakers need to be installed. Can be selected when the input format is 5.1 ch.

<sup>\*6</sup> Surround speakers or height speakers need to be installed.

<sup>\*7</sup> Center speaker, surround speakers or height speakers need to be installed.

Input Format	Listening Mode
Dolby TrueHD	Direct
	Mono
	Dolby TrueHD <sup>*1 *2</sup>
	Dolby Surround
	Neo:6 Cinema <sup>*3</sup>
	DTS Neural:X
	THX Cinema <sup>*4</sup>
	THX S2 Cinema <sup>*5</sup>
	THX Surr EX <sup>*5</sup>
	TV Logic <sup>*6</sup>
	AllCh Stereo <sup>*7</sup>
	Full Mono <sup>*7</sup>
T-D	

<sup>\*1</sup> Cannot be selected when the input format is monaural or 2 ch.

<sup>\*2</sup> Center speaker or surround speakers need to be installed.

<sup>\*3</sup> Can only be selected when the input format is 2 ch and a center speaker or surround speakers are installed.

<sup>\*4</sup> Surround speakers need to be installed.

<sup>\*5</sup> Back speakers need to be installed. Can be selected when the input format is 5.1 ch.

<sup>\*6</sup> Surround speakers or height speakers need to be installed.

<sup>\*7</sup> Center speaker, surround speakers or height speakers need to be installed.

Input Format	Listening Mode
DTS	Direct
	Mono
	DTS <sup>*1 *2</sup>
	Dolby Surround
	Neo:6 Cinema <sup>*3</sup>
	DTS Neural:X
	THX Cinema <sup>*4</sup>
	THX S2 Cinema <sup>*5</sup>
	THX Surr EX <sup>*5</sup>
	TV Logic <sup>*6</sup>
AllCh Stereo <sup>*7</sup>	
Full Mono <sup>*7</sup>	
T-D	

<sup>\*1</sup> Cannot be selected when the input format is monaural or 2 ch.

<sup>\*2</sup> Center speaker or surround speakers need to be installed.

<sup>\*3</sup> Can only be selected when the input format is 2 ch and a center speaker or surround speakers are installed.

<sup>\*4</sup> Surround speakers need to be installed.

<sup>\*5</sup> Back speakers need to be installed. Can be selected when the input format is 5.1 ch.

<sup>\*6</sup> Surround speakers or height speakers need to be installed.

<sup>\*7</sup> Center speaker, surround speakers or height speakers need to be installed.



Using the Listening Modes

Input Format	Listening Mode
DTS 96/24	Direct
	Mono
	DTS 96/24* <sup>1</sup> * <sup>2</sup>
	Dolby Surround
	Neo:6 Cinema* <sup>3</sup>
	DTS Neural:X
	THX Cinema* <sup>4</sup>
	THX S2 Cinema* <sup>5</sup>
	THX Surr EX* <sup>5</sup>
	TV Logic* <sup>6</sup>
	AllCh Stereo* <sup>7</sup>
	Full Mono* <sup>7</sup>
T-D	

\*<sup>1</sup> Cannot be selected when the input format is monaural or 2 ch.

\*<sup>2</sup> Center speaker or surround speakers need to be installed.

\*<sup>3</sup> Can only be selected when the input format is 2 ch and a center speaker or surround speakers are installed.

\*<sup>4</sup> Surround speakers need to be installed.

\*<sup>5</sup> Back speakers need to be installed. Can be selected when the input format is 5.1 ch.

\*<sup>6</sup> Surround speakers or height speakers need to be installed.

\*<sup>7</sup> Center speaker, surround speakers or height speakers need to be installed.

Input Format	Listening Mode
DTS Express	Direct
	Mono
	DTS Express* <sup>1</sup> * <sup>2</sup>
	Dolby Surround
	Neo:6 Cinema* <sup>3</sup>
	DTS Neural:X
	THX Cinema* <sup>4</sup>
	THX S2 Cinema* <sup>5</sup>
	THX Surr EX* <sup>5</sup>
	TV Logic* <sup>6</sup>
	AllCh Stereo* <sup>7</sup>
	Full Mono* <sup>7</sup>
T-D	

\*<sup>1</sup> Cannot be selected when the input format is monaural or 2 ch.

\*<sup>2</sup> Center speaker or surround speakers need to be installed.

\*<sup>3</sup> Can only be selected when the input format is 2 ch and a center speaker or surround speakers are installed.

\*<sup>4</sup> Surround speakers need to be installed.

\*<sup>5</sup> Back speakers need to be installed. Can be selected when the input format is 5.1 ch.

\*<sup>6</sup> Surround speakers or height speakers need to be installed.

\*<sup>7</sup> Center speaker, surround speakers or height speakers need to be installed.

Input Format	Listening Mode
DTS-HD HR	Direct
	Mono
	DTS-HD HR* <sup>1</sup> * <sup>2</sup>
	Dolby Surround
	Neo:6 Cinema* <sup>3</sup>
	DTS Neural:X
	THX Cinema* <sup>4</sup>
	THX S2 Cinema* <sup>5</sup>
	THX Surr EX* <sup>5</sup>
	TV Logic* <sup>6</sup>
AllCh Stereo* <sup>7</sup>	
Full Mono* <sup>7</sup>	
T-D	

\*<sup>1</sup> Cannot be selected when the input format is monaural or 2 ch.

\*<sup>2</sup> Center speaker or surround speakers need to be installed.

\*<sup>3</sup> Can only be selected when the input format is 2 ch and a center speaker or surround speakers are installed.

\*<sup>4</sup> Surround speakers need to be installed.

\*<sup>5</sup> Back speakers need to be installed. Can be selected when the input format is 5.1 ch.

\*<sup>6</sup> Surround speakers or height speakers need to be installed.

\*<sup>7</sup> Center speaker, surround speakers or height speakers need to be installed.



Using the Listening Modes

Input Format	Listening Mode
DTS-HD MSTR	Direct
	Mono
	DTS-HD MSTR*1 *2
	Dolby Surround
	Neo:6 Cinema*3
	DTS Neural:X
	THX Cinema*4
	THX S2 Cinema*5
	THX Surr EX*5
	TV Logic*6
	AllCh Stereo*7
	Full Mono*7
	T-D

\*1 Cannot be selected when the input format is monaural or 2 ch.

\*2 Center speaker or surround speakers need to be installed.

\*3 Can only be selected when the input format is 2 ch and a center speaker or surround speakers are installed.

\*4 Surround speakers need to be installed.

\*5 Back speakers need to be installed. Can be selected when the input format is 5.1 ch.

\*6 Surround speakers or height speakers need to be installed.

\*7 Center speaker, surround speakers or height speakers need to be installed.

Input Format	Listening Mode
DTS-ES	Direct
	Mono
	DTS*1
	ES Matrix*2
	ES Discrete*2
	Dolby Surround*3
	DTS Neural:X
	THX Cinema*4
	TV Logic*5
	AllCh Stereo*6
	Full Mono*6
	T-D

\*1 Can only be selected when the back speakers are not installed.

\*2 Back speakers need to be installed.

\*3 Height speakers need to be installed.

\*4 Surround speakers need to be installed.

\*5 Surround speakers or height speakers need to be installed.

\*6 Center speaker, surround speakers or height speakers need to be installed.

Input Format	Listening Mode
DTS:X	Direct
	Mono
	DTS:X
	TV Logic*1
	AllCh Stereo*2
	Full Mono*2
	T-D

\*1 Surround speakers or height speakers need to be installed.

\*2 Center speaker, surround speakers or height speakers need to be installed.

■ MUSIC button

You can select a mode suitable for music.

Input Format	Listening Mode
Analog	Pure Audio
	Direct
	Stereo
	Dolby Surround
	Neo:6 Music*1
	DTS Neural:X
	THX Music*2
	Orchestra*3
	Unplugged*3
	Studio-Mix*3
	AllCh Stereo*4
Full Mono*4	

\*1 Center speaker or surround speakers need to be installed.

\*2 Surround speakers need to be installed.

\*3 Surround speakers or height speakers need to be installed.

\*4 Center speaker, surround speakers or height speakers need to be installed.

Input Format	Listening Mode
PCM	Pure Audio
	Direct
	Stereo
	Dolby Surround
	Neo:6 Music*1
	DTS Neural:X
	THX Music*2
	Orchestra*3
	Unplugged*3
	Studio-Mix*3
	AllCh Stereo*4
Full Mono*4	

\*1 Center speaker or surround speakers need to be installed.

\*2 Surround speakers need to be installed.

\*3 Surround speakers or height speakers need to be installed.

\*4 Center speaker, surround speakers or height speakers need to be installed.



Using the Listening Modes

Input Format	Listening Mode
Multich PCM	Pure Audio
	Direct
	Stereo
	Multich* <sup>1</sup>
	Dolby Surround
	DTS Neural:X
	THX Music* <sup>2</sup>
	THX S2 Music* <sup>3</sup>
	Orchestra* <sup>4</sup>
	Unplugged* <sup>4</sup>
	Studio-Mix* <sup>4</sup>
	AllCh Stereo* <sup>5</sup>
Full Mono* <sup>5</sup>	

\*<sup>1</sup> Center speaker or surround speakers need to be installed.

\*<sup>2</sup> Surround speakers need to be installed.

\*<sup>3</sup> Back speakers need to be installed. Can be selected when the input format is 5.1 ch.

\*<sup>4</sup> Surround speakers or height speakers need to be installed.

\*<sup>5</sup> Center speaker, surround speakers or height speakers need to be installed.

Input Format	Listening Mode
DSD	Pure Audio
	Direct
	Stereo
	DSD* <sup>1</sup> * <sup>2</sup>
	Dolby Surround
	Neo:6 Music* <sup>3</sup>
	DTS Neural:X
	THX Music* <sup>4</sup>
	THX S2 Music* <sup>5</sup>
	Orchestra* <sup>6</sup>
	Unplugged* <sup>6</sup>
	Studio-Mix* <sup>6</sup>
AllCh Stereo* <sup>7</sup>	
Full Mono* <sup>7</sup>	

\*<sup>1</sup> Cannot be selected when the input format is monaural or 2 ch.

\*<sup>2</sup> Center speaker or surround speakers need to be installed.

\*<sup>3</sup> Can only be selected when the input format is 2 ch and a center speaker or surround speakers are installed.

\*<sup>4</sup> Surround speakers need to be installed.

\*<sup>5</sup> Back speakers need to be installed. Can be selected when the input format is 5.1 ch.

\*<sup>6</sup> Surround speakers or height speakers need to be installed.

\*<sup>7</sup> Center speaker, surround speakers or height speakers need to be installed.

Input Format	Listening Mode
Dolby Atmos <ul style="list-style-type: none"> <li>The listening mode of Dolby Digital Plus or Dolby TrueHD can be selected if back speakers or height speakers are not connected.</li> </ul>	Pure Audio
	Direct
	Stereo
	Dolby Atmos
	Orchestra
	Unplugged
	Studio-Mix
	AllCh Stereo
	Full Mono

Input Format	Listening Mode
Dolby D	Pure Audio
	Direct
	Stereo
	Dolby D* <sup>1</sup> * <sup>2</sup>
	Dolby Surround
	Neo:6 Music* <sup>3</sup>
	DTS Neural:X
	THX Music* <sup>4</sup>
	THX S2 Music* <sup>5</sup>
	Orchestra* <sup>6</sup>
Unplugged* <sup>6</sup>	
Studio-Mix* <sup>6</sup>	
AllCh Stereo* <sup>7</sup>	
Full Mono* <sup>7</sup>	

\*<sup>1</sup> Cannot be selected when the input format is monaural or 2 ch.

\*<sup>2</sup> Center speaker or surround speakers need to be installed.

\*<sup>3</sup> Can only be selected when the input format is 2 ch and a center speaker or surround speakers are installed.

\*<sup>4</sup> Surround speakers need to be installed.

\*<sup>5</sup> Back speakers need to be installed. Can be selected when the input format is 5.1 ch.

\*<sup>6</sup> Surround speakers or height speakers need to be installed.

\*<sup>7</sup> Center speaker, surround speakers or height speakers need to be installed.



Using the Listening Modes

Input Format	Listening Mode
Dolby D+	Pure Audio
	Direct
	Stereo
	Dolby D+*1 *2
	Dolby Surround
	Neo:6 Music*3
	DTS Neural:X
	THX Music*4
	THX S2 Music*5
	Orchestra*6
	Unplugged*6
	Studio-Mix*6
	AllCh Stereo*7
Full Mono*7	

\*1 Cannot be selected when the input format is monaural or 2 ch.  
 \*2 Center speaker or surround speakers need to be installed.  
 \*3 Can only be selected when the input format is 2 ch and a center speaker or surround speakers are installed.  
 \*4 Surround speakers need to be installed.  
 \*5 Back speakers need to be installed. Can be selected when the input format is 5.1 ch.  
 \*6 Surround speakers or height speakers need to be installed.  
 \*7 Center speaker, surround speakers or height speakers need to be installed.

Input Format	Listening Mode
Dolby TrueHD	Pure Audio
	Direct
	Stereo
	Dolby TrueHD*1 *2
	Dolby Surround
	Neo:6 Music*3
	DTS Neural:X
	THX Music*4
	THX S2 Music*5
	Orchestra*6
	Unplugged*6
	Studio-Mix*6
	AllCh Stereo*7
Full Mono*7	

\*1 Cannot be selected when the input format is monaural or 2 ch.  
 \*2 Center speaker or surround speakers need to be installed.  
 \*3 Can only be selected when the input format is 2 ch and a center speaker or surround speakers are installed.  
 \*4 Surround speakers need to be installed.  
 \*5 Back speakers need to be installed. Can be selected when the input format is 5.1 ch.  
 \*6 Surround speakers or height speakers need to be installed.  
 \*7 Center speaker, surround speakers or height speakers need to be installed.

Input Format	Listening Mode
DTS	Pure Audio
	Direct
	Stereo
	DTS*1 *2
	Dolby Surround
	Neo:6 Music*3
	DTS Neural:X
	THX Music*4
	THX S2 Music*5
	Orchestra*6
	Unplugged*6
	Studio-Mix*6
	AllCh Stereo*7
Full Mono*7	

\*1 Cannot be selected when the input format is monaural or 2 ch.  
 \*2 Center speaker or surround speakers need to be installed.  
 \*3 Can only be selected when the input format is 2 ch and a center speaker or surround speakers are installed.  
 \*4 Surround speakers need to be installed.  
 \*5 Back speakers need to be installed. Can be selected when the input format is 5.1 ch.  
 \*6 Surround speakers or height speakers need to be installed.  
 \*7 Center speaker, surround speakers or height speakers need to be installed.



Using the Listening Modes

Input Format	Listening Mode
DTS 96/24	Pure Audio
	Direct
	Stereo
	DTS 96/24*1 *2
	Dolby Surround
	Neo:6 Music*3
	DTS Neural:X
	THX Music*4
	THX S2 Music*5
	Orchestra*6
	Unplugged*6
	Studio-Mix*6
	AllCh Stereo*7
Full Mono*7	

\*1 Cannot be selected when the input format is monaural or 2 ch.

\*2 Center speaker or surround speakers need to be installed.

\*3 Can only be selected when the input format is 2 ch and a center speaker or surround speakers are installed.

\*4 Surround speakers need to be installed.

\*5 Back speakers need to be installed. Can be selected when the input format is 5.1 ch.

\*6 Surround speakers or height speakers need to be installed.

\*7 Center speaker, surround speakers or height speakers need to be installed.

Input Format	Listening Mode
DTS Express	Pure Audio
	Direct
	Stereo
	DTS Express*1 *2
	Dolby Surround
	Neo:6 Music*3
	DTS Neural:X
	THX Music*4
	THX S2 Music*5
	Orchestra*6
	Unplugged*6
	Studio-Mix*6
	AllCh Stereo*7
Full Mono*7	

\*1 Cannot be selected when the input format is monaural or 2 ch.

\*2 Center speaker or surround speakers need to be installed.

\*3 Can only be selected when the input format is 2 ch and a center speaker or surround speakers are installed.

\*4 Surround speakers need to be installed.

\*5 Back speakers need to be installed. Can be selected when the input format is 5.1 ch.

\*6 Surround speakers or height speakers need to be installed.

\*7 Center speaker, surround speakers or height speakers need to be installed.

Input Format	Listening Mode
DTS-HD HR	Pure Audio
	Direct
	Stereo
	DTS-HD HR*1 *2
	Dolby Surround
	Neo:6 Music*3
	DTS Neural:X
	THX Music*4
	THX S2 Music*5
	Orchestra*6
	Unplugged*6
	Studio-Mix*6
	AllCh Stereo*7
Full Mono*7	

\*1 Cannot be selected when the input format is monaural or 2 ch.

\*2 Center speaker or surround speakers need to be installed.

\*3 Can only be selected when the input format is 2 ch and a center speaker or surround speakers are installed.

\*4 Surround speakers need to be installed.

\*5 Back speakers need to be installed. Can be selected when the input format is 5.1 ch.

\*6 Surround speakers or height speakers need to be installed.

\*7 Center speaker, surround speakers or height speakers need to be installed.



Using the Listening Modes

Input Format	Listening Mode
DTS-HD MSTR	Pure Audio
	Direct
	Stereo
	DTS-HD MSTR*1 *2
	Dolby Surround
	Neo:6 Music*3
	DTS Neural:X
	THX Music*4
	THX S2 Music*5
	Orchestra*6
	Unplugged*6
	Studio-Mix*6
	AllCh Stereo*7
Full Mono*7	

\*1 Cannot be selected when the input format is monaural or 2 ch.

\*2 Center speaker or surround speakers need to be installed.

\*3 Can only be selected when the input format is 2 ch and a center speaker or surround speakers are installed.

\*4 Surround speakers need to be installed.

\*5 Back speakers need to be installed. Can be selected when the input format is 5.1 ch.

\*6 Surround speakers or height speakers need to be installed.

\*7 Center speaker, surround speakers or height speakers need to be installed.

Input Format	Listening Mode
DTS-ES	Pure Audio
	Direct
	Stereo
	DTS*1
	ES Matrix*2
	ES Discrete*2
	Dolby Surround*3
	DTS Neural:X
	THX Music*4
	Orchestra*5
	Unplugged*5
	Studio-Mix*5
	AllCh Stereo*6
Full Mono*6	

\*1 Can only be selected when the back speakers are not installed.

\*2 Back speakers need to be installed.

\*3 Height speakers need to be installed.

\*4 Surround speakers need to be installed.

\*5 Surround speakers or height speakers need to be installed.

\*6 Center speaker, surround speakers or height speakers need to be installed.

Input Format	Listening Mode
DTS:X	Pure Audio
	Direct
	Stereo
	DTS:X
	Orchestra*1
	Unplugged*1
	Studio-Mix*1
	AllCh Stereo*2
	Full Mono*2

\*1 Surround speakers or height speakers need to be installed.

\*2 Center speaker, surround speakers or height speakers need to be installed.

■ GAME button

You can select a mode suitable for games.

Input Format	Listening Mode
Analog	Direct
	Dolby Surround
	DTS Neural:X
	THX Games*1
	Game-RPG*2
	Game-Action*2
	Game-Rock*2
	Game-Sports*2
	AllCh Stereo*3
	Full Mono*3
T-D	

\*1 Surround speakers need to be installed.

\*2 Surround speakers or height speakers need to be installed.

\*3 Center speaker, surround speakers or height speakers need to be installed.

Input Format	Listening Mode
PCM	Direct
	Dolby Surround
	DTS Neural:X
	THX Games*1
	Game-RPG*2
	Game-Action*2
	Game-Rock*2
	Game-Sports*2
	AllCh Stereo*3
	Full Mono*3
T-D	

\*1 Surround speakers need to be installed.

\*2 Surround speakers or height speakers need to be installed.

\*3 Center speaker, surround speakers or height speakers need to be installed.





Using the Listening Modes

Input Format	Listening Mode
Multich PCM	Direct
	Multich* <sup>1</sup>
	Dolby Surround
	DTS Neural:X
	THX Games* <sup>2</sup>
	THX S2 Games* <sup>3</sup>
	Game-RPG* <sup>4</sup>
	Game-Action* <sup>4</sup>
	Game-Rock* <sup>4</sup>
	Game-Sports* <sup>4</sup>
	AllCh Stereo* <sup>5</sup>
	Full Mono* <sup>5</sup>
	T-D

\*<sup>1</sup> Center speaker or surround speakers need to be installed.

\*<sup>2</sup> Surround speakers need to be installed.

\*<sup>3</sup> Back speakers need to be installed. Can be selected when the input format is 5.1 ch.

\*<sup>4</sup> Surround speakers or height speakers need to be installed.

\*<sup>5</sup> Center speaker, surround speakers or height speakers need to be installed.

Input Format	Listening Mode
DSD	Direct
	DSD* <sup>1</sup> * <sup>2</sup>
	Dolby Surround
	DTS Neural:X
	THX Games* <sup>3</sup>
	THX S2 Games* <sup>4</sup>
	Game-RPG* <sup>5</sup>
	Game-Action* <sup>5</sup>
	Game-Rock* <sup>5</sup>
	Game-Sports* <sup>5</sup>
	AllCh Stereo* <sup>6</sup>
	Full Mono* <sup>6</sup>
	T-D

\*<sup>1</sup> Cannot be selected when the input format is monaural or 2 ch.

\*<sup>2</sup> Center speaker or surround speakers need to be installed.

\*<sup>3</sup> Surround speakers need to be installed.

\*<sup>4</sup> Back speakers need to be installed. Can be selected when the input format is 5.1 ch.

\*<sup>5</sup> Surround speakers or height speakers need to be installed.

\*<sup>6</sup> Center speaker, surround speakers or height speakers need to be installed.

Input Format	Listening Mode
Dolby D	Direct
	Dolby D* <sup>1</sup> * <sup>2</sup>
	Dolby Surround
	DTS Neural:X
	THX Games* <sup>3</sup>
	THX S2 Games* <sup>4</sup>
	Game-RPG* <sup>5</sup>
	Game-Action* <sup>5</sup>
	Game-Rock* <sup>5</sup>
	Game-Sports* <sup>5</sup>
AllCh Stereo* <sup>6</sup>	
Full Mono* <sup>6</sup>	
T-D	

\*<sup>1</sup> Cannot be selected when the input format is monaural or 2 ch.

\*<sup>2</sup> Center speaker or surround speakers need to be installed.

\*<sup>3</sup> Surround speakers need to be installed.

\*<sup>4</sup> Back speakers need to be installed. Can be selected when the input format is 5.1 ch.

\*<sup>5</sup> Surround speakers or height speakers need to be installed.

\*<sup>6</sup> Center speaker, surround speakers or height speakers need to be installed.

Input Format	Listening Mode
Dolby Atmos	Direct
	Dolby Atmos
	Game-RPG
	Game-Action
	Game-Rock
	Game-Sports
	AllCh Stereo
	Full Mono
	T-D

Dolby Atmos

- The listening mode of Dolby Digital Plus or Dolby TrueHD can be selected if back speakers or height speakers are not connected.



Using the Listening Modes

Input Format	Listening Mode
Dolby D+	Direct
	Dolby D+*1 *2
	Dolby Surround
	DTS Neural:X
	THX Games*3
	THX S2 Games*4
	Game-RPG*5
	Game-Action*5
	Game-Rock*5
	Game-Sports*5
	AllCh Stereo*6
	Full Mono*6
	T-D

\*1 Cannot be selected when the input format is monaural or 2 ch.

\*2 Center speaker or surround speakers need to be installed.

\*3 Surround speakers need to be installed.

\*4 Back speakers need to be installed. Can be selected when the input format is 5.1 ch.

\*5 Surround speakers or height speakers need to be installed.

\*6 Center speaker, surround speakers or height speakers need to be installed.

Input Format	Listening Mode
Dolby TrueHD	Direct
	Dolby TrueHD*1 *2
	Dolby Surround
	DTS Neural:X
	THX Games*3
	THX S2 Games*4
	Game-RPG*5
	Game-Action*5
	Game-Rock*5
	Game-Sports*5
	AllCh Stereo*6
	Full Mono*6
	T-D

\*1 Cannot be selected when the input format is monaural or 2 ch.

\*2 Center speaker or surround speakers need to be installed.

\*3 Surround speakers need to be installed.

\*4 Back speakers need to be installed. Can be selected when the input format is 5.1 ch.

\*5 Surround speakers or height speakers need to be installed.

\*6 Center speaker, surround speakers or height speakers need to be installed.

Input Format	Listening Mode
DTS	Direct
	DTS*1 *2
	Dolby Surround
	DTS Neural:X
	THX Games*3
	THX S2 Games*4
	Game-RPG*5
	Game-Action*5
	Game-Rock*5
	Game-Sports*5
AllCh Stereo*6	
Full Mono*6	
T-D	

\*1 Cannot be selected when the input format is monaural or 2 ch.

\*2 Center speaker or surround speakers need to be installed.

\*3 Surround speakers need to be installed.

\*4 Back speakers need to be installed. Can be selected when the input format is 5.1 ch.

\*5 Surround speakers or height speakers need to be installed.

\*6 Center speaker, surround speakers or height speakers need to be installed.



Using the Listening Modes

Input Format	Listening Mode
DTS 96/24	Direct
	DTS 96/24* <sup>1</sup> * <sup>2</sup>
	Dolby Surround
	DTS Neural:X
	THX Games* <sup>3</sup>
	THX S2 Games* <sup>4</sup>
	Game-RPG* <sup>5</sup>
	Game-Action* <sup>5</sup>
	Game-Rock* <sup>5</sup>
	Game-Sports* <sup>5</sup>
	AllCh Stereo* <sup>6</sup>
	Full Mono* <sup>6</sup>
	T-D

<sup>\*1</sup> Cannot be selected when the input format is monaural or 2 ch.  
<sup>\*2</sup> Center speaker or surround speakers need to be installed.  
<sup>\*3</sup> Surround speakers need to be installed.  
<sup>\*4</sup> Back speakers need to be installed. Can be selected when the input format is 5.1 ch.  
<sup>\*5</sup> Surround speakers or height speakers need to be installed.  
<sup>\*6</sup> Center speaker, surround speakers or height speakers need to be installed.

Input Format	Listening Mode
DTS Express	Direct
	DTS Express* <sup>1</sup> * <sup>2</sup>
	Dolby Surround
	DTS Neural:X
	THX Games* <sup>3</sup>
	THX S2 Games* <sup>4</sup>
	Game-RPG* <sup>5</sup>
	Game-Action* <sup>5</sup>
	Game-Rock* <sup>5</sup>
	Game-Sports* <sup>5</sup>
	AllCh Stereo* <sup>6</sup>
	Full Mono* <sup>6</sup>
	T-D

<sup>\*1</sup> Cannot be selected when the input format is monaural or 2 ch.  
<sup>\*2</sup> Center speaker or surround speakers need to be installed.  
<sup>\*3</sup> Surround speakers need to be installed.  
<sup>\*4</sup> Back speakers need to be installed. Can be selected when the input format is 5.1 ch.  
<sup>\*5</sup> Surround speakers or height speakers need to be installed.  
<sup>\*6</sup> Center speaker, surround speakers or height speakers need to be installed.

Input Format	Listening Mode
DTS-HD HR	Direct
	DTS-HD HR* <sup>1</sup> * <sup>2</sup>
	Dolby Surround
	DTS Neural:X
	THX Games* <sup>3</sup>
	THX S2 Games* <sup>4</sup>
	Game-RPG* <sup>5</sup>
	Game-Action* <sup>5</sup>
	Game-Rock* <sup>5</sup>
	Game-Sports* <sup>5</sup>
AllCh Stereo* <sup>6</sup>	
Full Mono* <sup>6</sup>	
T-D	

<sup>\*1</sup> Cannot be selected when the input format is monaural or 2 ch.  
<sup>\*2</sup> Center speaker or surround speakers need to be installed.  
<sup>\*3</sup> Surround speakers need to be installed.  
<sup>\*4</sup> Back speakers need to be installed. Can be selected when the input format is 5.1 ch.  
<sup>\*5</sup> Surround speakers or height speakers need to be installed.  
<sup>\*6</sup> Center speaker, surround speakers or height speakers need to be installed.



Using the Listening Modes

Input Format	Listening Mode
DTS-HD MSTR	Direct
	DTS-HD MSTR*1 *2
	Dolby Surround
	DTS Neural:X
	THX Games*3
	THX S2 Games*4
	Game-RPG*5
	Game-Action*5
	Game-Rock*5
	Game-Sports*5
	AllCh Stereo*6
	Full Mono*6
	T-D

\*1 Cannot be selected when the input format is monaural or 2 ch.  
 \*2 Center speaker or surround speakers need to be installed.  
 \*3 Surround speakers need to be installed.  
 \*4 Back speakers need to be installed. Can be selected when the input format is 5.1 ch.  
 \*5 Surround speakers or height speakers need to be installed.  
 \*6 Center speaker, surround speakers or height speakers need to be installed.

Input Format	Listening Mode
DTS-ES	Direct
	DTS*1
	ES Matrix*2
	ES Discrete*2
	Dolby Surround*3
	DTS Neural:X
	THX Games*4
	Game-RPG*5
	Game-Action*5
	Game-Rock*5
	Game-Sports*5
	AllCh Stereo*6
	Full Mono*6
T-D	

\*1 Can only be selected when the back speakers are not installed.  
 \*2 Back speakers need to be installed.  
 \*3 Height speakers need to be installed.  
 \*4 Surround speakers need to be installed.  
 \*5 Surround speakers or height speakers need to be installed.  
 \*6 Center speaker, surround speakers or height speakers need to be installed.

Input Format	Listening Mode
DTS:X	Direct
	DTS:X
	Game-RPG*1
	Game-Action*1
	Game-Rock*1
	Game-Sports*1
	AllCh Stereo*2
	Full Mono*2
	T-D

\*1 Surround speakers or height speakers need to be installed.  
 \*2 Center speaker, surround speakers or height speakers need to be installed.



**■ THX button**

You can select a THX listening mode.

Input Format	Listening Mode
All formats other than Dolby Atmos and DTS:X	THX Cinema*1
	THX Music*1
	THX Games*1
	THX S2 Cinema*2
	THX S2 Music*2
	THX S2 Games*2
	THX Surr EX*2

\*1 Surround speakers need to be installed.

\*2 Back speakers need to be installed. Can be selected when the input format is 5.1 ch.

**■ PURE AUDIO button (on the main unit only)**

The display and analog video circuit are turned off to switch the unit to Pure Audio mode which provides purer sound. Selecting this mode lights the PURE AUDIO indicator on the unit. Pressing the button again reselects the previous listening mode.

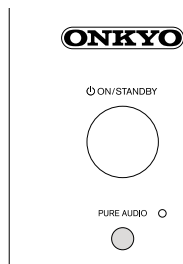

- Selecting Pure Audio for listening mode turns off the display and analog video circuitry, but the video signals input through HDMI input are output from HDMI output.

**■ Pure Analog Playback (on the main unit only)**

If you connect a CD player or such other player to the AUDIO IN jacks of the unit with analog audio (RCA) cable, you can use the "Pure Analog Playback function" that physically shuts down the digital circuits affecting sound reproduction and enables cleaner sound playback. If this function is on, the power of the analog video circuit, HDMI circuit, digital audio circuit, and tuner circuit is cut off and their interference with sound playback is physically prevented.

To use the function, hold down PURE AUDIO on the main unit 5 seconds during playback. When "Pure Analog [Enter] OK" appears on the main unit display, press ENTER on the main unit. To turn off the function, press ON/STANDBY on the main unit.

- When the function is on, you can perform only input selection and volume adjustment. It cannot be operated with Onkyo Remote or any other application that can control the unit.
- It cannot be used when "TUNER", "NET", or "BLUETOOTH" input is selected or the multi-zone function is on.
- The Auto Standby setting becomes off if the function is on.

**Checking the Input Format**

While audio from the player is being input, press DISPLAY on the remote controller several times to switch the information shown on the main unit display. For example, if "Dolby D 5.1" is displayed, the Dolby Digital 5.1 ch signals are being input.

- The number of channels is not displayed when the input signal is "Dolby Atmos" format.

Dolby D 5.1



Advanced Settings (Setup Menu)

## Advanced Settings (Setup Menu)

### How to Set

The unit allows you to configure advanced settings in order to provide even better experience.

● **Operation:** You can set up by viewing the guidance displayed on the TV screen (OSD). Select the item with the cursor buttons of the remote controller and press ENTER to confirm your selection. To return to the previous screen, press RETURN.

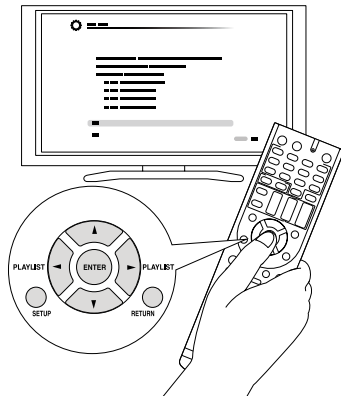

### ■ Operation

1. Press RCV on the remote controller.
  - Always press RCV first to change the remote controller to RECEIVER mode (the mode to operate this unit) since its mode may be changed to operate another component.

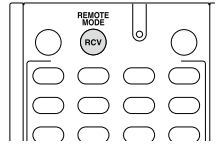

2. Press SETUP to display the Setup menu.

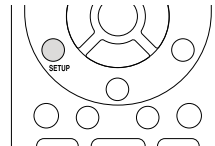

3. Press ▲/▼ to select the desired menu, and then press ENTER.

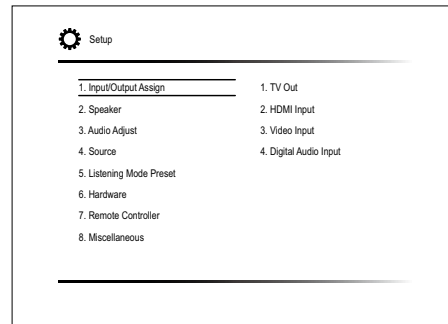

4. Press ▲/▼ to select the item, and then press ENTER.

5. With the ▲/▼/◀/▶ cursors, select the item to configure the settings.

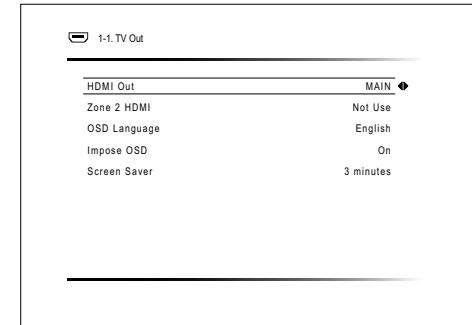

To exit the setup menu, press SETUP.

### Overview of the Setup menu:

#### 1. Input/Output Assign

Make settings to assign the various jacks and for the on-screen display function on the TV when you use the setting menu, for example.

#### 2. Speaker

Make advanced settings for the speakers.

#### 3. Audio Adjust

Make a variety of settings related to sound.

#### 4. Source

Make settings for input sources, such as volume difference adjustments for each input selector for the connected equipment.

#### 5. Listening Mode Preset

You can preset your favorite listening mode.

#### 6. Hardware

Make a variety of settings such as for linked operation with connected HDMI equipment, the standby mode and network connection for this unit.

#### 7. Remote Controller

Make settings related to the remote controller.

#### 8. Miscellaneous

Update the firmware and perform initial settings, etc.



## 1. Input/Output Assign

### TV Out

Select the HDMI jack to be connected with the TV. Make settings for the on-screen display function on the TV when you use the setting menu, for example.

Setting Item	Default Value	Setting Details
HDMI Out	MAIN	Select the HDMI jack to be connected with the TV. "MAIN": When connecting the TV to the HDMI OUT MAIN jack "SUB": When connecting the TV to the HDMI OUT SUB jack "MAIN+SUB": When connecting to both the MAIN and SUB jacks
Zone 2 HDMI	Not Use	Make the setting when you output to the Zone 2 TV connected to the HDMI OUT SUB/ZONE 2 jack. "Use": Enable this function "Not Use": Disable this function
OSD Language	English	Select the on-screen display language. Select from English, German, French, Spanish, Italian, Dutch, Swedish, Russian (European, Australian and Asian models), or Chinese (European, Australian and Asian models).
Impose OSD	On	Set whether or not to display the information on the TV when the volume is adjusted or input is changed, for example. "On": OSD will be displayed on the TV. "Off": OSD will not be displayed on the TV. • The OSD may not be displayed depending on the input signal even if "On" is selected. If the operation screen is not displayed, change the resolution of the connected device.
Screen Saver	3 minutes	Set the time to start the screen saver. Select a value from "3 minutes", "5 minutes", "10 minutes" and "Off".

### HDMI Input

You can change input assignment between the input selectors and HDMI IN jacks.

Setting Item	Default Value	Setting Details
BD/DVD	HDMI 1 (HDCP 2.2)	"HDMI 1 (HDCP 2.2)" to "HDMI 7": Assign a desired HDMI IN jack to the BD/DVD button. If you do not assign a jack, select "-----". To select an HDMI IN jack already assigned to another input selector, change its setting to "-----" first.
CBL/SAT	HDMI 2 (HDCP 2.2)	"HDMI 1 (HDCP 2.2)" to "HDMI 7": Assign a desired HDMI IN jack to the CBL/SAT button. If you do not assign a jack, select "-----". To select an HDMI IN jack already assigned to another input selector, change its setting to "-----" first.
STRM BOX	HDMI 3 (HDCP 2.2)	"HDMI 1 (HDCP 2.2)" to "HDMI 7": Assign a desired HDMI IN jack to the STRM BOX button. If you do not assign a jack, select "-----". To select an HDMI IN jack already assigned to another input selector, change its setting to "-----" first.
PC	HDMI 4 (HDCP 2.2)	"HDMI 1 (HDCP 2.2)" to "HDMI 7": Assign a desired HDMI IN jack to the PC button. If you do not assign a jack, select "-----". To select an HDMI IN jack already assigned to another input selector, change its setting to "-----" first.
GAME 1	HDMI 5 (HDCP 2.2)	"HDMI 1 (HDCP 2.2)" to "HDMI 7": Assign a desired HDMI IN jack to the GAME 1 button. If you do not assign a jack, select "-----". To select an HDMI IN jack already assigned to another input selector, change its setting to "-----" first.
GAME 2	HDMI 6	"HDMI 1 (HDCP 2.2)" to "HDMI 7": Assign a desired HDMI IN jack to the GAME 2 button. If you do not assign a jack, select "-----". To select an HDMI IN jack already assigned to another input selector, change its setting to "-----" first.
AUX	(Front)	The setting cannot be changed.
CD	-----	"HDMI 1 (HDCP 2.2)" to "HDMI 7": Assign a desired HDMI IN jack to the CD button. If you do not assign a jack, select "-----". To select an HDMI IN jack already assigned to another input selector, change its setting to "-----" first.



Setting Item	Default Value	Setting Details
PHONO	-----	"HDMI 1 (HDCP 2.2)" to "HDMI 7": Assign a desired HDMI IN jack to the PHONO button. If you do not assign a jack, select "-----". To select an HDMI IN jack already assigned to another input selector, change its setting to "-----" first.
TV	-----	"HDMI 1 (HDCP 2.2)" to "HDMI 7": Assign a desired HDMI IN jack to the TV button. If you do not assign a jack, select "-----". To select an HDMI IN jack already assigned to another input selector, change its setting to "-----" first.

### Video Input

You can change assignment of the COMPONENT VIDEO IN 1 and 2 jacks and the VIDEO IN 1 to 3 jacks between the input selectors. If you do not assign a jack, select "-----".

Setting Item	Default Value	Setting Details
BD/DVD	COMPONENT 1	"COMPONENT 1", "COMPONENT 2": Assign the COMPONENT VIDEO IN jacks to the BD/DVD button. "VIDEO 1" to "VIDEO 3": Assign a desired VIDEO IN jack to the BD/DVD button.
CBL/SAT	VIDEO 2	"COMPONENT 1", "COMPONENT 2": Assign the COMPONENT VIDEO IN jacks to the CBL/SAT button. "VIDEO 1" to "VIDEO 3": Assign a desired VIDEO IN jack to the CBL/SAT button.
STRM BOX	VIDEO 3	"COMPONENT 1", "COMPONENT 2": Assign the COMPONENT VIDEO IN jacks to the STRM BOX button. "VIDEO 1" to "VIDEO 3": Assign a desired VIDEO IN jack to the STRM BOX button.
PC	-----	"COMPONENT 1", "COMPONENT 2": Assign the COMPONENT VIDEO IN jacks to the PC button. "VIDEO 1" to "VIDEO 3": Assign a desired VIDEO IN jack to the PC button.
GAME 1	VIDEO 1	"COMPONENT 1", "COMPONENT 2": Assign the COMPONENT VIDEO IN jacks to the GAME 1 button. "VIDEO 1" to "VIDEO 3": Assign a desired VIDEO IN jack to the GAME 1 button.
GAME 2	COMPONENT 2	"COMPONENT 1", "COMPONENT 2": Assign the COMPONENT VIDEO IN jacks to the GAME 2 button. "VIDEO 1" to "VIDEO 3": Assign a desired VIDEO IN jack to the GAME 2 button.
AUX	-----	The setting cannot be changed.
CD	-----	"COMPONENT 1", "COMPONENT 2": Assign the COMPONENT VIDEO IN jacks to the CD button. "VIDEO 1" to "VIDEO 3": Assign a desired VIDEO IN jack to the CD button.





## Advanced Settings (Setup Menu)

Setting Item	Default Value	Setting Details
PHONO	----	"COMPONENT 1", "COMPONENT 2": Assign the COMPONENT VIDEO IN jacks to the PHONO button. "VIDEO 1" to "VIDEO 3": Assign a desired VIDEO IN jack to the PHONO button.
TV	----	"COMPONENT 1", "COMPONENT 2": Assign the COMPONENT VIDEO IN jacks to the TV button. "VIDEO 1" to "VIDEO 3": Assign a desired VIDEO IN jack to the TV button.

- When you convert video signals input to the COMPONENT VIDEO IN jacks and output them from the HDMI OUT jack, set the output resolution of the player to 480i or 576i. If the input has 480p/576p or higher resolution, an error message will appear.

**Digital Audio Input**

You can change input assignment between the input selectors and DIGITAL IN COAXIAL 1 to 2/OPTICAL 1 to 3 jacks. If you do not assign a jack, select "-----".

Setting Item	Default Value	Setting Details
BD/DVD	COAXIAL 1	"COAXIAL 1", "COAXIAL 2", "OPTICAL 1", "OPTICAL 2", "OPTICAL 3": Assign a desired DIGITAL IN jack to the BD/DVD button.
CBL/SAT	COAXIAL 2	"COAXIAL 1", "COAXIAL 2", "OPTICAL 1", "OPTICAL 2", "OPTICAL 3": Assign a desired DIGITAL IN jack to the CBL/SAT button.
STRM BOX	OPTICAL 1	"COAXIAL 1", "COAXIAL 2", "OPTICAL 1", "OPTICAL 2", "OPTICAL 3": Assign a desired DIGITAL IN jack to the STRM BOX button.
PC	----	"COAXIAL 1", "COAXIAL 2", "OPTICAL 1", "OPTICAL 2", "OPTICAL 3": Assign a desired DIGITAL IN jack to the PC button.
GAME 1	----	"COAXIAL 1", "COAXIAL 2", "OPTICAL 1", "OPTICAL 2", "OPTICAL 3": Assign a desired DIGITAL IN jack to the GAME 1 button.
GAME 2	----	"COAXIAL 1", "COAXIAL 2", "OPTICAL 1", "OPTICAL 2", "OPTICAL 3": Assign a desired DIGITAL IN jack to the GAME 2 button.
AUX	----	The setting cannot be changed.
CD	OPTICAL 2	"COAXIAL 1", "COAXIAL 2", "OPTICAL 1", "OPTICAL 2", "OPTICAL 3": Assign a desired DIGITAL IN jack to the CD button.
PHONO	----	"COAXIAL 1", "COAXIAL 2", "OPTICAL 1", "OPTICAL 2", "OPTICAL 3": Assign a desired DIGITAL IN jack to the PHONO button.
TV	OPTICAL 3	"COAXIAL 1", "COAXIAL 2", "OPTICAL 1", "OPTICAL 2", "OPTICAL 3": Assign a desired DIGITAL IN jack to the TV button.

- Sampling rates for PCM signals (stereo, mono) from a digital input are 32 kHz, 44.1 kHz, 48 kHz, 88.2 kHz, 96 kHz/16 bit, 20 bit, and 24 bit.



Advanced Settings (Setup Menu)

## 2. Speaker

Allows you to change the speaker configuration such as presence or not of subwoofer, crossover frequency, and so on. Settings are automatically configured if you use the Automatic Speaker Setup. This setting cannot be selected if headphones are connected or audio is output from the speakers of the TV.

### Configuration

You can change the number of speaker channels connected, the type of front speaker connection, the height speaker type, and other speaker settings.

Setting Item	Default Value	Setting Details
Speaker Channels	7.1 ch	Select "2.1 ch", "3.1 ch", "4.1 ch", "5.1 ch", "6.1 ch", "7.1 ch", "2.1.2 ch", "3.1.2 ch", "4.1.2 ch", "5.1.2 ch", "6.1.2 ch", or "7.1.2 ch" to suit the number of speaker channels connected.
Subwoofer	Yes	Set whether a subwoofer is connected or not. "Yes": When subwoofer is connected "No": When subwoofer is not connected
Height Speaker	Front High	Set the speaker type if height speakers are connected to the HEIGHT terminals. Select "Front High", "Top Front", "Top Middle", "Top Rear", "Rear High", "Dolby Speaker (Front)", "Dolby Speaker (Surr)", or "Dolby Speaker (Back)" according to the connected speaker type and location. <ul style="list-style-type: none"> <li>If an item cannot be selected even though connection is correct, check that the settings in "Speaker Channels" matches the number of connected channels.</li> </ul>
Bi-Amp	No	Set whether your front speaker connection is bi-amp. "No": When front speakers are connected in a normal manner "Yes": When front speakers are bi-amp connected <ul style="list-style-type: none"> <li>If an item cannot be selected even though connection is correct, check that the settings in "Speaker Channels" matches the number of connected channels.</li> </ul>

Setting Item	Default Value	Setting Details
Powered Zone 2	No	Set the connection of speakers to Zone 2 speaker terminals. "Yes": When speakers are connected to ZONE 2 speaker terminals "No": When speakers are not connected to ZONE 2 speaker terminals <ul style="list-style-type: none"> <li>This item will be set to "No" when "Bi-Amp" is set to "Yes".</li> </ul>
Speaker Impedance	6ohms	Set the impedance of the connected speakers. "4ohms": When any of the connected speakers have 4 Ω or more to less than 6 Ω impedance "6ohms": When the connected speakers all have 6 Ω or more impedance <ul style="list-style-type: none"> <li>For impedance, check the indications on the back of the speakers or their instruction manual.</li> </ul>



## Advanced Settings (Setup Menu)

**Crossover**

Allows you to change speaker configurations, such as crossover frequency. Settings are automatically configured if you use the Automatic Speaker Setup. Audio will not be output while you are making this setting.

- If you are using THX-certified speakers, we recommend the following settings:
  - Set a value "80Hz(THX)" in Crossover frequency.
  - Set a value "80Hz" in "LPF of LFE".
  - Set a value "Off" in "Double Bass".

Setting Item	Default Value	Setting Details
Front	80 Hz(THX)	Select the crossover frequency from "40Hz" to "200Hz" to start outputting frequencies for each channel. "Full Band": Full band will be output. <ul style="list-style-type: none"> <li>• If "Configuration" - "Subwoofer" is set to "No", "Front" will be fixed to "Full Band" and the low pitched range of the other channels will be output from the front speakers. Refer to the instruction manual of your speakers to make the setting.</li> </ul>
Center	80 Hz(THX)	Select the crossover frequency from "40Hz" to "200Hz" to start outputting frequencies for each channel. "Full Band": Full band will be output. <ul style="list-style-type: none"> <li>• "Full Band" can be selected only when "Front" is set to "Full Band".</li> <li>• If an item cannot be selected even though connection is correct, check that the settings in "Configuration" - "Speaker Channels" matches the number of connected channels.</li> </ul>
Height	80 Hz(THX)	Select the crossover frequency from "40Hz" to "200Hz" to start outputting frequencies for each channel. "Full Band": Full band will be output. <ul style="list-style-type: none"> <li>• This cannot be selected when the setting for "Configuration" - "Bi-Amp" is "Yes".</li> <li>• "Full Band" can be selected only when "Front" is set to "Full Band".</li> <li>• If an item cannot be selected even though connection is correct, check that the settings in "Configuration" - "Speaker Channels" matches the number of connected channels.</li> </ul>

Setting Item	Default Value	Setting Details
Surround	80 Hz(THX)	Select the crossover frequency from "40Hz" to "200Hz" to start outputting frequencies for each channel. "Full Band": Full band will be output. <ul style="list-style-type: none"> <li>• "Full Band" can be selected only when "Front" is set to "Full Band".</li> <li>• If an item cannot be selected even though connection is correct, check that the settings in "Configuration" - "Speaker Channels" matches the number of connected channels.</li> </ul>
Back	80 Hz(THX)	Select the crossover frequency from "40Hz" to "200Hz" to start outputting frequencies for each channel. "Full Band": Full band will be output. <ul style="list-style-type: none"> <li>• This cannot be selected when the setting for "Configuration" - "Bi-Amp" is "Yes".</li> <li>• "Full Band" can be selected only when "Surround" is set to "Full Band".</li> <li>• If an item cannot be selected even though connection is correct, check that the settings in "Configuration" - "Speaker Channels" matches the number of connected channels.</li> </ul>
LPF of LFE	120Hz	Set the low-pass filter for LFE (low-frequency effect) signals in order to pass lower frequency signals than the set value and thus cancel unwanted noises. The low-pass filter will be effective only on sources with LFE channel. The value from "80Hz" to "120Hz" can be set. "Off": Do not use this function
Subwoofer Phase	0°	Bass sound of the subwoofers may be insufficient depending on the type of sound and the listening position. In that case, change the phase of subwoofers. Set the phase value while listening to the sound so that you can obtain your preferred bass sound. "0°": The subwoofer is in normal phase. "180°": The subwoofer is in reverse phase. <ul style="list-style-type: none"> <li>• The setting cannot be changed if "Configuration" - "Subwoofer" is set to "No".</li> </ul>



Advanced Settings (Setup Menu)

Setting Item	Default Value	Setting Details
Double Bass	On	<p>This can only be selected when "Configuration" - "Subwoofer" is set to "Yes" and "Front" is set to "Full Band".</p> <p>Boost bass output by feeding bass sounds from the front left and right, and center speakers to the subwoofer.</p> <p>"On": Bass output will be boosted.                      "Off": Bass output will not be boosted.</p> <ul style="list-style-type: none"> <li>• The setting will not automatically be configured even if you performed the automatic speaker setup.</li> </ul>

**Distance**

Set the distance from each speaker to the listening position. Settings are automatically configured if you use the automatic speaker setup.

Setting Item	Default Value	Setting Details
Unit	feet/meters	<p>Specify the unit of distance for configuring settings.</p> <p>"feet": When setting in feet (0.1 ft to 30.0 ft, in increments of 0.1 ft)                      "meters": When setting in meters (0.03 m to 9.00 m, in increments of 0.03 m)</p>
Front Left	12.0ft/3.60m	Specify the distance between each speaker and the listening position.
Center	12.0ft/3.60m	Specify the distance between each speaker and the listening position.
Front Right	12.0ft/3.60m	Specify the distance between each speaker and the listening position.
Height Left	9.0ft/2.70m	<p>Specify the distance between each speaker and the listening position.</p> <ul style="list-style-type: none"> <li>• This setting cannot be changed if "Configuration" - "Powered Zone 2" is set to "Yes" and Zone2 is set to on.</li> </ul>
Height Right	9.0ft/2.70m	<p>Specify the distance between each speaker and the listening position.</p> <ul style="list-style-type: none"> <li>• This setting cannot be changed if "Configuration" - "Powered Zone 2" is set to "Yes" and Zone2 is set to on.</li> </ul>
Surround Right	7.0ft/2.10m	Specify the distance between each speaker and the listening position.
Back Right	7.0ft/2.10m	<p>Specify the distance between each speaker and the listening position.</p> <ul style="list-style-type: none"> <li>• This setting cannot be changed if "Configuration" - "Powered Zone 2" is set to "Yes" and Zone2 is set to on.</li> </ul>
Back Left	7.0ft/2.10m	<p>Specify the distance between each speaker and the listening position.</p> <ul style="list-style-type: none"> <li>• This setting cannot be changed if "Configuration" - "Powered Zone 2" is set to "Yes" and Zone2 is set to on.</li> </ul>
Surround Left	7.0ft/2.10m	Specify the distance between each speaker and the listening position.
Subwoofer	12.0ft/3.60m	Specify the distance between each speaker and the listening position.



## Advanced Settings (Setup Menu)

- Default values vary depending on the regions.
- The speaker "Distance" may be unable to be changed depending on the settings in "Configuration" - "Speaker Channels" / "Subwoofer".

**Level Calibration**

Adjust the level of each speaker with the built-in test tone. Settings are automatically configured if you use the Automatic Speaker Setup.

Setting Item	Default Value	Setting Details
Front Left	0.0dB	Select a value between "-12.0 dB" and "+12.0 dB" (in 0.5 dB increments). A test tone will be output each time you change the value. Select the desired level.
Center	0.0dB	Select a value between "-12.0 dB" and "+12.0 dB" (in 0.5 dB increments). A test tone will be output each time you change the value. Select the desired level.
Front Right	0.0dB	Select a value between "-12.0 dB" and "+12.0 dB" (in 0.5 dB increments). A test tone will be output each time you change the value. Select the desired level.
Height Left	0.0dB	Select a value between "-12.0 dB" and "+12.0 dB" (in 0.5 dB increments). A test tone will be output each time you change the value. Select the desired level. <ul style="list-style-type: none"> <li>• This cannot be selected in the following conditions. <ul style="list-style-type: none"> <li>– The setting for "Configuration" - "Bi-Amp" is "Yes"</li> <li>– "Configuration" - "Powered Zone 2" is set to "Yes" and ZONE 2 is on</li> </ul> </li> </ul>
Height Right	0.0dB	Select a value between "-12.0 dB" and "+12.0 dB" (in 0.5 dB increments). A test tone will be output each time you change the value. Select the desired level. <ul style="list-style-type: none"> <li>• This cannot be selected in the following conditions. <ul style="list-style-type: none"> <li>– The setting for "Configuration" - "Bi-Amp" is "Yes"</li> <li>– "Configuration" - "Powered Zone 2" is set to "Yes" and ZONE 2 is on</li> </ul> </li> </ul>

Setting Item	Default Value	Setting Details
Surround Right	0.0dB	Select a value between "-12.0 dB" and "+12.0 dB" (in 0.5 dB increments). A test tone will be output each time you change the value. Select the desired level.
Back Right	0.0dB	Select a value between "-12.0 dB" and "+12.0 dB" (in 0.5 dB increments). A test tone will be output each time you change the value. Select the desired level. <ul style="list-style-type: none"> <li>• This cannot be selected in the following conditions. <ul style="list-style-type: none"> <li>– The setting for "Configuration" - "Bi-Amp" is "Yes"</li> <li>– "Configuration" - "Powered Zone 2" is set to "Yes" and ZONE 2 is on</li> </ul> </li> </ul>
Back Left	0.0dB	Select a value between "-12.0 dB" and "+12.0 dB" (in 0.5 dB increments). A test tone will be output each time you change the value. Select the desired level. <ul style="list-style-type: none"> <li>• This cannot be selected in the following conditions. <ul style="list-style-type: none"> <li>– The setting for "Configuration" - "Bi-Amp" is "Yes"</li> <li>– "Configuration" - "Powered Zone 2" is set to "Yes" and ZONE 2 is on</li> </ul> </li> </ul>
Surround Left	0.0dB	Select a value between "-12.0 dB" and "+12.0 dB" (in 0.5 dB increments). A test tone will be output each time you change the value. Select the desired level.
Subwoofer	0.0dB	Select a value between "-15.0 dB" and "+12.0 dB" (in 0.5 dB increments). A test tone will be output each time you change the value. Select the desired level.

- The speaker "Level Calibration" may be unable to be changed depending on the settings in "Configuration" - "Speaker Channels" / "Subwoofer".
- "Level Calibration" cannot be changed while muting is on.



Advanced Settings (Setup Menu)

**Equalizer Settings**

Adjust the output volume of each range of each connected speaker. You can adjust the volume of each range of each speaker. You can set three types of equalizer settings in the Presets 1, 2, and 3.

- You can adjust the bass in the low range frequencies (63 Hz, etc.), and the treble in the high range frequencies (16 kHz, etc.).
- You can select up to seven frequency bands for each speaker.

Setting Item	Default Value	Setting Details
Front	0 dB	First select the frequency of the speaker from "25 Hz" to "16 kHz" with the ◀▶ cursors, then use ▲/▼ to adjust the volume of the frequency between "-6dB" to "+6dB".
Center	0 dB	First select the frequency of the speaker from "25 Hz" to "16 kHz" with the ◀▶ cursors, then use ▲/▼ to adjust the volume of the frequency between "-6dB" to "+6dB".
Height	0 dB	First select the frequency of the speaker from "25 Hz" to "16 kHz" with the ◀▶ cursors, then use ▲/▼ to adjust the volume of the frequency between "-6dB" to "+6dB". <ul style="list-style-type: none"> <li>• This cannot be selected in the following conditions.                             <ul style="list-style-type: none"> <li>- The setting for "Configuration" - "Bi-Amp" is "Yes"</li> <li>- "Configuration" - "Powered Zone 2" is set to "Yes" and ZONE 2 is on</li> </ul> </li> </ul>
Surround	0 dB	First select the frequency of the speaker from "25 Hz" to "16 kHz" with the ◀▶ cursors, then use ▲/▼ to adjust the volume of the frequency between "-6dB" to "+6dB".
Back	0 dB	First select the frequency of the speaker from "25 Hz" to "16 kHz" with the ◀▶ cursors, then use ▲/▼ to adjust the volume of the frequency between "-6dB" to "+6dB". <ul style="list-style-type: none"> <li>• This cannot be selected in the following conditions.                             <ul style="list-style-type: none"> <li>- The setting for "Configuration" - "Bi-Amp" is "Yes"</li> <li>- "Configuration" - "Powered Zone 2" is set to "Yes" and ZONE 2 is on</li> </ul> </li> </ul>

Setting Item	Default Value	Setting Details
Subwoofer	0 dB	First select the frequency of the speaker from "25 Hz" to "160Hz" with the ◀▶ cursors, then use ▲/▼ to adjust the volume of the frequency between "-6dB" to "+6dB". <ul style="list-style-type: none"> <li>• This cannot be selected if "Configuration" - "Subwoofer" is set to "No".</li> </ul>

- The Speaker "Equalizer Settings" may be unable to be changed depending on the settings in "Configuration" - "Speaker Channels" / "Subwoofer".
- Adjust the volume of each speaker in "Level Calibration".
- Adjust the volume in 1 dB steps.
- This is not effective if the listening mode is Pure Audio or Direct.
- The result may not be as expected depending on the input source and listening mode setting.



Advanced Settings (Setup Menu)

**THX Audio**

Setting item	Default Value	Setting Details
Back Speaker Spacing	>4.0 ft / >1.2 m	<p>Select the distance between the back speakers from the following values.</p> <p>When "Distance" - "Unit" is set to "feet".: Select a value from "&lt;1.0 ft", "1.0-4.0 ft", and "&gt;4.0 ft".</p> <p>When "Distance" - "Unit" is set to "meters".: Select a value from "&lt;0.3 m", "0.3-1.2 m", and "&gt;1.2 m".</p> <ul style="list-style-type: none"> <li>This cannot be selected in the following conditions.                             <ul style="list-style-type: none"> <li>The setting for "Configuration" - "Bi-Amp" is "Yes"</li> <li>"Configuration" - "Powered Zone 2" is set to "Yes" and ZONE 2 is on</li> </ul> </li> <li>If an item cannot be selected even though connection is correct, check that the settings in "Configuration" - "Speaker Channels" matches the number of connected channels.</li> </ul>
THX Ultra2/ Select2 Subwoofer	No	<p>Set "Yes" or "No" of the connection of the THX certified subwoofer.</p> <p>"Yes": When a THX-certified subwoofer is connected</p> <p>"No": When a THX-certified subwoofer is not connected</p> <ul style="list-style-type: none"> <li>The setting cannot be changed if "Configuration" - "Subwoofer" is set to "No".</li> </ul>
BGC	Off	<p>If your listening room layout (for practical or aesthetic reasons) locates most of the listeners close to the rear wall, the resulting bass level can be sufficiently reinforced by the boundary that the overall sound becomes "boomy". THX Select2 Plus receivers contain a Boundary Gain Compensation (BGC) feature to improve bass balance.</p> <p>"On": Use this function</p> <p>"Off": Do not use this function</p> <ul style="list-style-type: none"> <li>In the following cases, the setting cannot be changed:                             <ul style="list-style-type: none"> <li>"Configuration" - "Subwoofer" is set to "No".</li> <li>"THX Ultra2/Select2 Subwoofer" is set to "No".</li> </ul> </li> </ul>

Setting item	Default Value	Setting Details
Loudness Plus	On	<p>When the setting is set to "On", it is possible to enjoy even subtle nuances of audio expression at low volume. This is only available when the THX listening mode is selected.</p> <p><b>THX Loudness Plus</b></p> <p>THX Loudness Plus is a new volume control technology featured in THX Ultra2 Plus™ and THX Select2 Plus™ Certified receivers.</p> <p>With THX Loudness Plus, home theater audiences can now experience the rich details in a surround mix at any volume level.</p> <p>A consequence of turning the volume below Reference Level is that certain sound elements can be lost or perceived differently by the listener. THX Loudness Plus compensates for the tonal and spatial shifts that occur when the volume is reduced by intelligently adjusting ambient surround channel levels and frequency response. This enables users experience the true impact of soundtracks regardless of the volume setting. THX Loudness Plus is automatically applied when listening in any THX listening mode. The new THX Cinema, THX Music, and THX Games modes are tailored to apply the proper THX Loudness Plus settings for each type of content.</p>



### 3. Audio Adjust

Configure various settings related to sound, such as settings for listening to multiplex audio or multilingual TV broadcasts and sound field settings for listening modes.

#### Multiplex/Mono

Setting Item	Default Value	Setting Details
Multiplex Input Channel	Main	Set the audio channel or language to be output when playing multiplex audio or multilingual TV broadcasts etc. "Main": Main channel only "Sub": Sub channel only "Main/Sub": Main and sub channels will be output at the same time. • If multiplex audio is being played, "1+1" will be displayed when DISPLAY is pressed.
Mono Input Channel	Left+Right	Set the input channel to use for playing any 2 ch digital source such as Dolby Digital, or 2-ch analog/PCM source in the Mono listening mode. "Left": Left channel only "Right": Right channel only "Left + Right" : Left and right channels
Mono Output Speaker	Center	Select the speaker to output monaural audio in the Mono listening mode. "Center": Audio is output from the center speaker. "Left/Right": Audio is output from the front L/R speakers. • If an item cannot be selected even though connection is correct, check that the settings in "Configuration" - "Speaker Channels" matches the number of connected channels.

#### Dolby

Make the settings for Dolby listening mode.

Setting Item	Default Value	Setting Details
Loudness Management	On	Enable the Late Night function that allows you to enjoy surround sound of Dolby TrueHD playback even in low volume. "On": Use this function "Off": Do not use this function

#### Theater-Dimensional

Make the settings for Theater-Dimensional listening mode.

Setting Item	Default Value	Setting Details
Listening Angle	Wide	To enhance the effect of Theater-Dimensional, select the actual angle of the left and right front speakers as it appears from the listening position. "Narrow": Less than 30° "Wide": Greater than 30°

- Position the front speakers 20° to the listening position if you have selected "Narrow" in "Listening Angle" and 40° if you have selected "Wide".

#### LFE Level

Set the low-frequency effect (LFE) level of the Dolby Digital, DTS, Multichannel PCM and DSD signals.

Setting item	Default Value	Setting Details
Dolby D/Dolby D+/TrueHD	0dB	Select the low-frequency effect (LFE) level of each type of signal from "0dB" to "-∞dB". If the low-frequency effect sound is too strong, select "-20dB" or "-∞dB".
DTS/DTS-ES/DTS-HD	0dB	Select the low-frequency effect (LFE) level of each type of signal from "0dB" to "-∞dB". If the low-frequency effect sound is too strong, select "-20dB" or "-∞dB". • This setting works on LFE channel volume of DTS, DTS-ES, DTS-HD High Resolution and DTS-HD Master Audio sources.





## Advanced Settings (Setup Menu)

Setting item	Default Value	Setting Details
Other Multich Source	0dB	Select the low-frequency effect (LFE) level of each type of signal from "0dB" to "-∞dB". If the low-frequency effect sound is too strong, select "-20dB" or "-∞dB". <ul style="list-style-type: none"> <li>This setting works on LFE channel volume of Multichannel PCM and DSD sources.</li> </ul>

## Volume

Make the detailed volume setting of the unit.

Setting Item	Default Value	Setting Details
Volume Display	Absolute	Switch the volume display between the absolute value and relative value. The absolute value 82.0 is equivalent to the relative value 0.0dB. "Absolute": Absolute value such as "0.5" to "99.5" "Relative": Relative value such as "-81.5dB" and "+18.0dB" <ul style="list-style-type: none"> <li>If the absolute value is set to "82.0", "82.0Ref" will appear on the display.</li> </ul>
Muting Level	-∞dB	Set the volume lowered from the listening volume when muting is on. Select a value from "-∞dB", "-40dB" to "-20dB".
Maximum Volume	Off	Set the maximum value to avoid too high volume. Select a value from "Off", "50" to "99". (When "Volume Display" is set to "Absolute")
Power On Volume	Last	Set the volume level of when the power is turned on. Select a value from "Last" (Volume level before entering standby mode), "Min", "1" to "99" and "Max". (When "Volume Display" is set to "Absolute") <ul style="list-style-type: none"> <li>You cannot set a higher value than that of "Maximum Volume".</li> </ul>
Headphone Level	0 dB	Adjust the output level of the headphones. Select a value between "-12 dB" and "+12 dB".

## Multi Zone

Setting Item	Default Value	Setting Details
Zone 2 Out	Fixed	Select which of the integrated amplifier in a separate room or this unit should be used to adjust the volume when Zone 2 is active. "Fixed": Adjust on the Integrated amplifier in a separate room "Variable": Adjust on the unit
Zone 2 Maximum Volume	Off	Set the maximum value for Zone 2 to avoid too high volume. Select a value from "Off", "50" to "99". (When "Volume Display" is set to "Absolute")
Zone 2 Power On Volume	Last	Set the Zone 2 volume level of when the unit is turned on. Select a value from "Last" (Volume level when the unit was turned off), "Min", "1" to "99" and "Max". (When "Volume Display" is set to "Absolute") <ul style="list-style-type: none"> <li>You cannot set a higher value than that of "Zone 2 Maximum Volume".</li> </ul>



#### 4. Source

Make settings for input sources, such as volume difference adjustments for each input selector for the connected equipment. Select the input selector to configure.

##### IntelliVolume

Setting Item	Default Value	Setting Details
IntelliVolume	0 dB	Adjust the volume level difference between the devices connected to the unit. Select a value between "-12 dB" and "+12 dB". Set a negative value if the volume of the target device is larger than the others and a positive value if smaller. When you select a desired input to check the audio, start playback of the connected device. <ul style="list-style-type: none"> <li>This function is not effective in Zone 2/Zone 3.</li> </ul>

##### Name Edit

Set an easy name to each input. The set name will be shown on the main unit display. Select the input selector to configure.

Setting Item	Default Value	Setting Details
Name	Input name	<ol style="list-style-type: none"> <li>Select a character or symbol with the cursors and press ENTER. Repeat it to input 10 or less characters. "A/a": Switches between upper and lower cases. (Pressing +10 on the remote controller also toggles between upper and lower cases.) "←" "→": Moves the cursor to the arrow direction. "⌫": Removes a character on the left of the cursor. "Space": Puts a space.           <ul style="list-style-type: none"> <li>Pressing CLR on the remote controller will remove all the input characters.</li> </ul> </li> <li>After inputting, select "OK" with the cursors and press ENTER. The input name will be saved.</li> </ol>

- To name a preset radio station, press TUNER on the remote controller, select AM/FM and select the preset number.
- It cannot be set if the "NET" or "BLUETOOTH" input is selected.

##### Audio Select

Make the audio input setting. The setting can be separately set to each input selector button. Select the input selector to configure.

Setting Item	Default Value	Setting Details
Audio Select	BD/DVD: HDMI CBL/SAT: HDMI STRM BOX: HDMI PC: HDMI GAME 1: HDMI GAME 2: HDMI AUX: HDMI CD: OPTICAL TV: OPTICAL PHONO: Analog	<p>Select the priority for input selection when multiple audio sources are connected to one input selector, such as connections to both the "BD/DVD" of HDMI jack and "BD/DVD" of AUDIO jack. You cannot select a jack that is not associated with the currently selected input.</p> <p>"ARC": When giving priority to input signal from ARC compatible TV.</p> <ul style="list-style-type: none"> <li>The setting can be selected only when "HDMI" - "Audio Return Channel" is set to "Auto" and also the "TV" input is selected.</li> </ul> <p>"HDMI": When giving priority to input signal from HDMI jacks</p> <ul style="list-style-type: none"> <li>The setting can be selected only when the input is assigned to the HDMI IN jack in the "HDMI Input" setting.</li> </ul> <p>"COAXIAL": When giving priority to input signal from COAXIAL jacks.</p> <ul style="list-style-type: none"> <li>The setting can be selected only when the input is assigned to the COAXIAL jack in the "Digital Audio Input" setting.</li> </ul> <p>"OPTICAL": When giving priority to input signal from OPTICAL jacks.</p> <ul style="list-style-type: none"> <li>The setting can be selected only when the input is assigned to the OPTICAL jack in the "Digital Audio Input" setting.</li> </ul> <p>"Analog": To always output analog audio independently of the input signal</p>
PCM Fixed Mode	Off	<p>Select whether to fix input signals to PCM (except multi-channel PCM) when you have selected "HDMI", "COAXIAL", or "OPTICAL" in the "Audio Select" setting. Set this item to "On" if noise is produced or truncation occurs at the beginning of a track when playing PCM sources. Select "Off" normally.</p> <ul style="list-style-type: none"> <li>Changing "Audio Select" changes the setting to "Off".</li> </ul>

- The setting cannot be changed when "TUNER", "NET", or "BLUETOOTH" input is selected.



## Advanced Settings (Setup Menu)

## Video Select

Setting Item	Default Value	Setting Details
Video Select	Last	Select the video input played along with audio output when either "TUNER", "NET" or "BLUETOOTH" is selected. <ul style="list-style-type: none"> <li>This setting is effective only for an input selector which is assigned in "HDMI Input" or "Video Input".</li> </ul> "Last": Select the video input played immediately prior. "BD/DVD", "CBL/SAT", "STRM BOX", "PC", "GAME 1", "GAME 2", "AUX", "CD", "PHONO", "TV": Play the video from the selected input.

- The setting cannot be changed when input other than "TUNER", "NET" or "BLUETOOTH" is selected.
- When input is "NET" or "BLUETOOTH", switch between displaying and not displaying video by pressing MODE on the remote controller.

## 5. Listening Mode Preset

You can preset your favorite listening mode to each input. (For example, you can always apply straight decode to the Dolby TrueHD source of Blu-ray Disc to play it in unchanged sound field.)

When the list of input sources is displayed, set the signal type and listening mode. Although it is possible to select the listening mode during playback, the selected mode will be reset when the unit enters standby mode.

Setting Item	Default Value	Setting Details
Analog/PCM	Last Valid	Set the listening mode for playing PCM signals of CD and analog signals of record and cassette tape.
Mono/Multiplex	Last Valid	Set the listening mode for playing Dolby Digital and other digital signals recorded in monaural or multiplex audio.
2 ch Source	Last Valid	Set the listening mode for playing Dolby Digital and other digital signals recorded in 2 channels.
Dolby D/Dolby D+/TrueHD	Last Valid	Set the listening mode for playing multi-channel Dolby Digital, Dolby Digital Plus and Dolby TrueHD signals. <ul style="list-style-type: none"> <li>Input signals are played as they are input if you select "Straight Decode".</li> </ul>

Setting Item	Default Value	Setting Details
DTS/DTS-ES/DTS-HD	Last Valid	Set the listening mode for playing multi-channel digital audio signals in DTS and DTS-HD High Resolution formats. Select the listening mode specified for Blu-ray or such other DTS-HD Master Audio source. <ul style="list-style-type: none"> <li>Input signals are played as they are input if you select "Straight Decode".</li> </ul>
Other Multich Source	Last Valid	Set the listening mode for playing multi-channel audio such as DVD-audio and DSD signals. <ul style="list-style-type: none"> <li>Input signals are played as they are input if you select "Straight Decode".</li> </ul>

- Available listening modes vary depending on speaker configuration and the input signal.
- Setting "Last Valid" will always select the last selected mode.
- Only "Analog" can be set to the "TUNER" input.
- "Digital" and "TrueHD" can be set to the "NET" input.
- Only "Digital" can be set to the "BLUETOOTH" input.



**6. Hardware**

**Tuner**

Setting Item	Default Value	Setting Details
AM/FM Frequency Step (North American models)	10kHz/0.2MHz	Select a frequency step depending on your area of residence. Select "10kHz/0.2MHz" or "9kHz/0.05MHz". <ul style="list-style-type: none"> <li>When this setting is changed, all radio presets are deleted.</li> </ul>
AM Frequency Step (European, Australian and Asian models)	9kHz	Select a frequency step depending on your area of residence. Select "10kHz" or "9kHz". <ul style="list-style-type: none"> <li>When this setting is changed, all radio presets are deleted.</li> </ul>

**HDMI**

Setting Item	Default Value	Setting Details
HDMI CEC (RIHD)	Off	<p>Setting to "On" enables the input selection link and other link functions with HDMI connected CEC compliant device.</p> <p>"On": Use this function                      "Off": Do not use this function</p> <p>When changing this setting, turn off and then on again the power of all connected components.</p> <ul style="list-style-type: none"> <li>Depending on the TV set, a link may need to be configured on the TV.</li> <li>When this setting is "On", the names of the CEC-compatible components and "CEC On" are displayed after this operation screen is closed.</li> <li>Setting to "On" increases the power consumption even when the unit is on standby. However, the increase in power consumption is kept to a minimum by automatically entering the HYBRID STANDBY mode, where only the essential circuit is operating.</li> <li>If you operate the MASTER VOLUME control on the unit when this setting is "On" and audio is output from the TV speakers, audio will be output also from the speakers connected to the unit. If you want to output from only either of them, change the unit or TV settings, or reduce the volume of the unit.</li> <li>If abnormal operation occurs when you set the setting to "On", set it to "Off".</li> <li>When connecting a non-CEC compatible component, or when you are not sure whether it is compatible, set the setting to "Off".</li> </ul>
Control TV	MAIN	<p>Set whether to enable the CEC link function for TVs connected through one of the HDMI OUT MAIN or SUB jacks. To change this setting, set "HDMI CEC (RIHD)" to "On" in advance.</p> <ul style="list-style-type: none"> <li>When you have set "TV Out" - "HDMI Out" to "SUB" you cannot select "MAIN".</li> </ul>



## Advanced Settings (Setup Menu)

Setting Item	Default Value	Setting Details
HDMI Standby Through	Off	<p>When this is set to anything other than "Off", you can play the video and audio of an HDMI connected player on the TV even if the unit is in standby mode. Only "Auto" and "Auto(Eco)" can be selected if "HDMI CEC (RIHD)" is set to "On". If you select anything else, set "HDMI CEC (RIHD)" to "Off".</p> <ul style="list-style-type: none"> <li>Power consumption in standby mode increases if set to anything other than "Off".</li> </ul> <p>"BD/DVD", "CBL/SAT", "STRM BOX", "PC", "GAME 1", "GAME 2", "AUX", "CD", "PHONO", "TV": For example, if you select "BD/DVD", you can play the equipment connected to the "BD/DVD" terminal on the TV even if the unit is in standby mode. Select this setting if you have decided which player to use with this function.</p> <p>"Last": You can play the video and audio of the input selected immediately prior to the unit being switched to standby on the TV. When "Last" is selected, you can switch the input of the unit even in the standby mode with the remote controller or the Onkyo Remote app.</p> <p>"Auto", "Auto (Eco)": Select one of these settings when you have connected equipment that conforms to the CEC standard. You can play the video and audio of the input selected on the TV, irrespective of what input was selected immediately prior to the unit being switched to standby, using the CEC link function.</p> <ul style="list-style-type: none"> <li>To play players on the TV that do not conform to the CEC standard, you will need to turn the unit on and switch to the relevant input.</li> <li>When using a TV that conforms to the CEC standard, you can reduce the power consumption in standby mode by selecting "Auto (Eco)".</li> </ul>

Setting Item	Default Value	Setting Details
Audio TV Out (MAIN)	Off	<p>You can enjoy audio through the speakers of the HDMI connected TV while this unit is on.</p> <p>"On": Use this function  "Off": Do not use this function</p> <ul style="list-style-type: none"> <li>To select "On", set "HDMI CEC (RIHD)" to "Off".</li> <li>The setting is fixed to "Auto" if "HDMI CEC (RIHD)" is set to "On" and "Control TV" is set to "MAIN".</li> <li>Listening mode cannot be changed while "Audio TV Out (MAIN)" is set to "On" and audio is being output through the speakers of the TV.</li> <li>Depending on your TV set or input signal of the component, audio may not output through the speakers of the TV even if this setting is set to "On". In such case, audio is output from the speakers of the unit.</li> <li>If you operate the MASTER VOLUME control on the unit when audio input to the unit is being output from the TV speakers, audio will be output from the unit. If you do not want to output audio from the unit, change the unit or TV settings, or reduce the volume of the unit.</li> <li>This setting is fixed to "Off" if "TV Out" - "HDMI Out" is set to "SUB".</li> </ul>



## Advanced Settings (Setup Menu)

Setting Item	Default Value	Setting Details
Audio TV Out (SUB)	Off	<p>You can enjoy audio through the speakers of the HDMI connected TV while this unit is on.</p> <p>"On": Use this function</p> <p>"Off": Do not use this function</p> <ul style="list-style-type: none"> <li>The setting is fixed to "Auto" if "HDMI CEC (RIHD)" is set to "On" and "Control TV" is set to "SUB".</li> <li>Listening mode cannot be changed while "Audio TV Out (SUB)" is set to "On" and audio is being output through the speakers of the TV.</li> <li>Depending on your TV set or input signal of the component, audio may not output through the speakers of the TV even if this setting is set to "On". In such case, audio is output from the speakers of the unit.</li> <li>If you operate the MASTER VOLUME control on the unit when audio input to the unit is being output from the TV speakers, audio will be output from the unit. If you do not want to output audio from the unit, change the unit or TV settings, or reduce the volume of the unit.</li> <li>This setting is fixed to "Off" if "TV Out" - "HDMI Out" is set to "MAIN".</li> </ul>
Audio Return Channel	Auto (*)	<p>You can enjoy sound of the HDMI connected ARC compatible TV through the speakers connected to the unit.</p> <p>* To use this function, set "HDMI CEC (RIHD)" to "On" in advance.</p> <p>"Auto": When enjoying the TV sound through the speakers connected to the unit</p> <p>"Off": When not using the ARC function</p>
Auto LipSync	On	<p>This setting automatically corrects any desynchronization between the video and audio signals based on data from the HDMI LipSync compatible TV.</p> <p>"On": Automatic correction will be enabled.</p> <p>"Off": Automatic correction will be disabled.</p>

## Power Management

Setting Item	Default Value	Setting Details
Sleep Timer	Off	<p>Select to turn the unit into standby mode automatically when the specified time elapses. Select a value between "10 minutes" to "90 minutes".</p> <p>"Off": Select if you do not want the unit to automatically switch to standby.</p>
Auto Standby	On/Off	<p>This setting places the unit on standby automatically after 20 minutes of inactivity without any video or audio input.</p> <p>"On": The unit will automatically enter standby mode.</p> <p>"Off": The unit will not automatically enter standby mode.</p> <ul style="list-style-type: none"> <li>"Auto Standby" is appeared on the display and TV screen 30 seconds before the Auto Standby comes on.</li> <li>"Auto Standby" does not work when Zone 2 is on.</li> <li>Default values vary depending on the regions.</li> </ul>
Auto Standby in HDMI Standby Through	Off	<p>Enable or disable "Auto Standby" while "HDMI Standby Through" is on.</p> <p>"On": The setting will be enabled.</p> <p>"Off": The setting will be disabled.</p> <ul style="list-style-type: none"> <li>This setting cannot be set to "On" if "Auto Standby" is set to "Off".</li> </ul>
USB Power Out at Standby	Off	<p>When this function is "On", you can still have equipment connected to the USB port supplied with power even when this unit is in standby.</p> <ul style="list-style-type: none"> <li>When this function is being used, the power consumption increases even when the unit is on standby. However, the increase in power consumption is kept to a minimum by automatically entering the HYBRID STANDBY mode, where only the essential circuit is operating.</li> </ul>



Setting Item	Default Value	Setting Details
Network Standby	Off	When this function is "On", you can turn on the power of the unit via network using an application such as Onkyo Remote. <ul style="list-style-type: none"> <li>When "Network Standby" is used, the power consumption increases even when the unit is on standby. However, the increase in power consumption is kept to a minimum by automatically entering the HYBRID STANDBY mode, where only the essential circuit is operating.</li> </ul>
Bluetooth Wakeup	Off	This function wakes up the unit on standby by connecting a BLUETOOTH-enabled device. <p>"On": Use this function</p> <p>"Off": Do not use this function</p> <ul style="list-style-type: none"> <li>Setting to "On" increases the power consumption even when the unit is on standby. However, the increase in power consumption is kept to a minimum by automatically entering the HYBRID STANDBY mode, where only the essential circuit is operating.</li> <li>This setting is fixed to "Off" if "Bluetooth" - "Auto Input Change" is set to "Off".</li> </ul>

- Wait for a while if "Network Standby" or "Bluetooth Wakeup" cannot be selected. It will appear when the network function is started up.

## Network

Make the network setting.

- When LAN is configured with a DHCP, set "DHCP" to "Enable" to configure the setting automatically. ("Enable" is set by default) To assign fixed IP addresses to each components, you must set "DHCP" to "Disable" and assign an address to this unit in "IP Address" as well as set information related to your LAN, such as Subnet Mask and Gateway.

Setting Item	Default Value	Setting Details
Wi-Fi	Off (Wired)	Connect the unit to network via wireless LAN router. "On": Wireless LAN connection "Off (Wired)": Wired LAN connection
Wi-Fi Setup	–	You can configure wireless LAN settings by pressing ENTER when "Start" is displayed.
Wi-Fi Status	–	The information of the connected access point will be displayed. "SSID": SSID of the connected access point. "Signal": Signal strength of the connected access point. "Status": Status of the connected access point.
MAC Address	–	This is the MAC address of the AV receiver. This value is specific to the component and cannot be changed.
DHCP	Enable	"Enable": Auto configuration by DHCP "Disable": Manual configuration without DHCP <ul style="list-style-type: none"> <li>If selecting "Disable", you must set "IP Address", "Subnet Mask", "Gateway", and "DNS Server" manually.</li> </ul>
IP Address	–	Displays/Sets the IP address.
Subnet Mask	–	Displays/Sets the subnet mask.
Gateway	–	Displays/Sets the gateway.
DNS Server	–	Displays/Sets the primary DNS server.
Proxy URL	–	Displays/Sets the proxy server URL.
Proxy Port	–	Displays/Sets the proxy server port number when you enter "Proxy URL".



Advanced Settings (Setup Menu)

Setting Item	Default Value	Setting Details
Friendly Name	TX-RZ900/ TX-RZ800	<p>Change the name for this unit to a simple one for display on the equipment connected by network.</p> <ol style="list-style-type: none"> <li>Press ENTER to display the Edit screen.</li> <li>Select a character or symbol with the cursors and press ENTER. Repeat it to input 31 or less characters. "A/a": Switches between upper and lower cases. (Pressing +10 on the remote controller also toggles between upper and lower cases.) "←" "→": Moves the cursor to the arrow direction. "⌫": Removes a character on the left of the cursor. "Space": Puts a space. <ul style="list-style-type: none"> <li>Pressing CLR on the remote controller will remove all the input characters.</li> </ul> </li> <li>After inputting, select "OK" with the cursors and press ENTER. The input name will be saved.</li> </ol>
AirPlay Password	----	<p>You can enter a password (maximum of 31 places) so that only the entered user can use AirPlay®.</p> <ol style="list-style-type: none"> <li>Press ENTER to display the Edit screen.</li> <li>Select a character or symbol with the cursors and press ENTER. Repeat it to input 31 or less characters. "A/a": Switches between upper and lower cases. (Pressing +10 on the remote controller also toggles between upper and lower cases.) "←" "→": Moves the cursor to the arrow direction. "⌫": Removes a character on the left of the cursor. "Space": Puts a space. <ul style="list-style-type: none"> <li>Pressing D on the remote controller will switch whether to mask the password with "*" or display in the plain text.</li> <li>Pressing CLR on the remote controller will remove all the input characters.</li> </ul> </li> <li>After inputting, select "OK" with the cursors and press ENTER. The input password will be saved.</li> </ol>

Setting Item	Default Value	Setting Details
Usage Data	No	<p>As a means of improving the quality of our products and services, Onkyo may collect information about your usage over the network. Select "Yes" if you agree to our collecting this information. Select "No" if you do not want us to collect this information.</p> <ul style="list-style-type: none"> <li>You can set this after confirming the Privacy Policy. When you select "Usage Data" and press ENTER, the Privacy Policy is displayed. (The same screen is displayed once also when setting up the network connection.) If you agree to the collection of the information, this setting also becomes "Yes". Note that if you agree to the Privacy Policy but select "No" for this setting, the information will not be collected.</li> </ul>
Network Check	–	<p>You can check the network connection. Press ENTER when "Start" is displayed.</p>

- Wait for a while if "Network" cannot be selected. It will appear when the network function is started up.





## Advanced Settings (Setup Menu)

## Bluetooth

Setting Item	Default Value	Setting Details
Bluetooth	On	Select whether or not to use the BLUETOOTH function. "On": Enables connection with a BLUETOOTH-enabled device by using the BLUETOOTH function. Select "On" also when making various BLUETOOTH settings. "Off": When not using the BLUETOOTH function
Auto Input Change	On	The input of the unit will automatically be switched to "BLUETOOTH" when connection is made from a BLUETOOTH-enabled device to the unit. "On": The input will automatically become "BLUETOOTH" when a BLUETOOTH-enabled device is connected. "Off": The function is disabled. <ul style="list-style-type: none"> <li>If the input is not switched automatically, set to "Off" and change the input manually.</li> </ul>
Auto Reconnect	On	This function automatically reconnects to the BLUETOOTH-enabled device connected last when you change the input selector to "BLUETOOTH". "On": Use this function "Off": Do not use this function <ul style="list-style-type: none"> <li>This may not work with some BLUETOOTH-enabled devices.</li> </ul>
Pairing Information	–	The information of the previous pairing stored in this unit will be initialized. Pressing ENTER when "Clear" is displayed initializes the pairing information stored in this unit. <ul style="list-style-type: none"> <li>This function does not initialize the pairing information on the BLUETOOTH-enabled device. When pairing the unit again with the device, be sure to clear the pairing information on the BLUETOOTH-enabled device in advance. For information on how to clear the pairing information, refer to the BLUETOOTH-enabled device's instruction manual.</li> </ul>

Setting Item	Default Value	Setting Details
Device	–	Displays the name of the BLUETOOTH-enabled device connected to the unit. <ul style="list-style-type: none"> <li>The name is not displayed when "Status" is "Ready" or "Pairing".</li> </ul>
Status	–	Displays the status of the BLUETOOTH-enabled device connected to the unit. "Ready": Not paired "Pairing": Pairing "Connected": Successfully connected

- Wait for a while if "Bluetooth" cannot be selected. It will appear when the BLUETOOTH function is started up.

## 12V Trigger

Setting Item	Default Value	Setting Details
Zone	Main	Set which zone to output the 12V trigger when playing. If you select "All", then the 12V trigger is output to all zones that are playing.



## 7. Remote Controller

Setting Item	Default Value	Setting Details
Remote ID	1	Select an ID for the unit's remote controller from "1", "2", and "3" to prevent interference between the unit and other Onkyo components that are installed in the same room. After changing the ID on the main unit, change the ID on the remote controller accordingly with the following procedure. <ol style="list-style-type: none"> <li>While holding down RCV, press and hold SETUP for about 3 seconds until the remote indicator lights.</li> <li>With the number buttons, press one of 1, 2, and 3. The remote indicator flashes twice.</li> </ol>
Remote Mode	–	Input and register the remote controller code of other devices. <ul style="list-style-type: none"> <li>For registration of the remote control code, refer to the next section, "Operating Other Components with the Remote Controller".</li> </ul>

## 8. Miscellaneous

### Firmware Update

Setting Item	Default Value	Setting Details
Update Notice	Enable	Availability of a firmware update will be notified via network. "Enable": Notify updates "Disable": Do not notify updates
Version	–	The current firmware version will be displayed.
Update via NET	–	Press ENTER to select when you want to update the firmware via network. <ul style="list-style-type: none"> <li>You will not be able to select this setting if you do not have Internet access or there is nothing to update.</li> </ul>
Update via USB	–	Press ENTER to select when you want to update the firmware via USB. <ul style="list-style-type: none"> <li>You will not be able to select this setting if a USB storage device is not connected or there is nothing to update in the USB storage device.</li> </ul>

- Wait for a while if "Firmware Update" cannot be selected. It will appear when the network function is started up.
- Refer to the "Firmware Update" section for details about how to update the firmware.

### Initial Setup

You can make the initial setup from the setup menu.

- Wait for a while if "Initial Setup" cannot be selected. It will appear when the network function is started up.

### Lock

Setting Item	Default Value	Setting Details
Setup Parameter	Unlocked	Lock the Setup menu to protect the settings. "Locked": The menu is locked. "Unlocked": The menu is unlocked.



## Operating Other Components with the Remote Controller

### Functions of REMOTE MODE Buttons

You can control any other device than this unit by programming a specified remote control code to a REMOTE MODE button of the remote controller. Register a remote control code to a desired REMOTE MODE button and press it to enter the remote mode that allows you to operate the corresponding device.

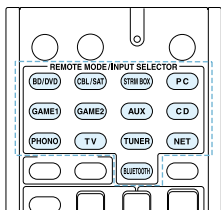

\* The RCV and ZONE2/ZONE3 buttons cannot be programmed.

### Programming Remote Control Codes

#### ■ Searching in the Setup Menu

You can search a remote control code and register it to a desired REMOTE MODE button in the unit's Setup menu.

1. After pressing RCV on the remote controller, press SETUP.

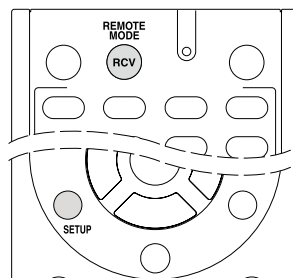

2. With the cursors, select "7. Remote Controller" - "Remote Mode" and press ENTER.
3. With the cursors, select the REMOTE MODE button for which you want to register a remote control code and press ENTER to display the subcategory selection screen.
4. With the cursors, select the target subcategory, and then press ENTER to display the brand name input screen.
5. Select a character with the cursors and press ENTER. Repeat it to enter the first three characters of the brand name.
6. Select "OK" with the cursors and press ENTER.
  - After a search is done, the list of possible brand names is displayed. If the brand name list is not displayed, select "Not Listed" with the cursors and press ENTER to return to the brand name input screen in step 5.
7. With the cursors, select the target brand name, and then press ENTER.
  - When the brand name is specified, the remote control code of the brand and how to register it will be displayed on the TV screen.
8. Follow the guidance displayed on the TV screen.
9. If the component can successfully be operated with its registered remote control code, select "OK" with the cursors and press ENTER.
  - Only TV remote control codes can be entered for TV.

### Operating Other Components with the Remote Controller

- Program a remote control code in accordance with the input since each button also works as the input selector. (For example, when the CD player is connected to the CD jack, program the remote control code for the CD player to CD)
- If the component cannot be operated, select "Try Next Code" with the cursors and press ENTER to display another code.

#### ■ Consulting the Remote Control Code List

Find the remote control code in the remote control code list.

1. Look up the [Remote Control Codes](#) at the back of the manual for the corresponding remote control code.
  - The codes in the Remote Control Code List are those known as of the date of publication and may be changed.
  - The following REMOTE MODE buttons are preprogrammed with remote control codes.  
BD/DVD: Onkyo Blu-ray Disc/DVD player  
CD: Onkyo CD player  
STRM BOX: Apple TV
  - Only TV remote control codes can be entered for TV.
  - Program a remote control code in accordance with the input since each button also works as the input selector. (For example, when the CD player is connected to the CD jack, program the remote control code for the CD player to CD)
2. Press and hold DISPLAY for 3 or more seconds while holding down the REMOTE MODE button to which you want to program the remote control code.
  - The remote indicator lights in the input mode.

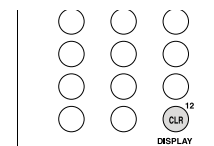

3. With the number buttons, enter the 5-digit remote control code within 30 seconds.
  - Programming is complete when the remote indicator flashes twice. The remote indicator flashes once slowly when programming the remote control code fails. Try programming again.



Operating Other Components with the Remote Controller

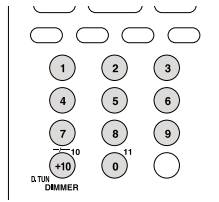

■ Remapping the Colored Buttons

The colored button assignment on the AV receiver's remote controller can be remapped to match that on the remote controller of the component whose remote control code you programmed to REMOTE MODE. However, you will not be able to remap the colored buttons if Zone 2/Zone 3 is selected.

1. Hold down the REMOTE MODE button to map and A (Red) simultaneously until the remote indicator lights (about 3 seconds).
  - Remapping is possible only for codes included in the categories of the Remote Control Code List (DVD player, TV, etc.)

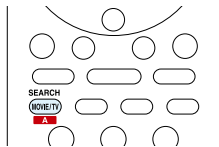

2. Within 30 seconds, press the colored buttons from left to right, in the order you want to remap.
  - For example, if the colored buttons on the remote controller of the other component are yellow, green, blue, and red from left to right, press the buttons on the AV receiver's remote controller in that order.
  - Programming is complete when the remote indicator flashes twice. The remote indicator flashes once slowly when programming the remote control code fails. Try programming again.
  - Pressing any other button than a colored button cancels the remap operation.

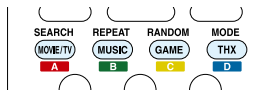

■ Resetting the REMOTE MODE Buttons

You can reset the remote control code registered in the REMOTE MODE button to its default status. This operation can be executed on a single REMOTE MODE button.

1. Press and hold Q for 3 or more seconds while holding down the REMOTE MODE button you want to reset.
  - The remote indicator will light.

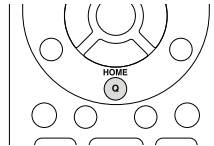

2. Within 30 seconds, press the REMOTE MODE button again.
  - Resetting is complete when the remote indicator flashes twice.

**To reset all the remote controller settings:** While holding down RCV, press and hold Q for 3 or more seconds until the remote indicator stays lit. Within 30 seconds, press RCV again. Resetting is complete when the remote indicator flashes twice.

TV operation

Press the REMOTE MODE button programmed with the remote control code for the relevant AV component to switch the remote controller mode to that for the AV component. Then, operate by using the corresponding buttons. Available buttons vary depending on the product category of the component. Operation may be incorrect or impossible depending on the product.

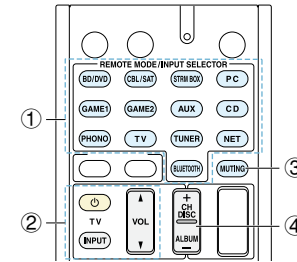

- ① REMOTE MODE
- ② ⏪, INPUT, VOL ▲/▼
- ③ MUTE
- ④ CH +/-

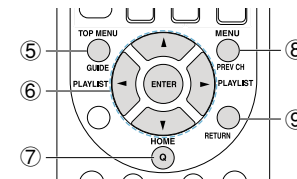

- ⑤ GUIDE
- ⑥ ▲/▼/◀/▶, ENTER
- ⑦ HOME
- ⑧ PREV CH
- ⑨ RETURN



Operating Other Components with the Remote Controller

**VCR/PVR operation**

Press the REMOTE MODE button programmed with the remote control code for the relevant AV component to switch the remote controller mode to that for the AV component. Then, operate by using the corresponding buttons. Available buttons vary depending on the product category of the component. Operation may be incorrect or impossible depending on the product.

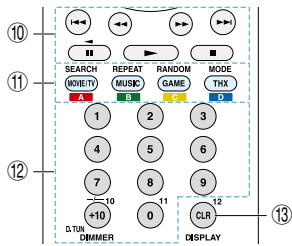

- ⑩ ►, ■, ■, ◀, ▶, ◀▶, ▶◀, ▶◀▶ (※)
- ⑪ A (Red), B (Green), C (Yellow), D (Blue)
- ⑫ Number 1 to 9, 0, +10
- ⑬ CLR, DISPLAY

\* Not CEC-compatible.

**Blu-ray Disc player/DVD player/DVD recorder operation**

Press the REMOTE MODE button programmed with the remote control code for the relevant AV component to switch the remote controller mode to that for the AV component. Then, operate by using the corresponding buttons. Available buttons vary depending on the product category of the component. Operation may be incorrect or impossible depending on the product.

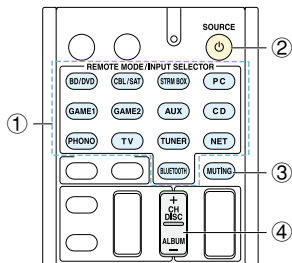

- ① REMOTE MODE
- ② SOURCE
- ③ MUTE
- ④ CH +/-, DISC +/-

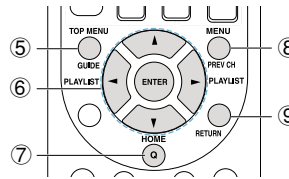

- ⑤ TOP MENU
- ⑥ ▲/▼/◀/▶, ENTER
- ⑦ HOME
- ⑧ MENU
- ⑨ RETURN

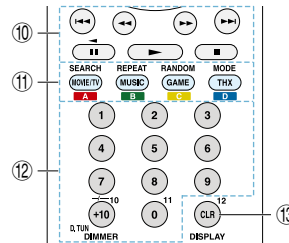

- ⑩ ►, ■, ■, ◀, ▶, ◀▶, ▶◀, ▶◀▶ (※)
- ⑪ A (Red), B (Green), C (Yellow), D (Blue)
- ⑫ Number 1 to 9, 0, +10 (※)
- ⑬ CLR, DISPLAY

\* Not CEC-compatible.

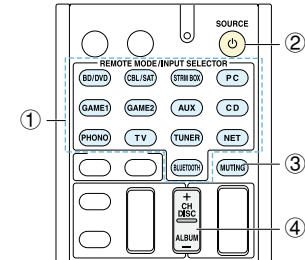

- ① REMOTE MODE
- ② SOURCE
- ③ MUTE
- ④ CH +/-

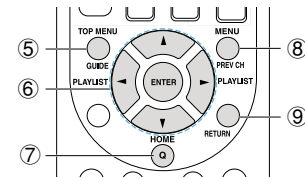

- ⑤ GUIDE
- ⑥ ▲/▼/◀/▶, ENTER
- ⑦ HOME
- ⑧ PREV CH
- ⑨ RETURN



Operating Other Components with the Remote Controller

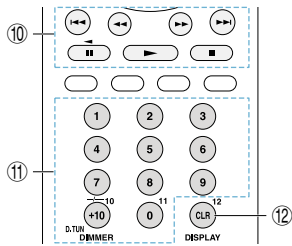

- ⑩ ►, ||, ■, ◀, ▶, ◀◀, ▶▶, |◀◀, ▶▶|
- ⑪ Number 1 to 9, 0, +10
- ⑫ CLR, DISPLAY

**Satellite receiver / Cable receiver operation**

Press the REMOTE MODE button programmed with the remote control code for the relevant AV component to switch the remote controller mode to that for the AV component. Then, operate by using the corresponding buttons. Available buttons vary depending on the product category of the component. Operation may be incorrect or impossible depending on the product.

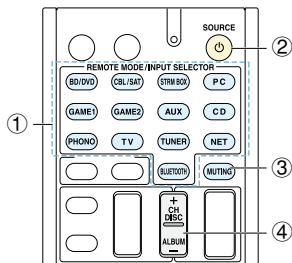

- ① REMOTE MODE
- ② SOURCE
- ③ MUTE
- ④ CH +/-

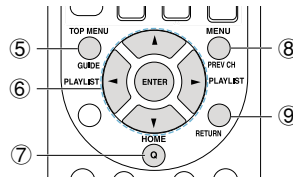

- ⑤ GUIDE
- ⑥ ▲▼◀▶, ENTER
- ⑦ HOME
- ⑧ PREV CH
- ⑨ RETURN

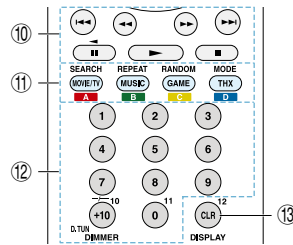

- ⑩ ►, ||, ■, ◀, ▶, ◀◀, ▶▶, |◀◀, ▶▶|
- ⑪ A (Red), B (Green), C (Yellow), D (Blue)
- ⑫ Number 1 to 9, 0, +10
- ⑬ CLR, DISPLAY

**CD player operation**

Press the REMOTE MODE button programmed with the remote control code for the relevant AV component to switch the remote controller mode to that for the AV component. Then, operate by using the corresponding buttons. Available buttons vary depending on the product category of the component. Operation may be incorrect or impossible depending on the product.

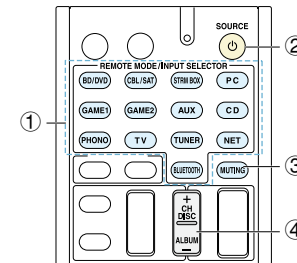

- ① REMOTE MODE
- ② SOURCE
- ③ MUTE
- ④ DISC +/-

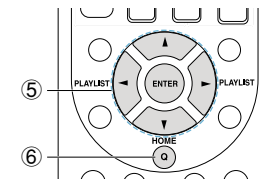

- ⑤ ▲▼◀▶, ENTER
- ⑥ HOME



Operating Other Components with the Remote Controller

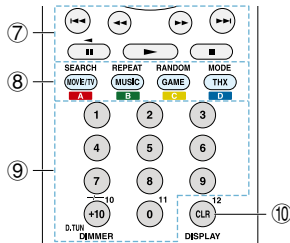

- ⑦ ▶, ||, ■, ◀◀, ▶▶, ◀◀▶▶, ▶▶◀◀
- ⑧ SEARCH, REPEAT, RANDOM, MODE
- ⑨ Number 1 to 9, 0, +10
- ⑩ CLR, DISPLAY

**Cassette tape deck operation**

Press the REMOTE MODE button programmed with the remote control code for the relevant AV component to switch the remote controller mode to that for the AV component. Then, operate by using the corresponding buttons. Available buttons vary depending on the product category of the component. Operation may be incorrect or impossible depending on the product.

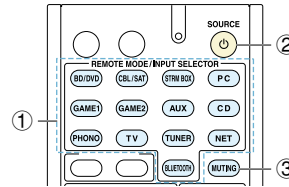

- ① REMOTE MODE
- ② SOURCE
- ③ MUTING

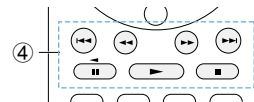

- ④ ▶, ◀ (Reverse Playback), ■, ◀◀, ▶▶, ◀◀▶▶, ▶▶◀◀

**To operate CEC-compatible components**

If this unit is connected via HDMI to a TV or BD/DVD player, you may be able to control the devices using the remote controller of this unit with CEC (Consumer Electronics Control) linked operation.

**TV:** The TV button on the remote controller is preprogrammed with remote control codes for linked operation of some CEC(Consumer Electronics Control)-compatible TV sets.

- If you cannot operate your CEC-compatible TV, program one of the following remote control codes (11807/13100/13500) to the TV button.

**BD/DVD player:** By registering a remote control code (32910/33101/33501/31612) in the BD/DVD button, your remote controller will be able to take advantage of linked operation with CEC-compatible BD/DVD players.



## Advanced Connections

### Connecting Bi-amp Speakers

It is possible to connect speakers supporting bi-amping to improve quality of the bass and treble. Up to 5.1 ch will be played in bi-amping.

#### ■ Connections

1. Connect as below using the FRONT terminals and HEIGHT terminals.

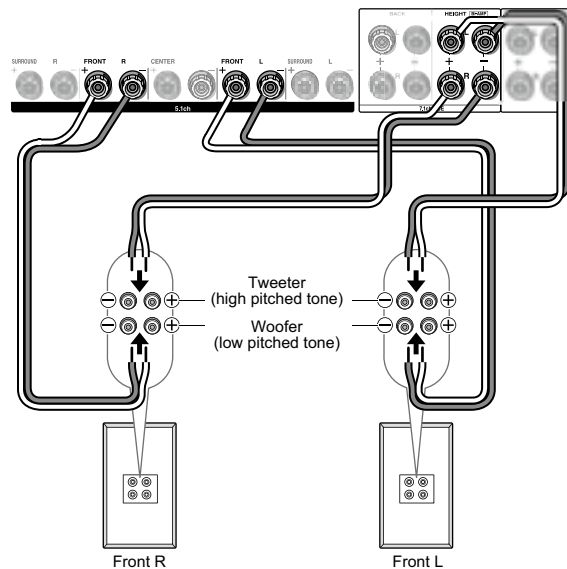

2. Turn the unit on and make the bi-amping setting.
  - ① After pressing RCV on the remote controller, press SETUP.
  - ② With the cursors, select "2. Speaker" - "Configuration" - "Bi-Amp".
  - ③ Select "Yes" with the cursors.
    - Before bi-amping, be sure to remove the short-circuit connector that connects the tweeter (treble)

- jack and the subwoofer (bass) jack.
- Use speakers supporting bi-amping only. For details, refer to the speakers' instruction manual.

### Connecting Dipole Speakers

A dipole speaker is bidirectional speaker outputting the same sound in two directions, for example forward and backward.

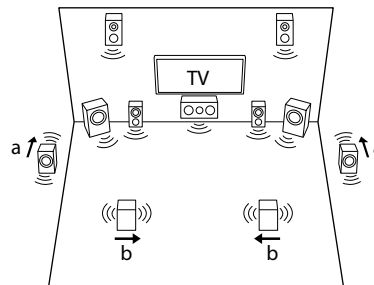

#### ■ Connections

An arrow for matching the phases (\*) is marked on a dipole speaker. Place the surround speakers (a) so that their arrows (↑) point to the TV and the back speakers (b) so that their arrows (→) point to each other.

- \* If the phases do not match due to mistake in speaker distance, installation angle or positive/negative of wiring, sound image and sound field may be unclear or hard of listening.

### Connecting a Power Amplifier

You can connect a power amplifier to the unit and use the unit as a pre-amplifier in order to produce a large volume that cannot be output with the unit only. Connect the speakers to the power amplifier. For details, refer to the power amplifier's instruction manual.

#### ■ Connections

1. Connect as below using the PRE OUT terminals.

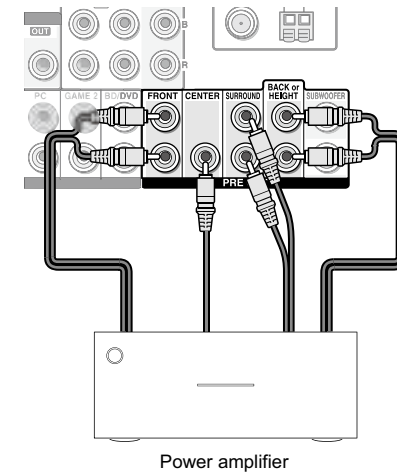

- Set to suit the number of speaker channels connected.
  - After pressing the RCV button, press the SETUP button on the remote controller. Select "2. Speaker" - "Configuration" - "Speaker Channels" in order with the cursors, and set the number of speaker channels.





## Connecting and Operating Onkyo RI Components

### About RI Function

Connecting an Onkyo component with RI jack such as the separately sold RI Dock to the unit by using an RI cable and an analog audio cable enables the following RI functions:

**System On / Auto Power On:** Starting playback on a component connected via RI when the unit is on standby mode, automatically turns on the unit to select the relevant component as its input source.

**Direct Change:** When playback is started on a component connected via RI, the unit selects that component as the input source.

**Remote Controller Operation:** Allows you to operate RI-compatible Onkyo components using the AV receiver's remote controller. Point the remote controller at remote control sensor of the unit. This operation is possible only when the RI remote control code is programmed.

- Some components may not support all RI functions.
- These functions do not work when Zone 2/Zone 3 is turned on.
- For information on the RI functions, also refer to each component's instruction manual.

### RI Connection and Setting

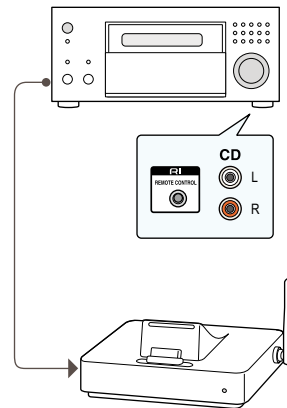

Connect an Onkyo component with RI jack to this unit using an RI cable and an analog audio cable. For details, refer to the instruction manual of the component with RI jack. The RI cable can be connected in any order. When there are two RI jacks, both jacks work in the same way and are interchangeable.

To connect the RI Dock or cassette tape deck via RI, the following settings are required.

#### ■ Rename the input selector

To make the RI functions work, you must rename the input selectors on the unit. Press CD or G1 on the main unit to display "CD" or "GAME1" on the main unit display. Then press and hold CD or G1 on the main unit 3 seconds or more to switch the display to "DOCK" or "TAPE".

#### ■ To program the RI remote control code

Program the remote control code to any REMOTE MODE button on the remote controller. This will allow you to operate the component by pointing the remote controller at the unit instead of the component.

1. Press and hold DISPLAY for 3 or more seconds while holding down the REMOTE MODE button to which you want to program the remote control code.
  - The remote indicator will light.
  - The RCV, ZONE2 and ZONE3 buttons cannot be programmed.

### Connecting and Operating Onkyo RI Components

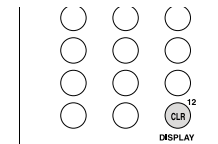

2. With the number buttons, enter the following 5-digit remote control code within 30 seconds.

RI Dock: 81993

Cassette tape deck with RI jack: 42157

- Programming is complete when the remote indicator flashes twice. The remote indicator flashes once slowly when programming the remote control code fails. Try programming again.

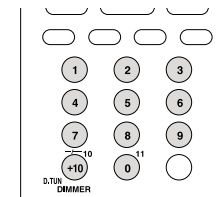

**Input selector on the RI Dock:** Switch to "DOCK" or "TAPE". For details, refer to the RI Dock's instruction manual.

To operate Onkyo components directly or Onkyo components that are not connected via RI, use the following remote control codes:

Onkyo DVD player: 30627

Onkyo CD player: 71817

RI Dock: 82990

- With some models, operation may be not possible in part or not possible at all.



### iPod®/iPhone® Operation

The RI Dock allows you to use the AV receiver's remote controller to operate and play music on your iPod/iPhone. Moreover, it also allows you to view videos on your iPod/iPhone on the screen of your TV, as well as perform RI operations if connected via RI. This operation is possible only when the RI remote control code is programmed.

**Before performing any operation:** Make sure the OS for your iPod/iPhone is updated to the latest version. Certain buttons may not work for some iPod/iPhone models and generations, or RI Dock. For details on the operation, refer to the RI Dock's instruction manual.

Switch the remote controller mode by pressing the REMOTE MODE button programmed with the remote control code for the iPod/iPhone, and operate by using the corresponding buttons. Point the remote controller at the unit.

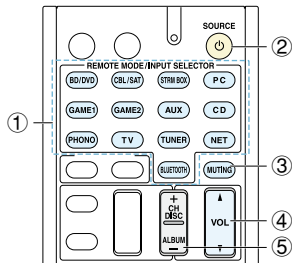

- ① REMOTE MODE
- ② SOURCE
- ③ MUTING
- ④ VOL ▲/▼
- ⑤ ALBUM +/-

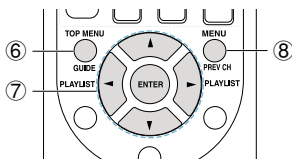

- ⑥ TOP MENU
- ⑦ ▲/▼/◀/▶, ENTER, PLAYLIST◀▶
- ⑧ MENU

### ⑧ MENU

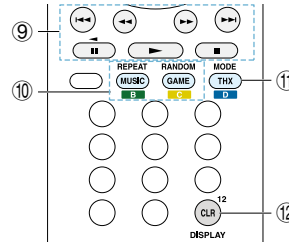

- ⑨ [stop], [play/pause], [previous], [next]
- ⑩ REPEAT, RANDOM
- ⑪ MUSIC, GAME, THX
- ⑫ CLR, DISPLAY

- Pressing DISPLAY turns on the backlight for a few seconds.
- MODE allows you to use the Resume function.



## Control Function between the Unit and External Component

You can enable the control functions between the unit and external devices using the terminals below. Special devices or cable connections are necessary to enable the functions. For more information about preparation, contact the specialized stores.

### ■ RS232 port

Use the port for connection with a commercially available integrated control system that can enable home automation. Some integrated control systems provide a centralized operation with a single touch panel controller in order to control audio and video home appliances and security devices together. For more information about adopting an integrated control system, contact the specialized stores.

### ■ IR jack

If you use a multiroom remote control kit with this jack, you can operate the unit with the remote controller even when you are in a separate room, or operate the unit with the remote controller even if its remote control sensor is difficult to see. You can also connect a device with the unit and operate it with the remote controller. For more information about adopting a multiroom remote control kit, contact the specialized stores.

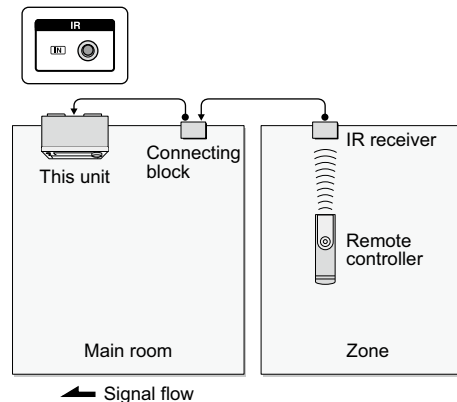

## Control Function between the Unit and External Component

### ■ 12V trigger output jack

You can enable power link operation when you connect the unit and an external device such as power amplifier equipped with 12V input jack. Power link operation will be activated with a control signal of maximum 12 V/100 mA from the 12V TRIGGER OUT jack. Select the zone to which to output the control signal from "Main", "Zone 2", "Zone 3", or "All". For connection, use a monaural mini plug cable.



## Firmware Update

### About Firmware Update

There are two methods for updating the firmware; via network and via USB.

Use the one that best suits your environment.

- For the latest information on updates, visit the Onkyo website.
- Before updating, make sure that the speaker setup microphone is not connected.
- During an update, do not
  - Disconnect and reconnect any cable, USB storage device, speaker setup microphone or headphones, or perform any operation on the component such as turn off its power
  - Access to this unit from a PC or smartphone using application
- The update may take about 30 minutes to complete for either method: via network or via USB. Furthermore, existing settings are guaranteed regardless of the method used for update.

**Disclaimer:** The program and accompanying online documentation are furnished to you for use at your own risk.

Onkyo will not be liable and you will have no remedy for damages for any claim of any kind whatsoever concerning your use of the program or the accompanying online documentation, regardless of legal theory, and whether arising in tort or contract.

In no event will Onkyo be liable to you or any third party for any special, indirect, incidental, or consequential damages of any kind, including, but not limited to, compensation, reimbursement or damages on account of the loss of present or prospective profits, loss of data, or for any other reason whatsoever.

### Updating the Firmware via Network

#### Before Starting:

- Check that the unit is turned on, and the connection to the Internet is secured.
  - Turn off the controller component (PC etc.) connected to the network.
  - Stop any playing Internet radio, USB storage device, or server content.
  - If the multi-zone function is active, turn it off.
  - If "HDMI CEC (RIHD)" is set to "On", set it to "Off" (default value).
    - After pressing RCV on the remote controller, press SETUP. Then, after selecting "6. Hardware" - "HDMI" and pressing ENTER, select "HDMI CEC (RIHD)" to select "Off".
- \* The description may differ from the on-screen display but that will not change the way to operate or the function.

#### Update

1. After pressing RCV on the remote controller, press SETUP.

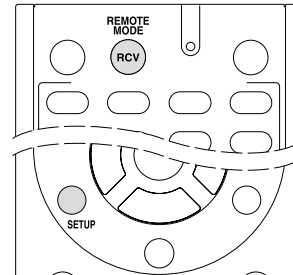

The Setup menu is displayed on the TV screen.

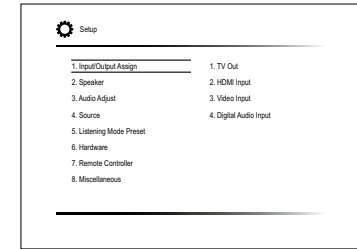

2. With the cursors, select "8. Miscellaneous" - "Firmware Update" - "Update via NET", and then press ENTER.

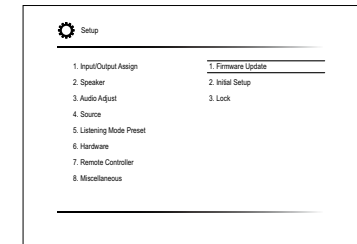

- If "Firmware Update" is grayed out and cannot be selected, wait for a while until it starts up.
  - You will not be able to select "Update via NET" if there is nothing to update.
3. Press ENTER with "Update" selected to start update.
    - During the update, the TV screen may go black depending on the updated program. In that case, check the progress on the display of the unit. The TV screen will remain black until the update is complete and the power is turned on again.
    - "Completed!" is displayed when the update is complete.
  4. Press  $\odot$ ON/STANDBY on the main unit to turn the unit into standby mode. The process is completed and your firmware is updated to the latest version.
    - Do not use  $\odot$ RECEIVER on the remote controller.



## Firmware Update

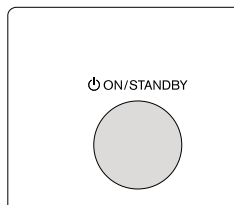

### ■ If an Error Message is Displayed

When an error occurs, "\*\*-\*\* Error!" is displayed on the unit. (\*\* represents an alphanumeric character.) Check the following:

#### Error Code

- **\*-01, \*-10:**  
Ethernet cable not found. Connect the Ethernet cable properly.
- **\*-02, \*-03, \*-04, \*-05, \*-06, \*-11, \*-13, \*-14, \*-16, \*-17, \*-18, \*-20, \*-21:**  
Internet connection error. Check the following:
  - Whether the router is turned on
  - Whether this unit and router are connected to the network
 Try to disconnect and then connect again the power to the unit and router. This may solve the problem. If you are still unable to connect to the Internet, the DNS server or proxy server may be temporarily down. Check the service status with your ISP provider.
- **Others:**  
First disconnect then reconnect the AC power cord, and then retry from the beginning.

### Updating the Firmware via USB

#### Before Starting:

- Prepare a 64MB or larger USB storage device. This unit supports FAT16 and FAT32 file system formats for USB storage devices.
  - Media inserted in a USB card reader may not be used for this function.
  - USB storage devices with security function are not supported.
  - USB hubs and USB devices with hub function are not supported. Do not connect these devices to the unit.
- Delete any data stored on the USB storage device.
- Turn off the controller component (PC etc.) connected to the network.
- Stop any playing Internet radio, USB storage device, or server content.
- If the multi-zone function is active, turn it off.
- If "HDMI CEC (RIHD)" is set to "On", set it to "Off" (default value).
  - After pressing RCV on the remote controller, press SETUP. Then, after selecting "6. Hardware" - "HDMI" and pressing ENTER, select "HDMI CEC (RIHD)" to select "Off".
- \* Some USB storage devices may take long to load, may not be loaded correctly, or may not be correctly fed depending on the device or their content.
- \* Onkyo will not be liable whatsoever for any loss or damage of data, or storage failure arising from the use of the USB storage device with this AV receiver. Thank you for your understanding.
- \* The description may differ from the on-screen display but that will not change the way to operate or the function.

### ■ Update

1. Connect the USB storage device to your PC.
2. Download the firmware file from the Onkyo website to your PC and unzip.  
Firmware files are named in the following way:  
ONKAVR\*\*\*\*\_\*\*\*\*\*.zip  
Unzip the file on your PC. The number of unzipped files and folders varies depending on the model.
3. Copy all unzipped files and folders to the root folder of the USB storage device.
  - Make sure to copy the unzipped files.
4. Connect the USB storage device to the USB port of the unit.
  - If you connect a USB hard disk drive to the USB port of the unit, we recommend that you use its AC

adapter to power it.

- If the USB storage device has been partitioned, each section will be treated as an independent device.

5. After pressing RCV on the remote controller, press SETUP.

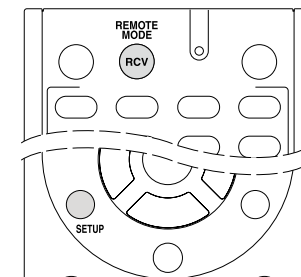

The Setup menu is displayed on the TV screen.

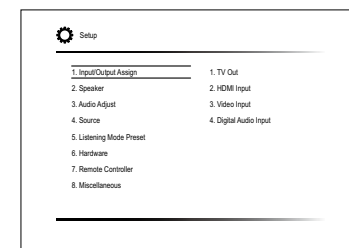

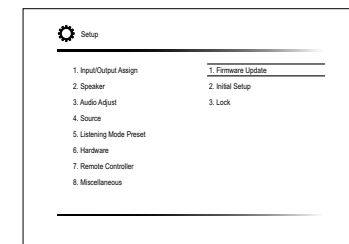

6. With the cursors, select "8. Miscellaneous" - "Firmware Update" - "Update via USB", and then press ENTER.



- If "Firmware Update" is grayed out and cannot be selected, wait for a while until it starts up.
- You will not be able to select "Update via USB" if there is nothing to update.



7. Press ENTER with "Update" selected to start update.
  - During the update, the TV screen may go black depending on the updated program. In that case, check the progress on the display of the unit. The TV screen will remain black until the update is complete and the power is turned on again.
  - During the update, do not turn off, or disconnect and reconnect the USB storage device.
  - "Completed!" is displayed when the update is complete.
8. Disconnect the USB storage device from the unit.
9. Press  ON/STANDBY on the main unit to turn the unit into standby mode. The process is completed and your firmware is updated to the latest version.
  - Do not use  RECEIVER on the remote controller.

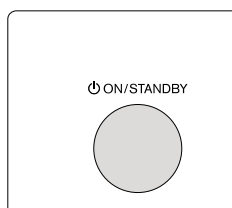

### ■ If an Error Message is Displayed

When an error occurs, "\*\_\* Error!" is displayed on the unit. ("\*" represents an alphanumeric character.) Check the following:

#### Error Code

- **\*-01, \*-10:**  
USB storage device not found. Check whether the USB storage device or USB cable is correctly inserted to the USB port of the unit.  
Connect the USB storage device to an external power source if it has its own power supply.
- **\*-05, \*-13, \*-20, \*-21:**  
The firmware file is not present in the root folder of the USB storage device, or the firmware file is for another model. Retry from the download of the firmware file.
- **Others:**  
First disconnect then reconnect the AC power cord, and then retry from the beginning.



## Troubleshooting

### Before starting the procedure

Problems may be solved by simply turning the power on/off or disconnecting/connecting the power cord, which is easier than working on the connection, setting and operating procedure. Try the simple measures on both the unit and the connected device. If the problem is that the video or audio is not output or the HDMI linked operation does not work, disconnecting/connecting the HDMI cable may solve it. When reconnecting, be careful not to wind the HDMI cable since if wound the HDMI cable may not fit well. After reconnecting, turn off and on the unit and the connected device.

- The AV receiver contains a microPC for signal processing and control functions. In very rare situations, severe interference, noise from an external source, or static electricity may cause it to lockup. In the unlikely event that this happens, unplug the power cord from the wall outlet, wait at least 5 seconds, and then plug it back in.
- Onkyo is not responsible for damages (such as CD rental fees) due to unsuccessful recordings caused by the unit's malfunction. Before you record important data, make sure that the material will be recorded correctly.

### Resetting the unit

Resetting the unit to the status at the time of shipment may solve the problem. If the measures mentioned in the troubleshooting do not solve the problem, reset the unit with the following procedure. If you reset the unit status, your preferences will be reset to the defaults. Note them down before starting reset.

#### ■ How to reset

1. While holding down CBL on the main unit (note that step 2 must be performed with this button pressed down)
2. Press  $\odot$ ON/STANDBY on the main unit. "Clear" is appeared on the display and the unit will enter standby mode.

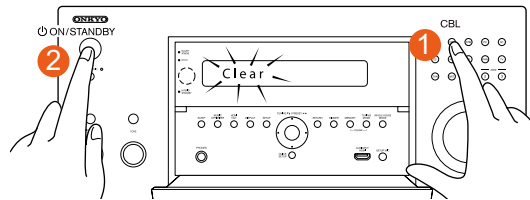

#### ■ How to reset the remote controller

1. While holding down ① RCV on the remote controller (note that step 2 must be performed with this button pressed down)
2. Press and hold ② Q for 3 or more seconds until the ③ remote indicator stays lit. Within 30 seconds, press ① RCV again.

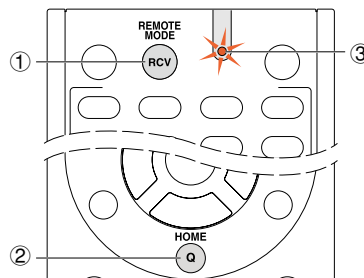

### Power

#### ■ Cannot turn on the unit

- Make sure that the power cord is properly plugged into the wall outlet.
- Unplug the power cord from the wall outlet, wait 5 seconds or more, then plug it in again.

#### ■ The unit turns off unexpectedly

- The AV receiver will automatically enter standby mode when Auto Standby or Sleep Timer is set and launched.
- The protection circuit may have been activated. If this is the case, when you turn the unit on again, "AMP Diag Mode" will appear on the main unit's display. The unit will then enter a mode that detects abnormal conditions. If no problems are detected, "AMP Diag Mode" will disappear and the unit will return to a normal state. If "CHECK SP WIRE" appears on the display, the speaker cables may be short-circuited. Turn the unit off, and check to see if the cable core of any of the speaker cables is in contact with that of another speaker cable or with the rear panel. After that, turn the unit on again. If "NG" appears, unplug the power cord immediately and contact your Onkyo dealer.

**WARNING:** If smoke, smell or abnormal noise is produced by the unit, unplug the power cord from the wall outlet immediately and contact the dealer or Onkyo Support.



## Audio

- Make sure that the speaker setup microphone is not still connected.
- Check that the output jack of the connected equipment and the input jack of this unit are connected correctly.
- Make sure that none of the connecting cables are bent, twisted, or damaged.
- If the MUTING indicator on the display flashes, press MUTING on the remote controller to unmute the unit.
- While headphones are connected to the PHONES jack, no sound is output from the speakers.
- If "Audio Select" - "PCM Fixed Mode" is set to "On", set it to "Off".

If the above does not solve the problem, check the following.

### ■ There is no sound from the television

- The input selector of this unit needs to be in the position that corresponds to the jack where the television is connected.
- If your TV does not support ARC, you need, in addition to the HDMI OUT jack connection, a digital optical cable connection between the digital audio out optical jack of the TV and the DIGITAL IN OPTICAL jack of the unit or an analog audio cable connection between the audio output jack of the TV and the AUDIO IN TV jack of the unit.

### ■ There is no sound from the connected player

- The input selector of this unit needs to be in the position that corresponds to the jack where the player is connected.
- Check the digital audio output setting on the connected component. On some game consoles, such as those that support DVD, the default setting is off.
- With some DVD-Video discs, you need to select an audio output format from a menu.

### ■ One of the speakers produces no sound

- Make sure that the polarity of the speaker cables is correct, and that no bare wires are in contact with the metal part of speaker terminals.
- Make sure that the speaker cables are not shorting.
- Make sure the speakers are configured correctly.

### ■ Only the front speakers produce sound

- When the Stereo or Mono listening mode is selected, only the front speakers and subwoofer produce sound.

### ■ Only the center speaker produces sound

- If you use the Dolby Surround listening mode with a mono source, such as an AM radio station or mono TV program, the sound is concentrated in the center speaker.

### ■ The surround speakers produce no sound

- When the T-D (Theater-Dimensional), Stereo or Mono listening mode is selected, the surround speakers produce no sound.
- Depending on the source and current listening mode, not much sound may be produced by the surround speakers. Try selecting another listening mode.

### ■ The center speaker produces no sound

- When the Stereo or Mono listening mode is selected, the center speaker produces no sound.

### ■ No sound from the back speakers and height speakers

- Depending on the source and current listening mode, not much sound may be produced by the speakers. Try selecting another listening mode.

### ■ The subwoofer produces no sound

- When the input signal does not include a subwoofer audio element (LFE), the subwoofer may not produce sound.

### ■ Volume is low

- Check the volume. The volume level is adjustable between Min, 0.5 to 99.5, Max (100). A level of around 60 is normal in a domestic environment.

### ■ There is no sound from a connected turntable

- If your turntable uses an MC cartridge, you must connect an audio equalizer and either an MC head amp or an MC transformer.

### ■ Noise can be heard

- Using cable ties to bundle audio cables with power cords, speaker cables, etc. may degrade the audio performance, so refrain from doing it.
- An audio cable may be picking up interference. Try repositioning your cables.

### ■ The sound changes when I connect my headphones

- When a listening mode other than Direct, Pure Audio or Mono is selected, connecting a headphone automatically selects Stereo.

### ■ About DTS signals

- When DTS program material ends and the DTS bitstream stops, the unit remains in DTS listening mode and the dts indicator remains on. This is to prevent noise when you use the pause, fast forward, or fast reverse function on your player. If you switch your player from DTS to PCM, you may not hear any sound because the unit does not switch formats immediately. In such case, you should stop your player for about 3 or more seconds and then resume playback.
- With some CD and LD players, you will not be able to playback DTS material properly even though your player is connected to a digital input on the unit. This is usually because the DTS bitstream has been processed (e.g., output level, sampling rate, or frequency response changed) and the unit does not recognize it as a genuine DTS signal. In such cases, you may hear noise.
- When playing DTS program material, using the pause, fast forward, or fast reverse function on your player may produce a short audible noise. This is not a malfunction.

### ■ The beginning of audio received by an HDMI IN cannot be heard

- Since it takes longer to identify the format of an HDMI signal than it does for other digital audio signals, audio output may not start immediately.

### ■ The volume has suddenly dropped

- If this unit is used for a long time even after the internal temperature of this unit exceeds a certain threshold, the volume may be lowered automatically to protect the circuitry.

### ■ Cannot increase volume when playing AirPlay, Spotify, or DLNA

- You can set the upper limit for the volume in "WEB Setup". After pressing the RCV button on the remote controller, press the SETUP button, select "6. Hardware" - "Network" - "IP Address" to display the IP address. After connecting the unit and your PC or smartphone to the same router, open the browser, enter the IP address of the unit in the URL field to display the "WEB Setup" screen. Change the value for "Max Volume" in "WEB Setup" and click "Save".





## Listening Mode

- When listening to Dolby Digital and/or DTS sound, digital connection is necessary.
- Check the digital audio output setting on the connected component. On some game consoles, such as those that support DVD, the default setting is off.
- After pressing RCV on the remote controller, repeatedly press DISPLAY to switch the display on the main unit. You can see the input format.

If the above does not solve the problem, check the following.

### ■ Cannot select a desired listening mode

- Depending on the connecting status of the speaker, some listening modes may not be selected. Check the details in "Selectable Listening Modes" section.

### ■ There is no sound with Dolby Atmos

- You need to have either back speakers or height speakers connected. After connecting each of the speakers, make sure the connection settings in "Configuration" - "Speaker Channels" are correct.
- Dolby Atmos play is only possible when the input signal is Dolby Atmos.

### ■ Cannot select the Pure Audio listening mode

- The Pure Audio listening mode cannot be selected while Zone 2/Zone 3 is on.

## Video

- Check that the output jack of the connected equipment and the input jack of this unit are connected correctly.
- Make sure that none of the connecting cables are bent, twisted, or damaged.
- Make sure the switching of input screens is proper at the monitor side such as a TV.

If the above does not solve the problem, check the following.

### ■ There is no picture from a source connected to an HDMI IN

- The input selector of this unit needs to be in the position that corresponds to the jack where the player is connected.
- While the Pure Audio listening mode is selected only video signals input through HDMI IN can be output.
- Check if "Resolution Error" is displayed on the main unit display when video input via HDMI IN jack is not displayed. In this case, the TV does not support the resolution of the video input from the player. Change the setting on the player.
- Reliable operation with an HDMI-to-DVI adapter is not guaranteed. In addition, video signals from a PC are not supported.
- Try switching off the Deep Color function. To turn off the Deep Color function, while holding down STM on the main unit, press  ON/STANDBY repeatedly until "Deep Color:Off" appears on the display. To reactivate the Deep Color function, repeat the above described step until "Deep Color:On" is appeared on the display.

### ■ There is no picture from a source connected to the composite video/component video input jack

- If multiple videos are input into one input system, HDMI signal output is prioritized. In this case, to output composite video/component video, set "HDMI Input" to "-----".

### ■ Images flicker

- It is possible that the resolution of the player is not compatible with the TV's resolution. If you have connected the player to this unit with an HDMI cable, try changing the output resolution on the player. There also may be an improvement if you change the screen mode on the TV.

## Linked operation

### ■ There is no HDMI linked operation with CEC-compliant equipment such as a television

- Set the HDMI CEC (RIHD) setting of the unit to On. Press RCV and then SETUP on the remote controller, select "6. Hardware" - "HDMI" - "HDMI CEC (RIHD)" and set to On.
- It is also necessary to make the HDMI linked system settings on the CEC-compliant equipment. Check the operating instructions.

### ■ The RI functions do not work

- To use RI, you must make an RI connection and an analog audio connection (RCA) between the component and AV receiver.
- While Zone 2/Zone 3 is selected, the RI functions do not work.

## Tuner

### ■ Reception is noisy, FM stereo reception is noisy, or the "FM STEREO" indicator does not stay lit

- Re-check the antenna connection.
- Relocate your antenna.
- Move the unit away from your TV or PC.
- Passing cars and airplanes can cause interference.
- Concrete walls weaken radio signals.
- Listen to the station in mono.
- When listening to an AM station, operating the remote controller may cause noise.



## BLUETOOTH function

- Try plugging/unplugging the power of the unit and try turning on/off the BLUETOOTH-enabled device. Restartup of the BLUETOOTH-enabled device may be effective.
- The BLUETOOTH-enabled devices must support the A2DP profile.
- Near components such as microwave oven or cordless phone, which use the radio wave in the 2.4 GHz range, a radio wave interference may occur, which disables the use of this unit.
- If there is a metallic object near the unit, BLUETOOTH connection may not be possible as the metal can effect on the radio wave.

If the above does not solve the problem, check the following.

### ■ Cannot connect with this unit

- The BLUETOOTH function of the BLUETOOTH-enabled device is not enabled. Refer to the user manual of the BLUETOOTH-enabled device for how to enable the BLUETOOTH function.
- When building a BLUETOOTH connection between this unit and your BLUETOOTH-enabled device for the first time, if the connection fails, select "6.Hardware" - "Bluetooth", execute "Clear" in "Pairing Information", turn off and then on again your BLUETOOTH-enabled device to clear the device name, and build the BLUETOOTH connection again.
- If the wireless LAN and BLUETOOTH connections are used at the same time, try connecting the ETHERNET port and router with the Ethernet cable after selecting "6. Hardware" - "Network" and changing "Wi-Fi" to "Off (Wired)" for a better connection.

### ■ Music playback is unavailable on the unit even after successful BLUETOOTH connection

- When the audio volume of your BLUETOOTH-enabled device is set low, the playback of audio may be unavailable. Increase the volume of the BLUETOOTH-enabled device.
- Depending on the BLUETOOTH-enabled device, Send/Receive selector switch may be provided. Select Send mode.
- Depending on the characteristics or specifications of your BLUETOOTH-enabled device, playback on the unit is not guaranteed.

### ■ Sound is interrupted

- Problem may be occurring at the BLUETOOTH-enabled device. Check the information on a web page.

### ■ The audio quality is poor after connection with a BLUETOOTH-enabled device

- The BLUETOOTH reception is poor. Move the BLUETOOTH-enabled device closer to the unit or remove any obstacle between the BLUETOOTH-enabled device and this unit.

### ■ "Bluetooth" - "Auto Reconnect" does not work

- This may not work with some BLUETOOTH-enabled devices.  
In that case, pair the unit and the BLUETOOTH-enabled device and then play again.

## Network function

- Network services become selectable after the network starts up even if they cannot be selected first. It may take about a minute to start up.
- When NET is blinking, the AV receiver is not properly connected to the home network.
- Try unplugging the power supply of this unit and the router, and then plugging in again. Try rebooting the router.

If the above does not solve the problem, check the following.

### ■ Cannot access the Internet radio

- Certain network service or contents available through the unit may not be accessible in case the service provider terminates its service.
- Make sure that your modem and router are properly connected, and make sure they are both turned on.
- Make sure that the router LAN side port is properly connected to the AV receiver.
- Make sure that connecting to Internet from other components is possible. If connecting is not possible, turn off all components connected to the network, wait for a while, and then turn on the components again.
- If a specific radio station is unavailable for listening, make sure the registered URL is correct, or whether the format distributed from the radio station is supported by this unit.
- Depending on ISP, setting the proxy server is necessary.
- Make sure that the used router and/or modem is supported by your ISP.

### ■ Cannot access the network server

- This unit needs to be connected to the same router as the network server.
- Make sure your network server has been started up.
- Make sure your network server is properly connected to the home network.
- Make sure your network server is correctly set.
- Make sure that the router LAN side port is properly connected to the AV receiver.

### ■ Playback stops while listening to music files on the network server

- Make sure the network server is compatible with this unit.
- When the PC is serving as the network server, try quitting any application software other than the server software (Windows Media® Player 12 etc.).
- If the PC is downloading or copying large files, the playback may be interrupted.

## USB storage device

### ■ USB storage device is not displayed

- Check whether the USB storage device or USB cable is correctly inserted to the USB port of the unit.
- Remove the USB storage device from the AV receiver once, and then try re-connecting.
- Performance of the hard disk that receive power from the USB port of the unit is not guaranteed.
- Depending on the type of format, the playback may not be performed normally. Check the type of the file formats that is supported.
- This unit supports FAT16 and FAT32 file system formats for USB storage devices.
- USB storage devices with security functions may not be played.



## Wi-Fi (Wireless LAN) Network

- Try plugging/unplugging the power supply of wireless LAN router and the unit, check the wireless LAN router power-on status, and try reboot of the wireless LAN router.

If the above does not solve the problem, check the following.

- **Cannot access to Wi-Fi (Wireless LAN) network**
  - The wireless LAN router setting may be switched to Manual. Return the setting to Auto.
  - Try the manual set-up. The connection may succeed.
  - When the wireless LAN router setting is at stealth mode (mode to hide the SSID key) or when ANY connection is off, the SSID is not displayed. Change the setting and try again.
  - Check if SSID and encryption settings (WEP, etc.) are correct. Make sure the network settings of the unit is properly set.
  - Connection to an SSID that includes multi-byte characters is not supported. Name the SSID of the wireless LAN router using single-byte alphanumeric characters only and try again.
- **Playback is interrupted and communication does not work**
  - Cannot receive signals due to a bad connection. Shorten the distance from wireless LAN access point or remove obstacles for a good visibility, and try again. Place the unit away from microwave ovens or other access points. It is recommended to place the Wi-Fi router (access point) and the unit in the same room.
  - If there is a metallic object near the unit, wireless LAN connection may not be possible as the metal can effect on the radio wave.
  - 2.4 GHz band for wireless LAN may not be enough. Connect ETHERNET port of the unit and the router via an Ethernet cable after selecting "6. Hardware" - "Network" and changing "Wi-Fi" to "Off (Wired)".
  - When other wireless LAN devices are used near the unit, several issues such as interrupted playback and communication may occur. You can avoid these issues by changing the channel of your Wi-Fi router. For instructions on changing channels, see the instruction manual provided with your Wi-Fi router.

## Multi-zone Function

- **There is no zone output from the connected player**
  - When outputting audio from an external player, in Zone 2, you can play equipment connected to any of the HDMI IN1 to IN5 jacks, DIGITAL IN COAXIAL/OPTICAL jacks, or AUDIO IN jacks. Note that only analog or 2-channel PCM audio signals can be played and that some players require audio output setting. Only players connected to the AUDIO IN jack by analog connection can be played in Zone 3.
  - When the NET input source is selected, DSD and Dolby TrueHD audio signals cannot be output to Zone 2/Zone 3.

## Remote Controller

- Make sure that the batteries are installed with the correct polarity.
- Install new batteries. Do not mix different types of batteries, or old and new batteries.
- Make sure that the remote controller is not too far away from the unit, and that there is no obstruction between the remote controller and the remote control sensor of the unit.
- Make sure that the unit is not subjected to direct sunshine or inverter-type fluorescent lights. Relocate if necessary.
- If the unit is installed in a rack or cabinet with colored-glass doors or if the doors are closed, the remote controller may not work reliably.

If the above does not solve the problem, check the following.

- **The remote controller does not work**
  - Before operating this unit with the remote controller, be sure to press RCV.
- **Operating other Onkyo component by using a RI remote control code is not available**
  - Make sure that the Onkyo component is properly connected with RI cable. When RI cable is used for connection, make sure to connect analog audio cable as well. (Connecting only an RI cable will not be enough.)
  - Make sure you have selected the correct remote controller mode.
  - When the RI remote control code is input, point the remote controller at remote control sensor of the unit.

- Make sure that the input display is correctly set.
- Input the RI remote control code again.

- **Cannot operate Onkyo components (ones without RI connection) and components of other makers**

- Operate the remote controller by setting toward the light receiving section of each component.
- When using the remote controller to control other manufacturers' AV components, some buttons may not work as expected. Also, some components may not operate at all.
- Make sure you have selected the correct remote controller mode.
- Make sure you have entered the correct remote control code.
- Make sure to set the same ID on both the unit and remote controller.
- Input a correct remote control code again. If there are several codes, try each code.

## Display and OSD

- **The display does not light**

- Make sure that Dimmer function is not working. Press DIMMER button and change the brightness level of the display.
- The display is turned off when the Pure Audio listening mode is selected or Pure Analog Playback function is in use.

- **The on-screen menus do not appear**

- On your TV, make sure that the video input to which this unit is connected is selected.
- Set "TV Out" - "Impose OSD" to "On".
- (European, Australian and Asian models) The guidance displayed on the TV screen (OSD) are not displayed when the OSD language is set to Chinese if the input selector is "NET" or "BLUETOOTH". Operate by confirming the display on the main unit. Note that the display on the main unit does not support the display of Chinese characters. Characters that cannot be displayed are replaced with asterisks (\*).



## RI Dock

- Make sure the unit is turned on, the correct input source is selected, and the volume is turned up.
- Make sure cord and cable plugs are properly plugged in.
- Make sure your iPod/iPhone is properly inserted in the Dock. If your iPod/iPhone is in a case, it may not connect properly to the Dock. Always remove your iPod/iPhone from the case before inserting it into the Dock. Try reconnecting your iPod/iPhone.
- Make sure your iPod/iPhone is actually playing.

If the above does not solve the problem, check the following.

### ■ There is no sound

- Try resetting your iPod/iPhone.

### ■ There is no video

- Make sure the correct input is selected on your TV or the unit.
- Make sure that your iPod/iPhone model's TV OUT setting is set to On.
- Some versions of the iPod/iPhone do not output video.

### ■ The AV receiver's remote controller does not control your iPod/iPhone

- The iPod/iPhone cannot be operated while it is displaying the Apple logo.
- Make sure you have selected the correct remote controller mode.
- When you use the AV receiver's remote controller, point it toward this unit.
- Before operating with the remote controller, you may need to play on your iPod/iPhone to make the input selector be recognized.
- Depending on your iPod/iPhone model and generation, some buttons may not work as expected.
- Try resetting your iPod/iPhone.

### ■ The unit unexpectedly selects your iPod/iPhone as the input source

- Always pause iPod/iPhone playback before selecting a different input source. If playback is not paused, the Direct Change function may select your iPod/iPhone as the input source by mistake during the transition between tracks.

## Others

### ■ Strange noises can be heard from the unit

- If you have connected another unit to the same wall outlet as this unit, this noise may be an effect from the other unit. If the symptoms improve by unplugging the power cord of the other unit, use different wall outlets for this unit and the other unit.

### ■ When performing Automatic Speaker Setup, the measurement fails and the message "Ambient noise is too high." is displayed

- This can be caused by a malfunction in your speaker unit. Check if the unit produces normal sounds.

### ■ The Late Night function does not work

- Make sure the source material is Dolby Digital, Dolby Digital Plus, Dolby TrueHD, or DTS.

### ■ Re-EQ, Re-EQ(THX) function does not work

- This function can be used in the following listening modes: Dolby Digital, Dolby Digital Plus, Dolby TrueHD, Multichannel, DTS, DTS-ES, DTS 96/24, DTS-HD High Resolution Audio, DTS-HD Master Audio, DTS Express, DSD.
- In Re-EQ(THX), the following listening modes can be used: THX Cinema, THX Surround EX, and THX Select2 Cinema.

### ■ How do I change the language of a multiplex source

- Select "Main" or "Sub" for "3. Audio Adjust" - "Multiplex/Mono" - "Multiplex Input Channel".

### ■ Cannot connect to the AV receiver from a Web browser

- Make sure that the IP address of the AV receiver is correctly input to the Internet browser.
- When DHCP is used for allocating the IP address, the IP address of this AV receiver may have been changed.
- Make sure that both AV receiver and PC are properly connected to the network.

### ■ Power consumption in standby mode

- In the following cases, the power consumption in standby mode may reach up to a maximum of 16.2 W:
  - When "USB Power Out at Standby", "Network Standby" or "Bluetooth Wakeup" is set to "On".
  - When "HDMI CEC (RIHD)" is set to "On". (Depending on the TV status, this unit will enter normal standby mode)
  - The "HDMI Standby Through" setting is set to other than "Off".



## Reference Information

### Linked Operation with CEC-compatible Components

Link operation with a product conforming to the CEC of the HDMI standard.  
Note that linked operation is not always guaranteed with all CEC devices.

**Operation has been confirmed on the following devices (as of February 2015).**

TV (Random order):

- Toshiba TV sets
- Sharp TV sets

Players/Recorders (Random order):

- Onkyo and Integra RIHD-compatible players
- Toshiba players and recorders
- Sharp players and recorders (only when used together with Sharp TV sets)

**Caution:** For linking functions to work properly, do not connect more RIHD-compatible components than the quantities specified below, to the HDMI jacks. Linking functions are not guaranteed when more RIHD-compatible components than the below mentioned quantities are connected. Furthermore, do not connect the AV receiver to another AV receiver/AV amplifier via HDMI.

- Blu-ray Disc/DVD players: up to 3.
- Blu-ray Disc/DVD recorders: up to 3.
- Cable TV tuner, terrestrial digital tuner, and satellite broadcasting tuner: up to 4 units.

### Checking whether the HDMI Linked Operation Settings Are Enabled

1. Turn on the power of all connected components.
2. Turn off the power of the TV, and confirm that the power of the connected components is turned off automatically with the link operation.
3. Turn on the power of the Blu-ray Disc/DVD player/recorder.
4. Start playback on the Blu-ray Disc/DVD player/recorder, and verify the following:
  - The AV receiver automatically turns on, and selects the input to which the Blu-ray Disc/DVD player/recorder is connected.
  - The TV automatically turns on, and selects the input to which the AV receiver is connected.
5. Following the instruction manual of the TV, select "Use the TV speakers" from the menu screen of the TV, and confirm that the audio is output from the speakers of the TV, and not from the speakers connected to the AV receiver.
6. Select "Use the speakers connected from the AV receiver" from the menu screen of the TV, and confirm that the audio is output from the speakers connected to the AV receiver, and not from the TV speakers.

#### Caution:

- Even if you set to output audio on the TV speakers, audio will be output from the speakers connected to the AV receiver when you adjust the volume or switch the input on the AV receiver. To output audio from the TV speakers, redo the corresponding operations on the TV.
- In case of an RIHD connection with RI audio control compatible components, do not connect the RI cable at the same time.
- On the TV, when you select anything other than the HDMI jack to which the AV receiver is connected, the input on the AV receiver will be switched to "TV".
- The AV receiver will automatically power on in conjunction when it determines it to be necessary. Even if the AV receiver is connected to an RIHD compatible TV or player/recorder, it will not power on if it is not necessary. It may not power on in conjunction when the TV is set to output audio from the TV.
- Linked system functions with the AV receiver may not work depending on the component model connected. In such cases, operate the AV receiver directly.
- When the player/recorder cannot be operated with the remote

controller of the AV receiver, the corresponding component may not be programmed to support the remote controller operation of CEC. Program the remote control code of the component maker to the remote controller for using.

### About HDMI

HDMI (High-Definition Multimedia Interface) is a digital interface standard for connecting TVs, projectors, Blu-ray Disc/DVD players, set-top boxes, and other video components. Until now, several separate video and audio cables have been required to connect AV components. With HDMI, a single cable can carry control signals, digital video and digital audio (2-channel PCM, multichannel digital audio, and multichannel PCM).

The HDMI video stream (i.e., video signal) is compatible with DVI (Digital Visual Interface) (\*1), so TVs and displays with a DVI input can be connected by using an HDMI-to-DVI adapter cable. (This may not work with some TVs and displays, resulting in no picture.)

This unit supports HDCP (High-bandwidth Digital Content Protection) (\*2), so it can display picture only on HDCP-compatible components.

HDMI of the unit supports the following functions. Audio Return Channel, 3D, x.v.Color, Deep Color, LipSync, 4K (Passthrough)

#### Audio Formats Supported by The Unit:

- 2-channel linear PCM (32 - 192 kHz, 16/20/24 bit)
- Multichannel linear PCM (up to 7.1 ch, 32 - 192 kHz, 16/20/24 bit)
- Bitstream (Dolby Atmos, Dolby Digital, Dolby Digital Plus, Dolby TrueHD, DTS, DTS-HD High Resolution Audio, DTS-HD Master Audio)
- DSD

Your Blu-ray Disc/DVD player must also support HDMI output of the above audio formats.

#### About Copyright Protection:

The unit supports Revision 1.4 and Revision 2.2 (HDMI OUT MAIN/SUB and HDMI IN1 to 5 only) of the HDCP (High-bandwidth Digital Content Protection) (\*2), a copy-protection system for digital video signals. Other devices connected to the unit must also support HDCP.

\*1 DVI (Digital Visual Interface): The digital display interface standard set by the DDWG (\*3) in 1999.



- \*2 HDCP (High-bandwidth Digital Content Protection): The video encryption technology developed by Intel for HDMI/DVI. It is designed to protect video content and requires a HDCP-compatible HDMI/DVI receiver to display the encrypted video.
- \*3 DDWG (Digital Display Working Group): Led by Intel, Compaq, Fujitsu, Hewlett Packard, IBM, NEC, and Silicon Image, this open industry group's objective is to address the industry's requirements for a digital connectivity specification for high-performance PC and digital displays.

**Caution:**

- There are some content that can be played only with HDCP Rev. 2.2 compatible devices. To play such content, connect an HDCP Rev.2.2 compatible TV or player to the HDMI OUT MAIN/SUB jack or HDMI IN1 to 5 jacks of the unit.
- The HDMI video stream (i.e., video signal) is compatible with DVI (Digital Visual Interface), so TVs and displays with a DVI input can be connected by using an HDMI-to-DVI adapter cable. (Note that DVI connections only carry video, so you will need to make a separate connection for audio.) However, reliable operation with such an adapter is not guaranteed. In addition, video signals from a PC are not supported.
- The HDMI audio signal (sampling rate, bit length, etc.) may be restricted by the connected source component. If the picture is poor or there is no sound from a component connected via HDMI, check its setup. Refer to the connected component's instruction manual for details.

**Home network (LAN)**

The connection of several components via cables enabling the mutual communication is called a network.

At households, many families create (generally, the term "build" is used) a network to connect PC and gaming machines to the Internet and to exchange data between PC.

The network established in a relatively narrow area such as one household is called a LAN (Local Area Network). In this manual, a term "home network" (network for a family) is used instead of "LAN", so this LAN becomes more familiar.

By connecting this unit with the network server such as a PC, playing music files in the network server (in the PC) is possible. Moreover, by connecting to the Internet, listening to the Internet radio is also possible.

This unit, PC, and Internet are not directly connected.

When connecting with a PC and/or Internet, several components (network components) are necessary.

**Components necessary for establishing a home network (LAN):**

Components necessary for the home network (LAN) for using the NET function of this unit are as follows.

**■ Router**

A router is a device that controls information (data) flow between the unit, PC, and the Internet.

As a network term, the flow of information (data) is called "traffic". The router has a role to control the information flow as the traffic control, between connected components.

- A router with a built-in 100Base-TX switch is recommended.
- In addition, if your router has the DHCP function, facilitating the network setting becomes possible.
- Some routers have a built-in modem, and some Internet Service Providers (ISP) require you to use specific routers.

Please consult your ISP or PC dealer if you are unsure.

**■ CAT5 Ethernet cable**

The Ethernet cable is a cable that actually connects components that comprise the network. There are straight type and cross type Ethernet cables.

- Use a shielded CAT5 Ethernet cable (straight-type) to connect the unit to your home network. Consult your cable store for details of Ethernet cable.

**■ Network server (When PC etc./network server is used)**

Component that stores music files and provides the unit with those files at the time of playback.

- Requirements for use with this unit depend on the component that is used as a network server.
- Conditions for pleasant playback of music files on the unit depend on the using network server (PC performance). See instruction manuals of using components.

**■ Modem (when Internet radio is used)**

Device that connects home network (LAN) and Internet. There are many kinds of modems depending on the forms of Internet connection.

In addition, when connecting to the Internet, it is required to conclude an agreement with a company that provides Internet connection service, called ISP (Internet Service Provider).

Use a modem that is recommended by your ISP company for the Internet connection.

There are some devices that have both router and modem functions.

Within above network components, prepare a router, Ethernet cable, and network server when the NET function "network server" is used.

For enjoying the NET function "Internet radio", it is necessary to use the router, Ethernet cable, and modem (and agreement with ISP).



## Server Requirements

### ■ Server playback

This unit can play digital music files stored on a PC or media server and supports the following technologies:

- Windows Media® Player 11
- Windows Media® Player 12
- DLNA-certified media server

The network server must be connected to the same network as this unit.

Up to 20,000 folders can be displayed, and folders may be nested up to 16 levels deep.

**Caution:** Depending on the media server, the unit may not recognize it, or may not be able to play its music files.

### ■ Remote playback

Remote playback is the function that enables this unit to play music files saved in different components by operating the DLNA-compliant controller component and PC in the home network.

- Windows Media® Player 12
  - DLNA-certified (within DLNA Interoperability Guidelines version 1.5) media server or controller component.
- \* The setting varies depending on the media server or controller components. Refer to your components' instruction manual for details.

If the operating system of your personal PC is Windows® 8/Windows® 7, Windows Media® Player 12 is already installed. For more information, see the Microsoft web site.

## USB Storage Device Requirements

- USB Mass Storage device class (but not always guaranteed).
- FAT16 or FAT32 file system format.
- If the USB storage device has been partitioned, each section will be treated as an independent device.
- Each folder can contain up to 20,000 tracks, and folders can be nested up to 16 levels deep.
- USB hubs and USB storage devices with hub functions are not supported. Do not connect these devices to the unit.

### Caution:

- If the media you connect is not supported, the message "No Storage" will be displayed.
- Sound files that are protected by copyright cannot be played.
- When the USB audio player and this unit are connected, the audio player screen and the screen of the unit may be different. In addition, control functions of the audio player (classifying and sorting music files and adding information, etc.) are not available on this unit.
- Do not connect a PC to the USB port of the unit. Inputting sound to the USB port of the unit from a PC is not possible.
- Media inserted to the USB card reader may not be available in this function.
- Some USB storage devices and its contents may require some time to be read.
- Depending on the USB storage device, proper reading of the contents and proper supply of the power supply may not be possible.
- Onkyo accepts no responsibility whatsoever for the loss or damage to data stored on a USB storage device when that device is used with this unit. We recommend that you back up your important music files beforehand.
- Performance of the hard disk that receive power from the USB port of the unit is not guaranteed.
- If you connect a USB hard disk drive to the USB port of the unit, we recommend that you use its AC adapter to power it.
- When an audio player that are operated with batteries is used, make sure that the batteries have enough remaining power.
- This unit does not support USB storage devices with security functions.

## Supported Audio Formats

- For server playback and playback from a USB storage device, this unit supports the following music file formats.
- Music files of the following formats that can be played depend on the network server. For example, when using Windows Media® Player 12, not all music files in the PC can be played. The music files that can be played are the ones registered to the Windows Media® Player 12 library.
- Variable bit-rate (VBR) files are supported. However, playback times may not be displayed correctly.
- This unit supports the gapless playback of the USB storage device in the following conditions. When WAV, FLAC and Apple Lossless files are continuously played back with the same format, sampling frequency, channels and quantization bit rate.
- Remote playback does not support the gapless playback.
- For playback via wireless LAN, the sampling rate of 88.2 kHz or higher, DSD and Dolby TrueHD are not supported.

### Caution:

- With remote playback on this unit the following formats are not supported:
  - FLAC, Ogg Vorbis, DSD and Dolby TrueHD.

### ■ MP3 (.mp3/.MP3)

- Supported formats: MPEG-1/MPEG-2 Audio Layer 3
- Supported sampling rates: 8 kHz, 11.025 kHz, 12 kHz, 16 kHz, 22.05 kHz, 24 kHz, 32 kHz, 44.1 kHz, 48 kHz
- Supported bitrates: Between 8 kbps and 320 kbps. Incompatible files cannot be played.

### ■ WMA (.wma/.WMA)

**WMA stands for Windows Media Audio and is an audio compression technology developed by Microsoft Corporation. Audio can be encoded in WMA format by using Windows Media® Player.**

- Supported sampling rates: 8 kHz, 11.025 kHz, 16 kHz, 22.05 kHz, 32 kHz, 44.1 kHz, 48 kHz
- Supported bitrates: Between 5 kbps and 320 kbps. Incompatible files cannot be played.
- WMA Pro/Voice formats are not supported.



**WMA Lossless (.wma/.WMA)**

- Supported sampling rates: 44.1 kHz, 48 kHz, 88.2 kHz, 96 kHz
- Quantization bit: 16 bit, 24 bit

**WAV (.wav/.WAV)**

WAV files contain uncompressed PCM digital audio.

- Supported sampling rates: 8 kHz, 11.025 kHz, 12 kHz, 16 kHz, 22.05 kHz, 24 kHz, 32 kHz, 44.1 kHz, 48 kHz, 64 kHz, 88.2 kHz, 96 kHz, 176.4 kHz, 192 kHz
- Quantization bit: 8 bit, 16 bit, 24 bit
  - \* For playback from a USB storage device, sampling rates of 176.4 kHz and 192 kHz are not supported.
  - \* For playback from a USB storage device, 5.1 ch is not supported.

**AAC****(.aac/.m4a/.mp4/.3gp/.3g2/.AAC/.M4A/.MP4/.3GP/.3G2)**

- Supported formats: MPEG-2/MPEG-4 Audio
- Supported sampling rates: 8 kHz, 11.025 kHz, 12 kHz, 16 kHz, 22.05 kHz, 24 kHz, 32 kHz, 44.1 kHz, 48 kHz, 64 kHz, 88.2 kHz, 96 kHz
- Supported bitrates: Between 8 kbps and 320 kbps. Incompatible files cannot be played.

**FLAC (.flac/.FLAC)**

**FLAC is a file format for lossless audio data compression.**

- Supported sampling rates: 8 kHz, 11.025 kHz, 12 kHz, 16 kHz, 22.05 kHz, 24 kHz, 32 kHz, 44.1 kHz, 48 kHz, 64 kHz, 88.2 kHz, 96 kHz, 176.4 kHz, 192 kHz
- Quantization bit: 8 bit, 16 bit, 24 bit
  - \* For playback from a USB storage device, sampling rates of 176.4 kHz and 192 kHz are not supported.
  - \* For playback from a USB storage device, 5.1 ch is not supported.

**Ogg Vorbis (.ogg/.OGG)**

- Supported sampling rates: 8 kHz, 11.025 kHz, 16 kHz, 22.05 kHz, 32 kHz, 44.1 kHz, 48 kHz
- Supported bitrates: Between 32 kbps and 500 kbps.
- Incompatible files cannot be played.

**LPCM (Linear PCM)**

- Supported sampling rates: 44.1 kHz, 48 kHz
- Quantization bit: 16 bit
  - \* Only for playback via DLNA.

**Apple Lossless (.m4a/.mp4/.M4A/.MP4)**

- Supported sampling rates: 8 kHz, 11.025 kHz, 12 kHz, 16 kHz, 22.05 kHz, 24 kHz, 32 kHz, 44.1 kHz, 48 kHz, 64 kHz, 88.2 kHz, 96 kHz
- Quantization bit: 16 bit, 24 bit

**DSD (.dsf/.DSF)**

- Supported sampling rates: 2.8224 MHz, 5.6448 MHz
  - \* For playback from a USB storage device, 5.6448 MHz is not supported.

**Dolby TrueHD (.vr/.mlp/.VR/.MLP)**

- Supported sampling rates: 48 kHz, 64 kHz, 88.2 kHz, 96 kHz, 176.4 kHz, 192 kHz
  - \* Only sampling rates of 48 kHz is supported for playback from USB.
  - \* Playback via DLNA is not supported.
  - \* For playback from a USB storage device, 7.1 ch is not supported.

**Radio Wave Caution**

The AV receiver uses a 2.4 GHz radio wave frequency, which is a band used by other wireless systems as 1 and 2 described below.

1. Devices which use a 2.4 GHz radio wave frequency
  - Cordless phones
  - Cordless facsimiles
  - Microwave ovens
  - Wireless LAN devices (IEEE802.11b/g/n)
  - Wireless AV equipment
  - Wireless controllers for game systems
  - Microwave oven-based health aids
  - Video transmitter
  - Specific type of external monitor and LCD display
2. Less common devices which use a 2.4 GHz radio wave frequency
  - Anti-theft systems
  - Amateur radio stations (HAM)
  - Warehouse logistic management systems
  - Discrimination systems for train or emergency vehicles

If these devices and the AV receiver are used at the same time, the audio may be undesirably stopped or disturbed due to a radio wave interference.

Suggestions for improvement

- Switch off the devices which emit the radio wave.
- Place the interfering devices away from the AV receiver.
- The AV receiver uses radio wave, and a third person can receive the wave on purpose or accidentally. Do not use the communication for important or fatal matters.
- We assume no responsibility whatsoever for any error or damage of network environment or access device resulting from the use of this apparatus. Confirm with the provider or access device maker for more information.





## Scope of Operation

Use of the AV receiver is limited to home use. (Transmission distances may be reduced depending on communication environment.)

In the following locations, poor condition or inability to receive radio waves may cause the audio to be interrupted or stopped:

- In reinforced concrete buildings or steel framed or iron framed buildings.
- Near large metallic furniture.
- In a crowd of people or near a building or obstacle.
- In a location exposed to the magnetic field, static electricity or radio wave interference from radio communication equipment using the same frequency band (2.4 GHz) as the AV receiver, such as a 2.4 GHz wireless LAN device (IEEE802.11b/g/n) or microwave oven.
- If you live in a heavily populated residential area (apartment, townhouse, etc.) and if your neighbor's microwave oven is placed near your AV receiver, you may experience radio wave interference. If this occurs, move your AV receiver to a different place. When the microwave oven is not in use, there will be no radio wave interference.

## Radio Wave Reflections

The radio waves received by the AV receiver include the radio wave coming directly from the devices and waves coming from various directions due to reflections by walls, furniture and building (reflected waves). The reflected waves (due to obstacles and reflecting objects) further produce a variety of reflected waves as well as variation in reception condition depending on locations. If the audio cannot be received properly due to this phenomenon, try moving the location of the wireless LAN device a little. Also note that audio may be interrupted due to the reflected waves when a person crosses or approaches the space between the AV receiver and the wireless LAN device.

- We assume no responsibility whatsoever for any damages resulting from the use of this apparatus except in the cases deemed acceptable under the applicable laws and regulations.
- Operation in all environment is not guaranteed for wireless LAN. The communication may not be possible or have desirable communication speed.

## Precautions

- Do not use this apparatus near an electronic device handling high-accuracy controls or weak signals. Doing so may cause an accident due to a malfunction of the device.
- Do not use this apparatus in use prohibited location such as an aircraft equipment or a hospital. Doing so may cause an accident due to a malfunction of an electronic device or an electro-medical apparatus. Follow the instructions of the medical facilities.

### ■ Electronic device which requires cautions

Hearing aid, pace maker, other medical electronic devices, fire alarm, automatic door, and other automatic control device.

When using a pace maker or other medical electronic devices, confirm with the medical electronic device maker or dealer for the effect of the radio wave.



## Reference Information

**Remote Control Codes**■ **Television (A to E)**

A.R. Systems	10037, 10556
ACCENT	10037
Acoustic Solutions	11667, 11585, 11523, 11037
Action	10650
Adcom	10625
Addison	10653, 11150
Admiral	10093
AEG	12197, 11037, 12239
Affinity	13717, 13870, 13577
Aftron	13478
Aiko	10037
Aim	10037
Akai	12676, 10812, 10037, 10672, 10208, 10714, 11523, 13067, 12414, 13183, 10178, 10556, 12197
Akiba	10037
Akito	10037
Akura	12289, 10037, 11667, 10714, 10668, 11585, 10171, 11037, 11498, 11687, 11983, 12239
Alba	12676, 11037, 10037, 10668, 10714, 11585, 13005, 13067, 13790, 11667, 12104, 12561
Alfide	10672
Alien	11037
Allstar	10037

Amstrad	10037, 10171, 11037
Anam	10037, 10650
Andersson	12676, 11585
Anitech	10037
Ansonic	10668, 10037
AOC	11589, 12769, 11365, 13720, 12014, 12087, 13790, 10093, 10178, 10625, 11150
Apex Digital	12397
Apollo	12239
Ardem	10714, 10037
Arena	10037
Ario	12397
Aristona	10556, 10037
ART	11037
Art Mito	11585, 11667
AS	11667, 11585, 11523, 11037
Asberg	10037
Astra	10037
ATD	10698
Atlantic	10037
Atvio	13636
Audiosonic	10714, 12104, 10037, 13067, 11983
Audio-Technica	10000, 10093, 10150, 11150
Audiovox	11769
Audioworld	10698
Auria	12087, 12014
Autovox	12676
Aventura	10171
Axxon	10714
Azuki	12239
B & O	10620
Baier	12239
Baird	10208

Bang & Olufsen	10620
Barco	10556
Base	10698
Basic Line	10037, 10668, 11037, 10556
Bauer	12197
Baur	10037, 10512, 10195
BBK	12098, 11523
Beaumarck	10178
Beijing	10208, 10812
Beko	10714, 12125, 10037, 12239
Bell & Howell	10017
Belson	10698, 11667
Belstar	11037
BenQ	12563, 11562, 11523
Beon	10037
Berthen	10556, 10668
Bestar	10037
Bexa	12493
BGH	14070, 14029, 10898, 12414, 12098
Black Diamond	11037
Blaupunkt	10195, 12426
Blue Sky	10714, 10037, 11037, 10668, 10556, 10625
BlueDiamond	12426
Bluetech	12561
bogo	12561
BPL	10208, 10037
Brandt	10625, 11585, 10714
Brinkmann	10037, 10668
Brionvega	10037
Britania	12414
BuBuGao	12098, 11523

Bush	11037, 10037, 12676, 10668, 10714, 13790, 13005, 11667, 11687, 11983, 10556, 12125, 10208, 11585, 12104, 10698, 11589, 12673, 12964
Byd:sign	12209
Cameron	11523
Camper	10037
Carad	11037, 10668
Carena	10037
Carrefour	10037
Cascade	10037
Casio	10037
Cathay	10037
CCE	13782, 14091, 10037
Celcus	12676, 11585
Celebrity	10000
cello	12673
Centrum	11037
Centurion	10037
Changhong	13434, 12769, 11498, 10508, 10208
Chiawin	10810
Chimei	12769
CHL	13067
Chung Hsin	11150
Chunyun	10000, 11150, 11687
Cinema	10672
Clarivox	10037
Clatronic	10037, 10714
Clayton	11037
CME	10037, 10512
CMX	13332, 13067



## Reference Information

Coby	13478, 12315, 13627
Commercial Solutions	11447
Condor	10037
Conia	11498, 11523, 11687
Conrowa	10698
Contec	10037
Cosmel	10037
CPTEC	10625
Crosley	10000
Crown	10037, 10714, 10208, 10672, 11037, 10668
Crown Mustang	10672, 10898
Crypton	11667
Currys Essentials	12486
Curtis	12855, 13577, 12466, 12352, 13895, 12397, 13636, 13382, 14035
Curtis Mathes	10093
Cyberpix	11667
Daenyx	10672
Daewoo	10634, 10037, 10672, 10556, 12098, 10178, 11150, 12125
Dansai	10037, 10208
Dantax	11037, 12676, 10714, 11667
Datsura	10208
DAWA	10037
Daytek	10672
Daytron	10037
De Graaf	10208
Decca	10037
Dell	11863
Denver	12197, 13067, 10037, 12239
Desmet	10037

Devant	12098
DGM	12239
Diamant	10037
Diamond	10698, 10672
Dick Smith Electronics	10698
Digatron	10037
Digihome	12676, 11667
Digiline	10037, 10668
Digimate	12239
Digisonic	11826
Digitor	10698, 10037
Digitrex	13067
Dikom	12561
diVision	12197, 12239
Dixi	10037
DNS	13434
Domeos	10668
Donghai	10037, 10668, 11037
Drean	10037
DSE	10698
Dual	12197, 11037, 12676, 11667, 10037, 11585, 10714
Dumont	10017
Durabrand	10171, 10178, 10714, 11037
Dux	10037
D-Vision	12197, 10037, 10556
DX Antenna	13817
Dynatron	10037
Dynex	12049
E.S.C.	10037
Easy Living	12104
ECE	10037
ECG	12197, 12125
Eiki	10735

Elbe	10037, 10556
Electroband	10000
Electrograph	11755
Electrohome	11670
Electrolux	11585
Electron	12466, 12855
Elektra	10017
Element	13559, 11687, 12183, 12964, 13907, 11886, 12256
Elfunk	11037
ELG	10037
Elin	10037
Elite	13867, 10037
Emerson	11864, 11394, 10171, 11886, 10178, 10037, 13623, 12183, 10668, 10714, 13559
e-motion	12426
Enox.	12673
Envision	11589, 11365, 12087, 12014, 11506
Epson	11379
EQD	12014, 12087
EQD Auria	12014, 12087
Erisson	13183
Erres	10037
ESA	10812, 10171
Essentials	12486
Euroman	10037
Europa	10037
Europhon	10037
Evesham Technology	11667
Evotel	12561
Excello	11037
Exquisit	10037

## ■ Television (F to J)

F&U	12676
FairTec	11585
Favi	13382
Fedders Lloyd	13639
Ferguson	10625, 11037, 13005, 10037, 12426, 10195, 11585, 12676
Fidelity	10037, 10512, 10171
Finlandia	10208
Finlux	11667, 12676, 10714, 10037, 10556
Firstline	10714, 10037, 10668, 11037, 10208, 10556
Fisher	11585, 10208
Flint	10037
Fluid	12964, 13907
Formenti	10037
Fortress	10093
Fraba	10037
Friac	10037
Frigidaire	11826
Fujimaro	11498, 11687
Fujimaru	11687
Fujitsu	10809
Fujitsu Siemens	10809
Funai	13817, 10171, 11394, 10000, 11037, 10714, 10668, 11864
Funai United	12676
Furriion	13332
Gaba	11037
Galaxi	10037
Galaxis	10037
Gateway	11755



Reference Information

GE	11447, 10178, 10735, 10625, 10093, 11454
GEC	10037
General Electric	11447, 10178, 10735, 10625, 10093, 11454
Genesis	10037
Genexxa	10037
GFM	10171, 11864, 11886
Gibraltar	10017
Gibson	11826
Gintai	11150
Godrej	11585
GoGen	12676, 11585
Goldfunk	10668
GoldStar	10178, 10037, 10714, 13183, 11150
Goodmans	10037, 11037, 10634, 11667, 10668, 11523, 11585, 11687, 11983, 10714, 10556, 10625, 12426, 12676
Gorenje	11585, 12676
Gradiente	10037
Graetz	10714
Gran Prix	12197
Granada	10037, 10208
Grandin	10037, 10714, 10668, 11037, 10556, 12125
Grundig	10195, 11223, 12125, 12239, 10556, 10037, 11523, 11667, 13067, 10672, 12561, 12676
Grunkel	11523

GVA	12098, 13067
Haier	12876, 11749, 12309, 13382, 11753, 13620, 13613, 13429, 10698, 11983, 12293, 13790, 13987, 10037, 10508
Hallmark	10178
Handic	12676
Hankook	10178
Hannspree	11826
Hanseatic	10037, 10634, 10714, 10625, 10556
Hantarex	12197, 10037
Hantor	10037
Harwood	10037
Hauppauge	10037
Havermy	10093
HB	10714
HB Ingelen	10714
H-Buster	13620, 13419
HCM	10037
Heran	11826
Herosonic	11826
Highline	10037
Hikona	11983
Hinari	10037, 10208
HiPlus	11826
Hisawa	10714
Hisense	12846, 12098, 13519, 12183, 10556, 13123, 10508, 14029, 10208, 13382

Hitachi	11643, 12676, 11576, 11585, 11037, 11691, 13317, 11667, 10634, 13639, 10037, 10679, 12170, 12846, 10150, 10178, 10508, 11150
Hitachi Fujian	10150
Hitec	10698
Hiteker	13118
Hoher	10714, 13434
Hongmei	10093
Hornophon	10037
Hua Tun	11150
Hypson	10037, 10714, 10556, 10668, 11037
Hyundai	10698, 12414, 12676, 11037, 11523
Iberia	10037
ICE	10037
iLo	11394
Imperial	10037
Indiana	10037
Ingelen	10714
Ingo Devices	12239
Inno Hit	11585, 11037
Innova	10037
Insignia	12049, 11423, 10171
Integra	11807, 13100, 13500
Inteq	10017
Interbuy	10037
Interfunk	10037, 10512
Internal	10556
Intervision	10037
Irradio	10037

IRT	10698
Isis	12676
Isukai	10037
iSymphony	13429, 13382, 13118
ITS	10037
ITT	12675, 12125, 12676, 10208, 11523
ITT Nokia	10208
ITV	10037
James	13183
Jay-tech	13067
JC Penney	10178
JCB	10000
JCM	12256
Jinfeng	10208
Jinxing	10556, 10037, 10698
JMB	12676, 10634, 10556, 12426
JTC	13067
Jubilee	10556
JVC	11774, 11653, 11601, 11818, 10653, 12321, 12271, 11428, 13650, 11670, 12676, 14070, 10650, 10093, 10508

■ Television (K to N)

Kaisui	10037
Karcher	12125, 10714
Kathrein	10556
KDS	11498, 11687
Kendo	11037, 11585, 12676, 10037
Kennex	11037



Reference Information

Kioto	10556
Kiton	10037, 10668
KLL	10037
Kneissel	10037, 10556
Kolin	11610, 10150, 11755, 10037, 11150
Kolster	10037
Konig	10037, 10512
Konka	12881, 13419, 10037, 10714
Korpel	10037
Kosmos	10037
Kunlun	10208
Kuppersbusch	12676
L&S Electronic	10714
Lavis	11037
Leader	12876
Lecson	10037
Legend	12397, 12309
Lenco	12676, 11983, 10037, 11037
Leyco	10037
LG	11840, 11860, 11423, 12731, 12182, 12358, 10178, 12362, 13941, 12424, 10037, 10714, 10017, 10556, 10698, 11753
Liberton	13183
Liesenkotter	10037
Lifetec	10668, 10037, 11037, 10714
Linetech	12676
Linsar	12676, 11667, 11585
Lloyd	13639
Lodos	11037

Loewe	10512, 10633, 10037
Logic	11585
Logik	13432, 13005, 12486, 11037, 10698, 11585, 11687
Logix	10668
Luma	10037, 11037
Lumatron	10037, 10668
Lumenio	10037
Lux May	10037
Luxor	12676, 11037, 10208
LXI	10178, 10017
Madison	10037
MAG	11687, 11498
Magnavox	13623, 11866, 12372, 11454, 11506, 10171, 11365, 11755, 11867
Magnum	10714, 10037
Manesth	10037
Manhattan	10037, 11037, 10668
Marantz	10037, 10556, 11454
Mark	10037, 10714
Marks & Spencer	12673
Mascom	12197, 12125
Masters	10037
Mastro	10698
Masuda	10037
Matsui	10037, 10195, 10208, 12486, 11037, 10714, 11667, 12676, 10556, 12561
Matsushita	10650
Maxent	11755

Maxess	12493
Meck	10698
Mediator	10037, 10556
Medion	12676, 10714, 10037, 10668, 11037, 11585, 11667, 10512, 12239, 13067, 10556, 10698, 12563
Megatron	10178
MEI	11037
Meletronic	10037, 10195, 10634, 10512, 10714
Memorex	11687, 11037, 11670, 10178, 10150
Memory	11983
Mercury	10037
Mermaid	10037
Metronic	10625
Metz	11037, 10668, 10195
MGA	10150, 10178
Micromaxx	10037, 10668, 10714, 11037
Microsonic	13419
Midland	10017
Mikomi	11585, 11667
Minato	10037
Minerva	10195
Ministry Of Sound	11667
Minoka	10037
Miray	12414, 13183, 10898
Misakai	10171

Mitsubishi Electric	11250, 12313, 10150, 10178, 10512, 11797, 10093, 10556, 10037, 11150, 11037, 11171
Mivar	10609
Moree	10037
Morgan's	10037
Moserbaer	11585
Motorola	10093
MTC	10512
MTlogic	10714, 12104
Mudan	10208
Multitec	11037, 10037, 10668
Multitech	10037
Murphy	12673
Mx Onda	11983, 11498, 11687
Myryad	10556
Mystery	13047
NAD	10037, 10178
Naiko	10037
Nakimura	10037
National	10208, 10508
Naxa	12104, 13382
NEC	11797, 13257, 12293, 12461, 11585, 10037, 10178, 10508, 10653, 11150
Neckermann	10037, 10556
NEI	10037, 11037
Neoka	11826
Neon	12673
Netsat	10037
NetTV	11755
Neufunk	10037, 10556, 10714
Nevir	12676



## Reference Information

New Acoustic Dimension	10037, 10178
New Sonic	11826
New Tech	10037, 10556
Newave	10093, 10178, 11150
NEX	13861
Nexus Electronics	12183
Nikkai	10037
Nikkei	12197, 10714
Nikko	10178, 10017
Nimbro	12104
Noblex	14029
Nokia	10208
Norcent	11365, 11589
Nordmende	13419, 13861, 10037, 10195, 11585, 13835, 10714, 11667
Normerel	10037
Nortek	10668
Novatronic	10037
Novex	11523
Novita	11585
NPG	13434

## ■ Television (O to S)

O.K.Line	11037
Oceanic	10208
OK Line	11037
OK.	13434, 12676, 13047
Okano	10037
OKI	11667, 12676, 12125, 13434, 11585
Olevia	11610
Omni	10698
Onei	11667
Onida	10653, 12414

Onimax	10714
Onix	10698
Onkyo	11807, 13100, 13500
Onn	12125, 11667
Opera	10037, 10714
Optimus	10650, 10679
Optoma	12796
Optonica	10093
Orava	11037
Orbit	10037
Orion	12108, 10037, 12676, 10556, 10714, 11037, 11667, 13540, 13650
Orline	10037
Ormond	10668, 11037
Osaki	10037, 10556
Osio	10037
Osume	10037
Otic	11983, 11498, 11687
Otto Versand	10037, 10512, 10093, 10556, 10195
Pacific	10714, 11037, 10556
Palladium	10037, 10714, 10556
Palsonic	12461, 10698, 13067, 10037
Panama	10037
Panasonic	11636, 11480, 11291, 10650, 11650, 13825, 12170, 10037, 10093, 10150, 10178, 10208, 10508
Panavideo	13825

Panavision	10037
Panavox	13835
Panda	10698, 10208, 10508
PARK	12104
Penney	10178
Peony	10208
Perdio	10037
Perfekt	10037
Philco	10171, 13426, 12414, 11394, 10037, 10178, 13639
Philips	11887, 11867, 10037, 12372, 12800, 10556, 13614, 11506, 11744, 12768, 12680, 11454, 10639, 11866, 10017, 10512, 13623, 10171, 12769, 11365, 11394, 10000, 10178, 11589
Phocus	10714
Phoenix	10037
PHOENIX Apollo	12239
Phonola	10037, 10556
Pioneer	10679, 11457, 10037, 10698, 11636, 10512, 12171
PJ	11506
Planar	10679, 14247, 11589
Plantron	10037
Playsonic	10714, 10037

Polaroid	11523, 11769, 11498, 11687, 11767, 12676, 14035, 12125, 11826
Powerpoint	10037, 10698
Premier	13419, 13183, 13793
Prestiz	13419
Prima	11753, 10037, 11749, 12461, 10698
Prinston	11037
Pro Vision	10037, 10556, 10714, 12197
Profitronic	10037
ProLine	10625, 10634, 10037, 11037, 12676
Proscan	11447, 12183, 12256, 13577, 13382, 13332, 13717, 13895, 12746, 13636, 14035
Prosonic	10714, 12676, 12125, 10668, 12197, 10037, 11523, 11585, 11667
Protech	10037, 10668, 11037
Proton	10178
Proview	11687, 11498
Proxima	10735
Pulsar	10017
Pye	10037, 10556
Q.Bell	12561
Quadro	11667
QuantumFX	12337
Quasar	11291, 13899, 10650



Reference Information

Quelle	10037, 10512, 11037, 10195, 10668
Radiola	10037, 10556
Radiomarelli	10037
Radionette	10714
RadioShack	10178, 10037
Radiotone	10037, 10668, 11037
RCA	12746, 12434, 12932, 11447, 12247, 13577, 11781, 10625, 12187, 13382, 10679, 13332, 13717, 10093, 13793, 12183, 12855, 13419, 10000, 10178, 10618, 11454, 13426, 13636
Realistic	10178
Recco	10898, 13183
Reconnect	13183
Recor	10037
Rectiligne	10037
Red Star	10037
Reflex	10037, 10668, 11037
RefleXion	12239
Relisys	11585
Relon	11826
Remotec	10037, 10093, 10171, 11150
Reoc	10714, 12197
Revox	10037
RFT	10037
R-Line	10037
Roadstar	11037, 10037, 10714, 10668

Rolsen	12098, 13067, 13434
Rowa	10898, 13047, 10698, 11038, 13001, 10037
RTF	10037
Runco	10017
Saba	10625, 12676, 10714
Saga	12197
Sagem	10618
Saivod	10668, 11037, 10037, 11667
Salora	12197, 12676, 12239, 12125, 13067, 10208
Sampo	11755, 10898, 13419, 10093, 10171, 10178, 10650
Samsung	12051, 10812, 11632, 10618, 11458, 11630, 12953, 10037, 10556, 10650, 10178, 10208, 11150
Sandstrom	12197, 13047
Sansui	13540, 11670, 13564, 10037, 10898, 10171, 10714, 13559
Sanyo	11142, 10208, 11585, 12676, 12461, 12994, 10735, 11974, 12881, 12769, 13488, 11498, 11365, 10508, 11037, 11150, 11667, 13861
Sanyuan	10093

Save	10037
SBR	10037, 10556
Sceptre	13899, 12528, 12337
Schaub Lorenz	10714, 12676, 12125, 12197, 11667, 12289
Schneider	10037, 10714, 10556, 11037, 10668, 11585, 12676
Schontech	11037
Scotch	10178
Scott	10178, 11983
Sears	10171, 10178
Seaway	10634
Seelver	10556, 11037
SEG	12673, 11037, 10037, 10668, 12125, 11523, 10634, 13434
SEI	10037
Seiki	13953, 12964, 13559, 10178
Seiko Epson	11379
Sei-Sinudyne	10037
Semp	11743, 13793
Semp Toshiba	11743, 13793
Sencor	13067, 12197, 10714
Senzu	12493
Serie Dorada	10178
Serino	10093
Shanghai	10208
Sharp	12360, 11659, 10818, 10093, 12951, 11393, 12676, 13867, 10650, 11165, 11423
Sheng Chia	10093, 11150

Shinelco	12104
Shintoshi	10037
Shivaki	12197, 10178, 10037
Siam	10037
Siemens	10195, 10037
Siera	10556, 10037
Silva	10037
Silva Schneider	12197, 10037, 12125
SilverCrest	12676, 11037
Sinudyne	10037
SKY	10037
Sky Brasil	10037
Skyworth	12899, 12963, 12889, 12769, 10037, 10698
SLX	10668
Sogo	13067
Solavox	10037
Soniko	10037
Soniq	12493, 13005
Sonitron	10208
Sonneclair	10037
Sonoko	10037
Sonolor	10208
Sontec	10037
Sontech	11983
Sony	12778, 10810, 11825, 10000, 11651, 11551, 11625, 11505, 11317, 10150, 11150, 10093, 11167
Soundesign	10178
Soundwave	10037, 11037, 12673
SOVOS	12239
Sowa	10178, 11150
Soyea	10698, 11743



## Reference Information

Soyo	11826
Spectroniq	11498, 11687
Squareview	10171
SR Standard	10037, 11037
Starion	11037
Starlite	10037
STI	13793
Strato	10037
SunBriteTV	12337, 12528, 11610
Sunic Line	10037
Sunkai	10037, 11523
Sunny	10037
Sunstar	10037
Sunstech	12676
Sunwood	10037
Superior	11585
Superscan	10093, 10171
Supersonic	10208, 11753, 12104
SuperTech	10037, 10556
Supra	10178
Supreme	10000
SVA	11498
Svasa	10208
Swisstec	12106, 12104
Sylvania	10171, 11864, 11886, 11394
Symphonic	10171, 11394
Synco	11755, 11826, 10000, 10093, 10178
Syntax	11610
Sysline	10037

## ■ Television (T to Z)

Tacico	10178, 11150
Tai Yi	11150
Talent	10178

Tandy	10093
Tashiko	10650, 11150
Tatung	10037, 11150, 11687
Taurus	12197
TCL	13047, 13183, 12434, 13001, 10898, 11038, 12414, 13426, 12675, 10698
TCM	10714
Teac	10037, 11037, 10698, 10714, 11755, 10898, 10178, 10668, 10171, 10512, 11983, 13005
Tec	10037
Tech Line	10037, 10668, 11585
Technica	11037, 12106, 12426
Technical	12676, 11667
Technics	10017, 10556, 10650
Technika	12426, 12106, 12197, 11667, 11983, 12676, 13005, 12125, 13067
TechniSat	10556
Technisson	10714
Techno	11585
Technosonic	10556, 10625
Techwood	12676, 11667, 11037
Tecnimagen	10556
Teco	10093, 10178, 10653, 11523, 11687
Tedalex	10208
Teknika	10150

TELE System	11585, 12125
Telecor	10037
Telefunken	10625, 12676, 12414, 10698, 12239, 11585, 11667, 10037, 10714
Telefusion	10037
Telegazi	10037
Telemagic	10735
Telemeister	10037
Telesonic	10037
Telestar	10037, 10556
Teletech	10037, 10668, 11037
Television	10037
Tennessee	10037
Tensai	10037, 11037
Terris	11667
Tesco	12426
Tesla	11037, 10037, 10556, 10714
Tevion	10714, 12426, 10668, 11037, 12125, 10037, 10556, 11498, 11585, 11667, 11687, 12197, 12289
ThemeScene	12796
Thomas	10625
Thomas America	10625
Thomson	10625, 13047, 12675, 11447, 10037
Thorn	10037, 10512
Tiane	10093
TMK	10178
TNCi	10017
Tokai	10037, 10668, 11037

Tokaido	11037
Tophouse	10672, 10698
Topline	10668, 11037
Toshiba	11508, 11524, 11656, 13323, 12676, 12598, 10508, 12724, 13570, 11743, 10650, 10618, 12108, 11037, 10093, 10195, 11150, 11169
Tosonic	11508
TRANS-continents	10037, 10556, 10668, 11037
Tranasonic	10037, 10698, 10512
Triad	10556
Trio	11498, 11687
Triumph	10037, 10556
Tucson	12676
TVE	12239
TVTEXT 95	10556
Uher	10037
Ultravox	10037
UMC	12106, 12426
Unic Line	10037
Uniden	12122, 12676, 11667
United	10714, 11037, 10037, 10556, 11523, 11983, 12125, 13434
Universal	10037, 10714
Universum	10037, 11037, 10512, 10668, 10618, 10195
Univox	10037
V7 Videoseven	11755
Vanguard	10037
VD-Tech	13067, 13332





## Reference Information

Venturer	13005
Vestel	11037, 11585, 10037, 12676, 10668, 11667
Vexa	10037
Victor	11428, 10000, 10093, 10150, 11150, 10650, 10653
Videocon	10508, 10037
Videoseven	11755
VideoSystem	10037
Vidikron	10735
Vidtech	10178
Viewsonic	12014, 12745, 12087, 13706, 11755, 11627, 12049, 11365
Viore	12352, 13382, 13118, 13429, 12104
Visa	10037
Vision	11826, 10037
VisionPlus	12426, 12106
Visual Innovations	12106
VIZIO	11758, 13758, 12707, 12757, 13415, 12512, 13174, 12209
Vortec	10037
Voxson	12197, 10178, 10037, 11667
VU	12098, 11365
Walker	12676, 11667, 11585
Waltham	10037, 11037, 10668
Wansa	12098
Wards	10178, 10017, 10000

Watson	11037, 10037, 10668, 10714
WeCube	11860
Wega	10037
Welltech	10714
Weltstar	11037
Westinghouse	11712, 13579, 13382, 13949, 11826, 12293, 11755, 12397
Westwood	11585
Wharfedale	11983, 11667, 10037, 10556
White Westinghouse	10037
Wilson	10556
Windsor	11037, 10668
Windy Sam	10556
Wintel	10714
Wyse	11365
Xenius	11667, 10634, 11585, 12676
Xiahua	11753, 10037, 11749, 12461, 10698
Xiron	11983, 11037
XLogic	10698
Xoceco	11753, 10037, 11749, 12461, 10698
Xogego	11753, 10037, 11749, 12461, 10698
Xoro	13067
Xpeer	12051
XRYPTON	10037
Yamaha	11576, 10650
Yamishi	10037
Yokan	10037
Yoko	10037
YU-MA-TU	10037

Zenith	10017, 10178, 11423, 10000, 12731, 11365, 12358, 12362
Zepto	11585
Ziggo	11818
Zonda	10698

## ■ TV DVD Combination

Akai	32966
Alba	32966
Black Diamond	30713
Blue Sky	30713
Bush	30713, 32966
Celcus	32966
Centrum	30713
Crown	30713
Dantax	32966
Digihome	32966
Dual	32966, 30713
Elfunk	30713
Emerson	30675
Ferguson	30713, 32966
Finlux	32966
Funai	30675
Goodmans	30713, 32966
Grandin	30713
Grundig	30539, 32966
Hitachi	32966, 30713
Hyundai	32966
Insignia	32095
JMB	32966
JVC	32966
Kuppersbusch	32966
Linetech	32966
Linsar	32966
Logik	30713
Luxor	32966, 30713
Matsui	30713, 32966
Medion	32966

Mitsubishi Electric	34004
OK.	32966
OKI	32966
Orava	30713
Orion	30713
Panasonic	32859
Philips	30539
Polaroid	32966
ProLine	32966
Prosonic	32966
Saba	32966
Salora	32966
Sanyo	32966
SEG	30713
Sharp	32966, 30630
Sony	30864
Soundwave	30713
Sylvania	30675, 30630
Symphonic	30675
Technica	30713
Technical	32966
Techwood	32966
Telefunken	32966
Teletech	30713
Thomson	30551
Toshiba	32966
United	30713
Universum	30713
Walker	32966
Waltham	30713
Weltstar	30713
Xiron	30713

## ■ DVD

3D LAB	30539
Accurian	30675
Acoustic Solutions	30730, 30713
AEG	30675, 31643, 30770, 31233
Aitro	32095



## Reference Information

Aiwa	30533
Akai	32966, 30770, 31233, 30675
Akura	31233
Alba	32966, 30713, 30539, 30730
Amitech	30770
Amphion MediaWorks	30872
Amstrad	30713, 30770, 32139
AMW	30872
Ansonic	30831
Anthem	32820
Anthem Statement	32820
Aristona	30539, 30646
Arrgo	31023
AS	30730, 30713
ASDA	32213
Audio Authority	32555
Audix	30713
Autovox	30713
Awa	30730, 30872
Axon	30730
Basic Line	30713
Beko	30831
Bel Canto Design	31571
Belson	32139
Berthen	31643
Best Buy	32139
Black Diamond	30713
Blu:sens	31233
Blue Parade	30571
Blue Sky	30713
Brainwave	30770
Brandt	30551, 30503
Bush	30713, 30730, 30831, 32966
Byd:sign	30872
California Audio Labs	30490
Cambridge Audio	32808
CCE	30730

Celcus	32966
Centrum	30713, 30675
Changhong	30627
Cinea	30831
Cineral	30730
Cinetec	30713, 30872
CJ Digital	31643
Classic	30730
Clatronic	30675, 31233
Clayton	30713
CMX	31643
Coby	32494, 30730
Codex	31233
Continental Edison	30831, 30872
Craig	30831
Crown	30713, 30770
Cybercom	30831
CyberHome	31023
Daenyx	30872
Daewoo	30770, 30872, 30490
Dansai	30770
Dantax	30713, 30539, 32966
Datsun	31233
Daytek	30872
Dayton Audio	30872
DCE	30831
Decca	30770
Denon	31634, 32258, 30490, 32748, 33851
Denver	31643
Dewo	31634
Dick Smith Electronics	32095, 30675
Digihome	32966, 30713
DigiLogic	30713
DiK	30831
Dikom	32494
Disney	30675, 30831

DK Digital	30831, 32095, 31643
Donghai	31233
Dragon	30831
DSE	32095, 30675
Dual	30831, 30730, 30713, 32966, 31023
Durabrand	30713, 30675, 31023, 30831
Dynex	32596
E:max	30770, 31233, 31643
ECC	30730
Electrocompaniet	32545
Elfunk	30713
Elin	30770
Elite	32854
Elta	30770, 31643, 31233
Eltax	31233
Emerson	30675, 30591, 32213
Enterprise	30591
Epworth	30533
EuroLine	30675, 31233, 31643
Ferguson	30713, 32966
Finlux	32966, 30770, 30591, 30741
Firstline	30713
Funai	30675
GE	30522
General Electric	30522
GFM	30675
G-Hanz	32213
G-HanzS	32213
Go Video	31044, 30741
GoGen	32139
GoldStar	30741, 30591
Goodmans	30713, 30730, 32966

GoWell	31643
GPX	30741
Gran Prix	30831
Grandin	30713, 31233
Grundig	30539, 30551, 30713, 31643, 32966
Grunkel	30770, 30831
GVG	30770
H & B	30713, 31233
Hanseatic	30741
Harman/Kardon	30582, 33228, 32927
HE	30730
Hello Kitty	30831
Hen°	30713
Hitachi	30573, 32966, 30713, 31664
Hoher	30713, 30831, 31643
Home Electronics	30770, 30730
Home Tech Industries	31643
Humax	30646
HYD	31233
Hyundai	32966
Ingersoll	31023
Inno Hit	30713
Insignia	32095, 32596, 32428, 30675, 30741
Integra	30627, 32147, 31769, 31634, 30571, 30503, 31612
Irradio	31233, 30646
ITT	31233
Jamo	32358
JDB	30730
JMB	32966
JVC	30623, 31602, 32365, 32612, 32855, 32966



## Reference Information

Kansas Technologies	31233
Kendo	30713, 30831
Kennex	30713, 30770
Kenwood	30534, 30490
KeyPlug	31643
Kiirō	30770
KingVision	31643
Kuppersbusch	32966
Leiker	30872
Lenco	30713, 30770
Lenoxx	32213
Lexicon	32545
LG	30741, 32811, 31602, 30591, 31233
Lifetec	30831
Linetech	32966
Linsar	32966
LM	31643
Lodos	30713
Loewe	30741, 30539
Logik	30713
Lumatron	30713, 30741
Lunatron	30741
Luxman	30573
Luxor	32966, 30713
Magnavox	30675, 31354, 30503, 30539, 30646, 31506, 33488, 30713
Manhattan	30713
Marantz	30539, 32481, 32414, 33444
Mark	30713
Marquant	30770
Matsui	30713, 32966
Maxim	30713, 30872
MBO	30730
McIntosh	31273
MDS	30713
Mecotek	30770

Medion	30831, 32966, 30741, 30630
Memorex	30831, 32213, 33153
Metz	30713, 30571
Micromedia	30503, 30539
Micromega	30539
Microsoft	31708, 32083, 32202, 30522
Microstar	30831
Minax	30713
Minoka	30770
Mitsubishi Electric	31521, 34004, 30713
Mizuda	30770
Mustek	30730
Muvid	31643
Mystral	30831
NAD	30741
Naiko	30770
NEC	30741, 31602
Neom	31643
Nevir	30831, 30770
New Acoustic Dimension	30741
Nisato	31233
Noblex	31233
Norcent	30872
Nordmende	30831
Nortek	31643
OK.	32966
OKI	32966
Omni	32139
One For All	32555
Onkyo	30627, 32147, 30503, 31769, 31612, 30571, 31634
Oppo	32545, 30575
Optimus	30571
Orava	30713
Orbit	31643, 30872

Orion	30713, 31233
Ormond	30713
Pacific	30831, 30713
Packard Bell	30831
Palladium	30713
Panasonic	31641, 30490, 33641, 31579, 33580, 33862, 32710, 32859, 32523, 30503
Philco	30675
Philips	32056, 30539, 31354, 32789, 30646, 32434, 31506, 32334, 31340, 30503, 33488, 30675, 32084, 30713
Pioneer	31571, 30571, 30631, 31531, 32442, 32847, 30142, 32854
Play It	31643
Polaroid	32966
Polk Audio	30539
Portland	30770
Powerpoint	30872
Presidian	30675
Prinz	30831
Prism	30831
Pro Vision	30730
ProLine	31643, 32966
Proscan	30522
Proson	30713
Prosonic	32966
Pye	30539, 30646, 30675
Radionette	30741
Radiotone	30713
RCA	30522, 32213, 30571, 31769, 32532

RE-BL	32555
REC	30490
Red	32213
Red Star	30770
Richmond	31233
Roadstar	30713, 30730
Ronin	30872
Rotel	30623
Rowa	30872
Saba	30551, 31643, 32966
Saivod	30831
Salora	32966, 30741
Samsung	30199, 30573, 33195, 32069, 31635, 32942, 32369, 32329, 32489, 31044, 30490, 32107
Sanyo	32966, 30713, 31233
ScanMagic	30730
Schaub Lorenz	30770, 31643
Schneider	30539, 30646, 30831, 30713
Schontech	30713
Scott	31233
Seeltech	31643
SEG	30713, 30872
Semp	30503
Semp Toshiba	30503
Sharp	32250, 30630, 32966, 30675, 33313, 30713
Sherwood	30741, 30770, 32820, 33837
Shinsonic	30533
Sigmatek	32139
Silva Schneider	30831, 30741
SilverCrest	31643
Skantic	30713, 30539
Skymaster	30730



Reference Information

SM Electronic	30730
Smart	30713
Sonashi	30831
Soniq	30831
Sony	31516, 31633, 30533, 31033, 30864, 31070, 31548, 32861, 31536, 32839, 32180, 30772
Sound Color	31233
Soundwave	30713
Spectra	30872
SR Standard	30831
Sunkai	30770
Sunstech	30831, 32139, 32966
Superior	31643
Supratech	32139
SV2000	30675
Sylvania	30675, 30630
Symphonic	30675
Sytech	30831
Tandberg	30713
Targa	30741
Tascam	31818
Tatung	30770
TBoston	32139
Tchibo	30741
TCM	30741
Teac	30571, 30675, 30741, 31818, 32139, 34004
Technica	30713
Technical	32966
Technics	30490
Technika	30770, 30831
Technosonic	30730
TechnoStar	31643
Techwood	30713, 32966
Telefunken	30551, 32966

Teletch	30713
Tensai	30770
Theta Digital	30571
Thomson	30551, 30522, 30831
Thule Audio	30551
Tokai	31233
Tosaki	32006
Toshiba	30503, 33157, 33857, 32006, 32277, 32705, 31769, 32966, 32551
TRANS-continents	30831, 30872, 31233
Transonic	30730
Trent	31643
Trevi	30831
TruTech	30675
TVE	30713
United	30713, 30675, 30730, 31233, 31643
Universum	30713, 30741, 30591
Urban Concepts	30503
Venturer	31769
Vestel	30713
Vitek	30831
VIZIO	32563
Voxson	30730, 30831
Waitec	30730, 31233
Walker	32966
Waltham	30713
WB Electronics	32555
Welkin	30831
Wellington	30713
Weltstar	30713
Wharfedale	30713
Wilson	31233, 30831

Windsor	30713
Windy Sam	30573
Woxter	32139
Xbox	32083, 31708, 32202, 30522
Xiron	30713
XMS	30770
X-View	31233
Yamada	30872, 32139
Yamaha	30497, 32298, 30539, 30817, 30490, 31354, 33871, 30646, 33837
Yamakawa	30872
YBA	30872
Yukai	30730
Zenith	30741, 30591, 30503

■ Blu-ray Disc

Anthem	32820
Anthem Statement	32820
Cambridge Audio	32808
Denon	32258, 32748, 33851
Electrocompaniet	32545
Elite	32854
Funai	30675
Harman/Kardon	33228, 32927
Insignia	32596, 32428, 30675
Integra	32147, 32900, 32910, 33100, 33101, 33500, 33501
JVC	32365, 32612, 32855
Lexicon	32545
LG	31602, 32811, 30741

Magnavox	30675
Marantz	32414, 33444
Mitsubishi Electric	34004
Onkyo	32147, 32900, 33101, 33501, 32910, 33100, 33500
Oppo	32545
Panasonic	31641, 33862, 33580, 33641, 32859, 32523, 32710
Philips	32789, 32434, 32084
Pioneer	32442, 32847, 32854, 30142
RCA	32532
Samsung	30199, 33195
Sharp	32250, 33313
Sherwood	32820, 33837
Sony	31516, 32180, 30772
Sylvania	30675
Tascam	34004
Toshiba	32705, 33157, 33857, 32551
VIZIO	32563
Yamaha	32298, 33871, 33837

■ DVD-R

Accurian	30675
AEG	30675
Akai	30675
Aristona	30646
CyberHome	31023
Denon	30490
Dick Smith Electronics	30675
DSE	30675
Emerson	30675
Funai	30675



## Reference Information

Go Video	30741
GPX	30741
Hitachi	31664
Humax	30646
Insignia	32095
Irradio	30646
JVC	30623, 32612
LG	30741
Loewe	30741
Magnavox	30675, 30646, 31506
Medion	30741
NEC	30741
Panasonic	30490, 31579, 33580, 32710, 32859, 32523
Philips	30646, 31340, 31506, 32334, 30539, 32056
Pioneer	30631
Pye	30646, 30675
RCA	30522
Samsung	31635, 32942, 33195, 32107, 30490, 32069, 32489
Schneider	30646
Sharp	33313, 30630, 30675, 30713
Silva Schneider	30741
Sony	31070, 31033, 32861, 31516, 31536, 32839, 32180, 31633
Sylvania	30675
Targa	30741
Tchibo	30741
TCM	30741
Thomson	30551
Toshiba	32277, 32551, 30503
Universum	30741

Yamaha	30646
Zenith	30741

## ■ VCR

DirecTV	20739
Humax	20739
Loewe	21062
Metz	21062
Optimus	21062
Panasonic	21062, 20616
Philips	20739
Quasar	21062
RCN	20739
ReplayTV	20616
Sonic Blue	20616
Sony	20636
TiVo	20739, 20636

## ■ Cable Set Top Box (A to E)

ABN	03322, 02897, 02979, 03340, 03407, 03849
Access Communications	01376, 00476
ACT	02950
Adams Cable TV	01376
ADB	02586, 01920, 01585, 01927, 01481, 01998, 02254, 02302, 02437, 03028
Akado	02043
Aland	02030, 02437
Alands	02030, 02437
Datakommunikation	
Alcom	02030, 02437
Alice	01585
Allegiance Communications	00476, 01376
Allen TV Cable	00476
Altibox	02437, 02030

Amino	01615, 01898, 01481, 02482, 01998, 02302, 03028
Anguang Network	03936
Anhui Network	03936
Arcadyan	02952
Arion	03336
Armstrong	01376, 00476
Arris	02187, 01982, 01998, 02378
Arvig Communication Systems	01376, 01982, 01998, 02345
Astound Broadband	01376, 01877, 00476, 02479, 04079
AT&T	00858
AT&T U-verse	00858
Atlantic Broadband	01877, 01376
ATMC	01376, 01982, 03028
Austar	00276
B tv	02681, 03442
Baja Broadband	00476, 01376
BBTV	02980
Beijing	04010
Belgacom TV	02047, 02132
Bell	01998
Bell Aliant	01998
Bell ExpressVu	01998
Bell Fibe TV	01998
Bend Broadband	01376, 00476, 02187
BesTV	04196
Bevcomm	01898, 00476
BGCTV	03278, 00476
BIG.BOX	03465
Blue Ridge Communications	01877
Bluewin	02271
Bouygues Telecom	03007
Boxer	03607
Bright ClouDigital	03961

Bright House	01877, 01376, 00476
British Telecom	02294
Broadstripe	00476, 01376
BSI	02979
BT	02294
BT Vision	02294
Buckeye Cable System	01376, 00476, 01877, 02187
C&M	03407, 03319, 02962, 02979
Cable America	01376, 01877
Cable Axion Digitel	01376, 00476
Cable HK	01374
Cable One	01376, 00476, 01877
Cablecom	01582
Cablecom Mexico	00476, 01376
Cablemas	01376, 01877
Cablevision	01877, 01376, 03336, 00476
Cabovisao	02436, 02493
Caiway	02015, 03607, 02762, 00660, 02447
Caiyun Digital	03961
CalTel Connections	02254, 02586
Canal Digital	02030
Canby Telcom	01481, 02302
Cass Cable	00476, 01376
CC9	02703, 02752, 03474
CCAP	01877
CCS	03322
Celrun	03442, 02682
CenturyLink	01998
Channel Master	03118
Charter	01877, 01376, 00476, 02187, 03560
Chengde Guangtong	03936
Chengdu Cable	03953
Chengdu Telecom	04196



## Reference Information

China Telecom	04196, 02913, 03937
China Unicom	04366, 04196
Chongqing Cable	03954
Chongqing Cable Networks	03954
CHT	03647, 01917
Chunghwa	03647, 01917
Cincinnati Bell	01877, 01376
Cisco	01877, 00858, 03028, 01982, 02132, 02345, 02589, 01883, 01998, 01582, 02047, 02378, 02563, 02401, 02742, 03265, 02271, 02947, 03452
Citycable	03451, 03477
CJ	03322, 02897, 02979, 03340, 03407, 03849
CJ Digital	02979, 02897, 03322, 03340, 03407, 03849
CJ HelloVision	03322, 02897, 02979, 03340, 03407, 03849
Claro	01376, 00476
ClubInternet	02132
CMA Communications	01376
CMB	03389, 02979, 03498
CMBTV	03498
CNS	02980, 02350
Cogeco	01376, 01982, 00476
Com Hem	00660, 02447, 02832, 02015
Comcast	01982, 01376, 00476, 01877, 03560, 02187

Comporium	01877, 03560, 02187
Consolidated Communications	01877, 01376, 01998, 02302, 03048
Coship	01991, 02950, 03278, 04162, 04408, 04196
Cosmic	02897
Cox	01877, 01376, 00476
CTS	02703, 03474
Daeryung	01877
Darty Box	02436
DASAN	02683
Delta	03607, 02015, 00660, 02447, 02762
DEN	02726
Deutsche Telekom	02132
Digeo	02187
Digi	02762, 03479
Digicable	03382, 02479
DigitAlb	02493
Director	00476
Dmg	03835
DNA	02832, 00660, 02030
Dom.ru TV	02493
Dream Satellite TV	02493
DSD	03340
DST	03389
Du	02401
DV	02979
Eagle Communications	01376, 02187
EastLink	01376, 00476
Echostar	02955, 03452
Elion	03916
Entertain	02132
Entone	02302, 03048
ER Telecom	02493
eTb	04281
Evolution	02479, 02746, 04079

Extra TV	02132
<b>■ Cable Set Top Box (F to J)</b>	
Fastway	03382
FCTV	01782, 02703
Fidelity Communications	01376
Finnet	02030, 02832
First Media	03783
Freebox	01976
Frontier Communications	02378
Fujian Broadcast & TV Network Group	04195
Fujian Broadcast and TV	04195
Gangwon Broadcasting Network	03407
Gansu Cable	04236
GCI	01376
GCS	03322
GDCATV	02980, 03131, 03132
Gehua	03278, 00476
General Communications	01376
General Instrument	00276, 00476
Google	03666
Gospell	04205
Grande Communications	01877, 03560, 01376
Great Plains Communications	01376
Guangdong Cable	02980, 03131, 03132
Guangxi Broadcasting	02897, 03407, 03961
Guangxi Broadcasting Network	02897, 03407, 03961
Guangzhou Cable	02945
Guizhou Broadcasting Network	03946
Hana TV	02681, 03442

Hathw@y	02043, 02726
Hawaiian Telcom	03028
HBC	01376, 01877, 01982, 02979, 03322, 03340, 03849
HCN	02979, 03340
HD+	03607
HDT	03465
Hebei Broadcasting	04026, 03967
Hebei Broadcasting Network	04026, 03967
Hebei Digital TV	04205
Hello TV	03322
HelloD	02979
Henan Cable	04034
HickoryTech	01898, 02302
Hikari TV	03237
Himawari TV	01760
Homecast	02977, 02979, 03389
Hong Kong Cable	01374
Hrvatski Telekom	02132
HSHONG	03965, 03937, 04026
Huashu	04034
Huawei	02994, 03278, 03937, 01991, 02913, 04281, 01982
Humax	03607, 02762, 02043, 02447, 00660, 01981, 01983, 02620, 02832, 03560, 02165, 02683, 02701, 02889, 02715, 02962, 03051, 03053, 03075, 03319, 03849
Hunan Cable Net	04205
HYA	02989
Hyroad	02979



## Reference Information

HyTV	02979, 03340
Hyundai Digital Technology	03465
HZRTV	02960
I-Cable	01374
i-CAN	01585, 02437
I-Digital	03319, 02979
IMBTVN	04106
INESA	03865
Innovative Systems	01898
Inotel	02437
Inter Mountain Cable	01877, 02479, 04079
Invitel	02437
InviTV	02437
iTSCOM	02703
ITV	02979, 03389, 04196, 03498
J:COM	01760, 02703, 03925, 01782, 02701, 02700, 02715, 02752, 03051, 03053
Jambox	02030
JBC	02979, 03322, 03340, 03849
JCN North	02703, 01760, 03474
Jerrold	00276, 00476
Jiangsu Cable Network	04022
Jilin Broadcasting	04009
Jilin Cable	04009
Jinan Radio and Television Network	04206
Jishi Media	04009
Jiuzhou	01991
JP PTT	01615
JXCN	03948

## ■ Cable Set Top Box (K to N)

Kabel Deutschland	03514, 01981, 01983, 02165, 03607, 02620
-------------------	--

KabelBW	02889, 01981, 01983
KabelNoord	02015
Kaon	02493, 02889, 02746, 03407, 04409, 02682, 02979, 03389
kbro	02350, 03139
KCN-TV	02703
KCT	01760, 02703, 02752, 03474
KCTV	02979, 03340, 03389, 03849, 03322
KCTV JEJU	02979, 03340, 03389, 03849
KCTV-KJ	02979, 03340, 03389, 03849
KDMC	03319, 02979
Kiryung	03498
Kiss	02132, 02271
KoolConnect	01481
KPN	02952, 02437
Kreatel	02030
KT	02683, 03478
Lattelecom	02030
LG	03340, 02682, 03407, 02979, 03389, 03319
LG U+	02682
Linksys	02271
Lishui Huashu	04034
Longyan Broadcasting Cable & Tv	04195
Lumos Networks	01998, 03028
Magio Sat	02132
Magnet	01615
Maige TV	03937
Massillon Cable	00476, 01376
Matanuska Telephone Association	01481, 02254, 02482, 02586
Mediacom	01376, 00476, 01982, 01877
Mediastream	01376, 00476

Mega	02683
Mega TV	02683
Megacable	01376, 00476
Meo	02401
MetroCast Cablevision	01376, 01982, 00476
Mi-Connection	01877
Midcontinent Communications	01376, 00476, 01982
Mid-Hudson Cable	00476, 01376
Minerva Networks	03118
MIO	02275, 02802
mio TV	02275, 02802
Mitsubishi Electric	03274
MOD	03647, 01917
Motorola	01376, 00476, 02378, 02437, 01998, 02030, 00858, 01982, 02952, 00276, 01562, 02275, 03916, 01585, 04034, 02401
Movistar	01585, 03288
Moxi	02187
Moyo	03611
MTS	01998, 03611, 01615, 01481, 01898
MyLGTv	02682
NET	01883
NewWave Communications	00476, 01376, 02187
NIB	03322
Ningde Cable TV	04195
Noos	02436
Northland Communications	01376
Novus	01376, 00476
Now TV	02009, 02014
NTL	01060, 00276
NTT	03237, 03274
NTV Plus	02762
NU Telecom	01998, 03028

Numericable	02436
-------------	-------

## ■ Cable Set Top Box (O to S)

O2	02586
OCN	03865
Oi TV	03452, 03454, 04165
Olleh TV	02683, 03478
Olleh-Skylife	02683, 03478
Ono	01562
Open IPTV	01615
Optimum	01877
Optimus Clix	02437
Optus	00276, 01060
Orange	02407
Oriental Cable Networks	03865
Pace	01376, 01060, 02620, 01982, 01877, 01998, 00858, 01582, 01883, 03454, 02294, 02401
Panasonic	02703, 02752, 03474, 01760, 01782, 01982
Parasat	03479
Paul Bunyan Communications	02254, 02586
PCCW	02009, 02057
Philips	01582, 02378, 03560, 02294
Pioneer	01782, 01877, 03925, 02700
Pioneer Telephone	02254, 02302
Portugal Telecom	02401
Premiere	02620
Primacom	02889
PrimeStar	02030
PrimeTel	03611, 02030, 02437
PrimeTV	02030
PT	02401



## Reference Information

PTCI	01376
PX	03348
QooK TV	02683, 03478
Qook-Skylife	02683, 03478
Qrix	03465, 02979
QuickLine	02493
Qwerty	01898, 01481, 01615
Qwerty.TV	01898
RCN	01376, 00476, 03560
Reach Broadband	01376, 01877, 01982
Reliance	02556
RIO Media	02030
Rogers	01877, 01376
Rostelecom	03611
Sagem	02407, 02436, 03288
Sagemcom	03514, 02407, 02436, 03007, 03288
Samsung	03322, 02979, 03319, 01877, 02407, 02015, 03340, 03407, 03451, 03442, 03477, 02610, 02955, 01060, 02683, 03514, 03783, 02589, 02889, 02962, 03265, 03849, 03928, 01982, 01987
SaskTel	01998
SBN	03965
Scientific Atlanta	01877, 00858, 01982, 02401, 02345, 01987, 02047, 02436, 03028, 02378
SCTV	02493
SCV	02950

Seokyoung	03340
Service Electric	01376, 00476, 01982
SetaBox	01917
Shaanxi Broadcasting	03965
Shanghai	03865
Shanghai OCN	03865
Shanxi Broadcasting Network	03965
Shaw	01376, 01877, 00476, 02187, 01982
Shenzhen Broadcasting	01991, 04162
Shenzhen Digital TV	01991, 04162
Shijiazhuang Broadcasting	04026
Shimanto CATV	02752
Sichuan Broadcasting	03953
SingTel	02275, 01998, 02802
Siti Digital	03664
SK Broadband	03442, 02681
SK Btv	02681, 03442
Sky Austria	02620, 02447, 02832
Sky Deutschland	02620, 02447, 02832
SkyCable	02950, 03521, 03527, 04177
SkyLife	02683, 03478
Skyworth	03298, 02960, 03278, 01991, 03521, 04177, 03946, 04162
Smartlabs	03611
Smile Content	02437
SMT	03527
SMtronics	03319
Sogetel	01998, 02482
Sonaecom	02437
Sonera	00660
Source Cable	01376, 00476
Starcat	02703, 01782

StarHub	01927, 00276
Stipte	01898
Stofa	02015
Suddenlink	01877, 01376, 01982, 03560, 00476
Supercable	00276
Supercanal	01376, 00476
Suwon Cable	03319
Suzhou Cable Network	04022
SVA	03865
Swisscom	02271
SXBCTV	03965

## ■ Cable Set Top Box (T to Z)

TalkTalk	02994
Tbaytel	03028
Tbroad	03319
TCC	04409, 04408
TCN	03340, 02703
T-Com	02132
TDC	02271
TDS Telecom	03028
Technicolor	01982, 02994, 03288
TechniSat	03316
Tele2	00660, 02447
Telecentro	00476, 01376
TeleColumbus	02889
Telefonica	01585, 03028, 03288, 02586
Telekom Deutschland	02132
Telenet	01920, 03451, 03477
Telewest	01987
Telia	02030
Telmex	01376
TELUS	03028
TFN	03127, 03139
T-Home	02132

Thomson	01582, 01981, 01982, 01983, 03007, 02407
T-Hrvatski Telekom	02132
Tianjin Broadcast & TV Network	04010
Tianjin Broadcasting	04010
Time Warner	01877, 01376, 00476, 02187
TiVo	03560, 03265
ToongTV	03322
Top	03766
TopTV	01991
TP	02407
Trans PX	00276
True Visions	03075, 02762
TVB	01615
TVS Cable	01376, 01877, 01982
U+	02682
U+ tvG	02682
UCATV	02703, 01760
Unitymedia	02955, 02610, 03451, 03477
UPC	01582, 03451, 03477, 00660, 01060
UPC Cablecom	01582, 03451, 03477
US Electronics	00276
U-verse	00858
Vector	02030
VeeTV	03231
Verizon	02378
Viasat	02030
Videotron	01877, 02947
Viken Fibernett	02030, 02437
Virgin Media	01987, 02563, 01060, 03265, 00276
Visionetics	01374
Vivo	03288





## Reference Information

Vodafone	02401
Volia	02493
Volia Cable	02493
Voo	02742
VTR	01376
wasu	04034
Wave Broadband	01376, 00476, 02479, 04079
Wavevision	01376, 01877, 01982
Wbox	02832
WEHCO Video	01376
Welho	02832
WellAV	03479
Westman Communications	01376, 00476, 02187
WideOpenWest	01376, 01877, 02187
Windjammer Cable	00476, 01376, 01877
WNC	03118
WOW!	01877, 01376, 00476, 02187, 02479
Xfinity	01376, 01982, 00476, 01877, 03560, 02187
Xuyi Radio & TV	02897
YBN	03322
YCV	02703, 01760
Youview	02994
Yunnan Broadcasting	03961
Yuxing	02014
Zhong Hua Dian Xin	01917
Ziggo	02589, 03607, 02015, 02762, 00660, 02401, 02447
Zinwell	03139
Zito Media	01376, 01982
ZTE	04196

## ■ Satellite Set top Box

@sat	01300
@Sky	01334
1.Sky	03538
Acoustic Solutions	01284
ADB	02553, 00887, 01887
AEG	02738, 02813
Agora	01284
Airis	02813, 03012
Airtel	02248
Akai	02938
Akira	02738
Akta	01986
Akura	01626
Alba	01284, 02034, 02568
Allvision	01334
Altech UEC	02059, 02097, 03517
Amiko	04197
Amstrad	00847, 01662, 01175, 01693, 02467
AMTC	02738, 02813
Ansonic	02418
Aonvision	02279
Apro	01672
Argos	02568
Arion	03374, 04348
Arnion	01300
Arris	00869
AS	01284
ASA	00740
ASCI	01334
ASDA	01284
AssCom	00853
Astell	01986, 02418
Astro	00173, 01838, 02627, 00658, 03838, 01099, 01100, 02026

Atevio	02928
Atlanta	02418, 03320
Atom	02289
Audiola	03012, 02418
Audioline	01672
Aurora	00879
Austar	00879
Austriasat	01195, 01197, 02957, 03374, 01561, 01631, 02631
Auvisio	02932, 02738, 02813
Avanit	00299, 01631
Awa	02418
Axil	02418, 01413, 01777, 02738, 03424
Axitronic	01626
AZ America	01631
AZBox	02719
B.net	01672
B@ytronic	00740
Beijing	03299
Bell	00775
Bell ExpressVu	00775
Bell Fibe TV	00775
Bell Satellite TV	00775
Belson	02418
BENSat	02957, 02938
Best Buy	02728, 02842
BIG TV	04312
BIOSTEK	02738
BiS Television	01986
Black Diamond	01284
Blaupunkt	00173
Blu:sens	02938
Boca	02026, 02458, 02797, 02308, 02813
Boshmann	01413, 01631
Botech	02738, 03749

Boxer	02443, 01692, 01957, 04024
Brainwave	00658, 01672
BSkyB	01175, 01662, 00847
Bulltech	02738
Bush	01935, 02376, 01284, 02813, 01672, 03346, 03439, 02034, 03652, 01291, 01626, 02418, 02568
Cablecom	01195, 01197
Caiway	02443, 00253
Canal Digitaal	02631, 00853, 02466, 02957
Canal Digital	02553, 01780, 00853, 01334
Canal+	00853, 02657, 01195, 01197, 01986
CanalSat	00853, 02657
Century	03110, 00856
CGV	02034, 01413, 01986
Chess	02026, 01334, 01626
Signal	02289, 02835, 02836
CityCom	00299, 00658, 02957
Clarke-Tech	03320
Claro	03787, 03790
Classic	01291, 01284, 01672
Clatronic	01413, 02738
Clayton	01626
CME	00173
CMX	02205, 02932
Cobra	02728, 03012
Com Hem	01176, 01915



## Reference Information

Comag	02797, 02026, 02458, 02813, 02308, 01413
Comsat	01413
Comwell	01956
Continent	01986
Coship	03787, 03790, 01672, 02525, 03574
Cosmos TV	01545
Croner	02813
Crown	01284
Crypto	03012
Crystal	03012, 01416
Cyfra+	00853, 01409
Cyfrowy Polsat	02262, 02527, 00253, 00853
Dantax	01626
Danystar	02938
DASAN	03321
D-box	01114
DCR	03517
Delta	02443
Denver	02418, 02738
Deutsche Telekom	01195, 01197
Dgtec	01631, 02418
Dick Smith Electronics	02418, 02813
Dicra	02738, 02842, 03012
Digenius	00299, 00740
Digi	01416, 01195, 01197, 02026
Digi Raum Electronics	02622
Digi Romania	01416
Digitality	01334, 02813
Digihome	02034, 01284, 01935
DigiLogic	01284, 02034
DigiQuest	02278, 02738, 01300, 01631
Digital	02308
DigitAlb	01195, 01197

DigitalBox	02540, 01631, 02289, 01100, 03240
DigitSat-e	02842
Digiturk	03517, 02097
Digiwave	01631
Dikom	02938, 02842
Dilog	01957, 01780
DiPro	02278
DirectTV	01377, 01442, 00099
Dish Mexico	00775
Dish Network	00775
DishHD	04090
Dishpro	00775
DishTV	01300, 02604, 01780
Di-Way	02289
DMT	03321
DMTech	02738
DNA	01780, 01957, 01176, 02144
Donghai	02938
Doro	01672
DragonSat	02928
DRE	02622
Dream	01237
Dream Multimedia	01237, 01652, 01923
Dream Satellite TV	01416, 03374
DSE	02418, 02813
D-Smart	02231
DSTV	00879, 02059, 02060
DTI Electronics	02938
DTK Deutsche Telekom	01195, 01197
DTV	03572
Dual	02034
Durabrand	01284, 02034
Dyon	02738, 02813
Easy-One	03240

EchoStar	00775, 02262, 02527, 00853, 01409
Eco-Star	01413
Edision	01631
Ekotech	03422
Elap	01413
Elbe	02418
Electron	01956
Elisa	01322, 02455
Elless	00740
Elta	02738
Embratel	02796, 03787
Energy Sistem	02418, 01631, 02289, 02813
Engel	03749, 01611, 01672
Etisalat	02443
Europhon	00299, 01334
Europsat	01611, 01413
Eurosky	00740, 00299
Eutra	00740
Evesham Technology	02034
Eycos	03374
F&U	03012
Fagor	01611
FaVal	03422
Ferguson	02638, 01291, 01803, 01935, 02034
Finepass	01780
Finlux	01626, 02034
Finnnet	01780, 01957
FinnSat	00740, 01195, 01197, 01351
FMD	01413
Fortec Star	01631
Foxtel	01356, 00879, 01176
Freesat	01692, 02928, 03266, 01986, 02376

Freesat+	02443, 03266
freeview	02982
Fte Maximal	02289
Fuba	02750, 00173, 00299, 03726
Fuji Onkyo	02728, 01631
Funai United	03012
Galaxis	00853, 00879
Galaxy	01956
Galaxy Innovations	02799, 04197
General Instrument	00869
General Satellite	03064, 02622
Gi	02799, 04197
GigaBlue	03663
GigaTV	02738
Globo	02026, 01334, 00740, 01429, 02957, 01626
GMMZ	03538
Go	01780
GoGen	02738
GOI	00775
Gold Box	00853
Gold Vision	01631
Golden Media	04197
GoldMaster	01334, 02928
Goodmans	01284, 02376, 02034, 03652, 02568, 03346, 03439
Gradiente	00887, 03110, 00856
Gran Prix	00740
Grandin	01626
Grocos	01409



Reference Information

Grundig	00173, 00847, 02376, 01291, 02034, 00853, 02813, 01284, 01780, 02738, 03424, 00879, 01672, 02568, 03346
GVT	03789
Haier	02418
Hailo	02289
Hallo	01626
Handan	01780, 01957
Hanseatic	01099, 01100
Hauppauge	01672
HD Box	02928
HD+	02797, 02443, 01429, 02569, 03095
HDT	01416, 01255, 03321
Hirschmann	00173, 00299, 02026, 00740
Hitachi	02034, 01284
Homecast	02525
Hornet	01300
HTS	00775
Huawei	03787
Huaxian Radio and Television Network	04041
Hubei Chutian	04041
Hubei Radio & Television Network	04041
Hughes Network Systems	01442, 01377

Humax	01176, 02443, 01427, 01808, 02736, 01882, 01915, 03140, 02231, 02408, 02144, 02616, 02754, 01377, 03517, 01989, 02289, 03321, 01255
Hyundai	01416
Hyundai Digital Technology	01416, 01255, 03321
ibox	01652
IceCrypt	04197, 02838, 02928
ID Digital	01176
ID Sat	02289, 01334, 01631
i-Joy	02938
Illusion	01631
Imagin	01195, 01197
Imperial	01195, 01197, 01334, 01429, 01672
InDigital	01416
Indovision	01989, 00856, 01887, 02108, 00887, 01255
iNETBOX	01652, 01237
Inno Hit	01626, 02728
Innova	00099
Intv	04348
Inverto	03095
inVion	02418
iotronic	01413
IP Vision	02455
IPM	03567
IQ	02813
IQ Prism	02813
ISkyB	00887
ITT	02418

Jaeger	02797, 01334
Jameson	02813
Jerrold	00869
Jiuzhou	03140
JVC	00775, 01284
Kabel Deutschland	01195, 01197, 01672, 01882, 01915
KabelBW	01882, 01915, 01195, 01197, 01429
KabelNoord	00253, 02443
Kamosonic	02738
Kaon	01300, 02231
Kathrein	01561, 02569, 00658, 00173, 03658, 01416, 02263
Kenwood	00853
Konig	02289, 01631, 00173
Koscom	01956
KPN	01986
Kreiling	00658, 01626
Kreismeyer	00173
KT	03321
L&S Electronic	01334
Labgear	03424
LaSAT	00740, 00299
Lava	01631
Lazer	02738
Leiker	02728
Leiko	01626
Lemon	01334
Lenoxx	01611
LG	03321
Lifesat	00299
LinkBox	02957
Linsar	01284, 02842
Listo	01626, 02813
Lodos	01284

Logik	02034, 01284, 01906, 02842, 01803, 03652
LogiSat	02797, 02026, 02813, 02458
Lorenzen	00299
Lowry	02938
Luxor	01935, 02034
M vision	03562
M7	02631
Macab	00853
Magic TV	02982
Majestic	03012, 02738, 02842
Manhattan	01300
Maplin	02034
Marusys	02799, 03543
Mascom	02738
Maspro	00173, 03099
Matsui	01284, 00173, 01626
Maximum	01334, 02813, 01672, 01986
Mediabox	00853
MediaSat	00853
Mediascape	02289, 02835, 02836
Mediaset	02750, 02278, 01427, 02736, 02739
Medion	00299, 00740, 01626, 01334, 02026, 02797
Mega TV	03321
MegaSat	01631, 02034, 02813, 02289, 00740, 02738
Melita	01416
Meo	02466
Mercury	03422



## Reference Information

Metronic	01986, 02418, 02738, 01334, 01631, 01413, 01672, 01935, 02278
Metz	00173
Micro	02797, 02813
Micro electronic	02308, 02813
Micromaxx	00299
Microstar	00299
Miraclebox	02928
Mitsai	02738
Morgan's	02026
Motorola	00869, 03110, 00856, 03469
Movistar	02527, 02262, 02263
MTEX	03539
Multichoice	00879, 02059, 02060
Murphy	02034
Mx Onda	02938
myfreeviewHD	02982
Mysat	02738
MySky Italia	02467
MySky New Zealand	01356, 02211
Nagra	02262
NanoXX	01631
NC+	00853, 01409
NEOTION	01334
NET	02262
Netgem	01322, 02455
Netsat	00099, 00887
Neuf TV	01322
Neuling	02458, 02026
Nevir	02938, 02728
Next	02231
Next Level	00869
Nextvision	01956
NextWave	01956

Nilox	02278
Nokia	00853
Nordmende	01611
Noru	02938
Nova	02475, 00879
NPG	02289, 01413, 01631
NTV Plus	01307, 01692, 02443
Octagon	02928
Olleh TV	03321
Olleh-Skylife	03321
Onn	02034, 01284
Openbox	01956, 02928
Opensat	02957, 01956, 02719
Opentech	02525
Opentel	02525
Optex	01626, 01413, 01611, 03012
Opticum	02957, 02797, 02932
Optus	01356, 00879
Orbis	01334
Orbitech	01195, 01100, 01197, 01099, 01351
Orchid	02289
Orion Express	01986
Orton	02957
P&T Luxembourg	01322, 02455

Pace	00847, 00887, 01356, 02754, 01682, 01175, 01693, 02475, 00853, 02231, 02467, 02631, 02657, 03469, 03790, 01377, 01662, 02097, 02211, 02059, 02060, 02466, 02796, 02160
Pacific	01284
Palcom	01611, 00299, 01409
Palsonic	02813
Panasat	00879
Panasonic	03494, 00847, 03099
Panda	00173
peekTon	02418
Philips	00099, 00853, 02561, 01499, 01442, 02466, 01114, 01672, 02619, 02211, 03110, 03469, 00173, 00856, 00887, 02631
Phoenix	01956, 02418
Phonotrend	01780
Pino	01334
Pioneer	00853
Pixel Magic	02982
PLDT	02835, 02836, 02289
PMB	01611
Polsat	02262, 02527, 00253, 00853
Portugal Telecom	02466
Premiere	01429, 01114, 01195, 01197

PremiumX	03374
Primacom	01176, 01195, 01197
Pro Basic	00853
ProLine	01284
PSI	03539
PT	02466
QooK TV	03321
Qook-Skylife	03321
Quelle	00299
Qwest	01377
RadioShack	00869
Radix	01255
Raduga TV	01986, 02957
RCA	01291, 01442, 02108
RCS	01416
Rebox	02928
RiksTV	01692
Rimax	02938
RIO Media	01780
Roadstar	00853
Rollmaster	01413
Ross	02540
SAB	01956, 01631, 04197, 01300
Saba	00740, 02205
Sagem	01692, 01690, 01114, 02553, 01307
Sagemcom	01692, 04024, 03789
Saivod	02418
Samart DTH	03576, 03574



## Reference Information

Samsung	03063, 00253, 01442, 01377, 02467, 01682, 01989, 03266, 00853, 01662, 02525, 03321, 03784, 03834, 03838, 01255, 01693
Sansui	01545
Sanyo	01626
Sat Control	01300
Sat Industrie	01611
SAT+	01409
SatCatcher	01956
Satforce	03374
Satplus	01100
SatyCon	01631
Schaub Lorenz	02034, 02418
Schneider	02842
Schwaiger	01672, 01429, 02308, 02458, 01631, 02797, 02813, 00740, 01334, 02957
Schwaiger CS	01631
Scott	02738
SCS	00299, 00740
Sede	01626
Sede Electronique	01626
SEG	01626, 01284, 02034
Sencor	02813
Servimat	01611
Set-One	03240, 02728
Shark	01631
Sharp	01935, 02034
Shaw Direct	00869
Sherwood	01409
Shinelco	02738, 02278, 02938

SHOI	02938
Siemens	00173, 01657, 01429, 02418, 01626, 01334, 01672
Sigmathek	02418, 02813, 02738
SignalMAX	01956
Silva	00299
Silva Schneider	00740
SilverCrest	02026, 02308, 02458, 02932
SKY	01662
Sky Austria	02754, 02443, 01429, 01114, 01915, 01195, 01197
Sky Brasil	01377, 03110, 00887, 00856, 00099, 01499, 02619
Sky Deutschland	02754, 02443, 01429, 01114, 01915, 01195, 01197
Sky Ireland	01175, 01662, 00847
Sky Italia	01693, 02467, 00853
Sky Mexico	00856, 02619, 00887, 01377, 03469
Sky New Zealand	02211, 00887, 00856, 01356
SKY PerfecTV!	03099, 02616, 03049
Sky UK	01175, 01662, 00847
SkyCable	01631, 01957
SkyLife	03321, 01255

Skylink	02957, 01545, 02443, 02928, 01195, 01197, 01986
Skymaster	01409, 02205, 01611, 02728, 02932, 01545, 01334
Skymax	01413
Skypex	00740
Skyplus	01334, 02026, 00740, 01175
SkySat	01100
Skytec	02928
Skyvision	02797, 01334
SkyWay	02928
Skyworth	01631, 02835, 02836
SL	00740, 02026, 00299, 01672
SM Electronic	01409
Smart	01631, 01413, 03095, 02289, 00740, 00299
Sogo	02842
Sonera	01780, 01957
Sony	01558, 00847, 00853, 03049
Spiderbox	03562
Star	00887
Star Choice	00869
Starmax	02638
Steinner	02738
Stream System	01300
Strong	01409, 02235, 01626, 02278, 02418, 02813, 00879, 03424, 00853, 01300, 03374, 01284, 01682

Sun Box	03571
Sun Direct	02525
Sunny	01300
Sunstech	02738
Supernova	00887
Supratech	01413
Systec	01334
Sytech	02418, 02842, 03012
S-ZWO	03374
TATA Sky	03575
TBoston	02418
TDS Telecom	00775
Teac	01957, 01322, 02813
Technical	01626
Technicolor	03469, 03790
Technika	01284, 01672, 02034
TechniSat	01197, 01195, 01100, 01099, 01351, 03440, 02813, 01322
Technoit	02278
Technosonic	01672
Technotrend	01429, 01672, 02263
Techwood	01284, 02034, 01626, 01935
Tecsat	01986
TEKCOMM	02738
Telasat	02466
TELE System	02750, 01611, 01409, 02739, 03726, 02813
Tele2	01195, 01197
Telefonica	01692, 02262, 02527, 02263
TeleSAT	02631, 02466



Reference Information

Telestar	01100, 01099, 01334, 01197, 02540, 01195, 01351, 01626, 01672
Televés	01300, 01334
Televisa	00887
TelkomVision	04310
Telsey	02738
TelSKY	02540
Telstra	01356
TELUS	00775
Tesla	01626
Tevion	02205, 01409, 01672, 02026, 02813
Thai	03573, 03539
Thomson	01291, 01935, 01662, 00847, 00853, 01175, 02278, 01307, 02160, 02619, 03110, 03469
Tiny	01672
Titan	02205
Tividi	01429
TiVo	01377, 01442
TivuSat	02750
T-Mobile	02631, 02443, 01545
TNT SAT	01692, 01195, 01197, 01986
Tokai	02938
Tonna	01611, 02458
Topfield	01545, 01986, 01208, 02838
Toshiba	01803, 01284, 01429
TPS	01307
Transparent Video Systems	01780, 01957

TrekStor	02738
Triax	01291, 01626, 00853, 01099, 01611, 01631
Tricolor TV	02622, 03064
True Visions	03140, 01208, 02408, 03784
TT-micro	01429
TV Cabo	02160
TV Star	03012
TV Vlaanderen	02631, 00853, 02466
TVA Digital	02895, 01692, 02262
TVB	01989
TVonics	01906, 01803
Twinner	01611
UEC	00879, 01356
UfaNet	01986
UNE	01692
United	02842, 02278, 03012, 01626, 02418
Unitymedia	01429, 01882, 01915
Universum	00173, 00299, 00740, 01099
Unixbox	01652
UPC	01780, 02443
UPC Cablecom	01195, 01197
UPC Direct	02443
Vantage	02797
Variosat	00173
VEA	02418
Vectra	01195, 01197
Vestel	01626, 01284, 02231, 02034, 03517
VH Sat	00299
Via Embratel	03787, 02796

Viasat	01682, 01197, 01195, 02235, 00253
Videocon	03077
Vietnam Television Corporation	03834
Viola Digital	01672
Vision	01626
VisionNet	01631
Visiosat	01413
Vistron	00740
Vitecom	01413
Viva	00856
Vivax	02418
Vivo	02262, 02895, 01692, 02527
Volcasat	02418
Voom	00869
VTC	03834
Vu+	03458, 02799, 03543
Walker	02034
Wavelength	01413
Wharfedale	01935, 02034, 01284, 01906
Winix	02278
Wintel	00299
Wisi	00740, 00173, 00299, 02957, 01986
Woxter	02418, 02813
Xoro	02813, 02738, 03012, 03422
Xtreme	01300
Xtrend	03320
Yakumo	01413
Yes	00887, 01887
Youview	03140
ZapMaster	00740

Zehnder	01777, 03422, 01334, 01413, 02289, 03424, 02034, 00740, 01631
Zenega	02604
Zenith	00856, 03110, 03469
Ziggo	02443, 01499, 01657, 00253
Zircon	02957
Zodiac	03726
Zon	02160
Zon Optimus	02160

■ Video - Accessory

A.C.Ryan	02709, 03350
ABS	01272
Acer	01272
Alienware	01272
Apple	02615
ASRock	01272
Boxee	03693
Ceton	01272
Claritas	01272
CyberPower	01272
Daily Media	01272
Dell	01272
Digitech	02260
D-Link	03671, 03693, 02186
Elonex	01272
Eminent	03215, 02260
Emtec	02709
Fantec	03350, 02709
Fujitsu Siemens	01272
Funai	03339
Gateway	01272
G-Box Midnight	04440
Hewlett Packard	01272



## Reference Information

hFX	01272
Howard Computers	01272
HP	01272
Hush	01272
iBUYPOWER	01272
iconBIT	03350, 02709
ICY Box	03350
iNext	03350
Iomega	02558
ISTAR	02260
JadooTV	02260
Keedox	04442
LG	03373
Linksys	01272
Magnavox	03339
Mede8er	02709
Media Center PC	01272
Micca	03669
Microsoft	01272, 01805, 04000
Mind	01272
Netgear	03324, 04401, 03292
NiveusMedia	01272
Northgate	01272
Omniverse	04421
Packard Bell	01272
Panasonic	03760
Philips	01272
Pivos	04339
PopBox	02260
Popcorn Hour	02260
RCA	03335
Ricavision	01272
Roku	03061, 02371
Seagate	02698
Sony	02713, 01272
Stack 9	01272
Sumvision	04339
Systemax	01272

Tagar Systems	01272
Toshiba	01272
Touch	01272
TrekStor	02723
Trust	01272
VIA Technologies	01272
Viewsonic	01272
VIZIO	03670
Voodoo	01272
Western Digital	02558
Woxter	02709
Xbox	01805, 04000, 01272
Xtreamer	02723
ZT Group	01272

## ■ CD

A.V.International	70157
ADVANTAGE	70032
AH!	70157
Aiwa	70157
Arcam	70157
Atoll	70157
Atoll Electronique	70157
Audio Research	70157
Audiolab	70157
Audiomeca	70157
Audioton	70157
AVI	70157
Balanced Audio Technology	
BAT	70157
Cairn	70157
California Audio Labs	70029, 70303
Cambridge	70157
Cambridge Audio	70157
Carver	70157
CCE	70157
Curtis Mathes	70029

Cyrus	70157
Denon	70766
DKK	70000
DMX Electronics	70157
Dynaco	70157
Epworth	70157
Genexxa	70032, 70000
Goldmund	70157
Grundig	70157
Harman/Kardon	70157, 73044
HIFIAkademie	70157
Hitachi	70032
JVC	70072
Integra	71817
Kenwood	70036, 70157
Krell	70157
Linn	70157
Loewe	70157
Magnavox	70157
Marantz	70157, 70029
Matsui	70157
MCS	70029
Memorex	70032
Meridian	70157
Micromega	70157
Miro	70000
Mission	70157
Myryad	70157
NAD	70721, 70000
Naim	70157
New Acoustic Dimension	70721, 70000
NSM	70157
Onkyo	71817
Optimus	70032, 70000
Panasonic	70303, 70029
Philips	70157
Pioneer	70032
Polk Audio	70157

Primare	70157
Proton	70157
QED	70157
Quad	70157
Quasar	70029
Radiola	70157
RCA	70032
Restek	70157
Revox	70157
Rotel	70157
SAE	70157
Sansui	70157
SAST	70157
Siemens	70157
Silsonic	70036
Simaudio	70157
Sonic Frontiers	70157
Sony	70000, 70490
Sylvania	70157
TAG McLaren	70157
TAG McLaren Audio	70157
Tandy	70032
Tascam	73095, 73511, 73533
Teac	73095, 73531, 73532, 73551
Technics	70303, 70029, 70207
Thorens	70157
Thule Audio	70157
Universum	70157
Victor	70072
Wards	70032, 70000, 70157
Yamaha	70036, 70032, 70490
Zonda	70157

## ■ Cassette Deck

Aiwa	40029
------	-------



## Reference Information

Arcam	40076
Audiolab	40029, 40229
Carver	40029
Denon	40076
Epworth	40029
Grundig	40029
Harman/Kardon	40029
Inkel	40070
JVC	40244
Kenwood	40070
Magnavox	40029
Marantz	40029
Myryad	40029
Onkyo	42157
Optimus	40027
Panasonic	40229
Philips	40029, 40229
Pioneer	40027
Polk Audio	40029
Radiola	40029
RCA	40027
Revox	40029
Sansui	40029
Sony	40243, 40170
Tascam	73095
Technics	40229
Thorens	40029
Universum	40029
Victor	40244
Wards	40027, 40029
Yamaha	40097

## ■ Receiver

Integra	52503
Onkyo	52503

## ■ Audio - Accessory

Apple	81115
Jamo	82228

Onkyo	81993, 82990, 82351, 82352, 82353
Polk Audio	82228

## ■ IPTV

ADB	02586, 01585, 01481, 01998, 02254, 02302, 02437, 03028
Aland	02030, 02437
Alands Datakommunikation	02030, 02437
Alcom	02030, 02437
Altibox	02437, 02030
Amino	01615, 01898, 01481, 02482, 01998, 02302, 03028
Arcadyan	02952
Arkwest	02482, 01481, 01998, 02302
Arris	01998, 02378
Arvig Communication Systems	01998, 02345
AT&T	00858
AT&T U-verse	00858
ATMC	03028
B tv	02681, 03442
BBTV	02980
BEK Communications	02254, 02302
Belgacom TV	02047, 02132
Bell	01998
Bell Aliant	01998
Bell ExpressVu	01998
Bell Fibe TV	01998
BesTV	04196
Bluewin	02271
Bouygues Telecom	03007
British Telecom	02294

BT	02294
BT Vision	02294
Cabovisao	02436
CalTel Connections	02586
Canal Digital	02030
Canby Telcom	01481, 02302
Celrun	03442
CenturyLink	01998
Channel Master	03118
China Telecom	04196, 02913, 03937
China Unicom	04366, 04196
CHT	03647, 01917
Chunghwa	03647, 01917
Cisco	00858, 03028, 02132, 02345, 02047, 02378, 01998, 02271, 03452
ClubInternet	02132
CNS	02980
Consolidated Communications	01998, 02302, 03048
Coship	04196
Deutsche Telekom	02132
DNA	02030
Du	02401
Echostar	03452
Elion	03916
Entertain	02132
Entone	02302, 03048
eTb	04281
Evertex	02302
Finnet	02030
Freebox	01976
Frontier Communications	02378
GDCATV	02980
Google	03666
Guangdong Cable	02980

Guangxi Broadcasting	02897
Guangxi Broadcasting Network	02897
Hana TV	02681
Hathw@y	02043
Hikari TV	03237
HSHONG	03937
Huawei	02994, 03937, 02913, 04281
i-CAN	02437
Innovative Systems	01898
Inotel	02437
Invitel	02437
InviTV	02437
ITV	04196
Jambox	02030
JP PTT	01615
Kaon	04409, 02682
kbro	03139
Kiss	02132, 02271
KoolConnect	01481
KPN	02952, 02437
Kreatel	02030
KT	02683
LG	02682
LG U+	02682
Linksys	02271
Lumos Networks	01998, 03028
Magio Sat	02132
Magnet	01615
Maige TV	03937
Matanuska Telephone Association	01481, 02254, 02482, 02586
Mega TV	02683
Meo	02401





## Reference Information

MHTC	01481, 01998, 02254, 02302, 02482
Minerva Networks	03118
MIO	02275, 02802
mio TV	02275, 02802
Mitsubishi Electric	03274
MM&G Enterprises	01481, 01998, 02302, 02482
MOD	03647, 01917
Motorola	02378, 02437, 01998, 02030, 00858, 02952, 02275, 03916, 01585, 02401
Movistar	01585, 03288
Moyo	03611
MTS	01998, 03611, 01615, 01481, 01898
MyLGTV	02682
Now TV	02009, 02014
NTT	03237, 03274
NU Telecom	01998, 03028
Numericable	02436
Oi TV	03452, 03454, 04165
Open IPTV	01615
Optimus Clix	02437
Orange	02407
Pace	01998, 00858, 03454, 02294, 02401
PCCW	02009, 02057
Philips	02378
Pioneer Telephone	02254, 02302
Portugal Telecom	02401
Primestar	02030
PrimeTel	02030, 02437, 03611
PrimeTV	02030

PT	02401
Qwerty	01898, 01481, 01615
Qwerty.TV	01898
Reliance	02556
RIO Media	02030
Rostelecom	03611
Sagem	02407, 03288
Sagemcom	02436, 02407, 03007
Samsung	02407
SaskTel	01998
Scientific Atlanta	00858, 02345, 02047, 02401, 03028, 02378
SetaBox	01917
SingTel	02275, 01998, 02802
SK Broadband	03442, 02681
SK Btv	02681, 03442
Sky Austria	02620
Sky Deutschland	02620
Smartlabs	03611
Smile Content	02437
Sogetel	01998
Sonaecom	02437
SureWest	01998, 01481, 02254, 02482, 02586
Swisscom	02271
TalkTalk	02994
TCC	04409
TDC	02271
Technicolor	02994
Telefonica	01585, 03028, 03288
Telekom Deutschland	02132
Telia	02030
TELUS	03028
TenET	01898

T-Home	02132
Thomson	03007, 02407
TVB	01615
U+ tvG	02682
U-verse	00858
Verizon	02378
Viasat	02030
Viken Fibernet	02030, 02437
Vivo	03288
Vodafone	02401
WNC	03118
Youview	02994
Yuxing	02014
Zinwell	03139
ZTE	04196

## ■ IPTV PVR Combination

ADB	01585, 02254, 02437
Altibox	02437
Amino	01615, 01898
Arcadyan	02952
Arris	01998, 02378
AT&T	00858
AT&T U-verse	00858
ATMC	03028
BBTV	02980
Belgacom TV	02047, 02132
Bell	01998
Bell Aliant	01998
Bell ExpressVu	01998
Bell Fibe TV	01998
Bluewin	02271
Bouygues Telecom	03007
British Telecom	02294
BT	02294
BT Vision	02294
Cabovisao	02436
Canal Digital	02030

CenturyLink	01998
CHT	03647
Chunghwa	03647
Cisco	03028, 02132, 00858, 02047, 02345, 02271, 02378, 03452
ClubInternet	02132
CNS	02980
Consolidated Communications	01998
Deutsche Telekom	02132
Du	02401
Echostar	03452
Elion	03916
Entertain	02132
Entone	03048
Freebox	01976
Frontier Communications	02378
GDCATV	02980
Glashart Media	01615, 01898
Google	03666
Guangdong Cable	02980
Hikari TV	03237
Huawei	02994
i-CAN	02437
Innovative Systems	01898
Invitel	02437
InviTV	02437
Kaon	04409
kbro	03139
Kiss	02132, 02271
KPN	02952, 02437
Linksys	02271
Lumos Networks	01998
Magio Sat	02132
Magnet	01615
Meo	02401
MetroNet	01998



## Reference Information

Minerva Networks	03118
Mitsubishi Electric	03274
MOD	03647
Motorola	01998, 02437, 02378, 02952, 00858, 03916, 01585, 02030, 02401
Movistar	01585
MTS	01998, 01615, 01481, 01898
NTT	03237, 03274
Numericable	02436
Oi TV	03452, 03454, 04165
Orange	02407
Pace	00858, 01998, 03454, 02294, 02401
Philips	02378
Portugal Telecom	02401
PrimeTel	02437
PT	02401
Qwerty	01898
Sagem	02407, 03288
Sagemcom	02436, 03007, 02407
Samsung	02407
SaskTel	01998
Scientific Atlanta	00858, 02047, 02401, 02345, 03028, 02378
Sky Austria	02620
Sky Deutschland	02620
SureWest	01998
Swisscom	02271
TalkTalk	02994
TCC	04409
TDC	02271
Telefonica	01585, 03028, 03288

Telekom Deutschland	02132
TELUS	03028
T-Home	02132
Thomson	03007
U-verse	00858
Verizon	02378
Vodafone	02401
WNC	03118
Youview	02994
Zinwell	03139

## ■ SAT\_PVR Combination

@sat	01300
ADB	02553
AEG	02738, 02813
Airtel	02248
Altech UEC	02097, 03517
Amiko	04197
Amstrad	01662, 01175, 02467, 01693
Arion	04348
Astro	03838
Atevio	02928
Atlanta	03320
Austriasat	01195, 01197, 02957, 02631
Auvisio	02932, 02738, 02813
Avanit	00299
Axil	03424
AZ America	01631
AZBox	02719
B@ytronic	00740
Bell	00775
Bell ExpressVu	00775
Bell Fibe TV	00775
Bell Satellite TV	00775
BENsat	02957
Boca	02797, 02308, 02813

Botech	02738, 03749
Boxer	01957
BSkyB	01175, 01662
Bush	02034
Canal Digitaal	02631, 02466, 02957
Canal Digital	02553
Canal+	02657
CanalSat	02657
CityCom	02957
Clarke-Tech	03320
Claro	03790
CMX	02932
Comag	02797, 02813, 02308
Coship	03790
Cyfrowy Polsat	02527
DCR	03517
Deutsche Telekom	01195, 01197
Digenius	00740
Digi	01195, 01197
Digihome	02034
DigiQuest	01300
Digital	02308
DigitAlb	01195, 01197
DigitalBox	02540, 03240
Digiturk	03517, 02097
Dilog	01957
DirecTV	01377, 01442, 00099
Dish Mexico	00775
Dish Network	00775
DishHD	04090
Dishpro	00775
DNA	01957
DragonSat	02928
Dream Multimedia	01237, 01923
D-Smart	02231
DSTV	02059, 02060

DTK Deutsche Telekom	01195, 01197
Dyon	02738, 02813
Easy-One	03240
Echostar	00775, 02527
Edision	01631
Elta	02738
Engel	03749
Etisalat	02443
Eurosky	00740
FaVal	03422
Ferguson	02638
Finnet	01957
Foxtel	01356
Freesat	01692, 02928, 03266
Freesat+	02443, 03266
Fuji Onkyo	01631
Galaxy Innovations	02799, 04197
General Satellite	03064
Gi	02799, 04197
GigaBlue	03663
Globo	02957
Golden Media	04197
GoldMaster	02928
Goodmans	02034
Grundig	02738, 03424
GVT	03789
Handan	01957
HD Box	02928
HD+	02797, 03095
Hirschmann	00740
Hitachi	02034
Hughes Network Systems	01442
Humax	02443, 01176, 01377, 03517, 01427, 01808, 02231, 02408, 02754



Reference Information

IceCrypt	04197, 02928
ID Sat	01334
Indovision	01989
iNETBOX	01237
Intv	04348
Inverto	03095
Jaeger	02797
JVC	00775
Kamosonic	02738
Kaon	01300
Kathrein	02569, 01561, 03658, 00658
Labgear	03424
LaSAT	00740
LinkBox	02957
LogiSat	02797, 02813
Luxor	01935
M vision	03562
M7	02631
Marusys	02799, 03543
Maspro	03099
Maximum	01334, 02813
Medion	02797, 00740
MegaSat	01631, 02813, 02034, 02738
Meo	02466
Mercury	03422
Micro	02797, 02813
Micro electronic	02308
Miraclebox	02928
Motorola	00869
Movistar	02527
Multichoice	02059, 02060
Mysat	02738
MySky Italia	02467
MySky New Zealand	01356, 02211
NEOTION	01334
Nova	02475
NTV Plus	01307, 01692, 02443

Octagon	02928
Openbox	02928
Opensat	02957, 02719
Opticum	02957, 02797, 02932
Orbitech	01195, 01197
Orton	02957
Pace	01682, 01175, 02754, 02475, 02231, 01356, 02467, 02631, 02657, 03790, 01662, 02097, 02211, 02059, 02060, 02466, 02895
Panasonic	03099
Philips	01442, 02466, 00099, 02631
Polsat	02527
Portugal Telecom	02466
PT	02466
Qwest	01377
Raduga TV	02957
RCA	01442
Rebox	02928
Ross	02540
SAB	04197
Sagem	01692, 02553, 01307
Sagemcom	03789, 01692
Samsung	03063, 01442, 01682, 01989, 02467, 01377, 03266, 01662, 03784, 03838, 01693
Sansui	01545
Sat Control	01300
Schwaiger	02308, 00740, 02957

SEG	02034
Set-One	03240
Sharp	02034, 01935
Shaw Direct	00869
Siemens	01657
SilverCrest	02308, 02932
Sky Austria	02754, 02443
Sky Brasil	01377
Sky Deutschland	02754, 02443
Sky Ireland	01175, 01662
Sky Italia	02467, 01693
Sky New Zealand	02211, 01356
SKY PerfecTV!	03099
Sky UK	01175, 01662
SkyCable	01631, 01957
Skylink	02957, 01545, 02443, 02928, 01195, 01197
Skymaster	02932, 01545
Skypex	00740
Skyplus	00740, 01175, 01334
Skytec	02928
Skyvision	02797
SkyWay	02928
Skyworth	01631
SL	00740
Smart	03095, 01631
Spiderbox	03562
Star Choice	00869
Starmax	02638
Stream System	01300
Strong	03424, 01300, 02813, 01682, 02278
Sunny	01300
TDS Telecom	00775
Teac	01957
Technicolor	03790

TechniSat	01197, 01195, 03440
Technotrend	01429
Techwood	02034
Telasat	02466
Telefonica	01692, 02527
TeleSAT	02631, 02466
Telestar	02540, 01195, 01197
TelkomVision	04310
TelSKY	02540
Telstra	01356
TELUS	00775
Thomson	01662, 01175, 01935, 01307, 02160
TiVo	01377, 01442
T-Mobile	02631, 02443, 01545
TNT SAT	01692
Topfield	01545, 02838
TPS	01307
Tricolor TV	03064
True Visions	03784
TV Cabo	02160
TV Vlaanderen	02631, 02466
TVA Digital	02895
TVonics	01906
UPC	02443
UPC Direct	02443
Vantage	02797
Vestel	02231, 03517
Via Embratel	02796
Viasat	01682, 01197, 01195
Vivo	02895, 01692, 02527
Vu+	03458, 02799, 03543
Wisi	00740, 02957



## Reference Information

Xoro	02738, 02813, 03422
Xtreme	01300
Xtrend	03320
Zehnder	03422, 03424, 01777, 02034, 00740
Ziggo	02443
Zircon	02957

## ■ TV\_DVD Combination

AEG	12197, 12239
Affinity	13870, 13717
Akai	12676, 13067, 12197
Akura	12289, 11983, 12239
Alba	12676, 13005, 13067, 12104
Apollo	12239
Audiosonic	12104, 11983
Audiovox	11769
Azuki	12239
Baier	12239
Bauer	12197
Beko	12239
Black Diamond	11037
Blaupunkt	12426
Blue Sky	11037
BlueDiamond	12426
Bush	13005, 12676, 11983, 12104, 10698, 11037
Celcus	12676
cello	12673
Centrum	11037
Coby	13627, 12315
Crown	11037
Currys Essentials	12486

Curtis	12855, 12466, 13895, 13636, 14035
Dantax	12676
Denver	12197, 13067, 12239
DGM	12239
Digihome	12676
Digimate	12239
Digitrex	13067
diVision	12197, 12239
Dual	12197, 12676, 11037
Durabrand	10171
D-Vision	12197
Dynex	12049
Easy Living	12104
ECG	12197, 12125
Electrohome	11670
Element	12964
Elfunk	11037
Emerson	11886, 11864, 11394, 10171
e-motion	12426
Enox.	12673
Essentials	12486
Favi	13382
Ferguson	13005, 12426, 11037, 12676
Finlux	12676
Funai	11394
Goodmans	11983, 11037, 11687, 12676, 12426
Gran Prix	12197
Grundig	12239, 12125, 12676
Haier	11753, 12309, 13429, 11749, 11983
Hantarex	12197

Hikona	11983
Hisense	13519
Hitachi	12676, 11037, 11667
Hyundai	12676
Ingo Devices	12239
Insignia	12049
iSymphony	13429
Jay-tech	13067
JMB	12676
JTC	13067
JVC	12271, 11670, 11774, 12676, 11601
Kuppersbusch	12676
Lenco	12676, 11983
LG	11860, 11423
Linetech	12676
Linsar	12676
Logik	13432, 13005, 12486, 11037, 11687
Luxor	12676, 11037
Magnavox	12372, 11866, 11454
Marks & Spencer	12673
Mascom	12197
Matsui	12486, 12676, 11037
Medion	12676, 12239, 13067
Memorex	11670
Memory	11983
MTLogic	12104
Murphy	12673
Mx Onda	11983
Naxa	12104, 13382
Neon	12673
Nikkei	12197
Nimbro	12104

Nordmende	13835
OK.	13434, 12676
OKI	12676
Orava	11037
Orion	11037, 12676
Otic	11983
Palsonic	13067
Panasonic	11291, 12170, 11636, 11480
Panavox	13835
Philips	13614, 12800, 10556, 11454, 11394, 12372
PHOENIX Apollo	12239
Polaroid	11769, 11523, 12676
Powerpoint	10698
Prima	11753
Pro Vision	12197
ProLine	12676
Proscan	12256, 13895, 13636
Prosonic	12676, 12197
QuantumFX	12337
RCA	12187, 12746, 12932, 11447, 12247, 13382
RefleXion	12239
Reoc	12197
Saba	12676
Saga	12197
Salora	12197, 12676, 12239
Sandstrom	12197
Sansui	11670, 13564
Sanyo	12676, 13488
Sceptre	12528, 12337
Schaub Lorenz	12197, 12289
Scott	11983
SEG	12673, 11037



Reference Information

Sencor	12197
Sharp	10818, 12676, 12360
Shinelco	12104
Shivaki	12197
Skyworth	12963
Soniq	12493, 13005
Sontech	11983
Sony	12778, 10000
Soundwave	11037, 12673
SOVOS	12239
Supersonic	11753, 12104
Swisstec	12106, 12104
Sylvania	11886, 11864, 11394, 10171
Taurus	12197
Teac	10698, 11983, 13005
Technica	11037, 12426
Technical	12676
Technika	12426, 12197, 12106, 11983, 13005
Techwood	12676
Telefunken	12239, 10698, 12676
Teletech	11037
Tesco	12426
Tevion	12426
Thomson	12675, 10625, 13047
Toshiba	13323, 12676, 11524, 11656
TVE	12239
UMC	12426, 12106
United	11037, 11983
VD-Tech	13067
Venturer	13005
Vestel	11037
Viewsonic	12049

Viore	13429, 12352, 12104, 13382, 13118
VisionPlus	12426
Walker	12676
Waltham	11037
Weltstar	11037
Westinghouse	11712
Wharfedale	11983
Xiahua	11753
Xiron	11983, 11037
Xoceco	11753
Xogego	11753
Xoro	13067
Zenith	10000, 10178
Xogego	11753
Xoro	13067
Zenith	10000, 10178



# ONKYO

## Onkyo Corporation

Kitahama Chuo Bldg, 2-2-22 Kitahama, Chuo-ku, OSAKA 541-0041, JAPAN

<http://www.onkyo.com/>

## The Americas

### Onkyo U.S.A. Corporation

18 Park Way, Upper Saddle River, N.J. 07458, U.S.A.

For Dealer, Service, Order and all other Business Inquiries:

Tel: 201-785-2600 Fax: 201-785-2650

<http://www.us.onkyo.com/>

For Product Support Team Only:

1-800-229-1687

<http://www.us.onkyo.com/>

## Europe

### Onkyo Europe Electronics GmbH

Liegnitzerstrasse 6, 82194 Groebenzell, GERMANY

Tel: +49-8142-4401-0 Fax: +49-8142-4208-213

<http://www.eu.onkyo.com/>

### Onkyo Europe Electronics GmbH (UK Branch)

Anteros Building, Odyssey Business Park, West End Road, South Ruislip, Middlesex, HA4 6QQ United Kingdom

Tel: +44 (0)871-200-1996 Fax: +44 (0)871-200-1995

## China

### Onkyo China Limited (Hong Kong)

Unit 1033, 10/F, Star House, No 3, Salisbury Road, Tsim Sha Tsui Kowloon, Hong Kong.

Tel: 852-2429-3118 Fax: 852-2428-9039

<http://www.hk.onkyo.com/>

### Onkyo China PRC (Mainland)

302, Building 1, 20 North Chaling Rd., Xuhui District, Shanghai, China 200032,

Tel: 86-21-52131366 Fax: 86-21-52130396

<http://www.cn.onkyo.com/>

## Asia, Oceania, Middle East, Africa

Please contact an Onkyo distributor referring to Onkyo SUPPORT site.

<http://www.intl.onkyo.com/support/>

The above-mentioned information is subject to change without prior notice.

Visit the Onkyo web site for the latest update.

SN 29402059PDF\_EN

(C) Copyright 2015 Onkyo Corporation Japan. All rights reserved. Onkyo has the Privacy Policy. You can review it at [<http://www.onkyo.com/privacy/>].

F1507-0



\* 2 9 4 0 2 0 5 9 \*

