

ASUS Tablet

e-MANUAL

ASUS

COPYRIGHT INFORMATION

No part of this manual, including the products and software described in it, may be reproduced, transmitted, transcribed, stored in a retrieval system, or translated into any language in any form or by any means, except documentation kept by the purchaser for backup purposes, without the express written permission of ASUSTeK COMPUTER INC. ("ASUS").

ASUS PROVIDES THIS MANUAL "AS IS" WITHOUT WARRANTY OF ANY KIND, EITHER EXPRESS OR IMPLIED, INCLUDING BUT NOT LIMITED TO THE IMPLIED WARRANTIES OR CONDITIONS OF MERCHANTABILITY OR FITNESS FOR A PARTICULAR PURPOSE. IN NO EVENT SHALL ASUS, ITS DIRECTORS, OFFICERS, EMPLOYEES OR AGENTS BE LIABLE FOR ANY INDIRECT, SPECIAL, INCIDENTAL, OR CONSEQUENTIAL DAMAGES (INCLUDING DAMAGES FOR LOSS OF PROFITS, LOSS OF BUSINESS, LOSS OF USE OR DATA, INTERRUPTION OF BUSINESS AND THE LIKE), EVEN IF ASUS HAS BEEN ADVISED OF THE POSSIBILITY OF SUCH DAMAGES ARISING FROM ANY DEFECT OR ERROR IN THIS MANUAL OR PRODUCT.

Products and corporate names appearing in this manual may or may not be registered trademarks or copyrights of their respective companies, and are used only for identification or explanation and to the owners' benefit, without intent to infringe.

SPECIFICATIONS AND INFORMATION CONTAINED IN THIS MANUAL ARE FURNISHED FOR INFORMATIONAL USE ONLY, AND ARE SUBJECT TO CHANGE AT ANY TIME WITHOUT NOTICE, AND SHOULD NOT BE CONSTRUED AS A COMMITMENT BY ASUS. ASUS ASSUMES NO RESPONSIBILITY OR LIABILITY FOR ANY ERRORS OR INACCURACIES THAT MAY APPEAR IN THIS MANUAL, INCLUDING THE PRODUCTS AND SOFTWARE DESCRIBED IN IT.

Copyright © 2015 ASUSTeK COMPUTER INC. All Rights Reserved.

LIMITATION OF LIABILITY

Circumstances may arise where because of a default on ASUS' part or other liability, you are entitled to recover damages from ASUS. In each such instance, regardless of the basis on which you are entitled to claim damages from ASUS, ASUS is liable for no more than damages for bodily injury (including death) and damage to real property and tangible personal property; or any other actual and direct damages resulted from omission or failure of performing legal duties under this Warranty Statement, up to the listed contract price of each product.

ASUS will only be responsible for or indemnify you for loss, damages or claims based in contract, tort or infringement under this Warranty Statement.

This limit also applies to ASUS' suppliers and its reseller. It is the maximum for which ASUS, its suppliers, and your reseller are collectively responsible.

UNDER NO CIRCUMSTANCES IS ASUS LIABLE FOR ANY OF THE FOLLOWING: (1) THIRD-PARTY CLAIMS AGAINST YOU FOR DAMAGES; (2) LOSS OF, OR DAMAGE TO, YOUR RECORDS OR DATA; OR (3) SPECIAL, INCIDENTAL, OR INDIRECT DAMAGES OR FOR ANY ECONOMIC CONSEQUENTIAL DAMAGES (INCLUDING LOST PROFITS OR SAVINGS), EVEN IF ASUS, ITS SUPPLIERS OR YOUR RESELLER IS INFORMED OF THEIR POSSIBILITY.

SERVICE AND SUPPORT

Visit our multi-language web site at: <http://support.asus.com>

Contents

	Conventions used	7
	Care and safety	7
1	Get your Zen ready!	
	Parts and features.....	9
	Installing a memory card.....	10
	Removing memory card	12
	Charging your ASUS Tablet.....	13
	Turning your ASUS Tablet on or off.....	15
	Basics.....	16
	Starting for the first time	17
	Using the touchscreen.....	19
	Using the Z Stylus (optional).....	22
2	There's no place like Home	
	Zen Home features	23
	Home screen	23
	Personalizing your Home screen	25
	App shortcuts	25
	Widgets	26
	Wallpapers	27
	Extended Home screen	28
	Easy Mode	28
	Setting up the date and time.....	30
	Setting up your alert sounds.....	30
	Quick settings	31
	System notifications	32
	Lock Screen	33
	Customizing your lock screen.....	33
	Customizing the quick access buttons.....	34
3	Keeping in touch	
	Managing contacts	39
	Launching the Contacts app.....	39
	Contacts Settings	39
	Setting up your profile	39
	Adding contacts.....	40
	Setting up your VIPs	42
	Marking your favorite contacts	45
	Importing contacts	46
	Exporting contacts.....	46
	Social networking with your contacts	47
	Linking your contacts' info	47
	Omlet Chat.....	48

4 Your precious moments

Capture moments	59
Launching the Camera app	59
Using Camera for the first time.....	60
Advanced camera features	64
Using the Gallery	70
Viewing files from your social network or cloud storage.....	70
Viewing the photo location	71
Viewing movies and videos	71
Sharing files from the Gallery.....	72
Deleting files from the Gallery.....	72
Editing images.....	72
Using MiniMovie.....	74
Using PlayTo	75

5 Work hard, play harder

Browser	77
Launching the Browser app.....	77
Sharing links	78
Reading the pages later	78
Adding a new tab	78
Bookmarking pages	78
Smartly read online	79
Clearing the browser cache.....	80
Email	80
Setting up email accounts.....	80
Adding email accounts.....	81
Setting up a Gmail account	81
Calendar	82
Creating events	82
Adding accounts to Calendar	82
Creating an event from your account	83
Enabling alert reminders for events	83
What's Next	84
Getting event reminders.....	84
Accepting or declining invites to events	85
Getting event-related alerts	86
Getting the weather updates.....	87
Do It Later	88
Adding to-do tasks	88
Prioritizing to-do tasks	88
Catching up on my online reading now	89
Deleting to-do tasks.....	89

SuperNote	90
Creating a notebook	91
Sharing a notebook on the Cloud	91
Sharing a note to the Cloud	91
Using the Z Stylus with SuperNote (optional)	91
File Manager	92
Accessing the internal storage	92
Accessing the external storage device	92
Accessing Cloud Storage	92
The Cloud	93
ASUS WebStorage	93
Data Transfer	94
ASUS Support	95
6 Fun and entertainment	
Using a headset	97
Connecting the audio jack.....	97
Play Games	98
Using Play Games	98
Music	99
Launching Music.....	99
Playing songs	99
Streaming Cloud music	100
Creating a playlist.....	101
PlayTo other devices.....	102
7 Staying connected	
Wi-Fi	103
Enabling Wi-Fi	103
Connecting to a Wi-Fi network.....	103
Disabling Wi-Fi.....	104
Bluetooth®	104
Enabling Bluetooth®	104
Pairing your ASUS Tablet to a Bluetooth® device.....	105
Unpairing your ASUS Tablet from the Bluetooth® device.....	105
Tethering	106
Wi-Fi Hotspot	106
Bluetooth Tethering.....	107
PlayTo	108
Launching PlayTo.....	108

8	Travel and Maps	
	Weather	109
	Launching the Weather app	109
	Weather home screen	110
	Clock	111
	World Clock	111
	Alarm clock	112
	Stopwatch	112
	Timer	113
9	ZenLink	
	Knowing ZenLink	115
	Share Link	115
	PC Link	116
	Remote Link	118
10	Zen Everywhere	
	Special Zen Tools	121
	Calculator	121
	Quick Memo	123
	Sound Recorder	124
	Audio Wizard	126
	Splendid	127
	Power Saver	130
11	Maintain your Zen	
	Keeping your device up-to-date	133
	Updating your system	133
	Storage	133
	Backup and reset	133
	Securing your ASUS Tablet	134
	Appendix	
	Notices	138

Conventions used

To highlight key information in this manual, some text are presented as follows:

IMPORTANT! This message contains vital information that must be followed to complete a task.

NOTE: This message contains additional information and tips that can help complete tasks.

CAUTION! This message contains important information that must be followed to keep you safe while performing tasks and prevent damage to your ASUS Tablet data and components.

Care and safety

Guidelines



Road safety comes first. We strongly recommend not to use your device when driving or operating any type of vehicle.



This device should only be used in environments with ambient temperatures between 0°C (32°F) and 35°C (95°F).



Turn off your device in restricted areas where the use of mobile devices is prohibited. Always obey rules and regulations when in restricted areas, such as, in aircraft, movie theater, in hospitals or near medical equipment, near gas or fuel, construction sites, blasting sites and other areas.



Use only AC adapters and cables approved by ASUS for use with this device. Refer to the rating label on the bottom of your device and ensure that your power adapter complies with this rating.



Do not use damaged power cables, accessories, and other peripherals with your device.



Keep your device dry. Do not use or expose your device near liquids, rain, or moisture.



You can put your device through x-ray machines (such as those used in conveyor belts for airport security), but do not expose the device to magnetic detectors and wands.



The device screen is made of glass. If the glass gets broken, stop using the device and do not touch the broken glass parts. Immediately send device for repair to ASUS-qualified service personnel.



Do not listen at high volume levels for long periods to prevent possible hearing damage.



Disconnect the AC power before cleaning your device. Use only a clean cellulose sponge or chamois cloth when cleaning your device screen.



Send device for repair to ASUS-qualified service personnel only.

Proper disposal



Risk of explosion if battery is replaced by an incorrect type. Dispose of used batteries according to the instructions.



Do not throw your device in municipal waste. This product has been designed to enable proper reuse of parts and recycling. The symbol of the crossed out wheeled bin indicates that the product (electrical, electronic equipment and mercury-containing button cell battery) should not be placed in municipal waste. Check local regulations for disposal of electronic products.



Do not throw the battery in municipal waste. The symbol of the crossed out wheeled bin indicates that the battery should not be placed in municipal waste.



DO NOT throw the device in fire. DO NOT short circuit the contacts. DO NOT disassemble the device.

WARNING: This product may contain chemicals known to the State of California to cause cancer, birth defects or other reproductive harm. Wash hands after handling.

Get your Zen ready!

1

Parts and features

Take a hold of your device and have it up and running in a jiffy.

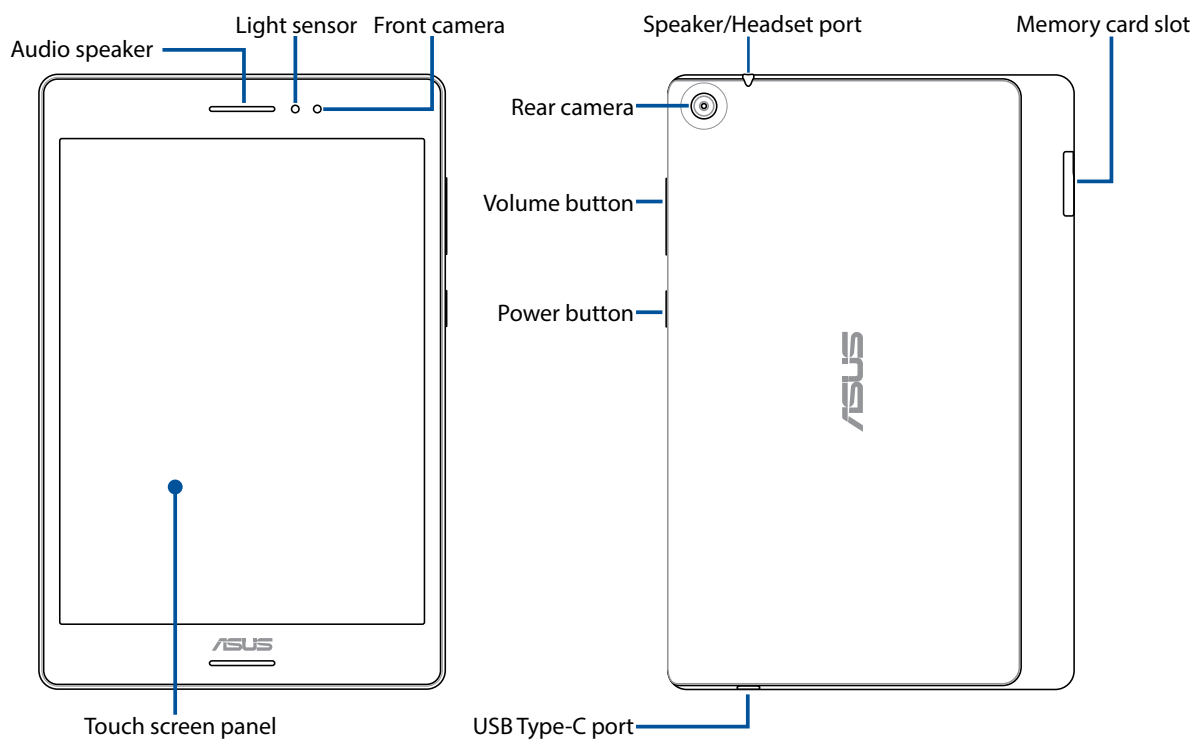

IMPORTANT! Keep the device, particularly the touch screen, dry all the time. Water or other liquids can cause the touch screen to malfunction.

Installing a memory card

Your ASUS Tablet supports a microSD™, microSDHC™, and microSDXC™ memory card with up to 128 GB of capacity.

NOTE: Some memory cards may not be compatible with your ASUS Tablet. Ensure that you use only compatible memory cards to prevent loss of data, damage to your device, or memory card, or both.

CAUTION! Be extra careful when handling a memory card. ASUS is not responsible for any data loss or damage incurred to your memory card.

To install a memory card:

1. Orient your device as shown, then open the memory card slot.

CAUTION!

- Be careful not to damage the slot cover or injure your fingernails when you remove the cover.
 - Do not forcibly remove, shear, or distort the memory card slot cover.
-

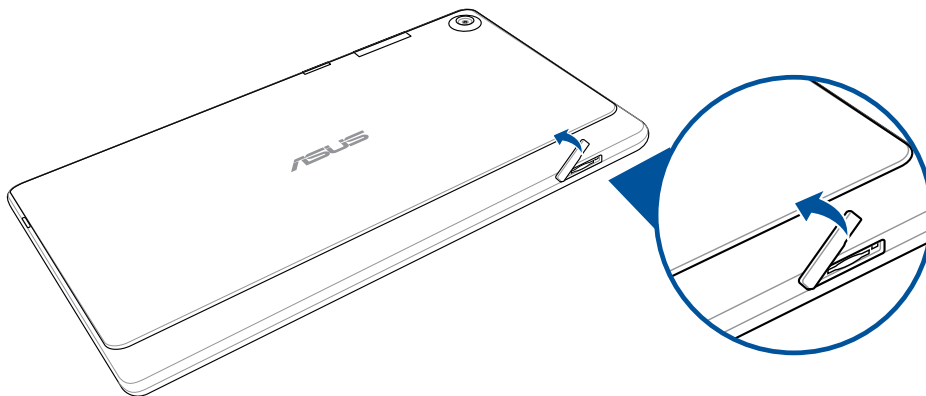

2. Align and insert a memory card into the memory card slot.
3. Push the memory card all the way into the slot until it is seated firmly in place.

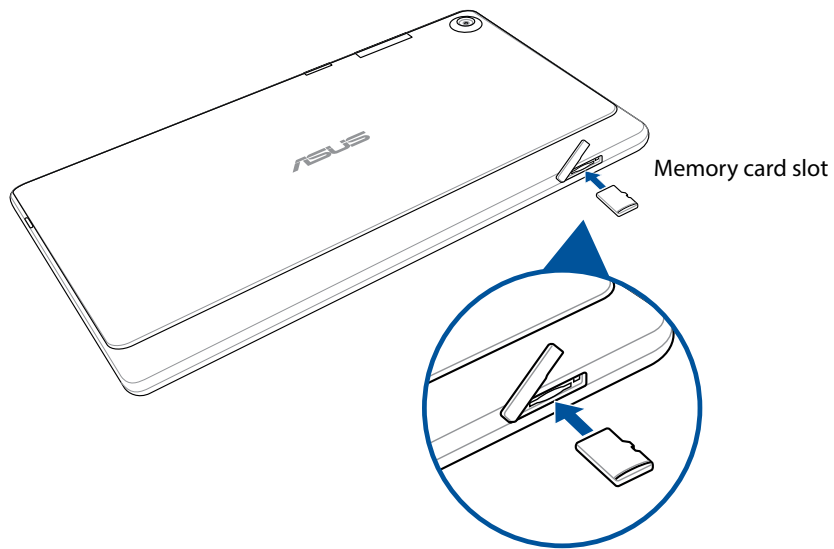

4. Put back the memory card slot cover.

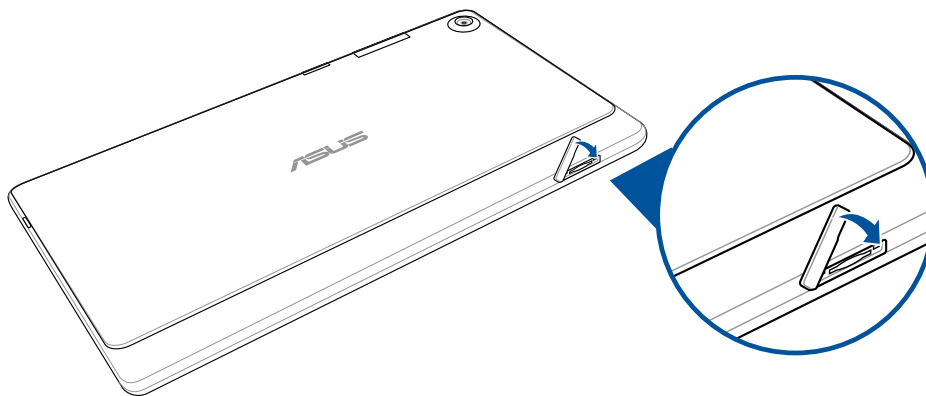

NOTE: After installing a formatted memory card, you can access its contents from **ASUS > File Manager > SD Memory Card**.

Removing memory card

CAUTION!

- Be extra careful when handling a memory card. ASUS is not responsible for any data loss or damage incurred to your memory card.
 - Eject the memory card properly to safely remove it from device. To eject the memory card, go to **Home > All Apps > Settings > Storage > Unmount external storage**.
-

To remove a memory card:

1. Orient your device as shown, then open the memory card slot.

CAUTION!

- Be careful not to damage the slot cover or injure your fingernails when you remove the cover.
 - Do not forcibly remove, shear, or distort the memory card slot cover.
-

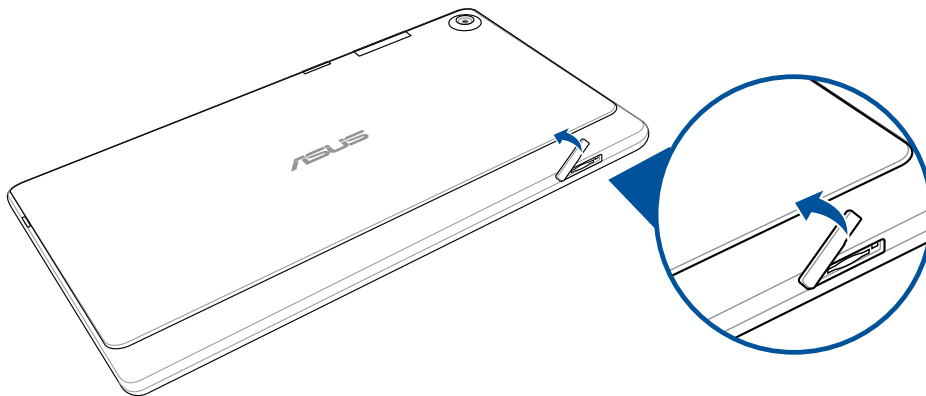

2. Press the memory card to eject, then pull it out.

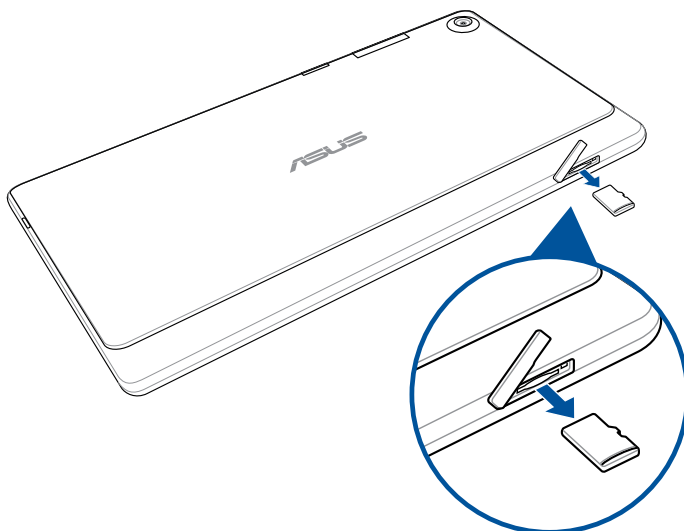

- Put back the memory card slot cover.

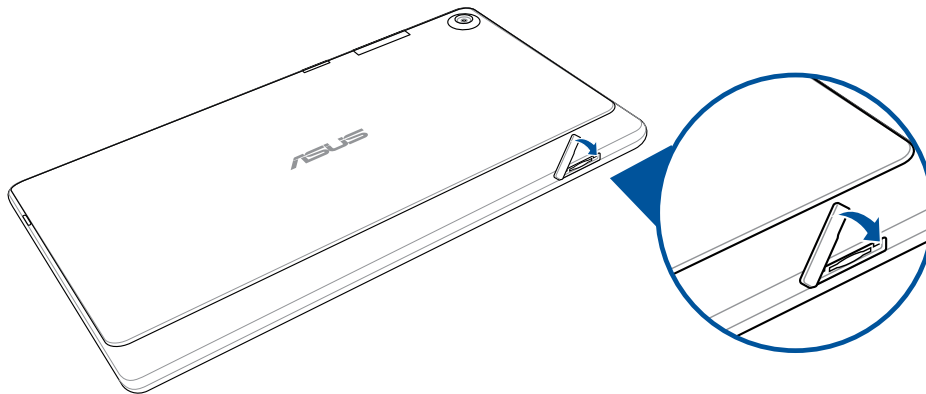

Charging your ASUS Tablet

Your ASUS Tablet comes partially charged but you must charge it fully before using it for the first time. Read the following important notices and cautions before charging your device.

IMPORTANT!

- Use only the bundled AC power adapter and USB Type-C cable to charge your ASUS Tablet. Using a different AC power adapter and cable may damage your device.
- Peel off the protective film on the AC power adapter and USB Type-C cable before using it with your device.
- Ensure to plug the AC power adapter to a compatible power outlet. You can plug the AC power adapter to any compatible 100~240 V outlet.
- The output voltage of the AC power adapter for this device is DC 5.2V, 1.35A.
- When using your ASUS Tablet while plugged-in to a power outlet, the power outlet must be near your device and easily accessible.
- To conserve electricity, unplug the AC power adapter from the power outlet when not in use.
- Do not place heavy objects on top of your ASUS Tablet.

CAUTION!

- While charging, your ASUS Tablet can become warm. This is normal, however, if your device becomes unusually hot, disconnect the USB Type-C cable from your device and send the device, including the AC power adapter and cable to an ASUS-qualified service personnel.
 - To prevent any damage to your ASUS Tablet, AC adapter, or USB Type-C cable. Ensure that the USB Type-C cable, AC adapter, and your device are connected properly before charging.
-

To charge your ASUS Tablet:

1. Connect the USB Type-C cable to the AC power adapter.
2. Plug the AC power adapter to a grounded power outlet.
3. Connect the USB Type-C cable to your ASUS Tablet.

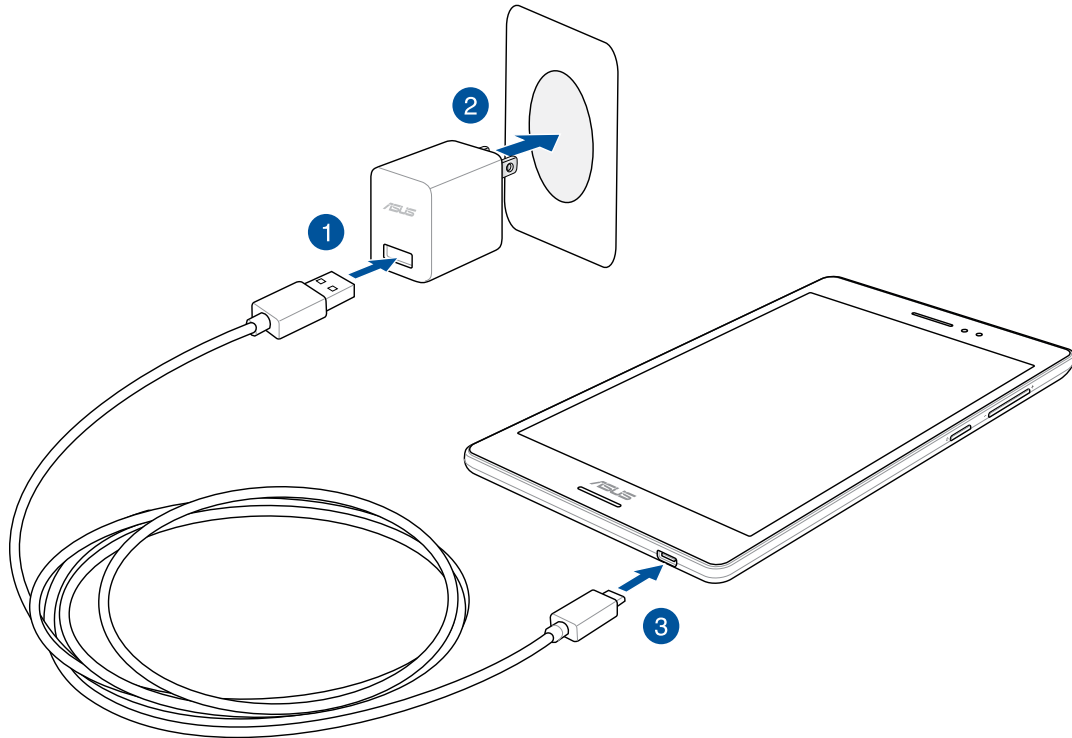

IMPORTANT!

- Charge your ASUS Tablet for eight (8) hours before using it in battery mode for the first time.
- The status of battery charge is indicated by the following icons:

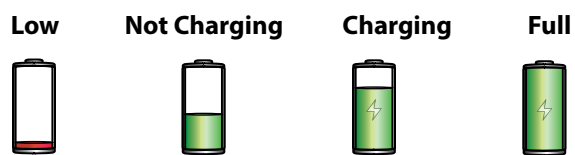

-
4. When fully-charged, disconnect the USB Type-C cable from your ASUS Tablet first before unplugging the AC power adapter from the power outlet.

NOTE:

- You can use your device while charging but it may take longer to fully charge the device.
 - Charging your device via USB port of a computer may take longer to fully charge the device.
 - If your computer does not provide enough power for charging via USB port, charge your ASUS Tablet using the AC power adapter plugged to a power outlet instead.
-

Turning your ASUS Tablet on or off

Turning your device on

To turn your device on, press and hold the power button until your device starts up.

Turning your device off

To turn your device off:

1. If your screen is turned off, press the power button to turn it on. If your screen is locked, unlock the device screen.
2. Press and hold the power button, then when prompted, tap **Power off** then tap **OK**.

Sleep mode

To put your device in sleep mode, press the power button once until the screen turns off.

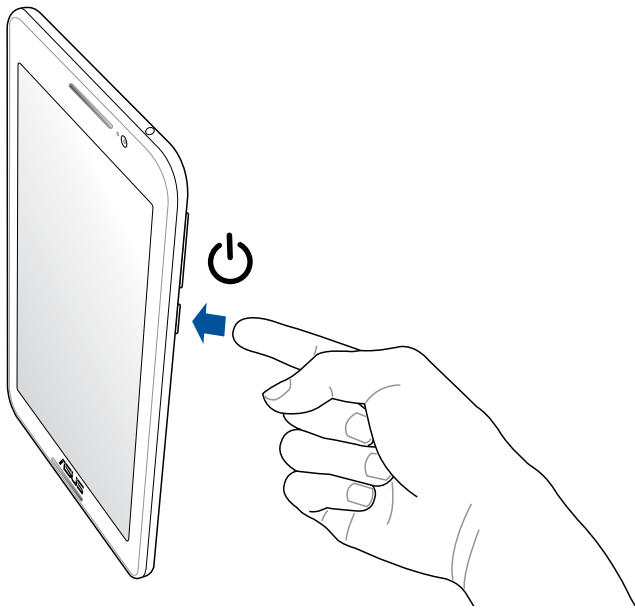

Basics

Explore the intuitive simplicity of ASUS Zen UI 2.0!

ASUS Zen UI 2.0 is a charming and intuitive interface exclusively for ASUS Tablets. It provides you with special apps, which are integrated in or with other apps, to fit your unique individual needs and make your life easier while letting you have fun with your ASUS Tablet.



[ASUS Support](#)

Find answers from FAQs (Frequently Asked Questions) or provide your feedbacks in the user forum.



[Camera](#)

With PixelMaster technology, capture those precious moments in vivid and high-quality photos and videos.



[Do It Later](#)

Get hold and act on your important emails, SMS messages, interesting websites, or other important tasks when it is more convenient for you to do so.



[What's Next](#)

View meeting details, emails, and other event alerts or notifications at a glance right from your Home screen, Lock Screen, or What's Next app.



[ZenLink](#)

Get maximum productivity from ZenLink, which comprises of Remote Link, Share Link, and PC Link apps. Use any of these apps to connect with other devices for sharing and receiving files.

NOTE: Availability of the ZenLink apps vary with ASUS Tablet models.

NOTE: Availability of ASUS Zen UI 2.0 apps vary per region and ASUS Tablet model. Tap  from your Home screen to check the apps available on your ASUS Tablet.

Starting for the first time

When you turn your ASUS Tablet on for the first time, Setup Wizard will guide you through the setup process. Follow the onscreen instructions to select your language, select input methods, set up your Wi-Fi, sync accounts, and configure your location services.

Use your Google or ASUS account to set up your device, if you do not have a Google or ASUS account yet, go ahead and create one.

Google Account

Using a Google Account allows you to fully utilize these Android OS features:

- Organize and see all your information from anywhere.
- Automatically backup all your data.
- Leverage Google services conveniently from anywhere.

ASUS Account

Having an ASUS Account allows you to enjoy the following perks:

- Personalized ASUS support service and warranty extension for registered products.
- Free 5 GB of Cloud storage space.
- Receive the latest device and firmware updates.

NOTE: You can also use the Setup Wizard to reconfigure your device, any time at your convenience. From the Home screen tap  > **Setup Wizard**.

Battery power conservation tips

The battery charge is the lifeline of your ASUS Tablet. Here are some battery power conservation tips that help preserve the power of your ASUS Tablet's battery.

- Close all running apps that are not in use.
- When not in use, press the power button to put the device in sleep mode.
- Activate Smart Saving in Power Saver app.
- Set audio to Smart Mode.
- Decrease brightness of display.
- Keep the speaker volume to a low level.
- Disable Wi-Fi feature.
- Disable Bluetooth feature.
- Disable PlayTo feature.
- Disable GPS.
- Disable the screen auto-rotate feature.
- Disable all auto-sync features in your device.

Using the touchscreen

Use these gestures on the touchscreen to launch apps, access some settings, and navigate your ASUS Tablet.

Launching apps or selecting items

Do any of the following:

- To launch an app, simply tap on it.
- To select an item such as in File Manager app, simply tap on it.



Moving or deleting items

Do any of the following:

- To move an app or widget, tap and hold then drag it to the location where you want it to be.
- To delete an app or widget from the Home screen, tap and hold then drag it to  **Remove**.



Moving through pages or screens

Do any of the following:

- Swipe your finger to the left or to the right to switch between screens or to flip through a Gallery of images.
- Scroll your finger up or down to go through web pages or list of items.

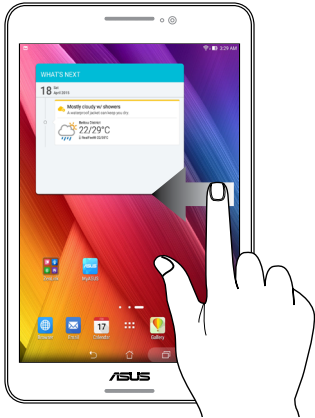

Zooming in

Spread apart your two fingers on the touch panel to zoom in an image in Gallery or Maps, or zoom in a web page.

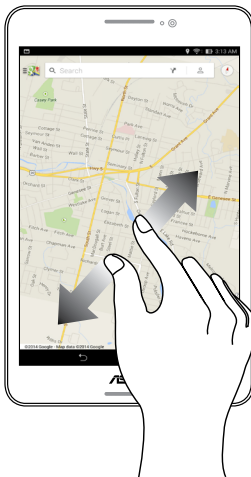

Zooming out

Bring together your two fingers on the touch panel to zoom out an image in Gallery or Maps, or zoom out of a web page.

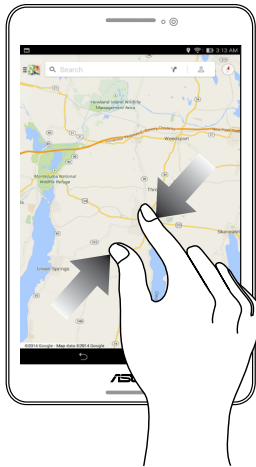

ZenMotion

When your touch screen panel is off, with these easy and intuitive gestures, you can launch apps on your ASUS Tablet in a snap by simply writing down an alphabet.

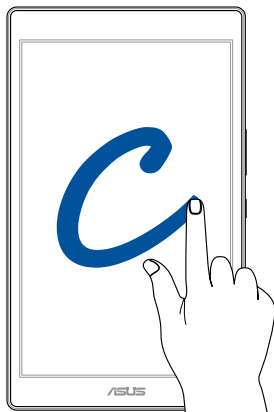



Gesture	Wi-Fi only models	3G / LTE (phone function) models
C	Camera	Camera
S	Calendar	Message
V	Gallery	Dialer
W	Browser	Browser
Z	ASUS Booster	ASUS Booster
e	Email	Email

Using the Z Stylus (optional)

Before using your Z Stylus for the first time, you will have to enable the Z Stylus feature on your ASUS Tablet.

To enable the Z Stylus feature:

1. Launch the Settings screen by doing any of the following:
 - Launch Quick settings then tap .
 - Tap  > **Settings**.
2. Scroll down the **Settings** screen and select **Z Stylus**.
3. Slide Z Stylus to **ON**.

NOTE:

- The Z Stylus is purchased separately.
 - A notification icon  will appear on the status bar to indicate the battery status of your Z Stylus.
 - Your Z Stylus will actively communicate with your ASUS Tablet when it is in close contact with the screen. Ensure to keep your Z Stylus away from the screen when not in use to save battery life.
 - Please visit <http://support.asus.com> for more information on the Z Stylus.
-

There's no place like Home

2

NOTE: Actual apps shown onscreen may vary per model. The following screenshot is for reference only.

Zen Home features

Home screen

Get reminders of important events, app and system updates, weather forecasts, and text messages from people who really matter to you, right from your Home screen.

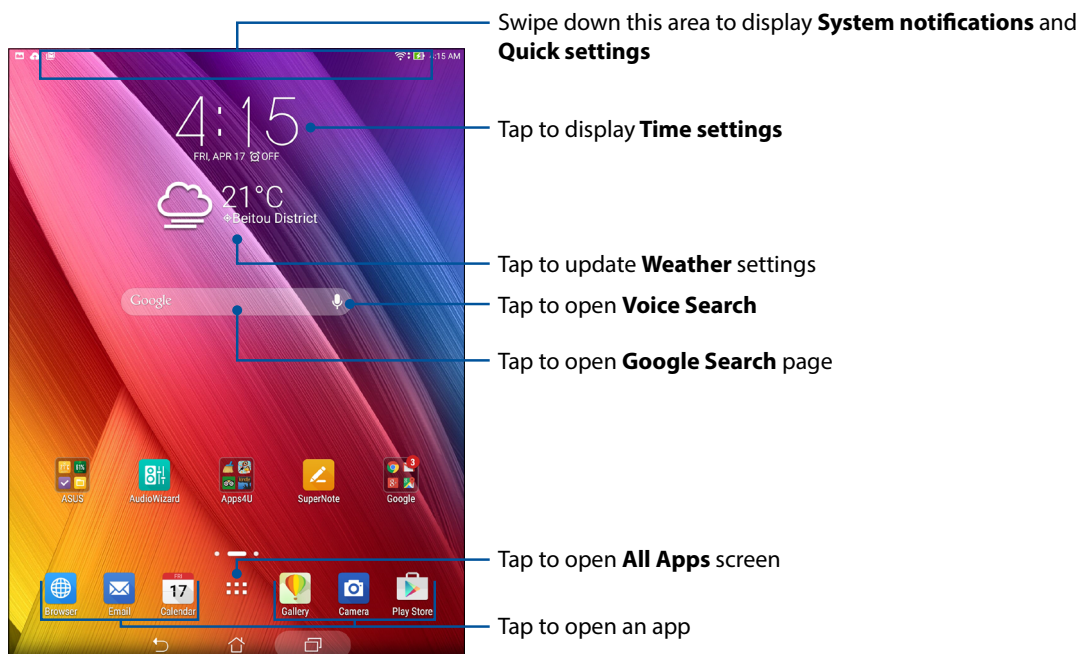













Swipe the Home screen to the left or right to display the extended Home screen.

NOTE: To add more pages to your Home screen, see [Extended Home screen](#).

Understanding notification icons

These icons are shown on the status bar and will guide you of the current status of your ASUS Tablet.

	Messages Shows that you have an unread message.
	Wi-Fi Shows the signal strength of your Wi-Fi connection.
	Battery life Shows the battery status of your ASUS Tablet.
	MicroSD card Shows that a microSD card is inserted in your ASUS Tablet.
	Screenshots Shows that you took screenshots of your ASUS Tablet.
	Airplane mode Shows that your ASUS Tablet is on Airplane mode.
	Wi-Fi Hotspot Shows that Wi-Fi hotspot of your ASUS Tablet is enabled.
	Smart Saving mode Shows that Smart Saving mode is enabled. NOTE: For more details, see Power Saver .
	Mute mode Shows that Mute mode is enabled.
	Vibrate mode Shows that Vibrate mode is enabled.
	Download status Shows the download status of an app or file.
	Bluelight Filter Mode Shows that Bluelight Filter mode is enabled. NOTE: For more details, see Bluelight Filter mode .
	Z Stylus battery status Shows the battery status of your Z Stylus. NOTE: <ul style="list-style-type: none">• This icon only appears if Z Stylus is enabled on your ASUS Tablet and a Z Stylus is in use.• Please visit http://support.asus.com for more information on the Z Stylus.

Personalizing your Home screen

Stamp your own personality on your Home screen. Select an attractive design as your wallpaper, add shortcuts for quick access to your favorite apps, and add widgets for a quick review of important info. You can also add more pages so you can add and quickly access or view more apps or widgets on your Home screen.

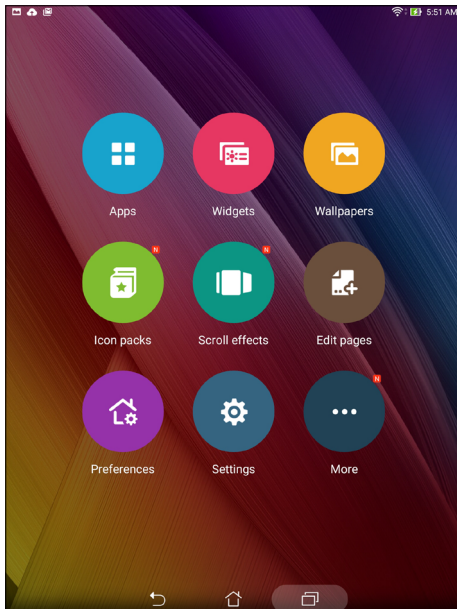

App shortcuts

App shortcuts make it easier to quickly-access your often-used or favorite apps from your Home screen. You can add, remove, or group your apps into one folder.

Adding app shortcuts

Add shortcuts to quickly access your often-used apps right from your Home screen.

1. Tap and hold an empty area on your Home screen and select **Apps**.
2. From the All Apps list, tap and hold an app, then drag it to an empty area on your Home screen.

Removing app shortcuts

From your Home screen, tap and hold an app, then drag it to  **Remove** on top of your screen. The app that you've removed from your Home screen will remain in the All Apps screen.

Grouping your app shortcuts in a folder

Create folders to organize your app shortcuts on your Home screen.

1. On your Home screen, tap and drag an app onto another app and a folder will appear.
2. Tap the new folder and tap **Unnamed Folder** to assign a name to this folder.

Widgets

You can put widgets, which are small dynamic apps, on your Home screen. Widgets provide you with quick-views of the weather forecast, calendar events information, battery status, and more.

Adding widgets

To add a widget:

1. Tap and hold an empty area on your Home screen and select **Widgets**.
2. From the Widgets screen, tap and hold a widget, then drag it to an empty area on your Home screen.

Removing widgets

From your Home screen, tap and hold a widget, then drag it to  **Remove** on top of your screen.

NOTE: You can also tap  on your Home screen to view All Apps and Widgets.

Wallpapers

Let your apps, icons, and other Zen elements sit on an attractively designed wallpaper. You may add a translucent background tint to your wallpaper for readability and clarity. You can also select an animated wallpaper to make your screen come alive.

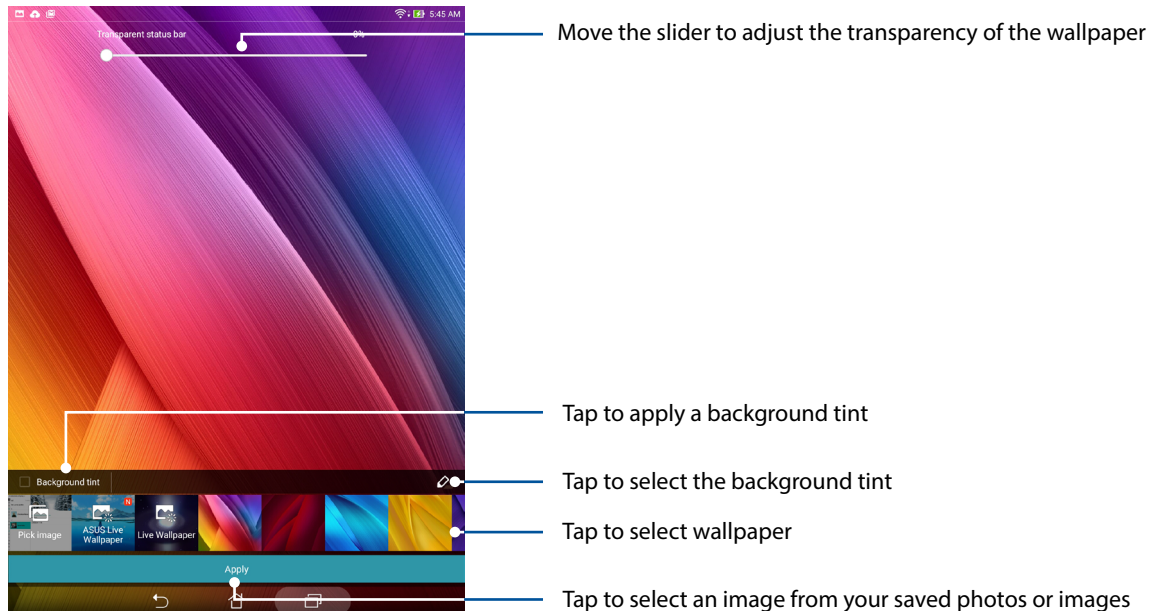

Applying wallpaper and background tint

To apply wallpaper and background tint:

1. Tap and hold an empty area on your Home screen and select **Wallpapers**.
2. Select where you want your wallpaper: on your **Home screen**, **Lock screen**, or **Home screen and Lock screen**. If you do not want to add a background tint to your wallpaper, skip to step 5.
3. Tick **Background tint**, then adjust the transparency level.
4. Tap  then select a color.
5. Select a wallpaper, then tap **Apply**.

Applying an animated wallpaper

To apply an animated wallpaper:



1. Tap and hold an empty area on your Home screen and select **Wallpapers**.
2. Select where you want your wallpaper: on your **Home screen**, or **Home Screen and Lock screen**.
3. Select an animated wallpaper, then tap **Apply**.

NOTE: You can also set up your wallpaper settings from  > **Settings** > **Display**.

Extended Home screen

Extending your Home screen

You can add more pages to extend your Home screen and put more app shortcuts and widgets on it.



1. Tap and hold an empty area on your Home screen and select **Edit page**.
2. Tap  to add a new page. If you wish to delete an extended Home screen, select then drag and drop it into .

Easy Mode

Navigate your ASUS Tablet better with Easy Mode, an intuitive interface with large icons, buttons, and font size for better readability and easier user experience. You can also quickly do your core tasks such as making calls, sending messages, and more in Easy Mode.

Enabling Easy Mode

To enable Easy Mode:

1. Launch the Settings screen by doing any of the following:
 - Launch Quick settings then tap .
 - Tap  > **Settings**.
2. Scroll down the **Settings** screen and select **Easy Mode**.
3. Slide Easy Mode to **ON**.

Adding shortcuts

In Easy Mode, you can add up to twelve (12) app shortcuts on the Home screen.

1. Swipe to the right of the Home screen, then tap **+**.
2. From the All apps screen, select the app that you want to add to the list.

Removing shortcuts

Do the following:

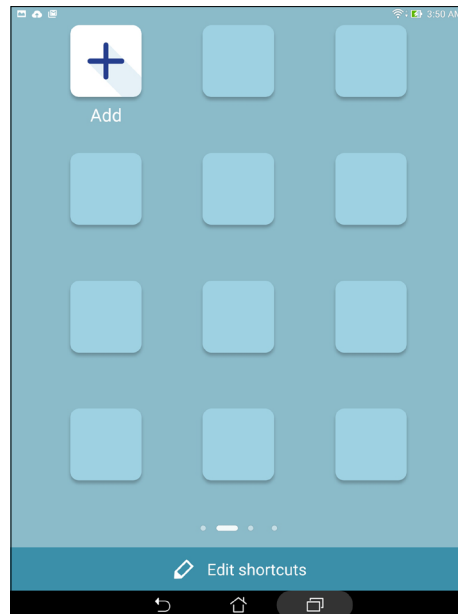
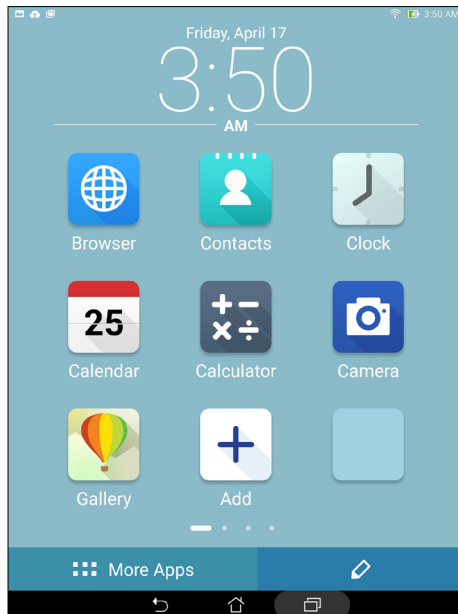

1. Tap  then select the app or apps that you want to remove from the list.
2. Tap **Delete** to remove the app shortcut.



Setting up the date and time

By default, the date and time displayed on your Home screen automatically syncs when you are connected to the internet.

To change the date and time settings:



1. Launch the Settings screen by doing any of the following:
 - Launch Quick settings then tap .
 - Tap  > **Settings**.
2. Scroll down the **Settings** screen and select **Date & time**.
3. Uncheck **Automatic date & time**.
4. Select the time zone and manually set the date and time.
5. You can opt to use the 24-hour format, if you prefer.
6. Select the date format that you want to display.

NOTE: See also [Clock](#).

Setting up your alert sounds

Set up the sound for your notifications such as messages, emails, and event alerts. You can also choose to enable or disable the touch sounds or screen lock sound.

To set up the sound settings:

1. Launch the Settings screen by doing any of the following:
 - Launch Quick settings then tap .
 - Tap  > **Settings**.
2. Scroll down the Settings screen and select **Sound & notification**.
3. Set up your preferred sound settings.

Quick settings

The Quick settings panel provides a one-tap access to some of the wireless features and settings of your ASUS Tablet. Each of these features are represented by a button.

To launch the Quick settings panel, swipe down with two fingers from the top of your ASUS Tablet.

NOTE: A blue button indicates that the feature is currently enabled while a gray button indicates a disabled feature. The green buttons refer to individual utilities that you can quickly access via the Quick Settings Notification Panel.

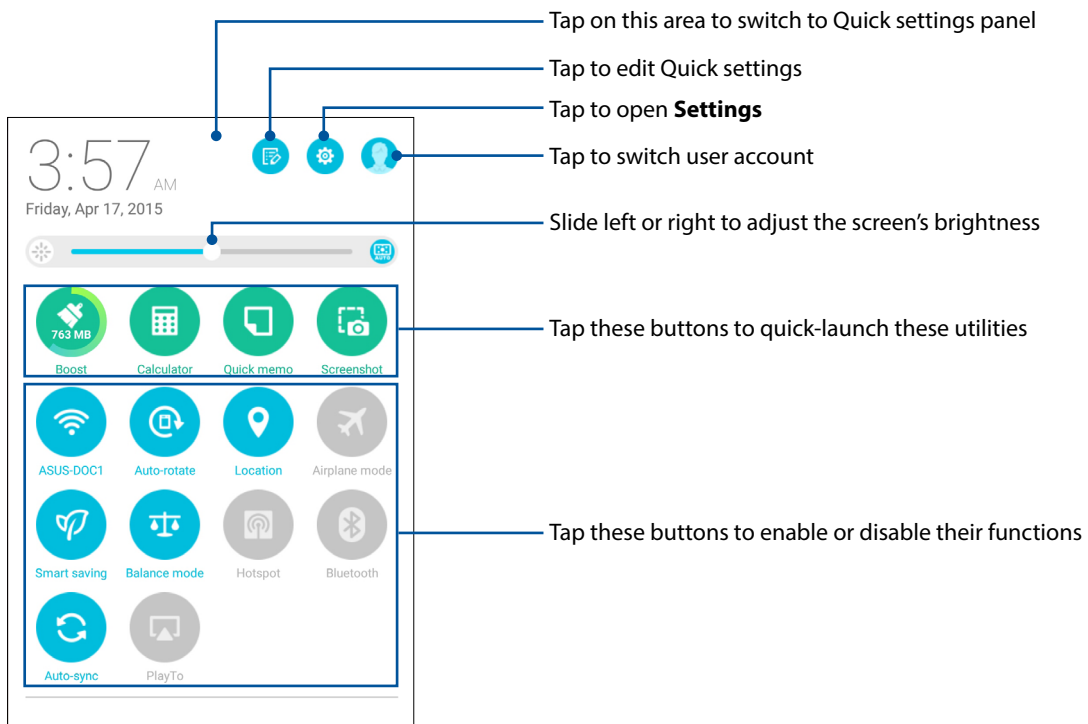

Adding or removing buttons

To add or remove existing buttons from the ASUS Quick settings notification panel:

1. Launch Quick settings then tap .
2. Tap the box beside the feature to add or remove it from the ASUS Quick settings notification panel.

NOTE: A checked box indicates that the feature's button is accessible via the ASUS Quick settings notification panel while an unchecked box means the opposite.

3. Tap  to go back and view the current ASUS Quick settings notification panel.

System notifications

From System notifications, you can see the latest updates done and system changes made on your ASUS Tablet. Most of these changes are data and system-related.

To launch the System notifications panel, swipe down with two fingers from the top of your ASUS Tablet.

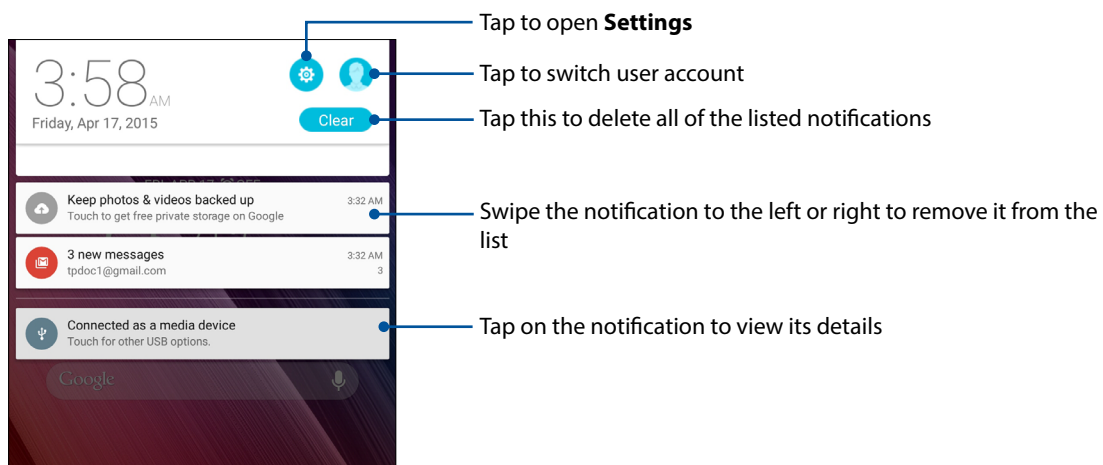

Lock Screen

By default, the lock screen appears after turning on your device and while waking it up from sleep mode. From the lock screen, you can proceed to your device's Android system by swiping on your touch screen panel.

Your device's lock screen can also be customized to regulate access to your mobile data and apps.

Customizing your lock screen

If you want to change your lock screen settings from the default **Swipe** option, refer to the following steps:

1. Launch Quick settings then tap .
2. Scroll down the **Settings** screen and select **Lock screen**.

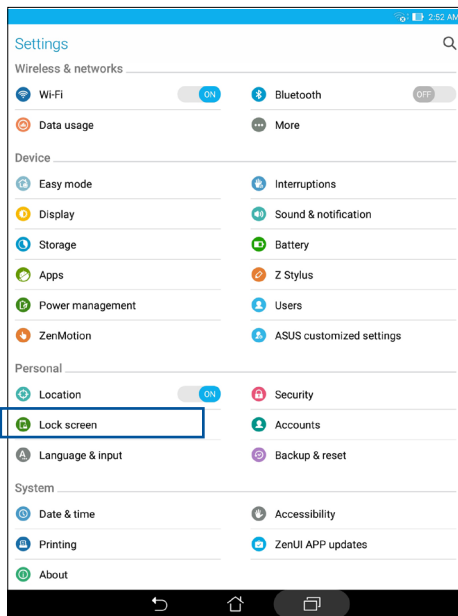

3. In the next screen, tap **Screen lock**.

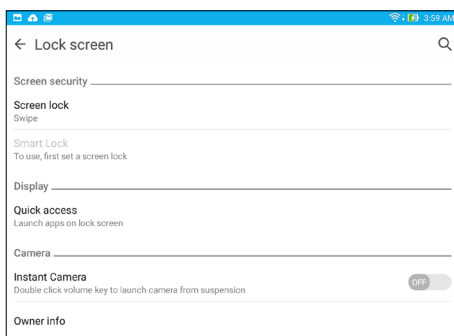

4. Tap the screen lock option you would like to use.

NOTE: For more details, see [Securing your ASUS Tablet](#).

Customizing the quick access buttons

By default, your lock screen includes quick access buttons for these apps: Messaging, and Camera. Change this default settings and customize these buttons to launch other apps on the lock screen using the following steps:

1. Launch Quick settings then tap .
2. Scroll down the **Settings** screen and select **Lock screen**.
3. Tap **Quick access**.
4. Under the Quick access screen, select which button you would like to customize.

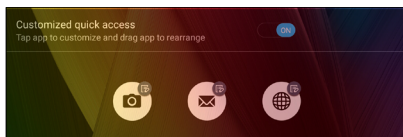

5. Tap the app you would like to preset on the quick access button you chose to configure.

NOTE: Scroll up or down to view the current list of apps you can preset.

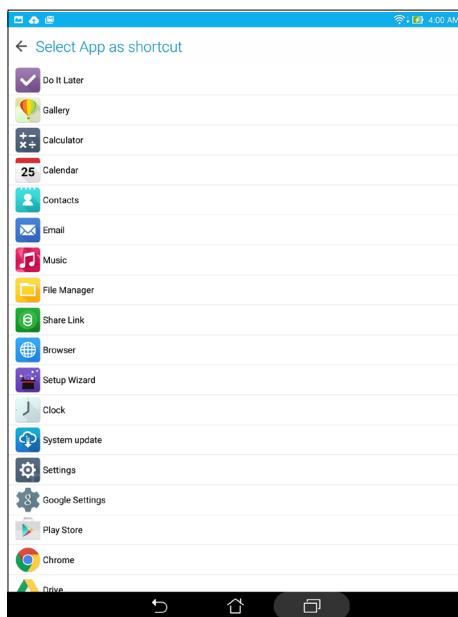



Voice Search

Make voice commands to your ASUS Tablet then watch it listen and take action using the Voice Search app. Using Voice Search, you can make voice commands to accomplish the following:

- Search for data and information online or on your ASUS Tablet
- Launch apps inside your ASUS Tablet
- Get directions going to a location

IMPORTANT! Your ASUS Tablet must be connected to the Internet to be able to use this feature.

Launching Voice Search

1. Launch the Voice Search app by doing any of the following:
 - Tap  on the Google search bar.
 - Tap  > **Voice Search**.
2. Once the mic icon turns red, start saying your voice command.

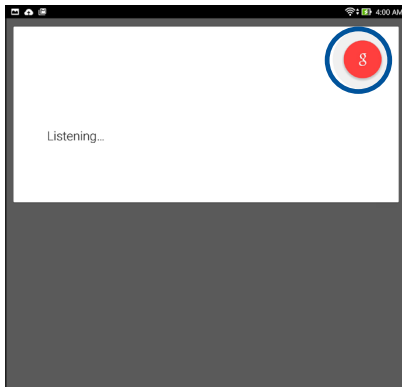

NOTE: Speak clearly and use concise phrases when talking to your ASUS Tablet. It also helps to start your commands with a verb related to the ASUS Tablet feature you want to use.

Customizing voice search results from the Tablet search group

If you want to set parameters for the voice search results gathered from your Google account and your ASUS Tablet's data, you may do so using the following steps:

1. On your ASUS Tablet's home screen, tap  > **Voice Search**.

NOTE: You need to log into your Google account to customize the settings.

2. Tap  > **Settings**.

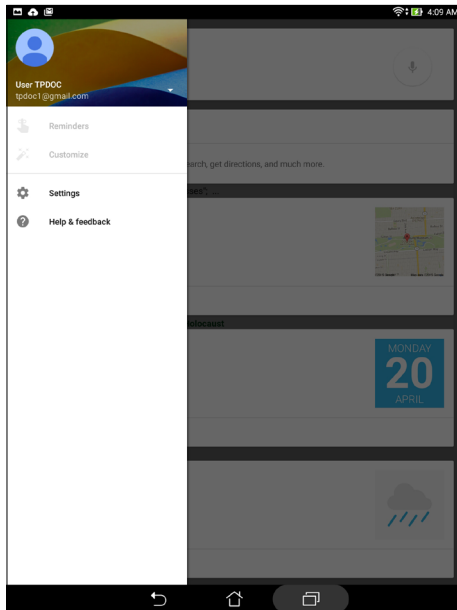

3. Tap **Tablet search**.

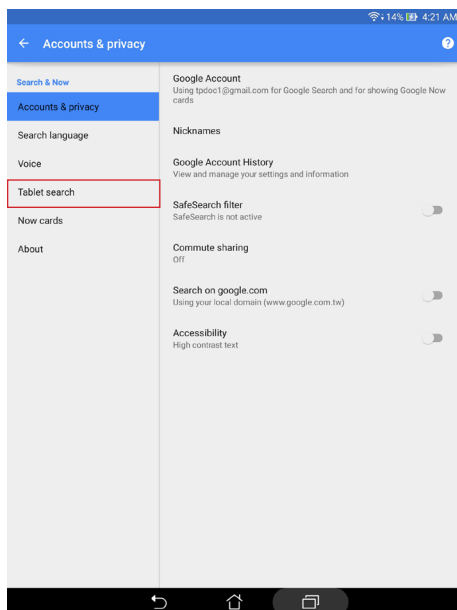

4. Tick the box of the search groups you would like to include as source when using **Voice Search**.

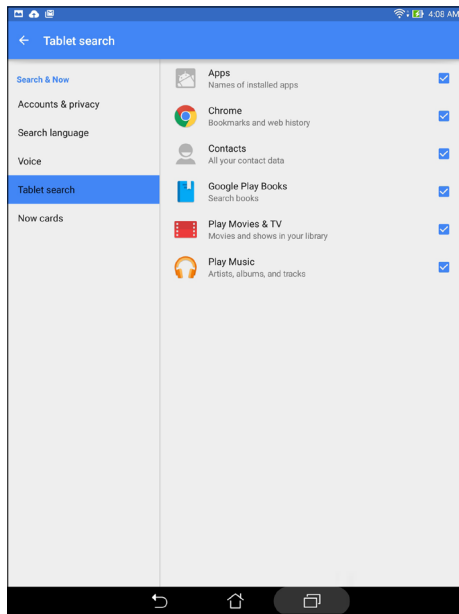

Keeping in touch

3

Managing contacts

Organize your contacts and easily stay in touch with them via emails, or social networks. Group your contacts as Favorites to quickly get in touch with them, or group them as VIPs to get notified about any upcoming events.

You can also sync your contacts with your email or social network accounts, link contacts' info for easy access in one place, or filter the contacts you want to keep in touch with.

Launching the Contacts app

From your Home screen, do any of the following to launch the Contacts app:

- Tap **Asus > Contacts**
- Tap  > **Contacts**

Contacts Settings

Select how you would want to display your contacts from the Contacts settings. Such display options include displaying only those contacts with phones, sorting list by first/last name, or viewing contact names as first/last names first. You can also choose which of these tabs to display on your Contacts screen: **Favorites, Groups, VIP**.

To set up your Contacts settings, tap  > **Settings** from the Contacts app.

Setting up your profile

Make your ASUS Tablet truly your own and set up your profile info.

1. Launch the Contacts app then tap **Set up my profile** or **ME**.

NOTE: ME appears when you've set up your Google account on your ASUS Tablet.

2. Fill in your info such as mobile or home number. To add other info, tap **Add another field**.

3. When you've completed your info, tap **Done**. To view your profile info, swipe down from the top right of your screen to launch the Quick settings panel, then tap the button with your profile picture on it.

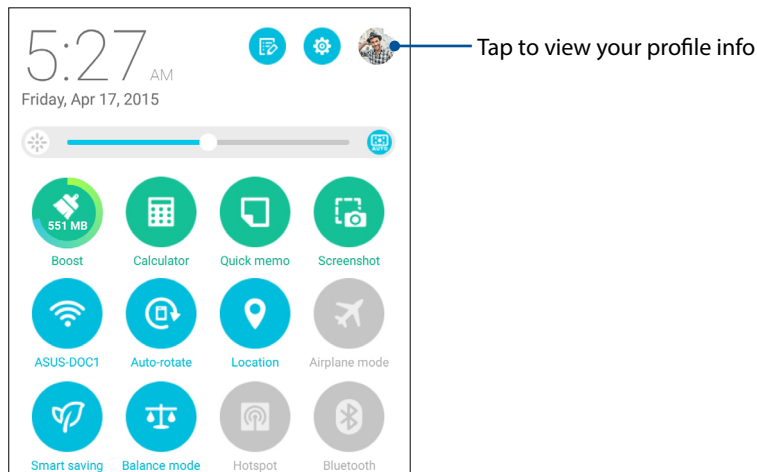

Adding contacts

Add contacts to your device, corporate, Google, or other email accounts and fill in more important contact information such as contact numbers, email addresses, special events for VIPs, and more.

1. Launch the Contacts app then tap **+**.
2. Select **Device**.

NOTE:

- You can also save the contact to your email account.
 - If you don't have an email account, tap **Add account** then create one.
-

3. Fill in the necessary information such as mobile or home number, email address, or group where you want to put the contact in.
4. After filling in the information and you want to add more contact numbers or email addresses, tap **New**.
5. If you want to add other contact information, tap **Add another field**.
6. When you've completed the info, tap **Done**.

Adding an extension number to a contact number

You can add an extension number to a contact's number.

1. From the Add contact screen, fill in the necessary fields.
2. On the Phone field, key in the main line then tap **,** or **;**, and add the extension number.

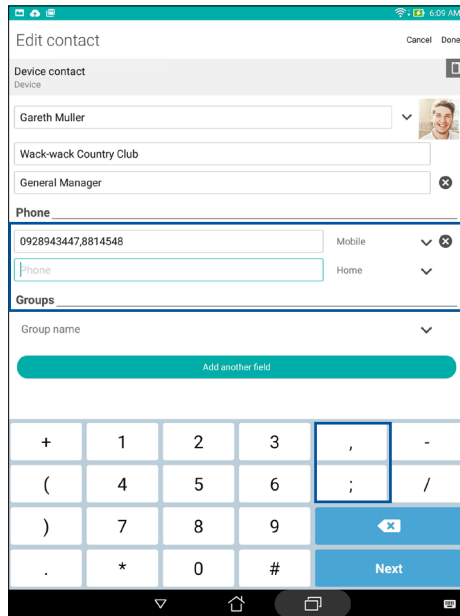

Note:

- Use **,** as a separator of the main line and the extension number when you want to skip the voice prompt.
 - Use **;** as a separator of the main line and the extension number when you want to confirm the extension number first before proceeding the call.
-

3. Tap **Done** to save the number.

Customizing your contact's profile

Edit your contact's info, add a photo, or take a photo as a cover for your contact's profile.

1. Launch the Contacts app then select the contact whose info or profile you want to edit or customize.
2. Make the changes from the contact's profile page.

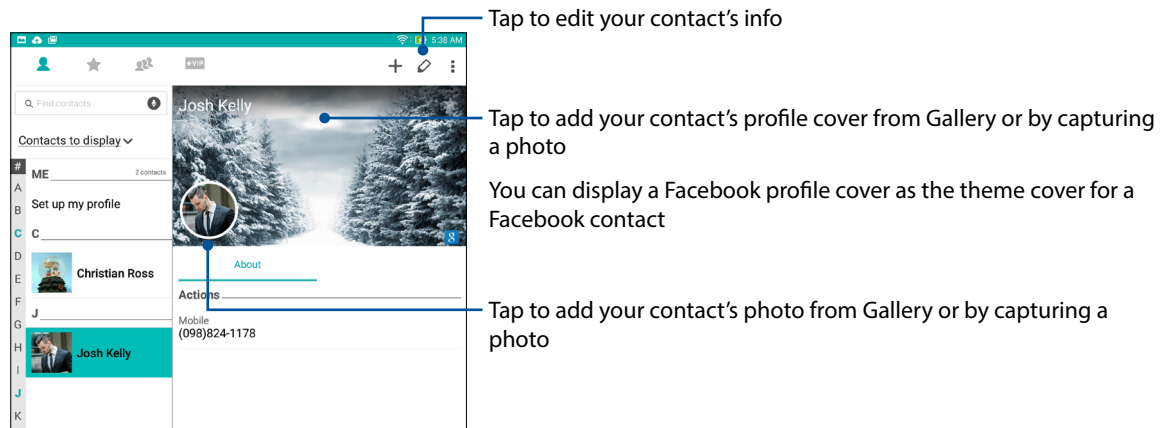

Setting up your VIPs

Group your contacts as VIPs to get notified about upcoming anniversaries, birthdays, and other important events. You'll also get alerts about any unread emails from your VIPs. You'll get all these notices as your What's Next alerts and reminders.

NOTE: For more details, see [What's Next](#).



Set up your VIP from the Contacts app home screen

To set up your VIP from the Contacts app home screen:

1. Launch the Contacts app, tap and hold the contact you want to set up as a VIP, then select **Add to VIP group**.

Set up your VIP from the Groups screen

To set up your VIP from the Groups screen:

1. Launch the Contacts app.
2. Tap  > **VIP**.
3. In the VIP screen, tap .
4. Select the contact or contacts you want to group as VIPs, then tap **Add**. The contact or contacts are added to your VIP list.

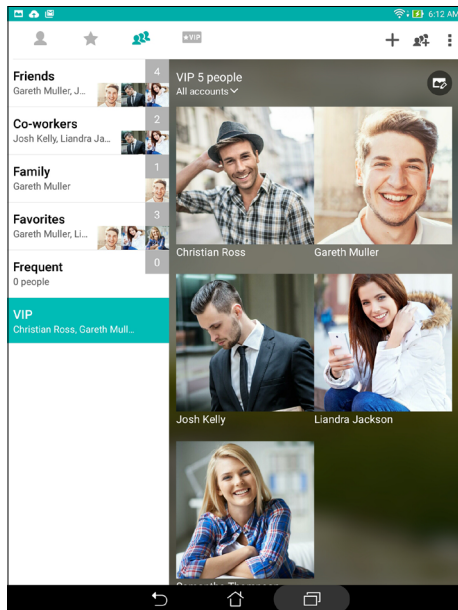

Set up your VIP from the VIP screen

To set up your VIP from the VIP screen:

1. Launch the Contacts app.
2. Tap **★VIP**.
3. In the VIP screen, tap **+**.
4. Select the contact or contacts you want to group as VIPs, then tap **Add**. The contact or contacts are added to your VIP list.

Adding an event to a VIP contact

You can add an event to a VIP contact such as anniversary, birthday, and other important events.

1. Launch the Contacts app, tap the contact you want to add an event detail to, then tap .
2. In the contact's info screen, tap **Add another field > Events**.

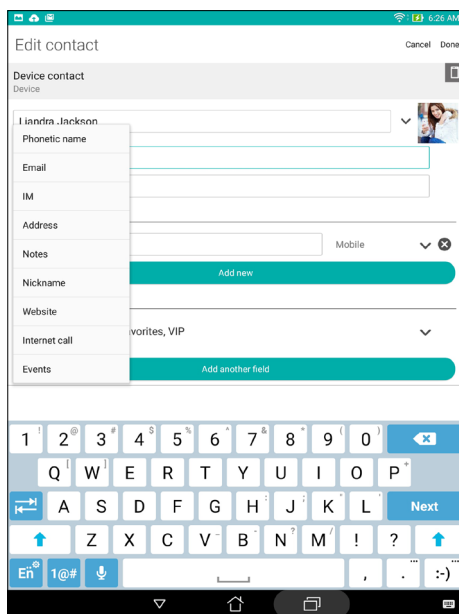



3. Select the date for the event, then tap **Set**.
4. Ensure that you select **VIP** under the Group field. When finished, tap **Done**.
5. The contact's special event will appear in your calendar of events. If you want to get an event alert, set the reminder time in the Calendar app.

NOTE:

- Set the reminder time for events in [Calendar](#) to get [What's Next](#) event alerts or reminders.
 - Aside from getting upcoming events reminders, you'll also get new email notifications from What's Next. For more details, see [What's Next](#).
-

Marking your favorite contacts

Set your frequently-accessed contacts as your favorites to be able to locate them quickly from the Contacts app.

1. Launch the Contacts app by doing any of the following:
 - a. From the Home screen, tap **ASUS > Contacts** app.
 - b. From the All Apps screen, tap **Contacts** app.
2. From the Contacts app screen, tap  then tap .
3. Tick the boxes of the contacts that you wish to add to Favorites.

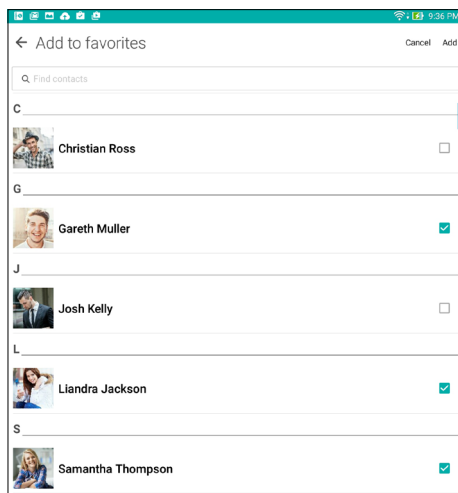

4. When done, tap **Add**. All contacts that you added appears on Favorites screen.

Importing contacts

Import your contacts and their respective data from one contact source to your ASUS Tablet, or email account.

1. Tap **Asus > Contacts** then tap  > **Manage contacts**.
2. Tap **Import/export** then select **Import from storage**.
3. Select from the following accounts to save the contact:
 - a. Email account/s
 - b. Device
4. Tick to select the contacts that you wish to import and when done, tap **Import**.

Exporting contacts

Export your contacts to any of the storage accounts in your ASUS Tablet.

1. Tap **Asus > Contacts** then tap  > **Manage contacts**.
2. Tap **Import/export** then select **Export to storage**.
3. Tap to select the contacts from the following accounts:
 - a. All contacts
 - b. Email account/s
 - c. Device
4. Tick the contacts that you want to export.
5. When done, tap **Export**.



Social networking with your contacts

Integrating the social network accounts of your contacts makes it easier for you to view their profiles, news, and social feeds. Stay updated with the activities of your contacts in real time.

IMPORTANT! Before you can integrate social network accounts of your contacts, you need to log in to your social network account and sync its settings.

Syncing your social network account

Sync your social network account to add the social network accounts of your contacts to your ASUS Tablet.

1. Do any of the following to launch the Settings app:
 - Launch Quick settings then tap .
 - Tap  > **Settings**.
2. From the Settings screen, tap your social network account under Accounts section.
3. Tick **Contacts** to sync the social network accounts of your contacts.
4. Launch the Contacts app to view your contacts list.
5. To view only your contacts with social network accounts, tap **Contacts to display** then untick the other contact sources, leaving the social network name checked.
6. When done, tap  or anywhere on the screen.

Linking your contacts' info

When you add social network or email accounts, data from these accounts automatically sync with the Contacts app. In some instances, some contact info may appear in several places or under different name variations or nicknames in the Contacts app. You can manually link and unify all these info and put them under one place or profile.

1. From the Contacts app, tap and hold the contact whose info you want to link, then select **Link contact**.
2. From the contact's profile page, tap .
3. Select all the contact profiles that you think should be linked to one profile, then tap **Link**. You can now view and retrieve all your contact's info under one profile.

Omlet Chat

Omlet Chat is an open messaging and mobile sharing app that lets you chat with friends on the spot. It also allows you to manage your data by storing them securely to your private Cloud accounts.

NOTE:

- Omlet Chat app may only be available in some countries.
 - On its first use, you have to visit Play Store to update Omlet Chat. You must have a Google account to update Omlet Chat.
-

Registering to Omlet Chat

Register to Omlet Chat with any of the following accounts:

- Mobile phone number
- Email account
- Gmail account
- Facebook account

Using your mobile phone number

To register using mobile phone number:

1. Tap  then tap **Omlet Chat**.
2. On the Sign Up screen, swipe the screen to the left to read highlighted features of Omlet Chat. If you want to register immediately, tap **Skip**.
3. Select the country that you are currently located, key in your mobile phone number, then tap **Next** to receive a text message containing the PIN.
4. Key in the PIN then tap **Next**.
5. Key in your name then tap **Get Started**.
6. Tap **Okay! Let's do it!** to update your friends from your contacts list. Tap **No thanks** to add your friends manually to your contacts list.

NOTE: Your Omlet contacts are automatically integrated to your contacts list in Contacts app. Refer to section [Viewing your Omlet contacts from Contacts app](#) for more information.

Using your Google™ account

To register using your Google™ account:

1. Tap  then tap **Omlet Chat**.
2. On the Sign Up screen, tap **Connect a different account here** then tap **Google**.
3. Tap **OK** to use the Google account that you registered with your device.
4. Key in your name then tap **Get Started**.
5. Tap **Okay! Let's do it!** to update your friends from your contacts list. Tap **No thanks** to add your friends manually to your contacts list.

NOTE: Your Omlet contacts are automatically integrated to your contacts list in Contacts app. Refer to section [Viewing your Omlet contacts from Contacts app](#) for more information.

6. Tap  to display the Omlet Chat menu.

Using your email account

To register using your email account:

1. Tap  then tap **Omlet Chat**.
2. On the Sign Up screen, tap **Connect a different account here** then tap **Email**.
3. Key in your email account then tap **Next**. Omlet Chat app will send a confirmation email to your email account.
4. From your email account, open the confirmation email from Omlet then tap the link to activate your account.
5. Key in your name then tap **Get Started**.
6. Tap **Okay! Let's do it!** to update your friends from your contacts list. Tap **No thanks** to add your friends manually to your contacts list.

NOTE: Your Omlet contacts are automatically integrated to your contacts list in Contacts app. Refer to section [Viewing your Omlet contacts from Contacts app](#) for more information.

7. Tap  to display the Omlet Chat menu.

Using your Facebook® account

To register using your Facebook account:

1. Tap  then tap **Omlet Chat**.
2. On the Sign Up screen, tap **Connect a different account here** then tap **Facebook**. Omlet Chat app will take you to Facebook screen to log in to your Facebook account.
3. Log in to your Facebook account then tap **OK**.
4. Key in your name then tap **Get Started**.
5. Tap **Okay! Let's do it!** to update your friends from your contacts list. Tap **No thanks** to add your friends manually to your contacts list.

NOTE: Your Omlet contacts are automatically integrated to your contacts list in Contacts app. Refer to section [Viewing your Omlet contacts from Contacts app](#) for more information.

6. Tap  to display the Omlet Chat menu.

Sending Omlet invites



Invite your friends to use Omlet Chat by sending them Omlet invites to their email or Facebook account.

Sending Omlet invites via Facebook

To send an Omlet invite via Facebook:

1. From the Omlet Chat screen, tap  to display Omlet Chat menu.
2. Tap **Contacts** then tap **Add/Invite friends**.
3. From the Add contacts screen, tap **Invite Facebook friends**.
4. Log in to your Facebook account then tap **OK** to let Omlet Chat access your account.
5. Tap **+** to select the contacts then tap **Send**.



Sending Omlet invites via email

1. From the Omlet Chat screen, tap  to display Omlet Chat menu.
2. Tap **Contacts** then tap **Add/Invite friends**.
3. From the Add contacts screen, tap **Invite address book friends**.
4. Tick to select the contacts, then tap .

Using Omlet chat

Send text and multimedia messages for a fun, creative, and interactive conversation.

To start a conversation:

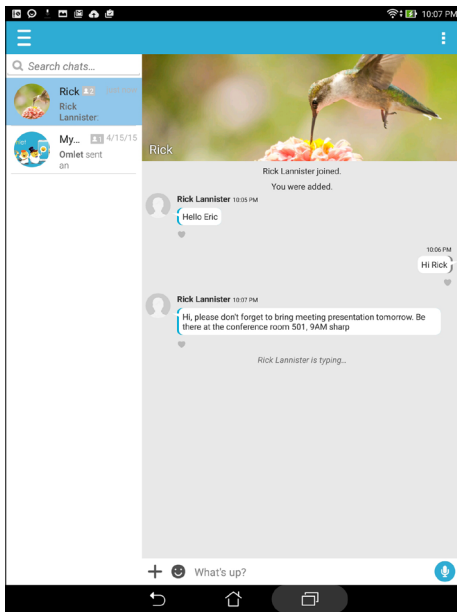

1. From the Omlet Chat screen, tap  to display Omlet Chat menu then tap **Contacts**.
2. Tap the contact that you wish to chat then tap .



Sending a chat message



To send a chat message, key in your message in **What's up** field then tap .

Sending a voice message

To send a voice message, tap and hold  while saying your message then release  to send.

Sending a virtual sticker

To send a virtual sticker, tap  then select from the available virtual stickers.

NOTE: You can download more virtual stickers from Sticker Store. To download the virtual stickers, tap  >  then tap .

Using drawer apps

Omlet Chat features these value-added drawer apps, allowing you to share multimedia messages for a more fun and personal touch.

To use these drawer apps, tap **+** from the chat thread then select an app from the drawer app list to send a specific multimedia message.

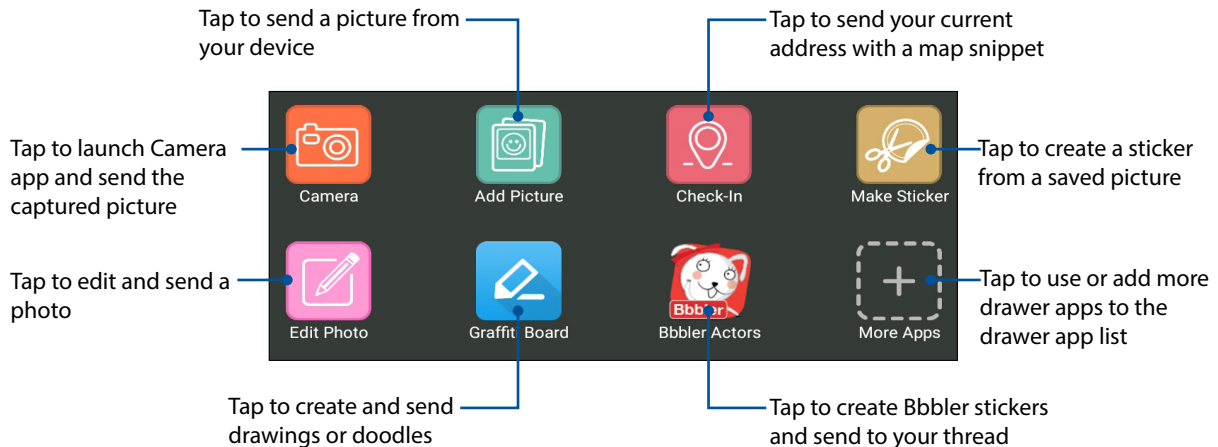

More drawer apps

Aside from the default apps in the drawer app list, there are other apps listed in your Omlet Chat app that you can use. Simply tap **+** from the chat thread, then tap **+** to view more drawer apps.

Using other drawer apps

To use other drawer app, tap **+** then tap an app to launch it.

Adding more drawer apps to the drawer app list

Tap **+** to view more apps, then tap **+** to pin the app.

NOTE: The drawer apps may vary depending on location.

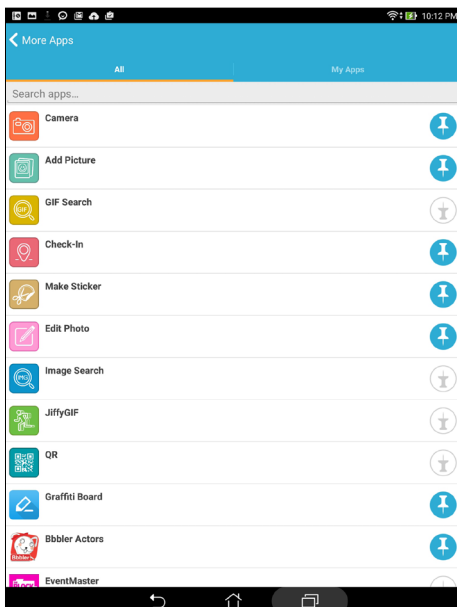

Viewing shared photos in Gallery app

The photos that you and your friends have shared in the Omlet Chat app's chat room are instantly saved to your device. You can view the shared photos using the Gallery app.

To view the shared photos:

1. Launch the Gallery app by doing any of the following:
 - a. From the Home screen, tap **ASUS** > **Gallery** app.
 - b. From the All Apps screen, tap **Gallery** app.
2. From the Gallery main screen, tap  then select from the following options:
 - a. All shared photos
 - b. Chat room
 - c. Sharer

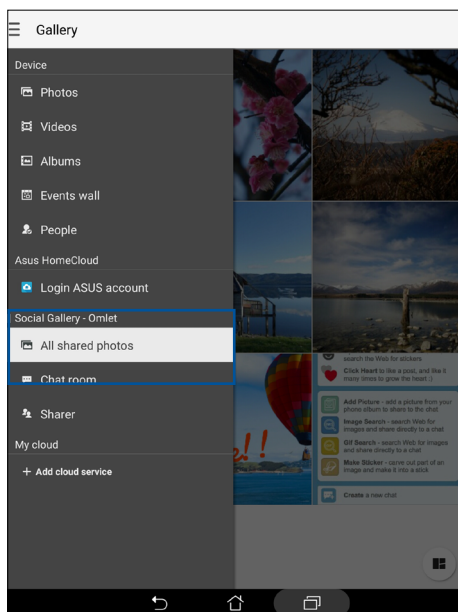

Viewing all shared photos

Tap **All shared photos** to view all photos shared by you and your Omlet Chat contacts.

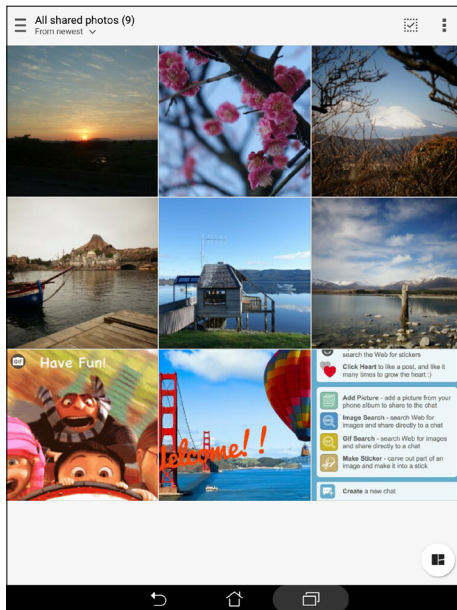

Viewing shared photos by chat room

Tap **Chat room** to view photos shared by chat room or social hotspot.

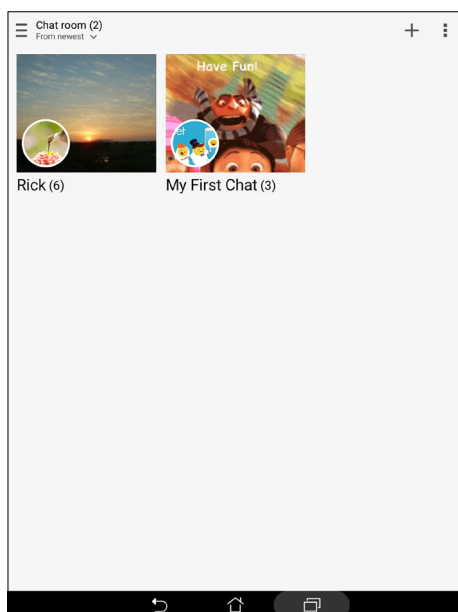

Viewing shared photos by sharer

Tap **Sharer** to view photos shared by an Omlet Chat contact.

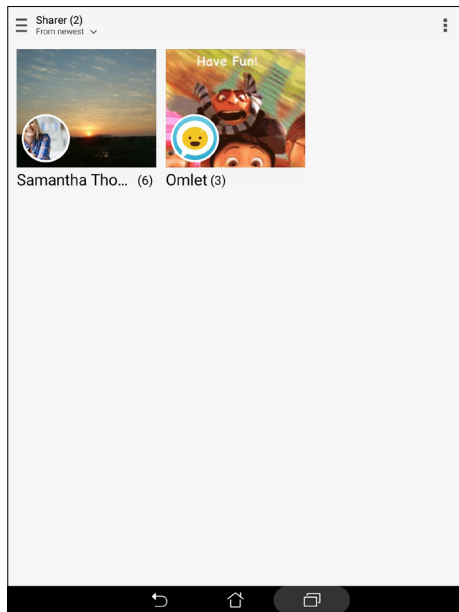

Viewing your Omlet contacts from Contacts app

Aside from connecting with your Omlet contacts in Omlet Chat app, you can also view and chat with your Omlet contacts using the Contacts app. The integration of your Omlet contacts to the Contacts app makes it easier for you to look up and chat to your Omlet contacts even without launching Omlet Chat app.

To view Omlet Contacts from Contacts app:

1. Launch the Contacts app by doing any of the following:
 - a. From the Home screen, tap **ASUS > Contacts** app.
 - b. From the All Apps screen, tap **Contacts** app.

2. Tap **Contacts to display** dropdown list to view the contact groups.

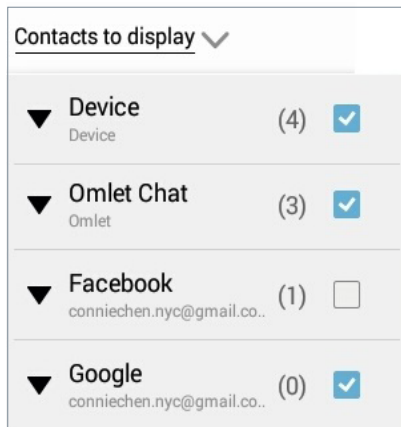

3. Untick all contact groups except **Omlet Chat**, then tap anywhere. Your Contacts screen displays all Omlet contacts.
4. Tap an Omlet contact to select and view the contact details or chat with that contact directly.

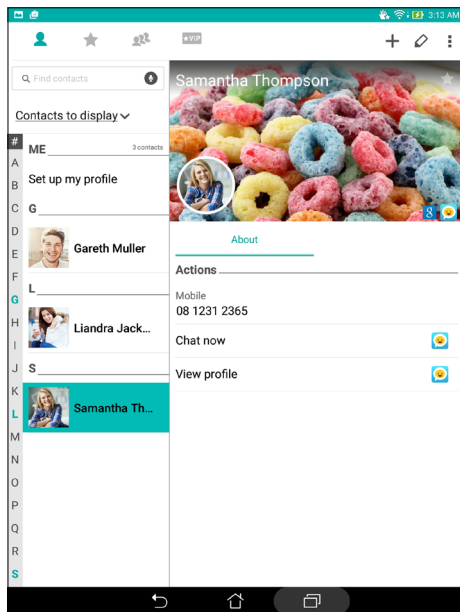

Syncing Omlet Chat to Cloud

If you have a Dropbox®, Box®, or Baidu PCS Cloud account, the Omlet Chat app instantly uploads your private conversations and chat logs securely.

Before Omlet Chat app uploads your data, you have to sync your Cloud account to Omlet Chat app first. To do this:

1. From the Omlet Chat menu, tap **Settings**.
2. Tap **Cloud Storage**, then select from the following Cloud services:
 - a. Dropbox
 - b. Box
 - c. Baidu PCS
 - d. OneDrive
 - e. Google Drive
3. Key in your username and password to log in to your Cloud account. Follow the onscreen instructions to sync your Cloud account with Omlet Chat app.

Your precious moments

4

NOTE: The following screenshot is for reference only.

Capture moments

Launching the Camera app

Capture images and record videos using your ASUS Tablet's Camera app. Refer to any of the steps below to open the Camera app.

From the lock screen

Drag down  until the camera app is launched.

From the home screen

Tap .

Using the volume key

While your ASUS Tablet is on sleep mode, double-click the volume key to wake it up and immediately launch the Camera app.

NOTE: Before using the volume key to launch the Camera app, enable this function from **Settings > Lock screen**, then slide **Instant camera** to **ON**.

Using Camera for the first time

After launching the Camera for the first time, two consecutive features appear to help you get started: Tutorial and Image locations.

Tutorial

If it is your first time to use your ASUS Tablet's camera, you will encounter the following tutorial screen after launching the **Camera** app. Refer to the following steps to proceed from this screen.

1. On the Tutorial screen, tap **Skip** if you want to skip viewing or **Start** to view the basic tutorial about using Camera.
2. After tapping either of these options, you will then proceed to the Remember Photo Locations screen.

Photo Locations

After going through the Tutorial screen, the Remember Photo Locations screen appears to help you create automatic location tags for your images. Refer to the following steps to proceed from this screen:

1. On the Remember Photo Locations screen, tap **No thanks** to proceed to the camera screen or **Yes** to set up location tagging for your captured images.
2. Slide **Location Access** to **ON** to enable the location tagging feature.
3. Tap **Agree** on the next screen to fully enable the feature and proceed to the Camera screen.

Camera home screen

Your ASUS Tablet's camera is equipped with auto-scene detection and auto-image stabilizer features. It also features a video stabilization function that helps prevent shakiness while video recording.

Tap the icons to start using your camera and explore the image and video features of your ASUS Tablet.

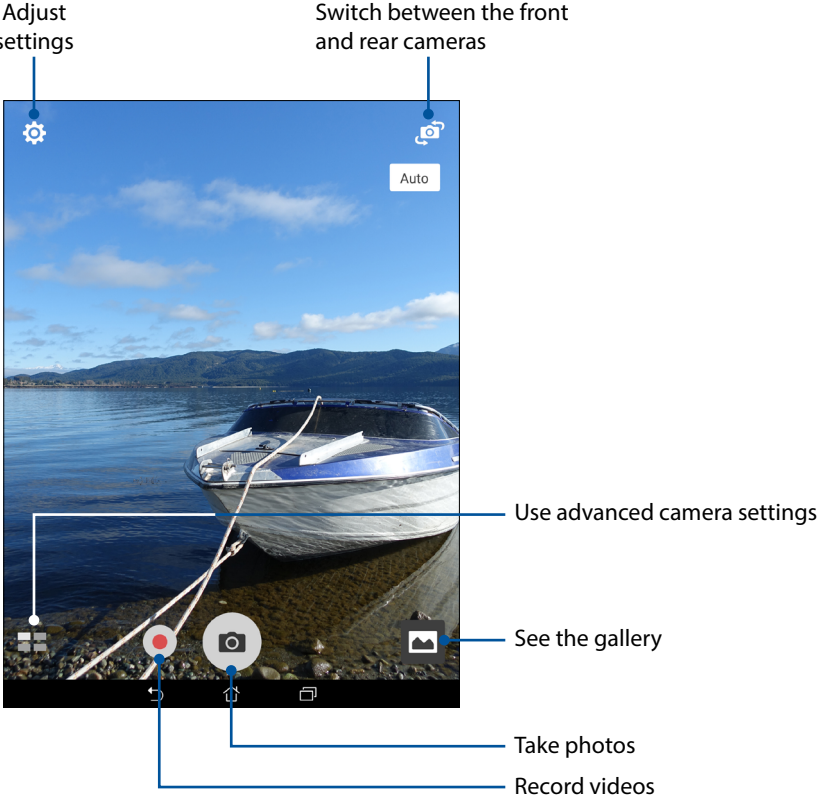



Image settings

Adjust the appearance of your captured images by configuring your camera's settings using the steps below.

IMPORTANT! Apply the settings first before taking images.

1. On the camera's home screen, tap  > .
2. Scroll down and configure the available options.

Image

Configure the image quality using these options.

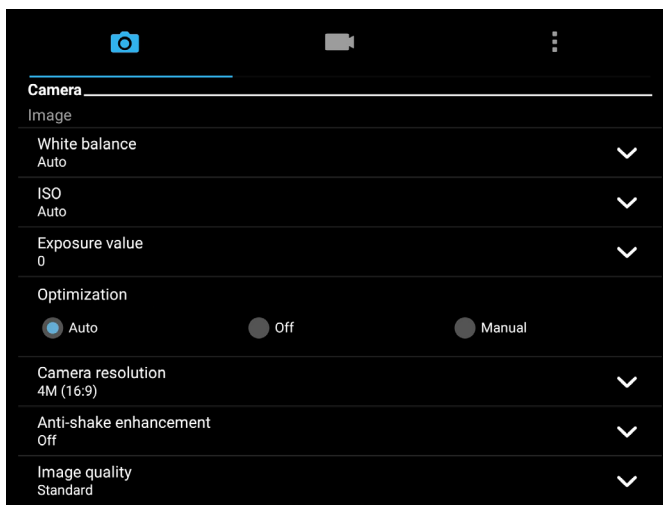

Shoot mode

Set your shutter speed to **Timer** mode, enable **Touch shutter** or change the **Burst** speed under this option.

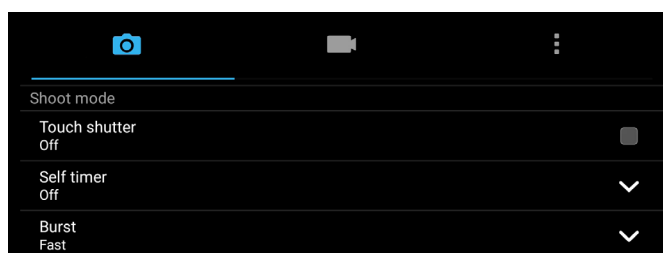

Focus & Exposure

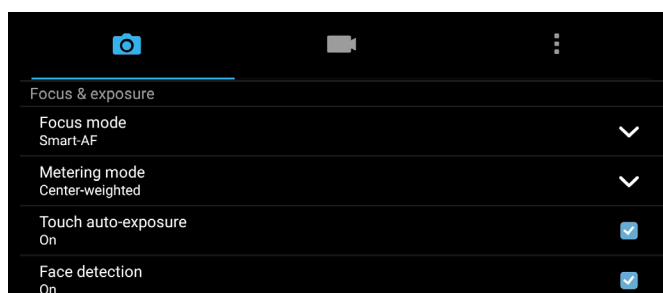

Enable **Touch auto-exposure** or **Face detection**, or set **Metering mode** and **Focus mode** under this option.



Video settings

Adjust the appearance of your recorded videos by configuring your camera's settings using the steps below.

IMPORTANT! Apply the settings first before taking images.

1. On the camera's home screen, tap  > .
2. Scroll down and configure the available options.

Image

Configure the video quality using these options.

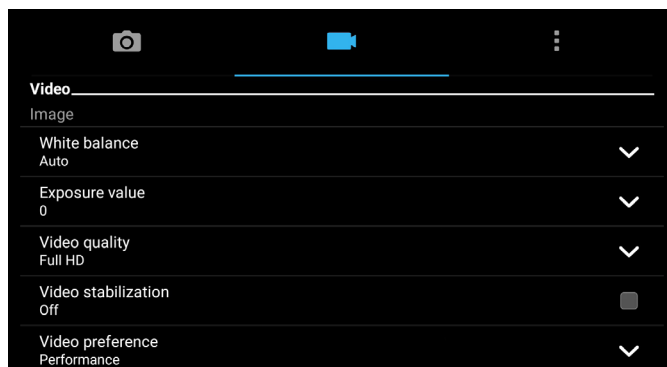

Focus & Exposure

Enable **Touch auto-exposure** under this option.



Advanced camera features



Explore new ways of capturing images or videos and make captured extra special moments using the advanced camera features of your ASUS Tablet.

IMPORTANT! Apply the settings first before taking images. Available features may vary per model.

HDR

The High-dynamic-range (HDR) feature allows you to take more detailed images for low-light and highly contrasting scenes. HDR is recommended for use when taking images on brightly lit locations, helping balance out the colors produced on your image.



Capturing HDR photos

1. From the Camera app's home screen, tap  > **HDR**.
2. Tap  to start capturing HDR photos.

Beautification



Have fun during and after taking photos of your family and friends using the Beautification feature of your ASUS Tablet. When enabled, this feature allows you to make live beauty enhancements on your subject's face before you press the shutter button.

Capturing Beautification photos

1. From the Camera app's home screen, tap  > **Beautification**.
2. Tap  to adjust the Beautification settings to apply to the photo.
3. Tap  to start capturing the photo.

NOTE: Drag  upwards to set a countdown timer.



Applying Beautification to photos

1. Tap the thumbnail to preview the photo and display the Beautification settings.
2. Tap the photo and tap  to select your preferred Beautification feature, then tap  to save the photo.



Low light

Using PixelMaster, your camera's light sensitivity is increased by up to 400% to enhance noise reduction and boost color contrast by up to 200%. Use this mode to transform any subject into a great photo or video—with or without ample natural lighting.

Capturing Low light photos

1. From the Camera app's home screen, tap  > **Low light**.
2. Tap  to start capturing photos.

Capturing Low light videos



1. From the Camera app's home screen, tap  > **Low light**.
2. Tap  to start recording a video.

Night

Take well-lit photos even in night time or in low-light situations using the Night feature of your ASUS Tablet.

NOTE: Keep your hands steady before and while the ASUS Tablet is capturing the image to prevent blurry results.





Capturing Night photos

1. From the Camera app's home screen, tap  > **Night**.
2. Tap  to start capturing Night photos.

Depth of Field

Take macro shots with a soft background using the Depth of Field. This feature suits close up photos of subjects for a more defined and dramatic result.

Capturing Depth of Field photos



1. From the Camera app screen, tap  > **Depth of Field**.
2. Tap  to start capturing photos.
3. Tap  or  to increase or decrease the background blur.
4. Tap  to save the photo.

Effect



Take photos using different effects such as Pixelize, Cartoon, Vintage, LOMO or other effects.

NOTE: Effect should be selected before taking the photo.

Capturing Effect photos

1. From the Camera app screen, tap  > **Effect**.
2. Tap  and select an effect to apply to the photo.
3. Tap  to start capturing photos.



Applying effects to photos

1. Tap the thumbnail to preview the photo.
2. Tap the photo and tap  to select your preferred Effect, then tap  to save the photo.

Selfie

Take advantage of your rear camera's high megapixel specs without worrying about pressing the shutter button. Using face-detection, you can set your ASUS Tablet to detect up to four faces using the rear camera then automatically capture your selfie or group selfie.



Capturing Selfie photos

1. From the Camera app screen, tap  > **Selfie**.
2. Tap  to choose how many people should be included in the photo.
3. Use the rear camera to detect faces and wait for your ASUS Tablet to start beeping, counting down until it captures the photo.
4. Tap  to save the photo.

GIF animation

Create GIF (Graphics Interchange Format) images straight from your ASUS Tablet's camera using the GIF animation feature.



Capturing GIF animation photos

1. From the Camera app's home screen, tap  > **GIF Animation**.
2. Long press  to start capturing burst photo for GIF animation.
3. Make your preferred adjustments to the GIF animation settings.
4. Tap  when finished.

Panorama

Capture images from various angles using Panorama. Images captured from a wide angle perspective are automatically stitched together using this feature.

Capturing panoramic photos

1. From the Camera app's home screen, tap  > **Panorama**.
2. Tap  then pan your ASUS Tablet to the left or right to capture the scenery.









NOTE: While panning your ASUS Tablet, a timeline of thumbnails appears on the lower part of your screen as it captures the scenery.

3. Tap  when finished.

Miniature

Simulate the tilt-shift effect of DSLR lenses via the Miniature feature. Using this feature allows you to focus on specific areas of your subject, adding a bokeh effect that can be used on both photos and video using your ASUS Tablet.

Capturing Miniature photos



1. From the Camera app screen, tap  > **Miniature**.
2. Tap  or  to select your focus area, then use your two fingers to adjust the focus area's size and position.
3. Tap  or  to increase or decrease the background blur. Tap  or  to increase or decrease saturation.
4. Tap  to capture Miniature photos.

Time Rewind

After selecting **Time Rewind**, your shutter starts taking burst shots two seconds before you actually press the shutter button. As a result, you get a timeline of images where you can choose the best image to save on your Gallery.

NOTE: The Time Rewind feature can only be used on the rear camera.

Capturing Time Rewind photos

1. From the Camera app's home screen, tap  > **Time Rewind**.
2. Tap  to start capturing photos.
3. Adjust the time (in seconds) that you want your captured photo to play in reverse or rewind mode.
4. Tap  when finished.

Using the Time Rewind viewer

1. After pressing the shutter, the Time Rewind viewer appears onscreen on top of a captured photo. Rotate the button on the viewer to browse through the photos you just took.



NOTE: Tap **Best** to view the best photo suggestion from the timeline.

2. Select a photo then tap **Done** to save it to Gallery.

Smart remove

Eliminate unwanted details immediately after capturing the image using the Smart remove feature.



Capturing Smart remove photos

1. From the Camera app screen, tap  > **Smart remove**.
2. Tap  to start capturing photos that can be edited using Smart remove.
3. On the captured photo, tap the outline around the detected moving object to delete it.
4. Tap  to save the photo.

All Smiles

Capture the perfect smile or the wackiest facial expression from a range of photos using the All Smiles feature. This feature lets you take five consecutive photos after pressing the shutter button, automatically detecting faces on the image for comparison.



Capturing All smiles photos

1. From the Camera app's home screen, tap  > **All smiles**.
2. Tap  to start capturing photos that can be edited using All Smiles.
3. Touch the subject's face, then select the subject's best facial expression.
4. Swipe down from the top, then tap  to save the photo.

Time lapse

The time lapse video feature of your ASUS Tablet allows you to capture stills for automatic time lapse playback. In effect, events seem to move in a fast-forward manner though they actually occurred and were recorded between long intervals.

Recording Time lapse videos

1. From the Camera app's home screen, tap  > **Time lapse**.
2. Tap  then select the time lapse interval.
3. Tap  to start taking Time lapse videos.

Using the Gallery

View images and play videos on your ASUS Tablet using the Gallery app.

This app also allows you to edit, share, or delete image and video files stored in your ASUS Tablet. From Gallery, you can display images in a slideshow or tap to view the selected image or video file.

To launch Gallery, tap  > **Gallery**.

Viewing files from your social network or cloud storage

By default, your Gallery displays all the media files on your ASUS Tablet according to their album folders.

To view the media files from other locations accessible via your ASUS Tablet:

1. From the main screen, tap .
2. Tap any of the following source locations to view their respective media files.

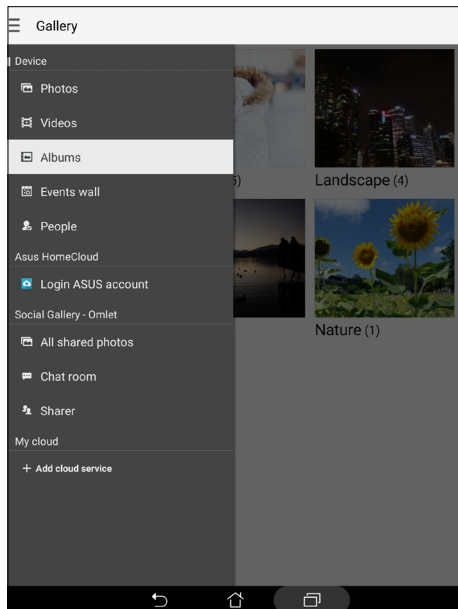

NOTE:



- You can download photos to your ASUS Tablet from your cloud account and use them as your wallpaper or a contact's cover image.
 - For details on adding cover images to your contacts, see [Customizing your contact's profile](#).
 - For details on using photos or images as your wallpaper, see [Wallpapers](#).
-

IMPORTANT! Internet connection is required for viewing photos and videos under **My cloud photos and Friends photos**.

Viewing the photo location

Enable the location access on your ASUS Tablet, and get the location details on your photos. Your photos' location details include the area where the photos are taken, as well as a map of the location via Google Map or Baidu (in China only).

To view the details of a photo:

1. Turn on the location access from  > **Settings** > **Location**.
2. Ensure that you have shared your location to Google Map or Baidu.
3. Launch the Gallery app, and select the photo whose photo details you want to view.
4. Tap the photo then tap .

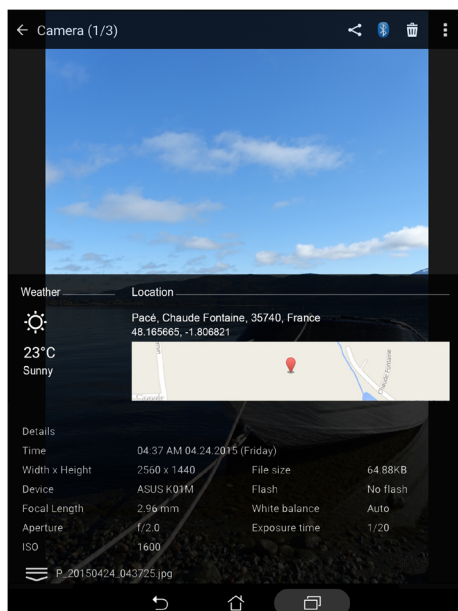

Viewing movies and videos



View videos recorded with the built-in camera or videos saved to your ASUS Tablet.

To view videos or movies:



1. Tap on the video or movie you want to view, then tap .
2. A message will appear asking you to select an app to view the video or movie with.

NOTE: For a better viewing experience and smoother playback with Tru2life+ technology you can enable Blur-Free Motion under **Settings** > **Display** > **Blur-Free Motion**.

Sharing files from the Gallery

1. From the Gallery screen, tap the folder where the files you want to share are located.
2. After opening the folder, tap  to activate file selection.
3. Tap the files you want to share. A check mark appears on top of the image you select.
4. Tap  then select from the list where you want to share the images.

Deleting files from the Gallery

1. From the Gallery screen, tap the folder where the files you want to delete are located.
2. After opening the folder, tap  to activate file selection.
3. Tap the files you want to delete. A check mark appears on top of the image you select.
4. Tap .

Editing images

The Gallery also features its own image editing tools that you can use to enhance images saved on your ASUS Tablet.





1. From the Gallery screen, tap the folder where the files are located.
2. After opening the folder, tap the image you want to edit.
3. Once the image is opened, tap it again to show its functions.
4. Tap  to open the image editing toolbar.
5. Tap any of the icons on the editing toolbar to apply changes to the image.

Zooming in/out the thumbnails or images

From the Gallery screen or your selected image, spread apart your fingers on the touchscreen panel to zoom in. To zoom out, bring your fingers together on the touchscreen panel.

Posting photos to your Calendar event wall

Enabling this feature in your Gallery allows you to view photos straight from your Calendar events. This way, you can immediately group captured photos according to their specific event name.

1. After taking photos from your ASUS Tablet, launch **Gallery**.
2. Tap  > **Events wall**.
3. Tap **Tap here to enter name** then key in the name of the event that you set in your Calendar app.
4. Tap  on the upper right corner of the folder containing the photos taken during an event.
5. Select the Calendar event you would like to integrate with the photo folder.
6. The  icon appears on the upper right corner of the photo folder indicating that the photos are successfully posted on the event wall.
7. To view the event photos, open the event from the Calendar app, then tap .

IMPORTANT!

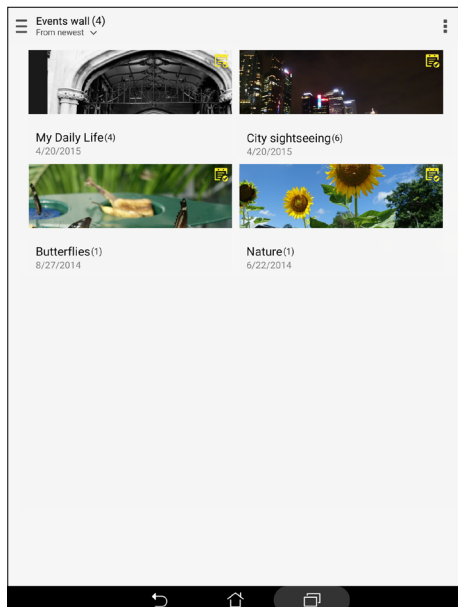

- This feature is only enabled after setting events on the Calendar. For more details on how to set events, see [Calendar](#).
 - Only photos taken with your ASUS Tablet's camera on the same date and time as a Calendar event can use this feature.
-



Using MiniMovie

Turn photos into a creative slideshow using the MiniMovie feature of the Gallery. MiniMovie contains a theme of slideshow presentations which you can immediately apply to selected photos.

To create a MiniMovie from a photo folder:

1. Launch Gallery then tap  to select the location of your photo folder.
2. Select the photo folder then tap  > **Auto MiniMovie**.
3. Select the MiniMovie theme you would like to use for your photo slideshow.

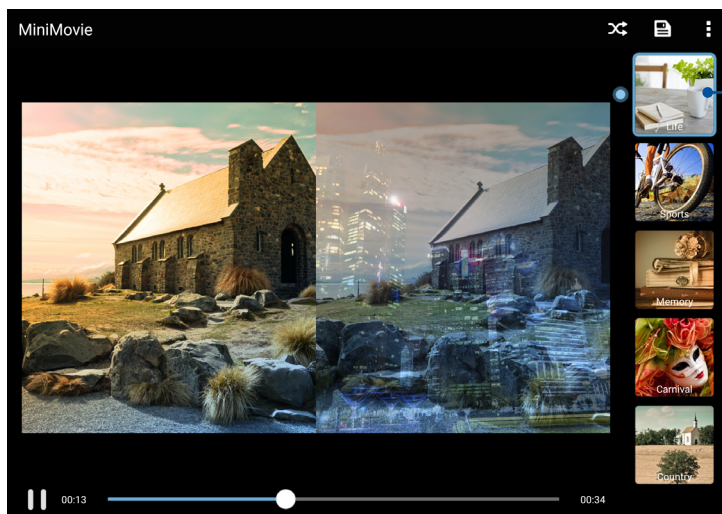

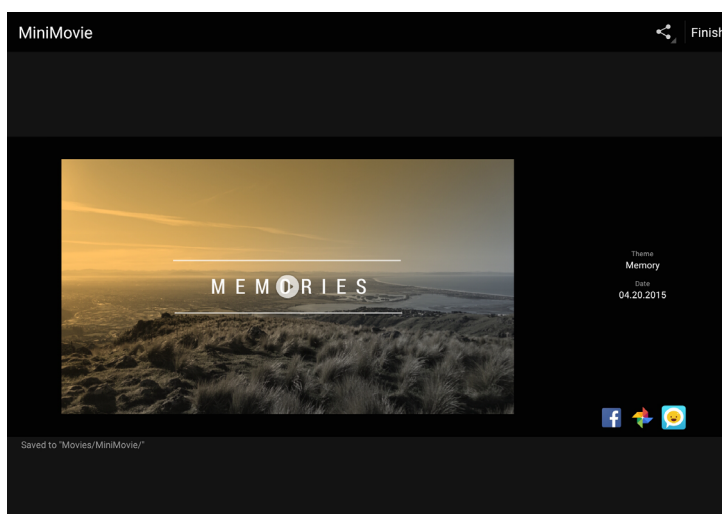

Tap any of these themes to see its preview

4. After selecting a theme, tap  to save the slideshow.
5. You can then share the slideshow to social network sites or instant messaging apps such as Facebook, Google Plus, or Omlet Chat.



To create a MiniMovie from a selection of photos:

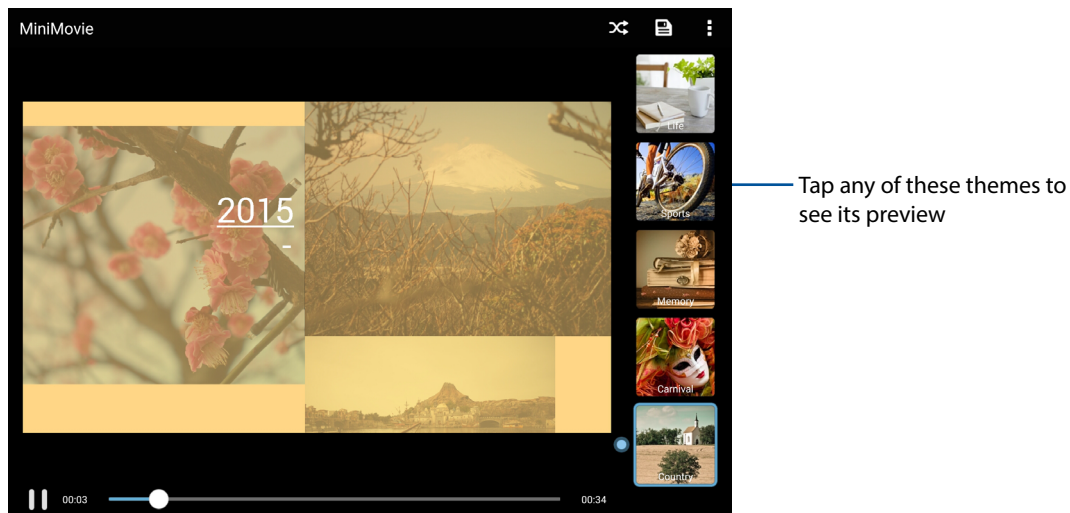

1. Launch Gallery then tap  to select the location of your photos.
2. Tap  to activate file selection.
3. After selecting your photos, tap **MiniMovie**.
4. Select the MiniMovie theme you would like to use for your photo slideshow.



5. After selecting a theme, tap  to save the slideshow. You can access your saved slideshows from **ASUS > File Manager > Movies > MiniMovie**.
6. You can then share the slideshow to social network sites or instant messaging apps such as Facebook, Google Plus, or Omlet Chat.

Using PlayTo

Play files from your Gallery to a compatible streaming device using PlayTo.

1. From the Gallery screen, tap  or the folder where the file you want to screencast is located.
2. Tap  > **PlayTo**.
3. In the next screen, select a compatible device to start screencasting your file.

Work hard, play harder

5



Browser

Your browser's state-of-the-art Chromium-based engine lets you surf the Internet at a fast loading speed. Its clean and intuitive Zen interface powered by text-reflow technology optimizes web contents to better fit the screen of your ASUS Tablet. With its magazine view mode via its Smart Reader feature, you can pleasurably read your favorite web contents online or offline without any distracting items such as banner ads. You can also mark an interesting page as a read later task, which you can retrieve from the Do It Later app and read at your convenient pace.

IMPORTANT! Before doing any Internet surfing or Internet-related activities, ensure that your ASUS Tablet is connected to a Wi-Fi network. For more details, see [Staying connected](#).

Launching the Browser app

From your Home screen, do any of the following to launch the Browser app:

- Tap .
- Tap  > **Browser**.

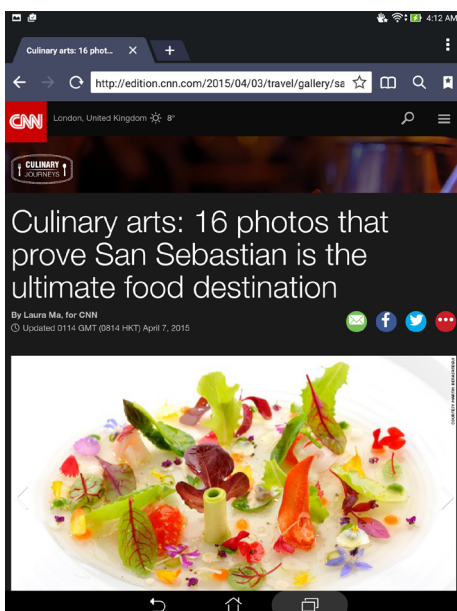

Sharing links

Share interesting links from your ASUS Tablet to others via an email account, cloud storage account, Bluetooth, or other ASUS Tablet apps.

1. Launch the browser.
2. From a web page, tap  > **Share link**.
3. Tap the account or app that you want to use as medium in sharing the link.

Reading the pages later



When there's an interesting piece of information online yet you don't currently have the time to read it, you can mark it as a read later task. You can retrieve and read this page at a convenient time from the Do It Later app.

1. From the page, tap  > **Read later**.
2. To retrieve the page, tap **Asus** > **Do It Later** from the Home screen.

NOTE: For details on browsing Read later pages, see [Catching up on my online reading now](#).

Adding a new tab

Hide the current website and open a new window to continue surfing or browsing another website.

1. From the current page, tap  > **New tab** or tap  beside the current tab.
2. Enter the URL address in the URL field and continue enjoying browsing the Internet from your ASUS Tablet.
3. If you want to do add another tab, follow step 1 again.

NOTE:

- Opening many websites in your browser slows down its loading performance.
 - If Internet connection slows down, try clearing the cache. For details, refer to the section [Clearing the browser cache](#).
-

Bookmarking pages

Bookmark your favorite pages or websites so you can go back and browse them again.

To bookmark a page:



From the page, tap  > **Save to bookmarks**. The next time you open your browser, you can quickly tap on your bookmarked page.

Smartly read online

Your ASUS Tablet automatically enables the Smart Reader Mode on pages that contain a lot of items that you may find unnecessary or distracting such as banner ads, icons, or menu items. You can remove these items and read only the main contents of the page.

NOTE: Smart Reader Mode supports Wikipedia, CNN, ESPN, BCC, and NY Times sites.

To use the Smart Reader Mode:

- Tap the Smart Reader Mode icon  to automatically remove any unnecessary or distracting items and show only the main contents of the page.
- From the Smart Reader Mode page, do any of the following:
 - Tap  to show your Reader's List or saved pages.
 - Tap  to launch the Marker tool and select your preferred color, then swipe over the text that you want to highlight.
 - Bring two fingers together or spread them apart to zoom in/out of a page.

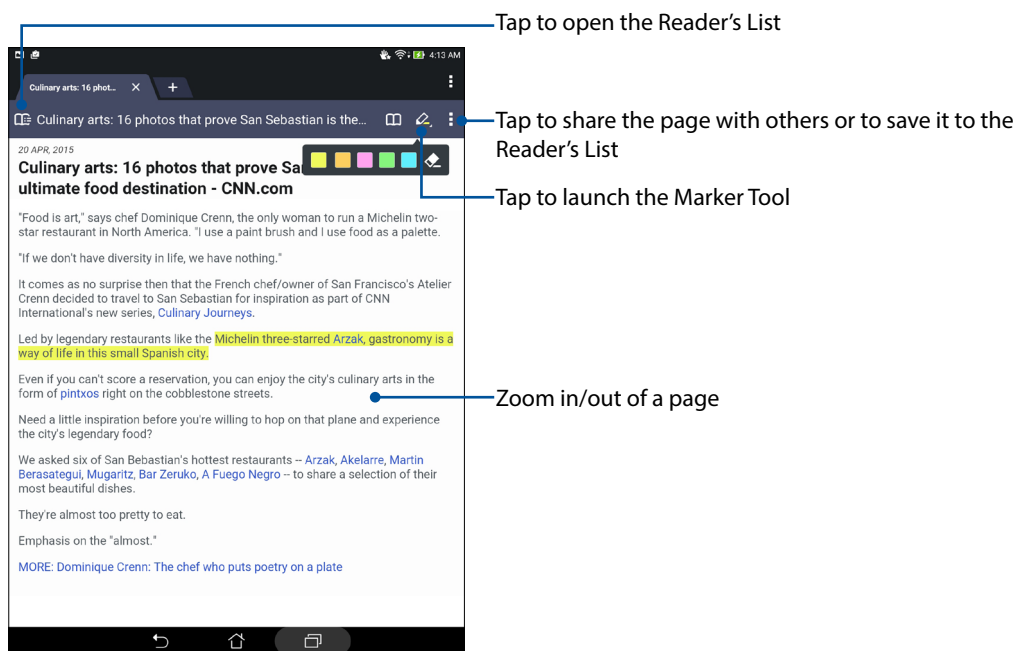

Clearing the browser cache

Clear the browser cache to delete temporary Internet files, websites, and cookies that are temporarily stored in your ASUS Tablet. This helps improve the loading performance of your browser.

1. Launch the browser.
2. Tap  > **Settings** > **Privacy & security** > **Clear cache**.
3. Click **OK** on the confirmation message.

Email

Add Exchange, Gmail, Yahoo! Mail, Outlook.com, POP3/IMAP accounts so you can receive, create, and browse emails right from your device. You can also sync your email contacts from these accounts to your ASUS Tablet.

IMPORTANT! Your ASUS Tablet must be connected to a Wi-Fi network so you can add an email account or send and receive emails from added accounts. For more details, see [Staying connected](#).

Setting up email accounts

Set up your existing personal or work email account so you can receive, read, and send emails from your ASUS Tablet.

1. From the Home screen, tap **Email** to launch the Email app.
2. Tap the mail provider you want to set up.
3. Key in your email address and password and tap **Next**.

NOTE: Wait while your device automatically checks your incoming and outgoing mail server settings.

4. Configure the **Account settings** such as inbox checking frequency, sync days, or notification for incoming emails. When done, tap **Next**.
5. Key in an account name that you want to be displayed in the outgoing messages, then tap **Next** to log into your inbox.

NOTE: If you want to set up your work account on your ASUS Tablet, ask for the email settings from your network administrator.

Adding email accounts

If you don't have an existing email account, you can create one so you can receive, read, and send emails right from your ASUS Tablet.

1. From the Home screen, tap **Email** to launch the Email app.
2. Tap  > **Settings**, then add an email account.
3. Tap the mail provider that you want to add.
4. Follow the succeeding instructions to complete setting up your new email account.

NOTE: You may also refer to steps 3 to 5 in the [Setting up email accounts](#) section to complete this setup process.

Setting up a Gmail account

Set up your Gmail account to get into Google-related services and apps as well as receive, send, and browse emails right from your ASUS Tablet.

1. Tap **Google** then tap **Gmail**.
2. Tap **Existing** and key in your existing Gmail account and password, then tap .

NOTE:

- Tap **New** if you do not own a Google account.
 - When signing in, you have to wait while your device communicates with Google servers to setup your account.
-

3. Use your Google account to backup and restore your settings and data. Tap  to sign in to your Gmail account.

IMPORTANT! If you have several email accounts aside from Gmail, use Email app to set up and access all your email accounts.

Calendar

The Calendar app enables you to keep track of important events using your ASUS Tablet. Along with creating events you may also set reminders, or create a countdown notice to ensure you don't forget these important occasions. It also stores the events, such as birthdays and anniversaries, that you've set up for your VIP contacts.

Creating events

To create an event:

1. Tap **Asus > Calendar**.
2. Tap  to start creating a new event.
3. In the New event screen, input all the necessary details of your event.
4. Turn Countdown to **ON**. You'll get a countdown notice on the System notifications panel as to the days left until this event takes place.

NOTE: For details on the System notifications panel, see [System notifications](#).

5. On the **Reminders** field, select the time that you want to get an alert or reminder about the event.
6. Once finished, tap **Done** to save and exit.

Adding accounts to Calendar

Aside from creating an event logged on your ASUS Tablet, you can also use Calendar to create events that get automatically synced with your online accounts. But first, these accounts must be added to Calendar using the following steps:

1. Tap **Asus > Calendar**.
2. Tap  > **Accounts > +**.
3. Tap the account you want to add.
4. Follow the succeeding onscreen instructions to complete adding the new account to Calendar.

Creating an event from your account

After adding online accounts that you would like to sync with Calendar, you may now use your ASUS Tablet to create notifications for those online accounts by following these steps:

1. Tap **Asus > Calendar**.
2. Tap **New Event** to start creating a new event.
3. In the New event screen, tap **My Calendar** to view all the accounts currently synced with the Calendar.
4. Tap the account where you would like to create a new event.
5. In the New event screen, input all the necessary details of your event then tap **Done**.

NOTE: Your online account must already be added to Calendar before you can proceed with the following steps. For more details, see [Adding accounts to Calendar](#).

Enabling alert reminders for events

Turn on the alert function from the Calendar app to get alert reminders and notifications for special events such as birthdays, anniversaries, meetings, and other important events that matter you.

1. Tap **Asus > Calendar**.
2. Tap  > **Accounts**.
3. Tap the accounts from which you want to receive alert reminders from.

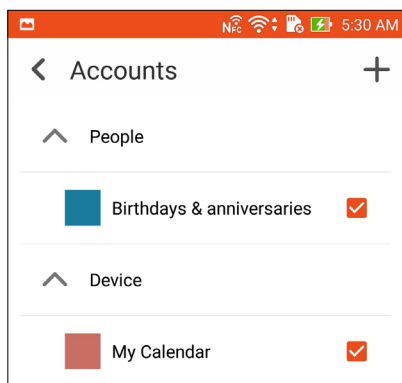

NOTE:

- For details on setting up event alerts about your VIPs, see [Adding an event to a VIP contact](#).
 - Get alerts or reminders as your [What's Next](#).
-

What's Next

Do not miss out on important events, having fun out in the sun, or getting emails from your VIP contacts. Set up your calendar of events, VIP groups, or weather update settings to get alerts and reminders of What's Next. View your What's Next alerts from the Lock screen, System notifications panel, and What's Next widget or app.

Getting event reminders

To get your What's Next event reminders and notifications, ensure the following:

- Set up your VIPs' events info such as birthdays or anniversaries on the Contacts app. For details, see [Adding an event to a VIP contact](#).
- You can set up an event and set the reminder time in the Calendar app. For details, see [Creating events](#).

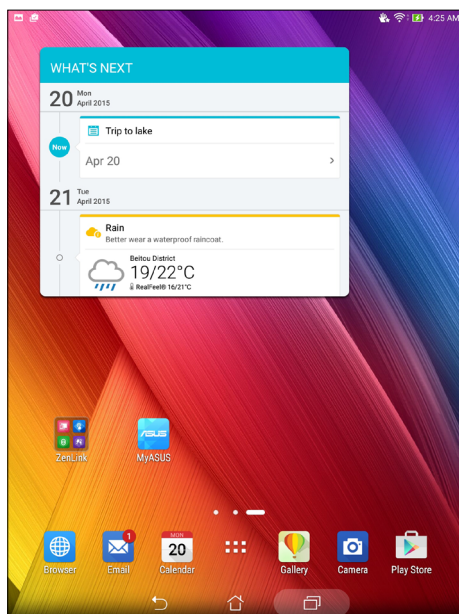

Accepting or declining invites to events

Set up your email account in the Email app to send or receive emails such as invites to events. When you accept email invites, the events will be synced with the Calendar app.

NOTE: For more details, see [Email](#) and [Calendar](#).

IMPORTANT! Your ASUS Tablet must be connected to a Wi-Fi network to get emailed invites or event-related alerts. For more details, see [Staying connected](#).

To accept or decline an invite:

1. Tap your email invite to open it.
2. Tap **Yes** to accept or **No** to decline the invite. Your reply will be emailed to the event organizer or host.

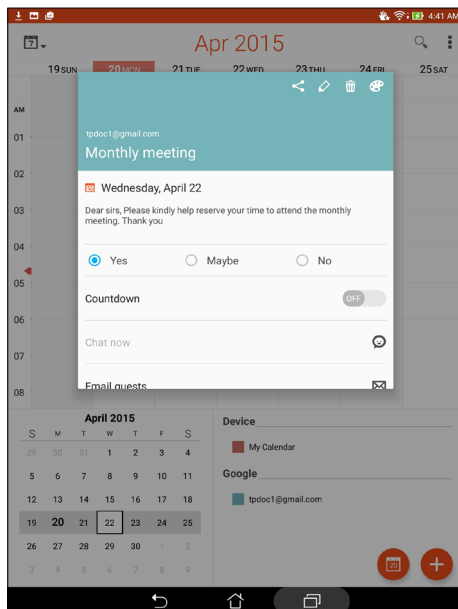

Getting event-related alerts

When you accept an invitation to an event, you'll get reminders of any changes to the event such as postponement, cancellation, change in event location, or shift in event schedule. These event-related alerts will be posted on the Lock screen, System notifications panel, and What's Next widget or app.

Start event alert

A few minutes before the event, you'll get a reminder that the event is about to start. You can call to give the organizer or host a heads up if you're running late.

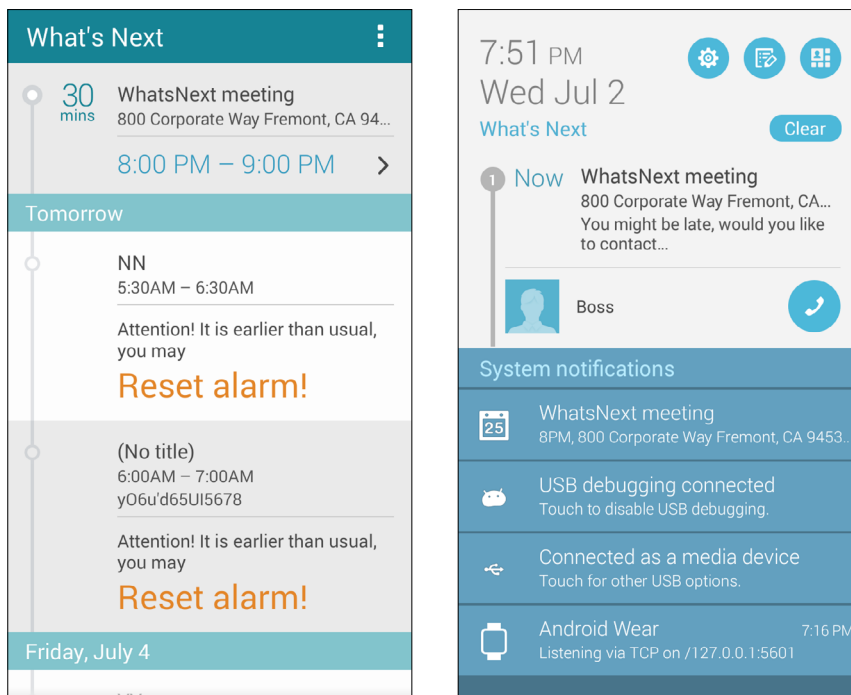

Cancelled event alert

You'll get a cancellation alert when the organizer or host cancels the event.

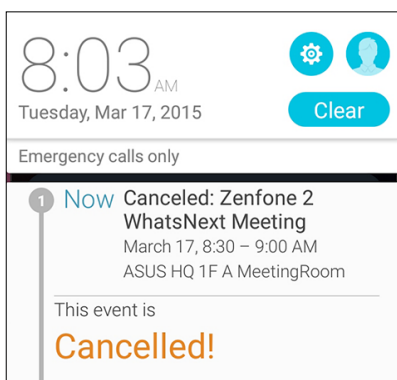

Rescheduled event alert

You'll get an alert if the event has been postponed, rescheduled, or moved to another location.

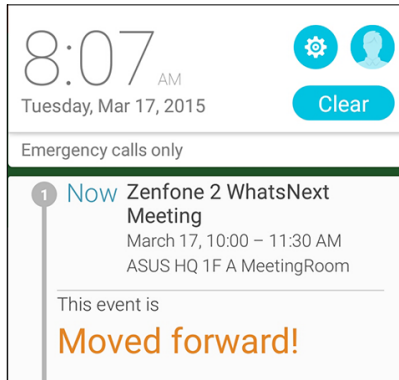

Getting the weather updates

Get real-time AccuWeather® updates, every hour or up to 12 hours, for your current location or for other parts of the world. You can make plans for up to seven (7) days with the 7-day weather forecast or dress appropriately based on AccuWeather RealFeel® temperature. You can also get the real-time UV index or air pollution index, letting you take the necessary protective measures against harmful ultra-violet rays or air pollutants.

1. Before getting the weather updates, ensure the following:
 - Wi-Fi network is turned on.
 - Turn on the location access from **☰** > **Settings** > **Location access**.
2. Launch the Weather app in any of these two ways:
 - Tap **☰** > **Weather**.
 - From your ASUS Tablet's home screen, tap the weather icon.

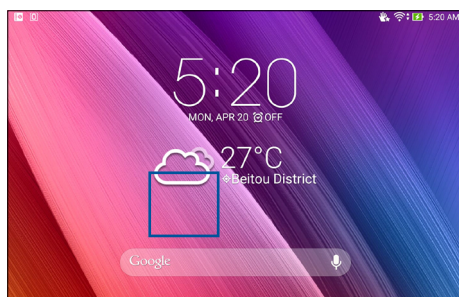

3. Tap **☰** > **Edit** then tap **+**.
4. In the search box, enter the city or area whose weather updates you want search for.
5. Wait for a while your ASUS Tablet gets the weather information. The city or area's weather data will be added to your location list. Tap the city's or area's weather data that you want to display on the What's Next widget on the Home screen.

Do It Later

Get hold of even the most trivial things in your busy life. Even when you're too busy, reply to your emails, read news online, or add other important to-do tasks at your convenience.

Mark your unread messages or emails, interesting web pages, and missed calls as **Reply Later**, **Read Later**, or **Call Later** items. These marked items will be added to your Do It Later tasks, and you can act on these tasks at a convenient time.

NOTE:

- Popular third-party apps that support Do It Later include Google Maps, Google Chrome, Google Play, YouTube, and IMDb.
 - Not all apps can share and add tasks to Do It Later.
-

Adding to-do tasks

Create important to-do tasks to organize your work or social activities in your professional or social life.

1. From the Home screen, tap **Asus > Do It Later**.
2. Tap **+** then fill in the necessary information.
3. If you want to set the importance level, select **High** in the Importance field.
4. When you're done, tap **OK**.

Prioritizing to-do tasks

Set the importance level of your to-do tasks so you can prioritize and act on them accordingly.

1. From the Home screen, tap **Asus > Do It Later**.
2. Tap the task that you want to set as a top priority.
3. Under the Importance field in the task screen, select **High**.
4. When you're done, tap **OK**.

NOTE: High-priority to-do tasks are marked as  on your Do It Later list. This allows you to quickly determine which to-do tasks need immediate actions.

Catching up on my online reading now

You can retrieve pages that you've previously marked as read later tasks and catch up on your online reading at your convenience from the Do It Later app.

1. From the Home screen, tap **Asus > Do It Later**.
2. Select the page or pages that you want to read now, then tap **Read now**.

NOTE: For details on setting pages as read later tasks, see [Reading the pages later](#).

Deleting to-do tasks

You can delete any completed, overdue, or unnecessary to-do tasks from the Do It Later app.

1. From the Home screen, tap **Asus > Do It Later**.
2. Tap the task you want to remove from the list, then tap **Delete**.

SuperNote





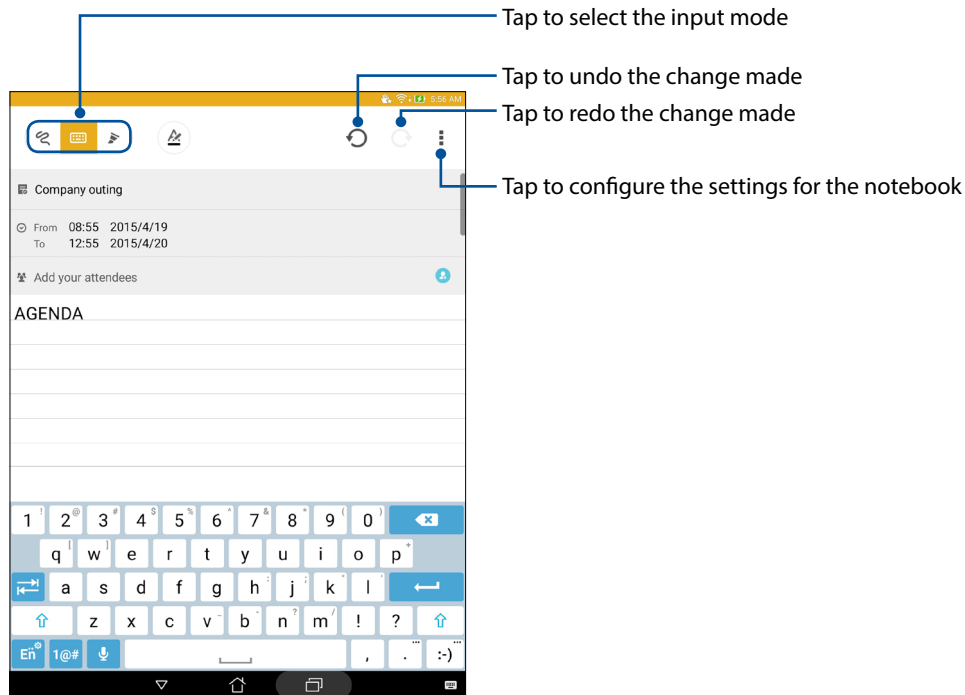



Turn note-taking into a fun and creative activity using Supernote.

This intuitive app allows you to create notes organized per notebook by directly writing or drawing on the touchscreen. While creating notes, you can also add multimedia files from other apps and share them via social networks or your Cloud storage account.



Understanding icons

Depending on your selected input mode, these icons appear as you take down your notes on SuperNote.

-  Select this type mode when you want to use the onscreen keyboard to enter your notes.
-  Select this write mode when you want to scribble or write your notes.
-  Select this draw mode when you want to create drawings or doodles.
-  When in write or type mode, tap this icon to select text weight and color.
-  When in draw mode, tap this icon to select the drawing tool to use, and the stroke color or size.
-  When in draw mode, tap this icon to erase some contents in your notes.
-  Tap this icon to take a photo or video, record audio, add timestamp and more to your notes.
-  Tap this icon to add a new page to your notebook.

Creating a notebook

To create new files using Supernote, refer to the following steps:

1. Tap **ASUS** > **SuperNote**, then tap .
2. Select a template and start writing your notes.

Sharing a notebook on the Cloud

You may share your notebook on the Cloud using the following steps:

1. On the Supernote home screen, tap-and-hold the notebook you would like to share.
2. In the pop-up screen, tap **Enable cloud sync**.
3. Input your ASUS WebStorage account's User name and Password details to proceed with syncing your notebook to the Cloud.
4. Once the notebook has been successfully synced to the Cloud, the Cloud icon appears on top of the shared notebook.

Sharing a note to the Cloud

Aside from your notebook, you may also share individual notes from your Supernote to your Cloud storage account. To do this:

1. Launch the notebook that contains the note you want to share.
2. Tap-and-hold the note you want to share.
3. In the pop-up screen, tap **Share** then select the type of file format you want to share it as.
4. In the next screen, select the Cloud storage account where you would like to share your note.
5. Follow the succeeding instructions to complete sharing your selected note.

Using the Z Stylus with SuperNote (optional)

Your Z Stylus makes taking notes easier than ever before. Quickly switch between different tools for easy note taking.

Set the input mode to **Draw** by tapping the  icon.

NOTE:



- The Z Stylus is purchased separately.
 - Your Z Stylus will actively communicate with your ASUS Tablet when it is in close contact with the screen. Ensure to keep your Z Stylus away from the screen when not in use to save battery life.
 - Please visit <http://support.asus.com> for more information on the Z Stylus.
-

File Manager

Using File Manager allows you to easily locate and manage your data on the internal storage of your ASUS Tablet and its connected external storage devices.



Accessing the internal storage

To access the internal storage:

1. Tap  > **File Manager**.
2. Tap  > **Internal storage** to view the contents of your ASUS Tablet then tap an item to select.

Accessing the external storage device



To access the external storage device:

1. Insert the microSD card into your ASUS Tablet.
2. Tap  > **File Manager**.
3. Tap  > **MicroSD** to view the contents of your microSD card.

Accessing Cloud Storage

IMPORTANT! Ensure that Wi-Fi is enabled on your ASUS Tablet. For details, see [Staying connected](#).

To access files saved on your cloud storage accounts:

1. Tap  > **File Manager**.
2. Tap  > then tap a cloud storage location under **Cloud Storage**.

The Cloud

Back up your data, sync files among different devices, and share files securely and privately via a Cloud account such as ASUS WebStorage, Drive, OneDrive, and Dropbox.

ASUS WebStorage

Register for or sign in to ASUS WebStorage and get free cloud storage. Automatically upload newly captured photos for instant sharing, sync files among different devices, or share files via your ASUS WebStorage account.

NOTE: To enjoy the auto-upload function, enable Instant Upload from **Settings > Instant Upload** in your ASUS WebStorage.

IMPORTANT! Ensure that Wi-Fi is enabled on your ASUS Tablet. For details, see [Staying connected](#).

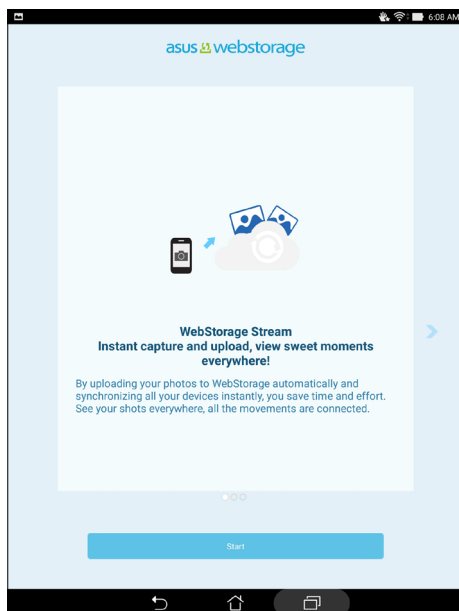

Data Transfer

Transfer your data such as contacts, calendar entries from your old mobile device to your ASUS Tablet via Bluetooth technology.

To use Data Transfer:

1. Pair your old mobile device with your ASUS Tablet via Bluetooth.

NOTE: For more details on pairing devices, see [Pairing your ASUS Tablet to a Bluetooth® device](#).

2. From the All apps screen, tap **Data transfer**.
3. Tap **Transfer Wizard** then follow the onscreen instructions to complete the Data Transfer process.

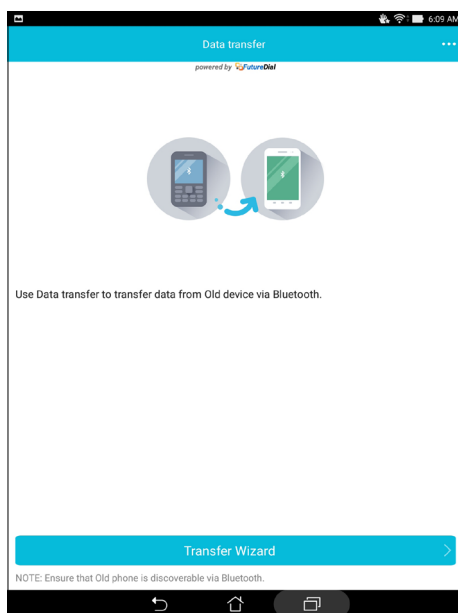

ASUS Support

Find answers from FAQs (Frequently Asked Questions) or directly interact with other Zen UI users to find and share solutions about ZenUI 2.0 apps.

To access ZenUI Help:

1. Tap  > **ASUS Support**.
2. Tap **ZenUI tips**, then select the app that you want to find answers for.

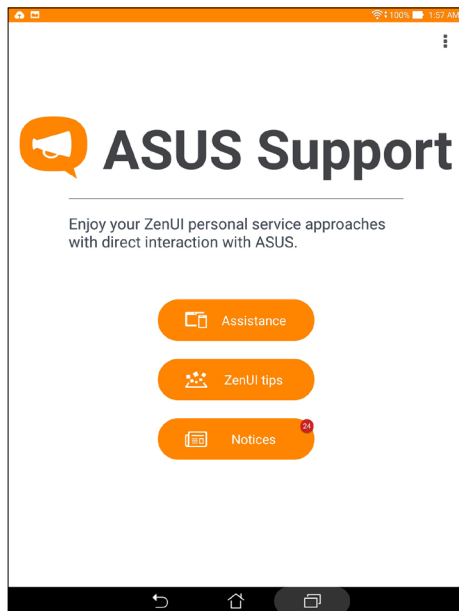

Fun and entertainment

6

Using a headset

Have the freedom to do other things while you enjoy listening to your favorite music using a headset.

Connecting the audio jack

Insert the 3.5 mm headset jack into the audio port of your device.

WARNING!

- Do not insert other objects into the audio jack port.
- Do not insert a cable with electric power output into the audio jack port.
- Listening at a high volume for long periods can damage your hearing.

NOTE:

- We highly recommend to use only compatible headsets or the bundled headset with this device.
 - Unplugging the audio jack while listening to music automatically pauses the music played.
 - Unplugging the audio jack while watching a video automatically pauses the video playback.
-

Play Games

Get the latest games online and share them in your social media accounts using the Play Games app. You can also join multiplayer games and check out leaderboards for some competitive gaming fun.

IMPORTANT! Log in to your Google account to maximize the features of Play Games.

Using Play Games

To use Play Games:

1. Tap **Google > Play Games**.
2. Tap the option you would like to use.

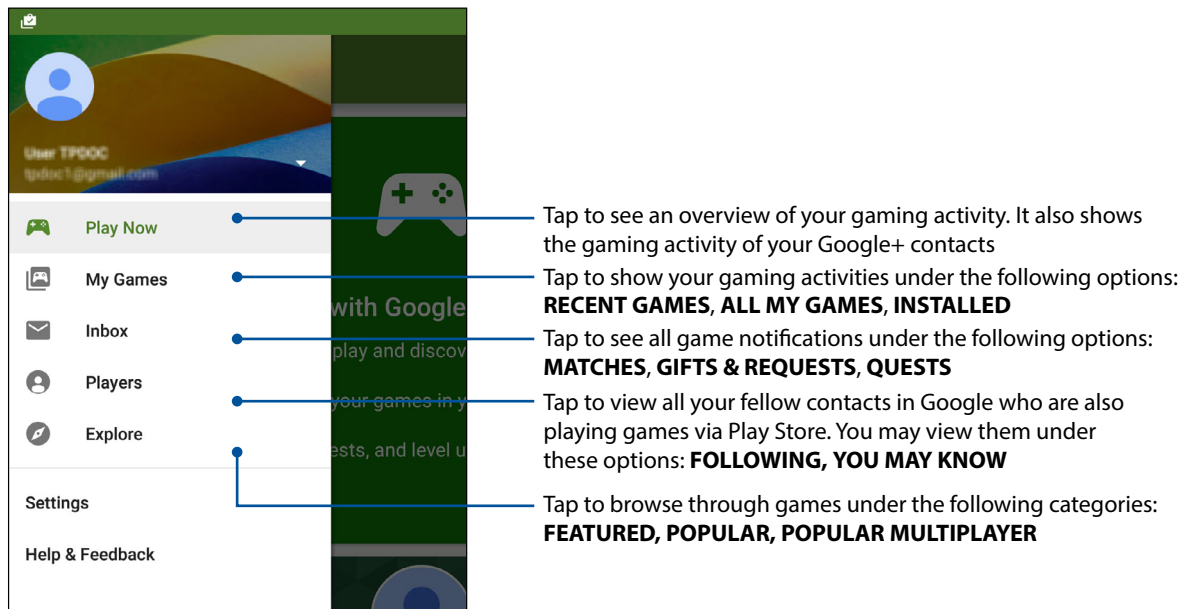

Music

Music app automatically searches for music files from the internal and external storages on your ASUS Tablet. You can organize these music files in a playlist or add them in a queue to play them sequentially. You can also stream music from cloud accounts such as ASUS WebStorage, Dropbox, OneDrive, and Drive.

IMPORTANT! Before streaming music from a cloud account, ensure that your ASUS Tablet is connected to a Wi-Fi network. For more details, see [Staying connected](#).

Launching Music

To launch Music, tap  > **Music**.

Playing songs

To play a song:

1. From the Music app, tap **Music** then select **Songs**. You can also select these other options on how you want to browse your music files: **Album**, **Artist**, **Genres**, **Composer**, or **Folder**.
2. From your list, tap the song that you want to play. Tap **Play All** if you want to play all songs.
3. Swipe up from the song title bar to get a full screen of the song that's currently playing.

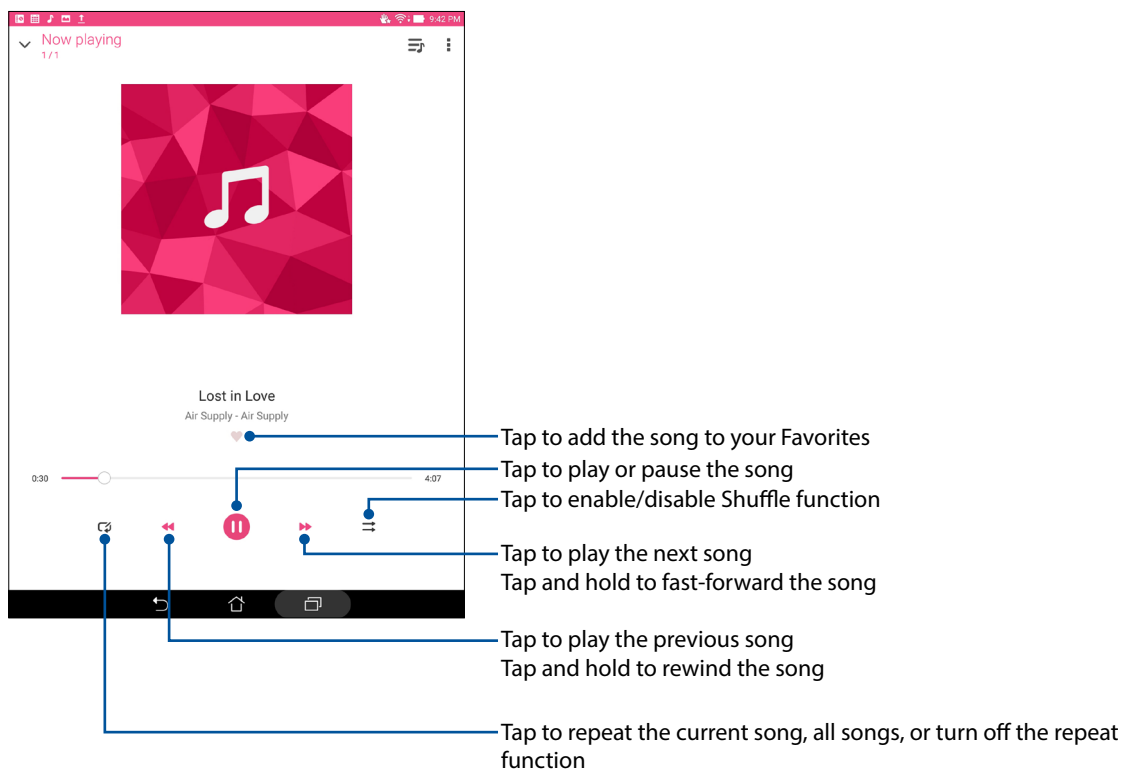

NOTE: To add several songs to an existing playlist, see [Adding songs to a playlist](#).

Other playback options

During playback, you can tap  and do any of these other options below.

Add to playlist	Tap to add the song to an existing playlist or create a new one to add the song to it.
Play To	Tap to scan and play the song to other devices nearby. NOTE: For details, see PlayTo other devices .
Share	Tap to share the song via some apps or cloud accounts.
Edit info	Tap to add some details about the song.
Clear queue	Tap to remove all songs in the queue.
Equalizer	Tap to configure the Equalizer settings and get better audio for your songs.
Sleep timer	Set the time when the music will stop playing.
Settings	Tap this option to configure the Music settings.
Feedback & Help	Get answers to your questions and you can send to us your feedbacks.

Streaming Cloud music

Register or sign in to a cloud account and stream music from your cloud account to your ASUS Tablet.

IMPORTANT! Ensure that Wi-Fi is enabled on your ASUS Tablet. For details, see [Staying connected](#).

Adding a cloud storage account

To add a cloud storage account:

1. From the Music home screen, tap .
2. Under Cloud Music, tap **Add cloud service**.
3. Select the cloud storage service where you want to play music files from.
4. Follow the succeeding instructions to complete signing in to your cloud storage account.



Streaming music from the cloud

To stream music from your cloud account.

1. From the Music home screen, tap .
2. Under **Cloud Music**, tap the cloud account where you want to stream music from.
3. Select the song, then tap to play it.



Creating a playlist

Get your favorite songs from different sources such as internal storage, external storage, or cloud accounts and organize them in a playlist.

1. From the Music home screen, tap .
2. Under **Playlist**, tap **My playlist**, then tap .
3. Assign a name to your playlist, then tap **Save**.

Adding songs to a playlist

You can add several songs to your playlist from your local source (internal and external storages) or cloud accounts.



1. From the Music home screen, tap .
2. Under **Playlist**, tap **My playlist**, then tap the name of your playlist.
3. Tap  > **Add songs**.
4. Tap the music source where you want to get your songs from to add to your playlist.
5. Select how you'd want to browse your music: **Album**, **Artist**, **Genres**, **Composer**, **Songs**, or **Folder**.
6. Select the songs that you'd want to add to your playlist. Tap **Select All** if you want to add all songs from your music list, album, folder, or from your favorite artists.

NOTE: You can also add a currently-playing song to an existing playlist. For details, see [Other playback options](#).

PlayTo other devices

Use the PlayTo function to stream music from your ASUS Tablet to other Miracast or DLNA-enabled devices nearby.

To use PlayTo:

1. From a currently-playing song, tap  > **PlayTo**.
2. Tap the device that you want to stream music to. Music from your ASUS Tablet will play or stream on the other device.
3. To stop PlayTo, tap  > **Disconnect**.



Staying connected

7

Wi-Fi

The Wi-Fi technology of your ASUS Tablet gets you connected to the wireless world. Update your social media accounts, browse the Internet, or exchange data and messages wirelessly from your ASUS Tablet.

Enabling Wi-Fi

1. Launch the Settings screen by doing any of the following:
 - Launch Quick settings then tap .
 - Tap  > **Settings**.
2. Slide the Wi-Fi switch to the right to turn on the Wi-Fi.

NOTE: You can also enable the Wi-Fi from Quick Settings screen. Refer to section [Quick settings](#) on how to launch Quick Settings screen.

Connecting to a Wi-Fi network



1. On the Settings screen, tap **Wi-Fi** to display all detected Wi-Fi networks.
2. Tap a network name to connect to it. For a secured network, you may be prompted to key in a password or other security credentials.

NOTE:

- Your ASUS Tablet automatically reconnects to the network that you connected with previously.
 - Turn off the Wi-Fi feature when you're not using it to help save battery power.
-

Disabling Wi-Fi

To disable Wi-Fi:



1. Launch the Settings screen by doing any of the following:
 - Launch Quick settings then tap .
 - Tap  > **Settings**.
2. Slide the Wi-Fi switch to the left to turn off the Wi-Fi.

NOTE: You can also disable the Wi-Fi from Quick Settings screen. See [Quick settings](#) on how to launch Quick Settings screen.

Bluetooth®

Use the Bluetooth feature of your ASUS Tablet to send or receive files and stream multimedia files with other smart devices over short distances. With Bluetooth, you can share your media files with your friends' smart devices, send data for print with a Bluetooth printer, or play music files with a Bluetooth speaker.

Enabling Bluetooth®

1. Do any of the following to launch the Settings screen:
 - Launch Quick settings then tap .
 - Tap  > **Settings**.
2. Slide the Bluetooth switch to the right to turn on the Bluetooth.

NOTE: You can also enable the Bluetooth from Quick Settings screen. See [Quick settings](#) on how to launch Quick Settings screen.

Pairing your ASUS Tablet to a Bluetooth® device

Before using the Bluetooth feature of your ASUS Tablet in full scale, you have to pair it first with the Bluetooth device. The ASUS Tablet automatically stores the pairing connection of the Bluetooth device.

1. On the Settings screen, tap **Bluetooth** to display all available devices.

IMPORTANT!

- If the device that you want to pair is not in the list, ensure to enable its Bluetooth feature and is discoverable.
 - See the user guide that came with your device to learn how to enable its Bluetooth and set it to discoverable.
-

2. Tap your ASUS Tablet to make it visible to other Bluetooth devices.
3. Tap **SEARCH FOR DEVICES** to scan for more Bluetooth devices.
4. In the list of available devices, tap the Bluetooth device that you want to pair with.
5. Ensure that the same passkey show on both devices, then tap **Pair**.

NOTE: Turn off the Bluetooth feature when you're not using it to help save battery power.

Unpairing your ASUS Tablet from the Bluetooth® device

1. On the Settings screen, tap Bluetooth to display all available and paired devices.
2. In the list of paired devices, tap  of Bluetooth device that you want to unpair, then tap **Unpair**.



Tethering

You can use your ASUS Tablet to link with other devices using Share Link, or link to a printer.

NOTE: Turn off the tethering feature when you're not using it to help save battery power.

Wi-Fi Hotspot

Turn your ASUS Tablet into a Wi-Fi Hotspot to link with other devices.

1. Do any of the following to launch the Settings screen:
 - Launch Quick settings then tap .
 - Tap  > **Settings**.
2. Tap **More...** > **Tethering** > **Set up Wi-Fi hotspot**.
3. Assign a unique SSID or network name and a strong 8-character password for your Wi-Fi hotspot. When done, tap **Save**.

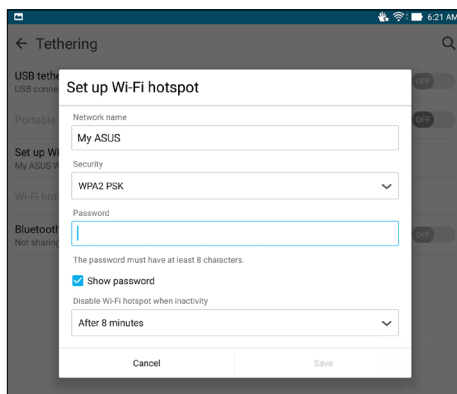

4. From the Tethering screen, tap **Wi-Fi hotspot** to turn on the Wi-Fi hotspot on your ASUS Tablet.

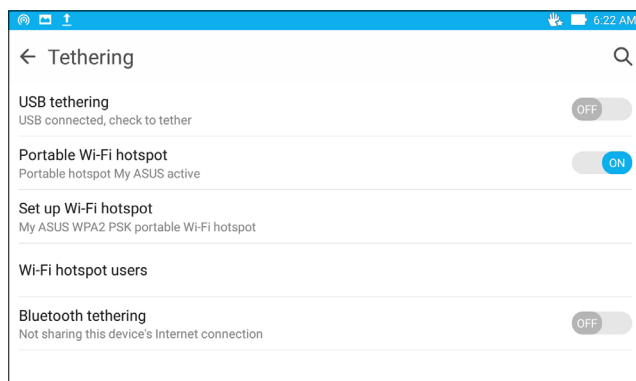

5. Connect other devices to your ASUS Tablet's hotspot connection the same way you connect to a Wi-Fi network.

Bluetooth Tethering

Enable Bluetooth on your ASUS Tablet and use it to link with other devices using Share Link, or link to a printer.

1. Enable Bluetooth on your ASUS Tablet and the other device.
2. Pair both devices.

NOTE: For details, see [Pairing your ASUS Tablet to a Bluetooth® device](#).

3. From the Settings screen, tap **More...** > **Tethering**, then slide **Bluetooth tethering** to **ON**.

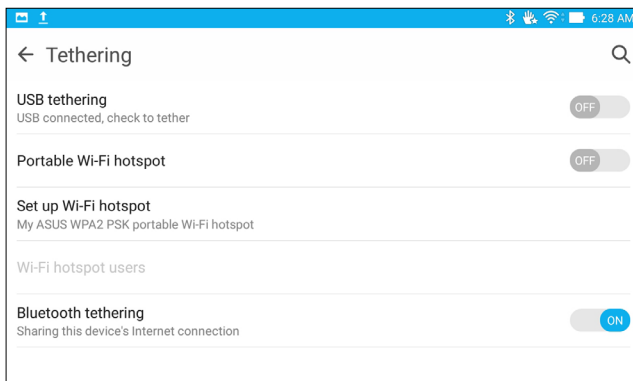

PlayTo

PlayTo app lets you screencast your ASUS Tablet to a streaming-supported display. Doing this allows an external display to become a dual monitor or second screen to your ASUS Tablet.

IMPORTANT! Your external display must have Miracast™ or DLNA® technology to support PlayTo app.

Launching PlayTo

There are two ways you can use to start using PlayTo from your ASUS Tablet.

From Quick settings

1. Setup the streaming-supported display you want to use with your ASUS Tablet.
2. Launch Quick settings on your ASUS Tablet then tap **PlayTo**.
3. Refer to the SSID shown on your streaming-supported display and select the same SSID on your ASUS Tablet to start pairing.

Once the connection is made, your streaming-supported display shows the same content currently shown on your ASUS Tablet.

From Settings

1. Tap  > **Settings**.
2. Under Wireless & networks, tap **More...** then tap **PlayTo**.
3. Refer to the SSID shown on your streaming-supported display and select the same SSID on your ASUS Tablet to start pairing.

Once the connection is made, your streaming-supported display shows the same content currently shown on your ASUS Tablet.

Travel and Maps

8

Weather

Get real-time weather updates straight from your ASUS Tablet using the weather app. Using Weather, you can also check other weather details from around the world.

Launching the Weather app

From your Home screen, launch the Weather app using either of the following options:

- Tap  > **Weather**.
- From your ASUS Tablet's home screen, tap the weather icon.

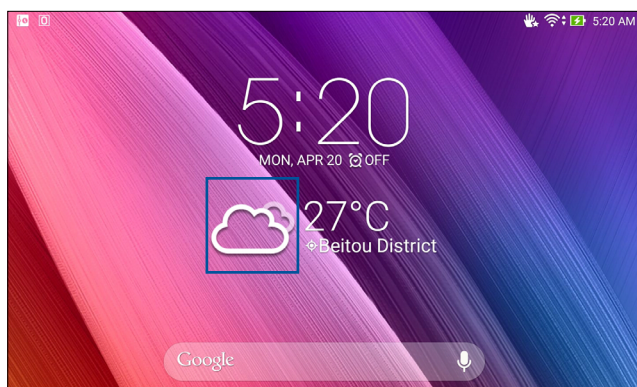

Weather home screen

Set up and get your current location's weather updates as well as other parts of the world. You can display the weather updates or daily weather forecast on the What's Next widget or app, and on the Calendar app.

NOTE: For more details, see [Getting the weather updates](#).

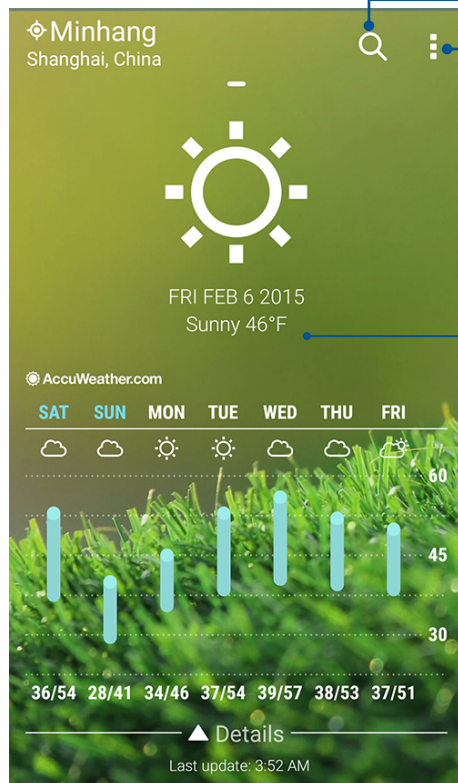

Tap to search for a city's weather info

Tap to get the area's current weather info, refresh the weather info, edit the location list, or configure the weather settings

Swipe up to see other weather information.
Swipe to the left or right to see the weather information of other cities in your location list

Clock

Customize the time zone settings of your ASUS Tablet, set alarms, and use your ASUS Tablet as a stop watch using the Clock app.

Launching Clock

Launch the Clock app using either of the following options:

- Tap  > **Clock**.
- From your ASUS Tablet's home screen, tap the digital clock display.

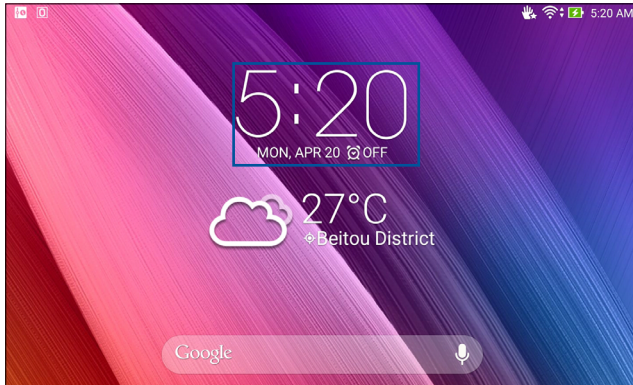

World Clock

Tap  to access the world clock settings of your ASUS Tablet.

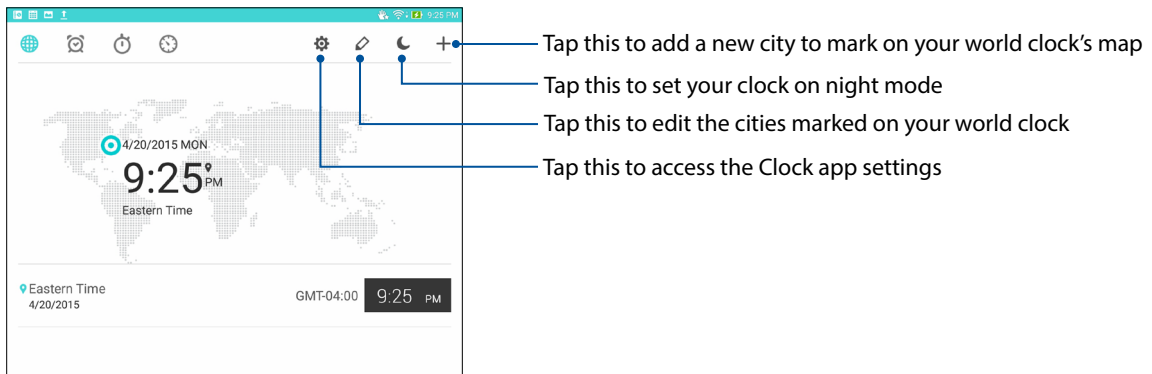

Alarm clock

Tap  to access the world clock settings of your ASUS Tablet.

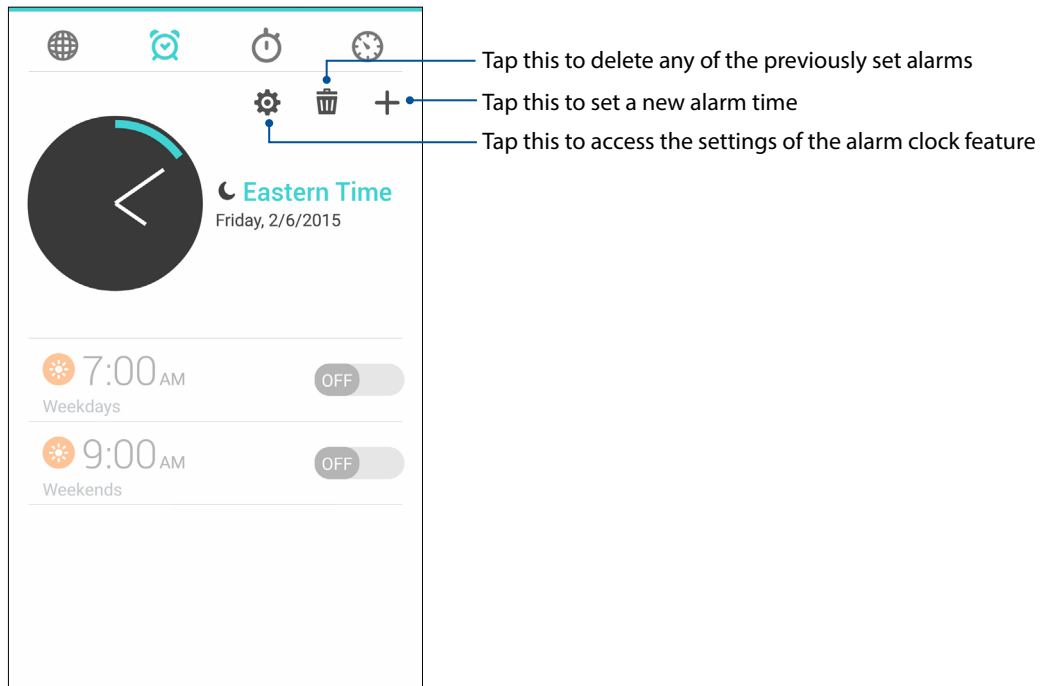

Stopwatch

Tap  to use your ASUS Tablet as a stopwatch.

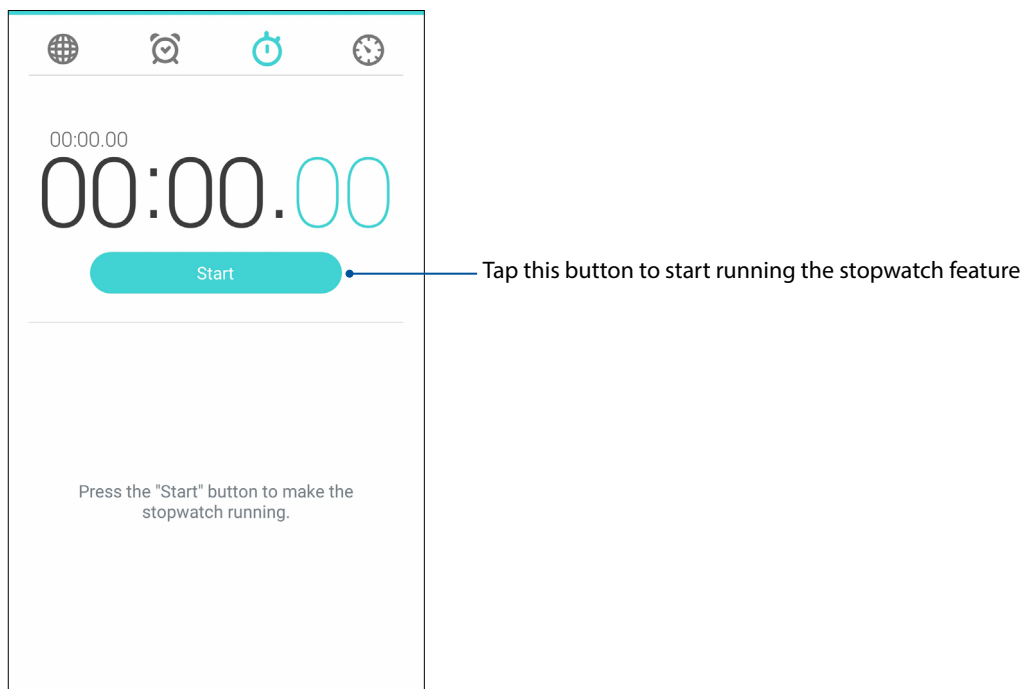

Timer

You may set multiple timer options for your ASUS Tablet. To do this, follow the steps below.

Setting the timer

1. Tap  to access the timer feature of your ASUS Tablet.

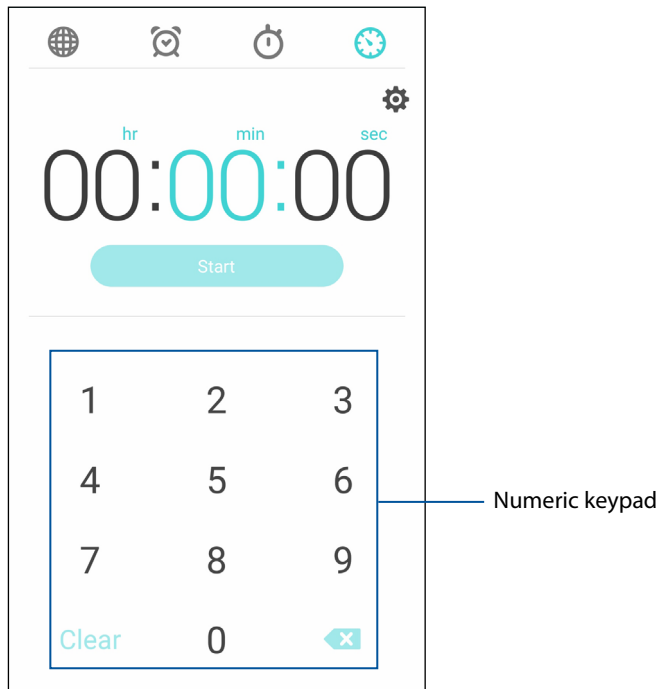

2. Use the numeric keypad to input your target time then tap start to start the timer.

Knowing ZenLink

Stay connected with the ASUS-exclusive ZenLink for maximum productivity. With these ZenLink apps, you can connect with other devices to share and receive files.

Your ZenLink comprises of the following apps: Share Link, PC Link, and Remote Link

NOTE: Some of these ZenLink apps may not be available in your ASUS Tablet.

Share Link

Share and receive files, apps, or media contents with Android mobile devices using Share Link app (for ASUS mobile devices) or SHAREit app (for other mobile devices) via a Wi-Fi hotspot. With this app, you can send or receive files that are larger than 100 MB and lets you share or receive multiple files at the same time. Share Link app sends and receives files faster than using Bluetooth.

Sharing files

1. From your Home screen, tap **ZenLink** > **Share Link**.
2. Tap **Send file** then select from the options that appear on your screen.

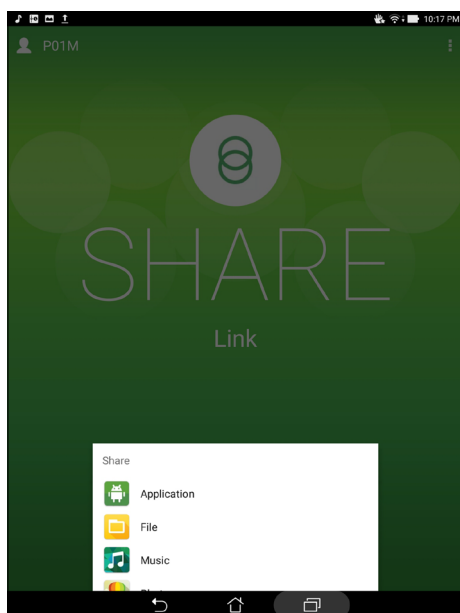

3. Tap the files that you want to send then tap **Done**.
4. After your ASUS Tablet detects the other devices, tap the device that you want to share your files with.



Receiving files

To receive files:

1. From your Home screen, tap  then tap **Share Link**.
2. Tap **Receive file** to receive the files from the sender.

PC Link

Use your computer to access and control your ASUS Tablet and its apps via the PC Link. It allows you to control your ASUS Tablet using your computer's keyboard and mouse.

NOTE: Before using PC Link, ensure to install PC Link to your computer. Go to <http://pmlink.asus.com> to download and install PC Link.

Using PC Link

To use PC Link:

1. Connect your ASUS Tablet to your computer using a USB cable.
2. In your ASUS Tablet, a pop-up screen **Allow USB debugging** appears. tap **OK** to allow connection between your computer and your ASUS Tablet.
3. From your computer's desktop, launch **PC Link** then click **Connect**.

4. On the PC Link screen, click **OK**. When connected, you can access and control your device using the keyboard for typing and mouse for hand gestures.

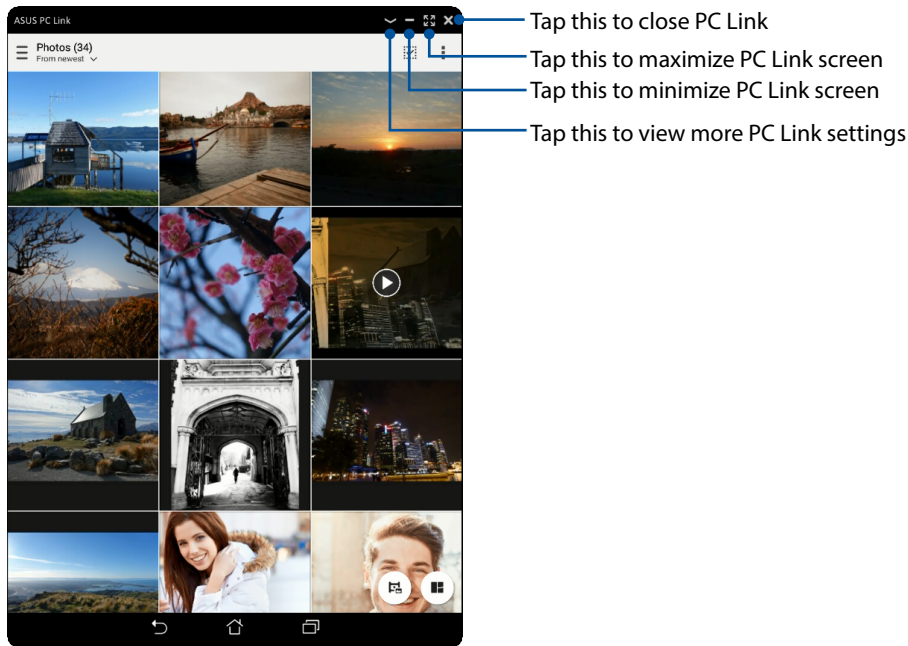

Understanding the PC Link settings



Click this icon to rotate the mirrored ASUS Tablet screen on your computer screen.



Click this icon to increase or decrease the volume.



Click this icon to capture a screenshot.



Click this icon to wake your ASUS Tablet or put it to sleep.



Click this icon to check for PC Link updates and assign a path for your screenshots.

Remote Link

Turn your ASUS Tablet into a wireless input device and a presentation tool. Using this app, you can use your ASUS Tablet as a touchpad, touchscreen panel, laser pointer for presentations, and Windows® Media Player controller while connected to your computer via bluetooth or Wi-Fi.

NOTE:

- Before using Remote Link, ensure to install Remote Link to your computer. Go to <http://remotelink.asus.com> to download PC Link and install it to your computer.
 - Ensure to pair your computer and your ASUS Tablet first before using Remote Link.
-

Using Remote Link

To use Remote Link:

1. From your Home screen, tap  then tap **Remote Link**.
2. Tap **Search device** then select the device that you want to connect.

Remote Link touch pad

Tap  to activate ASUS Smart gesture and navigate your computer.

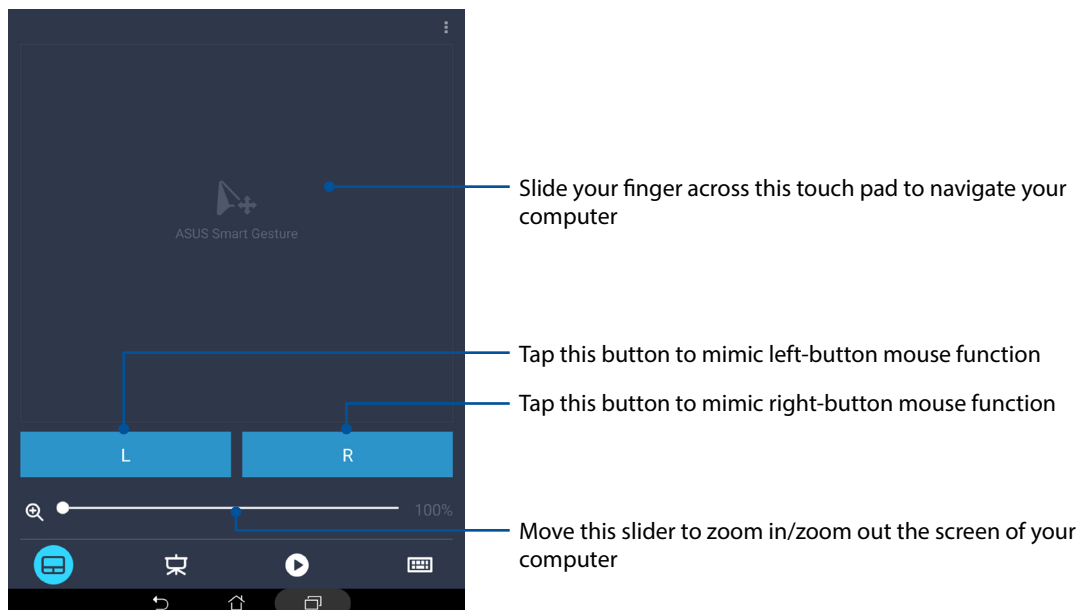

Remote Link presentation controller

Tap  to control the presentation slides on your computer.

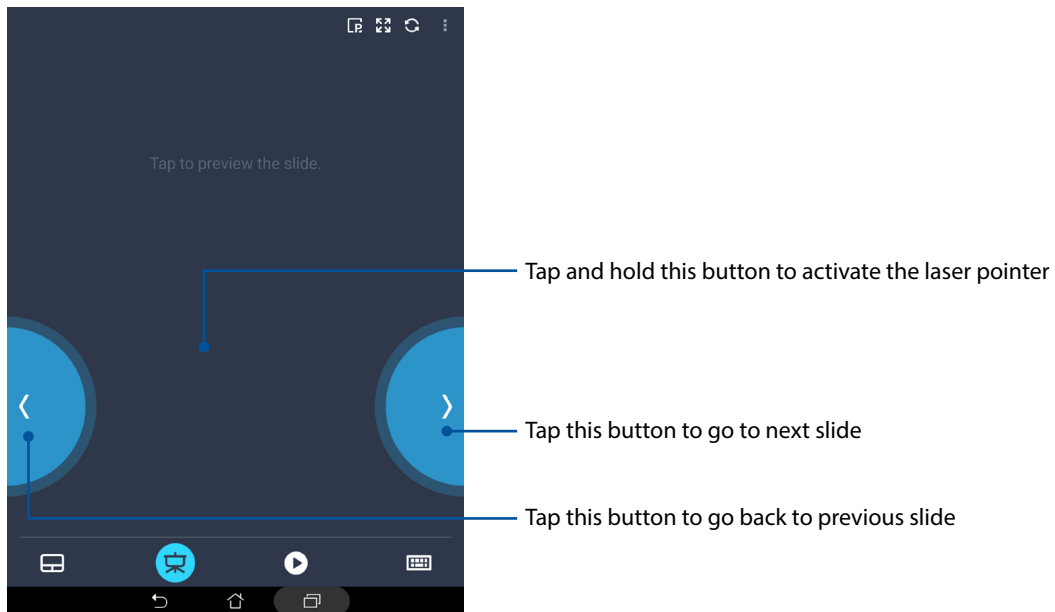

Remote Link Windows® Media Player controller

Tap  to control the Windows® Media player.

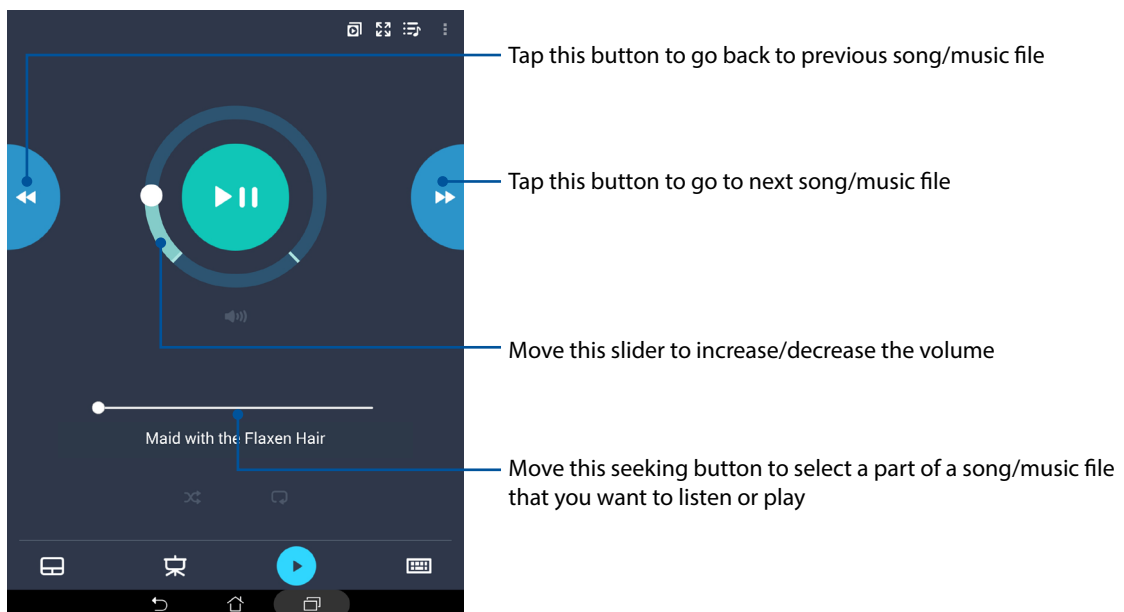

Remote Link keyboard input

Tap  to use keyboard input. You can also use the microphone icon for voice input.

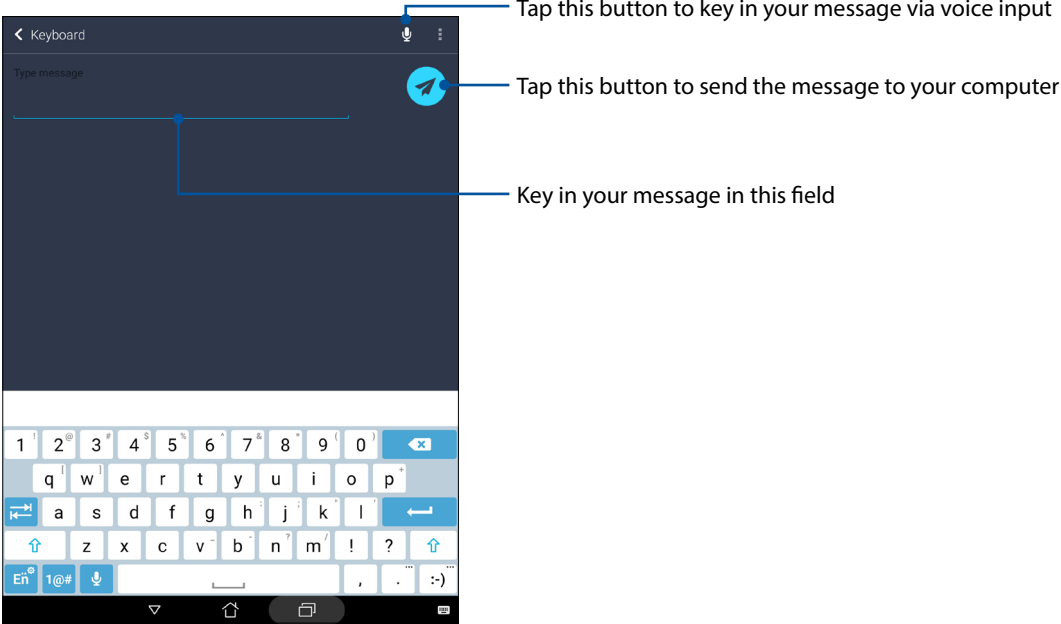

Special Zen Tools

Calculator

One-swipe and a tap is all it takes to launch your Calculator. When you open the Quick settings panel, the Calculator icon is there visibly on top of the list. Tap it to get started with your computations.

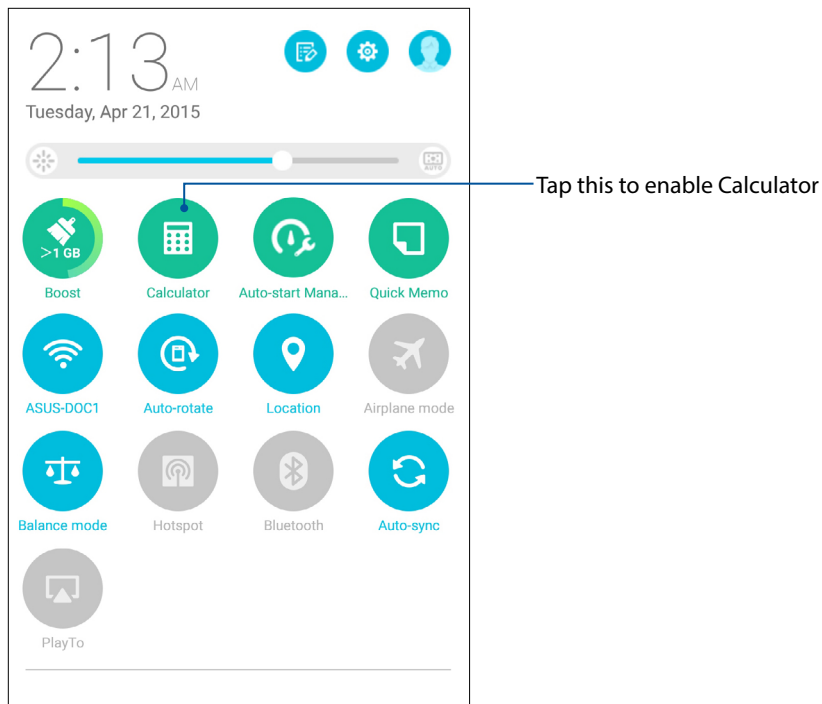

Calculator screen

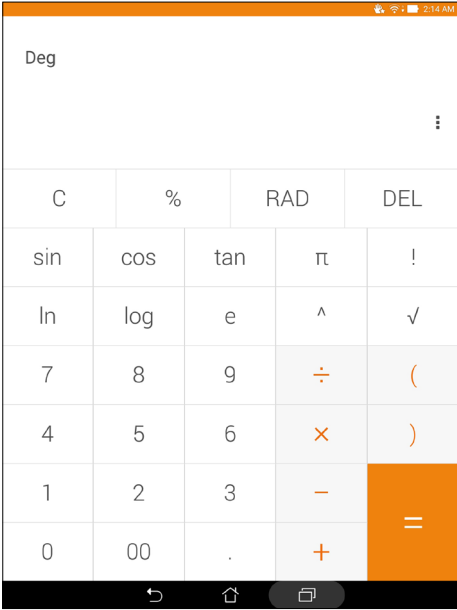

Quick Memo

Quick Memo is a note-taking tool that gives you the freedom to either scribble or type down important notes you need to remember. After creating notes, you can share them via Share Link and social media sites or turn them into a task inside Do It Later.

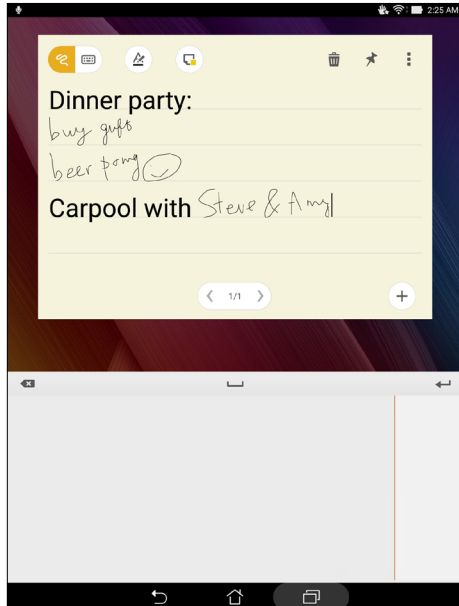

Creating a sticky note

You can turn Quick Memo notes into a sticky note so you can view them anywhere on your ASUS Tablet. To create a sticky note, just tap on the pin icon on the upper right corner of Quick Memo after creating your note.

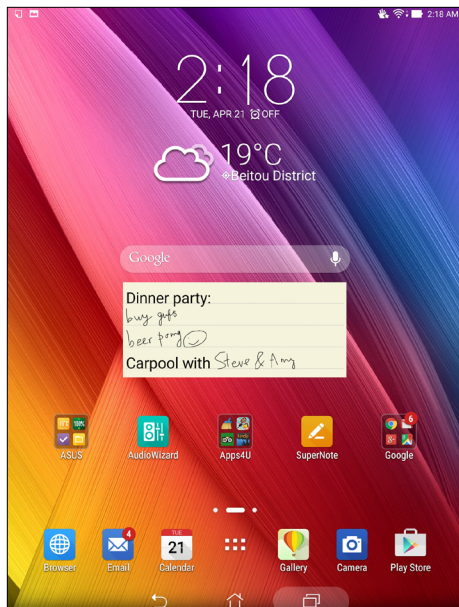

Sound Recorder

Record audio files using your ASUS Tablet by enabling the Sound Recorder app.

Launching Sound Recorder

To launch Sound Recorder, tap  > **Sound Recorder**.

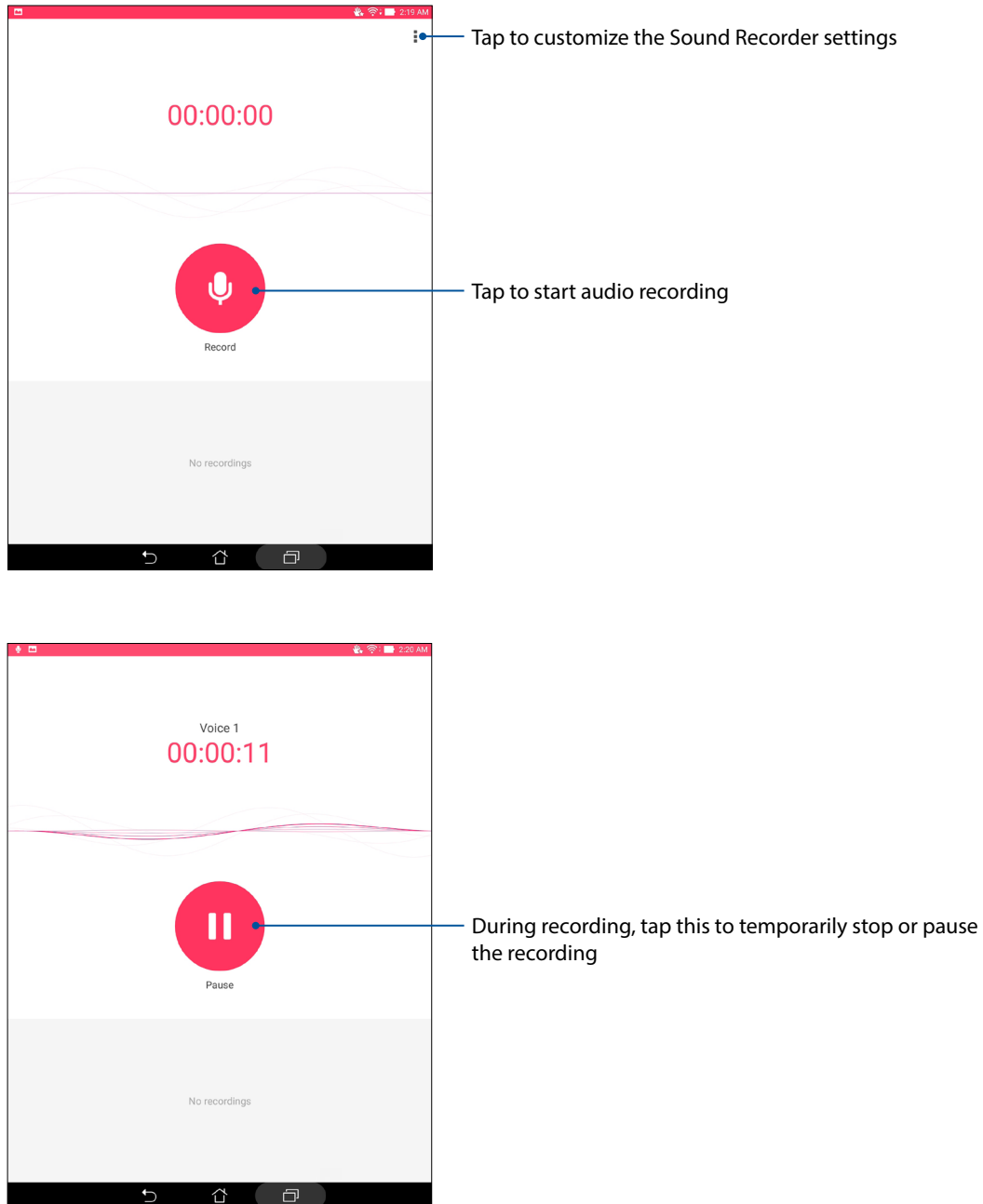

Pausing a recording

During a paused recording, you can choose to resume, delete, or save the recording.

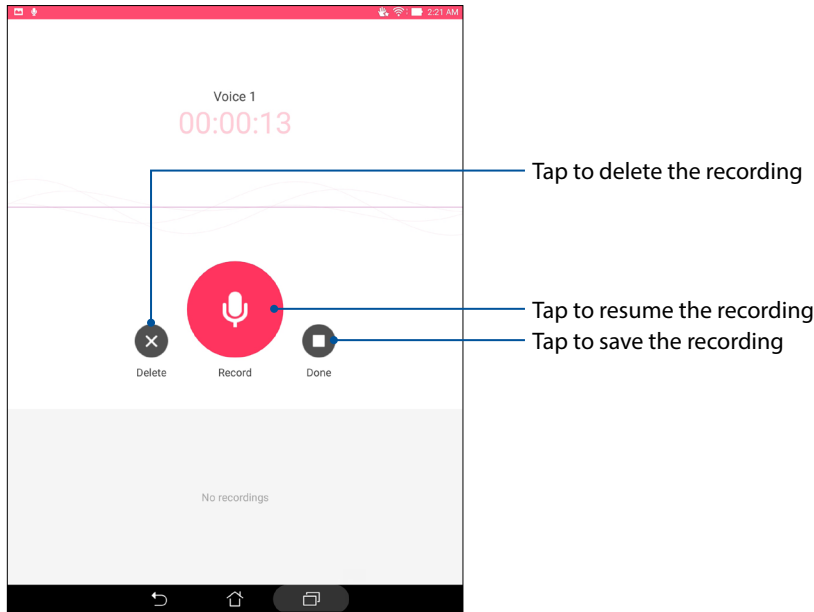

Recording List

From the Recording List, you can play, rename, share, or deleted a saved audio recording file. View your recording list at the bottom of the sound Recorder main screen.

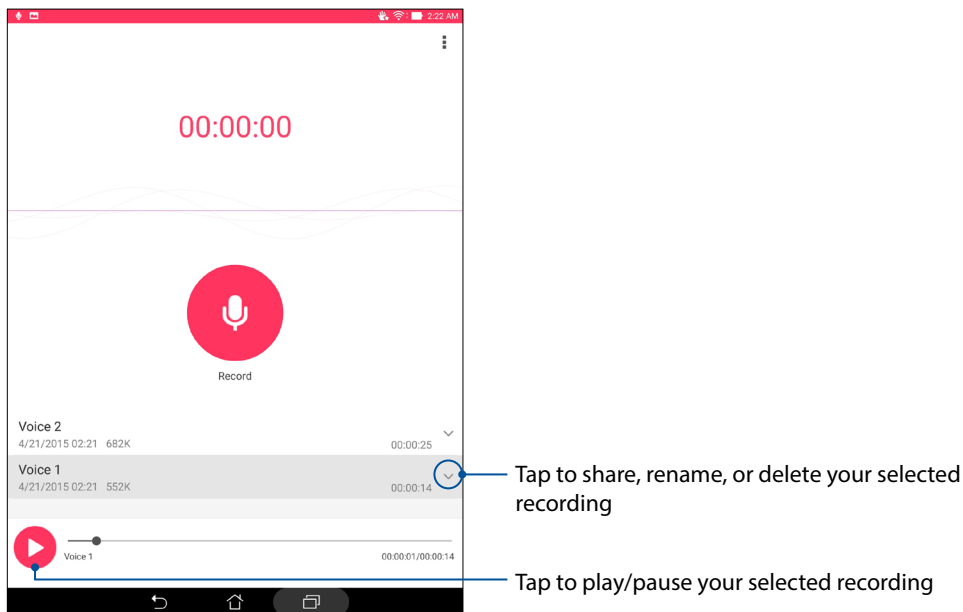

Audio Wizard

Audio Wizard allows you to customize the sound modes of your ASUS Tablet for a clearer audio output that fits actual usage scenarios.

Using Audio Wizard

To use AudioWizard:

1. Tap **ASUS > Audio Wizard**.
2. In the AudioWizard window, tap the sound mode you want to activate then tap **Done** to save and exit.

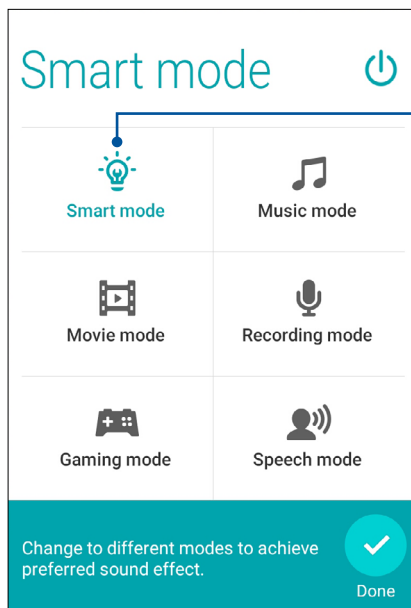

When enabled, the ASUS Tablet auto-switches to the best audio quality for the currently-running ASUS app

Splendid

ASUS Splendid allows you to easily adjust the display settings. It enriches the color of your screen with its preset screen color modes.

Using Splendid

To use Splendid:

1. From your Home screen tap **ASUS > Splendid**.
2. Select any of these screen color modes: **Balance**, **Blue Light Filter**, **Vivid**, and **Customized**.

Balance mode

This mode provides a balanced display of color on your ASUS Tablet.

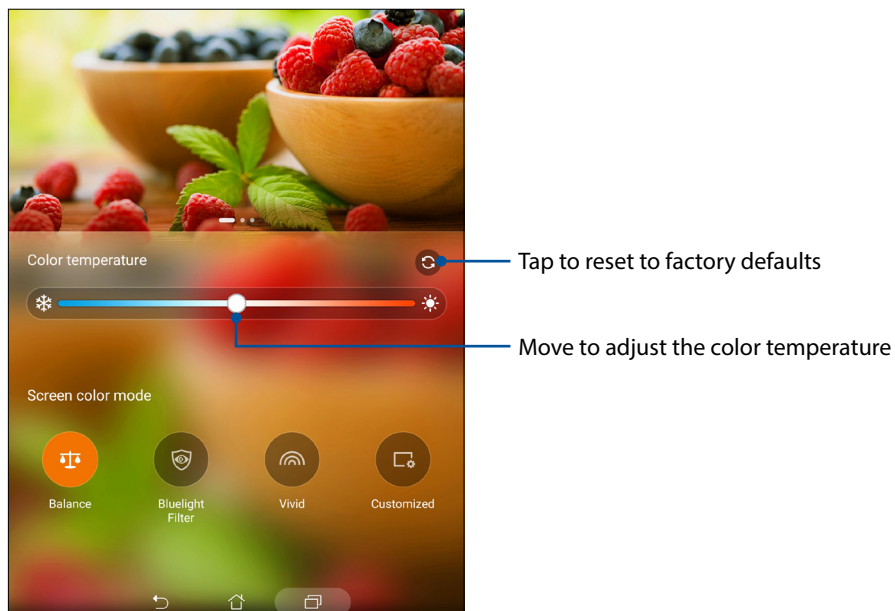

Bluelight Filter mode

This mode provides a mild paper-like display that reduces eye strain for a comfortable reading experience on your ASUS Tablet.

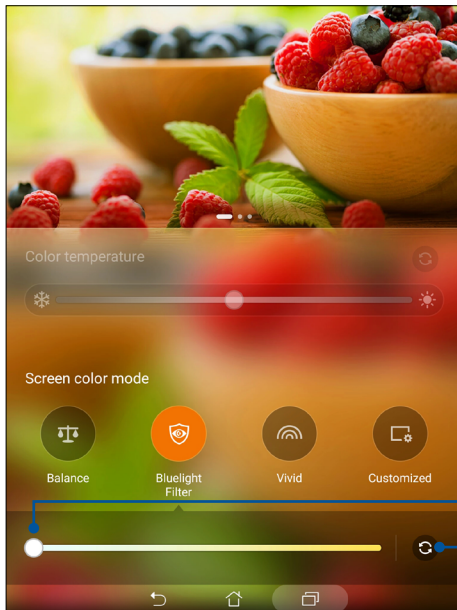

Move to adjust the color temperature

Tap to reset to factory defaults

Vivid mode

This mode provides a fine-tuned color preset that enriches the screen color of your ASUS Tablet.

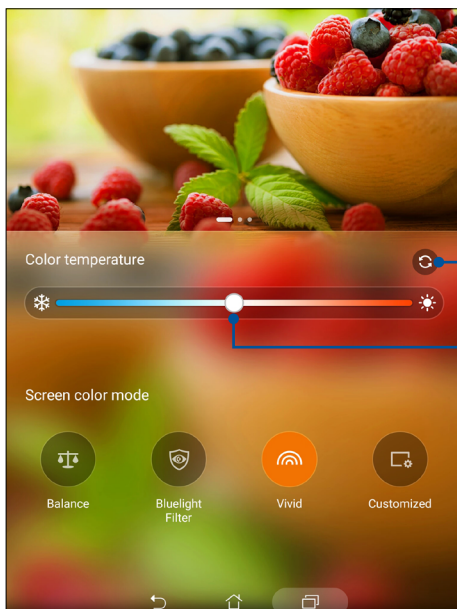

Tap to reset to factory defaults

Move to adjust the color temperature

Customized mode

This mode allows you to adjust the screen display based on your preferred color temperature, hue, and saturation.

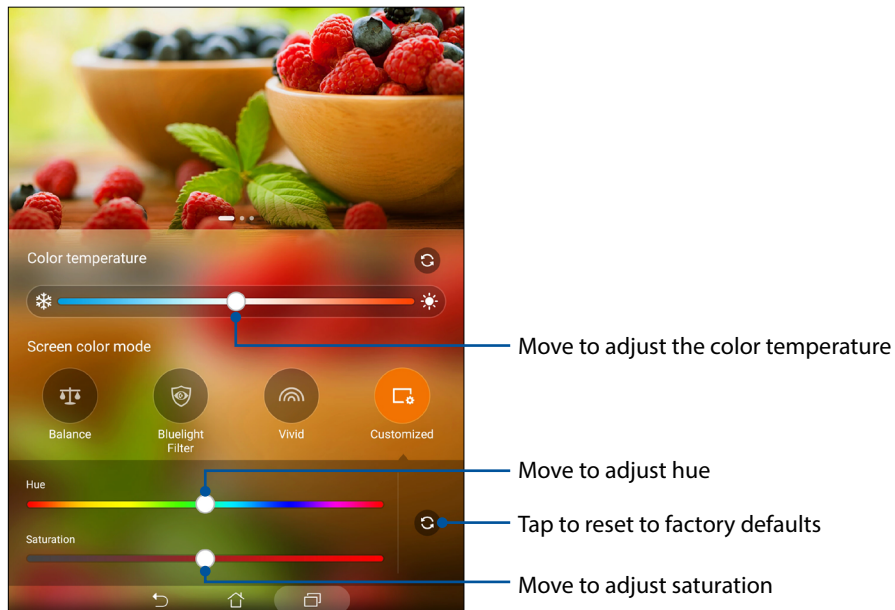

NOTE: You can also quickly set the Splendid screen mode from the Quick settings panel.

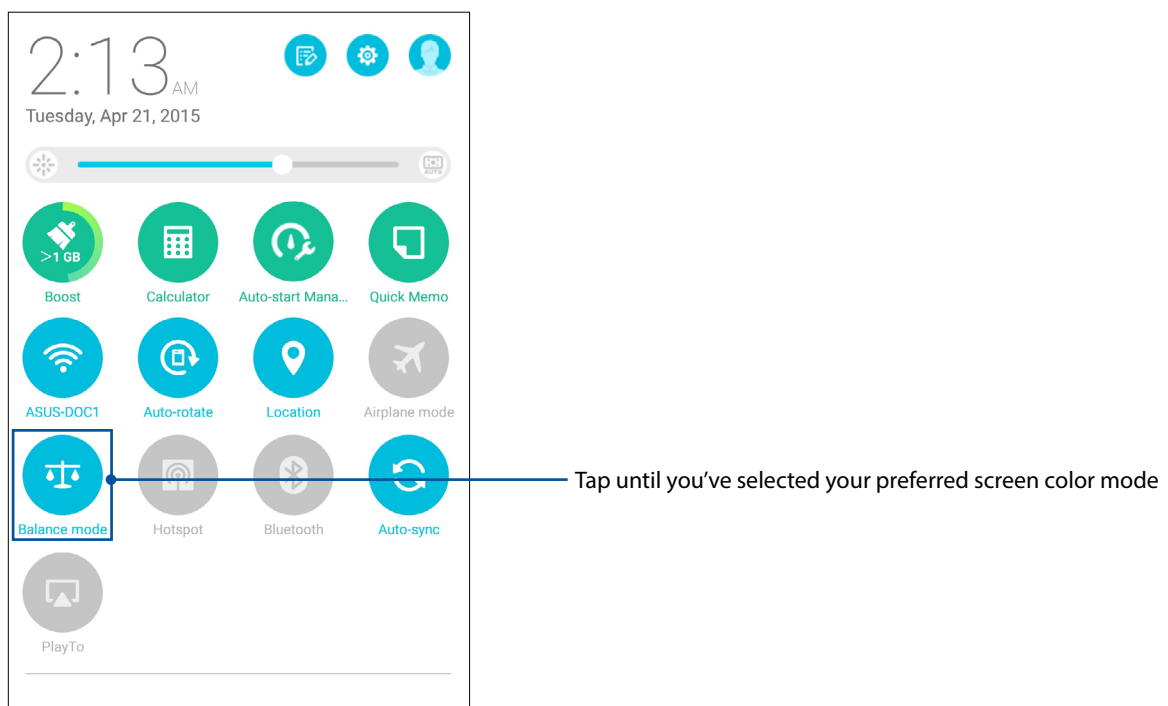

Power Saver

Fully maximize or extend the power of your ASUS Tablet even when it is idle or while it stays connected to your network. Smartly customize the power settings for your frequent activities such as reading emails or watching videos.

Setting up Power Saver

Maximize, optimize, or customize the power of your ASUS Tablet with some smart power saving options.

1. Do any of the following to launch Power Saver:
 - Swipe down with two fingers from the top to launch the Quick Settings panel, then tap **Smart saving**.
 - Tap **ASUS > Power Saver**.
2. Slide Smart saving to **ON**.

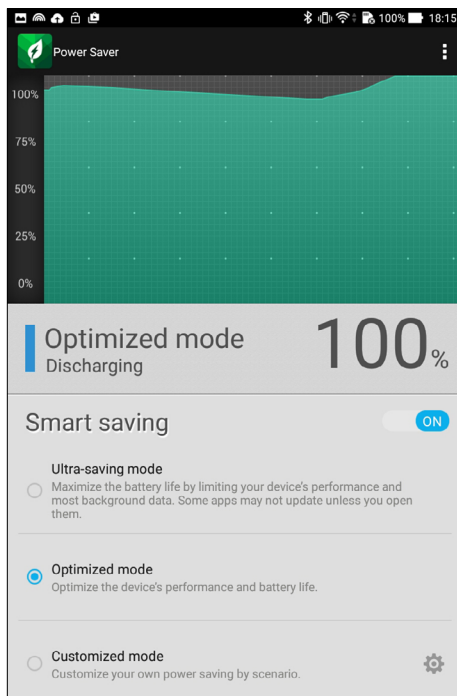

3. Select any of these modes:
 - **Ultra-saving mode:** Disconnects the network connection when your ASUS Tablet is idle to fully maximize its battery life.
 - **Optimized mode:** Extends the battery life while your ASUS Tablet stays connected to your network.
 - **Customized mode:** Allows you to set up the power settings for your frequent activities.

Customizing Power Saver

Set the brightness level for your frequent activities such as reading emails or ebooks, watching videos, browsing websites, and listening to music. You can also enable the power saving function for some apps or enable the auto-disconnection of your network when your ASUS Tablet is asleep.

1. From **Power Saver**, tick **Customized mode**, then tap .
2. Tick an activity, then set the brightness level in percentage.
3. If you want to enable the auto-disconnection of your network, tick **IM and other apps using push notification**. Your ASUS Tablet will automatically disconnect from your network when it is idle, and will resume the network connection when you wake up your ASUS Tablet.

Keeping your device up-to-date

Keep your ASUS Tablet in the loop of Android system updates and upgraded apps and features.

Updating your system

1. Tap  then tap **Settings**.
2. On the Settings screen, slide down to display other items then tap **About**.
3. Tap **System update** then tap **Check Update**.

NOTE: You can preview the last time your ASUS Tablet's system was updated in the Last check for update section.

Storage

You can store data, apps, or files on your ASUS Tablet (internal storage), on an external storage, or on an online storage. You need an internet connection to transfer or download your files on an online storage. Use the bundled USB cable to copy files to or from the computer to your ASUS Tablet.

Backup and reset

Back up data, Wi-Fi passwords, and other settings to Google servers using your ASUS Tablet.

1. Tap  then tap **Settings > Backup and reset**.
2. From the Backup & reset window, you can:
 - **Backup my data:** This feature backs up your data, Wi-Fi passwords, and other settings to Google servers when enabled.
 - **Backup account:** Allows you to specify the account you to be associated when you save your backup.
 - **Automatic Restore:** This features facilitates restoration of backed up settings and data when you reinstall an app.
 - **Factory data reset:** Erases all data on tablet.

Securing your ASUS Tablet

Use the security features of your ASUS Tablet to prevent unauthorized access of information.

Unlocking your screen

When the screen is locked, you can open it with the security unlocking options that the ASUS Tablet offers you.

1. Tap **■ ■ ■ ■** then tap **Settings > Lock Screen**.
2. Tap **Screen lock** then select an option to unlock your ASUS Tablet.

NOTE:

- Refer to section **Unlock screen options** for more information.
 - To deactivate the unlock screen option that you set, tap **None** on Choose screen lock screen.
-

Unlock screen options

Choose from these options to lock your ASUS Tablet.

Swipe

Swipe up to unlock your ASUS Tablet.

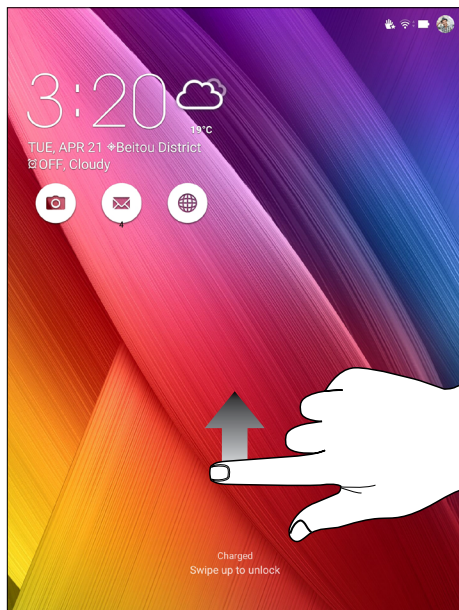

PIN

Key in at least four numbers to set a PIN.

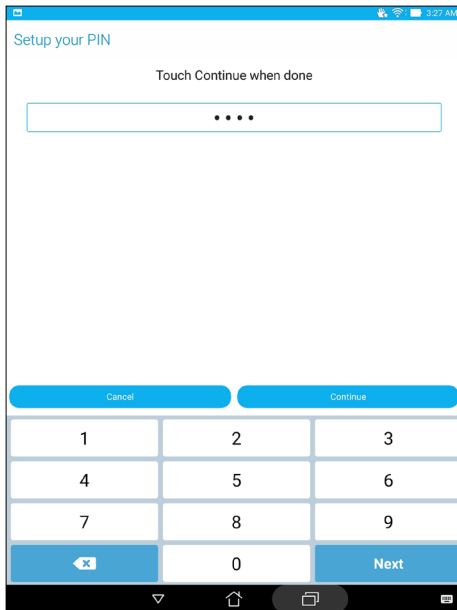

IMPORTANT! Ensure to remember the PIN that you created to unlock your device

Pattern

Slide your finger on the dots and create a pattern.

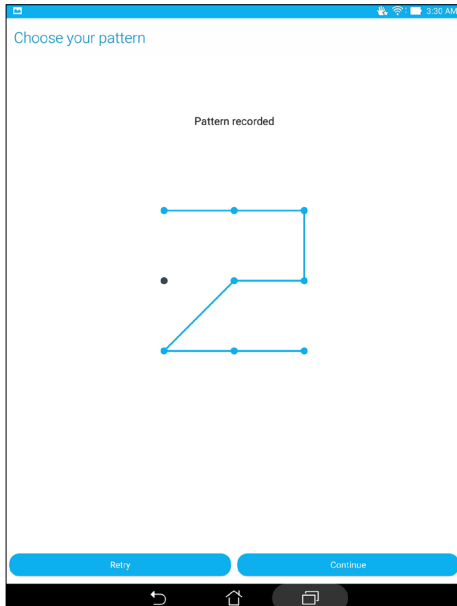

IMPORTANT! You can create a pattern with a minimum of four dots. Ensure to remember the pattern that you created to unlock your device.

Password

Key in at least four characters to create a password.

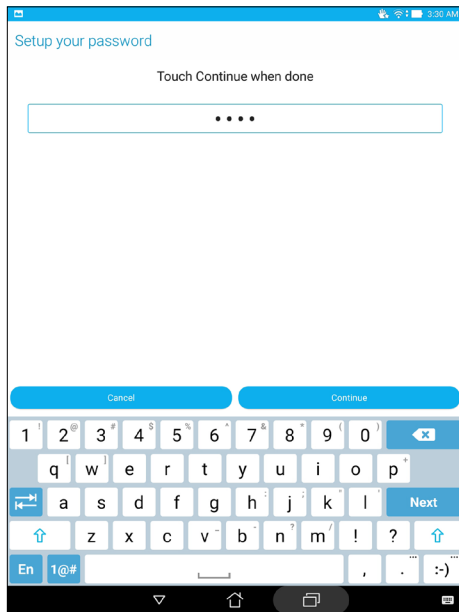

IMPORTANT! Ensure to remember the password that you created to unlock your device.

Configuring the other screen security features

Aside from the mode of screen lock, you can also do the following on the Screen security window:

- **Quick Access:** Slide the Quick Access switch to **ON** to launch apps on the lock screen.
- **Instant camera:** Slide the Instant camera switch to **ON** to launch the Camera app even if your ASUS Tablet is in idle mode by pressing the volume button twice.
- **Owner info:** Tap this to edit and key in the information that you want to appear even when your screen is locked.

Setting your ASUS Tablet identity

Know your ASUS Tablet's identity such as serial number, IMEI (International Mobile Equipment Identity) number, or model number.

This is important, as when you lose your ASUS Tablet, you can contact your mobile carrier and provide the information to blacklist the unauthorized use of your ASUS Tablet.

To display your ASUS Tablet's identity:

1. Tap **All Apps** then tap **Settings**.
2. On the Settings screen, slide down to display other items then tap **About**. The About screen displays the status, legal information, model number, operating system version, hardware, and software information of your ASUS Tablet.
3. To see the serial number and IMEI of your ASUS Tablet, tap **Status**.

Appendix

Notices

Federal Communications Commission Statement

This device complies with FCC Rules Part 15. Operation is subject to the following two conditions:

- This device may not cause harmful interference.
- This device must accept any interference received, including interference that may cause undesired operation.

This equipment has been tested and found to comply with the limits for a class B digital device, pursuant to Part 15 of the Federal Communications Commission (FCC) rules. These limits are designed to provide reasonable protection against harmful interference in a residential installation. This equipment generates, uses, and can radiate radio frequency energy and, if not installed and used in accordance with the instructions, may cause harmful interference to radio communications. However, there is no guarantee that interference will not occur in a particular installation. If this equipment causes harmful interference to radio or television reception, which can be determined by turning the equipment off and on, the user is encouraged to try to correct the interference by doing one or more of the following measures:

- Reorient or relocate the receiving antenna.
- Increase the separation between the equipment and receiver.
- Connect the equipment into an outlet on a circuit different from that to which the receiver is connected.
- Consult the dealer or an experienced radio/TV technician for help.

Changes or modifications not expressly approved by the party responsible for compliance could void the user's authority to operate the equipment.

The antenna(s) used for this transmitter must not be co-located or operating in conjunction with any other antenna or transmitter.

For FCC and IC e-labelling information, please go to Settings > About > Regulatory information .

RF Exposure Information (SAR)

This device meets the government's requirements for exposure to radio waves. This device is designed and manufactured not to exceed the emission limits for exposure to radio frequency (RF) energy set by the Federal Communications Commission of the U.S. Government.

The exposure standard employs a unit of measurement known as the Specific Absorption Rate, or SAR. The SAR limit set by the FCC is 1.6 W/kg. Tests for SAR are conducted using standard operating positions accepted by the FCC with the EUT transmitting at the specified power level in different channels.

The highest SAR value for the device as reported to the FCC is 1.14 W/kg when placed next to the body.

The FCC has granted an Equipment Authorization for this device with all reported SAR levels evaluated as in compliance with the FCC RF exposure guidelines. SAR information on this device is on file with the FCC and can be found under the Display Grant section of www.fcc.gov/oet/ea/fccid after searching on FCC ID: MSQP01M.

Canada, Industry Canada (IC) Notices

This device complies with Industry Canada license-exempt RSS standard(s).

This Class B digital apparatus complies with Canadian ICES-003 and CAN ICES-3(B)/NMB-3(B).

Operation is subject to the following two conditions: (1) this device may not cause interference, and (2) this device must accept any interference, including interference that may cause undesired operation of the device. The IC ID for this device is 3568A-P01M.

For FCC and IC e-labelling information, please go to Settings > About > Regulatory information .

Radio Frequency (RF) Exposure Information

The radiated output power of the Wireless Device is below the Industry Canada (IC) radio frequency exposure limits. The Wireless Device should be used in such a manner such that the potential for human contact during normal operation is minimized. This device has been evaluated for and shown compliant with the IC Specific Absorption Rate ("SAR") limits when installed in specific host products operated in portable exposure conditions.

Canada's REL (Radio Equipment List) can be found at the following web address:

<http://www.ic.gc.ca/app/sitt/reldtel/srch/nwRdSrch.do?lang=eng>

Additional Canadian information on RF exposure also can be found at the following web address:

<http://www.ic.gc.ca/eic/site/smt-gst.nsf/eng/sf08792.html>

Canada, avis d'Industrie Canada (IC)

Le présent appareil est conforme aux CNR d'Industrie Canada applicables aux appareils radio exempts de licence.

Cet appareil numérique de classe B est conforme aux normes canadiennes ICES-003 et CAN ICES-3(B)/NMB-3(B).

Son fonctionnement est soumis aux deux conditions suivantes: (1) cet appareil ne doit pas causer d'interférence et (2) cet appareil doit accepter toute interférence, notamment les interférences qui peuvent affecter son fonctionnement. L'identifiant IC de cet appareil est 3568A-P01M.

Pour les informations d'étiquette électrique de FCC et IC, s'il vous plaît aller à **Paramètres > À propos > infos réglementaires.**

Informations concernant l'exposition aux fréquences radio (RF)

La puissance de sortie émise par cet appareil sans fil est inférieure à la limite d'exposition aux fréquences radio d'Industrie Canada (IC). Utilisez l'appareil sans fil de façon à minimiser les contacts humains lors du fonctionnement normal.

Ce périphérique a été évalué et démontré conforme aux limites SAR (Specific Absorption Rate – Taux d'absorption spécifique) d'IC lorsqu'il est installé dans des produits hôtes particuliers qui fonctionnent dans des conditions d'exposition à des appareils portables.

Ce périphérique est homologué pour l'utilisation au Canada. Pour consulter l'entrée correspondant à l'appareil dans la liste d'équipement radio (REL - Radio Equipment List) d'Industrie Canada rendez-vous sur:

<http://www.ic.gc.ca/app/sitt/reltel/srch/nwRdSrch.do?lang=eng>

Pour des informations supplémentaires concernant l'exposition aux RF au Canada rendez-vous sur :

<http://www.ic.gc.ca/eic/site/smt-gst.nsf/eng/sf08792.html>

EC Declaration of Conformity

This product is compliant with the regulations of the R&TTE Directive 1999/5/EC. The Declaration of Conformity can be downloaded from <http://www.asus.com/support>.



For DTS patents, see <http://patents.dts.com>. Manufactured under license from DTS Licensing Limited. DTS, DTS-HD, the Symbol, & DTS or DTS-HD and the Symbol together are registered trademarks, and DTS-HD Premium Sound is a trademark of DTS, Inc. © DTS, Inc. All Rights Reserved.

Prevention of Hearing Loss

To prevent possible hearing damage, do not listen at high volume levels for long periods.



À pleine puissance, l'écoute prolongée du baladeur peut endommager l'oreille de l'utilisateur.

For France, headphones/earphones for this device are compliant with the sound pressure level requirement laid down in the applicable EN 50332-1:2000 and/or EN50332-2:2003 standard required by French Article L.5232-1.

CE Mark Warning



CE marking for devices with wireless LAN/ Bluetooth

This equipment complies with the requirements of Directive 1999/5/EC of the European Parliament and Commission from 9 March, 1999 governing Radio and Telecommunications Equipment and recognition of conformity.

The highest CE SAR value for the device is 0.567 W/Kg.

This equipment may be operated in:

AT	BE	BG	CH	CY	CZ	DE	DK
EE	ES	FI	FR	GB	GR	HU	IE
IT	IS	LI	LT	LU	LV	MT	NL
NO	PL	PT	RO	SE	SI	SK	TR

ENERGY STAR complied product



ENERGY STAR is a joint program of the U.S. Environmental Protection Agency and the U.S. Department of Energy helping us all save money and protect the environment through energy efficient products and practices.

All ASUS slate computers with the ENERGY STAR logo comply with the ENERGY STAR standard, and the power management feature is enabled by default. The display will be automatically set to sleep within 10 minutes user inactivity. Users could wake your computer through click the display, or press the power button.

Please visit <http://www.energy.gov/powermanagement> for detail information on power management and its benefits to the environment. In addition, please visit <http://www.energystar.gov> for detail information on the ENERGY STAR joint program.

NOTE: Energy Star is NOT supported on Freedos and Linux-based products.

IC Warning Statement

The device could automatically discontinue transmission in case of absence of information to transmit, or operational failure. Note that this is not intended to prohibit transmission of control or signaling information or the use of repetitive codes where required by the technology.

This device and its antenna(s) must not be co-located or operating in conjunction with any other antenna or transmitter, except tested built-in radios. The Country Code Selection feature is disabled for products marketed in the US/ Canada.

Cet appareil et son antenne ne doivent pas être situés ou fonctionner en conjonction avec une autre antenne ou un autre émetteur, exception faites des radios intégrées qui ont été testées. La fonction de sélection de l'indicatif du pays est désactivée pour les produits commercialisés aux États-Unis et au Canada.

RF Exposure information (SAR) - CE

This device meets the EU requirements (1999/5/EC) on the limitation of exposure of the general public to electromagnetic fields by way of health protection.

The limits are part of extensive recommendations for the protection of the general public. These recommendations have been developed and checked by independent scientific organizations through regular and thorough evaluations of scientific studies. The unit of measurement for the European Council's recommended limit for mobile devices is the "Specific Absorption Rate" (SAR), and the SAR limit is 2.0 W/Kg averaged over 10 gram of body tissue. It meets the requirements of the International Commission on Non-Ionizing Radiation Protection (ICNIRP).

For next-to-body operation, this device has been tested and meets the ICNRP exposure guidelines and the European Standard EN 50566 and EN 62209-2. SAR is measured with the device at a separation of 0 cm to the body while transmitting at the highest certified output power level in all frequency bands of the mobile device.

Power Safety Requirement

Products with electrical current ratings up to 6A and weighing more than 3Kg must use approved power cords greater than or equal to: H05VV-F, 3G, 0.75 mm² or H05VV-F, 2G, 0.75 mm².

ASUS Recycling/Takeback Services

ASUS recycling and takeback programs come from our commitment to the highest standards for protecting our environment. We believe in providing solutions for you to be able to responsibly recycle our products, batteries, other components as well as the packaging materials. Please go to <http://csr.asus.com/english/Takeback.htm> for detailed recycling information in different regions.

India RoHS

This product complies with the “India E-waste (Management and Handling) Rule 2011” and prohibits use of lead, mercury, hexavalent chromium, polybrominated biphenyls (PBBs) and polybrominated diphenyl ethers (PBDEs) in concentrations exceeding 0.1% by weight in homogenous materials and 0.01% by weight in homogenous materials for cadmium, except for the exemptions listed in Schedule-II of the Rule.

Coating notice

IMPORTANT! To provide electrical insulation and maintain electrical safety, a coating is applied to insulate the device except on the areas where the I/O ports are located.

Green ASUS notice

ASUS is devoted to creating environment-friendly products and packaging to safeguard consumers' health while minimizing the impact on the environment. The reduction of the number of the manual pages complies with the reduction of carbon emission.

For the detailed user manual and related information, refer to the user manual included in the ASUS Fonepad or visit the ASUS Support Site at <http://support.asus.com/>.

Regional notice for Singapore



This ASUS product complies with IDA Standards.

Model name: P01MA (Z580CA/Z8050CA)

Manufacturer:	ASUSTeK Computer Inc.
Address:	4F, No.150, LI-TE RD., PEITOU, TAIPEI 112, TAIWAN
Authorised representative in Europe:	ASUS Computer GmbH
Address:	HARKORT STR. 21-23, 40880 RATINGEN, GERMANY

EC Declaration of Conformity



We, the undersigned,

Manufacturer:	ASUSTeK COMPUTER INC.
Address:	4F, No. 150, LI-TE Rd., PEITOU, TAIPEI 112, TAIWAN
Authorized representative in Europe:	ASUS COMPUTER GmbH
Address, City:	HARKORT STR. 21-23, 40880 RATINGEN
Country:	GERMANY

declare the following apparatus:

Product name :	ASUS Tablet
Model name :	P01MA

conform with the essential requirements of the following directives:

2004/108/EC-EMC Directive

<input checked="" type="checkbox"/> EN 55022:2010+AC:2011	<input checked="" type="checkbox"/> EN 55024:2010
<input checked="" type="checkbox"/> EN 61000-3-2:2014,ClassA	<input checked="" type="checkbox"/> EN 61000-3-3:2013
<input type="checkbox"/> EN 55013:2001+A1:2003+A2:2006	<input type="checkbox"/> EN 55020:2007+A11:2011

1999/5/EC-R&TTE Directive

<input checked="" type="checkbox"/> EN 300 328 V1.9.1(2015-02)	<input checked="" type="checkbox"/> EN 301 489-1 V1.9.2(2011-09)
<input checked="" type="checkbox"/> EN 300 440-1 V1.6.1(2010-08)	<input checked="" type="checkbox"/> EN 301 489-3 V1.6.1(2013-08)
<input checked="" type="checkbox"/> EN 300 440-2 V1.4.1(2010-08)	<input type="checkbox"/> EN 301 489-4 V1.4.1(2009-05)
<input type="checkbox"/> EN 301 511 V9.0.2(2003-03)	<input type="checkbox"/> EN 301 489-7 V1.3.1(2005-11)
<input checked="" type="checkbox"/> EN 300 330-1 V1.7.1(2010-02)	<input type="checkbox"/> EN 301 489-9 V1.4.1(2007-11)
<input checked="" type="checkbox"/> EN 300 330-2 V1.5.1(2010-02)	<input checked="" type="checkbox"/> EN 301 489-17 V2.2.1(2012-09)
<input checked="" type="checkbox"/> EN 301 893 V1.7.1(2012-06)	<input type="checkbox"/> EN 301 489-24 V1.5.1(2010-09)
<input type="checkbox"/> EN 302 544-2 V1.1.1(2009-01)	<input type="checkbox"/> EN 302 326-2 V1.2.2(2007-06)
<input type="checkbox"/> EN 302 623 V1.1.1(2009-01)	<input type="checkbox"/> EN 302 326-3 V1.3.1(2007-09)
<input type="checkbox"/> EN 50360:2001	<input type="checkbox"/> EN 301 357-2 V1.4.1(2008-11)
<input checked="" type="checkbox"/> EN 62479:2010	<input type="checkbox"/> EN 302 291-1 V1.1.1(2005-07)
<input type="checkbox"/> EN 50385:2002	<input type="checkbox"/> EN 302 291-2 V1.1.1(2005-07)
<input type="checkbox"/> EN 62311:2008	<input checked="" type="checkbox"/> EN 50566:2013

2006/95/EC-LVD Directive

<input checked="" type="checkbox"/> EN 60950-1: 2006 / A12: 2011	<input type="checkbox"/> EN 60065:2002 / A12: 2011
<input type="checkbox"/> EN 60950-1: 2006 / A2: 2013	

2009/125/EC-ErP Directive

<input type="checkbox"/> Regulation (EC) No. 1275/2008	<input checked="" type="checkbox"/> Regulation (EC) No. 278/2009
<input type="checkbox"/> Regulation (EC) No. 642/2009	<input type="checkbox"/> Regulation (EU) No. 617/2013

2011/65/EU-RoHS Directive

Ver. 150326

CE marking



(EC conformity marking)

Position : **CEO**

Name : **Jerry Shen**

Declaration Date: 30/07/2015

Year to begin affixing CE marking: 2015

Signature : _____