

Samsung GALAXY Tab[®]4

A N D R O I D T A B L E T

User Manual

**Please read this manual before operating your
device and keep it for future reference.**



Warning! This product contains chemicals known to the State of California to cause cancer and reproductive toxicity.

Intellectual Property

All Intellectual Property, as defined below, owned by or which is otherwise the property of Samsung or its respective suppliers relating to the SAMSUNG Galaxy Tab, including but not limited to, accessories, parts, or software relating there to (the “Galaxy Tab System”), is proprietary to Samsung and protected under federal laws, state laws, and international treaty provisions. Intellectual Property includes, but is not limited to, inventions (patentable or unpatentable), patents, trade secrets, copyrights, software, computer programs, and related documentation and other works of authorship. You may not infringe or otherwise violate the rights secured by the Intellectual Property. Moreover, you agree that you will not (and will not attempt to) modify, prepare derivative works of, reverse engineer, decompile, disassemble, or otherwise attempt to create source code from the software. No title to or ownership in the Intellectual Property is transferred to you. All applicable rights of the Intellectual Property shall remain with SAMSUNG and its suppliers.

Open Source Software

Some software components of this product incorporate source code covered under GNU General Public License (GPL), GNU Lesser General Public License (LGPL), OpenSSL License, BSD License and other open source licenses. To obtain the source code covered under the open source licenses, please visit:

<http://opensource.samsung.com>.

Disclaimer of Warranties; Exclusion of Liability

EXCEPT AS SET FORTH IN THE EXPRESS WARRANTY CONTAINED ON THE WARRANTY PAGE ENCLOSED WITH THE PRODUCT, THE PURCHASER TAKES THE PRODUCT "AS IS", AND SAMSUNG MAKES NO EXPRESS OR IMPLIED WARRANTY OF ANY KIND WHATSOEVER WITH RESPECT TO THE PRODUCT, INCLUDING BUT NOT LIMITED TO THE MERCHANTABILITY OF THE PRODUCT OR ITS FITNESS FOR ANY PARTICULAR PURPOSE OR USE; THE DESIGN, CONDITION OR QUALITY OF THE PRODUCT; THE PERFORMANCE OF THE PRODUCT; THE WORKMANSHIP OF THE PRODUCT OR THE COMPONENTS CONTAINED THEREIN; OR COMPLIANCE OF THE PRODUCT WITH THE REQUIREMENTS OF ANY LAW, RULE, SPECIFICATION OR CONTRACT PERTAINING THERETO. NOTHING CONTAINED IN THE INSTRUCTION MANUAL SHALL BE CONSTRUED TO CREATE AN EXPRESS OR IMPLIED WARRANTY OF ANY KIND WHATSOEVER WITH RESPECT TO THE PRODUCT. IN ADDITION, SAMSUNG SHALL NOT BE LIABLE FOR ANY DAMAGES OF ANY KIND RESULTING FROM THE PURCHASE OR USE OF THE PRODUCT OR ARISING FROM THE BREACH OF THE EXPRESS WARRANTY, INCLUDING INCIDENTAL, SPECIAL OR CONSEQUENTIAL DAMAGES, OR LOSS OF ANTICIPATED PROFITS OR BENEFITS.

Modification of Software

SAMSUNG IS NOT LIABLE FOR PERFORMANCE ISSUES OR INCOMPATIBILITIES CAUSED BY YOUR EDITING OF REGISTRY SETTINGS, OR YOUR MODIFICATION OF OPERATING SYSTEM SOFTWARE.

USING CUSTOM OPERATING SYSTEM SOFTWARE MAY CAUSE YOUR DEVICE AND APPLICATIONS TO WORK IMPROPERLY. YOUR CARRIER MAY NOT PERMIT USERS TO DOWNLOAD CERTAIN SOFTWARE, SUCH AS CUSTOM OS.

Samsung Electronics America (SEA), Inc

Address: 85 Challenger Road
Ridgefield Park,
New Jersey
07660

Toll Free Telephone: 1-800-SAMSUNG

Internet Address: www.samsung.com

©2014 Samsung Telecommunications America, LLC. Samsung is a registered trademark of Samsung Electronics Co., Ltd.

Do you have questions about your Samsung Mobile Device?

For 24 hour information and assistance, we offer a new FAQ/ARS System (Automated Response System) at:
www.samsung.com/us/support

The actual available capacity of the internal memory is less than the specified capacity because the operating system and default applications occupy part of the memory. The available capacity may change when you upgrade the device.

The Bluetooth® word mark, figure mark (stylized “B Design”), and combination mark (Bluetooth word mark and “B Design”) are registered trademarks and are wholly owned by the Bluetooth SIG.

microSD™, microSDHC™, and the microSD logo are Trademarks of the SD Card Association.

Google, the Google logo, Android, the Android logo, Google Play, Gmail, Google Mail, Google Maps, Google Music, Google Talk, Hangouts, Picasa, YouTube and other marks are trademarks of Google Inc.

Wi-Fi is a registered trademark of the Wireless Fidelity Alliance, Inc.

Peel and the Peel logo are marks owned by Peel Technologies, Inc. and may be registered.

Table of Contents

Section 1: Getting Started4

Understanding This User Manual	4
Battery	5
Turning Your Device On and Off	7
Setting Up Your Device	7
Memory Card	8
Galaxy Tab Accessories	8
Securing Your Device	8
Holding the Device	9

Section 2: Understanding Your Device10

Features	10
Front and Sides	11
Back, Top, and Bottom	12
Home Screen	13
Navigating Your Device	15
Using the Touch Screen	16
Multi Window	19
Notifications	21
Status Bar	23
Folders	25
Wallpapers	25

Apps Screen	26
Task Manager	27
Screen Capture	27
Help	27
Entering Text	28

Section 3: Accounts and Contacts33

Accounts	33
Your Google Account	34
Your Samsung Account	34
Contacts	34
Groups	39
Favorites	40

Section 4: Messaging42

Types of Messages	42
Email	42
Gmail	45
Hangouts	46
Google+	46

Section 5: Multimedia47

Listening to Music	47
Play Music	47

Music Player	48	Google+	70
WatchON	54	Hancom Viewer	70
Section 6: Camera and Video	55	Hangouts	70
Camera	55	Help	70
Gallery	60	Internet	71
Video	62	Maps	71
YouTube	63	Memo	71
Section 7: Applications	64	Music	72
Updating Applications	64	My Files	72
GPS Applications	64	Netflix	73
Accessing Applications	65	Photos	73
Alarm	65	Play Books	74
Calculator	66	Play Games	74
Calendar	66	Play Movies & TV	74
Camera	68	Play Music	74
Chrome	68	Play Newsstand	75
Contacts	68	Play Store	75
Drive	68	S Voice	75
Dropbox	69	Samsung Apps	76
Email	69	Screen Saver	76
Gallery	69	Settings	76
Gmail	69	Video	76
Google	69	Voice Search	77
Google Settings	70	WatchON	77

World Clock	77	Lock Screen	100
YouTube	78	Wallpaper	103
Section 8: Connections	79	Font	103
Wi-Fi	79	Notification Panel	103
Bluetooth	83	Accessibility	104
Managing Downloads	88	Blocking Mode	106
Samsung Kies	90	Controls	107
Synchronizing with Windows Media Player	90	Language and Input	107
Connecting as a Mass Storage Device	90	Smart Screen	111
Section 9: Settings	91	General	111
About Settings	91	Accounts	111
Connections	92	Cloud	113
Wi-Fi	92	Backup and Reset	114
Bluetooth	92	Date and Time	115
Airplane Mode	93	Accessory	115
Data Usage	93	Application Manager	116
Location Services	94	Default Applications	118
More Networks	95	Users	118
Nearby Devices	97	Battery	120
Screen Mirroring	97	Power Saving Mode	121
Device	98	Storage	121
Sound	98	Security	123
Display	99	About Device	127
Multi Window	100	Index	129

Section 1: Getting Started

This section helps you to quickly start using your device.

Understanding This User Manual

The sections of this manual generally follow the features of your device. A robust index for features begins on page 129.

Also included is important safety information, beginning on page 128, that you should know before using your device.

This manual gives navigation instructions according to the default display settings. If you select other settings, navigation steps may be different.

Unless otherwise specified, all instructions in this manual assume that you are starting from a Home screen. To get to a Home screen, you may need to unlock the device. For more information, refer to “*Securing Your Device*” on page 8.

Note: Instructions in this manual are based on default settings and may vary from your device depending on the software version on your device and any changes to the device’s settings.

Note: Unless stated otherwise, instructions in this user manual start with the device unlocked, at the Home screen. All screen images in this manual are simulated. Actual displays may vary depending on the software version of your device and any changes to the device’s settings.

Special Text

In this manual, some text is set apart from the rest. This special text is intended to point out important information, share quick methods for activating features, define terms, and more. The definitions for these methods are as follows:



- **Note:** Presents alternative options for the current feature, menu, or sub-menu.
- **Tip:** Provides quick or innovative methods or useful shortcuts.
- **Important!:** Points out important information about the current feature that could affect performance.
- **Warning!:** Brings important information to your attention that can help to prevent loss of data or functionality or damage to your device.

Text Conventions

This manual provides condensed information about how to use your device. To make this possible, the following text conventions are used to represent often-used steps:

- Arrows are used to represent the sequence of selecting successive options in longer, or repetitive, procedures.

For example:

From a Home screen, touch  →  **Settings**
→ **Connections** tab → **Wi-Fi**.



Certain features and options use an **OFF/ON** button.



For example:

Touch the **OFF/ON** button to turn Bluetooth ON

 or OFF .

Battery

Your device is powered by a rechargeable, standard Li-Ion battery. A Wall/USB Charger (Charging Head and USB cable) are included with the device for charging the battery.

Warning! Use only approved charging devices. Approved accessories are designed to maximize battery life. Using other accessories may invalidate your warranty and may cause damage.

Battery Indicator

The Battery icon  in the Status Bar shows the battery power level. When battery power is 15% or less, your device prompts you to charge the battery. If you continue to operate the device without charging, the device powers off. For battery use information, see “About Device” on page 127.

Charging the Battery

Your device comes with a Wall/USB Charger (Charging Head and USB cable) to charge your device from any standard AC power outlet.

Note: The battery comes partially charged. You must fully charge the battery before using your device for the first time. After the first charge, you can use the device while charging.

1. Insert the USB cable into the device's Charger/Accessory Port.

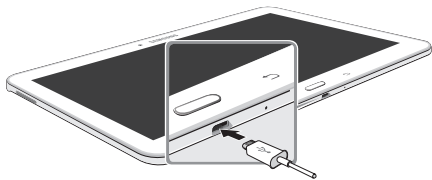

2. Insert the USB cable into the Charging Head.



3. Plug the Charging Head into a standard AC power outlet.

Warning! While the device is charging, if the touch screen does not function due to an unstable power supply, unplug the USB power adapter from the power outlet or unplug the USB cable from the device.

4. When charging is complete, unplug the Charging Head from the power outlet and remove the USB cable from the device.

Note: You cannot charge the battery using the USB cable and your PC.

Note: If the battery is completely discharged, you cannot turn on the device, even with the USB power adapter connected. Allow a depleted battery to charge for a few minutes before you try to turn on the device.

Turning Your Device On and Off

Turning Your Device On

- Press and hold the **Power/Lock Key**.

For more information, refer to “Unlocking the Device” on page 9.

Turning Your Device Off

1. Press and hold the **Power/Lock Key**.
2. On the *Device options* menu, touch **Power off** → **OK**.

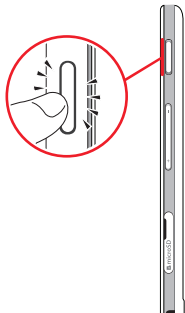

Setting Up Your Device

The first time you turn your device on, the Setup Wizard will guide you through the basics of setting up your device.

Follow the prompts to choose a default language, set up accounts, choose location services, and learn more about your device.

Touch **Skip** to skip some screens, or touch **Back** to redisplay them.

Note: If your screen dims or turns off, press the **Power/Lock Key** to continue.

Memory Card

Your device supports removable microSD or microSDHC memory cards with maximum capacities of 64 GB (depending on the memory card manufacturer and type). Memory cards are used to store music, photos, videos, and other files.

Installing a Memory Card

1. Open the memory card slot cover and turn to expose the slot.
2. With the gold contacts facing down, carefully slide the memory card into the slot, pushing gently until it clicks into place.

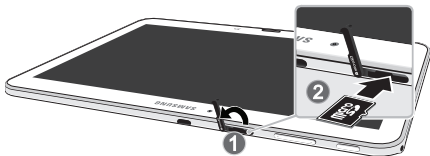

3. Close the memory card slot cover.

Galaxy Tab Accessories

To find accessories for your Galaxy Tab:

1. Go to samsung.com/us/mobile/galaxy-tab-accessories.
2. Use your model number to find compatible accessories.

Securing Your Device

By default, the device locks automatically when the screen times out or you can lock it manually.

Unlock the tablet by swiping your finger across the screen. This is the default Screen lock (Swipe), and offers no security.

Prevent others from using or accessing personal data and information stored in the device by using a secure Screen Lock.

For more information about creating and enabling a secure Screen Lock, see *“Lock Screen”* on page 100.

For other settings related to securing your device, see *“Security”* on page 123.

Locking the Device Manually

- Press the **Power/Lock Key**.

Unlocking the Device

1. Press the **Power/Lock Key**. The Lock screen displays.
2. Swipe across the screen as shown. This is the default Swipe screen lock and offers no security.



Holding the Device

Your device's internal antenna is located along the top back of the device. Do not block the antenna; doing so may affect signal quality and may cause the device to operate at a higher power level than is necessary.

Section 2: Understanding Your Device

This section outlines key features of your device and describes the screen and the icons that appear when the device is in use. It also shows how to navigate through the device.

Features

- 10.1-inch WXGA (1280x800) TFT (PLS) LCD touch screen
- Android Version: Kit Kat 4.4
- 1.2 GHz quad-core processors
- Full HTML Web Browser
- Bluetooth 4.0 Wireless technology. For more information, refer to “*Bluetooth*” on page 83.
- Built-in Wi-Fi technology (802.11 a/b/g/n)
- 3.2 megapixel camera and camcorder, plus 1.2 megapixel full HD forward-facing camera for video chat
- Full integration of Google applications (Gmail, Google Now, Google Settings, Google Maps, YouTube, and Voice Search)
- Photo gallery
- Messaging Features:
 - Gmail
 - Email (corporate and personal)
 - Google Hangouts (Instant Messaging and Video Chat)
- HD Video Player (1080p) that supports MP4, 3GP, WMV, ASF, AVI, FLV, MKV, and WEBM
- Music player that supports MP3, M4A, 3GA, AAC, OGG, WAV, WMA, and FLAC
- Support for microSHD and microSDHC memory cards
- Preloaded applications such as Google Play Books, Google Play Games, Google Play Movies & TV, Google Play Music, Google Play Newsstand, Play Store, and more.

Warning! This device does not support some USB storage media devices. For more information, refer to “*Galaxy Tab Accessories*” on page 8.

Front and Sides

The following items can be found on the front and sides of your device.

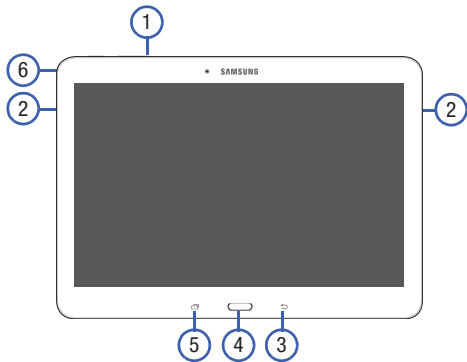

1. **Front-Facing Camera Lens:** Takes photos or records videos.
2. **Speaker:** Plays music, notification tones, and audio.
3. **Back Key:** Return to the previous screen or option.
4. **Home Key:** Display the central Home Screen.
5. **Recent Key:** Touch and hold to display recently used apps.
6. **3.5mm Headset Jack:** Plug in for headphones.

Back, Top, and Bottom

The following items can be found on the back, top, and bottom of your device.

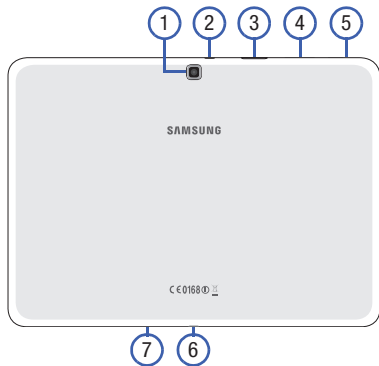

1. **Camera:** Takes photos or recording videos.
2. **Infrared Blaster:** Controls other devices.
3. **Memory Card Slot:** Install a memory card for storage of files (not included).
4. **Volume Key:** From a Home Screen, press to adjust master volume. During music playback, press to adjust volume.
5. **Power/Lock Key:** Press and hold to turn the device on or off. Press to lock the device or to wake the screen for unlocking.
6. **Charger/Accessory Port:** Plug in a USB cable for charging or to sync music and files.
7. **Microphone:** Records audio.

Home Screen

The Home screen is the starting point for using your device. It consists of:

- **Status Bar:** The Status Bar displays notifications on the left side and status indicators on the right side.
Note: The Status Bar is sometimes hidden. To display it, touch and drag the top of the screen down. It will disappear after a view seconds.
- **Notifications:** Notification icons appear on the Status Bar at the top of the screen to report calendar events, device status, and more. Drag down from the Status Bar to open the Notification Panel.
- **Widgets:** Applications that run on the Home screen. Some widgets are found on the Home screen by default.
- **Refresh Content:** Touch to refresh the content of the Home Screen App.
- **Status indicators:** Display your current network status, battery charge, and time.
- **Google Search:** Search the web by typing or speaking. For more information, refer to “Google” on page 69.

- **Current Screen:** Shows which Home screen is presently displayed.
- **App Shortcuts:** Touch to launch your favorite apps.
- **App Screen:** Access to all your apps and widgets.

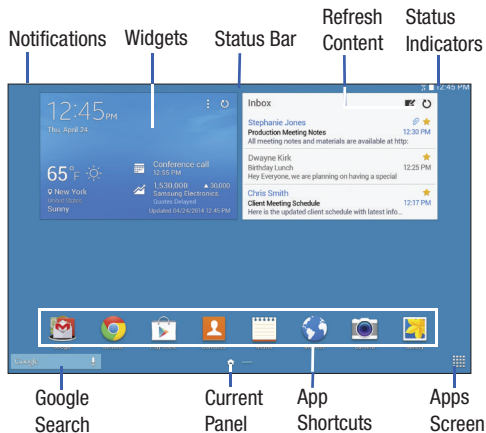

Extended Home Screen



The Home screen consists of the Home panel, plus panels that extend beyond the display width to provide more space for adding shortcuts, widgets and folders.

Slide your finger horizontally across the screen to scroll to the left or right side panels. As you scroll, the indicator at the bottom of the display shows your current position.

Home Screen Panels

You can customize the Home screen to include up to seven panels.

- From a Home screen, pinch the screen from diagonal corners to the center to display the editing screen.

Set this panel as the main Home screen (the panel with  will display when you press the  Home Key)

Touch and hold a panel, and then drag it here to delete it



Touch and hold a panel, and then drag it to a different location

Add a new panel (up to a total of seven)

Navigating Your Device

Use command keys and the touch screen to navigate.

Command Keys

Recent Apps

To display a list of recently used apps:

- Touch  **Recent apps**. Touch an app to open it.

To close an app:

- Drag the app preview up or down.

To end all running apps:

- Touch  **Close all**.

To manage running apps, downloads, device memory, and storage:

- Touch  **Recent apps** →  **Task Manager**.

For more information, refer to “*Task Manager*” on page 27.

Home

To display the main Home screen:

- Touch  **Home**.

To launch Google Now:

- Touch and hold  **Home**.

Back

To return to the previous screen, option, or step:

- Touch  **Back**.

Using the Touch Screen

Use only your fingers or a stylus with the touch screen.

Caution! Do not allow the touch screen to come into contact with other electrical devices. Electrostatic discharges can cause the touch screen to malfunction.

To avoid damaging the touch screen, do not touch it with anything sharp or apply excessive pressure to it with your fingertips.

Leaving the touch screen idle for extended periods may result in afterimages (screen burn-in) or ghosting. Turn off the touch screen when you do not use the device.

Finger Gestures

Touching

To open an application, to select a menu item, to press an onscreen button, or to enter a character using the onscreen keyboard, touch it with a finger.

Touching and Holding

Touch and hold an item for more than 2 seconds to access available options.

Dragging

To move an icon, thumbnail, or preview to a new location, touch and hold it and drag it to the target position.

Double-Tapping

Double-tap on a web page, map, or image to zoom in a part. Double-tap again to zoom out again.

Swipe

Swipe left or right on the Home screen or the Applications screen to see another panel. Swipe up or down to scroll through a web page or a list, such as contacts.

Pinching and Spreading

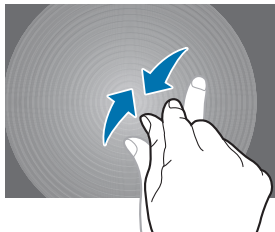

Spread two fingers apart on a web page, map, or image to zoom in. Pinch to zoom out.



Control Motions

Simple motions allow easy control of the device.

Before using motions, make sure the motion feature is activated.

1. From a Home screen, touch  →  **Settings** → **Controls** tab → **Palm Motion**.
2. Touch  to turn the feature ON.

Note: Excessive shaking or impact to the device may result in unintended inputs. Control motions properly.

Rotating the Screen

Many applications allow display in either portrait or landscape orientation. Rotating the device causes the display to automatically adjust to fit the new screen orientation.

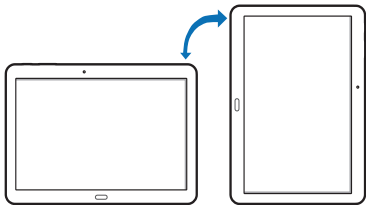

To prevent the display from rotating automatically, open the Notification Panel and deselect **Screen rotation**.

Note: Some applications do not allow screen rotation. Some applications display a different screen depending on the orientation. For example, the calculator turns into a scientific calculator when rotated to landscape.

Tilting

Touch and hold two points on the screen, and then tilt the device back and forth to zoom in or out.

Note: To move an icon to a new location, touch and hold it and drag it to the target position. For more information, refer to “*Dragging*” on page 16.

Panning to Browse

When an image is zoomed in, touch and hold a point on the screen, and then move the device in any direction to browse the image.

Sweeping

Sweep your hand across the screen to capture a screenshot. The image is saved in  **Gallery** → **Screenshots** album.

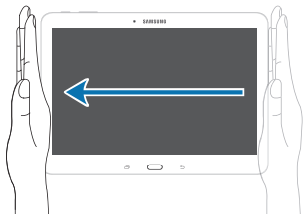

Covering

Cover the screen with a palm to pause media playback.

Capturing Screenshots

- Press and hold the **Power/Lock Key** and  **Home** to capture and save an image of the current screen.

Note: A copy of the screenshot is automatically saved to the clipboard.

To view the screen shots:



1. From a Home screen, touch  →  **My Files**.
2. Touch **Categories** → **Images**.
3. Touch a screen capture file to display it.

Multi Window

Multi task by using two applications at the same time.

Note: Only applications displayed on the Multi window panel can be used with the Multi window feature.

Activate Multi Window

1. From a Home screen, touch  →  **Settings** → **Device** tab.
2. Touch **Multi window**.
3. If necessary, touch  to turn Multi window ON.
4. If desired, touch **Open in multi window view** to automatically view content in Multi window when you open files from My Files or Video player, or attachments from email.

Note: You can also activate Multi window from the Notification Panel. For more information, refer to “*Notification Panel*” on page 21.



Multi Window Panel

Multi window apps are displayed on the Multi window panel.

Display the Multi window panel:

1. Activate Multi window (see “*Activate Multi Window*” on page 19).
2. Swipe the right edge of the screen toward the center to display the Multi window panel. After a few seconds, the panel will be hidden again.

Using Multi Window Applications

You can use Multi window to run two applications at the same time.

1. With Multi window activated, swipe the right edge of the screen toward the center to display the Multi window panel.
2. Drag an app off the panel and release. Drag another app off of the panel and release it into one of the highlighted windows.

Window Controls

Select an application window and touch  in the middle of the windows. Window controls appear:



Switch Multi window applications.



Share items between the application windows. Drag an item to share from one window to another. Some applications may not support this feature.



Maximize the application.





Close the application.

Panel Configuration

You can rearrange the apps on the Multi window panel, add new apps, or remove apps.

On the Multi window panel:

1. Touch  to access the panel controls.
2. Touch  **Edit**.

Configuring Apps

To remove an app from the panel:

- Touch and drag it off of the panel and place it in the storage area.

To add an app to the panel:

- Touch and drag it from the storage area to the panel.



To relocate an app:

- Touch and drag it to a new location.

To save your changes:

- Touch **Done**.

To download new Multi window apps:



- From a Home screen, touch  →  **Play Store**.

Notifications

Notification icons appear on the Status Bar at the top of the screen to report calendar events, device status, and more. For details about these notifications, open the Notification Panel.

Notification Panel



To view the Notification Panel:

1. Swipe downward from the top of the screen to display the Status Bar.
2. Swipe downward again on the Status Bar to display the Notification Panel.
3. Scroll down the list to see additional notification details.
4. Touch an item to open it.
5. To clear a single notification, drag the notification left or right. Touch  to clear all notifications.
6. To close the Notification Panel, swipe upward from the bottom of the screen or touch  **Back**.

Accessing Additional Panel Functions





In addition to notifications, the Notification Panel also provides quick and ready access to separate device functions. These can be quickly activated or deactivated by toggling them on or off. You can choose the functions that display.

From the Notification Panel:

1. To go to Settings, touch  **Settings**. For more information, refer to “Settings” on page 91.
2. Touch  to display additional options.
The following functions can either be activated (green) or deactivated (gray): Wi-Fi, GPS, Sound/Mute, Screen rotation, Bluetooth, Reading mode, Blocking mode, Power saving, Multi window, Screen Mirroring, Smart stay, Smart pause, Sync, and Airplane mode.
3. Touch  and locate the Notification Panel area at the bottom of the Notification Panel screen.
 - In a single motion, touch and hold a desired function, such as Airplane mode, then drag it to the top two rows.

- Touch **Brightness and volume** to create a check mark if you want to be able to adjust the screen brightness and volume from the Notification Panel.

- Touch  **Back** to exit the Notification Panel.

4. Touch  to display only your primary functions.
5. To set the display brightness, touch the  **Brightness** slider and drag it to set the brightness or touch **Auto** to allow the device to set brightness automatically based on available light and battery charge status. For more information, refer to “Display” on page 99.
6. To adjust the system volume, touch the  **Sound** slider and drag it to set the Notification sound level or touch  to set the level for Notifications, Media, and System sounds. For more information, refer to “Sound” on page 98.

To displays notifications

- Touch a notification entry to display the details. Touch  to remove Notification Icons from the Status Bar.

To close the Notification Panel:

- Touch  **Back**, or swipe up.

Status Bar

The Status Bar at the top of the home screen provides device information (such as network status, battery charge, and time) on the right side and notification alerts on the left.





To display the Status Bar:

- From a Home screen, swipe downward from the top of the screen. The grey Status Bar will appear. It will disappear after a few seconds.

Status Bar Icons

Some common status and notification icons are shown below.

Connectivity Icons

-  Wi-Fi connected
-  Bluetooth enabled
-  Bluetooth paired
-  Connected to computer



Wi-Fi Direct is active and your tablet is connected to another device.



The Nearby devices setting is enabled.

Device Status Icons



Battery full



Battery charging



Battery low



GPS enabled



Mute mode enabled



Error occurred or caution required

Messaging Icons



New email



New Gmail

Other Icons



Alarm activated



Airplane mode activated



Blocking mode activated



Music is playing.

Apps and Widgets

You can add, reposition, or remove shortcuts and widgets from the Home screen.

- **Shortcuts:** Icons on the Home screen that launch applications.
- **Widgets:** Self-contained applications. They appear as onscreen applications.

Adding a Shortcut or Widget

You can customize the Home screen by adding shortcuts and widgets.

1. From a Home screen, touch and hold on an empty area of the screen until the Home screen pop-up displays. Touch Apps and Widgets.
– or –
Touch  to display the Apps screen.
2. For shortcuts, touch the **Apps** tab. For widgets, touch the **Widgets** tab.
3. Touch and hold the shortcut or widget, and then drag it to the Home screen and release.

Removing a Shortcut or Widget

Shortcuts and widgets can be removed from the Home screen.

- Touch and hold the shortcut or widget until it detaches, and then drag it to  **Remove** and release.

Note: Removing a shortcut does not delete the application; it simply removes the shortcut from the Home screen.

Folders

Place folders on the Home screen to organize items.

Adding Folders

1. From a Home screen, touch and hold on an empty area of the screen until the *Home screen pop-up* appears.
2. Touch **Folder**.
3. Enter a name for the folder and touch **OK**.

Using Folders

- Touch the folder to open it and access the shortcuts inside.
- To add shortcuts to the folder, touch and hold the shortcut, and then drag it to the folder and release.
- To delete a folder, touch and hold the folder until it detaches, and then drag it to  **Remove** and release.

Note: All shortcuts contained in the folder will also be deleted.

Wallpapers

You can choose a picture to display on the Home Screen, Lock screen, or on both the Home and Lock screens. Choose from preloaded wallpapers, or select a photo you have downloaded or taken with the Camera.

1. From a Home screen, touch and hold on an empty area of the screen until the Home screen pop-up displays.
2. Touch **Home Screen, Lock screen, or Home and lock screens** for options:
 - **Gallery:** Access the Gallery to select a photo.
 - **Live wallpapers:** Choose from pre-loaded interactive animated wallpapers (Home screen only).
 - **Photos:** Access Google Photos to select a photo (Home screen only).
 - **Wallpapers:** Choose from pre-loaded wallpaper images.



Note: You can also set the wallpaper in Settings. From a Home screen, touch  →  **Settings** → **Device** tab → **Wallpaper**.

Apps Screen



The **Apps** screen displays all applications installed on your tablet. Applications that you download and install from Google Play or from the web are also added to a Home screen.

The Apps icons can be arranged in various ways.

To change the arrangement of the Apps icons:

1. From a Home screen, touch .
2. Touch  **Menu** → **View type**.
3. Touch **Customizable grid** or **Alphabetical grid**.

To manually change the order of the icons on the Apps screen:

1. From a Home screen, touch .
2. Touch  **Menu** → **Edit**.
3. Touch and hold an icon and drag it to a new position.
4. Touch **Save** to save the changes.

You can place shortcuts to applications on the Home screen for quick access to the application. For more information, refer to “*Adding a Shortcut or Widget*” on page 24.

To view your downloaded applications:



1. From a Home screen, touch .
2. Touch  **Download** to view downloaded apps.
3. Touch an icon on the **Downloaded applications** screen to launch the application.

– or –

Add an app shortcut to a Home screen by dragging the app icon onto the Home screen. For more information, refer to “*Adding a Shortcut or Widget*” on page 24.

Application Information

To view information about an App, such as the amount of storage it uses, force the App to stop, uninstall updates, and clear data:



1. From a Home screen, touch  →  **Settings** → **General tab** → **Application manager**.
2. Touch the **All** tab, scroll through the apps list, and touch the app to open a screen with details about the App.

Task Manager

Your device can run applications simultaneously and some applications run in the background.

Use Task Manager to see which applications are running on your device and to end running applications to extend battery life. You can also uninstall applications from your device and see how much memory is used by applications.

To access the Task Manager:



1. Touch  **Recent apps** →  **Task manager**.
2. Touch each tab for options:
3. **Active applications:** View applications running on your device. Touch **End** to terminate an application or **End all** to terminate all running applications.
4. **Downloaded:** View applications installed from Google Play. Touch **Uninstall** to remove an application from your device.
5. **RAM manager:** Display the amount of Random Access Memory (RAM) currently in use. Touch **Clear memory** to clear inactive and background processes.
6. **Storage:** View internal (System storage) and external (SD card) storage memory statistics.

Screen Capture

- Press and hold the **Power/Lock Key** and  **Home** to capture and save an image of the current screen.



Note: A copy of the screenshot is automatically saved to the clipboard.

To view the screen shots:

1. From a Home screen, touch  →  **Gallery**.
2. Touch to open the **Screenshots** album.
3. Touch a screen capture to view it.

Help

Access help information to learn how to use the device and applications or configure important settings.

1. From a Home screen, touch  →  **Help**.
2. Select a category to view tips.

Entering Text

Use the Samsung keyboard or the voice input feature to enter text.

Note: Text entry is not supported in some languages. To enter text, you must change the input language to one of the supported languages.

Choose a Text Input Method



Your device offers two text input methods:

- **Samsung keyboard** allows you to enter text by touching keys on a virtual QWERTY keyboard. Samsung keyboard includes optional predictive text, which matches your key touches to common words so you can select a word to insert it into your text.
- **Google voice typing** allows you to speak your entries.

Select a Default Text Input Method

You can select a default Text Input Method from Settings, or choose one at any time while entering text.

From Settings

1. From the Home screen, touch  **Apps** →  **Settings** → **Controls** tab → **Language and input**.
2. Touch **Default** to select a text entry method.

While Entering Text

1. From a screen where you can enter text, drag down from the top of the screen to open the Notifications panel.
2. Tap **Select input method**, and then choose a text entry method.

Using Samsung Keyboard

The Samsung keyboard is a custom virtual QWERTY keyboard, featuring optional predictive text. Input characters by tapping the onscreen keys with your finger, or use speech recognition.

You can enable predictive text, to have the Samsung keyboard match your key touches to common words and displays them. Select a word from the display to insert it into your text.





Entering Upper and Lower Case Letters

The default case is lower case (abc). To enter upper and lower case letters, touch  **Shift**, then the letter key(s).

- Touch once to switch from abc to Abc mode.
- Touch twice quickly to switch to ABC mode. Touch again to return to lower case mode.

Entering Common Symbols

- To enter common symbols, touch  to switch to symbol mode, then touch the corresponding key.
- Touch  to display additional symbols.
- Touch  to return to letter keys.

Using Google Voice Typing from the Samsung Keyboard

When enabled as an input method, you can switch to Google voice typing from the Samsung keyboard.



- Touch , and then speak your input.

Using Predictive Text



When using Predictive text, you can have next-letter prediction and regional error correction, which compensates for pressing the wrong keys on the QWERTY keyboard.

- While entering characters, potential word matches display in the Predictive text area above the keyboard. Touch a word to insert it into your text.

Handwriting

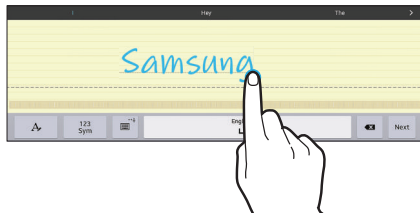

Touch and hold  **Options** →  **Handwriting**, and then write a word with a finger. As you write, suggestions are offered in the word options area in case the correct letters were not recognized. Touch to select a suggested word.





Use handwriting gestures to perform actions, such as editing or deleting characters and inserting spaces. To view the gesture guides, touch and hold  **Options**, and then touch  **Settings** → **Help** → **Keyboard** → **Using handwriting gestures**.

Configure Samsung Keyboard

Configure the Samsung keyboard to your preferences.

- For more information, see “*Configuring the Samsung Keyboard*” on page 107.
- While entering text, touch and hold , then select  from the pop-up menu.

Changing the Keyboard Layout

Touch and hold  **Options**, and then touch  to change the keyboard layout. Options are Normal, Floating, and Split.

Using Google Voice Typing

Use your voice to enter text using the Google Voice typing feature.

1. While entering text, touch and drag downward from the top of the screen to display Notifications, then touch **Select input method → Google voice typing**.

– or –

While using the Samsung keyboard, touch .

2. At the **Speak now** prompt, speak your text. As you speak, the text displays in the text field.
3. To return to using the Samsung keyboard, touch anywhere in the text field.

Note: For more information on configuring Google voice typing, see “*Google Voice Typing*” on page 109.

Editing Text

Use the text selection tools to select text or position a cursor for inserting text, then use the editing tools to select, cut, copy, and paste text.

Note: Some applications do not support editing, or may offer other ways to select and modify text.

Inserting New Text

- Touch the text to display the  **Insertion cursor** (touch and drag the cursor into position in the text if needed).



Selecting Text

- Touch and hold on the text you want to select to display the  **Selection cursors**, then touch and drag the cursors to highlight the text you want to select.

– or –

Touch and hold on text, then touch  **Select** from the pop-up text editing menu.

Copying or Cutting Text

1. Touch and hold on the text you want to select to display the  **Selection cursors**, then touch and drag the cursors to highlight the text you want to cut or copy. Touch  **Cut** or  **Copy** from the pop-up text editing menu.

Pasting Copied or Cut Text

1. Touch in a text entry field to display the  **Insertion cursor** (touch and drag the cursor into position in the text, if needed).
2. On the pop-up text editing menu, touch **Paste** to paste the last copied item, or **Clipboard** to choose other copied items.

Section 3: Accounts and Contacts

This section explains how to manage accounts and contacts.



Accounts

Your device can synchronize with a variety of accounts. With synchronization, information on your device is updated with any information that changes in your accounts.

- **Samsung Account:** Add your Samsung Account.
- **Dropbox:** Add your Dropbox Account.
- **Email:** Add an Email Account to sync Contacts.
- **Google:** Add your Google Account to sync your Contacts, Calendar, and Gmail.
- **LDAP:** Add an LDAP Account to find entries in an LDAP directory.
- **Microsoft Exchange ActiveSync:** Add your Exchange Account to sync Contacts, Calendar, and Email.
- **Facebook:** Add a Facebook Account to sync apps.
- **Twitter:** Add a Twitter Account.

Setting Up Accounts



Set up and manage your synchronized accounts with the **Accounts** setting.

1. From a Home screen, touch  →  **Settings** → **General** tab → **Accounts** → **Add account**.
2. Touch the account type.
3. Follow the prompts to enter your account credentials to complete the set up process.

Your tablet communicates with the appropriate account servers to set up your account. When complete, your account displays in the **Accounts** area of the Settings screen.



Your Google Account

In order to utilize your device to the fullest extent, you will need to create a Google Account when you first use your device. With a Google Account, Google applications will always be in sync between your tablet and computer.

1. From a Home screen, touch  →  **Settings** → **General** tab → **Accounts** → **Add account** → **Google**.
2. Follow the prompts to sign into your existing account or create a new account.

Your Samsung Account



Create a Samsung Account for access to Samsung apps and services, and much more.

1. From a Home screen, touch  →  **Settings** → **General** tab → **Accounts** → **Add account** → **Samsung account**.
2. Follow the prompts to sign into your existing account or create a new account.





Contacts

Use this application to manage contact information for your friends, family, and colleagues, including phone numbers, email addresses, and others.

To access Contacts:

- From a Home screen, touch  →  **Contacts**.

Add a Contact



1. Touch  **Contacts** →  **Create**. The Save contact to pop-up displays.
2. To choose where the contact is stored, touch **Phone** or an account.
– or –
Touch **Add new account** to add a different account. For more information, refer to “*Setting Up Accounts*” on page 33.
3. Touch each field to enter information. Touch  to add another entry, or  to remove an entry. Touch  to choose a label.
 - **Picture:** Touch the picture icon to assign a picture to the new contact.

- **Name:** Enter the name. Touch  to display additional name fields.
- **Phone:** Enter a phone number.
- **Email:** Enter an email address.
- **Groups:** Assign the contact to a group. For more information, refer to “Groups” on page 39.
- **Add another field:** Add additional fields for the contact.



4. Touch **Save**.

Note: Your personal Contact entry is always listed at the top of the Contacts list under ME. Touch **Set up profile** to add your contact information.

Updating Contacts



1. Touch  **Contacts**.
2. Touch a contact in the Contacts list to view its information.
3. Touch  **Edit**.
4. Touch any field to edit. For more information, refer to “Add a Contact” on page 34.

Deleting Contacts

1. Touch  **Contacts**.
2. Touch a contact in the Contacts list to display it.
3. Touch  **Delete**.
4. At the prompt, touch **OK**.

Contacts Display Options

There are various ways to display your contacts.



1. Touch  **Contacts**.
2. Touch the **Groups** tab, **Favorites** tab, or **Contacts** tab to view contacts in various ways:
 - **Groups:** Display contacts sorted into groups—such as Not assigned, Co-workers, Family, Friends, etc. The number of contacts in each group is displayed next to the group name. Touch a group name to show only contacts in that group. For more information, refer to “*Create a New Group*” on page 39.
 - **Favorites:** Show only your favorite (or starred), contacts. For more information, refer to “*Favorites*” on page 40.
 - **Contacts:** Show all your contacts. Touch the **Search** field and enter a keyword to list contacts that contain that keyword.
3. While viewing **Groups**, **Favorites**, or **Contacts**, touch  **Menu** for options.
4. While viewing the **Contacts** tab, touch  **Menu** → **Settings** for Contact settings.

Linked Contacts



Your device can synchronize with multiple accounts, including Google, Corporate Exchange, and other email providers. When you synchronize contacts from these accounts with your device, you may have multiple contacts for the same person.

Linking, or joining, imported contact records allows you to see all of a contact’s numbers and addresses together in a single contact entry. Linking also helps you keep your contacts updated, because any changes that your contacts make to their information in the respective accounts are automatically updated the next time you synchronize with that account.

Linking Contacts

1. Touch  **Contacts**.
2. Touch a contact in the *Contacts list* to display it.
3. Touch  **Menu** → **Link contact**.
4. Touch the contact you want to link. The linked contact’s information is displayed with the original contact’s information.
5. Repeat Steps 3 and 4 to link other contacts.

Separating Contacts

1. Touch  **Contacts**.
2. Touch a contact in the *Contacts list* to display it.
3. Touch  **Menu** → **Separate contact**. A list of linked contacts is displayed.
4. Touch  to separate a linked contact.

My Personal Contact



Your own personal Contact entry is listed under ME at the top of the Contacts list. You can send your personal Contact entry as a vCard via Bluetooth or as a message attachment.

Creating Your Personal Contact Entry

1. Touch  **Contacts**.
2. Touch **Set up profile**, then enter your information in the Contact fields. For more information, see “*Add a Contact*” on page 34.

Sharing Your Personal Contact Entry



You can send your personal Contact entry as a vCard via Bluetooth to other Bluetooth devices, or as a message attachment.

1. Touch  **Contacts**.
2. Touch your personal Contact entry to display your Contact information.
3. Touch  **Menu** → **Share namecard via**.
4. Choose a sending method, then follow the prompts to send the profile.

Sharing Contact Information



You can send a contact's information using Bluetooth to other Bluetooth devices, or in an Email or Gmail as an attachment.

Note: Not all Bluetooth devices accept contacts and not all devices support transfers of multiple contacts. Check the target device's documentation.

1. Touch  **Contacts**.
2. Touch  **Menu** → **Share namecard via**.
3. Touch **Selected contact** to share only the displayed contact, or touch **Multiple contacts**.
4. Touch a sending method, such as Bluetooth or email.
5. Follow the prompts to send the contact information.

Importing and Exporting Contacts

To back up and restore your contacts, you can export your contacts list to a storage device (such as a PC), or import your contacts list from a storage device.



1. Use the USB cable to connect your device to the storage device.
2. Touch  **Contacts**.
3. Touch  **Menu** → **Settings** → **Import/Export**.
4. Touch an option and then follow the prompts.

Groups

Assign contacts to Groups, such as co-workers, family, or friends, to make searching for contacts faster or to quickly send an email to group members.

Create a New Group

Create a new group when you add or edit a contact.



1. Touch  **Contacts** → **Groups** tab.
2. Touch  **Create**.
3. Touch the **Group name** field and enter a name.
4. Touch **Add member**, touch individual contacts or touch **Select all**, and then touch **Done** to add the selected contacts to the group.
5. Touch **Save**.

Tip: Contacts can belong to more than one group. While editing a contact, touch the **Groups** field to add additional groups.



Once you create a new group, the Contacts list can be set to display only the contacts in that group. For more information, refer to “*Contacts Display Options*” on page 36.

Adding Group Members



To add a contact to a group, just edit a contact’s Group field. For more information, refer to “*Updating Contacts*” on page 35.

1. Touch  **Contacts** → **Groups** tab.
2. Touch the group to which you want to add members.
3. Touch  **Menu** → **Add member**.
The contacts that can be added display.
4. Touch **Select all** or the name of each contact to add.
5. Touch **Done** to add the contacts to the group.



Removing Group Members

1. Touch  **Contacts** → **Groups** tab.
2. Touch the group from which you want to remove members.
3. Touch  **Menu** → **Remove member**.
4. Touch **Select all** or the name of each contact to remove.
5. Touch **Done** to remove the contacts. Contacts are removed from the group and the group name is removed from each contact’s **Group** field.

Renaming a Group

1. Touch  **Contacts** → **Groups** tab.
2. Touch the group you want to rename.
3. Touch  **Menu** → **Edit group**.
4. Touch the **Group name** field and enter a new name.
5. Touch **Save**.



Deleting Groups

1. Touch  **Contacts** → **Groups** tab →  **Menu** → **Delete groups**.
2. Touch individual groups or touch **Select all**, then touch **Done**.
3. Touch **Group only** to delete only the group or **Group and group members** to delete both the group and the group's members.

Favorites

Mark contact records with a  gold star to identify them as favorites.

Mark a Contact as a Favorite



1. Touch  **Contacts**.
2. Touch a contact in the Contacts list to display it.
3. Touch the  **Star** so that it turns gold .

Tip: You do not have to edit the contact to mark it as a favorite.

View Favorites

1. Touch  **Contacts**.
2. Touch the **Favorites** tab. Only your starred contacts are displayed.
– or –
Touch the **Groups** tab, then touch **Starred in Android** to list only your starred contacts that are being saved to your Google Account.

Remove Favorites

1. Touch  **Contacts** → **Favorites** tab.
2. Touch  **Menu** → **Remove from Favorites**.
3. Touch individual contacts or touch **Select all**, then touch **Done** to remove.

Note: To remove the currently displayed contact from your favorites list, touch the  **Star** next to the contact's name so that it is no longer gold .

Section 4: Messaging

This section describes how to send and receive messages and other features associated with messaging.

Types of Messages



Your device supports these types of messages:

- Email
- Gmail
- Hangouts
- Google+

Note: Your Wi-Fi-only device does NOT support voice calling and messaging services. Please disregard any “dial” and “message” related menus because some Gmail options are identically set in all Android devices.



Email

Use Email to view and manage all your email accounts in one application.

- From a Home screen, touch  →  **Email**.

Configuring Email Accounts





You can configure Email for most accounts in just a few steps.



1. Touch  **Email**.
2. The first time you set up an email account, at the Set up email screen, enter an **Email address** and **Password**, then touch **Next**.
– or –
For additional accounts, touch  **Menu** → **Settings** → **Add account**.
3. Follow the onscreen instructions to set up your email account.
4. Touch **Next** to go to the next screen or touch **Previous** to go to the Apps screen.

5. Enter an account name and your name, if required.
6. Touch **Done**. The device communicates with the appropriate server to set up your account and synchronize your email. When complete, your email appears in the Inbox for the account.



Note: To configure email account settings at any time, use  **Menu** → **Settings**. Touch the account to display Account settings.

Composing and Sending Email



1. Touch  **Email**.
2. If you have multiple accounts set up, choose an account from the menu at the top of the screen.
3. Touch  **Compose**, then touch fields to enter recipients and the email text.
4. While composing a message:
 - Touch  **Menu** to display options: Schedule sending, Priority, Tracking options, and Security options.
 - Touch  **Attach** to add a file to the message.

5. Touch the body of the email to enter the text of your email. Touch the text option buttons to edit and format your message text.
6. Touch  **Send** to send the message.
 - or –
 - Touch  **Save** to save the email to the Drafts folder.
 - or –
 - Touch  **Discard** to discard the email.

Replying to an Email





1. Touch  **Email**.
2. Open an email that you have received.
3. Touch  **Reply** to reply to the sender of the email.

Forwarding an Email

1. Touch  **Email**.
2. Open an email that you have received.
3. Touch  **Forward** to forward the email to another contact.

Managing Your Email Accounts

If you add more than one email account, you can view email you receive for all accounts in the **Combined view** screen or you can view email accounts individually.

1. Touch  **Email**.
2. Touch the  drop-down menu at the top left of the screen to select:
 - **Combined view**: View all email in a combined inbox.
 - **<Account Name>**: View email for the account.
3. Touch  **Split view** to display email in three columns. Touch  to return to a two column view.

Refreshing Your Email Account

Refresh your account to update your device from your email servers.

1. Touch  **Email**.
2. In the Application Bar, touch  **Refresh**.

Deleting Email Accounts



To delete an Email account:

1. Touch  **Email**.
2. Touch  **Menu** → **Settings** → **Delete account**.

Email Settings

Use the Email Settings to configure your Email preferences.

Note: Available settings depend on the email provider.

1. Touch  **Email**.
2. Touch  **Menu** → **Settings**, then touch **General settings**. The following options display:
 - **Display**: Set how email is shown in the email list and when you open them.
 - **Composing and sending**: Set what functions are available while composing and sending email.
 - **Auto advance**: Set the screen to show after deleting a message. Choices are: Next email, Previous email, or Email list.
 - **Confirm deletions**: Ask for confirmation before deleting email.

- **Priority senders:** Enter email addresses that you want treated as a priority.
- **Spam addresses:** Manage your spam address list.
- **Rules for filtering:** Create rules for filtering email based on names, address, or subject.

3. Touch an account to configure specific settings. Available options depend on the account.

Gmail



Send and receive email with Gmail, Google's web-based email service.

- From a Home screen, touch  →  **Gmail**.





Setting Up Your Gmail Account

If you did not set up a Google Account during the initial configuration, the first time you launch Gmail, your device prompts you to set up your Google Account.

1. Touch  **Gmail**.
2. Follow the prompts to sign in or create a new account. The device communicates with the Google server to set up your account and synchronize your email. When complete, your Gmail displays in the Inbox.

Note: You can use more than one Google Account on your device. From a Home screen, touch  →  **Settings** → **General** tab → **Accounts** → **Add account** to add an additional Google Account.

Composing and Sending Gmail

1. Touch  **Gmail**.
2. Touch  **Compose**, then touch fields to compose the message. While composing a message, touch  **Menu** for options.
3. Touch  **SEND** to send this message.
– or –
Touch  **Menu** → **Save draft** to save a draft of this message.

Refreshing Your Gmail Account

Refresh your account to update your device from the Gmail servers.

1. Touch  **Gmail**.
2. While viewing your Inbox, drag your finger downward across your messages.

Gmail Settings

Use the Gmail Settings to configure your Gmail preferences.



1. Touch  **Gmail**.
2. Touch  **Menu** → **Settings** for settings.

Hangouts

Previously known as Google Talk, Hangouts is an online place to meet friends and family, share photos, and host video calls. Conversation logs are automatically saved to a Chats area in your Gmail account.

Visit google.com/hangouts to learn more.

Note: This app requires a Google Account.



- From a Home screen, touch  →  **Hangouts**.

Google+

Google+ makes messaging and sharing with your friends a lot easier. You can set up Circles of friends, visit the Stream to get updates from your Circles, or use Instant Upload to automatically upload videos and photos to your own private album on Google+.

Note: This app requires a Google Account.

Visit plus.google.com to learn more.

- From a Home screen, touch  →  **Google+**.

Section 5: Multimedia

This section explains how to use the music features of your device including the Play Music app and the Music Player. WatchON is also described.

Listening to Music

You can listen to music using your device's built-in speakers, through a wired headset, or through a Bluetooth headset.

For more information, refer to “*Bluetooth*” on page 83.

Press the **Volume Key** on the top of the device to activate onscreen volume control, then touch and drag on the scale to set the volume. You can also press the **Volume Key** to adjust playback volume.

Play Music

Note: Some options require a Google Account.

Google Play Music is a Google service that gives you instant access to your personal music collection stored on the Internet and your device. Google Play Music lets you browse, shop, and play back songs purchased from the Google Play Store app, as well as songs you have loaded from your own music library



Visit music.google.com to learn more.

- From a Home screen, touch  →  **Play Music.**

Music Player

Use the Music application to listen to music.

To access Music Player:

1. From a Home screen, touch  →  **Music**.



Note: Some file formats are not supported depending on the software installed on the device. Some files may not play properly depending on the encoding method used.

The Music Player application searches your device's internal storage or on an installed memory card for music and playlists. This can take from a few seconds to several minutes, depending on the amount of new music added since you last opened the application. It then displays your music in several ways.

2. Touch a tab, such as **Playlists**, **Tracks**, **Albums**, and so on, to change the way you view the contents of your library.



Searching for Music

To find music in your library:

1. Touch  **Music**.
2. Touch  **Search** and use the keyboard to type the name of an artist, album, or song.

Music Player Options and Settings

To use Music Player options and configure settings:

1. Touch  **Music**.
2. Touch  **Menu** to display the following options:
 - **Create playlist / Add to playlist:** Create a new playlist or add to a playlist.
 - **Via Bluetooth:** Share music via Bluetooth.
 - **Delete:** Delete selected or all items.
 - **Music square:** Create a playlist based on mood.
 - **Scan for nearby devices:** Share music with devices nearby.
 - **Settings:** The following settings display:
 - Player**
 - **SoundAlive:** Configure SoundAlive.
 - **Adapt Sound:** Enhance sound quality.

- **Play speed:** Decrease or increase play speed.
- **Music auto off:** Set the option Off or set your music to turn off automatically by touching one of the time values.
- **Lyrics:** Display the lyrics of the song, if available.
- **Smart volume:** Automatically adjust volume to surroundings.
- **Voice control:** Use voice commands to control playback.

My music

- **Tabs:** Customize the tabs that display on the main Music screen. Playlists and Tracks are not optional.
- **Playlists:** Customize the types of playlists that display. Favorites is not optional.

To rearrange Tabs or Playlists, touch the grid  for an entry and drag the entry to a new position in the list.

Managing Playlists



Create, manage, or delete a playlist:

- Touch  **Music**.

Creating a Playlist

1. Touch the **Playlists** tab.
2. Touch  **Menu** → **Create playlist**.
– or –
Under **My playlists**, touch **Create playlist**.
3. Use the keyboard to enter a name for the playlist and touch **OK**.



Adding Songs to a Playlist

1. Touch the **Playlists** tab and, under **My playlists**, touch a playlist. Touch  **Add tracks**.
– or –
Touch the **Tracks** tab and touch  **Menu** → **Add to playlist**.
2. Touch each song you want to add or touch **Select all**, and then touch **Done**.
3. If the ADD TO PLAYLIST screen displays, touch a playlist, **Create playlist**, or **Now playing list**.

Renaming a Playlist

1. Touch the **Playlists** tab and, under **My playlists**, touch a playlist.
2. Touch  **Menu** → **Edit title**.
3. Use the keyboard to enter a new name for the playlist and touch **OK**.

Changing the Order of a Playlist

1. Touch the **Playlists** tab and, under **My playlists**, touch a playlist.
2. Touch  **Menu** → **Change order**.
3. Touch the grid  for an entry and drag the entry to a new position in the list.
4. Touch **Done** to change the order and save the playlist.

Playing a Playlist

1. Touch the **Playlists** tab.
2. Touch **Favorites**, **Most played**, **Recently played**, or **Recently added**, or touch a playlist title that you created.
3. Touch a song to start playing the playlist at that song.

Removing Songs from Playlists

1. Touch the **Playlists** tab and touch a playlist.
2. Touch  **Menu** → **Remove**.
3. Touch each song you want to remove or touch **Select all**.
4. Touch **Done** to save the playlist.

Deleting a Playlist

1. Touch the **Playlists** tab.
2. Touch  **Menu** → **Delete**.
3. Touch each playlist you want to remove or touch **Select all**.
4. Touch **Done**.

Playing Music

1. Touch  **Music**.
2. Touch a song or touch an album or genre and then touch a song in the list of songs on the album.
The song you touch starts to play. Unless you choose a repeat option, the tracks in the current list play in order until the end of the list is reached. Otherwise, playback stops only if you stop it, even when you switch applications.

Accessing the Music Player

If you navigate away from the Music Player application and music is playing, the Music notification icon  is displayed in the System Bar.

You can change songs or easily return to the Music Player:

1. Touch the top of the screen and swipe downward.
The Notification Panel displays.
2. Touch the song thumbnail to display the Music player.
You can also pause and resume playback and skip to the next or previous song in the panel. For more information, refer to *“Notifications”* on page 21.







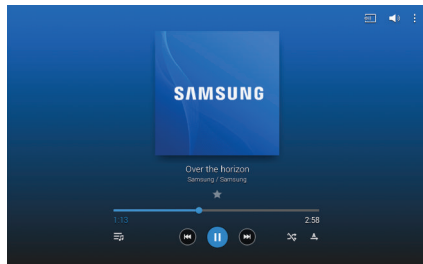









Music Player Controls

When a song is playing, the Music Player screen displays and various controls are available.

1. Touch  **Music**.
2. Touch a song or playlist to begin playback.
The music player displays below the music listing.
3. Touch the song thumbnail to enlarge the music player.





During playback, the following controls are available:

-  Scan for DLNA-enabled devices.
-  Volume control and SoundAlive.
-  Volume control showing volume muted.
-  Touch to view and set SoundAlive options.
-  Access settings.
-  Assign the current song as a Favorite.
-  Touch and drag the end of the progress bar to scan forward or backward through the current song.
-  Lists the current playlist songs.
-  Touch and hold to rewind the song. Touch to go to previous song.
-  Pause the song.
-  Start the song after pausing.
-  Touch and hold to fast-forward the song. Touch to go to next song.
-  Shuffles the current list of songs randomly.
-  Songs play in order and are not shuffled.
-  Plays the entire song list once.
-  Replays the current list when the list ends.
-  Repeats the currently playing song.



Options While Playing a Song

There are various options and controls available while a song is playing:

1. Touch  **Music**, touch a playlist or an album, and then a song.
2. Touch the music player to enlarge it.
3. Touch  **Menu** to display the following options:
 - **Via Bluetooth:** Play the current song by using a Bluetooth device.
 - **Add to playlist:** Add the song to a new playlist or an existing playlist.
 - **Set as:** Use the current song as an alarm tone.
 - **Scan for nearby devices:** Discover and connect directly to nearby devices.
 - **Settings:** Displays Music Player settings. For more information, refer to “*Music Player Options and Settings*” on page 48.
 - **Details:** View song details.
 - **End:** This option returns you to the Home Screen.

Playing Music by Mood

Play music grouped by mood. The playlist is automatically created by the device.

- Touch  **Music** →  **Menu** → **Music square** and select a cell of mood.
– or –
Select multiple cells by dragging your finger across multiple cells.

WatchON

Enjoy all of your favorite movies and TV shows with WatchON.



Important! Before you use WatchON, verify that you have an active Internet connection available. For more information, refer to “*Wi-Fi*” on page 79.

- Before beginning your initial WatchON application setup, make sure that your TV is turned off.
- To improve your recommendations, turn on seamless viewing across multiple screens, and simplify the purchase of content from Samsung WatchON, sign into your Samsung account before using WatchON. For more information, refer to “*Your Samsung Account*” on page 34.

Initial Configuration

1. From a Home screen, touch  →  **WatchON**.
The Set up WatchON screen displays.
2. Touch **Set up WatchON**.
3. Follow the onscreen instructions.

WatchON Menu



1. From a Home screen, touch  →  **WatchON**.
2. Touch  **Menu** for the following options.
 - **Sign in:** Sign in to your Samsung account to improve your WatchON experience.
 - **Settings:** Configure Samsung WatchON settings. Follow the onscreen instructions.
 - **Help:** Displays Samsung WatchON help information and a Contact us telephone number.

Section 6: Camera and Video

Camera

Use this application to take photos or videos.

Use **Gallery** to view photos and videos taken with the device's camera.

- From a Home screen, touch  →  **Camera**.

Note: The camera automatically shuts off when unused.

Camera Etiquette

- Do not take photos or videos of other people without their permission.
- Do not take photos or videos where legally prohibited.
- Do not take photos or videos in places where you may violate other people's privacy.

Taking Photos

- Touch the image on the preview screen where the camera should focus. When the subject is in focus, the focus frame turns green.
- Touch  to take the photo.

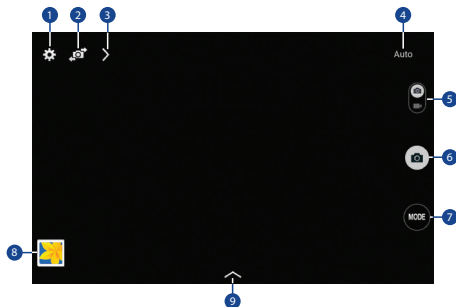

- Change camera settings
- Switch between the front and rear camera
- Quick settings
- Display current mode
- Record video button
- Camera button
- Shooting mode
- Open Gallery to view photos and videos
- Select an effect

Shooting Mode

Several photo effects are available. Some modes are not available when taking self-portraits.

- Touch **MODE**, and then scroll up or down the screen at the right side of the screen.
 - **Auto**: Allow the camera to evaluate the surroundings and determine the ideal mode for the photo.
 - **Beauty face**: Take a photo with lightened faces for gentler images.
 - **Sound & shot**: Take a photo with sound.
 - Touch  to take a photo. The device records a few seconds of audio after taking a photo.



Note: While taking photos in this mode, sound is recorded by the internal microphone.

- **Panorama**: Take a photo composed of many photos strung together. To get the best shot, follow these tips:
 - Move the camera slowly in one direction.
 - Keep the camera's viewfinder within the guide frame.
 - Avoid taking photos of a subject in front of unrecognizable backgrounds, such as empty skies or plain walls.

- **Sports**: Use this setting for fast-moving subjects.
- **Night**: Take brighter, clearer pictures in low light without a flash.

Panoramic Photos

A panoramic photo is a wide landscape image consisting of multiple shots.





1. Touch **MODE** → **Panorama**.
2. Touch  and move the camera slowly in one direction.
 - When the blue frame aligns with the viewfinder, the camera automatically takes another shot in a panoramic sequence.
3. To stop shooting, touch . If the viewfinder is out of the direction, the device stops shooting.

Applying Filter Effects

Use the filter effects to take unique photos or videos.

- Touch  and select a filter effect. The available options vary by mode.

Recording Videos

- To record a video, touch  to record a video.
- To pause recording, touch .
- To continue recording, touch .
- To stop recording, touch .

Recording Mode

- Touch **> Options** →  **Recording mode** to change the recording mode.
 - **Normal:** Use this mode for normal quality.
 - **Limit for email:** Use this mode to lower quality for sending via messages.

Zooming In and Out

Use one of the following methods:

- Use the **Volume** button to zoom in or out.
- Spread two fingers apart on the screen to zoom in, and pinch to zoom out.

Note: The zoom in and out effect is available when using the zoom feature while shooting video.

Share Shot

- Touch **> Options** →  and select one of the following:
 - **Share shot:** Send a photo directly to another device via Wi-Fi Direct.
 - **Buddy photo share:** Set the device to recognize a person's face that you have tagged in a photo and send it to that person.
 - **Remote viewfinder:** Set a device to control the camera remotely.

Controlling the Camera Remotely

Set a device as a viewfinder to control the camera remotely.

1. Touch **> Options** →  → **Remote viewfinder**, and then connect the device and the camera using Wi-Fi Direct.
2. Touch to take a photo remotely using the device as a viewfinder.

Configuring Settings for Camera

- Touch  to configure settings for Camera. Not all of the following options are available in both still camera and video camera modes. The available options vary depending on the mode used.

Camera:

- **Photo size:** Select a resolution. Use higher resolution for higher quality. Higher resolution photos take up more memory.
- **Metering modes:** Select a metering method. This determines how light values are calculated. Centre-weighted measures background light in the centre of the scene. Spot measures the light value at a specific location. Matrix averages the entire scene.

Video recorder:

- **Video size:** Select a resolution. Use higher resolution for higher quality. Higher resolution videos take up more memory.

Settings:

- **Location tag:** Attach a GPS location tag to the photo.

Tip: Your location may appear on your photos when you upload them to the Internet. To avoid this, deactivate the GPS tag setting.

- **Review pics/videos:** Set to show photos or videos after taking them.
- **Volume key:** Set the device to use the Volume button to control the shutter or zoom function.
- **Timer:** Use this for delayed-time shots.
- **White balance:** Select an appropriate white balance, so images have a true-to-life color range. The settings are designed for specific lighting situations. These settings are similar to the heat range for white-balance exposure in professional cameras.
- **Brightness:** Change the brightness value. This determines how much light the camera's sensor receives. For low light situations, use a higher value.
- **Guidelines:** Display viewfinder guides to help composition when selecting subjects.
- **Flash:** Activate or deactivate the flash.

- **Voice control:** Set the camera to take photos with voice commands.
- **Contextual filename:** Set the camera to display contextual tags. Activate this to use Tag Buddy in Gallery.
- **Save as flipped:** Reverse the image to create a mirror-image of the original scene.
- **Storage:** Select the memory location for storage.
- **Reset:** Reset the camera settings.
- **Help:** Access help information for using the camera.

Shortcuts

Reorganize shortcuts for easy access to the camera's various options.



1. Touch **> Options**.
2. Touch and hold a shortcut icon to display all shortcuts.
3. Touch and hold an option and drag it to a slot at the top of the screen.

Note: The other icons can be moved within the list by touching and dragging them.

Tip: Touch **Reset** to reset the quick settings layout to the default settings.

Gallery

Use this application to view images and videos.

- From a Home screen, touch  →  **Gallery**.

Note: Some file formats are not supported depending on the software installed on the device. Some files may not play properly depending on the encoding method used.

Viewing Images

Launching Gallery displays available folders. When another application, such as Email, saves an image, the Download folder is automatically created to contain the image.

Likewise, capturing a screenshot automatically creates the Screenshots folder.

- Select a folder to open it.

In a folder, images are displayed by creation date.

- Select an image to view it in full screen.
- Scroll left or right to view the next or previous image.

Zooming In and Out

Use one of the following methods to zoom in or out on an image:

- Double-tap anywhere on the screen to zoom in or zoom out.
- Spread two fingers apart on any place to zoom in. Pinch the screen to zoom out.

Playing Videos



Video files show the  icon on their thumbnails.

- Select a video to watch it and touch .

Trimming Segments of a Video

1. Select a video, and then touch  **Trim**.
2. Move the start bracket to the desired starting point, move the end bracket to the desired ending point, and then save the video.

Editing Images

- While viewing an image, touch  **Menu** and use the following functions:
 - **Favorite:** Add to the favorites list.
 - **Slideshow:** Start a slideshow with the images in the current folder.
 - **Photo frame:** Use this to add a frame and a note to an image. The edited image is saved in the Photo frame folder.
 - **Photo note:** Use this to write a note on the back of the image. Touch , to edit the note.
 - **Copy to clipboard:** Copy to clipboard.
 - **Print:** Print the image via a USB or Wi-Fi connection. Some printers may not be compatible with the device.
 - **Rename:** Rename the file.
 - **Buddy photo share:** Send the image to a person whose face is tagged in the image.
 - **Rotate left:** Rotate counter-clockwise.
 - **Rotate right:** Rotate clockwise.
 - **Crop:** Resize the blue frame to crop and save the image in it.



- **Set as:** Set the image as wallpaper or a contact image.
- **Details:** View image details.
- **Settings:** Change the Gallery settings.

Favorite Images

- While viewing an image, touch  **Menu** → **Favorite** to add the image to the favorites list.



Deleting Images

Use one of the following methods:

- In a folder, touch  **Menu** → **Select item**, Touch images to tag them, and then touch  **Delete**.
- When viewing an image, touch  **Delete**.

Sharing Images

Use one of the following methods:

- In a folder, touch  **Menu** → **Select item**, touch images to select them, and then touch  to send them to others or share them via social network services.
- When viewing an image, touch  to send it to others or share it via social network services.

Setting as Wallpaper

- When viewing an image, touch  **Menu** → **Set as** to set the image as wallpaper or to assign it to a contact.

Tagging Faces

1. Touch  **Menu** → **Settings** → **Tags** → **Face tag**.
A yellow frame appears around the recognized face.
2. Touch the face, touch **Add name**, and then select or add a contact.
3. When the face tag appears on an image, touch the face tag and use available options, such as sending messages.



Using Tag Buddy

To display a contextual tag (weather, location, date, and person's name) when opening an image:

1. Touch  **Menu** → **Settings** → **Tags** → **Tag buddy**.
2. Touch the **OFF/ON** button to turn Tag buddy ON .

Video

Use this application to play video files.

- From a Home screen, touch  →  **Video**.

Note: Some file formats are not supported depending on the device's software. Some files may not play properly depending on the encoding method used.

Playing Videos

Select a video to play.

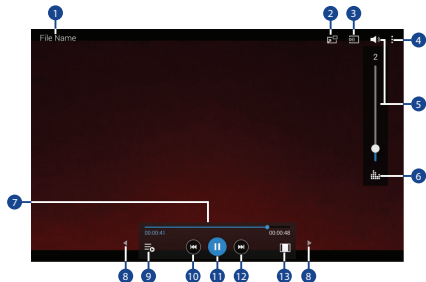

1. Video file name
2. Use the pop-up player
3. Scan for DLNA-enabled devices
4. Access additional options
5. Touch to display the volume control, and then touch and drag on the scale to set volume. You can also press the Volume Key on the side of the device to adjust playback volume
6. Display the volume control (5) and touch this icon to access SoundAlive settings
7. Move forwards or backwards by dragging the bar
8. Touch either side of the controls to reposition to the left or right
9. Switch to split screen mode and show video thumbnails on the left side of the screen
10. Restart the current video or skip to the previous video. Touch and hold to move backwards quickly
11. Pause and resume playback
12. Skip to the next video. Touch and hold to move forwards quickly
13. Change screen ratio

Deleting Videos

- Touch  **Menu** → **Delete**, select videos by ticking, and then touch **Delete**.

Sharing Videos

Touch  **Menu** → **Share via**, select videos by ticking, touch **Done**, and then select a sharing method.



Using Pop-Up Video Player

Use this feature to use other applications without closing the video player.

- While watching videos, touch  to use the pop-up player.
- Spread two fingers apart on the screen to enlarge the player or pinch to reduce it.
- To move the player, drag the player to another location.

YouTube

Use this application to watch videos from the YouTube website.

- From a Home screen, touch  →  **YouTube**.

Section 7: Applications

This section contains a description of each application that is available on the Apps screen, its function, and how to navigate through that particular application. If the application is described in another section of this user manual, then a cross reference to that description is provided.

Updating Applications

Once you have registered your device (see “*Software Update*” on page 128) and signed into your Google Account (see “*Your Google Account*” on page 34), you may see the  **Updates Available** notification in the Status Bar if there is a new version of one or more apps available or, when you open an application that is preloaded on your device, an **Update Available** message may be displayed.

To update the applications:

1. Touch the top of the screen and swipe downward.
The Status Details screen displays.
2. Touch **Updates available**.

GPS Applications

GPS applications allow you to achieve real-time, GPS-enabled, turn-by-turn navigation and to access local searches based on a variety of category parameters.

To receive better GPS signals, avoid using your device in the following conditions:

- Inside a building or between buildings
- In a tunnel or underground passage
- In poor weather
- Around high-voltage or electromagnetic fields
- In a vehicle with tinted windows

Global GPS turn-by-turn navigation, mapping, and Point of Interest content is available for three areas, including North America, Western Europe, and China, where wireless coverage is available.

Important! If you touch or cover the internal GPS antenna while using GPS services, it may impede the GPS signal resulting in the GPS services not working in an optimal manner. To locate the approximate location of the internal GPS antenna, see “*Back, Top, and Bottom*” on page 12.

Accessing Applications

The **Apps** screen displays all applications installed on your wireless device. Applications that you download and install from Google Play or from the web are also added to a Home screen.



To access applications:

1. From a Home screen, touch . The Apps screen displays.
2. Locate the application's icon and touch it to launch the application.

Tip: To open applications quickly, add the icons of frequently-used applications to one of the Home screens, if it is not there by default. For more information, refer to “*Adding a Shortcut or Widget*” on page 24.

Alarm

Set alarms for reminders or for wake-up times.



1. Touch  **Alarm**.
2. Touch  **Turn alarm on** to activate the alarm. A gray alarm means the alarm is deactivated.
3. Touch an alarm to change any of its settings and then touch **Save** to save the updates.

Note: When an alarm is set,  displays in the Status Bar.

Setting Alarms

- Touch  **Create**, set a time for the alarm to go off, select days for the alarm to repeat, and then touch **Save**.
 - **Location alarm:** Set a location. The alarm goes off only when you are in the location.
 - **Snooze:** Set an interval and the number of times for the alarm to repeat after the preset time.
 - **Smart alarm:** Set a time for the alarm to go off before the preset time.
 - **Name:** Give the alarm a name.

Stopping Alarms



- Drag  outside the large circle to stop an alarm.
- Drag  outside the large circle to repeat the alarm after a specified length of time.

Deleting Alarms

- Touch and hold the alarm, and then touch  **Delete**.

Calculator

The Calculator provides basic and advanced arithmetic functions.

1. Touch  **Calculator**.
2. Enter the first number using the numeric keys.
3. Enter the operation for your calculation by touching the corresponding onscreen arithmetic function key.
4. Enter the next number.
5. To view the result, touch the = (equals) key.
6. Repeat Steps 3 through 5 as many times as required.
7. Touch  to clear the result.
8. To clear the calculator history, touch  **Clear history**.

9. For more advanced problems, use the advanced operators **sin**, **ln**, **cos**, **log**, **tan**, and so on, just as you would on a pocket calculator.
10. Touch and hold entries in the Calculator's display field to copy or cut the contents of the display.
Copied to clipboard displays. Paste the copied value in another app.

Calendar

Use this application to manage events and tasks.

- Touch  **Calendar**.



Creating Events or Tasks

1. Touch  and use one of the following methods:
 - **Add event**: Enter an event with an optional repeat setting.
 - **Add task**: Enter a task with an optional priority setting.– or –
Touch a date on the calendar to select it and touch it again.

Enter a title and specify which calendar to use or sync with. Then touch **Edit event details** or **Edit task details** to add more details, such as how often the event repeats, when it has an advance alert, or where it takes place.

2. Attach a map showing the location of the event. Enter the location in the **Location** field, touch  next to the field, and then pinpoint the precise location by touching and holding on the map that appears.

Syncing with Google Calendar

1. From a Home screen, touch  →  **Settings** → **General** tab → **Accounts** → **Google**.
2. Touch a Google Account → **Sync Calendar** → **Sync now**.

To manually sync for updating:

- Touch  **Calendar** →  **Menu** → **Sync**.

To display synced events or tasks:

- Touch  **Calendar** →  **Menu** → **Calendars**, and then check mark the Google Account.





Changing Calendar Type

At the top of the screen:

1. Touch a calendar type: **Year**, **Month**, **Week**, or **Day**.
2. Touch **List** to list all events or **Task** to list all tasks.

Options

Addition options for events and tasks:

- **Search for events or tasks:** Touch  **Search** to search for an event.
- **View today's events:** Touch **Today** at the top of the screen.
- **Delete an event or task:** Touch the entry. On the pop-up, touch  **Menu** → **Delete**.
– or –
Touch  **Menu** → **Delete**, select events, and then touch **Delete**.
- **Share an event or task:** Touch the entry. On the pop-up, touch  **Menu** → **Share via**, and then select a sharing method.

Camera

Use this application to take photos or videos.

- Touch  **Camera**.

For more information, refer to “*Camera*” on page 55.

Chrome

Use Chrome to browse the internet and bring your open tabs, bookmarks and omnibox data from your computer to your tablet.

- Touch  **Chrome**.

Contacts

Store contact information for your friends, family, and colleagues, to quickly access information or to send a message.

- Touch  **Contacts**.



For more information, refer to “*Contacts*” on page 34.

Drive

Use the Google Drive app to open, view, rename, and share your Google Docs and files.

1. Touch  **Drive**.
2. Sign in to your Google account. For more information, refer to “*Setting Up Your Gmail Account*” on page 45. A product tour displays the first time you access Drive.
3. Touch **Next** to view the product tour or touch **Go to Drive** to get started.

Tip: Touch  **Menu** → **Product Tour** to repeat the product tour at any time.

4. Follow the onscreen instructions to use Drive.
5. Touch  **Menu** → **Settings** to configure your Drive preferences.
6. Touch  **Menu** → **Help** to display additional help information.

Dropbox

Use this application to save and share files with others via the Dropbox cloud storage. When you save files to Dropbox, your device automatically syncs with the web server and any other computers that have Dropbox installed.

1. Touch  **Dropbox**.
2. Follow the onscreen instructions to complete the setup and begin using Dropbox.

Email

Send and receive email using popular email services.

- Touch  **Email**.

For more information, refer to “*Email*” on page 42.

Gallery

Use Gallery to view, capture, and manage photos and videos.

For more information, refer to “*Gallery*” on page 60.

- Touch  **Gallery**.

Gmail

Send and receive email with Gmail, Google’s web-based email.

- Touch  **Gmail**.

For more information, refer to “*Gmail*” on page 45.

Google

Use this application to search not only the Internet, but also applications and their contents on the device as well.

- Touch  **Google**.

Google Now

Google Now recognizes repeated actions performed on the device (including accessing locations, repeated calendar appointments, search queries, and more). Google Now uses these actions to automatically send updates for user-specific information in the form of “cards.”

For more information, visit google.com/landing/now.

1. Press and hold  **Home**.
2. Follow the prompts to set up and use Google Now.

Note: When Google Now is enabled, you can also access it by touching  **Google**.

Google Settings

Use this application to configure settings for some features provided by Google.

- Touch  **Google Settings**.

Google+

Share updates and see what is going on around you with Google+ for mobile.

- Touch  **Google+**.

For more information, refer to “*Google+*” on page 46.

Hancom Viewer

Hancom Office Viewer opens and manages Hancom Office Hanword (*.hwp) and Hanshow (*.show) documents.

1. Touch  **Hancom Viewer**. The app will install.
2. For more information, touch **About Hancom Viewer** → **Online Support**.

Hangouts

Hangouts is an online place to meet friends and family, share photos, and host video calls.

- Touch  **Hangouts**.

For more information, refer to “*Hangouts*” on page 46.

Help

Access help information to learn how to use the device and applications or configure important settings.

- Touch  **Help**.





For more information, refer to “*Help*” on page 27.

Internet



Your device is equipped with a full HTML browser that gives you access to the Internet.

- Touch  **Internet**.

Command Keys

- Touch  **Back** or  to return to the previous page.
- Touch  **Forward** to go forward to a recent page.
- Touch  **Home** to display your Internet Home screen.
- Touch  **Refresh** to reload the current page.

Searching the Web via Voice

- Touch the address field, touch   , speak a keyword, and then select one of the suggested keywords that appear.

Maps

Use Google Maps to find your current location, get directions, and other location-based information.

Note: You must enable location services to use Maps. For more information, refer to “*Location Services*” on page 94.



- Touch  **Maps**.

Memo





Use this application to record important information to save and view at a later date.

- Touch  **Memo**.

Viewing a Memo

1. Touch the memo thumbnail to open it.
2. To edit the memo, touch the content of the memo.
3. To delete the memo, touch  **Delete**.
4. To send the memo to others, touch  **Share via**.
5. To send the memo to a Google or Samsung printer, touch  **Print**.

Composing a Memo

- Touch  **New**, enter a memo, and then touch **Save**.
- To change the category, touch .
- To insert an image into the memo, touch .
- To use your voice to insert text into the memo, touch .

Browsing Memos

- Browse memo thumbnails by scrolling up or down.
- To edit a memo, touch a memo thumbnail, and then touch the content of the memo.
- To search for a memo, touch .

Editing the Category List

To edit the category list:

- Touch  **Menu** → **Edit categories**.

Print a Memo

- To print a memo, first view it, and then touch .

Delete a Memo

- To delete memos, touch  **Menu** → **Delete**.

Music

Play music and other audio files that you copy from your computer.

- Touch  **Music**.

For more information, refer to “*Music Player*” on page 48.

My Files









Use this application to access all kinds of files stored in the device, including images, videos, songs, and sound clips.

- Touch  **My Files**.

Viewing Files

Files stored in the device are sorted by criteria.

1. From the left pane of the screen, select one of the following categories:
 - **Timeline**: View files that are grouped by date.
 - **Favorite folders**: View shortcuts to folders or FTP servers.
 - **Folders**: View files stored in the internal memory or a memory card.
 - **Categories**: View files sorted by their types.
 - **Apps**: View files stored or created in specific applications.

2. Touch a file or folder to open it.
3. Touch  **Menu** for general options:
4. Touch  **Menu** → **Select**, and select a file or folder. Then select an option to share, delete, move, or copy a file, or select additional options.
5. Additional options:
 - Touch  **Search**, and then enter search criteria.
 - Touch  **Storage** to view memory information for your device and memory card.
 - Touch  to change the view mode.
 - From the Folders category, touch  **Create folder**, enter a name for the folder, and then touch **OK**.
 - To add a shortcut to frequently-used folders in *Favorite folders*, select a folder and then touch  **Menu** → **Add to Favorite folders**.
 - To add an FTP server shortcut in *Favorite folders*, touch  **Menu** → **Add FTP**, enter details for the FTP server, and then touch **Done**.

Netflix

Watch TV shows and movies, streaming from Netflix.

Note: This app requires a Netflix membership. For more information, visit netflix.com.

- Touch  **Netflix**.

Photos

Automatically save every photo you take with your phone to your Google+ account. Then it is easy to view, organize, and share them with friends and family of your choice.

Visit google.com/+/learnmore/photos to learn more.

Note: This app requires a Google Account.

- Touch  **Photos**.

Play Books

With Google Play Books, you can find more than 3 million free e-books and hundreds of thousands more to buy in the eBookstore.

Visit play.google.com/store/books to learn more.

Note: This app requires a Google Account.

- Touch  Play Books.

Play Games

Discover hundreds of games for download and purchase through the Google Play Store.

Visit play.google.com/store/apps/category/GAME to learn more.

Note: This app requires a Google Account.

- Touch  Play Games.

Play Movies & TV

Watch movies and TV shows purchased from Google Play. You can stream them instantly, or download them for viewing when you're not connected to the Internet. You can also view videos saved on your device.

Visit play.google.com/about/movies to learn more.

Note: This app requires a Google Account.

- Touch  Play Movies & TV.

Play Music

With Google Play Music, you can play music you've downloaded, and music you copied from your computer.

Visit play.google.com/about/music to learn more.

Note: This app requires a Google Account for some features.

- Touch  Play Music.

Play Newsstand

Play Newsstand brings you free and paid news, magazine subscriptions, and much more all in one place.

Visit play.google.com/store/newsstand to learn more.

Note: This app requires a Google Account.

- Touch  **Play Newsstand**.

Play Store

All your favorite apps, movies and tv shows, music, books, magazines, and games are available in Google Play Store.

Visit play.google.com/store to learn more.

Note: This app requires a Google Account.

- Touch  **Play Store**.

S Voice

Use this application to command the device by voice to dial a number, send a message, write a memo, and more.

- Touch  **S Voice**.
– or –
Touch  **Home** twice.

Here are several examples of spoken commands:

- “Open music”
- “Launch calculator”
- “Check schedule”

Tips for better voice recognition:

- Speak clearly.
 - Speak in quiet places.
 - Do not use offensive or slang words.
-

Note: The device may not recognize your commands or may perform unwanted commands depending on your surroundings or how you speak.

Samsung Apps

Use this application to purchase and download dedicated Samsung applications.

For more information, visit samsungapps.com.



- Touch  **Samsung Apps**.

Installing Applications

1. Browse applications by category. Touch **CATEGORY** to select a category.
2. To search for an application, touch  **Search** at the top of the screen, and then enter a keyword in the search field.
3. Select an application to view information. To download it, touch **Free** or the price.

Screen Saver

When your tablet screen automatically times out, instead of a blank screen, enable the Galaxy Tab 4 Screen Saver, which is actually an action-packed video tour of all the fantastic features that you will find on your Galaxy Tab 4.

1. Touch  **Screen Saver**.
2. Follow the onscreen instructions to set up Screen Saver.
3. Touch  **Back** to stop the Screen Saver video even if Enable Touch To Stop is enabled.

Settings

Configure your device to your preferences.

- Touch  **Settings**.

For more information, refer to “*Settings*” on page 91.

Video

Use this application to play video files.

- Touch  **Video**.

For more information, refer to “*Video*” on page 62.

Voice Search

Use this application to search web pages by speaking.

- Touch  **Voice Search**.
- Speak a keyword or phrase when **Speak now** appears on the screen.

WatchON

Enjoy all of your favorite movies and TV shows with WatchON.

- Touch  **WatchON**.

For more information, refer to “*WatchON*” on page 54.

World Clock

Use this application to check the time of many major cities in the world.

- Touch  **World Clock**.
A list of the locations you have added displays.



To add another city to the list:

1. Touch  **Add city** to add another city to the list.
2. Scroll through the list of cities to find the city you want to add or touch the Search bar and use the keyboard to enter the name of the city you want to add.



Tip: Touch the first letter of the city’s name, to the right of the list, to find the city more quickly.

3. Touch the city. The list of your locations displays including the city just added.

To set Daylight Savings time:

1. Touch and hold a city.
2. Touch .
3. Select Automatic, DST off, or 1 hour. If Daylight Savings Time is active,  appears on the city’s entry.

To delete a World Clock entry:

1. Touch  **World Clock**.
2. Touch and hold a city. Touch any other cities you want to delete.
3. Touch  **Delete**.

YouTube

Watch videos from the YouTube website.

- Touch  YouTube.

Section 8: Connections

Your device includes features to connect to the internet and to other devices by using Wi-Fi, Bluetooth, or a USB cable.

Wi-Fi

Wi-Fi is a wireless networking technology that provides access to local area networks. Use your device's Wi-Fi feature to:

- Access the internet for browsing or to send and receive email.
- Access your corporate network.
- Use hotspots provided by hotels or airports while traveling.

Wi-Fi communication requires access to an existing Wireless Access Point (WAP). WAPs can be Open (unsecured, as with most hotspots) or Secured (requiring you to provide login credentials).

Your device supports Wi-Fi 802.11 a/b/g/n.

Turn Wi-Fi On or Off

Turn your device's Wi-Fi service on or off. When you turn Wi-Fi service on, your device automatically searches for available, in-range WAPs (Wireless Access Points).

From the Notification Panel

1. From any screen, touch the top of the screen and swipe downward. The Notification Panel displays.
2. Touch **Wi-Fi** to turn Wi-Fi **ON** (green) or **OFF** (grey).

From Settings

1. From a Home screen, touch  →  **Settings** → **Connections** tab → **Wi-Fi**.
2. Touch the **OFF/ON** button to turn Wi-Fi ON  or OFF .

Scan and Connect to a Wi-Fi Network

When you turn on Wi-Fi, your device searches for and displays available Wi-Fi connections.

1. From any screen, touch the top of the screen and swipe downward. The Notification Panel displays.
2. Touch **Wi-Fi** to turn Wi-Fi **ON** (green). Your device begins scanning for available Wireless Access Points.



Note: To begin a new scan for available WAPs, touch **Scan**.

3. When the scan is complete, touch a Wi-Fi network to connect. If the Wi-Fi network is open (unsecured), your device automatically connects. If the Wi-Fi network is secured, enter the password at the prompt to connect.

Tip: You can have your device automatically notify you of available networks. See **Network notification** under “*Wi-Fi Settings*” on page 81.

Note: When Wi-Fi is on,  is displayed on the Status Bar.

Add a Wi-Fi Network Manually

1. From a Home screen, touch  →  **Settings** → **Connections** tab → **Wi-Fi**.
2. Touch the **OFF/ON** button to turn Wi-Fi ON .
3. Touch **Add Wi-Fi network** and enter the following:
 - **Network SSID:** Enter the name of the Wi-Fi Wireless Access Point (WAP).
 - **Security:** Select the type of security used by the WAP.

Note: Depending on the security protocol used by the WAP, additional network information may be required, such as a password.

- **Password:** If the WAP is secured, enter the password or hex key.
4. Touch **Connect**.

Wi-Fi Status Indicators

The following icons show your current Wi-Fi connection status at a glance:



Displays when Wi-Fi is connected, active, and communicating with a Wireless Access Point (WAP).







Displays when there is a Wi-Fi access point available but you are not connected to it. May also display if there is a communication issue with the target Wireless Access Point (WAP).



Displays when connected to another device using Wi-Fi Direct. For more information, refer to “*Wi-Fi Direct*” on page 82.

Wi-Fi Settings

The Wi-Fi settings menu allows you to set up many of your device’s advanced Wi-Fi services.



1. From a Home screen, touch  →  **Settings** → **Connections** tab → **Wi-Fi**.
2. Touch the **OFF/ON** button to turn Wi-Fi ON .
3. Touch  **Menu** for options:
 - **Advanced:**
 - **Network notification:** Receive a notification when new Wireless Access Points (WAPs) are available.
 - **Sort by:** Sort Wi-Fi networks by Alphabet or Signal strength.
 - **Keep Wi-Fi on during sleep:** Specify when to disconnect from Wi-Fi.
 - **Always allow scanning:** Allow Google location service and other apps to scan for networks, even when Wi-Fi is turned off.
 - **Wi-Fi timer:** Set the start time and end time to connect to or disconnect from Wi-Fi networks.
 - **Install certificates:** Install authentication certificates.

- **MAC address:** View your device's MAC address, which is required when connecting to some secured networks (not configurable).
- **IP address:** View your device's IP address (not configurable).
- **WPS push button:** Set up a connection to a WPS (Wi-Fi Protected Setup) router or other equipment.
- **WPS PIN entry:** View the PIN used by your tablet to set up a PIN-secured connection to a Wi-Fi router or other equipment (not configurable).
- **Help:** Learn about setting up and using Wi-Fi networks, and other settings.

Wi-Fi Direct

Wi-Fi Direct allows device-to-device connections so you can transfer large amounts of data over a Wi-Fi connection.

These devices must be enabled for Wi-Fi Direct communication. This connection is direct and not via a hot spot or Wireless Access Point (WAP).

1. From a Home screen, touch  →  **Settings** → **Connections** tab → **Wi-Fi**.
2. Touch the **OFF/ON** button to turn Wi-Fi ON .

3. Touch **Wi-Fi Direct**. Your device begins scanning for other devices enabled with Wi-Fi Direct.
4. Enable Wi-Fi Direct on the target device.
5. In the list of available devices, touch the target device.
 - or –
 If you want to connect to more than one device, touch **Multi connect** and touch each device to which you want to connect that supports Multi-connect. Touch **Done**.
6. On the target device, touch **Accept** (you have 30 seconds to touch **Accept**). Once connected, the target device will show as **Connected** in your list of Wi-Fi Direct devices and the  icon will display on the Status Bar.

Share Information with Wi-Fi Direct

To share videos, photos, or other information with the connected device, follow these steps:

1. View the information that you want to share. For example, if you want to share a photo, find the photo in your camera viewer or touch  **My Files** folder, then touch the **Share**, **Share via**, or **Send via** option.

2. Touch the **Wi-Fi Direct** option.

The Wi-Fi Direct settings screen displays, Wi-Fi Direct is turned on, and your device scans for other devices.

3. Touch a connected device name.

The other device displays a pop-up that indicates it is receiving the file.

Bluetooth

Bluetooth is a short-range wireless communications technology for exchanging information over a distance of about 30 feet. You do not need to line up the devices to send information with Bluetooth. If the devices are in range, you can exchange information between them—even if they are in different rooms.





Your device can use Bluetooth to share photos, contacts and other content with other Bluetooth-enabled devices. Many of the apps on your tablet provide options for sharing via Bluetooth under  **Menu**.

Turning Bluetooth On or Off

From the Notification Panel

1. From any screen, touch the top of the screen and swipe downward. The Notification Panel displays.
2. Touch **Bluetooth** to turn Bluetooth on (green) or off (grey).

From Settings



1. From a Home screen, touch  →  **Settings** → **Connections** tab → **Bluetooth**.
2. Touch the **OFF/ON** button to turn Bluetooth ON  or OFF .

Note: When Bluetooth is on,  is displayed on the Status Bar.

Pairing with a Bluetooth Device

To exchange information between your device and another bluetooth-enabled device, you first must pair them.

Tip: After pairing, your device and the target device recognize each other and exchange information without having to enter a passcode or PIN.



1. From a Home screen, touch  →  **Settings** → **Connections** tab → **Bluetooth**.
2. Touch the **OFF/ON** button to turn Bluetooth ON .
3. Make sure that the target device is discoverable so that your device can find it. Refer to the instructions that came with the target device to find out how to set it to discoverable mode.
4. Touch **Scan**. Your device will start to scan for Bluetooth devices within range.
5. When you see the name of the target device displayed in the **Available devices** section, touch the name. Your tablet will attempt to pair with the target device.
 - If requested, enter the passcode displayed on the target device.

6. The pairing and connection status is displayed below the target device in the Available devices section. When you are connected to the target device,  (Bluetooth connected) displays in the Status Bar.

Note: Due to different specifications and features of other Bluetooth-compatible devices, display and operations may be different, and functions such as transfer or exchange may not be possible with all Bluetooth-compatible devices.

Reconnect to a Bluetooth Device

When you have paired your tablet with another device, you should be able to reconnect it automatically by turning on Bluetooth on your tablet.



1. From a Home screen, touch  →  **Settings** → **Connections** tab → **Bluetooth**.
2. Touch the **OFF/ON** button to turn Bluetooth ON .
3. Make sure that the target device is discoverable so that your device can find it. Refer to the instructions that came with the target device to find out how to set it to discoverable mode.
4. Touch **Scan**. Your device will start to scan for Bluetooth devices within range.
5. When you see the name of the target device displayed in the Available devices section, touch the name. Your tablet will attempt to pair with the target device.
 - If requested, enter the passcode displayed on the target device.

If you still cannot reconnect, try to disconnect or unpair from the target device, and then follow the instructions for “Pairing with a Bluetooth Device” on page 84.

Disconnect or Unpair from a Bluetooth Device



Follow these instructions to disconnect or unpair your tablet from a Bluetooth device.

Disconnect from a Bluetooth Device

1. From a Home screen, touch  →  **Settings** → **Connections** tab → **Bluetooth**.
2. Touch the **OFF/ON** button to turn Bluetooth ON .
3. Touch the connected device, and then touch **OK** to disconnect.

Unpair from a Bluetooth Device

You can make your tablet forget its pairing connection with another Bluetooth device. To connect to the other device again, you may need to enter or confirm a passcode again.

1. From a Home screen, touch  →  **Settings** → **Connections** tab → **Bluetooth**.
2. Touch the **OFF/ON** button to turn Bluetooth ON .
3. Touch the connected device, and then touch **Unpair**.

Send Information Using Bluetooth







You can use Bluetooth to transfer information between your tablet and another Bluetooth-enabled device such as a tablet or notebook computer. The first time you transfer information between your table and another device, you need to enter or confirm a security passcode. After that, your tablet and the other device are paired, and you will not need to exchange pass codes to transfer information in the future.

Send Information from Your Tablet to Another Device

You can send the following types of information, depending on the device you are sending to:

- Images and videos
- Calendar events
- Contacts
- Audio files



Note: Your tablet must already be paired to the target device in order to share files. For more information, refer to “Pairing with a Bluetooth Device” on page 84.

1. From a Home screen, touch  →  **Settings** → **Connections** tab → **Bluetooth**.
2. Touch the **OFF/ON** button to turn Bluetooth ON .
3. Set the target device to discoverable mode. Refer to the target device's documentation for instructions on receiving information over Bluetooth.
4. On your tablet, open the application that contains the information or file you want to send. Some common ways of sharing files via Bluetooth include:
 - While viewing photos or videos in the Gallery, touch  → **Bluetooth**.
 - While playing music using the Music app, touch  **Menu** → **Via Bluetooth**.
 - While viewing a Contact, touch  **Menu** → **Share namecard** → **Bluetooth**.
5. Touch the name of the target device.
6. On the target device, follow the prompts to accept the file.



Receive Data Using Bluetooth

Your tablet is capable of receiving a wide variety of file types with Bluetooth, including photos, audio files, and documents such as PDFs.



Note: Your tablet must already be paired to the target device in order to share files. For more information, refer to “Pairing with a Bluetooth Device” on page 84.

1. From a Home screen, touch  →  **Settings** → **Connections** tab → **Bluetooth**.
2. Touch the **OFF/ON** button to turn Bluetooth ON .
3. When your tablet receives a file transfer request notification, touch **Accept**.
4. When the file is transferred, a notification displays. To open the file immediately, slide down the Notification Panel, and then touch the relevant notification.

Accessing Files Received via Bluetooth

1. From a Home screen, touch  →  **Settings** → **Connections** tab → **Bluetooth**.
2. Touch  **Menu** → **Received files**.
3. Touch a file to open it. When you open a received file, what happens next depends on the file type:
 - Media files and documents are usually opened directly in a compatible application. For example, if you open a music track, it starts playing in the Music Player application.
 - For a vCalendar file, select the calendar where you want to save the event, and then touch **Import**. The vCalendar is added to your Calendar events.
 - For a vCard contact file, if there are multiple vCard files on your storage card, you can choose to import one, several, or all of those contacts to your Contacts list.
4. Received data is normally saved to the Bluetooth folder on your tablet. If you receive a contact, it is saved to your contacts automatically.

Bluetooth Settings

1. From a Home screen, touch  →  **Settings** → **Connections** tab → **Bluetooth**.
2. Touch the **OFF/ON** button to turn Bluetooth ON .
3. Touch  **Menu** for options:
 - **Visibility timeout:** Set the length of time your tablet is visible to other devices when you turn on visibility.
 - **Received files:** Show the list of files received using Bluetooth.
 - **Rename device:** Change the name of your device.
 - **Help:** Display additional Bluetooth information.

Managing Downloads

Files, apps, and other items you download in Internet, Gmail, Email, or in other ways, are stored on your tablet's internal storage. You can use the Downloads app to view, reopen, or delete what you have downloaded.



To manage the demands on their networks or to help you avoid unexpected charges, some mobile networks place restrictions on the size of the files you can download. When you are connected to such networks, and you try to download an oversized-file, you are asked or required to delay downloading the file until the next time you are connected to a Wi-Fi network. At that time, the download resumes automatically. The Downloads app can also be used to view and manage these queued files.

Downloaded files are stored in the Download directory in your tablet's internal storage. You can view and copy files from this directory when connected to a computer with a USB cable.

Uninstalling an App

Apps come pre-installed on your device and you can download additional apps from Google Play. If you decide to, you can uninstall apps you downloaded from Google Play and other sources.





There are several ways to uninstall an app:

1. From a Home screen, touch  →  **Settings** → **General tab** → **Application manager**.
2. Touch the **DOWNLOADED** tab.
3. Touch the app you want to uninstall.
4. Touch the **Uninstall** button.
A pop-up displays the message **Application will be uninstalled**.
5. Touch **Uninstall** to confirm you want to uninstall the app.

You can also use Google Play to uninstall apps you downloaded from there (see “*Play Store*” on page 75).

Tip: To uninstall updates to pre-installed apps, touch the app and touch **Uninstall updates**. A pop-up displays the message **All updates to this Android system app will be uninstalled**. Touch **OK** to uninstall the updates.

To uninstall an app from the Apps screen:

1. From a Home screen, touch .
2. Touch  **Menu** → **Uninstall/disable apps** to display the Uninstall screen.
– or –
Touch  **Download** and then touch  **Menu** → **Uninstall**.
A  appears on Apps that can be uninstalled or disabled.
3. Touch an app's icon and then touch **OK** to uninstall and remove the app from your tablet.

Note: You cannot uninstall pre-loaded apps. You can only uninstall the apps you have downloaded.

Samsung Kies

Samsung Kies is a software that enables you to update your device firmware, synchronize files, and transfer data to and from your device directly by connecting to your computer.

To learn more about Samsung Kies and to download the software (PC and Mac), visit samsung.com/kies.

Synchronizing with Windows Media Player

Ensure that Windows Media Player is installed on your PC.

1. Attach your device to the computer with the USB cable. Your computer recognizes the connection and displays the Auto Play screen. (If the Auto Play screen does not appear, manually launch the program.)
2. Click the option to **Sync digital media files to this device** to synchronize music files.
3. Select and drag the music files you want to the sync list and begin synchronizing.
4. When finished, exit Windows Media Player and disconnect the USB cable.

Connecting as a Mass Storage Device

You can connect your device to a PC as a removable disk and access the file directory. If you insert a memory card in the device, you can also access the files directory from the memory card by using the device as a memory card reader.

Note: The file directory of the memory card displays as **Card**, separate from the internal memory, which is **Tablet**.

1. Insert a memory card into the device to transfer files from or to the memory card.
2. Attach your device to the computer with the USB cable. Your computer recognizes the connection and displays the AutoPlay screen.
3. Click the option to **Open device to view files**. You should see a Card and a Tablet folder.
4. Copy files from the PC to the memory card (Card folder).
5. When finished, close the PC folder and disconnect the USB cable.

Section 9: Settings

About Settings

Use this application to configure the device, set application options, and add accounts.

Accessing Settings

- From a Home screen, touch  →  **Settings**.

– or –

From any screen, touch the top of the screen and swipe downward, to display the Notification Panel, and then touch  **Settings**. For more information, refer to “*Notification Panel*” on page 21.

The Settings screen displays.

Settings Tabs

The Settings are divided into four main groups. When the Settings screen displays, the following four tabs are located at the top of the screen.

Connections

Control your device’s wireless connections. For more information, refer to “*Connections*” on page 92.

Device

Personalize your device, including sounds and the display, accessibility, and input. For more information, refer to “*Device*” on page 98.



Controls

Access settings to configure Language and input, Voice control, Motions, Palm motion, and Smart screen. For more information, refer to “*Controls*” on page 107.

General

Create and modify your accounts (such as, Email, Google Account, Samsung Account, and so on). Manage security, location services, storage, and other features of the device. For more information, refer to “*General*” on page 111.

The Settings Screen

Some options are enabled or disabled by touching the **OFF/ON** button to turn the option ON  or OFF .

For some options, you must touch the field, such as Wi-Fi, to display and set more options.

Some options are enabled or disabled by touching a check box. When enabled, a  check mark displays. Touch the check mark to remove it and disable the option.

Connections

Control your device's wireless connections.

Wi-Fi

Wi-Fi is a wireless networking technology that provides access to local area networks. Your device supports Wi-Fi 802.11 a/b/g/n/ac.

For more information about using your device's Wi-Fi features, see “*Wi-Fi*” on page 79.

Wi-Fi Direct Settings

Wi-Fi Direct allows device-to-device connections so you can transfer large amounts of data over a Wi-Fi connection.

For more information about using Wi-Fi Direct, see “*Wi-Fi Direct*” on page 82.

Bluetooth

Bluetooth is a short-range wireless communications technology for exchanging information over a distance of about 30 feet.

For more information about using Bluetooth, see “*Bluetooth*” on page 83.

Airplane Mode

Airplane mode allows you to use many of your tablet's features, such as the camera, music and video apps, etc. when you are in an airplane or in any other area where accessing data networks is prohibited.

Important! When your tablet is in Airplane mode, it cannot access online information or applications.

- Press and hold the **Power/Lock Key** then touch **Airplane mode**.

– or –

Touch the top of the screen and swipe downward, to display the Quick Settings, and then touch **Airplane mode**.

For more information, refer to “*Notifications*” on page 21.

– or –

Touch  **Settings** → **Connections** tab → **Airplane mode**, and then touch the **OFF/ON** button to turn Airplane mode ON .

Data Usage

View your Wi-Fi data usage.

1. From the **Settings** screen, touch **Connections** tab → **Data usage**.
2. Touch the **Data usage cycle** drop-down menu and select a date.

The data usage displays as a visual (chart) and also displays a list of each application with a breakdown of data usage by application.

- Slide the vertical bars over the graphic to adjust the date.

Note: Data is measured by your device. Your service provider may account for data usage differently.

3. Touch  **Menu** for options:
 - **Auto sync data:** Automatically sync data. Disabling auto sync will reduce data usage and conserve battery power, but notifications and updates will need to be manually synchronized.
 - **Mobile hotspots:** Display all mobile hotspots near you.

Location Services

You must enable location services on your device for apps (such as Google Maps) to use your location.



Note: Some apps may require one or more location services be turned on for full functionality.

1. From the **Settings** screen, touch **Connections** tab → **Location**.
2. Touch the **OFF/ON** button to turn Location services ON .
3. Touch **Mode** to select how your location is determined:
 - **High accuracy:** Use GPS, Wi-Fi, and mobile networks.
 - **Power saving:** Use Wi-Fi and mobile networks (no GPS).
 - **GPS only:** Use GPS only.
4. Apps that have requested your location are listed under *Recent location requests*. Touch an entry to view its settings.

Location Reporting



Google uses Location Reporting to store and use your device's most recent location data. Google apps, such as Google Maps, can use this data to improve your search results based on places that you have visited.

To manage your Location Reporting settings:

1. From the **Settings** screen, touch **Connections** tab → **Location**.
2. Touch the **OFF/ON** button to turn Location services ON .
3. Touch **Google Location Reporting** for options:
 - **Location Reporting:** Allow Google apps to use your device's most recent location data. Touch the OFF/ON button to turn Location Reporting ON .
 - **Location History:** Allow Google to store a history of your location data. Touch the OFF/ON button to turn Location History ON . Touch **DELETE LOCATION HISTORY** to permanently delete your location history.

My Places

You can save your favorite locations for use with services that require location information. This information can improve your search results and other location-related activities.

1. From the **Settings** screen, touch **Connections** tab → **Location**.
2. Touch the **OFF/ON** button to turn Location services ON .
3. Touch **My places**.
4. Touch a category (Home, Office, or Car) to add a location:
 - Touch **Select method** to select how your location is determined for that particular place.
 - Touch **Save**.
5. Touch  **Add** to add additional categories.
6. Touch  **Menu** → **Delete** to delete a custom category.

Note: Home, Office, and Car cannot be deleted.

More Networks

This option displays additional Connectivity information.

- From the **Settings** screen, touch **Connections** → **More networks**.

The following options display.

Printing

To manage your printers:

1. From the **Settings** screen, touch **Connections** tab → **More networks** → **Printing**.
2. Touch a print service to configure.

VPN

The VPN settings menu allows you to set up and manage Virtual Private Networks (VPNs).

Adding a VPN

Note: You must set a screen lock PIN or password before setting up a VPN. For more information, refer to “*Screen Security*” on page 100.

1. From the **Settings** screen, touch **Connections** tab → **More networks** → **VPN**.
2. Touch  **Add**.
3. Enter the information provided by your network administrator.
4. Touch **Save** to save your VPN settings.

Connecting to a VPN

1. From the **Settings** screen, touch **Connections** tab → **More networks** → **VPN**.
2. Touch the VPN to which you want to connect.
3. In the pop-up window, enter any requested credentials.
4. Touch **Connect**.

Edit or Delete a VPN

1. From the **Settings** screen, touch **Connections** tab → **More networks** → **VPN**.
2. Touch and hold the VPN that you want to edit or delete.
3. In the pop-up window, touch:
 - **Edit network**, make the desired VPN setting changes, and touch **Save**.
 - or –
 - **Delete network** to delete the VPN.

VPN Options

- Touch  **Menu** → **Always-on VPN** to select a VPN profile to always stay connected.

Ethernet

Manage your ethernet connection and ethernet device.

1. From the **Settings** screen, touch **Connections** tab → **More networks** → **Ethernet**.
2. Touch **Ethernet** and follow the onscreen instructions to connect to an ethernet network.

Nearby Devices

This option allows you to share your media files with nearby DLNA (Digital Living Network Alliance) enabled devices.



Warning! If file sharing is enabled, other devices can access your data. Use this option with care.

1. From the **Settings** screen, touch **Connections** tab → **Nearby devices**.
2. Touch the **OFF/ON** button to turn Nearby devices ON . The device name displays under Device name.
3. In the Advanced section, set the following options:
 - **Shared contents:** Select the content to share. Choices are: Videos, Photos, and Music.
 - **Allowed devices list:** Indicate the devices accessible to your device.
 - **Denied devices list:** Indicate the devices not accessible to your device.
 - **Download to:** Set whether to download data to Device or SD card.

- **Download from other devices:** If a nearby device attempts to download data, this setting indicates the response. Options are: Always accept, Always ask, and Always reject.

Screen Mirroring

To share your device's screen with another device, enable Screen Mirroring.

1. From the **Settings** screen, touch **Connections** tab → **Screen Mirroring**.
 2. Touch the **OFF/ON** button next to **Share your device's screen with another device** to turn Screen Mirroring ON . Available devices are listed.
 3. Touch **Scan** to find more devices.
- Touch  **Menu** → **Help** for more information.

Device

This section of the Settings screen contains settings for your device.

Sound

Volume

Set the volume level for all types of sounds.

1. From the **Settings** screen, touch **Device** tab → **Sound** → **Volume**.
2. Touch and drag the sliders to set the volume for:
 - **Music, video, games and other media:** Sounds made by music apps, video apps, and more.
 - **Notifications:** Sounds for alerts to new messages and other events.
 - **System:** Application sounds and other sounds made by your device.

Tip: You can also set System volume from a Home screen by pressing the **Volume Key**.

Notifications

Select a default sound for message, alarm, and other notifications.

1. From the **Settings** screen, touch **Device** tab → **Sound** → **Notifications**.
2. Touch sound to hear a sample and select it.

Feedback

Set touch screen sound and screen lock sounds.

- From the **Settings** screen, touch **Device** tab → **Sound**.

The following options are available:

- **Touch sounds:** Play a sound when you touch the screen.
- **Screen lock sound:** Play a sound when your screen is locked or unlocked.

Samsung Applications

Set your applications' notification sound settings.

1. From the **Settings** screen, touch **Device** tab → **Sound**.
2. The following options are available:
 - **Email:** Touch an account to adjust its notification settings.
 - **Calendar:** Configure your event notifications.

Samsung Keyboard

Set Samsung keyboard sounds.

1. From the **Settings** screen, touch **Device** tab → **Sound**.
2. **Sound when tapped:** Enable auditory feedback when you touch an onscreen key.

More Settings

Find the best sound and audio settings for you.

1. From the **Settings** screen, touch **Device** tab → **Sound** → **Adapt Sound**.
2. Read the instructions and touch **Start** when you are ready to begin.

Display

Use the Display settings to configure the way your device's screen operates.

- From the **Settings** screen, touch **Device** tab → **Display**.

The following options are available:

- **Brightness:** Touch and drag the slider to set the brightness.
- **Screen timeout:** Set the length of delay between the last key press or screen touch and the automatic screen timeout (dim and lock).
- **Daydream:** Set the device to launch a screen saver when your device is connected to a desktop dock or charging. Touch the **OFF/ON** button to turn Daydream ON . Touch **Daydream** for additional options.
- **Show battery percentage:** Set the device to display the remaining battery life on the Status Bar.

Multi Window

Set the device to use Multi window.

1. From the **Settings** screen, touch **Device** tab → **Multi window**.
2. Touch the **OFF/ON** button to turn Multi window ON .
3. Touch **Open in multi window view** to automatically view content in a multi window when you open files from My Files or Video, or attachments from email and messages.

For more information, refer to “*Multi Window*” on page 19.

Lock Screen

Screen Security

Choose settings for unlocking your screen. For more information about using the lock and unlock features, see “*Securing Your Device*” on page 8.

1. From the **Settings** screen, touch **Device** tab → **Lock screen**.
2. Touch **Screen lock** for these settings:
 - **Swipe**: Swipe the screen to unlock it. This option provides no security.
 - **Pattern**: A screen unlock pattern is a touch gesture you create and use to unlock your device.
 - **PIN**: Select a PIN to use for unlocking the screen.
 - **Password**: Create a password for unlocking the screen.
 - **None**: Do not lock the screen.

Note: Additional options are available based on the Screen lock selected.

Swipe Options

The options are available when Swipe is selected:

- **Clock widget options:** Set the size of the Clock widget that is displayed on your Home screens, and whether to show the date.
- **Shortcuts:** Set shortcuts to appear at the bottom of the Lock screen.
- **Personal message:** Display a personal message.
- **Owner Information:** Show owner information on the lock screen.
 - Touch **Owner information** and then touch **Show owner info on lock screen** to enable or disable the option.
 - Touch the text field and enter the owner information to display.
- **Unlock effect:** Set the effect you receive when unlocking the tablet. You can select None, Watercolor, or Ripple.
- **Help text:** Show help information on the Lock screen.

Pattern Options

The options are available when Pattern is selected:

- **Clock widget options:** Set the size of the Clock widget that is displayed on your Home screens, and whether to show the date.
- **Personal message:** Display a personal message.
- **Owner Information:** Show owner information on the lock screen.
 - Touch **Owner information** and then touch **Show owner info on lock screen** to enable or disable the option.
 - Touch the text field and enter the owner information to display.
- **Make pattern visible:** See the pattern as you draw it.
- **Lock automatically:** Set how quickly to lock the screen after the screen automatically turns off.
- **Lock instantly with power key:** Use this option to enable the Lock screen when the Power Key is pressed. If this option is not enabled, the screen dims or brightens when the Power Key is pressed.

PIN Options

The options are available when PIN is selected:

- **Clock widget options:** Set the size of the Clock widget that is displayed on your Home screens, and whether to show the date.
- **Personal message:** Display a personal message.
- **Owner Information:** Show owner information on the lock screen.
 - Touch **Owner information** and then touch **Show owner info on lock screen** to enable or disable the option.
 - Touch the text field and enter the owner information to display.
- **Lock automatically:** Set how quickly to lock the screen after the screen automatically turns off.
- **Lock instantly with power key:** Use this option to enable the Lock screen when the Power Key is pressed. If this option is not enabled, the screen dims or brightens when the Power Key is pressed.

Password Options

The options are available when Password is selected:

- **Clock widget options:** Set the size of the Clock widget that is displayed on your Home screens, and whether to show the date.
- **Personal message:** Display a personal message.
- **Owner Information:** Show owner information on the lock screen.
 - Touch **Owner information** and then touch **Show owner info on lock screen** to enable or disable the option.
 - Touch the text field and enter the owner information to display.
- **Lock automatically:** Set how quickly to lock the screen after the screen automatically turns off.
- **Lock instantly with power key:** Use this option to enable the Lock screen when the Power Key is pressed. If this option is not enabled, the screen dims or brightens when the Power Key is pressed.

Wallpaper

You can choose a picture to display on the Home screen, Lock screen, or on both the Home and Lock screens. Choose from preloaded wallpaper images or select a photo you have downloaded or taken with the Camera.

1. From the **Settings** screen, touch **Device** tab → **Wallpaper**.
2. Touch **Home Screen**, **Lock screen**, or **Home and lock screens**. The Select wallpaper from screen displays the following options: **Gallery**, **Live wallpapers** (Home screen only), **Photos** (Home screen only), and **Wallpapers**.

For more information, refer to “*Wallpapers*” on page 25.





Font

Set the font for screen displays and the size you want it to display.

1. From the **Settings** screen, touch **Device** tab → **Font**.
2. Touch **Font style** and select a font or touch **Download** to browse and download a new font.
3. Touch **Font size** and select a font size.

Notification Panel

Customize the Notification Panel.

1. From the **Settings** screen, touch **Device** tab → **Notification panel**.
2. Touch **Brightness and volume** to create a check mark if you want to be able to adjust the screen brightness and volume from the Notification Panel.
3. Touch the **OFF/ON** button to turn Recommended apps ON  to show recommended apps on the Notification Panel after certain actions. Touch **Recommended apps** for options:
 - **Earphones**: Touch  to select which apps to display on the Notification Panel when you insert earphones.
 - **Docking**: Touch  to select which apps to display on the Notification Panel when you insert earphones.
 - Touch **Most used** to display your most used apps on the Notification Panel.
4. To customize which quick setting buttons appear at the top of the Notification Panel, touch and drag buttons to reorder them. Touch  use the default layout.

For more information, refer to “*Notification Panel*” on page 21.

Accessibility

Accessibility services are special features to make using the device easier for those with certain physical disabilities. Use the Accessibility settings to activate these services.

Note: You can download accessibility applications from the Google Play and manage their use here.

1. From the **Settings** screen, touch **Device** tab → **Accessibility**.
2. Configure the following settings:

Accessibility

- **Auto rotate screen:** Set the screen orientation to automatically change when you rotate the device. When not enabled, the screen orientation locks in the current orientation (landscape or portrait) and the orientation does not change when you rotate the device.

Tip: From any screen, touch the top of the screen and swipe downward, to display the Quick Settings screen. Touch **Screen rotation** to enable or disable the auto rotate feature. For more information, refer to *“Notification Panel”* on page 21.



- **Screen timeout:** Select the screen delay time the screen delays shutting off after inactivity for the selected period of time.
- **Lock automatically:** This option only appears when certain Screen locks are enabled. For more information, refer to *“Lock Screen”* on page 100.
- **Speak passwords:** Speaks passwords to enter them.
- **Single tap mode:** Tap to stop/snooze alarms, calendar events, and timer alerts, and to accept/reject incoming calls.
- **Show shortcut:** Set this option to display an Accessibility shortcut on the Device options pop-up when you press and hold the power key.
- **Manage accessibility:** Save and update your accessibility settings or share them with another device. You can export your settings, import a previously saved file, or share your file with another device.

Services

- **TalkBack:** Activate the TalkBack feature, which speaks feedback aloud to help blind and low-vision users.

Important! TalkBack can collect all of the text you enter, except passwords, including personal data and credit card numbers. It may also log your user interface interactions with the device.

Vision

- **Font size:** Set the font size.
- **Magnification gestures:** Use exaggerated gestures such as triple-tapping, double pinching, and dragging two fingers across the screen. Touch the **OFF/ON** button to turn the feature ON .
- **Negative colors:** Reverse the display of onscreen colors from White text on a Black background to Black text on a White background.
- **Notification reminder:** Play a beep when a notification for a call, message, and so on, has been missed. Touch the **OFF/ON** button to turn it ON .

- **Accessibility shortcut:** Quickly enable accessibility features in two quick steps. Touch the **OFF/ON** button to turn the feature ON .
- **Text-to-speech options:** Set your preferred TTS engine. Touch **Speech rate** to set the speed at which the text is spoken. Touch **Listen to an example** to play a short speech demonstration. For more information, refer to “*Speech*” on page 109.

Hearing

- **Sound balance:** Use the slider to set the Left and Right balance when using a stereo device.
- **Mono audio:** When Mono audio is enabled, you can listen through one earphone to mono audio sound.
- **Turn off all sounds:** Turn off all sounds including receiver voice.
- **Google subtitles (CC):** Use Google subtitles with multimedia files when available. Touch the **OFF/ON** button to turn the feature ON . Touch **Google subtitles (CC)** for options.

- **Samsung subtitles (CC):** Use Samsung subtitles with multimedia files when available. Touch the **OFF/ON** button to turn the feature ON . Touch **Samsung subtitles (CC)** for options.

Dexterity

- **Assistant menu:** Improve the device accessibility for users with reduced dexterity. Touch the **OFF/ON** button to turn the feature ON . Follow the onscreen instructions.
- **Press and hold delay:** Select a time interval for this gesture.

Recognition

- **Interaction control:** Enable or disable motions and screen timeout. You can also block areas of the screen from touch interaction. Touch the **OFF/ON** button to turn the feature ON . Follow the onscreen instructions.

Blocking Mode

Turn off notifications for selected features.

1. From the **Settings** screen, touch **Device** tab → **Blocking mode**.
2. Touch the **OFF/ON** button to turn Blocking mode ON .
3. Touch **Turn off notifications** to block all notifications.
4. Touch **Turn off alarm** to block all alarms.
5. The Set time option allows you to set Blocking mode for a specific time range or Always. Touch the **Always** field to disable it and configure the **From** and **To** time fields.

Note: When Blocking Mode is enabled,  displays in the Status Bar.

Controls

Access settings to configure Language and input, Voice control, Motions, Palm motion, and Smart screen.

Language and Input

Language

Set the language used by your device.



1. From the **Settings** screen, touch **Controls** tab → **Language and input** → **Language**.
2. Touch a language/locale from the list.

Keyboards and Input Methods

Set the keyboard used by your device.

1. From the **Settings** screen, touch **Controls** tab → **Language and input** → **Default**.
2. Select a keyboard. (Samsung keyboard is the only selection available for this device.)
3. Touch **Set up input methods**.

Configuring the Samsung Keyboard

1. From the **Settings** screen, touch **Controls** tab → **Language and input**.
2. Touch  next to Samsung keyboard to display the following options:
 - **Select input languages:** Used to set a default text entry language. Touch this field, scroll through the options, and touch the desired input language.
 - **Predictive text:** Allow Predictive text to suggest words matching your text entries, and, optionally, complete common words automatically. Touch the **OFF/ON** button to turn Predictive text ON . Touch **Predictive text** for options:
 - **Live word update:** Automatically update with popular new words every day.
 - **Personalized data:** Enter personalized data to improve prediction results.
 - **Learn from Facebook:** Log in to let your device learn your Facebook style.
 - **Learn from Gmail:** Log in to let your device learn your Gmail style.

- **Learn from Twitter:** Log in to let your device learn your Twitter style.
- **Learn from Contacts:** Allow your device to learn your Contacts style.
- **Clear remote data:** Delete your anonymous data stored on the personalization server.
- **Clear personal data:** Remove all personalized data entered.
- **Privacy Policy:** Read the privacy policy regarding Predictive Text and the use of your personalization data.
- **Auto replacement:** Complete or replace the word you are typing with the most probable word when you touch the space bar. Touch the **OFF/ON** button to turn it ON .
- **Auto capitalization:** Automatically capitalize the first letter of sentences.
- **Auto spacing:** Automatically insert spaces between words.
- **Auto punctuate:** Automatically insert a full stop by tapping the space bar twice.
- **Keyboard swipe:**
 - **None:** Disable the keyboard swipe feature.
 - **Continuous input:** Enter text by sliding your finger across the keyboard.
 - **Cursor control:** Slide your finger across the keyboard to move the cursor to begin entering text.
- **Key-tap feedback:**
 - **Sound:** Play sounds when a key is touched.
 - **Character preview:** Display the character in a bubble when you touch it on the keyboard.
- **More settings:**
 - **Help:** Access help information for using the Samsung keyboard.
 - **Reset settings:** Reset Samsung keyboard settings.

Google Voice Typing

1. From the **Settings** screen, touch **Controls** tab → **Language and input**.
2. Touch **Google voice typing** to automatically use Google voice typing.
3. Touch  next to Google voice typing.

The following options are available:

- **Choose input languages:** Select languages for Google voice typing. Touch **Automatic** to use the Default language exclusively, or choose other languages.
- **Block offensive words:** Hide words many people find offensive are in results of Google voice searches. Offensive words are replaced in results with a placeholder (####).
- **Offline speech recognition:** Download and install speech recognition engines, allowing you to use voice input while not connected to the network, such as during Airplane mode. Touch the **All** tab to download speech recognition for other languages.

Speech

Set voice search and text-to-speech options.

Voice Search

1. From the **Settings** screen, touch **Controls** tab → **Language and input**.
2. Touch **Voice search** to configure:
 - **Language:** Choose a language for your voice input.
 - **Speech output:** Always provides audible readout of text, only when using Hands-free functions, or never.
 - **Block offensive words:** Block recognized offensive words from the results of your voice-input Google searches.
 - **Hotword detection:** Say “Ok Google” to launch a voice search.
 - **Offline speech recognition:** Enable voice input while offline. Touch the **All** tab to download speech recognition for other languages.
 - **Bluetooth headset:** Record audio through a Bluetooth headset, if available.

Text-To-Speech Options

1. From the **Settings** screen, touch **Controls** tab → **Language and input**.
2. Touch **Text-to-speech options** and select the preferred TTS engine.
3. Touch  next to the preferred TTS engine and configure.
4. Under General, configure the following:
 - **Speech rate:** Set the speed at which the text is spoken.
 - **Listen to an example:** Play a sample of speech synthesis (available if voice data is installed).
 - **Default language status:** Display the default language in use.

Mouse/Trackpad

Set your pointer speed for an external mouse or trackpad (not included).

1. From the **Settings** screen, touch **Controls** tab → **Language and input**.
2. Touch **Pointer speed** and drag the slider to the right to go faster or to the left to go slower.

Palm Motion

Activate the palm motion feature to control the device by touching the screen with the palm of your hand.

1. From the **Settings** screen, touch **Controls** tab → **Palm motion**.
2. Touch the **OFF/ON** button to turn the feature ON .
3. Configure the following options (touch each option for details):
 - **Capture screen:** Capture an image of the screen when you sweep your hand left or right across the screen.
 - **Mute/pause:** Set the device to pause media playback when you touch the screen with your palm.

Smart Screen

Use the Smart screen options to customize your screen settings to make the screen more responsive and easier to use.

- From the **Settings** screen, touch **Controls** tab → **Smart screen**. The following option display:
 - **Smart stay**: Set the screen to stay on as long as you look at it.

General

Create and modify your accounts (such as, Email, Google Account, Samsung Account, and so on). Manage security, location services, storage, and other features of the device.

Accounts

Set up and manage accounts, including your Google Accounts, Samsung accounts, and email accounts.

Your device can synchronize information from a variety of accounts, including Email, Facebook, Google, and your Samsung account. Depending on the account, you can choose to synchronize your calendar, contacts, and other types of content.

With synchronization, you can ensure that the information on your device is updated with any information that changes in your accounts.

Adding an Account



1. From the **Settings** screen, touch **General** tab → **Accounts** → **Add account**.
2. Touch one of the account types.
3. Follow the prompts to enter your credentials and set up the account.

Tip: For more information about the types of accounts that you can add, see “Accounts” on page 33.

Managing Accounts

To view the accounts you have added:

1. From the **Settings** screen, touch **General** tab → **Accounts** → <account>.
The <account> is either a Google account, Samsung account, or some other account you have added, such as Email.
2. Touch **Sync all** to synchronize all accounts listed.
Touch **Cancel sync** to stop the synchronization.

3. Touch an account to view the sync settings for that account.
 - Touch  **Menu** → **Sync now** to synchronize all data for the selected account.
 - or –
 - Touch the account data to synchronize, such as, Calendar, Contacts, and so on.
 - To remove the account, touch  **Menu** → **Remove account** and then touch **Remove account** at the prompt to remove the account and delete all its messages, contacts, and other data.
4. For Google Accounts, touch one of the items listed under Privacy to view various settings for that item.
 - or –
 - For Samsung accounts, touch **Account settings** to manage Samsung account settings or **Backup** to set Samsung account back up and restore options.
 - or –
 - For Email accounts, touch **Settings** to manage various settings for that account.

Cloud

Back up your personal data using your Samsung Account or use Dropbox to sync your device content.

1. From the **Settings** screen, touch **General** tab → **Cloud**.
2. Under **Personal data**:
 - If you have not signed in to your Samsung Account, touch **Add account**. For more information about Samsung accounts, see “*Cloud*” on page 113.
 - If you have signed in to your Samsung Account:
 - Touch your Samsung Account to manage your sync settings or remove your Samsung Account.
 - Touch **Storage usage** to show the storage used and the remaining storage available.
 - Touch **Sync settings** to sync your calendar, contacts, Internet, S Note, and Scrapbook settings with your Samsung Account.
 - Touch **Backup** to manage your back up and restore options.
 - Touch **Restore** to retrieve data from your Samsung account.

3. Under **Dropbox**:

- If you have not signed in to your Dropbox account, touch **Link Dropbox account**.
- If you have signed in to your Dropbox Account, then follow the prompts to set up and use Dropbox.

For more information, refer to “*Dropbox*” on page 69.

Backup and Reset

Back up your data to the Google server and reset your device to its factory defaults.

Backup and Restore

To enable or disable backup of your information to the Google server.

1. From the **Settings** screen, touch **General** tab → **Backup and reset**.
2. Touch **Back up my data** to enable or disable back up of application data, Wi-Fi passwords, and other settings to the Google server.
Once the **Back up my data** option is enabled, then the **Backup account** and the **Automatic restore** options are available.
3. Touch **Backup account** and touch your Google Gmail account or touch **Add account** to set your Google Gmail account to be backed up to the Google server.
4. Touch **Automatic restore** to enable automatic restoration of settings from the Google server. When enabled, backed-up settings are restored when you reinstall an application.

Factory Data Reset

Reset to return your device to its factory defaults.

Warning! This action permanently erases **ALL** data from the device, including Google or other email account settings, system and application data and settings, and downloaded applications, as well as your music, photos, videos, and other files.

If you reset the tablet in this way, the next time you turn on your tablet you are prompted to reenter the same kind of information as when you first started Android.

1. From the **Settings** screen, touch **General** tab → **Backup and reset** → **Factory data reset**.
The Factory data reset screen displays reset information.
2. Touch **Reset device**, then follow the prompts to perform the reset.

Date and Time

By default, your device receives date and time information from the wireless network. When you are outside network coverage, you may want to set date and time information manually using the Date & time settings.

1. From the **Settings** screen, touch **General** tab → **Date and time**.
2. Configure the following settings:
 - **Set date:** Enter the current date (only available when the Automatic setting is disabled).
 - **Set time:** Enter the current time (only available when the Automatic setting is disabled).
 - **Select time zone:** Choose your local time zone (only available when the Automatic setting is disabled).
 - **Use 24-hour format:** Set the format for time displays.
 - **Select date format:** Set the format for date displays.

Accessory

To change accessory settings:

- From the **Settings** screen, touch **General** tab → **Accessory**.

Dock

- **Dock sound:** Play a sound when your device is connected to or removed from a desktop dock.
- **Audio output mode:** Use the dock speaker when your device is connected to a desktop dock.

Book Cover

- **Automatic unlock:** Flip the cover open to unlock the screen when secure lock is turned off.

Application Manager

You can download and install applications from Google Play or create applications using the Android SDK and install them on your device. Use Application manager settings to manage applications.

Warning! Because this device can be configured with system software not provided by or supported by Google or any other company, end-users operate these devices at their own risk.

Memory Usage



See how memory is being used by Downloaded or Running applications.

1. From the **Settings** screen, touch **General** tab → **Application manager**.
2. Touch **DOWNLOADED**, **SD CARD**, **RUNNING**, or **ALL** to display memory usage for that category of applications.

The graph at the bottom of the **DOWNLOADED** tab shows used and free device memory. The graph at the bottom of the **RUNNING** tab shows used and free RAM.

Downloaded

Displays apps you have downloaded onto your device.

1. From the **Settings** screen, touch **General** tab → **Application manager**.
2. Touch **DOWNLOADED** to view a list of all the downloaded applications on your device.
3. To switch the order of the **DOWNLOADED** list, touch  **Menu** → **Sort by size** or **Sort by name**.
4. To reset your application preferences, touch  **Menu** → **Reset app preferences**.
5. Touch an application to view and update information about the application, including memory usage, default settings, and permissions.



The following options are displayed:

- **Force stop:** Stop an app that is misbehaving. Restart your device if stopping an app, process, or service causes your device to stop working correctly.
- **Uninstall:** Delete the application from the tablet. For more information, refer to *“Installing Applications”* on page 76.

- **Move to SD card:** Move this app to your microSD card.
- **Clear data:** Clear application data from memory.
- **Clear cache:** Clear an app's temporary memory storage.
- **Clear defaults:** Clear an app's customization.
- **Permissions:** View information about the app's access to your device and data.

SD Card

Displays apps you have downloaded onto your SD card.

1. From the **Settings** screen, touch **General** tab → **Application manager**.
2. Touch **SD CARD** to view a list of all the downloaded applications on your device.
3. To switch the order of the SD CARD list, touch  **Menu** → **Sort by size** or **Sort by name**.
4. To reset your application preferences, touch  **Menu** → **Reset app preferences**.

Note: When you Reset app preferences, you will not lose any app data.

5. Touch an application to view and update information about the application, including memory usage, default settings, and permissions.

Running Services

View and control services running on your device.

1. From the **Settings** screen, touch **General** tab → **Application manager**.
2. Touch the **RUNNING** tab.
All the applications that are currently running on the device display.
3. Touch **Show cached processes** to display all the cached processes that are running. Touch **Show services in use** to switch back.

4. Touch one of the applications to view application information.

The following options display:

- **Stop:** Stops the application from running on the device. This is usually done prior to uninstalling the application.

Warning! Not all services can be stopped. Stopping services may have undesirable consequences on the application or Android System.

- **Report:** Report failure and other application information.

Note: Options vary by application.

Default Applications

Set and manage your default applications.

1. From the **Settings** screen, touch **General** tab → **Default applications**.
2. Touch an app to set it as the default application.
– or –
Touch **Clear** to remove the app.

Users

Shared this tablet with multiple people by creating User accounts and Profiles.

- **Users** have their own space, which they can customize with their own apps, wallpaper, and so on. Users can also adjust tablet settings like Wi-Fi that affect everyone.
- **Restricted profiles** are restricted accounts that allow only limited access to apps and content.

Setting Up Users and Profiles

By setting up multiple user profiles, several users can share the device without affecting the personal settings of others, such as email accounts, wallpaper preferences, and more.

1. From the **Settings** screen, touch **General** tab → **Users**.
2. Touch  **Add user** and select **User** or **Restricted profile**.
3. Follow the onscreen prompts to set up the account.

Changing Users

To access the device with a user profile, select a profile at the top right of the locked screen.





Tip: You can also switch between users by sliding down the Notification Panel and touching the current user.

Change User Account Nicknames and Photo IDs

The photo and name each user uses in their personal Contact entry (listed under ME at the top of their Contacts list) is used as their User account ID.

To change a user's photo or name:

1. Touch  **Contacts**.
2. Touch their personal Contact entry to edit their Contact information. For more information, refer to “*My Personal Contact*” on page 37.
– or –
1. From the **Settings** screen, touch **General** tab → **Users**.
2. Touch  **Menu** and edit the user's personal Contact entry.

Deleting a User or Profile

Each user can only delete their own account, while the Owner can delete any user account.

If you are the Owner:

1. From the **Settings** screen, touch **General** tab → **Users**.
2. Touch a user, and then touch  **Delete**.

If you are a User:

1. From the **Settings** screen, touch **General** tab → **Users**.
2. Touch  **Menu** → **Delete [user] from this device**.

Battery

See how much battery power is used for device activities.

1. From the **Settings** screen, touch **General** tab → **Battery**.

The battery level displays as a percentage. The amount of time the battery has been used also displays.

Battery usage displays in percentages per application.

2. Touch **Screen, Android System, or Android OS** to view how the display and the Android system are affecting battery use.

Note: Other applications may be running that affect battery use.

3. Touch  **Refresh** to update the listing.
4. Touch **Show battery percentage** to display the device battery status next to the battery icon.

Power Saving Mode

When enabled, your device automatically analyzes the screen and adjusts the brightness to conserve battery power.

1. From the **Settings** screen, touch **General** tab → **Power saving mode**.
2. Touch the **OFF/ON** button to turn the feature ON 
3. Turn Power saving on and touch the Power saving mode settings (CPU power saving or Screen power saving) to enable or disable them.
4. Touch **Learn about power saving** to display more information about conserving power.

Storage

View the device memory and usage, or mount, unmount, or format an optional memory card (not included).

Device Memory

- From the **Settings** screen, touch **General** tab → **Storage**. The Device memory displays as Total space, System memory, Used space, Cached data, Miscellaneous files, and Available space.

SD Card

Once a memory card has been installed in your device, the card memory displays as Total space and Available space.

Mounting an SD Card

When you install a memory card, it is automatically mounted (connected to the tablet) and prepared for use. However, should you unmount the card without removing it from the tablet, you will need to mount it before it can be accessed.

1. Install an SD card. For more information, refer to “*Installing a Memory Card*” on page 8.
2. From the **Settings** screen, touch **General** tab → **Storage**.
3. Touch **Mount SD card**.

Unmounting an SD Card

Important! To prevent damage to information stored on the memory card, always unmount the card before removing it from the device.

1. From the **Settings** screen, touch **General** tab → **Storage**.
2. Touch **Unmount SD card**.
3. At the prompt, select **OK** to safely unmount the memory card.
4. Remove the SD card from the slot. For more information, refer to “*Galaxy Tab Accessories*” on page 8.

Important! Unmounting an SD card will stop some applications from functioning. Applications may not be available until you mount the SD card again.

Removing a Memory Card

Important! To prevent damage to information stored on the memory card, unmount the card before removing it from the device.

1. From the **Settings** screen, touch **General** tab → **Storage**.
2. Under *SD card*, touch **Unmount SD card** and then touch **OK**.
3. Open the memory card slot cover and turn to expose the slot.
4. Gently press inward on the memory card so that it pops out from the slot, and carefully pull the card out.
5. Close the memory card slot cover.

Formatting an SD Card

When formatting an SD card you will want to backup your music and photo files that are stored on the card because formatting the SD card deletes all the stored data.

1. From the **Settings** screen, touch **General** tab → **Storage**.
2. Touch **Format SD card** and then touch **Format SD card** again on the warning screen.
3. Touch **Delete all**.

Security

Use the Security settings to secure your device.

Encryption

To require a numeric PIN or password to decrypt your tablet each time you power it on or encrypt the data on your SD card each time it is connected:

1. From the **Settings** screen, touch **General** tab → **Security**.
2. Touch **Encrypt device**. For more information, read the displayed help screen.
3. Touch **Encrypt external SD card** to enable the encryption on SD card data that requires a password be entered each time the microSD card is connected.

Tip: Make sure your battery is charged more than 80 percent. Encryption takes an hour or more.

Find My Mobile

Use this option to allow your device to be locked and tracked, and for your data to be deleted remotely. You must sign up for a Samsung account and enable Google location service to use Remote controls.

Sign In to Your Samsung Account

1. From the **Settings** screen, touch **General tab** → **Security**.
2. Touch **Remote controls**. Read the information and touch **OK** to acknowledge the information.
3. Touch **Add account** to create a Samsung account. For more information about Samsung accounts, see “*Your Samsung Account*” on page 34.

Enable or Disable Remote Controls

Once you have signed in to your Samsung Account, you can enable or disable Remote controls.

1. From the **Settings** screen, touch **General tab** → **Security** → **Remote controls**.
2. Enter your Samsung account password in the pop-up **Enter password** field and touch **Done**. The Introduction to remote controls screen displays. Touch **Do not show for 90 days** to temporarily disable this screen.
3. Touch **OK**. The Remote controls screen displays.
4. Touch the **OFF/ON** button to turn the feature ON .
5. Touch **Use wireless networks** to enable location information using the wireless network.

Find My Mobile Web Page

To launch the Find My Mobile web page:

1. From the **Settings** screen, touch **General** tab → **Security** → **Go to the Find my mobile webpage**.
2. Select which application to launch the application. Touch **Internet** or **Chrome** and select **Always** or **Just once**. The *Find My Mobile* webpage displays.
3. Follow the onscreen instructions.

Passwords

Briefly display password characters as you touch them while entering passwords.

1. From the **Settings** screen, touch **General** tab → **Security**.
2. Touch **Make passwords visible** to enable the feature.

Device Administration

To add or remove device administrators:

1. From the **Settings** screen, touch **General** tab → **Security**.
2. Touch **Device administrators**.

To enable or disable installation of non-Google Play applications.

1. From the **Settings** screen, touch **General** tab → **Security**.
2. Touch **Unknown sources**.
An informational pop-up displays.
3. Read the message and touch **OK** to allow installation of non-Google Play applications.

Warning! Enabling this option causes your tablet and personal data to be more vulnerable to attack by applications from unknown sources.

4. To block or warn before installing apps that may cause harm, touch **Verify apps**.

Security Update Service

To set security update service settings:

1. From the **Settings** screen, touch **General** tab → **Security**.
2. Touch **Security policy updates** for these options:
 - **Automatic updates:** Automatically check for changes to the security policy and download any updates to improve security.
 - **Check for updates:** Check for updates manually.
3. Touch **Send security reports** to send security reports to Samsung via Wi-Fi for threat analysis.

Credential Storage

If a certificate authority (CA) certificate gets compromised or for some other reason you do not trust it, you can disable or remove it.

1. From the **Settings** screen, touch **General** tab → **Security**.
2. Touch **Storage type** to set a storage type for credential contents.
3. Touch **Trusted credentials**.

The trusted credentials screen has two tabs:

- **System:** Displays CA certificates that are permanently installed in the ROM of your device.
 - **User:** Displays any CA certificates that you installed, for example, in the process of installing a client certificate.
4. Touch a CA certificate to examine its details. A scrolling screen displays the details.

Scroll to the bottom of the details screen and touch **Turn off** to disable a System certificate.

Caution! When you disable a system CA certificate, the **Turn off** button changes to **Turn on**, so you can enable the certificate again, if necessary.

Touch **OK** to return to the certificate list.

5. Touch **Install from phone storage**, then choose a certificate and follow the prompts to install encrypted certificates stored on the USB storage.

Note: You must have installed a memory card containing encrypted certificates to use this feature.

6. Touch **Clear credentials** to erase the credential contents from the device and reset the password.

Note: This setting only appears if you have installed encrypted certificates.

About Device

View information about your device, including status, legal information, hardware and software versions, and battery use.

1. From the **Settings** screen, touch **General** tab → **About device**.
2. Touch items to view details:
 - **Software update:** Connect to the network and download new software updates for your device, if available.
 - **Status:** View Battery status, Battery level, IP address, Wi-Fi MAC address, Bluetooth address, Ethernet MAC address, Serial number, Up time, and Device status.
 - **Legal information:** Touch an option to display Open source licenses, Google and Samsung legal information, and Privacy Alert.
 - **Device name:** Enter the name for your device. (The default is the model number.)
 - **Model number:** Display your device's model number.
 - **Android version:** Display the firmware version of your device.

- **Kernel version:** Display the kernel version of your device.
- **Build number:** Display your device's build number.
- **SE for Android status:** Display Security Enhancements for Android status information.

Software Update

The Software Update feature enables you to use your device to connect to the network and download any new software directly to your device. The device automatically updates with the latest available software when you access this option.

Software Update Options

To register your device and check for a software update:

1. From the **Settings** screen, touch **General** tab → **About device** → **Software update**.
2. Touch **Update**.
Your device is connected to the server and a search is performed for a software update.
3. Touch **Auto update** to check for updates automatically.

A

- About Device** 127
- Accessibility Settings** 104
- Accessory Settings** 115
- Accounts** 33, 111
 - setting up 33
- Alarm** 65
 - delete 66
 - set 65
 - stop 66
- Antenna** 9
- Application Manager** 116
 - downloaded apps 116
 - memory usage 116
 - running services 117
 - SD card 117
- Applications** 64
 - access 65
 - GPS 64
 - uninstalling 89
 - updating 64

Apps

- adding to Home screen 24
- app information 26
- removing from Home screen 24
- shortcuts 24

Apps Screen

B

- Back Key** 15
- Backup and Reset** 114
 - backup and restore 114
 - factory data reset 114
- Battery** 5
 - charging 6
 - indicator 5
 - settings 120
 - show battery percentage 99
- Blocking Mode** 106
- Bluetooth** 83
 - accessing received files 87
 - disconnect or unpair 85
 - pairing with a device 84
 - receiving data 87

- reconnect 85
- sending information 86
- settings 88
- turning on or off 83

Buddy Photo Share

C

- Calculator** 66
- Calendar** 66
 - change calendar type 67
 - create event or task 66
 - options 67
 - sync with Google Calendar 67
- Camera** 55
 - applying filter effects 56
 - controlling the camera
 - remotely 57
 - etiquette 55
 - panoramic photos 56
 - recording video 57
 - settings 58
 - shooting modes 56

shortcuts 59
taking photos 55

Chrome 68

Cloud Settings 113

Contacts 34

add 34
delete 35
display options 36
exporting and importing 38
favorites 40
groups 39
linking 36
my personal contact 37
separate linked 37
sharing namecards 38
starred contacts 40
update 35

Covering Gesture 18

D

Data Usage 93

Date and Time Settings 115

Default Applications Settings 118

Device

Back Key 15
back, top, and bottom features 12
command keys 15
features and specifications 10
front and side features 11
Home Key 15
navigation 15
Recent Apps Key 15
screen rotation 17

Display

Using Negative Colors 105

Display Settings 99

font style and size 103
timeout 99

Double-Tapping Gesture 16

Downloads

managing 88

Dragging Gesture 16

Drive 68

Dropbox 69

E

Email

combined view 44
composing and sending 43
configuring accounts 42
delete account 44
forwarding 43
manage accounts 44
refresh accounts 44
replying 43
settings 44

Ethernet Settings 96

Events 66

F

Factory Data Reset 114

Find My Mobile 124

Finger Gestures 16

Fonts

settings 103

G

Galaxy Tab Accessories 8

Gallery 60

- delete 61
- edit images 61
- favorites 61
- playing videos 60
- set as wallpaper 62
- sharing images 61
- Tag Buddy 62
- tagging faces 62
- view images 60
- zoom in and out 60

Gestures

- finger 16

Gmail 45

- composing and sending 45
- refreshing your account 45
- set up account 45
- settings 46

Google

- Drive 68
- Gmail 45
- Google Account 34

Maps 71

Photos 73

Play Books 74

Play Games 74

Play Movies & TV 74

Play Music 74

Play Newsstand 75

Play Store 75

Voice Search 77

Google Now 69

Google Search 69

Google Settings 70

Google Voice Typing 31

- settings 109

GPS Applications 64

Groups

- add members 39
- creating 39
- delete 40
- remove member 39
- rename 40

H

Hancom Viewer 70

Handwriting 30

Help 70

Holding the Device 9

Home Key 15

Home Screen 13

- extended Home screens 14
- folders 25
- panels 14
- wallpaper 25

I

Icons, Status Bar 23

Infrared Blaster 12

Internet 71

- command keys 71
- searching the web via voice 71

K

Keys 15

- Back Key 15
- Home Key 15
- Recent Apps 15

L

Language and Input Settings 107

- select language 107

Location Services

- location reporting 94
- my places 95

Location Services Settings 94

Lock Screen 100

- Password options 102
- Pattern options 101
- PIN options 102
- screen security 100
- Swipe options 101

Locking and Unlocking

- locking the device manually 9
- unlocking the keypad 9

M

Maps 71

Memo 71

- browsing 72
- composing 72
- delete 72
- editing the category list 72

- print 72
- viewing 71

Memory Card 8

- formatting 123
- installing 8
- mounting 121
- removing 122
- unmounting 122

Messages

- email,Email 42
- Gmail 45
- types 42

Microphone 12

More Networks Settings 95

Motions

- device control 17
- screen rotation 17

Mouse/Trackpad Settings 110

Multi Window 19

- activate 19
- applications 20
- configuring apps 21
- panel 20

- panel configuration 20
- settings 100
- window controls 20

Multimedia 47

Music

- listening to 47

Music Player 48

- accessing 51
- controls 51
- options while playing 53
- play music 51
- playing music by mood 53
- playlist, add to 49
- playlist, change order of 50
- playlist, create 49
- playlist, delete 50
- playlist, manage 49
- playlist, remove song 50
- playlist, rename 50

My Files (App) 72

My Personal Contact 37

N

Namecards

sending 38

Nearby Devices

settings 97

status 23

Negative Colors 105

Netflix 73

Notification Panel 21

settings 103

Notifications 21

P

Pairing with Bluetooth 84

Palm Motion

Settings 110

Panning to Browse Gesture 17

Panoramic Photos 56

Photos

viewing in Gallery 60

Photos (App) 73

Pinching and Spreading Gestures 16

Play Books 74

Play Games 74

Play Movies & TV 74

Play Music 74

Play Newsstand 75

Play Store 75

Playlists

add songs 49

change order of 50

creating 49

delete 50

managing 49

remove songs 50

rename 50

Pop-Up Player 63

Power Saving Mode 121

Powering On and Off 7

Predictive Text 29

settings 107

Printing 95

R

Recent Apps Key 15

Remote Viewfinder 57

Reset Factory Data 114

S

S Voice 75

Samsung Account 34

Samsung Apps 76

Samsung Keyboard

common symbols 29

entering text 29

Google Voice Typing 29

handwriting 30

layout 30

Predictive text 29

Predictive text settings 107

upper and lower case letters 29

using 29

Samsung Kies 90

Screen

rotating 17

Screen Mirroring 97

Screen Saver 76

Screen Security 100

Screenshot, Capturing 18, 27

Security

locking and unlocking 8

locking your device manually 9

Security Settings 123

credential storage 126

device administration 125

- encryption 123
- Find My Mobile 124
- passwords 125
- remote controls 124
- security update service 126

Settings

- accessing 91
- Connections tab 91
- Controls tab 91
- Device tab 91
- General tab 91
- Location Services 94
- tabs 91
- the settings screen 92

Setup Wizard 7

Share Shot 57

Shooting Modes 56

Shortcuts

- adding to Home screen 24
- removing from Home screen 24

Shortcuts to Apps 24

Smart Screen Settings 111

Software Update 128

Sound Settings

- feedback 98
- more settings 99
- notifications 98
- Samsung Applications 99
- Samsung Keyboard 99
- volume 98

Speech Settings 109

Status Bar 23

- icons 23

Storage 121

- device memory 121
- SD card 121

Sweeping Gesture 18

Swipe Gesture 16

T

Tag Buddy 62

Taking Photos 55

Task Manager 27

Tasks 66

Text

- editing tools 31
- entering 28
- Samsung keyboard 29

Text-To-Speech Options 110

3.5mm Headset Jack 11

Tilting Gesture 17

Touch Gesture 16

Touch Screen 16

- finger gestures 16

Touching and Holding Gesture 16

Touchscreen

- covering gesture 18
- double-tapping gesture 16
- dragging gesture 16
- panning to browse gesture 17
- pinching and spreading gestures 16
- sweeping gesture 18
- swipe gesture 16
- tilting gesture 17
- touch gesture 16
- touching and holding gesture 16

Turning Your Device On and Off 7

U

USB Settings

mass storage device 90

User Manual 4

special text 4

text conventions 5

Users 118

account nicknames and photo

IDs 119

changing users 119

delete 120

setting up 118

V

Video

playing 60

recording 57

recording mode 57

remote viewfinder 57

settings 58

Share Shot 57

trimming segments of video 60

Video Player 62

zooming in and out 57

Video Buddy Photo Share 57

Video Player 62

delete 63

playing videos 62

Pop-Up Player 63

share 63

Voice Search 77

settings 109

Volume Key 12

VPN 96

adding 96

connecting to 96

edit or delete 96

options 96

W

Wallpaper 25

settings 103

WatchON 54

initial configuration 54

menu 54

Widgets 24

adding to Home screen 24

removing from Home screen 24

Wi-Fi 79

adding a connection manually 80

scanning and connecting 80

settings 81

status indicators 81

turning on or off 79

Wi-Fi Direct 23, 82

Windows Media Player 90

Wireless Networking

Bluetooth 83

Wi-Fi 79

World Clock 77

Y

YouTube 78