



Lenovo G700/G710

User Guide



Read the safety notices and important tips in the included manuals before using your computer.

Notes

- Before using the product, be sure to read *Lenovo Safety and General Information Guide* first.
- Some instructions in this guide may assume that you are using Windows® 8. If you are using other Windows operating system, some operations may be slightly different. If you are using other operating systems, some operations may not apply to you.
- The features described in this guide are common to most models. Some features may not be available on your computer or your computer may include features that are not described in this user guide.
- The illustrations used in this manual are for Lenovo G700 unless otherwise stated.
- The illustrations in this manual may differ from the actual product. Please refer to the actual product.
- To learn more about Lenovo Applications, go to: <http://www.lenovo.com>.

First Edition (March 2013)

© Copyright Lenovo 2013.

LIMITED AND RESTRICTED RIGHTS NOTICE: If data or software is delivered pursuant to a General Services Administration "GSA" contract, use, reproduction, or disclosure is subject to restrictions set forth in Contract No. GS-35F-05925.

Contents

Chapter 1. Getting to know your computer	1
Top view	1
Left-side view	7
Right-side view	11
Front view	12
Bottom view	13
Chapter 2. Starting to use Windows 8	14
Configuring the operating system for the first time	14
Operating system interfaces	14
The charms	15
Putting the computer to sleep or shutting it down	17
Connecting to wireless LAN	19
Help and support	20
Chapter 3. Lenovo OneKey Recovery System	21
Chapter 4. Troubleshooting	22
Frequently asked questions	22
Troubleshooting	24
Appendix A. CRU instructions.....	28
Replacing the battery pack	28
Replacing the hard disk drive.....	29
Replacing memory	33
Replacing the wireless LAN card	36
Removing the optical drive.....	38
Trademarks.....	40

Chapter 1. Getting to know your computer

■ ■ Top view

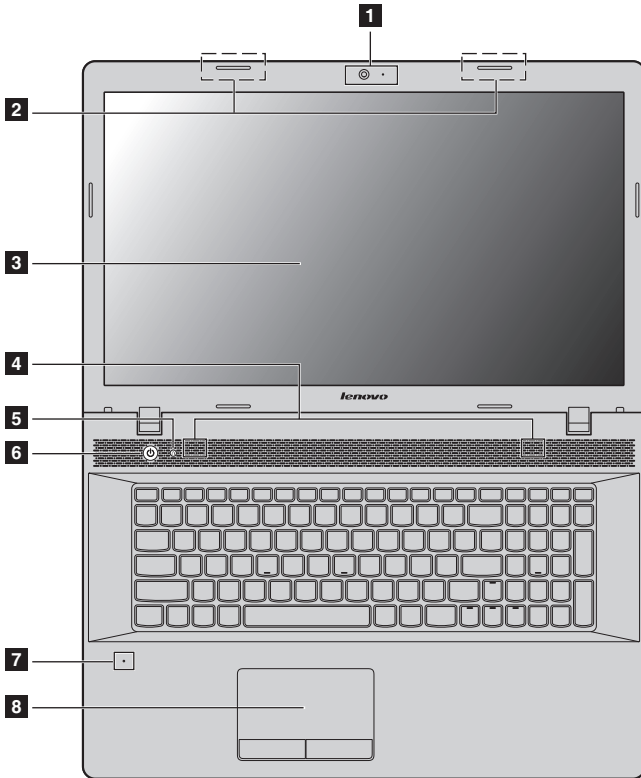

Note: The dashed areas indicate parts that are not visible externally.

⦿ Attention:

- Do *not* open the display panel beyond 130 degrees. When closing the display panel, be careful *not* to leave pens or any other objects in between the display panel and the keyboard. Otherwise, the display panel may be damaged.

Chapter 1. Getting to know your computer

- 1 Integrated camera** Use the camera for video communication.
- 2 Wireless module antennas (on select models)** The built-in antennas ensure optimal reception of wireless radio.
- 3 Computer display** Provides brilliant visual output.
- 4 Speakers** The stereo speakers provide rich and powerful sound.

Note: For sound effects and speaker locations specific to your model, refer to the actual product.

- 5 Novo button** When the computer is off or in hibernation mode, press this button to start the Lenovo OneKey Recovery System or the BIOS setup utility, or to enter the boot menu.

Note: For details, see “Lenovo OneKey Recovery System” on page 21.

- 6 Power button** Press this button to turn on the computer.
- 7 Built-in microphone (with noise reduction)** Captures sound which can be used for video conferencing, voice narration, or audio recording.
- 8 Touch pad** The touch pad functions as a conventional mouse.
Touch pad: To move the pointer on the screen, slide your fingertip over the pad in the direction in which you want the pointer to move.
Touch pad buttons: The functions of the left/right side correspond to that of the left/right mouse button on a conventional mouse.

Note: You can enable/disable the touch pad by pressing  .

Chapter 1. Getting to know your computer

■ Using the keyboard

Your computer has a numeric keypad and function keys incorporated in its standard keyboard.

Numeric keypad

The keyboard has a separate numeric keypad. To enable or disable the numeric keypad, press the **Num Lock** key.

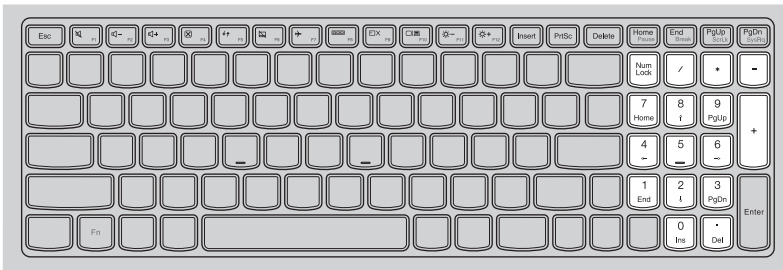

Chapter 1. Getting to know your computer

Function key combinations

Through the use of the function keys, you can change operational features instantly. To use this function, press and hold **Fn 1**; then press one of the function keys **2**.

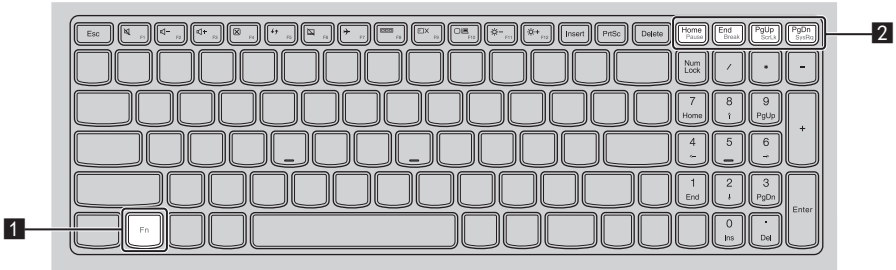

The following describes the features of each function key.

- | | |
|-------------------|-----------------------------------|
| Fn + Home: | Activates the pause function. |
| Fn + End: | Activates the break function. |
| Fn + PgUp: | Enables/disables the scroll lock. |
| Fn + PgDn: | Activates the system request. |

Chapter 1. Getting to know your computer

Hotkeys

You can access certain system settings quickly by pressing the appropriate hotkeys.

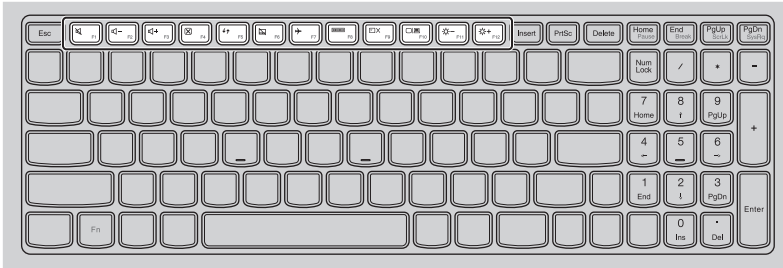

Mutes/unmutes the sound.



Enables/disables Airplane mode.



Decreases the volume level.



Displays all currently active apps.



Increases the volume level.



Turns on/off the backlight of the LCD screen.



Closes the currently active window.



Toggles the display between the computer and an external device.



Refreshes the desktop or the currently active window.



Decreases the display brightness.



Enables/disables the touch pad.



Increases the display brightness.

Chapter 1. Getting to know your computer

Setting hotkey mode

By default, the hotkey functions are accessible by pressing the appropriate hotkey. However, you can disable the hotkey mode in the BIOS setup utility. To disable the hotkey mode:

- ❶ Shut down the computer.
- ❷ Press the Novo button and then select **BIOS Setup**.
- ❸ In the BIOS setup utility, open the **Configuration** menu, and change the setting of **HotKey Mode** from **Enabled** to **Disabled**.
- ❹ Open the **Exit** menu, and select **Exit Saving Changes**.

Note: When hotkey mode is disabled, press the **Fn** key and the appropriate hotkey to access the corresponding hotkey function.

Left-side view

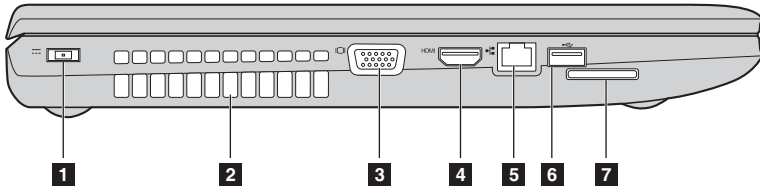

1 AC power adapter jack Connect the AC power adapter here.

2 Ventilation slots Dissipate internal heat.

Note: Make sure that the ventilation slots are not blocked or else the computer may overheat.

3 VGA port Connects to external display devices.

4 HDMI port Connects to devices with HDMI input such as a TV or an Ethernet display.

5 RJ-45 port Connects the computer to an Ethernet network.

6 USB port Connects to USB devices.

Notes:

- The blue ports are USB 3.0 ports. The black ports are USB 2.0 ports.
- For details, see “Connecting USB device” on page 9.

7 Memory card slot Insert memory cards (not supplied) here.

Note: For details, see “Using memory cards (not supplied)” on page 8.

Chapter 1. Getting to know your computer

■ Using memory cards (not supplied)

Your computer supports the following types of memory cards:

- Secure Digital (SD) card
- MultiMediaCard (MMC)

Notes:

- Insert *only* one card in the slot at a time.
- This card reader does not support SDIO devices (e.g., SDIO Bluetooth and so on.).

Inserting a memory card

- 1 Push the dummy card in until you hear a click.
- 2 Gently pull the dummy card out of the memory card slot.

Note: The dummy card is used for preventing dust and small particles from entering the inside of your computer when the memory card slot is not in use. Retain the dummy card for future use.

- 3 Slide the memory card in until it clicks into place.

Note: Select models may not include a dummy card. You can insert a memory card into the slot directly.

Removing a memory card

- 1 Push the memory card in until you hear a click.
- 2 Gently pull the memory card out of the memory card slot.

Note: Before removing the memory card, disable it by using the Windows safely remove hardware and eject media utility to avoid data corruption.

■ Connecting USB device

Your computer comes with three USB ports compatible with USB devices.

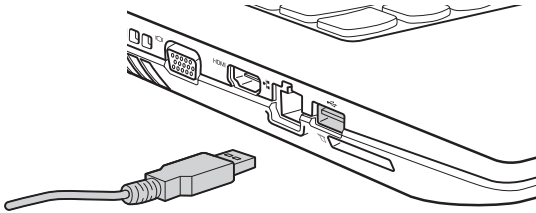

The first time you plug a USB device into a particular USB port on your computer, Windows automatically installs a driver for that device. After the driver has been installed, you can disconnect and reconnect the device without performing any additional steps.

Note: Typically, Windows detects a new device after it has been connected, and then installs the driver automatically. However, some devices may require you to install the driver before connecting. Check the documentation provided by the device's manufacturer before connecting the device.

Before disconnecting a USB storage device, make sure your computer has finished transferring data to that device. Click the **Safely Remove Hardware and Eject Media** icon in the Windows notification area to remove the device before disconnecting.

Note: If your USB device uses a power cord, connect the device to a power source before connecting it. Otherwise, the device may not be recognized.

Chapter 1. Getting to know your computer

■ Connecting a *Bluetooth* device (on select models)

If your computer has an integrated Bluetooth adapter card, it can connect to and transfer data wirelessly to other Bluetooth enabled devices, such as notebook computers, PDAs and cell phones. You can transfer data between these devices up to 10 meters range in open space.

Note: The actual maximum range may vary due to interference and transmission barriers. For best transfer speed, place the device as near your computer as possible.

Enabling *Bluetooth* communications on your computer

Press  to make configuration.

Notes:

- When you do not need to use the *Bluetooth* function, turn it off to save battery power.
- You need to pair the *Bluetooth* enabled device with your computer before you can transfer data between them. Read the documentation supplied with the *Bluetooth* enabled device for details on how to pair the device with your computer.

Right-side view

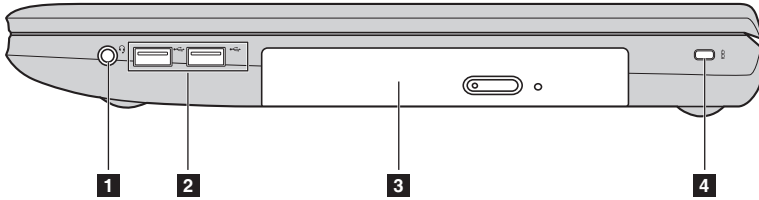

- 1 Combo audio jack** Connects to headset.

Notes:

- The combo audio jack does not support conventional microphones by default.
- The recording function may not be supported if third-party headphones or headsets are connected, due to different industry standards.

- 2 USB port** Connects to USB devices.

Notes:

- The blue ports are USB 3.0 ports. The black ports are USB 2.0 ports.
- For details, see “Connecting USB device” on page 9.

- 3 Optical drive (on select models)** Reads/Burns optical discs.

- 4 Kensington lock slot** Attach a security lock (not supplied) here to help protect your computer from theft and unauthorized use. You can attach a security lock to your computer to help prevent it from being removed without your permission. For details on installing the security lock, please refer to the instructions shipped with the security lock that you have purchased.

Notes:



- Before purchasing any security product, verify that it is compatible with this type of security keyhole.
- You are responsible for evaluating, selecting, and implementing the locking devices and security features. Lenovo offers no comment judgment or warranty regarding the function, quality or performance of locking devices and security features.

Chapter 1. Getting to know your computer

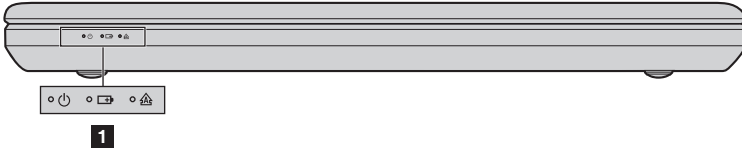
■ ■ Front view



1 System status indicators

- Power indicator 
- Battery status indicator 
- Caps lock indicator 

■ ■ Bottom view

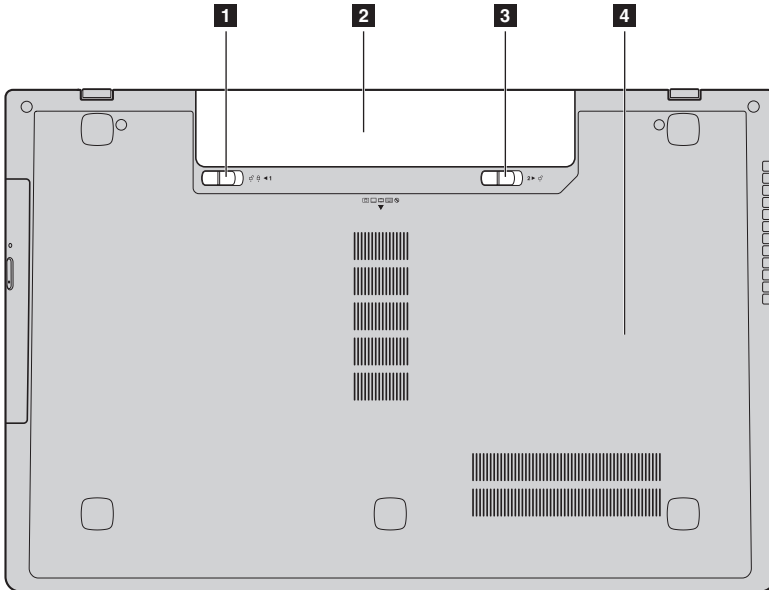

1 Battery pack latch -manual

The manual battery pack latch is used to keep the battery pack secured in place.

2 Battery pack

3 Battery pack latch - spring loaded

The spring-loaded battery pack latch keeps the battery pack secured in place.

**4 Optical drive/
Hard disk drive
(HDD)/Memory/
CPU (Central
processing unit)/
Mini PCI Express
Card slot
compartment**

■ ■ The charms

The five charms provide new and faster ways to perform many basic tasks, and are always available regardless of which app you are currently in. To display the charms, do one of the following:

- Move the pointer to the upper-right or lower-right corner until the charms bar is displayed.
- Press Windows key  + C.

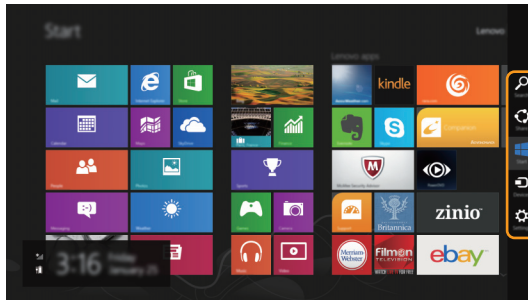

Search charm

The Search charm is a powerful new way to find whatever you are looking for, including apps, settings and files.

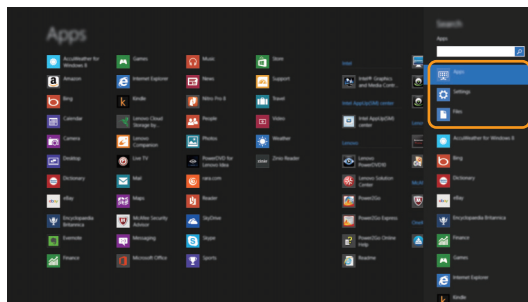

Chapter 2. Starting to use Windows 8



Share charm

The **Share** charm lets you send links, photos, and more to your friends and social networks without leaving the app you are in.



Start charm

The **Start** charm is a fast way to go to the Start screen.



Devices charm

The **Devices** charm allows you to connect or send files to any external devices, such as digital cameras, TVs, or printers.



Settings charm

The **Settings** charm lets you perform basic tasks, such as setting the volume or shutting down the computer. Also, you can get to the Control Panel through the **Settings** charm when using the desktop screen.



■ ■ Putting the computer to sleep or shutting it down

When you have finished working with your computer, you can put it to sleep or shut it down.

■ Putting your computer to sleep

If you will be away from your computer for a short time, put the computer to sleep.

When the computer is in sleep mode, you can quickly wake it to resume use, bypassing the startup process.

To put the computer to sleep, do one of the following:

- Close the display panel.
- Press the Power button.
- Open the charms and then select **Settings**  → **Power**  → **Sleep**.

Note: Wait until the power indicator light starts blinking (indicating that the computer is in sleep mode) before you move your computer. Moving your computer while the hard disk is spinning can damage the hard disk, causing loss of data.

To wake the computer, do one of the following:

- Press the Power button.
- Press any key on the keyboard.

Chapter 2. Starting to use Windows 8

■ Shutting down the computer

If you are not going to use your computer for a long time, shut it down.
To shut down your computer:

- 1 Open the charms, and then select **Settings**  .

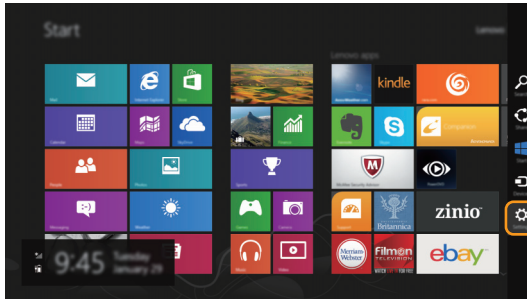

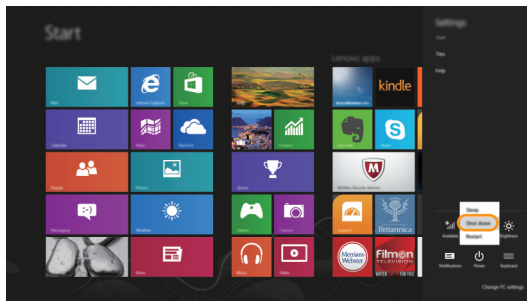

- 2 Select **Power**  → Shut down.



■ ■ Connecting to wireless LAN

Enabling wireless connection

If Airplane mode is on, do one of the following to enable the wireless function:

- Press  to disable Airplane mode.
- Open the charms, and select **Settings**  →  to open the Network configuration page, and then toggle Airplane mode switch to **Off**.

Connecting to a wireless LAN

After wireless has been enabled, the computer will automatically scan for available wireless networks and display them in the wireless LAN network list. To connect to a wireless network, click the network name in the list, and then click **Connect**.

Note: Some networks require a network security key or passphrase for connection. To connect to one of those networks, ask the network administrator or the Internet Service Provider (ISP) for the security key or passphrase.

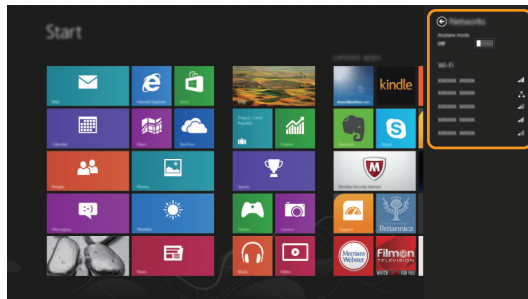

■ ■ Help and support ---

If you have any problems using the operating system, see the Windows Help and Support file.

To open the Windows Help and Support file, do one of the following:

- Select the **Settings** charm, then select **Help**.
- Press Windows key  + **Fn** + **F1**.

You can read the Windows Help and Support file on your computer. You can also get online help and support by clicking the link listed under **More to explore**.

Chapter 3. Lenovo OneKey Recovery System

The Lenovo OneKey Recovery System is software designed to back up and restore your computer. You can use it to restore the system partition to its original status in case of a system failure. You can also create user backups for easy restoration as required.

Note: To utilize the features of the OneKey Recovery System, your hard disk already includes a hidden partition by default to store the system image file and the OneKey Recovery System program files. This default partition is hidden for security reasons, which explains why the available disk space is less than the stated capacity.

■ Backing up the system partition

You can back up the system partition to an image file. To back up the system partition:

- 1 Press the Novo button to start the Lenovo OneKey Recovery System.
- 2 Click **System Backup**.
- 3 Select a back-up location and click **Next** to start the backup.

Notes:

- You can choose a back-up location on the local hard disk drive or an external storage device.
- Remove the removable hard disk drive before starting the Lenovo OneKey Recovery System. Otherwise, data from the removable hard disk drive might be lost.
- The back-up process may take a while.
- The back-up process is only available when Windows can be started normally.

■ Restoring

You can choose to restore the system partition to its original status or to a previously created back-up point. To restore the system partition:

- 1 Press the Novo button to start the Lenovo OneKey Recovery System.
- 2 Click **System Recovery**. The computer will restart to the recovery environment.
- 3 Follow the on-screen instructions to restore the system partition to its original status or to a previously created back-up point.

Notes:

- The recovery process is irreversible. Make sure to back up any data you wish to save on the system partition before starting the recovery process.
- The recovery process may take a while. So be sure to connect the AC power adapter to your computer during the recovery process.
- The above instructions should be followed when Windows can be started normally.

If Windows cannot be started, then follow the steps below to start the Lenovo OneKey Recovery System:

- 1 Shut down the computer.
- 2 Press the Novo button. From the Novo button menu, select the Lenovo OneKey Recovery System and press Enter.

Chapter 4. Troubleshooting

■ ■ Frequently asked questions

This section lists frequently asked questions by category.

■ Finding information

What safety precautions should I follow when using my computer?

The *Lenovo Safety and General Information Guide* which came with your computer contains safety precautions for using your computer. Read and follow all the precautions when using your computer.

Where can I find the hardware specifications for my computer?

You can find the hardware specification for your computer on the printed flyers which came with your computer.

Where can I find warranty information?

For the warranty applicable to your computer, including the warranty period and type of warranty service, see the Lenovo limited warranty flyer that came with your computer.

■ Drivers and preinstalled software

Where are the installation discs for Lenovo preinstalled software (desktop software)?

Your computer did not come with installation discs for Lenovo preinstalled software. If you need to reinstall any preinstalled software, you can find the installation program on the D partition of your hard disk. If you cannot find the installation program there, you can also download it from the Lenovo consumer support website.

Where can I find drivers for the various hardware devices of my computer?

If your computer is preinstalled with a Windows operating system, Lenovo provides drivers for all the hardware devices that you need on the D partition of your hard disk. You can also download the latest device drivers from the Lenovo consumer support website.

■ Lenovo OneKey Recovery System

Where are the recovery discs?

Your computer did not come with any recovery discs. Use the Lenovo OneKey Recovery System if you need to restore the system to its original factory status.

What can I do if the back-up process fails?

If you can start the backup but it fails during the back-up process, try the following steps:

- ❶ Close all open programs, and then restart the back-up process.
- ❷ Check to see if the destination media is damaged. Select another path and then try again.

When do I need to restore the system to its factory status?

Use this feature when the operating system fails to start up. If there is critical data on the system partition, back it up before starting recovery.

■ BIOS setup utility

What is the BIOS setup utility?

The BIOS setup utility is a ROM-based software. It displays basic computer information and provides options for setting boot devices, security, hardware mode, and other preferences.

How can I start the BIOS setup utility?

To start the BIOS setup utility:

- ❶ Shut down the computer.
- ❷ Press the Novo button and then select **BIOS Setup**.

How can I change the boot mode?

There are two boot modes: **UEFI** and **Legacy Support**. To change the boot mode, start the BIOS setup utility and set boot mode to **UEFI** or **Legacy support** on the boot menu.

When do I need to change the boot mode?

The default boot mode for your computer is **UEFI** mode. If you need to install a legacy operating system, such as Windows, Linux or Dos, etc (that is, any operating system before Windows 8) on your computer, you must change the boot mode to **Legacy support**. The legacy operating system, such as Windows, Linux or Dos, etc cannot be installed if you don't change the boot mode.

■ Getting help

How can I contact the customer support center?

See "Chapter 3. Getting help and service" in the *Lenovo Safety and General Information Guide*.

Chapter 4. Troubleshooting

■ ■ Troubleshooting

Display problems

When I turn on the computer, nothing appears on the screen.

- If the screen is blank, make sure that:
 - The battery pack is installed correctly.
 - The AC power adapter is connected to the computer, and the power cord is plugged into a working electrical outlet.
 - The computer power is on. (Press the Power button again for confirmation.)
 - The memory is installed correctly.
- If these items are properly set, and the screen remains blank, have the computer serviced.

When I turn on the computer, only a white cursor appears on a blank screen.

- Restore backed-up files to your Windows environment or the entire contents of your hard disk to its original factory contents using the Lenovo OneKey Recovery System. If you still see only the cursor on the screen, have the computer serviced.

The screen goes blank while the computer is on.

- Your screen saver or power management may be enabled. Do one of the following to exit from the screen saver or to resume from sleep mode:
 - Touch the touch pad.
 - Press any key on the keyboard.
 - Press the Power button.
 - Press **F9**() to confirm whether the backlight of the LCD screen has been turned off.

BIOS password problems

I forgot my password.

- If you forget your user password, ask the system administrator to clear your user password.
- If you forget your hard disk drive password, a Lenovo authorized servicer cannot reset your password or recover data from the hard disk. You must take your computer to a Lenovo authorized servicer or a marketing representative to have the hard disk drive replaced. Proof of purchase is required, and a fee will be charged for parts and service.
- If you forget your supervisor password, a Lenovo authorized servicer cannot reset your password. You must take your computer to a Lenovo authorized servicer or a marketing representative to have the system board replaced. Proof of purchase is required, and a fee will be charged for parts and service.

Sleep problems

The critical low-battery error message appears, and the computer immediately turns off.

The computer enters sleep mode immediately after Power-on self-test (POST).

- The battery power is getting low. Connect the AC power adapter to the computer, or replace the battery pack with a fully charged one.
- Make sure that:
 - The battery pack is charged.
 - The operating temperature is within the acceptable range. See “Chapter 2. Use and care Information” in the *Lenovo Safety and General Information Guide*.

Note: If the battery pack is charged and the temperature is within range, have the computer serviced.

The computer does not return from sleep mode, and the computer does not work.



- If your computer is in sleep mode, connect the AC power adapter to the computer, then press any key or the Power button.
- If the system still does not return from sleep mode, stops responding, or cannot be turned off, reset the computer. Unsaved data may be lost. To reset the computer, press and hold the Power button for four seconds or more. If the computer is still not reset, remove the AC power adapter and the battery pack.

Display panel problems

The screen is blank.

The screen is unreadable or distorted.

Incorrect characters appear on the screen.

- Do the following:
 - If you are using the AC power adapter or the battery pack, and the battery status indicator is on, press **F12**() to make the screen brighter.
 - If the power indicator is blinking, press the Power button to resume from sleep mode.
 - If the problem persists, follow the solution in the next problem “The screen is unreadable or distorted.”
 - Press **F9**() to confirm whether the backlight of the LCD screen has been turned off.
- Make sure that:
 - The display device driver is installed correctly.
 - The screen resolution and color quality are correctly set.
 - The monitor type is correct.
- Are the operating system or programs installed correctly? If they are installed and configured correctly, have the computer serviced.

Chapter 4. Troubleshooting

Sound problems

No sound can be heard from the speaker even when the volume is turned up.

- Make sure that:
 - The Mute function is off.
 - The combo audio jack is not being used.
 - Speakers are selected as the playback device.

Battery pack problems

Your computer shuts down before the battery status indicator shows empty.

-or-

Your computer operates after the battery status indicator shows empty.

The computer does not operate with a fully charged battery pack.

- Discharge and recharge the battery pack.
- The surge protector in the battery pack might be active. Turn off the computer for one minute to reset the protector; then turn on the computer again.

A hard disk drive problem

The hard disk drive does not work.

- Make sure that the hard disk drive is included in the **Boot** menu in the BIOS setup utility correctly.

OneKey Recovery System problems

Backup cannot be made.

- Make sure that you are currently using a Windows operating system.
- There may not be enough space to store the backed-up data. You will need to free more hard disk space on your backup's partition.

Failure to restore system partition to factory default.

- The system partition (e.g. the partition size or the drive capacity of C) has been modified.

Other problems

Your computer does not respond.

- To turn off your computer, press and hold the Power button for four seconds or more. If the computer still does not respond, remove the AC power adapter and the battery pack.
- Your computer might lock when it enters sleep mode during a communication operation. Disable the sleep timer when you are working on the network.

The computer does not start from a device you want.

- See the **Boot** menu of the BIOS setup utility. Make sure that the BIOS setup utility is set so that the computer starts from the device you want.
- Also make sure that the device from which the computer starts is enabled. Make sure that the device is included in the **Boot** menu in the BIOS setup utility correctly.
- While turned off, press the Novo button to select the device you want the computer to start from.

The connected external device does not work.

- Do *not* connect or disconnect any external device cables other than USB while the computer power is on. Otherwise, you might damage your computer.
- When using high power consumption external devices such as an external USB optical disk drive, use an external device power adapter. Otherwise, the device may not be recognized, or the system may shut down as a result.

Appendix A. CRU instructions

Notes:

- The illustrations used in this appendix are for the Lenovo G700, unless otherwise stated.
- The following steps about upgrading and replacing devices are the same for the Lenovo G700/G710.
- Make sure the battery pack has been removed before replacing any devices.

■ Replacing the battery pack

Note: Use only the battery pack provided by Lenovo. Any other battery pack could ignite or explode.

To replace the battery pack, do the following:

- 1 Turn off the computer. Disconnect the AC power adapter and all cables from the computer.
- 2 Close the computer display and turn the computer over.
- 3 Unlock the manual battery pack latch **1**. While holding the spring-loaded battery pack latch in the unlocked position **2**, remove the battery pack in the direction shown by the arrow **3**.

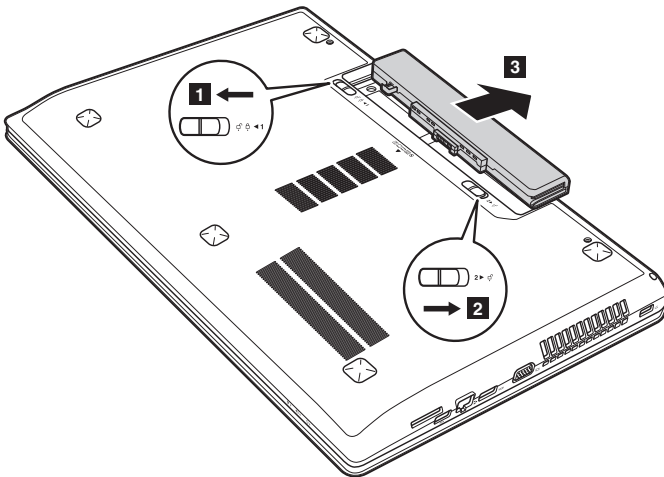

- 4 Install a fully charged battery pack.
- 5 Slide the manual battery pack latch to the locked position.
- 6 Turn the computer over again.
- 7 Connect the AC power adapter and the cables to the computer.

■ ■ Replacing the hard disk drive

You can increase the storage capacity of your computer by replacing the hard disk drive with one of greater capacity. You can purchase a new hard disk drive from your reseller or Lenovo marketing representative.

Notes:

- Replace the hard disk drive only if you upgrade it or have it repaired. The connectors and bay of the hard disk drive were not designed for frequent changes, or drive swapping.
- The preinstalled softwares are not included on an optional hard disk drive.

Handling a hard disk drive

- Do *not* drop the drive or subject it to physical shocks. Put the drive on a material, such as soft cloth, that absorbs the physical shock.
- Do *not* apply pressure to the cover of the drive.
- Do *not* touch the connector.

The drive is very sensitive. Incorrect handling can cause damage and permanent loss of data on the hard disk. Before removing the hard disk drive, make a backup copy of all the information on the hard disk, and then turn the computer off. Never remove the drive while the system is operating or in sleep mode.

Appendix A. CRU instructions

To replace the hard disk drive, do the following:

- ❶ Turn off the computer. Disconnect the AC power adapter and all cables from the computer.
- ❷ Close the computer display and turn the computer over.
- ❸ Remove the battery pack.
- ❹ Remove the Optical drive/Hard disk drive/Memory/Central processing unit/Mini PCI Express Card slot compartment cover.
 - a. Remove the screws that secure the compartment cover **❶**.
 - b. Remove the compartment cover **❷**.

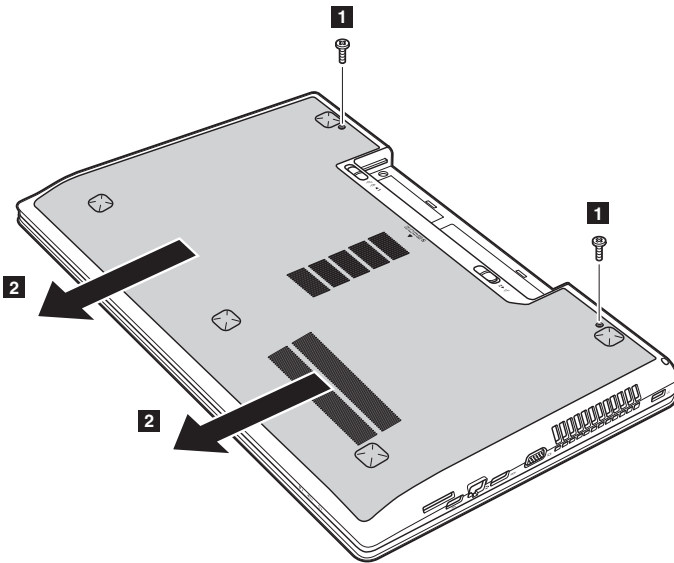

Appendix A. CRU instructions

- 5 Remove the frame fixing screws 3.

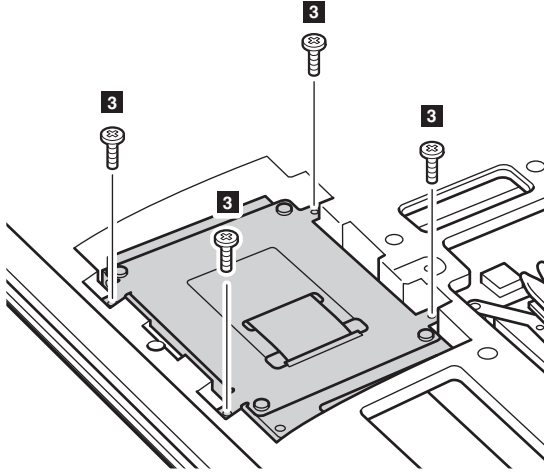

- 6 Pull the hard disk drive tab in the direction shown by arrow 4.

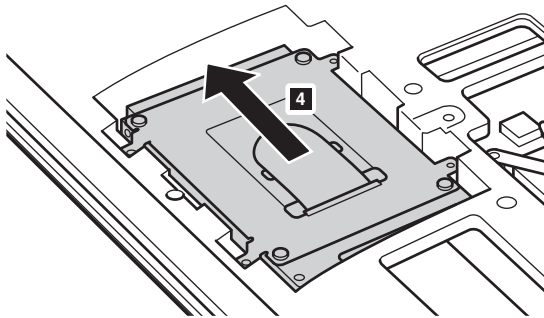

Appendix A. CRU instructions

- 7 Take out the hard disk drive secured in a metal frame **5**.

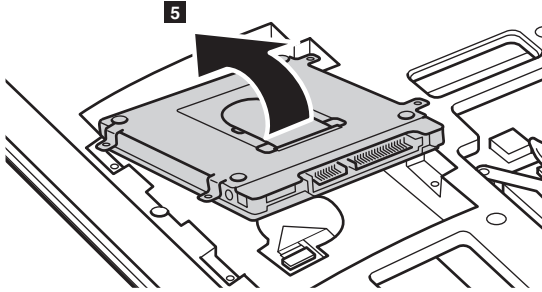

- 8 Remove the screws and detach the metal frame from the hard disk drive.
- 9 Attach the metal frame to a new hard disk drive and tighten the screws.
- 10 Put the hard disk drive gently into the hard disk drive bay with the tab facing upwards and the connectors facing each other; then push it firmly into space.
- 11 Reinstall the frame fixing screws.
- 12 After aligning the attachment clips with their matching gaps, reinstall the compartment cover.
- 13 Reinstall and tighten the screws.
- 14 Reinstall the battery pack.
- 15 Turn the computer over again.
- 16 Connect the AC power adapter and the cables to the computer.

■ ■ Replacing memory

You can increase the amount of memory in your computer by installing a double-data-rate three synchronous dynamic random access memory (DDR3 SDRAM)-available as an option-in the memory slot of your computer. DDR3 SDRAMs are available in various capacities.

Notes:

- Use only the memory types supported by your computer. If you incorrectly install optional memory, or install an unsupported memory type, a warning beep will sound when you try to start the computer.
- Select models of the computer may have only one memory slot. Refer to the actual product. However, the procedure for replacing the memory is the same as listed below.

To install a DDR3 SDRAM, do the following:

- ① Touch a metal table or a grounded metal object to reduce any static electricity in your body, which could damage the DDR3 SDRAM. Do not touch the contact edge of the DDR3 SDRAM.
- ② Turn off the computer. Disconnect the AC power adapter and all cables from the computer.
- ③ Close the computer display and turn the computer over.
- ④ Remove the battery pack.
- ⑤ Remove the Optical drive/Hard disk drive/Memory/Central processing unit/Mini PCI Express Card slot compartment cover.

Appendix A. CRU instructions

- 6 Remove the DDR3 SDRAM by pressing out on the latches on both edges of the socket at the same time. Be sure to save the old DDR3 SDRAM for future use.

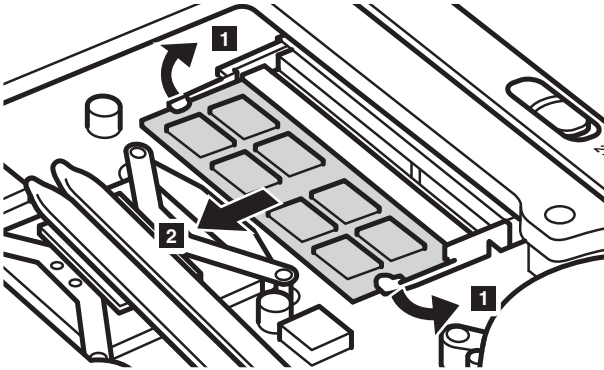

- 7 Align the notch of the DDR3 SDRAM with the protrusion of the socket and gently insert the DDR3 SDRAM into the socket at a 30-45° angle.
- 8 Push the DDR3 SDRAM inward toward the socket until the latches on both edges of the socket are pushed into the closed position.

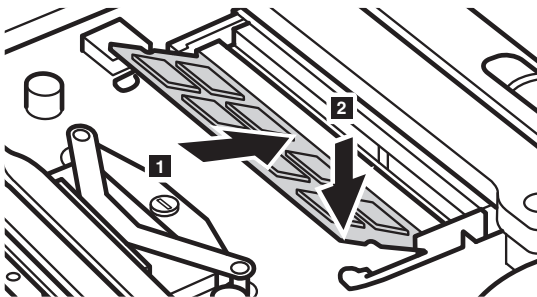

- 9 After aligning the attachment clips with their matching gaps, reinstall the compartment cover.
- 10 Reinstall and tighten the screws.
- 11 Reinstall the battery pack.
- 12 Turn the computer over again.
- 13 Connect the AC power adapter and the cables to the computer.

Appendix A. CRU instructions

Note: If only one DDR3 SDRAM is used on the computer you are servicing, the card must be installed in SLOT-0 (**a**: lower slot), but not in SLOT-1 (**b**: upper slot).

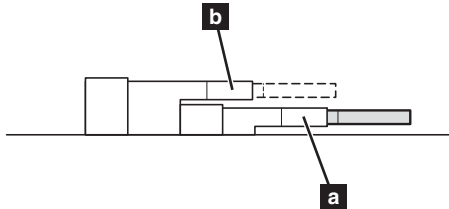

To make sure that the DDR3 SDRAM is installed correctly, do as follows:

- 1 Turn the computer on.
- 2 Hold F2 during startup. The BIOS setup utility screen opens. The **System Memory** item shows the total amount of memory installed in your computer.

Appendix A. CRU instructions

■ ■ Replacing the wireless LAN card

To replace the wireless LAN card, do the following:

- ❶ Turn off the computer; then disconnect the AC power adapter and all cables from the computer.
- ❷ Close the computer display, and then turn the computer over.
- ❸ Remove the battery pack.
- ❹ Remove the Optical drive/Hard disk drive/Memory/Central processing unit/Mini PCI Express Card slot compartment cover.
- ❺ Disconnect the two wireless LAN cables (one black, one white) **❶**.

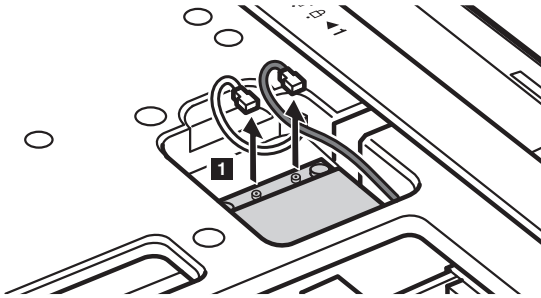

Note: The wireless LAN card in select models may have only one cable (black).

- ❻ Remove the screw that secures the wireless LAN card **❷**.

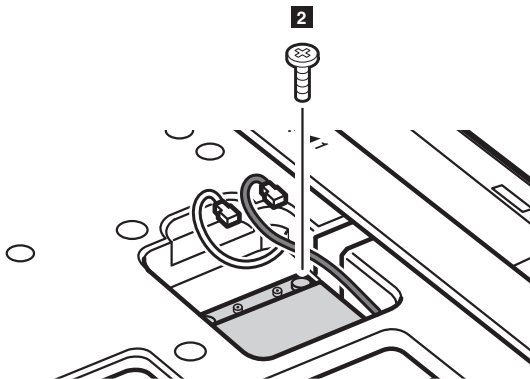

- 7 Take out the wireless LAN card **3**.

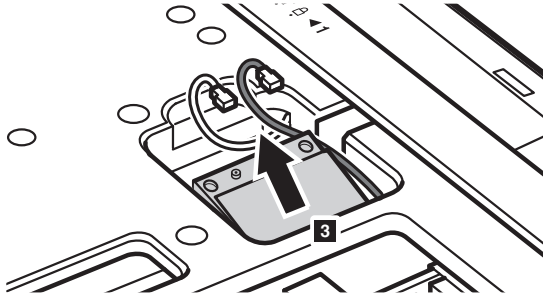

- 8 Install the new wireless LAN card.
- 9 Reinstall and tighten the screw.
- 10 Reconnect the two wireless LAN cables (one black, one white).

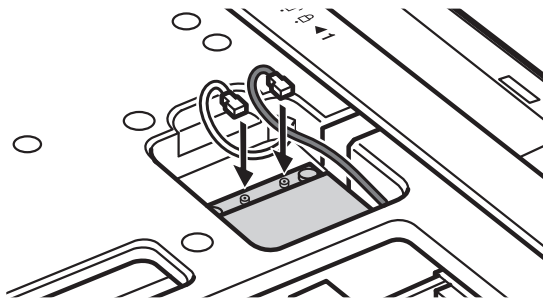

Note: When installing or reinstalling the wireless card:

- In models with a wireless LAN card that has two cables:
 - a Plug the black cable (MAIN) into the jack labeled M(Main).
 - b Plug the white cable (AUX) into the jack labeled A(Aux).
- In models with a wireless LAN card that has only one cable, plug the black cable (MAIN) into the jack labeled M(Main).

- 11 Reinstall the compartment cover and tighten the screws.
- 12 Reinstall the battery pack.
- 13 Turn the computer over again.
- 14 Connect the AC power adapter and the cables to the computer.

Appendix A. CRU instructions

■ ■ Removing the optical drive

To remove the optical drive, do the following:

- ❶ Remove the Optical drive/Hard disk drive/Memory/Central processing unit/Mini PCI Express Card slot compartment cover.
- ❷ Remove the screw shown in the illustration **❶**.
- ❸ Gently pull the optical drive out **❷**.

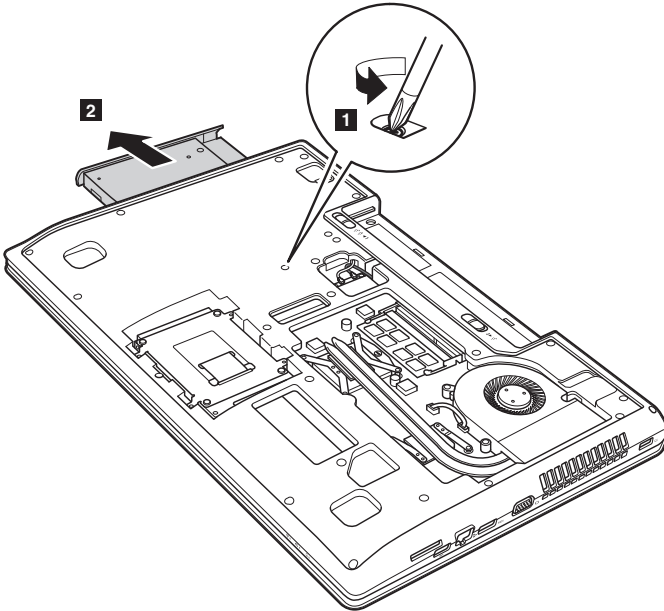

Appendix A. CRU instructions

The following table provides a list of CRUs (Customer Replaceable Units) for your computer and informs you of where to find replacement instructions.

	Setup Poster	User Guide
AC power adapter	○	
Power cord for AC power adapter	○	
Battery pack	○	○
Bottom access doors		○
Hard disk drive		○
Memory		○
Wireless LAN card		○
Optical drive		○

Trademarks

The following terms are trademarks or registered trademarks of Lenovo in the United States, other countries, or both.

Lenovo
OneKey

Microsoft and Windows are trademarks of Microsoft Corporation in the United States, other countries, or both.

Other company, products, or service names may be trademarks or service marks of others.

lenovo[®]

©Lenovo China 2013

en-US
Rev. AA00