



LEICA V-LUX

Instructions

Finding the information you need

In these “Instructions”, you can find the information you need from the following pages.

Table of Contents	P4 ~
List of function names “Contents by Function”	P9 ~
The Main Parts	P14 ~
Monitor/Viewfinder Displays	P292 ~
List of on-screen messages “Message Displays”	P298 ~
Menu list	P302 ~
[Rec]	P302
[Motion Picture]	P304
[Custom]	P305
[Setup]	P308
[Playback]	P310
Troubleshooting	P311 ~
For details on how to use these instructions, see the next page.	P3
Wi-Fi® function	P245 ~

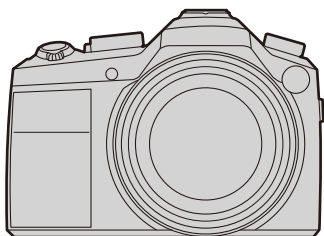

How to use these instructions

About the indication of the available modes

Available in the following modes:       COM    COL

The icons indicate the modes available for a function.

- Black icons: Available modes
- Gray icons: Unavailable modes

 and  will differ depending on the Recording Modes registered under custom settings.

About the symbols in the text

MENU: Indicates how the menu can be set after pressing the [MENU/SET] button.

Wi-Fi: Indicates how the Wi-Fi setting can be made after pressing the [WIFI] button.



: Configurations that can be performed in the [Custom] menu.

: Application tips.

: Conditions in which a particular function cannot be used.

: Continued to next page.

In these instructions, steps for setting a menu item are described as follows.

MENU →  [Rec] → [Quality] → 

The screen illustration examples in these instructions assume that [Style] in [Clock Set] (P34) is set to [D.M.Y].

Some icon values and on-screen illustrations related to motion pictures differ between the camera models available in different countries and depending on the camera settings.

Table of Contents

Finding the information you need.....	2
How to use these instructions	3
Contents by Function	9

1. Before Use

Care of the camera	12
Scope of Delivery / Accessories.....	13
The Main Parts.....	14

2. Preparations before Recording

Attaching the Lens Hood.....	20
Attaching the Lens Cap/the Shoulder Strap	22
Charging the Battery	23
• Charging	23
• Approximate operating time and number of recordable pictures.....	25
Inserting and Removing the Card/the Battery	27
About cards that can be used with this camera	29
• Formatting the card (initialization)	30
• Approximate number of recordable pictures and available recording time.....	31
Setting Date/Time (Clock Set).....	34
• Changing the Clock Setting.....	35
Setting the Menu	36
• Setting menu items.....	36
Quick Menu	39
• Customizing Quick Menu	41
Assigning Frequently Used Functions to the Function Buttons.....	43
Configuring basic settings (Setup Menu)	46
Entering Text	54

3. Basic Operation

Tips for taking good pictures	55
• Camera Direction Detection Function	55
Using the Viewfinder	56
• [EVF] button (Switching between Monitor and Viewfinder)	56
• About Eye Sensor AF	57
Taking a Still Picture	58
Recording Motion Pictures.....	60
Selecting the Recording Mode.....	61
Switching the Information Displayed on the Recording Screen	63

Playing Back Pictures/Motion Pictures.....	67
• Playing Back Pictures.....	67
• Playing Back Motion Pictures.....	70
• Changing the information displayed on the playback screen.....	71
Deleting Pictures.....	73

4. Recording Modes

Using the Snapshot Modes.....	75
• Recording night scenes.....	80
• Combining pictures into a single picture with rich gradation.....	81
• Taking a picture with a blurred background (Defocus Control).....	82
• Changing the brightness or color tone.....	83
Program Mode.....	84
Aperture-Priority Mode.....	86
Shutter-Priority Mode.....	87
Manual Exposure Mode.....	88
Confirming the Effects of Aperture and Shutter Speed (Preview Mode).....	91
Easily setting aperture/shutter speed for a suitable exposure (One Push AE).....	92
Using the Scene Modes.....	93
Using Creative Control Mode.....	107
Recording motion pictures with manually set aperture value/shutter speed.....	118
• Recording slow motion pictures.....	119
Registering your preferred settings (Custom Mode).....	120
• Registering Personal Menu Settings.....	120
• Using registered custom settings.....	121

5. Image and Picture Quality Settings

Adjusting the Picture Quality by Adding an Effect ([Photo Style]).....	122
Adjusting Bright/Dark Sections ([Highlight Shadow]).....	124
Setting the White Balance.....	126
Setting the aspect ratio.....	131
Setting the resolution.....	132
Setting the compression rate.....	133
Using Image Correction Functions.....	135
• Compensating the contrast and exposure ([i.Dynamic]).....	135
• Raising the resolution ([i.Resolution]).....	135
• Combining pictures with different exposures ([HDR]).....	136
• Reducing the long shutter noise caused by slower shutter speeds.....	137
• Setting the color space.....	138

6. Focus and Exposure Settings

Using Autofocus	139
• About the focus modes (AFS/AFF/AFC)	140
• Autofocus modes	141
• Setting the desired focus method	149
Manual Focusing	151
Taking Close-up Pictures	156
Focus and Exposure Memory Lock (AF/AE Lock)	158
Exposure Compensation	160
Setting the ISO Sensitivity	161
• Setting the upper ISO sensitivity limit	163
• Setting the ISO sensitivity setting increments	163
• Extending ISO sensitivity	163
Selecting the Exposure Metering Mode	164

7. Shutter and Drive Settings

Setting the Shutter Type	165
Selecting a Drive Mode	167
Using Continuous Mode	168
Using Auto Bracket	171
Using the Self-timer	173
Taking Pictures Automatically at Set Intervals	174
Creating Stop Motion Pictures	178

8. Functions Customized for Various Subjects and Purposes

Making Multiple Exposures on One Picture	182
Disabling Operational Sounds and the Light Sources at once	184
Taking Pictures of Registered Faces	185
Recording Profiles of Children and Pets on Images	190
Using screens and displays suitable for recording	191
Recording while monitoring camera images	192

9. Stabilizer, Zoom and Flash

Optical Image Stabilizer	193
Using the Lens' Zoom Function	195
Using the flash	199
• Changing the Flash Modes	201
• Setting 2nd Curtain Synchro	204
• Flash exposure compensation	205
• Synchronizing the output of the built-in flash unit to the set Exposure Compensation	205
• Changing the firing mode (Manual flash)	206
• Correcting red eyes	206

10. Recording Motion Pictures

Recording Motion Pictures	207
• Setting the resolution and frame rate	207
• How to focus when recording a motion picture ([Continuous AF])	209
• Recording Motion Pictures	210
• Recording motion pictures in 4K	213
Recording still pictures while recording motion pictures	214
Using the [Motion Picture] Menu	216
• [Rec Quality]	216
• [Exposure Mode]	216
• [High Speed Video]	216
• [Picture Mode]	216
• [Continuous AF]	216
• [Level Shot]	217
• [Luminance Level]	217
• [Flkr Decrease]	217
• [Mic Level Disp.]	218
• [Mic Level Adj.]	218
• Adjusting the sound input level automatically ([Mic Level Limiter])	218
• [Wind Cut]	219
• [Zoom Mic]	219

11. Playing Back and Editing Images

Playing Back Group Pictures	220
Creating Still Pictures from a Motion Picture	222
Using the [Playback] Menu	223
• [Slide Show]	223
• [Playback Mode]	225
• [Location Logging]	226
• [RAW Processing]	227
• [Title Edit]	230
• [Text Stamp]	231
• [Video Divide]	234
• [Time Lapse Video]	235
• [Stop Motion Video]	235
• [Resize]	236
• [Cropping]	237
• [Rotate]/[Rotate Disp.]	238
• [Favorite]	239
• [Print Set]	240
• [Protect]	242
• [Face Rec Edit]	243
• [Picture Sort]	243
• [Delete Confirmation]	244

12. Using the Wi-Fi function

Wi-Fi® function/NFC function	245
What you can do with the Wi-Fi function	249
Controlling with a Smartphone/Tablet	250
• Installing the smartphone/tablet app “Image Shuttle”	250
• Connecting to a smartphone/tablet	251
• Taking pictures via a smartphone/tablet (remote recording)	256
• Playing back images in the camera	257
• Saving images stored in the camera	257
• Sending images in the camera to an SNS	259
• Adding location information to images stored in the camera from a smartphone/tablet	259
• Sending images to a smartphone/tablet by controlling the camera	261
About Connections	264
• Connecting from your house (via the network)	265
• Connecting from a location away from your house (direct connection)	267
• Connecting quickly with the same settings as the previous ones ([Select a destination from History]/[Select a destination from Favorite])	268
• About settings for sending images	270
[Wi-Fi Setup] Menu	272

13. Connecting to other equipment

Enjoying Motion Pictures in 4K	274
Playing Back Pictures on a TV	275
• Using HDTV Link (HDMI)	278
Copying the recorded image data to a computer	280
Saving still pictures and motion pictures on a Recorder	283
Printing the Pictures	284

14. Miscellaneous

Accessories	290
Monitor/Viewfinder Displays	292
Message Displays	298
Menu list	302
• [Rec]	302
• [Motion Picture]	304
• [Custom]	305
• [Setup]	308
• [Playback]	310
Troubleshooting	311
Cautions for Use	326
Leica Service Addresses	334

Contents by Function



Recording

Recording

Recording Mode	P61
[Preview]	P91
Macro recording	P156
[Multi Exp.]	P182
[Silent Mode]	P184

Focus (AF/MF)

Focus Mode	P140
AF Mode	P141
Adjusting the AF area position	P146
Manual Focus	P151
AF/AE Lock	P158

Drive

Drive Mode	P167
[Self Timer]	P173
[Time Lapse Shot]	P174
[Stop Motion Animation]	P178

Picture Quality and Color Tone

[Photo Style]	P122
[Highlight Shadow]	P124
White Balance	P126
[Picture Size]	P132

[Quality]	P133
[i.Dynamic]	P135
[i.Resolution]	P135
[HDR]	P136
[Long Shtr NR]	P137
[Color Space]	P138
ISO sensitivity	P161

Exposure

[One Push AE]	P92
AF/AE Lock	P158
Exposure Compensation	P160
[Metering Mode]	P164
[Auto Bracket]	P171

Flash

[Flash Mode]	P201
2nd curtain synchro	P204
[Flash Adjust.]	P205

Screen settings

[Center Marker]	P191
[Monochrome Live View]	P192
[Mic Level Disp.]	P218



Motion Picture

Motion Picture

Creative Video Mode	P118
[High Speed Video]	P119
[Rec Quality]	P207
Motion pictures in 4K	P213
Recording still pictures while recording motion pictures	P214

Audio

[Mic Level Adj.]	P218
[Wind Cut]	P219
[Mic Level Limiter]	P218



Setup/Custom

Basic settings

[Format]	P30
[Clock Set]	P34
How to set menu items	P36
[Q.MENU]	P39
[Beep]	P48
[Economy]	P50
[Reset] (initialization)	P53

Diopter adjustment	P57
Display switching	P63, 71

Customization

[CUSTOM] in the Quick Menu	P41
Function buttons	P43
Custom Mode	P120
[Custom] menu	P305



Playback

Playback

[Auto Review]	P59
Picture playback	P67
Playback Zoom	P68
Multi Playback	P69
Motion picture playback	P70
Delete	P73

Display/playback settings

[Slide Show]	P223
[Rotate]/[Rotate Disp.]	P238

Edit

[RAW Processing]	P227
[Resize]	P236
[Cropping]	P237

Adding information

[Location Logging]	P226
[Title Edit]	P230
[Text Stamp]	P231

Image settings

[Favorite]	P239
[Print Set]	P240
[Protect]	P242



Wi-Fi

Connect

“Image Shuttle”	P250
NFC	P255
[WPS (Push-Button)]	P265, 267
Direct connection	P267

Image Shuttle

Remote recording	P256
Saving images	P257
Sending images	P258, 261
Sending and adding location information	P259
[Touch Sharing]	P272



Connections with other devices

Computers

Software available for download ...	P280
-------------------------------------	------

TV

[HDTV Link]	P278
-------------------	------

Recorder

Dubbing	P283
---------------	------

Printer

PictBridge	P284
------------------	------

Care of the camera

Do not subject it to strong vibration, shock, or pressure.

- The lens, monitor, or external body may be damaged if used in the following conditions.

It may also malfunction or the image may not be recorded if you:

- Drop or hit the camera.
- Exert pressure on the lens or the monitor.
- **When the camera is not in use or when using playback, ensure that the lens is in the stored position, with the lens cap attached.**
- **There are times when the camera will emit rattling sounds or vibrations, but these are due to the diaphragm operation, the lens' zoom function and the motor and do not indicate a defect.**

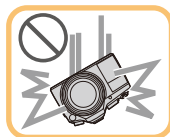

This camera is not dust/splash/water proof.

Avoid using the camera in places with a lot of dust, water, sand, etc. such as when using it on a rainy day or at the beach.

- Liquids, sand and other foreign material may enter through the gaps around the lens, the buttons, etc. Be particularly careful since it may not just cause malfunctions, but it may also cause irreparable damage.

■ About Condensation (When the lens, the viewfinder or monitor is fogged up)

- Condensation occurs when the ambient temperature or humidity changes. Try to avoid this since it may cause lens, viewfinder and monitor stains, fungus and camera malfunction.
- If condensation occurs, turn the camera off and leave it for about 2 hours. The fog will disappear naturally when the temperature of the camera is similar to the ambient temperature.

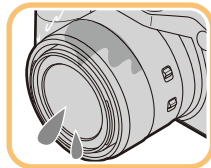

Scope of Delivery / Accessories

■ Scope of Delivery

Order No.	
Rechargeable battery BP-DC12-E BP-DC12-U BP-DC12-TK	18 728 18 729 18 794
Battery charger BC-DC12-E BC-DC12-U	423-111.001-012 423-111.002-010
Mains cable KR TW EU CN UK AUS	423-114.001-003 423-114.001-004 423-114.001-005 423-114.001-006 423-114.001-007 423-114.001-008 (delivery differs depending on markets)
USB cable	423-114.001-010
Shoulder strap	423-111.001-014
Lens hood	423-114.001-020
Lens cap	423-114.001-018
Lens cap string	423-114.001-019
Hot shoe cover	423-114.001-012
CD with instr. PDFs	423-114.001-016
Button template for Canada	423-114.001-009 (only with camera model 18 194)
Short instructions	93 593-597 (delivery differs depending on markets)
Guarantee card	439-399.100-026

■ Accessories

Order No.	
Cases System case, size S, Nylon, black size M, Nylon, black size S, leather, gray size L, cotton/linnen, gray	18 746 18 748 18 761 18 844
Billingham for Leica, size M, black size M, khaki	14 854 14 855
Flash unit Leica CF 22	18 694
Tripods Mini tripod Travel tripod, carbon fiber	14 100 14 101
Ball heads Ball head 18, short, black/silver long, black/silver Ball head 24 Ball head 38	14 108 / 14 109 14 110 / 14 112 14 113 14 114
SD- and credit card sheath, black /cognac	18 538 / 18 539

Notes:

- Cards are optional.
- Check that all items belonging to the scope of delivery are included before using the camera.
- The items and their shape may differ depending on the country or area where the camera was purchased.
- Keep small parts in a safe place out of the reach of children.
- Please dispose of all packaging appropriately.

The Main Parts

- 1 Self-timer indicator (P173)/
AF Assist Lamp (P150)
- 2 Flash (P199)
- 3 Lens surface

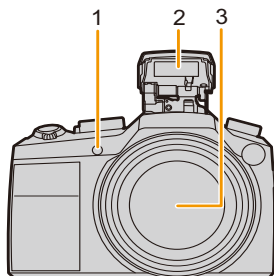

- 4 [EVF] button (P56)/
[FN5] button (P43)
- 5 Eye sensor (P56)
- 6 Eyecup (P327)
- 7 Viewfinder (P56)
- 8 [AF/AE LOCK] button (P158)
- 9 Focus mode lever (P139, 151)
- 10 Rear dial (P18)
- 11 Speaker
 - Be careful not to cover the speaker, e.g. with your finger. Doing so may impair sound audibility.

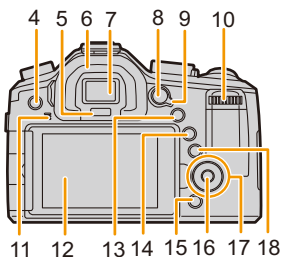

- 12 Monitor (P17)
- 13 [Q.MENU] button (P39)/
[FN3] button (P43)
- 14 [▶] (Playback) button (P67)
- 15 [⏏/⌫] (Delete/Cancel) button (P73)/
[FN4] button (P43)
- 16 [MENU/SET] button (P19, 36)
- 17 Cursor buttons (P19)
 - ▲/ISO button (P161)
 - ▶/WB (White Balance) (P126)
 - ◀/AF Mode button (P139)
 - ▼/AF  button (P156)
- 18 [DISP] button (P63, 71)
 - Each time this is pressed, the display on the monitor is switched.



- 19 Focal length scale (35mm film camera equivalent)
- Indicates values for the [3:2] aspect ratio.
(When recording motion pictures, refer to the focal length displayed on the monitor screen.)

20 Motion picture button (P210)

21 Zoom lever (P195)

22 Shutter button (P58)

23 [FN1] button (P43)

24 Drive mode dial (P167)

Single (P167): 

Continuous (P168): 

Auto Bracket (P171): 

Self-timer (P173): 

Time Lapse/Animation (P174, 178): 

25 Hot shoe (Hot shoe cover) (P290)

26 Stereo microphone (P218)

- Be careful not to cover the microphone, e.g. with your finger. Doing so may make impair sound recording.

27 Mode dial (P61)

28 Camera ON/OFF switch (P34)

29 Status indicator (P34)

30 Wi-Fi® connection lamp (P246)

31 [WIFI] button (P246)/

[FN2] button (P43)

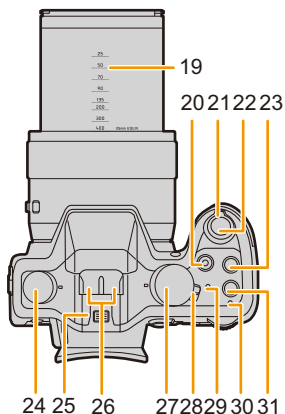

32 NFC antenna (P255)

33 Tripod thread (P331)

- Using tripod screws with lengths of 5.5mm (7/32") or more may damage the camera if attached.

34 Card/Battery door (P27)

35 Release slider (P27)

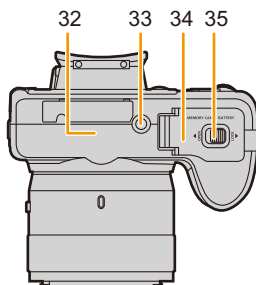

- 36 Zoom/MF ring (P151, 195)
 - Allows you to either change the focal length, or to focus manually.
- 37 Zoom/MF ring selector switch (P151, 195)
- 38 O.I.S. switch (P193)
- 39 [MIC] socket
- 40 Shoulder strap lug (P22)
 - We suggest to attach the shoulder strap when using the camera to ensure that you do not drop it.
- 41 Flash open slider (P199)
 - The flash opens.
- 42 Diopter adjustment dial (P57)
- 43 [REMOTE] socket
- 44 [HDMI] socket (P275)
- 45 [AV OUT/DIGITAL] socket (P276, 281, 283, 284)
- 46 Terminal cover

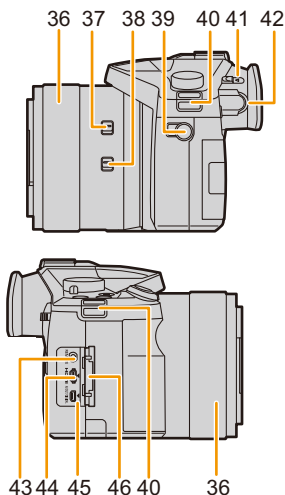

Drive mode dial

You can change what the camera will do when you press the shutter button. (P167)

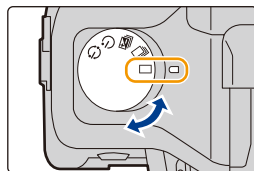

Diopter adjustment dial

Adjust the diopter to suit your vision so that you can see the viewfinder displays clearly. (P57)

- Ⓐ Diopter adjustment dial

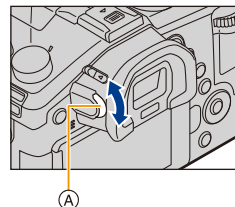

Monitor

When this camera is purchased, the monitor is facing the camera body.
Fold out the monitor as shown below.

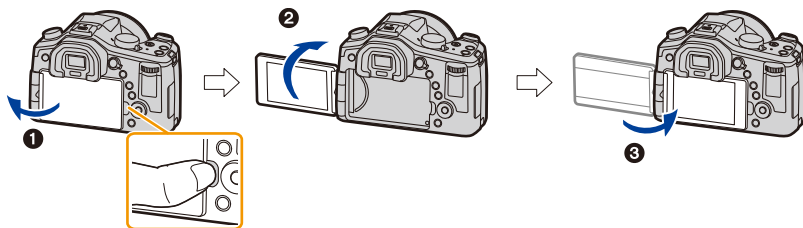

- 1 Place your finger in the notch on the right side of the monitor to open it.
(Maximum 180°)
 - 2 It can be rotated 180 ° forwards.
 - 3 Return the monitor to its original position.
- **Only rotate the monitor after opening it wide enough, and be careful not to use excessive force as this may damage it.**

■ Shooting with different camera positions

The monitor can be rotated to suit your needs. This is convenient as it allows you to take pictures from various angles by adjusting the monitor accordingly.

- Do not cover the AF Assist Lamp with your fingers or other objects.

Taking pictures at a high angle

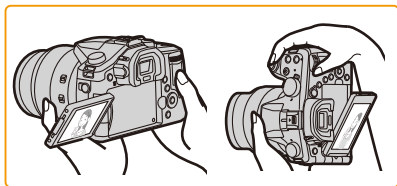

Taking pictures at a low angle

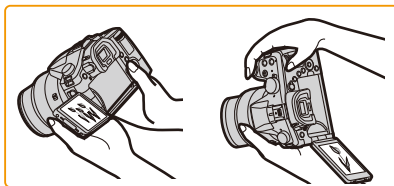

- When not using the monitor it is recommended that you close it with the screen facing inwards to prevent dirt and scratches.

Rear Dial

There are 2 ways to operate the rear dial, rotating it left or right, and changing its functions by pressing it.

Rotating:

Selects items or sets values during the various settings.

Pressing:

Operations that are the same as with the [MENU/SET] button, such as determining settings, etc., are performed during the various settings.

- The rear dial is described as follows in these instructions.

e.g.: When rotating the rear dial to the left or right/
pressing it

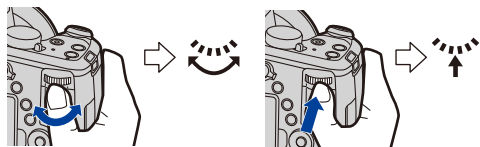

It allows you to set the aperture, shutter speed, and other settings when in **P / A / S / M** modes.

Mode dial	 Rear Dial
P (P84)	Program Shift*
A (P86)	Aperture value*
S (P87)	Shutter speed*
M (P88)	Aperture value/Shutter speed

- * Pressing the rear dial enables you to set an exposure compensation value.



Displaying/not displaying the operation guide

MENU → **/c**[Custom] → [Dial Guide] → [ON]/[OFF]

- When [ON] is set, the operation guide for dials, buttons, etc. is displayed on the screen.



Cursor buttons/[MENU/SET] button

Pressing the cursor button:

Selects items or sets values etc.,.

Pressing [MENU/SET]:

Confirms setting contents, etc.,.

- In these instructions, pressing the up, down, left, and right cursor buttons is indicated by ▲/▼/◀/▶.

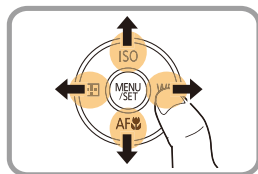

2.

Preparations before Recording

Attaching the Lens Hood

In bright sunlight or backlight, the lens hood will minimize lens flare and ghosting. The lens hood cuts off excess lighting and improves the picture quality.

- Do not hold the lens hood in a way that twists or bends it.
- Check that the camera is turned off.
- Close the flash.



- 1** Align one of the mounting marks on the lens hood edge at the 10 o'clock position and opposite the lens' bayonet mount.

- Ⓐ Lens bayonet
- Ⓑ Mounting mark (Lens hood)

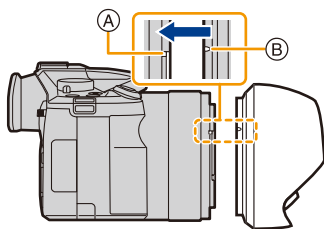

- 2** Lightly press the lens hood onto the lens' bayonet mount.

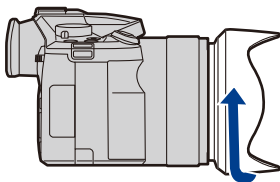

- 3** Turn the lens hood in the direction of the arrow beyond a slight resistance until you feel and hear it click into place.

- Ⓒ Make sure the lens hood is correctly attached, i.e. that the marks are exactly in the 6 and 12 o'clock positions

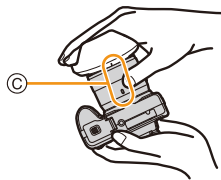

2. Preparations before Recording

- When taking pictures with flash with the lens hood attached, the lower section of the photo may be dark (vignetting effect) and flash output control may be impaired. We recommend detaching the lens hood when using the flash.
- When temporarily detaching and carrying the lens hood, we recommend attaching it with the orientation reversed. Return it to the normal position when taking pictures.

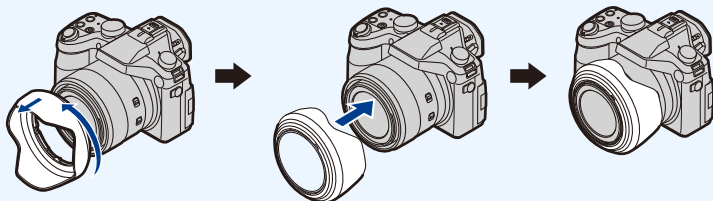

Attaching the Lens Cap/the Shoulder Strap

■ Attaching the Lens Cap

- When the camera is not being used, always attach the lens cap to protect the lens.

- 1** Pass the string through the strap lug on the camera.

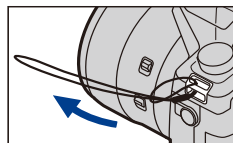

- 2** Pass the other end of the string through the eyelet on the lens cap.

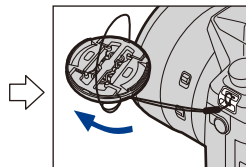
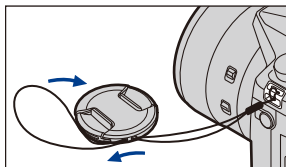

- 3** Attach the lens cap.

- Do not hang or swing around the camera holding it only by the lens cap string.
- Make sure to remove the lens cap before turning the camera on.
- Take care not to entangle the lens cap string with the shoulder strap.

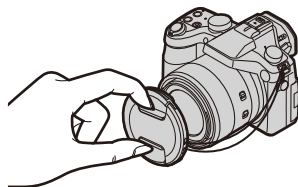

■ Attaching the Shoulder Strap

- We recommend attaching the shoulder strap when using the camera to prevent it from dropping.

- 1** Pass one end of the shoulder strap through the shoulder strap lug.

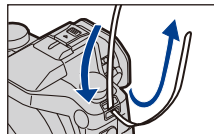

- 2** Pass the shoulder strap through the stopper and pull it tight.

- Ⓐ Let the end of the strap extend 2cm ($\frac{25}{32}$ " or more).

- Attach the shoulder strap to the other side of the camera without twisting it.

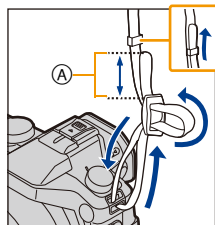

Charging the Battery

About batteries that you can use with this camera

It has been found that counterfeit batteries which look very similar to the genuine product are made available for purchase in some markets. Some of these batteries are not adequately protected with internal protection to meet the requirements of appropriate safety standards. There is a possibility that these batteries may cause a fire or an explosion. Please be advised that Leica Camera AG is not liable for any accident or failure occurring as a result of use of a counterfeit battery. To ensure that safe products are used, we urgently recommend to use only the Leica battery BP-DC12.

- Use only the dedicated charger and battery.

Charging

- The battery is not charged when the camera is shipped. Charge the battery before use.
- Charge the battery indoors.

1 Insert the battery into the charger.

- The terminals should face the charger's contacts and the Leica logo upwards.

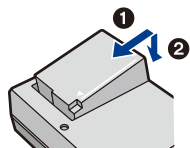

2 Connect the charger to the electrical outlet.

- The [CHARGE] indicator (A) lights up and charging begins.

plug-in type

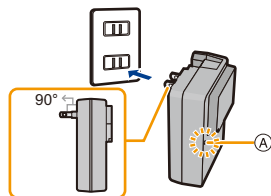

inlet type

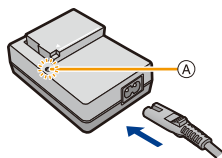

■ About the [CHARGE] indicator

On: Charging.

Off: Charging has been completed.
(After charging is completed, disconnect the charger from the electrical outlet and remove the battery from the charger.)

• When the [CHARGE] indicator flashes

- The battery temperature is too high or too low. It is recommended to charge the battery again in an ambient temperature of between 10 - 30°C (50 - 86°F).
- The terminals of the charger or the battery are dirty. In this case, clean them with a dry cloth.

■ Charging time

Charging time	Approx. 140 min
----------------------	------------------------

- The indicated charging time is for when the battery has been discharged completely. The charging time may vary depending on how the battery has been used. The charging time for the battery in hot/cold environments or for a battery that has not been used for a long time may be longer than normal.

■ Battery indication

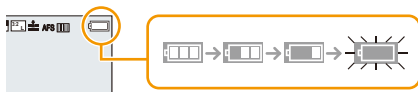

- The indication turns red and flashes if the remaining battery power is exhausted. (The status indicator also flashes)
Recharge the battery or replace it with a fully charged battery.

- **Do not leave any metal items (such as clips) near the power plug terminals. Otherwise, a fire and/or electric shocks may be caused by short-circuiting or the resulting generated heat.**
- The battery can be recharged even when it still has some charge left, but it is not recommended that the battery charge be frequently topped up while the battery is fully charged.
(Since characteristic swelling may occur.)

Approximate operating time and number of recordable pictures

■ Recording still pictures (when using the monitor) (By CIPA standard in Program Mode)

Number of recordable pictures	Approx. 360 pictures
Recording time	Approx. 180 min

■ Recording still pictures (when using the viewfinder) (By CIPA standard in Program Mode)

Number of recordable pictures	Approx. 300 pictures
Recording time	Approx. 150 min

Recording conditions by CIPA standard

- CIPA is an abbreviation of [Camera & Imaging Products Association].
- Temperature: 23°C (73.4°F)/Humidity: 50%RH when monitor is on.
- When using an SDHC Memory Card.
- Using the supplied battery.
- Starting recording 30 seconds after the camera is turned on.
(When the Optical Image Stabilizer is set to [(|||)].)
- Taking a picture **once every 30 seconds** using full flash every second time.
- Rotating the zoom lever from Tele to Wide or vice versa for every shot.
- Turning the camera off every 10 recordings and leaving it until the temperature of the battery decreases.

The number of recordable pictures varies depending on the recording interval time. If the recording interval time becomes longer, the number of recordable pictures decreases.

[For example, if you were to take one picture every two minutes, then the number of pictures would be reduced to approximately one-quarter of the number of pictures given above (based upon one picture taken every 30 seconds).]

■ Recording motion pictures (when using the monitor)

- **With camera models 18 194 / 18 195:**
Recording with picture quality set to [FHD/20M/30p]
- **With camera models 18 193 / 18 196:**
Recording with picture quality set to [FHD/20M/25p]

Recordable time	Approx. 140 min
Actual recordable time	Approx. 75 min

- Motion pictures with their file size set to [FHD], [HD] or [VGA] in [Rec Quality]:
Recording stops when the continuous recording time exceeds 29 minutes or the file size exceeds 4 GB.
 - Since the file size becomes larger with [FHD], recording with [FHD] will stop before 29 minutes.
- Motion pictures with their file size set to [4K] in [Rec Quality]:
Recording stops when the continuous recording time exceeds 29 minutes.
(You can continue recording without interruption even if the file size exceeds 4 GB, but the motion picture file will be divided and played back separately.)
- These times are for an ambient temperature of 23°C (73.4°F) and a humidity of 50%RH. Please be aware that these times are approximate.
- Actual recordable time is the time available for recording when repeating actions such as turning the camera on and off, starting/stopping recording, zoom operation, etc.

■ Playback (when using the monitor)

Playback time	Approx. 300 min
----------------------	------------------------

- **The operating times and number of recordable pictures will differ according to the environment and the operating conditions.**
For example, in the following cases, the operating times will be shorter and the number of recordable pictures is reduced.
 - In low-temperature environments, such as on ski slopes.
 - When flash is used repeatedly.
- When the operating time of the camera becomes extremely short even after properly charging the battery, the life of the battery may have expired. Buy a new one.

Inserting and Removing the Card/the Battery

• Make sure the camera is turned off.

- 1** Move the release slider in the direction of the arrow and open the card/battery door.

- Use only the Leica battery BP-DC12.
- We cannot guarantee the quality of any other batteries.

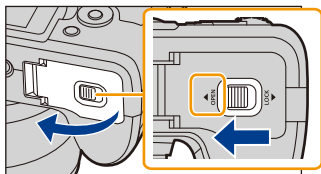

- 2** Insert battery and card.

Be sure to insert in the correct orientation.

Battery: Push it in until it is locked by the lever (A). To remove, pull this lever in the direction of the arrow.

Card: Push it down until it clicks into place.

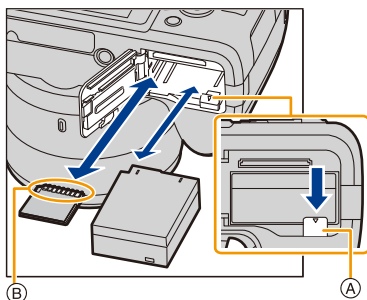

To remove, push it further down until it clicks, then pull it straight out.

(B): Do not touch the connection terminals of the card.

- 3** **1:** Close the card/battery door.
- 2:** Move the release slider in the direction of the arrow.

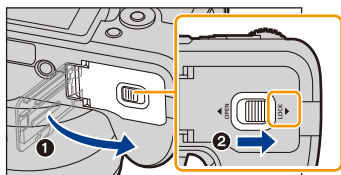

- Remove the battery whenever you will not use the camera for a longer period of time.
(The battery will be exhausted if left for a long period of time after being charged.)
- **The battery becomes warm after using it and during and after charging. The camera also becomes warm during use. This is not a malfunction.**
- Before removing the card or the battery, turn the camera off, and wait until the status indicator has gone off completely.
(Otherwise, the camera may no longer operate normally and the card itself may be damaged or the recorded pictures may be lost.)

About cards that can be used with this camera



The following cards which conform to the SD standard can be used with this camera. (Memory cards are indicated as **card** in the text.)

SD Memory Card (8 MB to 2 GB)	<ul style="list-style-type: none"> • SDHC and SDXC Memory Cards can be used only with compatible devices. • Check that the computer and other equipment is compatible when using SDXC Memory Cards. • This camera is compatible with UHS-I UHS Speed Class 3 standard SDHC/SDXC memory cards. • Only the cards with capacity listed left can be used.
SDHC Memory Card (4 GB to 32 GB)	
SDXC Memory Card (48 GB, 64 GB)	

■ About motion picture recording and speed class

According to [Rec Quality] (P207) of a motion picture, the required card differs. Use a card that meets the following ratings of the SD or UHS Speed Class.

- SD and UHS Speed Class are the speed standards regarding continuous writing. To check the class, see the labelled side, etc. of the card.

[Rec Quality]	Speed class	Label example
FHD/HD/VGA	Class 4 or higher	CLASS  
4K/ High Speed Video	UHS Speed Class 3	

Access to the card

The access indication is displayed in red when pictures are being recorded on the card.



- During access (image writing, reading and deleting, formatting etc.), do not turn the camera off, remove the battery or the card. Furthermore, do not subject the camera to vibration, impact or static electricity.

The card or the data on the card may be damaged, and the camera may no longer operate normally.

If operation fails due to vibration, impact or static electricity, perform the operation again.

- If you set the Write-Protect switch (A) to "LOCK", you may not be able to write, delete or format the data or display it by recording date. These operations become available again when you unlock the switch.
- The data on the card may be damaged or lost due to electromagnetic radiation, static electricity or breakdown of the camera or the card. We recommend storing important data on a computer etc.
- Keep memory cards out of reach of children to prevent swallowing.

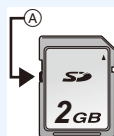

Formatting the card (initialization)

Format the card before recording a picture with the camera.

Since data cannot be recovered after formatting, make sure to back up necessary data in advance.

Select the menu item.

MENU → **X [Setup]** → **[Format]**

- A confirmation screen is displayed. The function is executed when [Yes] is selected.
- Use a battery with sufficient power when formatting.
- Do not turn the camera off during formatting.
- If the card has been formatted on a computer or other equipment, format it again in the camera.
- If the card cannot be formatted, please try another card before contacting a Leica Camera AG service facility.

Approximate number of recordable pictures and available recording time

■ Number of recordable pictures

• [9999+] is displayed if there are more than 10000 pictures remaining.

• Aspect ratio [3:2], Compression rate [■●●]

Resolution	2 GB	8 GB	32 GB	64 GB
L (20M)	175	720	2910	5810
EX M (10M)	320	1310	5310	10510
EX S (5M)	560	2270	9220	17640

• Aspect ratio [3:2], Compression rate [RAW■●]

Resolution	2 GB	8 GB	32 GB	64 GB
L (20M)	56	220	920	1840
M (10M)	65	260	1070	2140
S (5M)	72	290	1170	2340

■ Available recording time (when recording motion pictures)

- “h” is an abbreviation for hour, “m” for minute and “s” for second.
- The recordable time is the total time of all the motion pictures which have been recorded.

[Rec Quality]	2 GB	8 GB	32 GB	64 GB
[4K/100M/30p] ^{*1} [4K/100M/25p] ^{*2}	1m00s	8m00s	40m00s	1h20m
[FHD/28M/60p] ^{*1} [FHD/28M/50p] ^{*2}	7m00s	34m00s	2h25m	5h00m
[FHD/20M/30p] ^{*1} [FHD/20M/25p] ^{*2}	9m00s	45m00s	3h15m	6h40m
[HD/10M/30p] ^{*1} [HD/10M/25p] ^{*2}	20m00s	1h25m	6h20m	12h45m
[VGA/4M/30p] ^{*1} [VGA/4M/25p] ^{*2}	38m00s	3h15m	13h00m	26h00m

*1 With camera models 18 194 / 18 195

*2 With camera models 18 193 / 18 196

- Motion pictures with their file size set to [FHD], [HD] or [VGA] in [Rec Quality]:

Recording stops when the continuous recording time exceeds 29 minutes or the file size exceeds 4 GB.

– Since the file size becomes larger with [FHD], recording with [FHD] will stop before 29 minutes.

- Motion pictures with their file size set to [4K] in [Rec Quality]:

Recording stops when the continuous recording time exceeds 29 minutes.

(You can continue recording without interruption even if the file size exceeds 4 GB, but the motion picture file will be divided and played back separately.)

- The number of recordable pictures and the available recording time are an approximation. (These vary depending on the recording conditions and the type of card.)
- The number of recordable pictures and the available recording time varies depending on the subjects.
- **The maximum available continuous recording time is displayed on the screen.**





Switching the display between the number of recordable pictures and the available recording time

MENU → **/c[Custom]** → **[Remaining Disp.]**

[📷] ([Remaining Shots]):

This will display the number of recordable pictures for still pictures.

[🕒] ([Remaining Time]):

This will display the available recording time for motion pictures.

- [9999+] is displayed if there are more than 10000 pictures remaining.

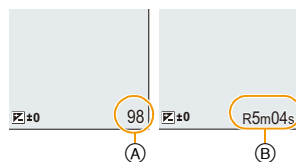

Ⓐ Number of recordable pictures

Ⓑ Available recording time

Setting Date/Time (Clock Set)

• The clock is not set when the camera is shipped.

1 Turn the camera on.

- The status indicator **1** lights up.
- If the language select screen is not displayed, proceed to step 4.



2 Press [MENU/SET].

3 Press ▲/▼ to select the language, and then [MENU/SET].

4 Press [MENU/SET].

5 Press ◀/▶ to select the items (year, month, day, hour, minute), and then ▲/▼ to set.

- (A): Time at the home area
- (B): Time at the travel destination

- You can cancel without setting the clock by pressing [⏪/⏩].

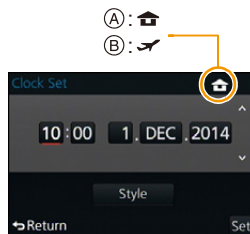

To set the display order and the time display format.

- To display the setting screen of the order/time, select [Style] and then press [MENU/SET].

6 Press [MENU/SET].

- A confirmation screen is displayed. Press [MENU/SET].
- A message prompting you to set [Home] in [World Time] will be displayed. Press [MENU/SET].

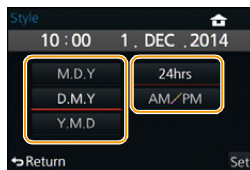

7 Press ◀/▶ to select the home area, and then [MENU/SET].

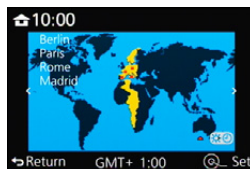

Changing the Clock Setting

Select [Clock Set] in the [Setup] menu. (P36)

- The clock can be reset as shown in steps **5** and **6**.
- **The clock setting is maintained for 3 months using the built-in clock battery even without the battery.**
(Leave the charged battery in the camera for 24 hours to charge the built-in battery.)

- If the clock is not set, the correct date cannot be printed when you stamp the date on the pictures with [Text Stamp] or order a photo studio to print the pictures.

Setting the Menu

The camera features menus that allow you to choose the settings for taking pictures and playing them back as you like. There are also menus that enable you to have more fun with the camera and use it more easily.

In particular, the [Setup] menu contains some important settings relating to the camera's clock and power.

Check the settings of this menu before proceeding to use the camera.

Setting menu items



- If you set [Menu Resume] (P52) in the [Setup] menu to [ON], the screen shows the last selected menu item.
It is set to [ON] at the time of purchase.
- When [Menu Information] (P52) in the [Setup] menu is set to [ON], explanations of the menu items and settings are displayed on the menu screen.





Example: In the [Rec] menu, change [Quality] from [⏏] to [..]

In these instructions, steps for setting a menu item are described as follows.

MENU →  [Rec] → [Quality] → [..]

1 Press [MENU/SET].



 [Rec] (P302)	This menu lets you set the aspect ratio, the resolution and other aspects of the pictures you are recording.
 [Motion Picture] (P216)	This menu lets you set the [Rec Quality], and other aspects for motion picture recording.
 [Custom] (P305)	Operation of the camera, such as displaying of the screen and button operations, can be set up according to your preferences. Also, it is possible to register the modified settings.
 [Setup] (P46)	This menu lets you perform the clock settings, select the operating beep tone settings and set other settings which make it easier for you to operate the camera. You can also configure the settings of Wi-Fi related functions.
 [Playback] (P310)	This menu lets you set the Protection, Cropping or Print Settings, etc. of recorded pictures.

2 Press ▲/▼ to select the menu item and then [MENU/SET].

- The menu item can also be selected by rotating the rear dial.
- You can also switch to the next screen by pressing [DISP].
(It will also switch by rotating the zoom lever)



3 Press ▲/▼ to select the setting and then [MENU/SET].

- The setting can also be made by selecting an option by rotating and then pressing the rear dial.
- Depending on the menu item, its setting may not appear or it may be displayed in a different way.



- There are functions that cannot be set or used depending on the modes or menu settings being used due to the specifications.

■ Close the menu

Press [⏪/⏩] repeatedly until the screen returns to the recording/playback screen.

- In Recording Mode, the menu screen can also be exited by pressing the shutter button halfway.

■ Switching to other menus

e.g.: Switching to the [Setup] menu from [Rec] menu

- 1 Press ◀.
- 2 Press ▲/▼ to select [⌘] or another of the menu toggle icons.
- 3 Press [MENU/SET].
 - Select a menu item next and set it.



Quick Menu

By using the Quick Menu, a selection of menu settings can be easily found.

- The features that can be adjusted using Quick Menu are determined by the mode or a display style the camera is in.

The [Q.MENU]/[FN3] button can be used in two ways, as [Q.MENU] or as [FN3] (function 3).

At the time of purchase, it is initially set to [Q.MENU].

- Refer to [P43](#) for details about the function button.

1 Press [Q.MENU] to display the Quick Menu.

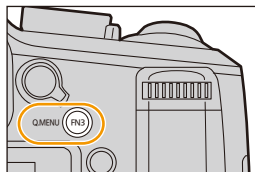

2 Rotate the rear dial to select the menu item, then press it.

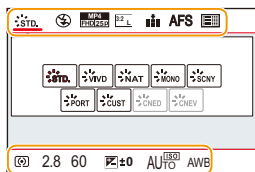

3 Rotate the rear dial to select the setting.

- You can also set items by pressing the cursor buttons ▲/▼/◀/▶.

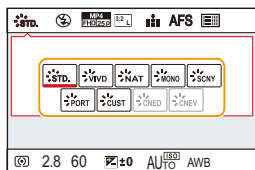

4 Press [Q.MENU] to exit the menu once the setting is complete.



Switching the method for setting Quick Menu items

MENU → **/C[Custom]** → **[Q.MENU]**

[PRESET]:

The default items can be set.

[CUSTOM]:

The Quick Menu will consist of desired items. (P41)

Using Quick Menu items on the on-monitor recording information screen of **[]** (monitor style) (P63)

(Press [DISP] repeatedly until the screen is displayed.)

Press [Q.MENU], rotate the rear dial to select an item, and then press the rear dial.

Rotate the rear dial to select the setting, and then press the rear dial to set it.

- You can also set with **▲/▼/◀/▶** and [MENU/SET].

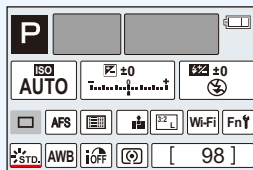

Customizing Quick Menu

When [Q.MENU] (P40) in the [Custom] menu is set to [CUSTOM], the Quick Menu can be changed as desired.

Up to 15 items can be assigned to the Quick Menu.

1 Press **▼** to select [Q.] and then [MENU/SET].

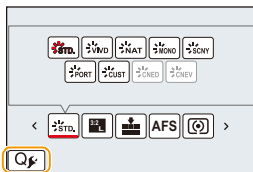

2 Press **▲/▼/◀/▶** to select the menu item in the top row and then [MENU/SET].

3 Press **◀/▶** to select the empty space in the bottom row and then [MENU/SET].

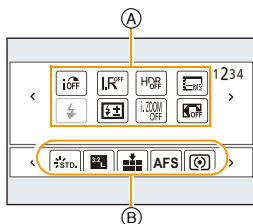

Ⓐ Items that can be assigned to the Quick Menu.

Ⓑ Items that can be displayed in the Quick Menu screen.

- If there is no empty space in the bottom row, you can replace an existing item with another item by selecting the existing item.
- To cancel the setting, move to the bottom row by pressing **▼** and select an item to cancel, and then press [MENU/SET].
- Items that can be assigned are the following:

[Rec] menu/Recording functions	
<ul style="list-style-type: none"> – [Photo Style] (P122) – [Picture Setting] ([Aspect Ratio] (P131)/[Picture Size] (P132)) – [Quality] (P133) – [AFS/AFF] (P140) – [Metering Mode] (P164) – [Burst Rate] (P168) – [Auto Bracket] (P171) – [Self Timer] (P173) – [i.Dynamic] (P135) – [i.Resolution] (P135) – [HDR] (P136) 	<ul style="list-style-type: none"> – [Shutter Type] (P165) – [Flash Mode] (P201) – [Flash Adjust.] (P205) – [i.Zoom] (P196) – [Digital Zoom] (P197) – [Stabilizer] (P193) – [Sensitivity] (P161) – [White Balance] (P126) – [AF Mode] (P139) – [Macro Mode] (P156)



[Motion Picture] menu	[Custom] menu
– [Motion Pic. Set] ([Rec Quality] (P207)) – [Picture Mode] (P214)	– [Silent Mode] (P184) – [Peaking] (P153) – [Histogram] (P65) – [Guide Line] (P65) – [Zebra Pattern] (P191) – [Monochrome Live View] (P192) – [Rec Area] (P211) – [Zoom Lever] (P198) – [Manual ring (Zoom)] (P198)

4 Press [↵/⏪].

- The screen of step 1 will reappear.
Press [MENU/SET] to switch to the recording screen.

Assigning Frequently Used Functions to the Function Buttons

You can assign frequently-used functions to particular buttons.

1 Select the menu item.

MENU → **/c[Custom]** → **[Fn Button Set]**

2 Press ▲/▼ to select [Setting in REC mode] or [Setting in PLAY mode] and then [MENU/SET].

3 Press ▲/▼ to select the function button you want to assign a function to and then [MENU/SET].

4 Press ▲/▼ to select the function you want to assign and then [MENU/SET].

- Refer to [P44](#) for [Setting in REC mode] and [P45](#) for [Setting in PLAY mode].
- To restore the default function button settings, select [Restore to Default].

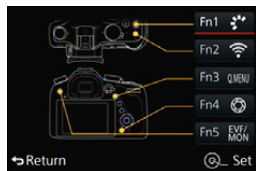

The function button settings available for recording

You can use assigned functions by pressing a function button when recording.

- The following functions can be assigned to the buttons [Fn1], [Fn2], [Fn3], [Fn4] or [Fn5].

[Rec] menu/Recording functions	
– [Wi-Fi] (P246): [Fn2]*	– [Highlight Shadow] (P124)
– [Q.MENU] (P39): [Fn3]*	– [i.Dynamic] (P135)
– [EVF/Monitor Switch] (P57): [Fn5]*	– [i.Resolution] (P135)
– [AF/AE LOCK] (P158)	– [HDR] (P136)
– [AF-ON] (P152, 158)	– [Shutter Type] (P165)
– [Preview] (P91): [Fn4]*	– [Flash Mode] (P201)
– [One Push AE] (P92)	– [Flash Adjust.] (P205)
– [Level Gauge] (P66)	– [i.Zoom] (P196)
– [Focus Area Set] (P45)	– [Digital Zoom] (P197)
– [Photo Style] (P122): [Fn1]*	– [Stabilizer] (P193)
– [Aspect Ratio] (P131)	– [Sensitivity] (P161)
– [Picture Size] (P132)	– [White Balance] (P126)
– [Quality] (P133)	– [AF Mode/MF] (P139)
– [AFS/AFF] (P140)	– [Macro Mode] (P156)
– [Metering Mode] (P164)	– [Restore to Default]
– [Burst Rate] (P168)	
– [Auto Bracket] (P171)	
– [Self Timer] (P173)	
[Motion Picture] menu	
– [Motion Pic. Set] ([Rec Quality] (P207))	– [Picture Mode] (P214)
[Custom] menu	
– [Silent Mode] (P184)	– [Zebra Pattern] (P191)
– [Peaking] (P153)	– [Monochrome Live View] (P192)
– [Histogram] (P65)	– [Rec Area] (P211)
– [Guide Line] (P65)	– [Zoom Lever] (P198)
	– [Manual ring (Zoom)] (P198)

* Function button settings at the time of purchase.



- Some functions cannot be used depending on the mode or displayed screen.
- When set to [Focus Area Set], it is possible to display the position setting screen of either the AF area or MF Assist.

Not available in these cases:

- [FN1] cannot be used in the following cases.
 - [Miniature Effect]/[One Point Color]/[Sunshine] (Creative Control Mode)
 - [Multi Exp.]
- [FN2] cannot be used during Time Lapse Shooting.

The function button settings available for playback

You can directly set an assigned function to a selected image by pressing the function button during playback.

- The following functions can be assigned to the buttons [FN1], [FN2], [FN3], or [FN5].

[Playback] Menu/Playback functions	
– [Favorite] (P239): [Fn3]*	– [Delete Single] (P73)
– [Print Set] (P240)	– [Off]: [Fn1]*/[Fn2]*/[Fn5]*
– [Protect] (P242)	– [Restore to Default]

* Function button settings at the time of purchase.

Using the function buttons during playback

Example: When [FN3] is set to [Favorite]

- 1 Press ◀▶ to select the picture.
- 2 Press [FN3], and then set the image as [Favorite].
 - When assigning [Print Set], set the number of pictures to be printed next.
 - When assigning [Delete Single], select [Yes] on the confirmation screen.





Configuring basic settings (Setup Menu)

 For details on how to select the [Setup] menu settings, refer to P36.

[Clock Set] and [Economy] are important items.
Check their settings before using them.

[Clock Set]	—
--------------------	---

• Refer to P34 for details.

[World Time]	<p>Set the time in your home area and travel destination. You can display the local times at the travel destinations and record them on the pictures you take.</p>
	<p>• Set [Home] first thing after purchasing. [Destination] can be set after setting up [Home].</p> <p>After selecting [Destination] or [Home], press ◀/▶ to select an area, and then [MENU/SET] to set.</p> <p> [Destination]: Travel destination area</p> <p>(A) Current time of the destination area (B) Time difference from home area</p> <p> [Home]: Your home area</p> <p>(C) Current time (D) Time difference from GMT (Greenwich Mean Time)</p> <div style="display: flex; justify-content: space-around;"> <div data-bbox="663 640 968 822"> </div> <div data-bbox="663 851 968 1035"> </div> </div>

- Press ▲ if you are using Daylight Savings Time []. (The time will move forward by 1 hour.)
Press ▲ once more to return to the normal time.
- If you cannot find the travel destination in the areas displayed on the screen, set by the time difference from the home area.

[Travel Date]	<p>Departure date and return date of the trip as well as the name of the travel destination can be set. You can display the number of days that have passed when playing back the pictures and stamp it on the recorded pictures with [Text Stamp] (P231).</p> <hr/> <p>[Travel Setup]:</p> <p>[SET]: Departure date and return date are set. Elapsed days (how many days after) of the trip are recorded.</p> <p>[OFF]</p> <ul style="list-style-type: none">• The travel date is automatically canceled if the current date is after the return date. If the [Travel Setup] is set to [OFF], [Location] will also be set to [OFF]. <p>[Location]:</p> <p>[SET]: Travel destination is recorded at the time of recording.</p> <p>[OFF]</p> <ul style="list-style-type: none">• For details on how to enter characters, refer to “Entering Text” on P54.
<ul style="list-style-type: none">• The travel date is calculated using the date in the clock setting and the departure date you set. If you set [World Time] to the travel destination, the travel date is calculated using the date in the clock setting and the travel destination setting.• [Location] cannot be recorded when taking motion pictures.	
[Wi-Fi]	[Wi-Fi Function]/[Wi-Fi Setup]
<ul style="list-style-type: none">• Refer to 272 for details.	

[Beep]	Set the volume for electronic noises and the electronic shutter noise.	
	[Beep Volume]: (High) (Low) (OFF)	[Shutter Vol.]: (High) (Low) (OFF)

- When [Silent Mode] is set to [ON], [Beep Volume] and [Shutter Vol.] are set to [OFF].

[Live View Mode]	Set the frame rate of the recording screen (Live View screen).	
	[30fps]: Reduces the power consumption, extending the operating time. [60fps]: Displays movements smoother.	



- When [Live View Mode] is set to [30fps] the image quality on the recording screen may be worse than when it is set to [60fps], but this does not affect the recorded image.
- In a dark environment, the frame rate may become slower.

[Monitor Display]/ [Viewfinder]	Brightness, color, or red or blue tint of the monitor/viewfinder is adjusted.	
	[] ([Brightness]): For adjusting the brightness. [] ([Contrast · Saturation]): For adjusting the contrast or clarity of colors. [] ([Red Tint]): For adjusting the red tint. [] ([Blue Tint]): For adjusting the blue tint.	
<ol style="list-style-type: none"> Select the settings by pressing ▲/▼, and adjust with ◀/▶. <ul style="list-style-type: none"> • Adjusting can also be performed by rotating the rear dial. Press [MENU/SET] to set. 		

- This will adjust the monitor when the monitor is in use, and the viewfinder when the viewfinder is in use.
- Some subjects may appear differently than in reality on the monitor. However, this does not affect the recorded pictures.

[Monitor Luminance]	Sets the monitor brightness according to the ambient light level. [A]* [AUTO]: The brightness is adjusted automatically depending on how bright it is around the camera. [1]* [MODE1]: Brightens the monitor image. [2]* [MODE2]: Set the monitor to the standard brightness. [3]* [MODE3]: Darkens the monitor image.
----------------------------	--

- The brightness of images displayed on the monitor is enhanced, so some subjects may appear different than in reality. However, this does not affect recorded pictures.
- The monitor automatically returns to standard brightness if no operations are performed for 30 seconds when recording in [MODE1]. It will light up brightly again with button operation.
- When [AUTO] or [MODE1] is set, the usage time is reduced.
- [AUTO] is only available in the Recording Mode.

<p>[Economy]</p>	<p>The camera can be set up to prevent unnecessary battery consumption.</p>
	<p>[Sleep Mode]: The camera is automatically turned off if it has not been used for the time selected on the setting. [10MIN.]/[5MIN.]/[2MIN.]/[1MIN.]/[OFF]</p> <p>[Auto EVF/Monitor Off]: The monitor/viewfinder is automatically turned off if the camera has not been used for the time selected on the setting. [5MIN.]/[2MIN.]/[1MIN.]</p>
<ul style="list-style-type: none"> • Press the shutter button halfway or turn the camera off and on to cancel [Sleep Mode]. • To turn the monitor/viewfinder on again, press any button. • When the monitor/viewfinder automatic switching (P56) is activated, [Auto EVF/Monitor Off] is canceled. • [Economy] does not work in the following cases. <ul style="list-style-type: none"> – When connecting to a computer or a printer – When recording or playing back motion pictures – During a slide show – [Multi Exp.] – [Time Lapse Shot] – When [Auto Shooting] in [Stop Motion Animation] is set to [ON]. – When connect with HDMI in Recording Mode. 	
<p>[USB Mode]</p>	<p>Select the USB communication system when connecting the camera to your computer or your printer with the USB connection cable (supplied).</p> <p> [Select on connection]: Select either [PC] or [PictBridge(PTP)] if you connected the camera to a computer or a printer supporting PictBridge.</p> <p> [PictBridge(PTP)]: Set when connecting to a printer supporting PictBridge.</p> <p> [PC]: Set when connecting to a computer.</p>

[TV Connection]	<ul style="list-style-type: none">• This sets how the camera connects to a television etc. <p>[Video Out]: (Menu item only available with camera models 18 193 / 18 196.) Set to match the color television system in each country.</p> <p>[NTSC]: Video output is set to NTSC system.</p> <p>[PAL]: Video output is set to PAL system.</p> <ul style="list-style-type: none">• This will operate when an AV or an HDMI micro cable is connected.
	<p>[TV Aspect]: Set to match the type of TV.</p> <p>[16:9]: When connecting to a 16:9 screen TV.</p> <p>[4:3]: When connecting to a 4:3 screen TV.</p> <ul style="list-style-type: none">• This will work when an AV cable is connected. <p>[HDMI Mode (Play)]: Set the format for the HDMI output when playing back on the HDMI compatible high-definition TV connected with the camera using an HDMI micro cable.</p> <p>[AUTO]: The output resolution is automatically set based on the information from the connected TV.</p> <p>[4K]: The progressive method with 2160 available scan lines is used for output. The output size is set to 3840×2160.</p> <p>[1080p]: The progressive method with 1080 available scan lines is used for output.</p> <p>[1080i]: The interlace method with 1080 available scan lines is used for output.</p> <p>[720p]: The progressive method with 720 available scan lines is used for output.</p> <p>[576p]^{*1}/[480p]^{*2}: The progressive method with 576^{*1}/480^{*2} available scan lines is used for output.</p> <ul style="list-style-type: none">*1When [Video Out] is set to [PAL]*2When [Video Out] is set to [NTSC] <ul style="list-style-type: none">• This will work when an HDMI micro cable is connected.• This will work only during playback.• If no image appears on the TV with [AUTO], switch the setting to a constant setting other than [AUTO] to set a format supported by your TV. (Please read the instructions for the TV.)

<p>[TV Connection] (continued)</p>	<p>[HDMI Info Display (Rec)]: Set whether or not to display information when recording an image on the camera while monitoring it on a TV.</p> <p>[ON]: The camera display is output as is.</p> <p>[OFF]: Only images are output.</p> <ul style="list-style-type: none"> • This will work when an HDMI micro cable is connected. • When the camera is connected to a TV, lower the volume of the TV. <p>[HDTV Link]: Settings that allow the camera to be controlled by the remote control of the HDTV equipment by automatically coupling the camera with the HDTV Link compatible equipment using an HDMI micro cable.</p> <p>[ON]: Remote control operation of the HDTV Link compatible equipment is enabled. (Not all operations are possible) Button operation of the main unit will be limited.</p> <p>[OFF]: Operation is performed with the buttons on the camera.</p> <ul style="list-style-type: none"> • This will work when an HDMI micro cable is connected. • Refer to P278 for details.
---	--

<p>[Menu Resume]</p>	<p>Stores the location of the last-used menu item for each menu.</p> <p>[ON]/[OFF]</p>
-----------------------------	---

<p>[Menu Information]</p>	<p>Explanations of the menu items and settings are displayed on the menu screen.</p> <p>[ON]/[OFF]</p>
----------------------------------	---

<p>[Language]</p>	<p>Sets the language displayed on the screen.</p>
--------------------------	---

- If you set a different language by mistake, select  from the menu icons to set the desired language.

2. Preparations before Recording

[Version Disp.]	—
	<ul style="list-style-type: none">• It is possible to check which firmware version is on the camera.• Press [MENU/SET] on the version display screen to display information about the software in the camera.
[Exposure Comp. Reset]	An exposure value can be reset when the Recording Mode is changed or the camera is turned off. [ON]/[OFF]
[No.Reset]	Resets the file number of the next recording to 0001. <ul style="list-style-type: none">• The folder number is updated and the file number starts from 0001.• A folder number between 100 and 999 can be assigned. When the folder number reaches 999, the number cannot be reset. We recommend formatting the card (P30) after saving the data on a computer or elsewhere.• To reset the folder number to 100, format the card first and then use this function to reset the file number. A reset screen for the folder number will then appear. Select [Yes] to reset the folder number.
[Reset]	The recording or setup/custom settings are reset to the default. <ul style="list-style-type: none">• When the recording setting is reset, the content of the following settings is also reset.<ul style="list-style-type: none">– The [Face Recog.] setting• When the setup/custom settings are reset, the following settings are also reset.<ul style="list-style-type: none">– The [World Time] (home area) setting (If the camera is turned on and off, the home area setting screen is displayed.)– The settings of [Travel Date] (departure date, return date, location)– The [Profile Setup] setting– The settings of [Rotate Disp.], [Picture Sort] and [Delete Confirmation] in the [Playback] menu• The folder number and the clock setting are not changed.
[Reset Wi-Fi Settings]	Reset all settings in the [Wi-Fi] menu to factory default settings. <ul style="list-style-type: none">• Always reset the camera when disposing or selling it to prevent personal information saved within the camera from being misused.• Always reset the camera after making a copy of personal information when sending the camera in to be repaired.
[Format]	—
	<ul style="list-style-type: none">• Refer to P30 for details.

Entering Text

It is possible to enter children's and pets' names and the locations when recording.

When a screen that looks like the one on the right is displayed, you can enter characters.

(Only alphabetical characters and symbols can be entered.)

• Example of operation for displaying a screen:

MENU →  **[Rec]** → **[Profile Setup]** → **[SET]** →
[Baby1] → **[Name]** → **[SET]**



1 Press ▲/▼/◀/▶ to select text and then [MENU/SET] to register.

- Move the cursor to [^A_a] and then press [MENU/SET] to switch text between [A] (capitals), [a] (lower case), [1] (numbers) and [&] (special characters). (You can also switch text by pressing [DISP].)
- To enter the same characters in a row, move the cursor by rotating the rear dial to the right.
- The following operations can be performed by moving the cursor to the item and pressing [MENU/SET]:
 - []: Enter a blank
 - [Delete]: Delete a character
 - [◀]: Move the entry position cursor to the left
 - [▶]: Move the entry position cursor to the right
- A maximum of 30 characters can be entered.
(Maximum of 9 characters when setting names in [Face Recog.])
- A maximum of 15 characters can be entered for [\], [Γ], [J], [•] and [–].
(Maximum of 6 characters when setting names in [Face Recog.])

2 Press ▲/▼/◀/▶ to move the cursor to [Set] and then [MENU/SET] to end text input.

- Text can be scrolled if all of the entered text does not fit on the screen.

3.

Basic Operation

Tips for taking good pictures

Hold the camera firmly with both hands, keep your arms still at your side and stand with your feet slightly apart.

- Do not cover the flash, the AF Assist lamp (A), the microphone (B) (P15) or the speaker with your fingers or other objects.
- Be careful not to move the camera when you press the shutter button.
- When taking pictures, make sure your footing is stable and there is no danger of colliding with another person, an object etc.

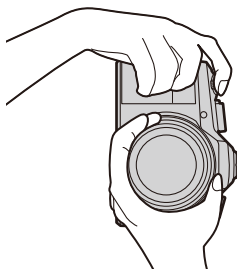
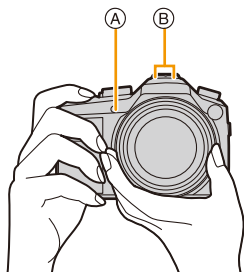

- Do not hold the lens barrel as you take pictures. There is a risk that your finger may be pinched if the lens retracts.

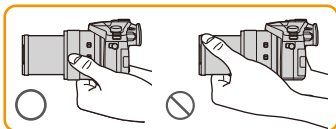

Camera Direction Detection Function

This function detects when you shoot with the camera vertically orientated.

When you play back the picture, the recording is automatically displayed in vertical orientation.

(Only available when [Rotate Disp.] (P238) is set to [ON].)

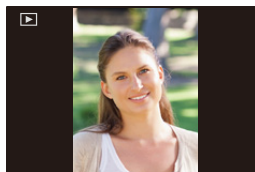

- When the camera is held vertically and tilted significantly up or down during shooting, the Direction Detection Function may not work correctly.
- Motion pictures taken with the camera held vertically are not displayed vertically.

Using the Viewfinder

[EVF] button (Switching between Monitor and Viewfinder)

Press [EVF] to switch between monitor and viewfinder.

Ⓐ Eye sensor

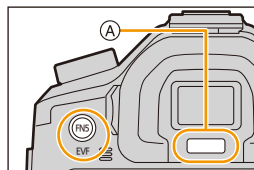

[EVF]/[FN5] button can be used in two ways, as [EVF] or as [FN5] (function 5). At the time of purchase, it is initially set to [EVF/Monitor Switch].

• Refer to P43 for details about the function buttons.

Press [EVF].

• The monitor/viewfinder will switch as follows:

Automatic viewfinder/ monitor switching*

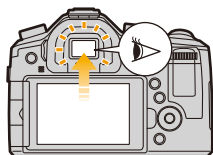

Viewfinder display*

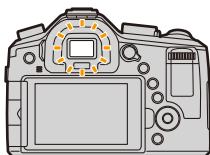

Monitor display

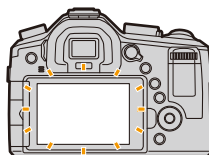

* If [Eye Sensor AF] in the [Custom] menu is set to [ON], the camera automatically adjusts the focus as the eye sensor is activated. (P57)

• You can also switch between the viewfinder and the monitor in [EVF/Monitor Switch] in [Eye Sensor] in the [Custom] menu. (P57)

■ Using the eye sensor to switch between monitor and viewfinder

Automatic viewfinder/monitor switching enables the eye sensor to switch the display to the viewfinder automatically when you bring your eye or an object near it.

- The eye sensor might not work properly depending on the shape of your eyeglasses, the way you hold the camera, or bright light shining around the eyepiece. In that case, press [EVF] to switch the display.
- During motion picture playback or a slide show, the camera does not automatically switch the display to the viewfinder with the eye sensor.
- You can set the eye sensor sensitivity in [Eye Sensor] in the [Custom] menu. (P57)



Setting the eye sensor sensitivity and the method for switching between monitor and viewfinder

MENU →  [Custom] → [Eye Sensor]

[Sensitivity]	This will set the sensitivity of the eye sensor. [HIGH]/[LOW]
[EVF/Monitor Switch]	This will set the method for switching between monitor and viewfinder. [^{EVF}/_{MON} AUTO.] (automatic switching between monitor and viewfinder)/ [EVF] (viewfinder)/[MON] (monitor) • If you press [EVF] to switch the display, the [EVF/Monitor Switch] setting will also switch.

■ Diopter adjustment

Adjust the diopter to suit your vision so that you can see the viewfinder displays clearly.

Look at the display in the viewfinder and rotate the diopter adjustment dial until the displays on the screen are in focus.

Ⓐ Diopter adjustment dial

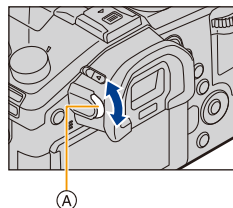

About Eye Sensor AF

If [Eye Sensor AF] in the [Custom] menu is set to [ON], the camera automatically focuses whenever activated by the eye sensor.

- Eye Sensor AF focuses only once when you look through the viewfinder, i.e. focusing is not performed continuously.

- Beep sounds are not emitted when focusing is completed in [Eye Sensor AF].

Not available in these cases:

- [Eye Sensor AF] may not work in dimly lit conditions.

Taking a Still Picture

- Set the drive mode dial to [□] (single recording).

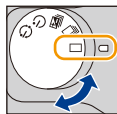

- 1 Select the Recording Mode. (P61)
- 2 Press the shutter button halfway to focus.

- (A) Aperture value
- (B) Shutter speed

- Aperture value and shutter speed are displayed. (They will flash in red if the correct exposure is not achieved, except when set to flash.)

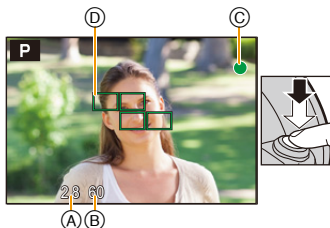

Focusing	When the subject is focused	When the subject is not focused
Focus indication (C)	On	Flashes
AF area (D)	Green	—
Sound	Beeps 2 times	Beeps 4 times

- The focus indication is displayed as [●_{LOW}] in a dark environment, and focusing may take longer than usual.

- When the Focus Mode is set to [AFF] or [AFC].
 - A beep will be emitted when focus is first achieved by pressing the shutter button halfway.
 - If AF Mode is set to [Custom Multi], such as [|||||] or [-----], the AF area is displayed for a moment only when focus is achieved for the first time by pressing the shutter button halfway.

- 3 Press the shutter button fully down to take the picture.



About the focusing range

The focusing range is displayed when operating the lens' zoom function.

- The focusing range is displayed in red when the subject is not focused after pressing the shutter button halfway.

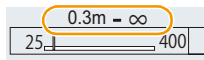

The focusing range may change gradually depending on the zoom position.

e.g.: Focusing range during the Program Mode

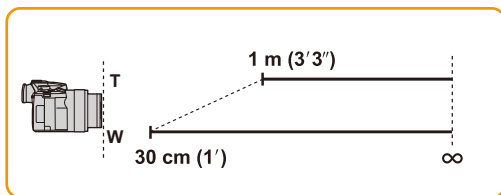

Subjects and shooting conditions which are difficult to focus

- Fast-moving, extremely bright subjects or those without contrast
- When shooting subjects through windows or near shiny objects
- When it is dark or when camera shake occurs
- When the camera is too close to the subject or when taking a picture of both distant and near subjects



Displaying a picture right after it is taken

MENU → **/c[Custom]** → **[Auto Review]**

[Duration Time]	Set the length of time that the picture is displayed after taking a still picture. [HOLD]: The picture is displayed until the shutter button is pressed halfway. [5SEC]/[4SEC]/[3SEC]/[2SEC]/[1SEC]/[OFF]	
[Playback Operation Priority]	[ON]	Switching the display of the playback screen, deleting pictures, etc. is possible during [Auto Review].
	[OFF]	Button operations during [Auto Review] are the same as those for recording.

- When [Duration Time] is set to [HOLD], [Playback Operation Priority] is fixed to [ON].

Recording Motion Pictures

This camera records motion pictures in the MP4 format.
Audio will be recorded in stereo.

1 Start the recording by pressing the motion picture button.

- (A) Elapsed recording time
- (B) Remaining available recording time

- Recording of motion pictures appropriate for each mode is possible.
- The recording state indicator (red) (C) will flash while recording motion pictures.
- If approximately 1 minute elapses without an operation being performed, part of the display will disappear. Press [DISP] to let the display reappear. This operation is to prevent screen burn-in and is not a malfunction.
- When recording a motion picture, do not cover the microphone with your fingers or other objects.
- Release the motion picture button right after you press it.

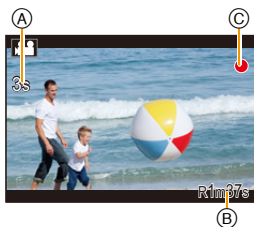
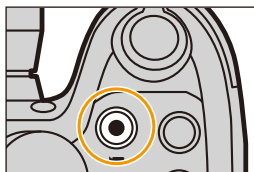

2 Stop the recording by pressing the motion picture button again.

- For details, refer to “Recording Motion Pictures” on P210.
- It is recommended that you close the flash when recording motion pictures.
- You can operate the lens' zoom function even when recording motion pictures.
- Still picture recording is also possible during motion picture recording by fully pressing the shutter button. (P214)

Selecting the Recording Mode

Change modes by rotating the mode dial.

Align the desired mode as shown.

- Make sure the dial is set exactly to the click-stop position of the desired mode. (The mode dial rotates 360°)

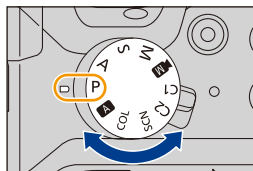

A Snapshot Mode (P75)

For taking pictures with extended automatic settings.

A⁺ Snapshot Plus Mode (P75)

Allows you to adjust the brightness and color hue when in Snapshot Mode.

P Program Mode (P84)

For taking pictures with automatic exposure control.

A Aperture-Priority Mode (P86)

The exposure is determined by the automatically controlled shutter speed, based on the manually set aperture value.

S Shutter-Priority Mode (P87)

The exposure is determined by the automatically controlled aperture value, based on the manually set shutter speed.

M Manual Exposure Mode (P88)

The exposure is determined by the manually set aperture value and shutter speed.



Creative Video Mode (P118)

Records a motion picture with the aperture value and the shutter speed you specify. In this recording mode, all the motion picture functions become available. For example, you can record motion pictures in 4K.

* You cannot take still pictures.

C1 C2 Custom Mode (P120)

Use this mode to take pictures with previously registered settings.

Scene Guide Mode (P93)

For taking pictures with preset menu settings that match the encountered scene.

Creative Control Mode (P107)

For shooting while checking the image effect.



Displaying/not displaying the selection screen when the mode dial is switched to SCN/COL .

MENU → **/c[Custom]** → **[Menu Guide]**

[ON]:

Displays the selection screen for the Scene Guide or the Creative Control Mode.

[OFF]:

Displays the recording screen of the currently selected mode of the Scene Guide or the Creative Control Mode.

Switching the Information Displayed on the Recording Screen

Press [DISP] to change.

- You can select between [] (monitor style) and [] (viewfinder style) for each of the monitor and the viewfinder display screens using [Monitor Disp. Style] and [EVF Disp. Style] in the [Custom] menu.



[] monitor style

- The screen will switch as follows:
(Example of the monitor displays)

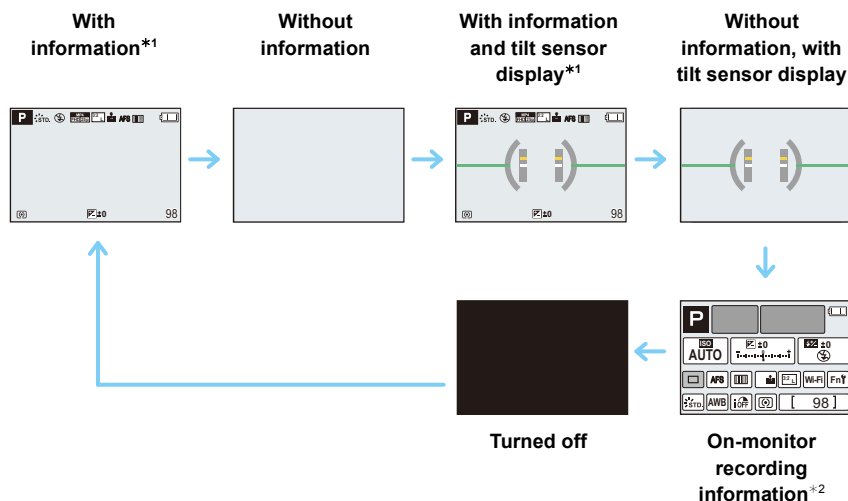

*1 The histogram is displayed when [Histogram] in the [Custom] menu is set to [ON]. It is also possible to display the shutter speed/aperture indication by setting the [Expo.Meter] of the [Custom] menu to [ON]. (P84)

*2 This is displayed when the [Monitor Info. Disp.] of the [Custom] menu is set to [ON]. (P65)
You can record images using the viewfinder while checking recording information on the monitor.



(viewfinder style)

- The screen will switch as follows:
(Example of the displays in viewfinder)

**With information
(detailed
information)***



**With basic
information**



**With detailed
information and
tilt sensor
display***

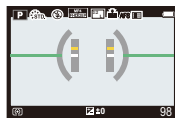

**With basic
information and
tilt sensor display**



- * The histogram is displayed when [Histogram] in the [Custom] menu is set to [ON]. It is also possible to display the shutter speed/aperture indication by setting the [Expo.Meter] of the [Custom] menu to [ON]. (P84)

- If approximately 1 minute elapses without an operation being performed, part of the display will disappear. Press [DISP] to make the display reappear. This operation is to prevent screen burn-in and is not a malfunction.

Switching the display method of the monitor

MENU → **/C[Custom]** → **[Monitor Disp. Style]**

(): viewfinder style

(): monitor style

Switching the display method of the viewfinder

MENU → **/C[Custom]** → **[EVF Disp.Style]**

(): viewfinder style

(): monitor style



Displaying/not displaying the histogram

MENU → **/C[Custom]** → **[Histogram]** → **[ON]/[OFF]**

You can set the position by pressing **▲/▼/◀/▶**.

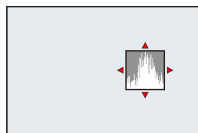

- A Histogram is a graph that displays brightness along the horizontal axis (black to white) and the number of pixels at each brightness level on the vertical axis.

It allows you to easily check a picture's exposure.

(A) dark

(B) bright

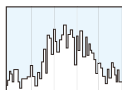

(A) ← → (B)

- **When the recorded picture and the histogram do not match each other under the following conditions, the histogram is displayed in orange.**

– When the Manual Exposure Assistance is other than [0] during exposure compensation or in the Manual Exposure Mode

– When the flash is activated

– When a suitable exposure is not achieved with the flash closed

– When the brightness of the screen is not correctly displayed in dark places

- The histogram in Recording Mode is an approximation.

- The histogram displayed in this camera may not match Histograms displayed by picture editing software used in computers etc.

Displaying/not displaying the guide lines

MENU → **/C[Custom]** → **[Guide Line]** → **[]/[]/[]/[OFF]**

- The guide lines are not displayed in [Panorama Shot] in Scene Guide Mode.

When [] is set, guideline positions can be set by pressing **▲/▼/◀/▶**.

▶.



Displaying/not displaying the on-monitor recording information screen

MENU → **/C[Custom]** → **[Monitor Info. Disp.]** → **[ON]/[OFF]**

■ About the tilt display

With the tilt display, it is easy to correct the camera's alignment.

- 1 Press **[DISP]** to call up the tilt display.
- 2 Check the camera's alignment.

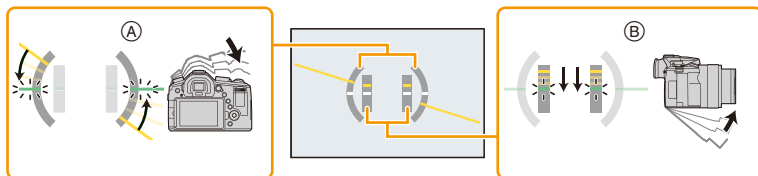

- (A) Horizontal direction:
Correcting tilt to the left
- (B) Vertical direction:
Correcting downward tilt
- When the camera is only slightly tilted, the indicator changes to green.
 - When recording with a vertical orientation, the display automatically switches to a vertically oriented display.

- Even when the tilt indications are green, there may still be an error of approximately $\pm 1^\circ$.
- When a function button is set to [Level Gauge] is assigned to a function button, the tilt display can be switched on/off by pressing that function button.

Not available in these cases:

- The tilt may not be displayed correctly when the camera is in motion.
- When tilted significantly upwards or downwards during shooting, the tilt display may not be displayed correctly, and the Direction Detection Function (P55) may not work correctly.

Playing Back Pictures/Motion Pictures

Playing Back Pictures

1 Press [▶].

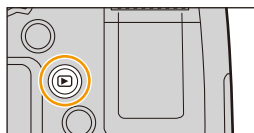

2 Press ◀/▶.

◀: Play back the previous picture

▶: Play back the next picture

- If you press and hold ◀/▶, you can play back the pictures in succession.
- Speed of picture Forwarding/Rewinding changes depending on the playback status.



■ To finish playback

Press [▶] again, press the motion picture button or press the shutter button halfway.

- The lens barrel retracts about 15 seconds after switching from Recording to Playback Mode.

ⓘ Not available in these cases:

- This camera complies with the DCF standard "Design rule for Camera File system" established by JEITA "Japan Electronics and Information Technology Industries Association" and with Exif "Exchangeable Image File Format". Files which do not comply with the DCF standard cannot be played back.
- The camera may not play back images recorded on other devices correctly, and the functions of the camera may not be available for the images.

Using the Playback Zoom

Rotate the zoom lever towards [T].

1× → 2× → 4× → 8× → 16×

- When you change the magnification, the zoom/position indication (A) appears for about 1 second.
- The more a picture is enlarged, the more its quality deteriorates.
- You can move the enlarged part by pressing ▲/▼/◀/▶ of the cursor button.



Displaying multiple screens (Multi Playback)

Rotate the zoom lever towards [W].

1 image → 12 images → 30 images → Calendar screen display

- Pictures displayed using [!] cannot be played back.

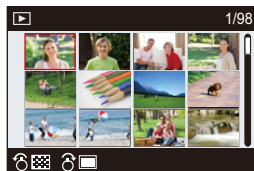

■ To return to Normal Playback

Press ▲/▼/◀/▶ to select a picture and then [MENU/SET].

Displaying Pictures by Recording Date (Calendar Playback)

- 1 Rotate the zoom lever towards [W] to display the calendar screen.
- 2 Press ▲/▼/◀/▶ to select the date to be played back.



- 3 Press [MENU/SET] to display the images that are recorded in selected date.
- 4 Press ▲/▼/◀/▶ to select a picture and then [MENU/SET].
 - To return to the calendar screen, rotate the zoom lever towards [W].

- The recording date of the picture selected in the playback screen becomes the date selected when the Calendar screen is first displayed.
- You can display the calendar between January 2000 and December 2099.
- If the date is not set in the camera, the recording date is set as the 1st January, 2014.
- If you take pictures after setting the travel destination in [World Time], the pictures are displayed by the dates at the travel destination in Calendar Playback.

Playing Back Motion Pictures

In **Playback Mode**, select a picture with the motion picture icon ([]), and then press **▲** to play back.

Ⓐ Motion picture recording time

- After playback starts, the elapsed playback time is displayed on the screen.

For example, 8 minutes and 30 seconds is displayed as [8m30s].



- High Speed Video images are displayed with recording time and playback time.

Ⓑ Playback time

Ⓒ Motion picture recording time

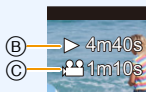

Operations during Motion Picture Playback

▲	Play/Pause	▼	Stop
◀	Fast rewind*	▶	Fast forward*
	Frame-by-frame rewind (while pausing)		Frame-by-frame forward (while pausing)
Rear dial (rotate to the left)	Reduce volume level	Rear dial (rotate to the right)	Increase volume level

* The fast forward/rewind speed increases if you press **▶**/**◀** again.

- To playback the motion pictures recorded by this camera on a computer, use the available software (P280).

• **With camera models 18 194 / 18 195:**

Motion pictures recorded with [Miniature Effect] in Creative Control Mode play back at approximately 10 times speed.

• **With camera models 18 193 / 18 196:**

Motion pictures recorded with [Miniature Effect] in Creative Control Mode play back at approximately 8 times speed.

Changing the information displayed on the playback screen

Press [DISP] to switch the displays.



• The screen will switch as follows:

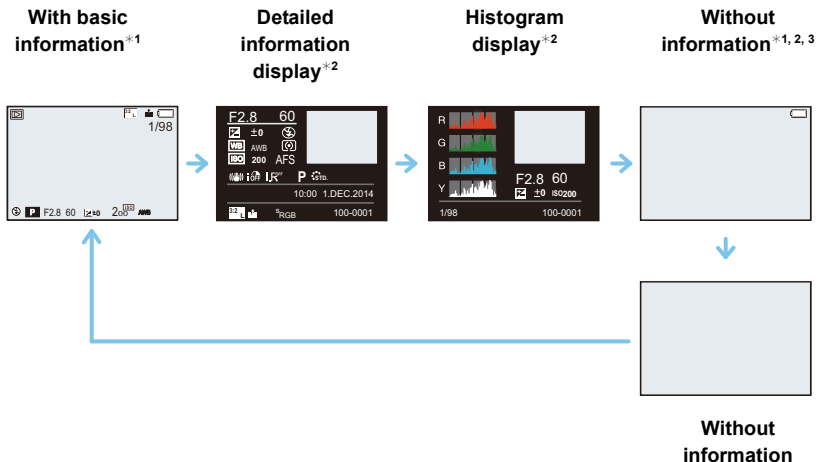

*1 If approximately 1 minute elapses without an operation being performed, part of the display will disappear. Press [DISP] to make the display reappear. This operation is to prevent screen burn-in and is not a malfunction.

*2 Not displayed while using the playback zoom or during motion picture playback, sequential playback, panorama playback or a slide show.

*3 This is displayed if [Highlight] (P72) in the [Custom] menu is set to [ON].

• Histogram (color) is displayed in R (red), G (green), B (blue), and Y (luminance) during playback.



Displaying/not displaying white saturated areas

MENU → **/c[Custom]** → **[Highlight]** → **[ON]/[OFF]**

When the Auto Review function is activated or when playing back, white saturated areas appear flashing in black and white.

This does not affect the recorded image.

- If there are any white saturated areas, it may prove beneficial to decrease the exposure ([P160](#)) referring to the histogram ([P65](#)) and then taking the picture again. It may result in a better quality picture.
- This does not work while in Multi Playback, Calendar Playback, or Playback Zoom.

[ON]



[OFF]



Deleting Pictures

Once deleted, pictures cannot be recovered.

- Pictures that are not in the DCF standard or those that are protected cannot be deleted.

To delete a single picture

- 1 In Playback Mode, select the picture to delete and then press [Fn4/⏏].

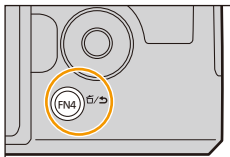

- 2 Press ▲ to select [Delete Single] and then [MENU/SET].

- A confirmation screen is displayed.
The picture is deleted by selecting [Yes].



- [Delete Confirmation] in the [Playback] menu enables you to set which option on the delete confirmation screen, [Yes] or [No], will be highlighted first. The default setting is [No]. (P244)
- A single picture can be deleted directly by pressing the function button to which [Delete Single] has been set. (P45)

To delete multiple pictures (up to 100*) or all the pictures

- * Picture groups are treated as a single picture.
(All the pictures in the selected picture group will be deleted.)

1 In Playback Mode, press [⏪/⏩].

2 Press ▲/▼ to select [Delete Multi] or [Delete All] and then [MENU/SET].

- The [Delete All] → Confirmation screen is displayed.
Pictures are deleted by selecting [Yes].
- It is possible to delete all pictures except the ones set as favorite when [All Delete Except Favorite] is selected with the [Delete All] set.

3 (When [Delete Multi] is selected)

Press ▲/▼/◀/▶ to select the picture, and then [MENU/SET] to set. (Repeat this step.)

- [⏪] appears on the selected pictures.
If [MENU/SET] is pressed again, the setting is canceled.

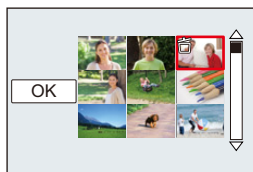

4 (When [Delete Multi] is selected)

Press ◀ to select [OK], and then [MENU/SET].

- A confirmation screen is displayed.
Pictures are deleted by selecting [Yes].

- Do not turn the camera off while deleting. Use a battery with sufficient battery power.
- Depending on the number of pictures to be deleted, the operation may take some time.

Using the Snapshot Modes

Modes:  

When you wish to leave settings to the camera and record without thinking about them, use Snapshot Plus Mode or Snapshot Mode, which makes optimal settings for the subject and scene.

About Snapshot Plus and Snapshot Modes

- Functions that can be set differ between Snapshot Plus and Snapshot Modes.
(○: possible, —: not possible)

	Snapshot Plus Mode	Snapshot Mode
Setting the brightness (P83)	○	—
Setting the color tone (P83)	○	—
Defocus Control (P82)	○	○
Menus that can be set	Refer to P79 for details.	Refer to P79 for details.

1 Set the mode dial to [].

- The camera will switch to the Snapshot Mode that was used most recently.
At the time of purchase, the mode is set to Snapshot Plus Mode.

2 Frame your subject.

- When the camera identifies the optimum scene mode, the respective icon is displayed in blue for 2 seconds, after which its color changes to the usual red.
- If you press ◀ and then press the shutter button halfway, the AF tracking function will be activated.
For details, refer to P142.



Switching between Snapshot Plus and Snapshot Modes

1 Press [MENU/SET].

- Press ◀, and then ▲/▼ to select [A+] or [A].



2 Press ◀/▶ to select [A+] or [A] and then [MENU/SET].

- Press [DISP] to display the description of the selected mode.



Scene Detection

When taking pictures

A	→		[i-Portrait]
			[i-Scenery]
			[i-Macro]
			[i-Night Portrait]*1
			[i-Night Scenery]
			[iHandheld Night Shot]*2
			[i-Food]
			[i-Baby]*3
			[i-Sunset]





*1 Only displayed when the built-in flash is open.







*2 Only displayed when [iHandheld Night Shot] is set to [ON]. (P80)

*3 When [Face Recog.] is set to [ON], [i-Baby] will be displayed for birthdays of registered faces (P187) already set only when the Face/Eye of a person 3 years old or younger is detected.









When recording motion pictures





A	→		[i-Portrait]
			[i-Scenery]
			[i-Low Light]
			[i-Macro]

- [**A**] is set if none of the scene modes are applicable, and the standard settings are set.
- When [, [, or [] is set, an eye closer to the camera will be in focus, while the exposure will be optimized for the face. In Snapshot Plus or Snapshot Mode, you cannot change the eye in focus. (**Face/Eye Detection**)
- If a tripod is used, for instance, and the camera has judged that camera shake is minimal when the appropriate scene mode has been identified as [, the shutter speed will be slower than normal. Take care not to move the camera while taking pictures.
- During AF Tracking, Scene Detection does not work until the subject is locked.
- When [Face Recog.] is set to [ON], and the face similar to the registered face is detected, [R] is displayed in the top right of [, [, and [].

- Due to conditions such as the ones below, a different scene may be identified for the same subject.
 - Subject conditions: When the face is bright or dark, the size, color and shape of the subject, the distance to the subject, the contrast of the subject, when the subject is moving
 - Recording conditions: Sunset, sunrise, under low brightness conditions, when the camera is shaken, when the lens' zoom function is used

■ About flash operation

Flash mode is set to [] when the flash is closed, and [^A] (AUTO) when it is open. When the flash is open, the camera automatically sets [^A], [] (AUTO/Red-Eye Reduction), [^S], or [^S] to match the type of subject and brightness.

- **Open the flash when you want to use it. (P199)**
- When [], [] is set, Red-Eye Removal is enabled.
- The shutter speed will be slower during [^S] or [^S].

■ Functions that work automatically

- The following functions are performed automatically to allow the camera to make the optimal settings.
 - Scene Detection
 - Backlight Compensation
 - [Face/Eye Detection]
 - Auto White Balance
 - Intelligent ISO sensitivity control
 - [Red-Eye Removal]
 - [i.Resolution]
 - [i.Dynamic]
 - [Long Shtr NR]
 - [Quick AF]
 - [AF Assist Lamp]
 - [Level Shot]

■ Menus that can be set

Only the following menus can be set.

Snapshot Plus Mode	
Menu	Item
[Rec]	[Photo Style]/[Aspect Ratio]/[Picture Size]/[Quality]/[AFS/AFF]/[Burst Rate]/[Auto Bracket]/[Self Timer]/[Time Lapse/Animation]/[iHandheld Night Shot]/[iHDR]/[Shutter Type]/[Color Space]/[Stabilizer]/[Face Recog.]/[Profile Setup]
[Motion Picture]	[Photo Style]/[Rec Quality]/[AFS/AFF]/[Continuous AF]/[Mic Level Disp.]/[Mic Level Adj.]/[Mic Level Limiter]/[Wind Cut]/[Zoom Mic]
[Custom]	[Silent Mode]/[Half Press Release]/[Pinpoint AF Time]/[Focus/Release Priority]/[AF+MF]/[MF Assist]/[MF Guide]/[Peaking]/[Histogram]/[Guide Line]/[Center Marker]/[Highlight]/[Zebra Pattern]/[Monochrome Live View]/[Constant Preview]/[Expo. Meter]/[Dial Guide]/[EVF Disp. Style]/[Monitor Disp. Style]/[Monitor Info. Disp.]/[Rec Area]/[Remaining Disp.]/[Auto Review]/[Fn Button Set]/[Zoom Lever]/[Manual ring (Zoom)]/[Zoom Resume]/[Q.MENU]/[Video Button]/[Eye Sensor]/[Menu Guide]
[Setup]	All menu items can be set. (P46)

Snapshot Mode	
Menu	Item
[Rec]	[Aspect Ratio]/[Picture Size]/[AFS/AFF]/[Burst Rate]/[Self Timer]/[Time Lapse/Animation]/[iHandheld Night Shot]/[iHDR]/[Face Recog.]
[Motion Picture]	[Rec Quality]/[AFS/AFF]
[Custom]	[Silent Mode]/[Guide Line]/[Remaining Disp.]
[Setup]	All menu items can be set. (P46)



Backlight Compensation

- When there is a backlight situation, the main subject would be rendered darker and therefore the camera will automatically attempt to correct it by increasing the overall brightness of the picture.

In Snapshot Plus or Snapshot Mode, backlight compensation works automatically.



Recording night scenes

Available modes:  



When [iHandheld Night Shot] is set to [ON] and  is detected while taking handheld night shots, a series of pictures of the night scenery will be taken at a high frame rate and composed into a single picture.

This mode is useful if you want to take stunning night shots with minimal camera shake and noise, without using a tripod.

MENU →  **[Rec]** → **[iHandheld Night Shot]** → **[ON]/[OFF]**

- The angle of view will be slightly narrower.
- A message notifying that multiple pictures will be taken is displayed. Do not move the camera during the continuous shooting after pressing the shutter button.
- If the camera is mounted on a tripod or other type of stand,  will not be detected.
- Flash is fixed to  (flash off).

Not available in these cases:

- [iHandheld Night Shot] does not work for the pictures taken during a motion picture recording.
- This function is not available in the following cases:
 - When [Quality] is set to [RAW , [RAW ] or [RAW]
 - When using [Time Lapse Shot]
 - When using [Stop Motion Animation] (only when [Auto Shooting] is set)

Combining pictures into a single picture with rich gradation

Available modes:  

When [iHDR] is set to [ON] and there is, for example, strong contrast between the brightest and the darkest parts of the scene, multiple still pictures are recorded with differing exposures and combined to create a single still picture rich in gradation. [iHDR] works automatically as needed. When it does, [HDR] is displayed on the screen.

MENU →  **[Rec]** → **[iHDR]** → **[ON]/[OFF]**

- The angle of view will be slightly narrower.
- A message notifying that multiple pictures will be taken is displayed. Do not move the camera during the continuous shooting after pressing the shutter button.
- You cannot take the next picture until the combination of pictures is complete.
- A moving subject may be recorded with unnatural blur.

Not available in these cases:

- [iHDR] does not work for the pictures taken during a motion picture recording.
- This function is not available in the following cases:
 - When recording using the flash
 - When recording in Continuous Mode
 - When recording with Auto Bracket
 - When [Quality] is set to [RAW₁], [RAW₂] or [RAW]
 - When using [Time Lapse Shot]
 - When using [Stop Motion Animation] (only when [Auto Shooting] is set)

Taking a picture with a blurred background (Defocus Control)

Available modes:  

You can easily set the blurriness of the background while checking the screen.

1 Press the rear dial to display the setting screen.

- Each time the rear dial is pressed in Snapshot Plus Mode, the camera switches between brightness setting (P83), Defocus Control, and normal operation.
- Each time the rear dial is pressed in Snapshot Mode, the camera switches between Defocus Control and normal operation.

2 Set the blurriness by rotating the rear dial.







Strong defocus

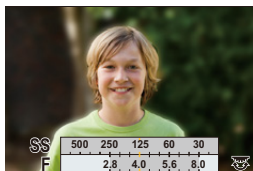

Weak defocus



3 Take the picture/the motion picture.

- Pressing  on the blurriness setting screen will cancel the setting.
- In Snapshot Mode ( or ), the Autofocus Mode is set to .

Changing the brightness or color tone

Mode: 

This mode enables you to change the brightness and color tone to your preferred settings as opposed to the ones set by the camera.

Setting brightness

- 1 **Press the rear dial to display the setting screen.**
 - Each press of the rear dial switches between brightness setting, Defocus Control (P82) and end operation.
- 2 **Rotate the rear dial to adjust the brightness.**

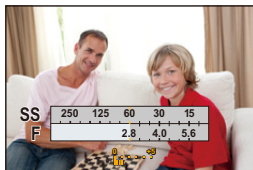

Setting color

- 1 **Press ► to display the setting screen.**
- 2 **Rotate the rear dial to adjust the color.**
 - This will adjust the color of the image from a reddish to a bluish color.
 - Press [MENU/SET] to return to the recording screen.



- If the [Exposure Comp. Reset] is set to [ON], the brightness setting will return to the default level (center point) when the camera is turned off or switched to another recording mode.
- The color setting will return to the default level (center point) when the camera is turned off or switched to another recording mode.

Program Mode

Mode: **P**

The camera automatically sets the shutter speed and the aperture value according to the brightness of the subject.

You can also change various settings in the [Rec] menu.

1 Set the mode dial to **[P]**.

2 Press the shutter button halfway to display the aperture and shutter speed values on the screen.

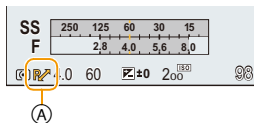

- If the exposure is not adequate when the shutter button is pressed halfway, the aperture value and shutter speed turn red and flash.

3 While the values are displayed (about 10 seconds), you can perform Program Shift by rotating the rear dial.

- Every time the rear dial is pressed while the values are displayed, it will switch between Program Shift and Exposure Compensation setting (P160).
 - The Program Shift indication **A** appears on the screen.
 - To cancel Program Shift, turn the camera off or rotate the rear dial until the Program Shift indication disappears.
- Program Shift can easily be canceled by setting a function button to [One Push AE]. (P92)

fc Displaying/not displaying the shutter speed/aperture indication

MENU → **/c[Custom]** → **[Expo.Meter]** → **[ON]/[OFF]**

- When [Expo.Meter] is set to [ON], the shutter speed/aperture indication **B** will be displayed when performing Program Shift, setting the aperture value or the shutter speed.
- Unsuitable areas of the range are displayed in red.
- When the shutter speed/aperture indication is not displayed, switch the display information for screen by pressing [DISP]. (P63)
- The shutter speed/aperture indication disappears after approximately 4 seconds if no operation is performed.

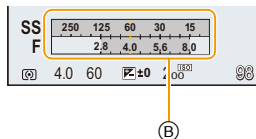

Program Shift

In Program Mode, you can change the preset aperture value and shutter speed combinations without changing the exposure. This is called Program Shift. You can e.g. reduce the extent of the sharply rendered subject parts by decreasing the aperture value or record a moving subject more dynamically by slowing the shutter speed.

Example of Program Shift

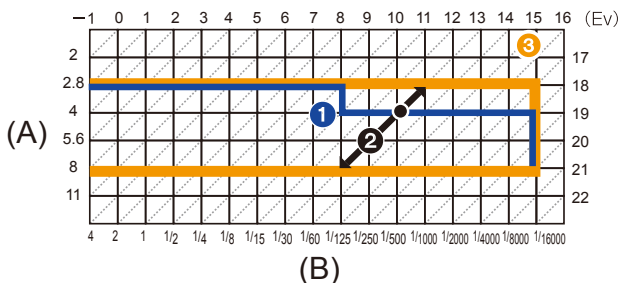

(A): Aperture value

(B): Shutter speed

① Program Shift line chart

Represents the aperture and shutter speed set automatically by the camera at each exposure value.

② Program Shift range

Represents the range of the aperture and shutter speed combinations available with Program Shift at each exposure value.

③ Program Shift limit

Represents the possible apertures and shutter speeds you can select when you use Program Shift.

• “EV” is an abbreviation of “Exposure Value”.

The EV changes with the aperture value or the shutter speed.

Not available in these cases:

• Program Shift is available in all [Sensitivity] settings except [ISO].

Aperture-Priority Mode

Mode: **A**

Set the aperture value to a higher number when you want a larger in-focus area (in front of and behind the main subject), or to a lower number for the opposite.

- 1 Set the mode dial to **[A]**.
- 2 Rotate the rear dial to set the aperture value.

- (A) Aperture Value setting
- (B) Shutter speed/aperture indication



Aperture value:

Use lower values to decrease the in-focus area (depth of field)



Aperture value:

Use higher values to increase the in-focus area (depth of field)

- Every time the rear dial is pressed while the values are displayed it will switch between aperture and Exposure Compensation setting.

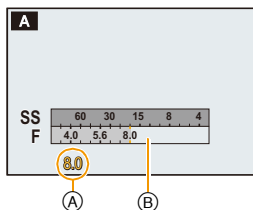

Available Aperture Values*	Shutter Speeds
F2.8 to F8.0	60 to 1/4000s (with the mechanical shutter) 1 to 1/16000s (with the electronic shutter)

* Depending on the lens' focal length setting (zoom position), some of the values cannot be selected.

- Rotate the rear dial to display the shutter speed/aperture indication. Unsuitable areas of the range are displayed in red.
- If the exposure is not adequate, the aperture value and the shutter speed turn red and flash when the shutter button is pressed halfway.
- The effects of the set aperture value and shutter speed will not be visible on the recording screen. To check on the recording screen, please use [Preview]. (P91)
- The brightness of the screen and the recorded pictures may differ. Check the pictures in Playback Mode.

Shutter-Priority Mode

Mode: **S**

Set a faster shutter speed if you want to take a sharp picture of a subject moving fast, or a slower shutter speed if you want to create e.g. subject blur to emphasize a movement

- 1 Set the mode dial to **[S]**.
- 2 Rotate the rear dial to set the shutter speed.

- (A) Shutter Speed setting
(B) Shutter speed/aperture indication

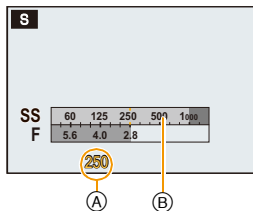
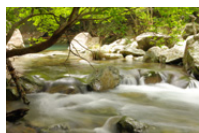

Shutter speed:

Use slower speeds to increase the impression of movement

Shutter speed:

Use faster speeds to freeze movements, i.e. to render them as sharp as desired

- Every time the rear dial is pressed while the values are displayed it will switch between shutter speed setting and Exposure Compensation operation (P160).

Available Shutter Speeds	Aperture Values
60 to 1/4000s (with the mechanical shutter) 1 to 1/16000s (with the electronic shutter)	F2.8 to F8.0

- Rotate the rear dial to display the shutter speed/aperture indication. Unsuitable areas of the range are displayed in red.
- If the exposure is not adequate, the aperture value and the shutter speed turn red and flash when the shutter button is pressed halfway.
- We recommend using a tripod when the shutter speed is slow.
- The [Sensitivity] is automatically set to [AUTO] when you switch the recording mode to Shutter-Priority Mode while the [Sensitivity] is set to [ISO].
- The effects of the set aperture value and shutter speed will not be visible on the recording screen. To check on the recording screen, please use [Preview]. (P91)
- The brightness of the screen and the recorded pictures may differ. Check the pictures in Playback Mode.

Manual Exposure Mode

Mode: **M**





Determine the exposure by manually setting the aperture value and the shutter speed. The light balance scale appears at the bottom of the screen to indicate the over-/under-/correct exposure resulting from the respective settings.

- 1 Set the mode dial to [M].
- 2 Rotate the rear dial to set aperture and shutter speed.

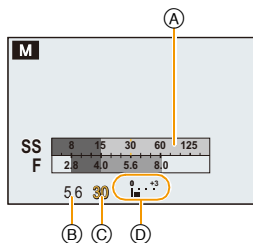
- Every time the rear dial is pressed while the values are displayed it will switch between aperture and shutter speed setting.

- (A) Shutter speed/aperture combination
- (B) Aperture value setting
- (C) Shutter speed setting
- (D) Light balance



Aperture value	 <p>Lower Use to decrease the in-focus area (depth of field)</p>	 <p>Higher Use to increase the in-focus area (depth of field)</p>
Shutter speed	 <p>Slower Use to increase the impression of movement</p>	 <p>Faster Use to freeze movements, i.e. to render them as sharp as desired</p>



Available Aperture Values*	Available Shutter Speeds
F2.8 to F8.0	[B] (Bulb), 60 to 1/4000s (with the mechanical shutter) 1 to 1/16000s (with the electronic shutter)

* Depending on the lens' focal length setting (zoom position), some of the values cannot be selected.



Light Balance

	The exposure is appropriate.
	Set to faster shutter speed and/or a larger aperture value.
	Set to slower shutter speed and/or a smaller aperture value.

• The Light Balance is an approximation. We recommend checking the pictures in Playback Mode.

About [B] (Bulb)

If you set the shutter speed to [B], the shutter stays open as long as the shutter button is pressed fully (up to about 120 seconds).

The shutter closes when you release the shutter button.

Use this mode when you want to keep the shutter open for a long time to take pictures of fireworks, a night scene etc.

- If you set the shutter speed to [B], [B] is displayed on the screen.
- When you take pictures with the shutter speed set to [B], use a sufficiently charged battery.

(P23)

- The Light Balance does not appear.
 - When the ISO sensitivity is set to [AUTO], it will switch to [125].
- This function is not available when using the electronic shutter.
- It can only be used with Manual Exposure mode.





- We recommend using a tripod when you take pictures with the shutter speed set to [B].
- When you take pictures with the shutter speed set to [B], noise may become visible. To avoid this, we recommend setting [Long Shtr NR] in the [Rec] menu to [ON] before taking pictures. (P137)



Checking/not checking the effects of aperture and shutter speed on the recording screen

MENU → **/c[Custom]** → **[Constant Preview]** → **[ON]/[OFF]**

- Close the flash.
- It can only be used with Manual Exposure Mode.

- Rotate the rear dial to display the shutter speed/aperture combination. Unsuitable areas of the range are displayed in red.
- If the exposure is not appropriate, the aperture value and the shutter speed turn red and flash when the shutter button is pressed halfway.
- We recommend using a tripod when the shutter speed is slow.
- When the ISO sensitivity is set to [iISO], it will switch to [AUTO].
- The effects of the set aperture value and shutter speed will not be visible on the recording screen. To check on the recording screen, please use [Preview]. (P91)
- The brightness of the screen and the recorded pictures may differ. Check the pictures in Playback Mode.

Confirming the Effects of Aperture and Shutter Speed (Preview Mode)

Available in the following modes: **A** **Av** **P** **A** **S** **M** **C1** **C2** **SCN** **COL**

The effects of aperture and shutter speed can be checked by using the Preview Mode.

• Confirming the effects of the aperture:

You can check the depth of field (in-focus range) before taking a picture. This is achieved by closing the diaphragm to the aperture value you set.

• Confirming the effects of shutter speed:

Movement sharpness can be checked by displaying what the picture will look like that is taken with the shutter speed you set. In the case of higher shutter speeds, the display in the shutter speed preview will be like a time-release film. It is used in cases such as stopping the movement of running water.

1 Assign [Preview] to a function button. (P43)

- The following step is an example in which [Preview] is assigned to [FN4].

2 Switch to the confirmation screen by pressing [FN4].

- The screen is switched every time [FN4] is pressed.

Normal recording screen



Effects of the aperture



Effects the shutter Speed



Depth of field properties

	Aperture value	Lower	Higher
*1	Focal length (Zoom position)	Longer (Tele)	Shorter (Wide)
	Distance to the subject	Closer	Further
	Depth of field (in-focus range)	Shallower ^{*2}	Deeper ^{*3}

*1 Recording conditions

*2 Example: When you want to take a picture with a blurred background etc.

*3 Example: When you want to take a picture with everything in focus including the background etc.

- It is possible to record while in Preview Mode.
- Range for shutter speed effect check is 8 to 1/16000s.

Easily setting aperture/shutter speed for a suitable exposure (One Push AE)

Available in the following modes:

When the exposure setting is too bright or too dark, you can use one push AE to achieve a suitable one.



How to tell if the exposure is not appropriate

- If the aperture and shutter speed values flash red (A) when the shutter button is pressed halfway.
 - If the Light Balance is anything other than when in Manual Exposure Mode.
- For more details on the Light Balance, refer to P89.

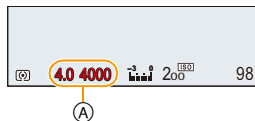

1 Assign [One Push AE] to a function button. (P43)

- The following step is an example in which [One Push AE] is assigned to [FN1].

2 (When exposure is not appropriate)

Press [FN1].

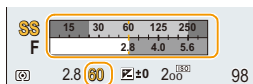

- The shutter speed/aperture combination is displayed, and they are changed to give a suitable exposure.
- The shutter speed/aperture combination is not displayed in Creative Video Mode.
- In the following cases, suitable exposure cannot be set.
 - When the subject is extremely dark and it is not possible to achieve an appropriate exposure by changing the aperture value or shutter speed
 - When recording using the flash
 - In Preview Mode (P91)

- In Program Mode, Program Shift can be canceled by pressing the function button to which [One Push AE] has been assigned.

Using the Scene Modes

Recording mode: **SCN**

When you select a Scene mode to match the subject and recording situation, the camera sets the optimal exposure, hue, and focus to obtain the desired picture.

- 1** Set the mode dial to [SCN].
- 2** Press ◀/▶ to select the scene mode.
- 3** Press [MENU/SET] to set.

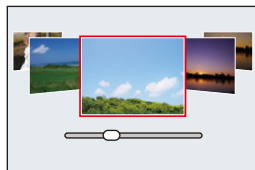

■ Switching the scene selection screen display

Press [DISP] to switch the monitor screen.

- Each time [DISP] is pressed, the scene selection screen is switched.

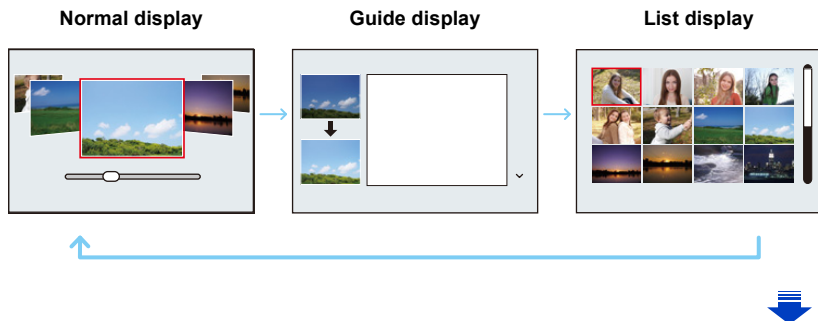



To enjoy a variety of picture effects

When the scene selection screen display is set to the guide display, tips for creating picture effects suitable for each type of scene, etc. is displayed.

To enjoy a wider variety of picture effects, we recommend that you read them before taking pictures.

- Pages can be switched by pressing ▲/▼.

- To change Scene Guide Mode, select the [SCN] tab on the menu screen, select [Scene Switch], and then press [MENU/SET]. You can return to step 2.
- The following items cannot be set in Scene Guide Mode because the camera automatically adjusts them to the optimal setting.
 - Items other than the picture quality adjustment in [Photo Style]
 - [Sensitivity]
- Although White Balance is fixed to [AWB] for certain scene modes, you can fine tune the White Balance or use White Balance bracketing by pressing the cursor button ► on the recording screen.
For further details, please read P129, 130.

 For details on “Scene Guide Mode” settings, refer to [P93](#).

[Clear Portrait]



The brightness of the face is adjusted and the background is defocused to create a clear portrait.

 **Tip**

- You can enhance the effect by using as long a focal length as possible and by keeping the distance between the camera and the subject as short as possible.

[Silky Skin]

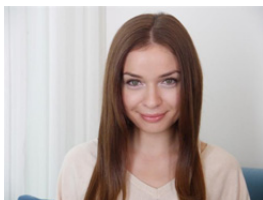

Brighter face and softer skin color creates a healthy younger look.

 **Tip**

- You can enhance the effect by using as long a focal length as possible and by keeping the distance between the camera and the subject as short as possible.
- The smoothing effect is applied to the part that has a similar tone to the complexion of a subject, as well.
- This mode may not be effective under insufficient lighting.

[Backlit Softness]



When backlit, the overall screen brightness is increased. Portraits are softened and rendered brighter.

[Clear in Backlight]

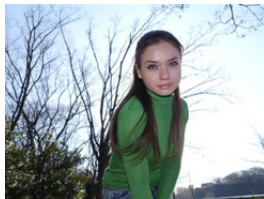

Outdoors, the flash will be used to match the brightness of the subject's face to the surroundings.

Tips

- **Open the flash.** (You can set to [$\frac{1}{2}$].)
- White saturation can occur if the subject is too close.
- Flash pictures taken closer or beyond the flash's rated distance may appear too bright or too dark.
- When [Silent Mode] is set to [ON], the flash is not activated.

[Relaxing Tone]



The warm color tone creates an image with a relaxing mood.

[Sweet Child's Face]



Moderate background defocusing and skin tone highlighted draws attention to the child's face.

Tip

- You can enhance the effect by using as long a focal length as possible and by keeping the distance between the camera and the subject as short as possible.

[Distinct Scenery]



Saturation of sky and trees creates more distinct scenery.

[Bright Blue Sky]

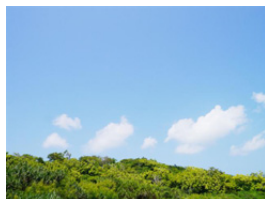

On a sunny day, the overall screen brightness is increased to create a vibrant image of the blue sky.

[Romantic Sunset Glow]

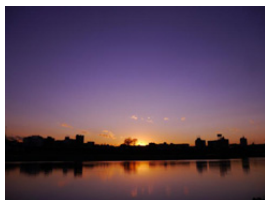

The enhanced purple tone creates a romantic image of the sky just after sunset.

[Vivid Sunset Glow]

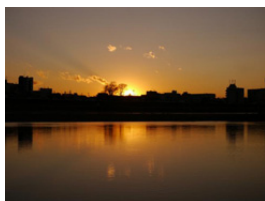

Red is enhanced to create a vivid image of the sunset.

[Glistening Water]

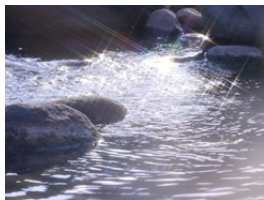

The glisten of the water is enhanced to look brighter and slightly bluish.

- The display of the recording screen will be delayed more than usual and the screen will look as if frames are dropping.
- The star filter used in this mode may also cause glistening effects on objects other than water surface.

[Clear Nightscape]



Color saturation of the night light is increased to accentuate the nightscape.

 **Tip**

- We recommend using a tripod and the self-timer.
- The shutter may remain closed after taking the picture. This is due to signal processing and is not a malfunction.
- Noise may become visible when you take pictures in dark places.

[Cool Night Sky]



Blue tones are enhanced to create a cool and sophisticated image of the night sky after sunset.

 **Tip**

- We recommend using a tripod and the self-timer.
- The shutter may remain closed after taking the picture. This is due to signal processing and is not a malfunction.
- Noise may become visible when you take pictures in dark places.

[Warm Glowing Nightscape]

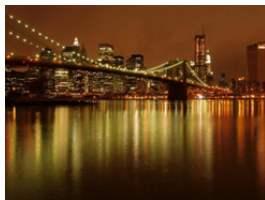

The warm color tone creates a warm image of the nightscape.

 **Tip**

- We recommend using a tripod and the self-timer.
- The shutter may remain closed after taking the picture. This is due to signal processing and is not a malfunction.
- Noise may become visible when you take pictures in dark places.

[Artistic Nightscape]



A slow shutter speed captures light trails that create an artistic nightscape.

 **Tip**

- We recommend using a tripod and the self-timer.
- The shutter may remain closed after taking the picture. This is due to signal processing and is not a malfunction.
- Noise may become visible when you take pictures in dark places.

[Glittering Illuminations]



The star filter enhances pinpoints of light.

 **Tip**

- We recommend using a tripod and the self-timer.
- Display of the recording screen will be delayed more than usual and the screen will look as if frames are dropping.
- The shutter may remain closed after taking the picture. This is due to signal processing and is not a malfunction.
- Noise may become visible when you take pictures in dark places.

[Handheld Night Shot]



Multiple images are captured and the data is combined to minimize blur and noise for hand-held shooting with night scenery.



Tip

- Do not move the camera during the continuous shooting after pressing the shutter button.
- The angle of view will be slightly narrower.

[Clear Night Portrait]



Fill flash and a longer exposure capture better portraits against the nightscape.



Tips

- **Open the flash.** (You can set to [$\frac{1}{S}$].)
- We recommend using a tripod and the self-timer.
- When [Clear Night Portrait] is selected, request the subject to remain still for about 1 second after taking the picture.
- When [Silent Mode] is set to [ON], the flash is not activated.
- The shutter may remain closed after taking the picture. This is due to signal processing and is not a malfunction.
- Noise may become visible when you take pictures in dark places.

[Soft Image of a Flower]

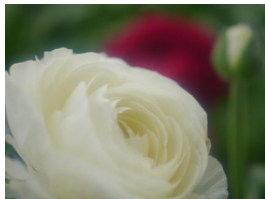

The soft focus creates a diffused image.

Tips

- We recommend using a tripod and the self-timer.
- For close-up recording, we recommend that you close the flash.
- The display of the recording screen will be delayed more than usual and the screen will look as if frames are dropping.
- For information on the focus range, refer to “About the focusing range” on [P59](#).
- In close-up photography, the in-focus range (depth of field) is generally very shallow. Therefore, if the distance between the camera and the subject is changed after focusing on the subject, it may become difficult to focus on it again.
- Closer parts of the scene are prioritized when taking pictures, and so time is required to focus if you take a picture of a distant subject.
- When you take pictures at close range, the resolution at the edges of the frame may decrease slightly. This is not a malfunction.
- If the front lens surface gets dirty with fingerprints or dust, it may not be able to focus on the subject correctly. ([P327](#))

[Appetizing Food]



The overall screen brightness is increased to make the food look appealing.

 **Tip**

- You can enhance the effect by using as long a focal length as possible and by keeping the distance between the camera and the subject as short as possible.
- We recommend using a tripod and the self-timer.
- For close-up recording, we recommend that you close the flash.

[Cute Dessert]



The overall screen brightness is set higher to enhance the cuteness of the dessert.

 **Tip**

- You can enhance the effect by using as long a focal length as possible and by keeping the distance between the camera and the subject as short as possible.
- We recommend using a tripod and the self-timer.
- For close-up recording, we recommend that you close the flash.

[Freeze Animal Motion]

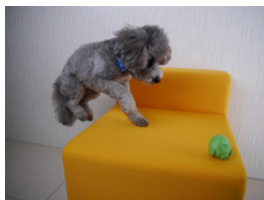

The faster shutter speed prevents blur and captures a clear image of the fast moving animal.

- The initial setting for the AF assist lamp is [OFF].

[Clear Sports Shot]



The faster shutter speed prevents blur, for example at sporting events.

[Monochrome]

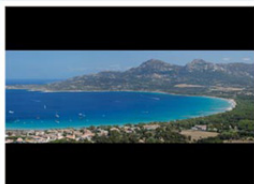

A monochrome image captures the mood of the moment.

[Panorama Shot]

Consecutive photos taken while the camera is moved are combined to form a panorama.

1 Check the recording direction, and then press [MENU/SET].

- A horizontal/vertical guide is displayed.



Changing the recording direction

- 1 Select the menu.

MENU → [Rec] → [Panorama Settings] → [Direction]

- 2 Select the recording direction, and then press [MENU/SET].

[→] (left → right)/[←] (right → left)/[↑] (bottom → top)/[↓] (top → bottom)



Adding an image effect

- 1 Select the menu.

MENU → [Rec] → [Panorama Settings] → [Filter Select]

- 2 Press ▲/▼ to select the image effects (filters).

- With the same operation as the Creative Control Mode, the same image effect as the Creative Control Mode can be added. (P107) (excluding [Toy Effect], [Toy Pop], [Miniature Effect], and [Sunshine])
- During panorama picture recording, the following image effects of the Creative Control Mode are not visible on the screen:
 - [Rough Monochrome]/[Silky Monochrome]/[Soft Focus]/[Star Filter]
- If no image effect is to be added, select [No Effect].

- 3 Press [MENU/SET].

2 Press the shutter button halfway to focus.



3 Press the shutter button fully and move the camera in a small arc in the direction of the arrow on the screen.

Recording from left to right

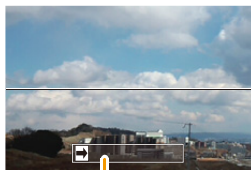
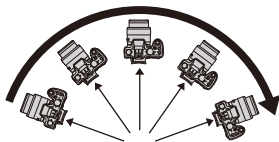

(A) Recording direction and panning (Guide)

- Move the camera at a constant speed. Pictures may not be able to be recorded properly if the camera is moved too fast or slow.

4 Press the shutter button once again to end picture recording.

- Recording can also be ended by keeping the camera still while recording.
- Recording can also be ended by moving the camera to the end of the guide.

Tips

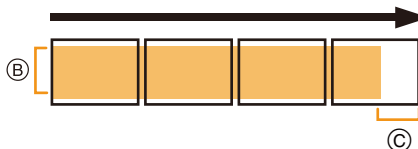

- (B) Move the camera in the recording direction without shaking it. If the camera shakes too much, pictures may not be able to be recorded, or the recorded panorama picture may become narrower (smaller).
- (C) Move the camera towards the edge of the range you wish to record. (The edge of the range will not be recorded in the last frame)

About playback

Pressing ▲ will start scrolling playback automatically in the same direction as the recording.

- The following operations can be performed during scrolling playback.

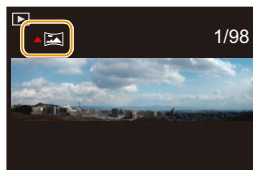

▲	Start panorama playback/Pause
▼	Stop
◀	Frame-by-frame rewind (while pausing)
▶	Frame-by-frame forward (while pausing)

- The lens' zoom function is fixed to the shortest (wide) focal length.
- The focus, white balance, and exposure settings are fixed at the optimum values for the first picture. As a result, if the subjects' position relative to the camera or brightness change substantially during recording, the entire panorama picture may not be recorded with appropriate focus or brightness settings.
- When an image effect is added, the White Balance is fixed to [AWB].
- When multiple pictures are combined to create a single panorama picture, the subject may appear distorted or seams between the stitched pictures may be noticeable in some cases.
- The resolution in the horizontal and vertical directions of the panorama picture varies depending on the recording direction and the number of combined pictures. The maximum resolution is shown below.

Recording direction	Horizontal Resolution	Vertical Resolution
Horizontal	8176 pixels	1920 pixels
Vertical	2560 pixels	7680 pixels

- [Shutter Type] is fixed to [AUTO].



- A panorama picture may not be able to be created, or the pictures may not be combined properly when recording the following subjects or under the recording conditions below.
 - Subjects with a single, uniform color or repetitive pattern (such as the sky or a beach)
 - Moving subjects (persons, animals, cars, waves, flowers blowing in the breeze, etc.)
 - Subjects whose color or patterns change in a short time (such as an image appearing on a display)
 - Dark places
 - Locations with flickering light sources such as fluorescent lights or candles
- When [Silent Mode] is set to [ON].

Using Creative Control Mode

Recording mode: **COL**

This mode employs additional image effects.

You can set the effects to add by selecting example images and checking them on the screen.

- 1 Set the mode dial to [COL].
- 2 Press ▲/▼ to select the image effects (filters).

- The image effect of the selected example image will be applied in a preview display (A).

- 3 Press [MENU/SET] to set.

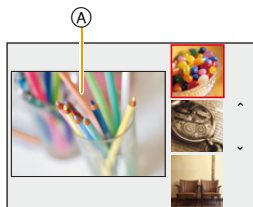

Switching the image effect (filter) selection screen display

Press [DISP] to switch the monitor screen.

- Each time [DISP] is pressed, the image effect selection screen is switched.
- When the image effect selection screen display is set to the guide display, a description of the selected image effect is displayed.

Normal display

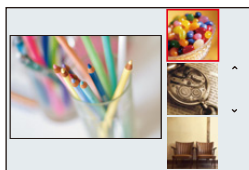

Guide display

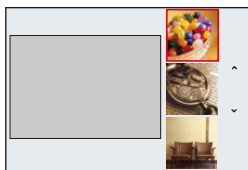

List display

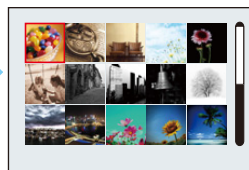

- To change Creative Control Mode, select the [CC] tab on the menu screen, select [Filter Switch], and then press [MENU/SET]. You can return to step 2.
- The White Balance will be fixed to [AWB] and the ISO sensitivity will be fixed to [AUTO]. In addition, the Photo Style will be fixed to [Standard] and the Color Space will be fixed to [sRGB].

Adjust the effect to fit your preferences

The intensity and colors of the effects can be easily adjusted to fit your preferences.

1 Press ► to display the setting screen.

2 Rotate the rear dial to set.

- The items that can be set differ depending on which Creative Control Mode is currently set.
For information on each image effect, refer to “Items that can be set”.
- Press [MENU/SET] to return to the recording screen.
- When setting the effect, [] is displayed on the screen.
- If you do not change the settings, select the center (standard).





Taking a picture with a blurred background (Defocus Control)

You can easily set the blurriness of the background while checking the screen.

1 Press the rear dial to display the setting screen.

- Each press of the rear dial switches between brightness setting, Defocus Control and end operation.

2 Rotate the rear dial to set.

- Pressing [ / ] on the blurriness setting screen will cancel the setting.

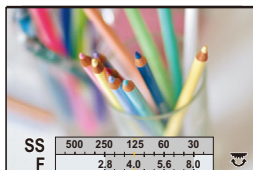

- This function is not available in the following case:
– [Miniature Effect] (Creative Control Mode)

Setting brightness

1 Press the rear dial to display the setting screen.

- Each press of the rear dial switches between brightness setting, Defocus Control and end operation.

2 Rotate the rear dial to set.

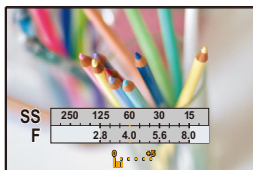

 For details on “Creative Control Mode” settings, refer to [P107](#).

[Expressive]

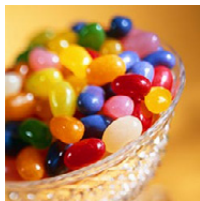

This effect emphasizes the color to make a pop art picture.

Items that can be set
(Press ► to display the setting screen.)

Color hues	Subdued	↔	Pop
------------	---------	---	-----

[Retro]



This effect gives a faded image.

Items that can be set
(Press ► to display the setting screen.)

Color	Yellow emphasized	↔	Red emphasized
-------	-------------------	---	----------------

[Old Days]

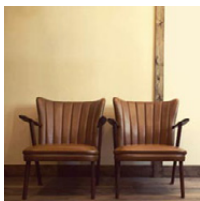

This effect adds a bright, soft and nostalgic feel to the overall image.

Items that can be set
(Press ► to display the setting screen.)

Contrast	Lower	↔	Higher
----------	-------	---	--------

[High Key]

This effect adds a bright, airy and soft feel to the overall image.

Items that can be set
(Press ► to display the setting screen.)

Color	Pink emphasized	↔	Aquamarine emphasized
-------	-----------------	---	-----------------------

- If you select this effect with [Panorama Shot] in Scene Guide Mode, the effect may not be apparent in places with insufficient brightness.

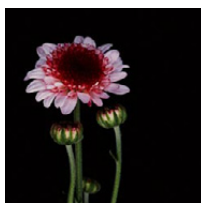
[Low Key]

This effect adds a dark and therefore quiet feel to the overall image and enhances bright parts.

Items that can be set
(Press ► to display the setting screen.)

Color	Red emphasized	↔	Blue emphasized
-------	----------------	---	-----------------

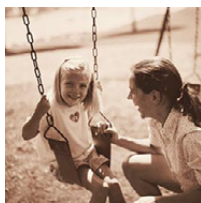
[Sepia]

This effect creates a sepia image.

Items that can be set
(Press ► to display the setting screen.)

Contrast	Lower	↔	Higher
----------	-------	---	--------

[Monochrome]

This effect creates a black and white picture.

Items that can be set
(Press ► to display the setting screen.)

Contrast	Yellow emphasized	↔	Blue emphasized
----------	-------------------	---	-----------------

[Dynamic Monochrome]

This effect gives a higher contrast to create an impressive black and white picture.

Items that can be set
(Press ► to display the setting screen.)

Contrast	Lower	↔	Higher
----------	-------	---	--------

[Rough Monochrome]

This effect creates a black and white picture with noise resembling the graininess of conventional film material.

Items that can be set
(Press ► to display the setting screen.)

Grittiness	Weaker	↔	Stronger
------------	--------	---	----------

- The display of the recording screen will be delayed more than usual and the screen will look as if frames are dropping.

[Silky Monochrome]

This effect blurs the overall image to add a soft feel to a black and white picture.

Items that can be set
(Press ► to display the setting screen.)

Extent of defocus	Weak	↔	Strong
-------------------	------	---	--------

- The display of the recording screen will be delayed more than usual and the screen will look as if frames are dropping.

[Impressive Art]

This effect gives your photo a dramatic contrast look.

Items that can be set
(Press ► to display the setting screen.)

Color hues	Black and white	↔	Pop colors
------------	-----------------	---	------------

- If this image effect is selected with [Panorama Shot] in Scene Guide Mode, seams between the stitched pictures may become visible.

[High Dynamic]

This effect produces the optimum brightness for both dark and bright parts.

Items that can be set
(Press ► to display the setting screen.)

Color hues	Black and white	↔	Pop colors
------------	-----------------	---	------------

[Cross Process]

This effect gives your photo a dramatic color look.

Items that can be set
(Press ► to display the setting screen.)

Color	Green tone/Blue tone/Yellow tone/Red tone
-------	---

- Select the desired color tone by rotating the rear dial, and then press [MENU/SET].

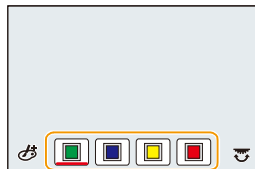

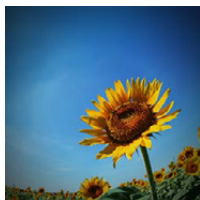
[Toy Effect]

This effect reduces the brightness in the frame corners to give the impression of a toy camera.

Items that can be set
(Press ► to display the setting screen.)

Colors	Orange emphasized	↔	Blue emphasized
--------	-------------------	---	-----------------

[Toy Pop]

This effect creates a vivid and bright image with the look of a toy camera.

Items that can be set
(Press ► to display the setting screen.)

Size of the frame corners with reduced brightness	Smaller	↔	Larger
---	---------	---	--------

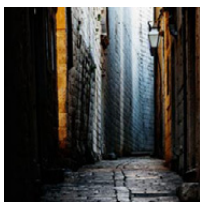
[Bleach Bypass]

This effect gives a higher contrast and a lower saturation to create a picture with a subdued atmosphere.

Items that can be set
(Press ► to display the setting screen.)

Contrast	Lower	↔	Higher
----------	-------	---	--------

[Miniature Effect]

This effect blurs the frame edges to give the impression of a diorama.

Items that can be set
(Press ► to display the setting screen.)

Color hue	Subdued	↔	Pop
-----------	---------	---	-----

■ Setting the type of defocus

With [Miniature Effect] you can make the subject stand out by intentionally creating defocused and in-focus sections.

You can set the recording orientation (defocus orientation) and the position and size of the in-focus section.

- 1 Press [FN1] to display the setting screen.
- 2 Press ▲/▼ or ◀/▶ to move the in-focus section.
- 3 Rotate the rear dial to change the size of in-focus section.
 - If you press [DISP], settings for the in-focus sections are restored to the initial settings.
- 4 Press [MENU/SET] to set.

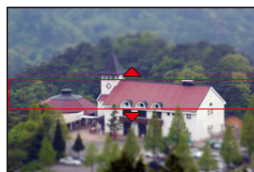

- The display of the recording screen will be delayed more than usual and the screen will look as if frames are dropping.
- No sound is recorded in motion pictures.
- **With camera models 18 194 / 18 195:**
The motion picture is condensed to approx. 1/10 of the originally recorded time.
(If you record for 10 minutes, the resulting motion picture recording will be approximately 1 minute long.)
Accordingly, the displayed available recording time is also approx. 10 times the resulting motion picture. When switching to Recording mode, please check the available recording time.
- **With camera models 18 193 / 18 196:**
The motion picture is condensed to approx. 1/8 of the originally recorded time.
(If you record for 8 minutes, the resulting motion picture recording will be approximately 1 minute long.)
Accordingly, the displayed available recording time is also approx. 8 times the resulting motion picture. When switching to Recording mode, please check the available recording time.
- If you end motion picture recording after a short time, the camera may go on recording for a certain period. Please continue to hold the camera until the recording finishes.
- When the focus mode is set to [MF], move the focused location to the in-focus section.

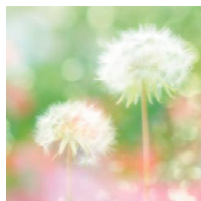
[Soft Focus]

This effect blurs the overall image to produce a soft feel.

Items that can be set
(Press ► to display the setting screen.)

Extent of defocus	Weaker	↔	Stronger
-------------------	--------	---	----------

- The display of the recording screen will be delayed more than usual and the screen will look as if frames are dropping.

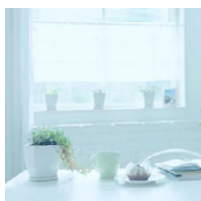
[Fantasy]

This effect creates a fantastical image in a pale color tone.

Items that can be set
(Press ► to display the setting screen.)

Color hues	Subdued	↔	Pop
------------	---------	---	-----

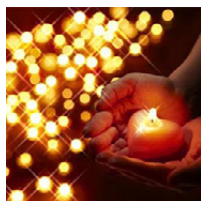
[Star Filter]

This effect transforms light points into a stars.

Items that can be set
(Press ► to display the setting screen.)

Ray length	Shorter	↔	Longer
------------	---------	---	--------

- The display of the recording screen will be delayed more than usual and the screen will look as if frames are dropping.

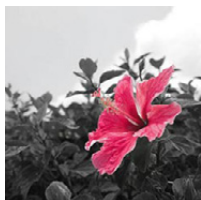
[One Point Color]

This effect lets subjects with the selected color stand out from the other (differently colored) subject parts.

Items that can be set
(Press ► to display the setting screen.)

Amount of color left	Smaller	↔	Large
----------------------	---------	---	-------

■ Set the color to retain

Set the color to retain by selecting a location on the screen.

- 1 Press **[FN1]** to display the setting screen.
- 2 Select the color you want to retain by moving the frame with **▲/▼/◀/▶**.
 - Press **[DISP]** to reset the frame position.
- 3 Press **[MENU/SET]** to set.



• Depending on the subject, the set color may not be retained.

[Sunshine]

This effect adds a cast of light to the scene.

Items that can be set

(Press ► to display the setting screen.)

Color	Yellow tone/Red tone/Blue tone/White tone
-------	---

- Select the color tone by rotating the rear dial, and then press [MENU/SET].

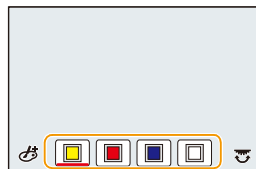

■ Setting the light source

You can change the position and size of the light source.

- 1 Press [FN1] to display the setting screen.**
- 2 Press ▲/▼/◀/▶ to move the center position of the light source.**
 - The center of the light source can be moved to the edge of the screen.



Point for when placing the center of the light source

A more natural appearance can be created by placing the center of the light source outside the image.



- 3 Adjust the size of the light source by rotating the rear dial.**
 - It can be changed to 4 different sizes.
 - Pressing [DISP] returns the light source setting to the default setting.
- 4 Press [MENU/SET] to set.**

• The display of the recording screen will be delayed more than usual and the screen will look as if frames are dropping.

Recording motion pictures with manually set aperture value/shutter speed

Recording mode: 

It is possible to manually change the aperture and shutter speed for recording motion pictures.

- 1 Set the mode dial to .
- 2 Select the menu.

MENU →  [Motion Picture] → [Exposure Mode]

- 3 Press ▲/▼ to select [P], [A], [S] or [M], and then [MENU/SET].

- The operation for changing the aperture value or shutter speed is the same as the when the mode dial is set to **P**, **A**, **S** or **M**.

- 4 To start recording, press the motion picture or the shutter button.
(Still pictures cannot be taken.)
- 5 To stop recording, press the motion picture or the shutter button.

• Aperture value

- Set a higher aperture value if you want to expand the in-focus area (depth of field), or a lower value if you want the opposite.

• Shutter speed

- Set a faster shutter speed if you want to take a sharp picture of a subject moving fast, or a slower shutter speed if you want to create e.g. subject blur to emphasize a movement.
- Manually setting a higher shutter speed may increase noise due to the higher sensitivity.
- When subjects are recorded in an extremely bright place or under fluorescent/LED lighting, the color tone or image brightness may change, or horizontal stripes may appear on the screen. In that case, change the Recording mode or manually adjust the shutter speed to 1/60 or 1/100.
- When [Exposure Mode] is set to [M], [AUTO] of the ISO sensitivity will switch to [125].

Recording slow motion pictures

You can create slow motion pictures by utilizing ultra-high-speed recording. The motion is displayed at a slower speed during playback.

- 1 Set the mode dial to **[M]**.
- 2 Select the menu.

[MENU] → **[Motion Picture]** → **[High Speed Video]**

- 3 Press **▲/▼** to select **[ON]** and then **[MENU/SET]**.
- 4 To start recording, press the motion picture or the shutter button. (Still pictures cannot be taken.)
- 5 To stop recording, press the motion picture or the shutter button.

- Audio is not recorded.
- You can continuously record a motion picture up to 7 minutes and 29 seconds or the file size of 4 GB. (This means you can record a motion picture equivalent to up to 29 minutes and 56 seconds in playback time.)
- The focus, zoom, exposure and White Balance settings are fixed to the value at the beginning of the recording motion picture.
- Under fluorescent lighting, flicker or horizontal bars may be seen.

Registering your preferred settings (Custom Mode)

Recording modes: **C1** **C2**

You can register the current camera settings as custom settings.

If you then record using one of the Custom Modes, you can use the registered settings.

- Initial setting of the Program Mode is registered as the custom settings initially.

Registering Personal Menu Settings

To allow recording using the same settings, up to 4 sets of current camera settings can be registered using [Cust.Set Mem.] (C1, C2-1, C2-2, C2-3)

Preparations: Set the recording mode you wish to save first, and then select the desired menu settings on the camera.

1 Select the menu.

MENU → /c[Custom] → [Cust.Set Mem.]

2 Press ▲/▼ to select the custom set to register and then [MENU/SET].

C1	The settings are registered for C1 on the mode dial. • You can record using by simply rotating the mode dial to the corresponding position. If you register the custom settings you use often, it is then convenient to use them.
C2-1	The settings are registered for C2 on the mode dial. • You can register up to 3 sets of custom settings and use the different sets as conditions demand.
C2-2	
C2-3	

- A confirmation screen is displayed. The respective function is executed when [Yes] is selected.

Exit the menu after it is executed.

- The following menu items cannot be registered as custom settings.

[Rec] menu	[Setup] menu	[Custom] menu	[Playback] menu
– Data registered with [Face Recog.] – The [Profile Setup] setting	– All menus	– [Menu Guide]	– [Rotate Disp.] – [Picture Sort] – [Delete Confirmation]

Using registered custom settings

You can easily call up the settings you have registered using [Cust.Set Mem.].

Set the mode dial to [C1], or [C2]

- The custom setting will be called up. If you set the mode dial to [C2], the custom setting you used last time ([C2-1], [C2-2], or [C2-3]) will be called up.

■ To change a custom setting in [C2]

- 1** Set the mode dial to [C2].
- 2** Press [MENU/SET] to display the menu.
- 3** Press ◀/▶ to select the custom setting you want to use, and then [MENU/SET].

- Saving of the selected custom settings is displayed on the screen.



■ Changing the settings

Registered contents do not change when the menu setting is changed temporarily with the mode dial set to **C1** or **C2**. To change the registered settings, overwrite the registered content using [Cust.Set Mem.] on the custom settings menu.









Adjusting the Picture Quality by Adding an Effect ([Photo Style])

Available in the following modes:           

You can select effects to match the type of image you wish to record.

You can adjust the color and image quality of the effects.

MENU →  [Rec] → **[Photo Style]**

 [Standard]	This is the standard setting.
 [Vivid]^{*1}	Creates a brilliant effect with high saturation and contrast.
 [Natural]^{*1}	Creates a soft effect with low contrast.
 [Monochrome]	Creates black and white pictures.
 [Scenery]^{*1}	An effect appropriate for scenes with vivid blue skies and greens.
 [Portrait]^{*1}	An effect appropriate for portrait pictures with a healthy and beautiful skin tone.
 [Custom]^{*1}	Uses the setting registered in advance.
 [Cinelike D]^{*1, 2}	Gives priority to dynamic range by using a gamma curve ^{*3} designed to create film-like pictures. Suited for editing.
 [Cinelike V]^{*1, 2}	Gives priority to contrast by using a gamma curve ^{*3} designed to create film-like pictures.

*1 This is disabled when Snapshot Plus Mode is selected.

*2 These can be set only in Creative Video Mode.

*3 When the actual brightness and the brightness to be captured are adjusted at each brightness level, the relationship between these two kinds of brightness is plotted as a nonlinear curve. This is called the gamma curve.

- In Snapshot Plus () Mode, the setting will be reset to [Standard] when the camera is switched to another recording mode or the camera is turned on and off.
- In Scene Guide Mode, a Photo Style which matches each scene is fixed.
- Those menu items are shared by the [Rec] menu and the [Motion Picture] menu. When the setting for either of the two is changed, the setting for the other is also changed.

■ Adjusting the picture quality

- Picture quality cannot be adjusted in the Snapshot Plus Mode.

- 1 Press ◀/▶ to select the type of Photo Style.
- 2 Press ▲/▼ to select the items, and then ◀/▶ to adjust.

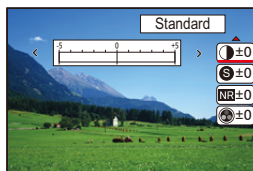

☉ [Contrast]	[+]	Increases the difference between the brighter and the darker parts in the picture.
	[-]	Decreases the difference between the brighter and the darker parts in the picture.
Ⓢ [Sharpness]	[+]	Definition is enhanced.
	[-]	Definition is reduced (resulting in "softer" pictures).
NR [Noise Reduction]	[+]	The noise reduction effect is enhanced. The resolution may deteriorate slightly.
	[-]	The noise reduction effect is reduced. The resolution can be enhanced slightly.
⊗ [Saturation]* ¹	[+]	The colors in the picture become vivid.
	[-]	The colors in the picture become subdued.
⊗ [Color Tone]* ¹	[+]	Shifts towards a bluish tone.
	[-]	Shifts towards a yellowish tone.
⊗ [Filter Effect]* ²	[Yellow]	Enhances the contrast of an subject. (Effect: Weak) The blue sky is rendered more clearly.
	[Orange]	Enhances the contrast of an subject. (Effect: Medium) The blue sky is rendered more vividly.
	[Red]	Enhances the contrast of an subject. (Effect: Strong) The blue sky is rendered much more vividly.
	[Green]	The skin and lips of people and green leaves appear in natural tones. Green leaves appear brighter and more emphasized.
	[Off]	—

*1 [Color Tone] is displayed only when [Monochrome] is selected. In other cases, [Saturation] will be displayed.

*2 [Filter Effect] is displayed only when [Monochrome] is selected.

- If you adjust the picture quality, [+] is displayed in addition to the Photo Style icon on the screen.

- 3 Press [MENU/SET].

■ Registering settings to [Custom]

Adjust the picture quality following step 2 of "Adjusting the picture quality", and then press [DISP].

- A confirmation screen is displayed. The function is executed when [Yes] is selected.

Adjusting Bright/Dark Sections ([Highlight Shadow])

Available in the following modes: **P** **A** **S** **M** **C1** **C2** **COL**

You can adjust the brightness of the bright and dark parts of a subject while checking the results on the screen.

1 Select the menu.

MENU → **[Rec]** → **[Highlight Shadow]**

2 Press to select the item.

<input type="checkbox"/> (Standard)	A state with no adjustments is set.
<input type="checkbox"/> (Raise the contrast)	Bright areas are brightened, and dark areas are darkened.
<input type="checkbox"/> (Lower the contrast)	Bright areas are darkened, and dark areas are brightened.
<input type="checkbox"/> (Brighten dark areas)	Dark areas are brightened.
/ / (Custom)	Registered custom settings can be applied.

3 Rotate the rear dial to adjust the brightness of bright/dark parts.

- Ⓐ Bright side
- Ⓑ Dark side
- Ⓒ Preview display

- Each time you press the rear dial, you can switch between the adjustment of the dark side and that of the bright side.
- To register a preferred setting, press , and select the destination where the custom setting will be registered to ([Custom1] ()/[Custom2] ()/[Custom3] ()).

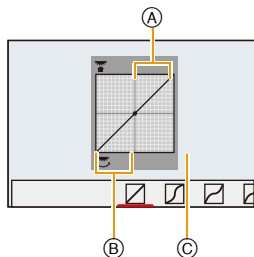





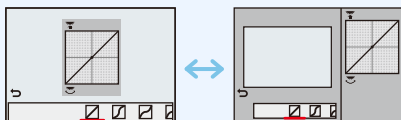

4 Press **[MENU/SET]**.



- The screen display can be switched by pressing [DISP] on the brightness adjustment screen.



- Settings registered to  /  /  will be stored even after the camera is turned off.
- Turning off the camera will return the setting adjusted with  /  /  /  back to the default setting.
- These menu items are shared by the [Rec] menu and the [Motion Picture] menu. When the setting for either of the two is changed, the setting for the other is also changed.

Setting the White Balance

Available in the following modes: 

In sunlight, under incandescent lights or in other such conditions where the color of white takes on a reddish or bluish tinge, this function allows settings according to the prevailing light source, and thus to adjust the rendition of white to your (subjective) personal perception.

1 Press ► [WB].

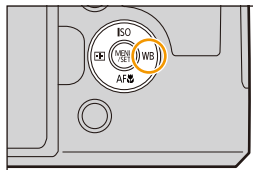

2 Select the desired White Balance setting by rotating the rear dial.



3 Press the rear dial to set.

[AWB]	Automatic adjustment
[☀]	For taking pictures outdoors under a clear sky
[☁]	For taking pictures outdoors under a cloudy sky
[🏠]	For taking pictures outdoors in the shade
[💡]	For taking pictures under incandescent lights
[WB]	For taking pictures with the flash only
[1]/[2]/[3]/[4]	The manually metered and set value is used
[K]	For using a preset color temperature setting

*This mode will switch to [AWB] during motion picture recording.





• Under fluorescent lighting, LED lighting fixtures etc., the appropriate White Balance will vary depending on the lighting type, so use [AWB] or [], [], [], [].

- The White Balance is only calculated for subjects within the range of the camera's flash. (P199)
- In Scene Guide Mode, changing the scene or recording mode will return White Balance settings (including the White Balance fine adjustment setting) back to [AWB].
- In the Scene Guide Modes listed below, White Balance is fixed to [AWB].
 - [Backlit Softness]/[Relaxing Tone]/[Distinct Scenery]/[Bright Blue Sky]/[Romantic Sunset Glow]/[Vivid Sunset Glow]/[Glistening Water]/[Clear Nightscape]/[Cool Night Sky]/[Warm Glowing Nightscape]/[Artistic Nightscape]/[Glittering Illuminations]/[Handheld Night Shot]/[Clear Night Portrait]/[Appetizing Food]/[Cute Dessert]

■ Auto White Balance

Depending on the conditions prevailing when pictures are taken, they may take on a reddish or bluish tinge. Furthermore, when a multiple number of light sources is being used or there is nothing with a color close to white, Auto White Balance may not function properly. In a case like this, set the White Balance to a mode other than [AWB].

- 1 Auto White Balance will work within this range.
 - 2 Blue sky
 - 3 Cloudy sky (Rain)
 - 4 Shade
 - 5 Sunlight
 - 6 White fluorescent light
 - 7 Incandescent light bulbs
 - 8 Sunrise and sunset
 - 9 Candlelight
- K=Kelvin Color Temperature

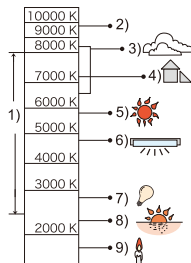

Setting the White Balance manually

This mode allows metering any specific situation and storing the according White Balance setting.

- 1 Press ► [WB].
- 2 Rotate the rear dial to select [1], [2], [3], or [4], and then press ▲.
- 3 Aim the camera at a sheet of white paper etc. so that it fills the frame in the center completely and then press [MENU/SET].

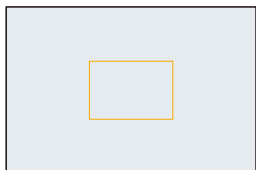

- It may not be possible to set the White Balance when the subject is too bright or too dark. Set it again after adjusting the exposure to appropriate brightness.

Setting the color temperature

You can set the color temperature manually for taking natural pictures in different lighting conditions.

The color of light is measured as a number in degrees Kelvin. As the color temperature increases, the picture becomes more bluish. As the color temperature decreases, the picture becomes more reddish.

- 1 Press ► [WB].
- 2 Rotate the rear dial to select [K], and then press ▲.
- 3 Press ▲/▼ to select the color temperature and then [MENU/SET].
 - You can set a color temperature from [2500K] to [10000K].

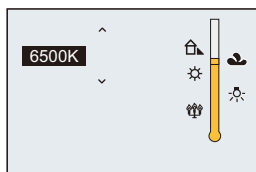

Finely adjusting the White Balance

You can finely adjust the White Balance when you cannot acquire the desired hue with the available fixed settings.

1 Select the desired White Balance setting and then press ▼.

2 Press ▲/▼/◀/▶ to fine-adjust the White Balance.

- ◀ : A (AMBER: ORANGE)
- ▶ : B (BLUE: BLuish)
- ▲ : G (GREEN: GREENISH)
- ▼ : M (MAGENTA: REDDISH)

- Pressing [DISP] resets the position back to the center.

3 Press [MENU/SET].

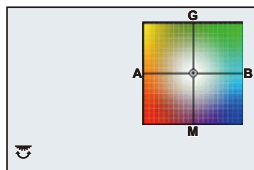

- If you finely adjust the White Balance to [A] (amber), the White Balance icon on the screen will change to orange. If you finely adjust the White Balance to [B] (blue), the White Balance icon on the screen will change to blue.
- If you finely adjust the White Balance to [G] (green) or [M] (magenta), [+] (green) or [-] (magenta) appears in addition to the White Balance icon on the screen.
- The White Balance fine adjustment setting is reflected in the picture when using the flash.
- You can finely adjust the White Balance independently for each White Balance item.
- The White Balance fine adjustment level returns to the standard setting (center point) in the following cases.
 - When you reset the White Balance in [], [], [] or []
 - When you reset the color temperature manually in []

White Balance Bracketing

Bracket settings are performed based on the adjustment values for the White Balance fine adjustment. 3 pictures with different color rendition are automatically recorded when the shutter button is pressed once.

1 Fine-adjust the White Balance in step 2 of “Finely adjusting the White Balance” and then perform the bracket setting by rotating the rear dial.

Rotating the rear dial to the right:

Horizontal ([A] to [B])

Rotating the rear dial to the left:

Vertical ([G] to [M])

2 Press [MENU/SET].

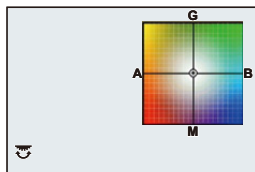

- [WBKT] is displayed in White Balance icon in the screen when the White Balance Bracket is set.
- The White Balance Bracket setting is canceled in the following cases:
 - When you turn off the camera (including Sleep Mode)
- You will only hear the shutter sound once.



The White Balance Bracket does not work in the following cases:

- [Glistening Water]/[Glittering Illuminations]/[Handheld Night Shot]/[Soft Image of a Flower]/[Panorama Shot] (Scene Guide Mode)
- When recording motion pictures
- When [Quality] is set to [RAW $\frac{1}{2}$], [RAW $\frac{1}{4}$] or [RAW]
- When [HDR] is set to [ON]
- [Multi Exp.]
- When using [Time Lapse Shot]

Setting the aspect ratio

Available in the following modes:          

This allows you to select the aspect ratio of the pictures to suit printing or the playback method.

At the time of purchase, it is initially set to [3:2].

MENU →  **[Rec]** → **[Aspect Ratio]**

[4:3]	[Aspect Ratio] of a 4:3 TV
[3:2]	[Aspect Ratio] of a 35mm film camera
[16:9]	[Aspect Ratio] of a high-definition TV, etc.
[1:1]	Square aspect ratio

- The ends of the recorded pictures may be cut at printing so check before printing. (P323)
- If you use the HDMI output during recording, the setting is fixed to [16:9].



This function is not available with [Panorama Shot] in Scene Guide Mode.

Setting the resolution

Available in the following modes:           

The higher the resolution, the more detailed the pictures will be. The results become increasingly evident, the larger the picture is viewed/printed.

MENU →  **[Rec]** → **[Picture Size]**

When the aspect ratio is [4:3].

Settings	Resolution
[L] (17.5M)	4864×3648
[EXM] (9M)	3456×2592
[EXS] (4.5M)	2432×1824

When the aspect ratio is [3:2].

Settings	Resolution
[L] (20M)	5472×3648
[EXM] (10M)	3888×2592
[EXS] (5M)	2736×1824

When the aspect ratio is [16:9].

Settings	Resolution
[L] (17M)	5472×3080
[EXM] (8M)	3840×2160
[EXS] (2M)	1920×1080

When the aspect ratio is [1:1].

Settings	Resolution
[L] (13.5M)	3648×3648
[EXM] (6.5M)	2592×2592
[EXS] (3.5M)	1824×1824

- The resolution will be fixed to [S] when [Burst Rate] is set to [SH].









This function is not available with [Panorama Shot] in Scene Guide Mode.

Setting the compression rate

Available in the following modes:   **P** **A** **S** **M**  **C1** **C2** **SCN** **COL**

Set the compression rate at which the pictures are to be stored.

MENU →  **[Rec]** → **[Quality]**

Settings	File format	Description of settings
	JPEG	A JPEG compression rate with priority on image quality.
		A standard image quality JPEG compression rate. This is useful for increasing the number of shots without changing the resolution.
[RAW	RAW+JPEG	For storing a RAW image and a JPEG image ( or ) simultaneously.* ¹
[RAW		
[RAW]	RAW	For recording only in RAW format.* ²

*1 If you delete a RAW file from the camera, the corresponding JPEG image will also be deleted.

*2 This mode is fixed to maximum resolution ([L]) for each image aspect ratio.





About RAW

RAW refers to an image data format that is not pre-processed. Playback and editing of RAW images require the camera or dedicated software.

You can make advanced adjustments by editing RAW images. For example, you can adjust the White Balance after taking pictures or save them in file formats that are allowed to be displayed on a computer. Pictures taken in RAW format will have higher image quality than those taken in JPEG format, but the file size will be larger.

- You can process RAW images in [RAW Processing] in the [Playback] menu. (P227)



The settings in the following modes are not applied in RAW images files:

- Snapshot Mode
 - Snapshot Plus Mode
 - Creative Control Mode
 - White Balance*1
 - [Photo Style]*1/[Highlight Shadow]*1/[i.Dynamic]*1/[Red-Eye Removal]*2/[i.Resolution]*1/[Color Space]*1 ([Rec] menu)
 - Scene Guide Mode
- In the following case, [RAW $\frac{1}{2}$], [RAW $\frac{1}{4}$], and [RAW] cannot be set.
 - [Handheld Night Shot]/[Panorama Shot] (Scene Guide Mode)
- *1 If you perform [RAW Processing] in the [Playback] menu, you can process the picture into one in JPEG format with the settings at the time of recording. The settings will be used as initial settings when you start [RAW Processing].
- *2 If you perform [RAW Processing] in the [Playback] menu on a picture taken with [Red-Eye Removal], the effect will be applied to the processed picture in JPEG format.

Using Image Correction Functions

Compensating the contrast and exposure ([i.Dynamic])

Available in the following modes:   **P** **A** **S** **M**  **C1** **C2** **SCN** **COL**

Contrast and exposure are compensated when the brightness difference between the subject and its surroundings is great, etc.

MENU →  **[Rec]** → **[i.Dynamic]**

Settings: **[AUTO]/[HIGH]/[STANDARD]/[LOW]/[OFF]**

- **[AUTO]** automatically sets the intensity of the effect according to the recording conditions.
- Those menu items are shared by the **[Rec]** menu and the **[Motion Picture]** menu. When the setting for either of the two is changed, the setting for the other is also changed.



This feature may be automatically disabled, depending on the lighting conditions.

- In the following cases, **[i.Dynamic]** does not work:
 - **[Panorama Shot]** (**Scene Guide Mode**)
 - When **[HDR]** is set to **[ON]**

Raising the resolution ([i.Resolution])

Available in the following modes:   **P** **A** **S** **M**  **C1** **C2** **SCN** **COL**

Pictures with sharp profile and resolution can be taken by using the Intelligent Resolution Technology.

MENU →  **[Rec]** → **[i.Resolution]**

Settings: **[HIGH]/[STANDARD]/[LOW]/[EXTENDED]/[OFF]**

- **[EXTENDED]** allows you to take natural pictures with a higher resolution.
- When recording a motion picture, **[EXTENDED]** changes to **[LOW]**.
- The setting in this menu item shared by the **[Rec]** menu and the **[Motion Picture]** menu. When the setting for either of the two is changed, the setting for the other is also changed.

Combining pictures with different exposures ([HDR])

Available in the following modes:   **P** **A** **S** **M**  **C2**  

You can combine 3 pictures with different exposure levels into a single picture with rich gradation. You can minimize the loss of gradation in bright areas and dark areas when, for example, the contrast between different parts of the subject is large.

An image combined by HDR is recorded in JPEG.

MENU →  **[Rec]** → **[HDR]**

[ON]	Records HDR pictures.
[OFF]	Does not record HDR pictures.
[SET]	[Dynamic Range]
	[AUTO]: Automatically adjusts the exposure range according to the differences between the bright and dark areas.
	[±1 EV]/[±2 EV]/[±3 EV]: Adjusts the exposure within the selected exposure parameters.
	[Auto Align]
	[ON]: Automatically corrects camera shake and other problems that can cause the images to misalign. Recommended for use during hand-held shooting.
	[OFF]: Image misalignment is not adjusted. Recommended when a tripod is used.



■ What Is HDR?

HDR stands for High Dynamic Range and refers to a technique for expressing a wide contrast range.

- Do not move the camera during the continuous shooting after pressing the shutter button.
- You cannot take the next picture until the combination of pictures is complete.
- A moving subject may be recorded with unnatural blurs.
- The angle of view becomes narrow slightly when [Auto Align] is set to [ON].
- Flash is fixed to  (flash off).



This function is not available in the following cases.

- When [Quality] is set to [RAW , [RAW ] or [RAW
- When using [Time Lapse Shot]
- When using [Stop Motion Animation] (only when [Auto Shooting] is set)
- For pictures taken during a motion picture recording

Reducing the long shutter noise caused by slower shutter speeds

Available in the following modes:   **P** **A** **S** **M**  **C1** **C2** **SCN** **COL**

The camera automatically removes noise that appears with slower shutter speeds, e.g. when taking pictures of night scenery etc.

MENU →  **[Rec]** → **[Long Shtr NR]**

Settings: [ON]/[OFF]

- [Long shutter noise reduction ongoing] is displayed for the same time as the shutter speed for signal processing.
- We recommend using a tripod when the shutter speed is slowed to take pictures.



In the following cases, [Long Shtr NR] does not work:

- [Panorama Shot] (Scene Guide Mode)
- When recording motion pictures
- When [Burst Rate] is set to [SH]
- When using the electronic shutter

Setting the color space

Available in the following modes:          

Set this when you want to correct the color reproduction of the recorded pictures on a computer, printer etc.

MENU →  **[Rec]** → **[Color Space]**

[sRGB]	The color space is set to sRGB. This is widely used in computer related equipment.
[AdobeRGB]	The color space is set to AdobeRGB. AdobeRGB is mainly used for business purposes such as professional printing because it has a greater range of reproducible colors than sRGB.

- Set to sRGB if you are not very familiar with AdobeRGB.
- The setting is fixed to [sRGB] in the following case.
 - When recording motion pictures

Using Autofocus

Available in the following modes: 

This item allows selecting the focusing method that suits the positions and number of the subjects.

1 Set the focus mode lever to [AFS/AFF] or [AFC].



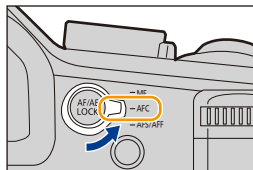

- The respective focus mode will be set. (P140)

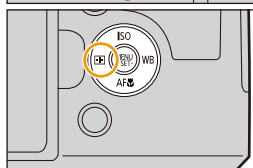

2 Press ◀ ().



3 Press ◀/▶ to select AF Mode and then [MENU/SET].

- The respective Autofocus Mode will be set. (P141)
- The AF area selection screen is displayed when ▼ is pressed while , , , or  is selected. For operation in the AF area selection screen, refer to P146.



- The setting is fixed to  in the following cases.
 - [Miniature Effect] (Creative Control Mode)
 - [High Speed Video] (Creative Video Mode)



This mode cannot be set to  in the following cases.

- [Clear Nightscape]/[Cool Night Sky]/[Warm Glowing Nightscape]/[Artistic Nightscape]/[Glittering Illuminations]/[Handheld Night Shot]/[Appetizing Food]/[Cute Dessert] (Scene Guide Mode)
- The  is disabled in the following case.
 - [AFF]/[AFC] (Focus Mode)

About the focus modes (AFS/AFF/AFC)

Available in the following modes:

Item	The movement of the subject and the scene (recommended)	Description of settings
AFS*	Subject is still (Scenery, anniversary photograph, etc.)	“AFS” is an abbreviation of “Autofocus Single”. The focus is set automatically when the shutter button is pressed halfway. It is locked as long as the shutter button is kept pressed in the halfway position..
AFF*	Movement cannot be predicted (Children, pets, etc.)	“AFF” is an abbreviation of “Autofocus Flexible”. In this mode, focusing is performed automatically when the shutter button is pressed halfway. If the subject moves while the shutter button is pressed halfway, the focus setting is corrected to match the movement automatically.
AFC	Subject is moving (Sport, trains, etc.)	“AFC” is an abbreviation of “Autofocus Continuous”. In this mode, while the shutter button is pressed halfway, focusing is constantly adjusted to match the movement of the subject. The focusing operation is based on predicting the subject position at the time of recording. (Movement prediction)
MF	Set the focus manually. (P151)	

* In [AFS/AFF] in the [Rec] menu or the [Motion Picture] menu, you can assign [AFS] or [AFF] to [AFS/AFF] of the focus mode lever.



When recording using [AFF], [AFC]

- It may take time to focus on the subject when you change the focal length (zoom) from Wide to Tele or suddenly change the subject distance from further to nearer.
- Press the shutter button halfway again when it is difficult to focus on the subject.
- While the shutter button is pressed halfway, the image on the screen may move around.

- When the brightness is insufficient for [AFF] or [AFC], the camera will operate as if [AFS] has been set. In this case, the [AFS] display will change to yellow.



When Scene Guide Mode is set to [Panorama Shot], even if you set the focus mode lever to [AFS/AFF] or [AFC], the camera will operate as if [AFS] has been set.

Autofocus modes

About [👤] ([Face/Eye Detection])

The camera automatically detects a person's face and eyes.

The eye closer to the camera will be in focus, while the exposure will be optimized for the face. (When [Metering Mode] is set to [☉])

• Up to 15 faces can be detected. Only the eyes of the face that is in focus can be detected.

When the camera detects a face, the AF area and the mark indicating the eye to be in focus are displayed.

Yellow:

When the shutter button is pressed halfway, the frame turns green when the camera is focused.

White:

Displayed when more than one face is detected. Other faces that are the same distance away as faces within the yellow AF areas are also focused.

Ⓐ The eye to be in focus

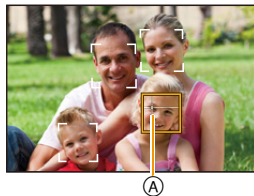

• You can change the position and size of the AF area and the eye to be in focus. (P146)

• When [👤] is selected and [Metering Mode] is set to multiple [☉], the camera will adjust the exposure to suit the person's face. (P164)



Under certain picture-taking conditions including the following cases, the Face/Eye Detection Function may fail to work, making it impossible to detect faces. The AF Mode is switched to [📏].

- When the person is not facing the camera
- When the face is at an angle
- When the face is extremely bright or dark
- When the facial features are hidden behind sunglasses, etc.
- When the face appears small on the screen
- When there is little contrast on the faces
- When person moves rapidly
- When the subject is not a human being
- When the camera is shaking

Setting up [AF-ON] ([Tracking])

Focus and exposure can be locked to a specified subject. They will follow the subject even if it moves. (Dynamic tracking)

Place the subject in the AF tracking frame, and press the shutter button halfway to lock it.

(A) AF tracking frame

- The AF frame will turn green when the camera detects the subject.
- The AF frame turns yellow when the shutter button is released.
- Lock is canceled when [MENU/SET] is pressed.
- Tracking AF and Face Detection will switch every time ◀ is pressed in the Snapshot ([A] or [A+]) Modes.



- The exposure is adjusted in accordance with the locked subject when [Metering Mode] is set to [☉]. (P164)
- If it fails to lock, the AF frame will flash in red, and disappear. Try to lock again.
- When AF tracking fails, [■] is set.



- [AF-ON] cannot be used with [Time Lapse Shot].
- In the following cases, [AF-ON] operates as [■].
 - [Glistening Water]/[Glittering Illuminations]/[Soft Image of a Flower]/[Monochrome] (Scene Guide Mode)
 - [Sepia]/[Monochrome]/[Dynamic Monochrome]/[Rough Monochrome]/[Silky Monochrome]/[Soft Focus]/[Star Filter]/[Sunshine] (Creative Control Mode)
 - [Monochrome] ([Photo Style])
- The Dynamic tracking function may not work in the following cases:
 - When the subject is too small
 - When the recording location is too dark or bright
 - When the subject is moving too fast
 - When the background has the same or similar color to the subject
 - When camera is not held still
 - When zoom is operated

About [] ([49-Area])

Subjects in up to 49 AF areas are detected, the focus setting is based on the detected one nearest to the camera.

This function makes it easy to focus on off-center subjects.

- **The area to be focused can be set. (P146)**

About [], etc. ([Custom Multi])

From among the 49 AF areas, you can freely set which of them should be used (and which not) for the subject. (P144)



About [] ([1-Area])

The camera focuses on the subject in the AF area in the center of the screen.

- **Position and size of the AF area can be changed. (P146)**
- When the subject is not in the center of the composition in [], you can bring the subject into the AF area, fix the focus and exposure by pressing the shutter button halfway, moving the camera to the composition you want with the shutter button pressed halfway, and then take the picture. (Only when the Focus Mode is set to [AFS].)



About [] ([Pinpoint])

You can achieve a more precise focus on an object that is smaller than with [].





- **The AF point position can be set on an enlarged screen. (P147)**
- If the shutter button is pressed halfway, the screen for checking the focus position will be enlarged.
- The time for which the display is enlarged can be set using [Pinpoint AF Time] in the [Custom] menu. (P148)
- In the following case, [] operates as []
 - When recording motion pictures
- The mode cannot be set to [] in the following cases.
 - [AFF]/[AFC] (focus mode)

Setting the shape of the AF area ([Custom Multi])

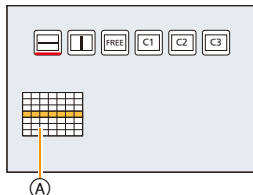
You are free to select which of the 49 AF areas you regard appropriate for the subject.

- 1 Press **◀** ().
- 2 Select a Custom Multi icon (, etc.), and press **▲**.
 - If you press **▼**, the AF area setting screen will be displayed.
- 3 Press **◀/▶** to select a setting.
 - The currently marked AF areas (A) are displayed on the bottom left of the screen.

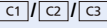

 ([Horizontal Pattern])	Horizontal line This shape is convenient for taking panning shots or similar shots.	
 ([Vertical Pattern])	Vertical line This shape is convenient for recording objects, such as buildings.	
 ([User Defined])	Free shape	
 ([Custom1]/ [Custom2]/ [Custom3])	You can select a customized setting.	

- 4 Press **▼**.
 - AF area setting screen is displayed.
- 5 Select AF areas.
 - The selected AF areas are displayed in yellow, while the areas that are not selected are displayed in white.



When selecting []/[]

When [] is selected, you can change the vertical position and the number of rows; when [] is selected, you can change the horizontal position and the number of columns.

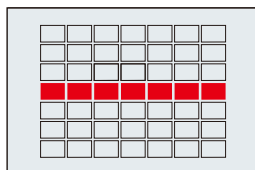

Button operation	Description of operation
▲/▼/◀/▶	Moves the position
	Changes the size (Up to 3 rows/columns)
[DISP]	Restores the default setting

When selecting [FREE]/[C1]/[C2]/[C3]

Press ▲/▼/◀/▶ to select the AF area, and then press [MENU/SET] to set (repeat).

- The setting is canceled when [MENU/SET] is pressed again.
- If you press [DISP], all the selections will be canceled.

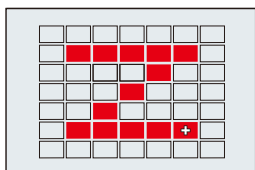
**6 Press [FN3].****■ Registering the set AF area to [C1], [C2] or [C3]**

- 1 On the screen in step 3 on P144, press ▲.
- 2 Press ▲/▼ to select a destination to which the setting will be registered, and then [MENU/SET].
 - A confirmation screen is displayed. The function is executed when [Yes] is selected.

- Settings registered to [C1]/[C2]/[C3] will be stored even after the camera is turned off.
- Turning off the camera will return the setting adjusted with []/[]/[FREE] back to the default setting.
- If you press a cursor button when [Direct Focus Area] in the [Custom] menu is set to [ON], the AF area setting screen will be displayed.

Setting up the position/changing the size of the AF area

When selecting [👤], [📐]

Position and size of the AF area can be changed.

- Select [👤] or [📐] and press ▼.**
 - The AF area setting screen is displayed.
- Press ▲/▼/◀/▶ to move the AF area.**
 - Press [DISP] to return the AF area to the center of the screen.
- Rotate the rear dial to change the size of AF area.**
 - If you move the AF area over an eye in the yellow frame when [👤] is selected, the eye to be in focus will be changed.
- Press [MENU/SET] to set.**

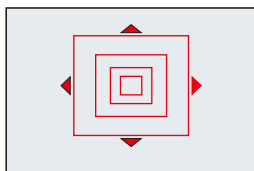

When selecting [📏]

You can set the focus position by selecting an AF area group.

The 49 AF areas are divided into groups, each consisting of 9 areas (on the edge of the screen, 6 or 4 areas).

- Select [📏] and press ▼.**
 - The AF area setting screen is displayed.
- Press ▲/▼/◀/▶ to select an AF area group.**
- Press [MENU/SET] to set.**
 - Only [+] display (center point of selected group) will remain on the screen.
 - Setting of the AF area frame is cleared when [MENU/SET] is pressed.

Examples of group

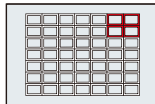
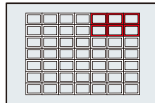
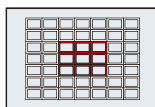

When selecting [+]

You can set the focus position precisely by enlarging the screen.

- The focus position cannot be set at the edges of the screen.

1 Select [+] and press ▾.

2 Press ▲/▼/◀/▶ to set the focus position and then [MENU/SET].

- The assist screen for setting the focus position is displayed in an enlarged size.

3 Move [+] to the focus position with ▲/▼/◀/▶.

- Pressing [DISP] will bring the focus position back to the center of the assist screen.



■ Changing the display of the assist screen

Each time the rear dial is pressed, the enlarged display switches between a windowed and a full screen display.



- If the rear dial is rotated, the display can be enlarged/reduced up to approximately 3 to 6 times when the enlarged display is in a windowed display or up to approximately 3 to 10 times when it is in a full screen display. The rear dial enlarges/reduces the size at a rate of 1 time.





Setting the duration for which the screen is enlarged

MENU → **/c[Custom]** → **[Pinpoint AF Time]** →
[LONG] (Approx. 1.5 seconds)/**[MID]** (Approx. 1.0 second)/**[SHORT]**
(Approx. 0.5 second)

- If you release the shutter button, the enlarged display will be canceled even during the set time period.



Moving/not moving the AF area with the cursor button

MENU → **/c[Custom]** → **[Direct Focus Area]** → **[ON]/[OFF]**

When , , or is selected, the AF area can be moved; when is selected, the enlarged position can be moved.

- When [Custom Multi] such as is selected, the AF area setting screen will be displayed.
- To set the items that use the cursor buttons like [White Balance] or [Sensitivity], use the Quick Menu (P39) instead.

- The spot metering target can also be moved to match the AF area when the [Metering Mode] (P164) is set to . At the edge of the screen, the metering may be affected by the brightness around the AF area.



- [Direct Focus Area] is fixed to [OFF] in the following case:
 - Creative Control Mode
- You cannot change the position and size of the AF area when the zoom position is in the digital zoom range.

Setting the desired focus method

Using the [Custom] menu, you can set the focus method in detail.

Focusing/not focusing when the shutter button is pressed halfway

MENU → **/c[Custom]** → **[Shutter AF]** → **[ON]/[OFF]**

Releasing/not releasing the shutter by pressing the shutter button halfway

MENU → **/c[Custom]** → **[Half Press Release]** → **[ON]/[OFF]**

Recording tips and techniques: setting focus with [AF/AE LOCK]

You can set focus with [AF/AE LOCK] instead of the shutter button.

1 Set items in the [Custom] menu.

MENU → **/c[Custom]** → **[Shutter AF]** → **[OFF]**

MENU → **/c[Custom]** → **[AF/AE Lock]** → **[AF-ON]**

2 Press [AF/AE LOCK].

- Set the focus.

3 Press the shutter button to take a picture.

- Set the exposure and take a picture.

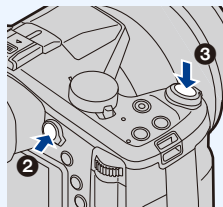

Focusing/Not focusing in advance

MENU → **/c[Custom]** → **[Quick AF]** → **[ON]/[OFF]**

As long as the camera is held steady, it automatically adjusts the focus setting and thus, when the shutter is pressed, focusing will be quicker. This is useful when you do not want to miss a picture-taking opportunity.

- The battery consumption is higher than usual.
- Press the shutter button halfway again when it is difficult to focus on the subject.
- The [Quick AF] feature is disabled in the following conditions:
 - In Preview Mode
 - In low light situations



Turning on/not turning on the AF Assist Lamp

MENU → **/C[Custom]** → **[AF Assist Lamp]** → **[ON]/[OFF]**

The AF assist lamp will illuminate the subject when the shutter button is pressed halfway, making it easier for the camera to focus when recording in low light conditions. (A larger AF area is displayed depending on the recording conditions.)

- The effective maximum range of the assist lamp is approximately 1.5m (5').
 - The AF Assist Lamp only works for subjects in the center of the screen. Position your subject in the center of the screen to ensure the best possible operation.
 - Remove the lens hood.
 - When you do not want to use the AF Assist Lamp (e.g. when taking pictures of animals in dark places), set the [AF Assist Lamp] to [OFF]. In this case, it will become more difficult to focus on the subject.
 - The setting is fixed to [OFF] in the following cases.
 - [Distinct Scenery]/[Bright Blue Sky]/[Romantic Sunset Glow]/[Vivid Sunset Glow]/[Glistening Water]/[Clear Nightscape]/[Cool Night Sky]/[Warm Glowing Nightscape]/[Artistic Nightscape]/[Handheld Night Shot] (Scene Guide Mode)
 - When [Silent Mode] is set to [ON]
-

Recording/not recording even when focus is not achieved

MENU → **/C[Custom]** → **[Focus/Release Priority]**

[FOCUS]:

You cannot take a picture until the subject is brought into focus.

[RELEASE]:

This gives priority to taking the picture. A picture is taken when the shutter button is pressed fully even if the targeted subject is not in focus at that time.

- When set to [RELEASE], please be aware that focus may not be achieved even with focus mode set to [AFS], [AFF] or [AFC].
 - [Focus/Release Priority] is disabled during motion picture recording.
-

Adjusting/not adjusting the focus manually after achieving autofocus operation

MENU → **/C[Custom]** → **[AF+MF]** → **[ON]/[OFF]**

When AF Lock is ON (press the shutter button halfway with the Focus Mode set to [AFS] or set AF Lock using [AF/AE LOCK]), you can make fine adjustments to the focus manually.

Manual Focusing

Available in the following modes: **A** **A*** **P** **A** **S** **M** **MM** **C1** **C2** **SCN** **COL**

Use this function when you want to fix the focus or when the distance between the lens and the subject is determined and you do not want to activate Autofocus.

1 Set the focus mode lever to **[MF]**.

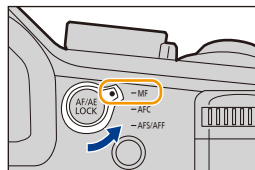

2 Set the Zoom/MF ring selector switch to **[FOCUS]**.

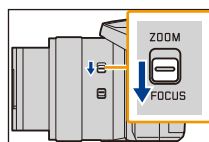

3 Press **◀** ().

4 Press **▲/▼/◀/▶** to determine the area to be enlarged, and then **[MENU/SET]**.

- The assist screen is displayed, enlarging the area. (MF Assist) ([P152](#))
- If you press **[DISP]**, the area to be enlarged will be reset to the center.

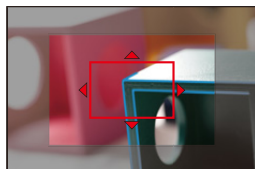

5 Operate the Zoom/MF ring to set the focus.

Rotate to **A** side:

Focuses on a nearer subject

Rotate to **B** side:

Focuses on a subject further away

- Be careful not to accidentally switch the O.I.S. switch or Zoom/MF ring selector switch when rotating the Zoom/MF ring.

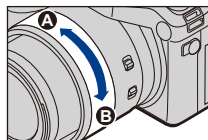

(A) Indicator for ∞ (infinity)

(B) MF Assist (enlarged screen)

(C) Peaking

(D) MF Guide

- The in-focus sections will be highlighted. (Peaking)

(P153)

- You can check whether the point of focus is to the near side or to the far side. (MF Guide) (P153)

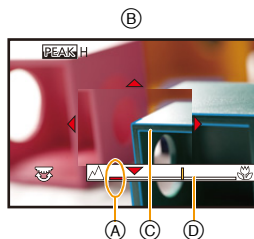

Recording tips and techniques: when to use manual focus

Manual focus is convenient when you fine-adjust the focus in Macro Mode or decide in-focus sections in advance.

Achieving focus quickly using Autofocus

MENU →  [Custom] → [AF/AE Lock] → [AF-ON]





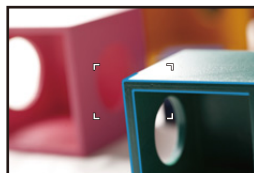

If [AF/AE LOCK] is pressed in Manual Focus, Autofocus will work.

- Autofocus works at the center of the frame.
- If Autofocus is used while the MF Assist screen is displayed, the center of the MF Assist screen will be focused.



Setting the display method of the MF Assist

MENU →  [Custom] → [MF Assist]













	Enlarge by rotating the Zoom/MF ring or pressing ◀ ().
	Enlarge by rotating the Zoom/MF ring.
	Enlarge by pressing ◀ ().
[OFF]	Does not enlarge with the Zoom/MF ring or ◀ ().



Highlighting/not highlighting in-focus parts

MENU → **/C[Custom]** → **[Peaking]**

- This function works in Manual Focus Mode or when focus is being adjusted manually with [AF+MF].

[ON]	In-focus sections are highlighted with color.	
[OFF]	In-focus sections are not highlighted.	
[SET]	[Detect Level]	<p>The detection level for in-focus sections is set. When [HIGH] is set, sections to be highlighted are reduced, allowing you to focus a more precisely.</p> <p>[HIGH]/[LOW]</p> <ul style="list-style-type: none"> • The detection level setting does not affect the focus range.
	[Display Color]	<p>Sets the highlighting color used for [Peaking].</p> <ul style="list-style-type: none"> • When [Detect Level] is set to [HIGH]:  (Light blue)/ (Yellow)/ (Green) • When [Detect Level] is set to [LOW]:  (Blue)/ (Orange)/ (White) • Changing the [Detect Level] setting also changes the [Display Color] setting as follows. <ul style="list-style-type: none"> –  (Light blue) ↔  (Blue) –  (Yellow) ↔  (Orange) –  (Green) ↔  (White)

- When [Peaking] is set, **[PEAKH]** ([Detect Level]: [HIGH]) or **[PEAKL]** ([Detect Level]: [LOW]) will be displayed.
- Each time the set function button is pressed when [Peaking] is set to [Fn Button Set] (P43) in the [Custom] menu, the peaking setting switches in order of [ON] ([Detect Level]: [LOW]) → [ON] ([Detect Level]: [HIGH]) → [OFF].
- Since only parts with clearly detectable outlines are highlighted as being in-focus, those to be highlighted vary depending on the recording conditions.
- The color used for highlighting does not affect recorded images.
- [Peaking] does not work with [Rough Monochrome] in Creative Control Mode.

Displaying/not displaying the MF Guide

MENU → **/C[Custom]** → **[MF Guide]** → **[ON]/[OFF]**

MF ASSIST

■ Displaying the MF Assist

- It is displayed by rotating the Zoom/MF ring.
- It can also be displayed by pressing ◀ to display the setup screen for the enlarged area, deciding the area to enlarge using the cursor button, and then pressing [MENU/SET].
- It will switch to the setting screen for the enlarged area by pressing the cursor button when the [Direct Focus Area] in the [Custom] menu is set to [ON].

■ Changing the display of the MF Assist

Each time the rear dial is pressed, an enlarged display switches between a windowed screen display and a full screen display.

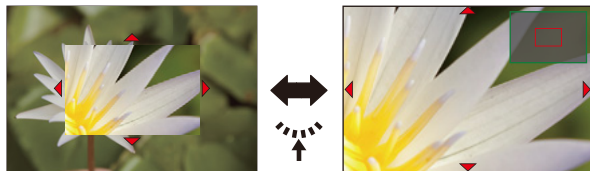

- If the rear dial is rotated, the display can be enlarged/reduced up to approximately 3 to 6 times when the enlarged display is in a windowed display or up to approximately 3 to 10 times when the enlarged display is in a full screen display.
The rear dial enlarges/reduces the size at a rate of 1 time.

■ Moving the enlarged area

- The enlarged area can be moved by pressing the cursor button.
- The following will return the MF assistance to the original position.
 - Pressing [DISP] when the setting screen for determining the area to be enlarged is displayed.

■ Closing the MF Assist

- It will close when the shutter button is pressed halfway.
- You can also close MF Assist by pressing [MENU/SET].
- If you have displayed the MF Assist by rotating the Zoom/MF ring, it will close approximately 10 seconds after you stop operating the camera.

Not available in these cases:

- The MF Assist is disabled in the Digital Zoom range or when recording motion pictures.





Technique for Manual Focus

- 1 Rotate the Zoom/MF ring to set the focus.
- 2 Rotate the Zoom/MF ring a little further in the same direction.
- 3 Rotate the Zoom/MF ring slightly in the opposite direction to fine-adjust the focus.

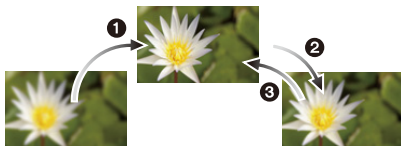

- If you zoom in/out after focusing on a subject, the focus may lose its accuracy. In that case, re-adjust the focus.
- After canceling Sleep Mode, focus on the subject again.
- If you are taking close-up pictures:
 - We recommend using a tripod and the self-timer (P173).
 - The effective focus range (depth of field) is significantly narrowed. Therefore, if the distance between the camera and the subject is changed after focusing on the subject, it may become difficult to focus on it again.
 - The resolution of the periphery of the picture may decrease slightly. This is not a malfunction.

Taking Close-up Pictures

Available in the following modes: **A** **A+** **P** **A** **S** **M** **C1** **C2** **SCN** **COL**

This mode allows you to take close-up pictures of a subject, e.g. when taking pictures of flowers.

- 1 Press **▼** [**AF**].
- 2 Press **◀/▶** to select the item and then [**MENU/SET**].

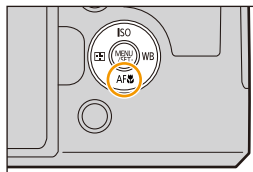



[AF] ([AF Macro])	You can take pictures of a subject as close as 3cm (1 ³ / ₁₆ ") from the lens by rotating the zoom lever towards [W] and setting the shortest focal length /1× magnification)
[] ([Macro Zoom])	Use this setting to be able to move close to the subject and thereby increase the reproduction ratio. You can take a picture with the Digital Zoom up to 3× while maintaining the distance to the subject for the extreme Wide position [3 cm (1 ³ / ₁₆ ")]. • The image quality is poorer than during normal recording. • The zoom range will be displayed in blue. (digital zoom range)
[OFF]	—



- We recommend using a tripod and the Self-timer.
- We recommend setting the flash to  (close the flash) when you take pictures at close range.
- If the distance between the camera and the subject is beyond the focusing range of the camera, the picture may not be properly focused even if the focus indication lights up.
- When a subject is close to the camera, the in-focus area is significantly shallower. Therefore, if the distance between the camera and the subject is changed after focusing on the subject, it may become difficult to focus on it again.
- Macro Mode gives priority to a subject close to the camera. Therefore, if the distance between the camera and the subject is far, it takes longer to focus on it.
- When you take pictures at close range, the sharpness at the edges of the frame may decrease slightly. This is not a malfunction.
- If the front lens surface becomes dirty with fingerprints or dust, the lens may not be able to focus on the subject correctly.



- [AF Macro] is not available when the Focus Mode is set to [MF].
- [Macro Zoom] cannot be set in the following cases.
 - [Handheld Night Shot]/[Panorama Shot] (Scene Guide Mode)
 - [High Speed Video] (Creative Video Mode)
 - [Impressive Art]/[Toy Effect]/[Toy Pop]/[Miniature Effect] (Creative Control Mode)
 - When [Burst Rate] in the [Rec] menu is set to [SH]
 - When [HDR] is set to [ON]
 - [Multi Exp.]
 - When [Quality] is set to [RAW , [RAW , or [RAW]

Focus and Exposure Memory Lock (AF/AE Lock)

Available in the following modes:

This function is useful when you want to take a picture of a subject outside the AF area and/or for subjects whose brightness is above or below average.

- 1 Aim the AF frame at the main subject (in case it is to be placed off-center), or at an other subject of average brightness (In case it is significantly darker or brighter).**
- 2 Press and hold [AF/AE LOCK] to lock the focus and/or exposure settings.**

- After [AF/AE LOCK], AF/AE Lock is canceled.
- Only the exposure setting is locked in the default setting.

- 3 While keeping [AF/AE LOCK] pressed, move the camera to compose the picture and then press the shutter button fully.**

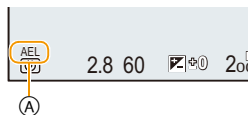

AE Lock indication

- When [AE LOCK] is set, after pressing the shutter button halfway to focus, press the shutter button fully.

Setting the functions of [AF/AE LOCK]

MENU → [Custom] → [AF/AE Lock]

[AE LOCK]	<p>Only the exposure is locked.</p> <ul style="list-style-type: none"> • [AEL], aperture value and the shutter speed light up when the exposure is set.
[AF LOCK]	<p>Only the focus is locked.</p> <ul style="list-style-type: none"> • [AFL], the focus indication, the aperture value and the shutter speed light up when the subject is focused.
[AF/AE LOCK]	<p>Both focus and exposure are locked.</p> <ul style="list-style-type: none"> • [AFL], [AEL], the focus indication, the aperture value, and the shutter speed light up when the subject is focused and the exposure is set.
[AF-ON]	Autofocusing is performed.





Maintaining/not maintaining the lock when [AF/AE LOCK] is released

MENU → **/C[Custom]** → **[AF/AE Lock Hold]** → **[ON]/[OFF]**

- Only AF Lock is effective when taking pictures in Manual Exposure Mode.
- Only AE Lock is effective when taking pictures with Manual Focus.
- Only AF lock is active during motion picture recording. Once you cancel AF lock during the recording, it cannot be reactivated.
- The subject can be focused again by pressing the shutter button halfway even when AE is locked.
- Program Shift can be set even when AE is locked.

Exposure Compensation

Available in the following modes: 

Use this function when you wish to modify the exposure settings the camera delivers, e.g. when your main subject would otherwise be rendered brighter/darker than you want.

- 1 Press the rear dial to switch to Exposure Compensation operation.

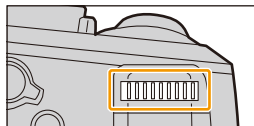

- 2 Rotate the rear dial to set an exposure compensation value.

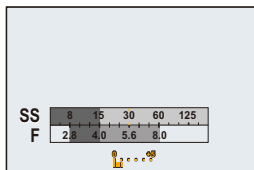

- The Exposure Compensation value can be set within a range of -5 EV to $+5$ EV. When recording motion pictures, the Exposure Compensation value can be set within a range of -3 EV to $+3$ EV.
- Select [0] to return to the original exposure.

- 3 Press the rear dial to set.

- When [Auto Exposure Comp.] in [Flash] in the [Rec] menu is set to [ON], the brightness of the built-in flash will automatically be set to the level appropriate to the selected Exposure Compensation value. (P205)
- When the exposure value is beyond the -3 EV to $+3$ EV range, the brightness of the displayed image will not change any further. It is recommended to check the actual brightness of the recorded image with Auto Review or playback.
- The set Exposure Compensation value is memorized even if the camera is turned off. (When [Exposure Comp. Reset] (P53) is set to [OFF])

Setting the ISO Sensitivity

Available in the following modes:  P A S M C1 C2

This allows the sensitivity to light (ISO sensitivity) to be set. Higher values allow using faster shutter speeds e.g. for unblurred hand-held shots and/or higher aperture values e.g. for more depth of field.

- 1 Press **▲** (ISO).
- 2 Select the ISO sensitivity by rotating the rear dial.
- 3 Press the rear dial to set.

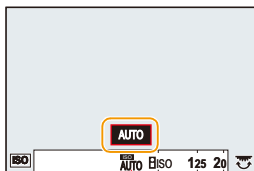
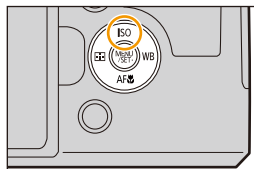



AUTO	The ISO sensitivity is automatically adjusted according to the brightness. • Maximum [3200]* ¹
 (Intelligent)	The camera detects movement of the subject and then automatically sets the optimum ISO sensitivity and shutter speed to suit the movement of the subject and brightness of the scene to minimize subject blurring. • Maximum [3200]* ¹ • The shutter speed is not fixed when the shutter button is pressed halfway. It is continuously changing to match the movement of the subject until the shutter button is pressed fully.
80*²/100*²/125/200/400/800/ 1600/3200/6400/12500/25000*²	The ISO sensitivity is fixed to various settings. • When the [ISO Increments] in [Rec] menu (P163) is set to [1/3 EV], the number of available ISO sensitivity increments will increase.

*1 When the [ISO Limit Set] (P163) of [Rec] menu is set to anything except [OFF], it is set automatically within the value set in [ISO Limit Set].

*2 Only available when [Extended ISO] is set.

Characteristics of the ISO sensitivity

	125  12500	
Recording location (recommended)	When it is bright (outdoors)	When it is dark
Shutter speed	Slower	Faster
Noise	Less	More
Subject blurring	More	Less

- For the focus range of flash when [AUTO] is set, refer to P199.
-  is not available in Shutter-Priority Mode and Manual Exposure Mode.
- When [Multi Exp.] is set, the maximum setting is [3200].
- When [Direct Focus Area] (P148) is set to [ON], the operations on the cursor buttons translate to movements of the AF area. Set using the Quick Menu (P39).
- Setting items below will be selectable in Creative Video Mode.
[AUTO]/[125] to [6400]

Setting the upper ISO sensitivity limit

Available in the following modes: **P** **A** **S** **M** CM **C1** **C2** **SCN** **COL**

This function allows limiting the ISO range utilized by Auto ISO, e.g. to determine the accepted amount of noise.

MENU → **[Rec]** → **[ISO Limit Set]**

Settings: **[200]/[400]/[800]/[1600]/[3200]/[6400]/[12500]/[OFF]**

- The function will work when the [Sensitivity] is set to [AUTO] or [ISO].



[ISO Limit Set] is disabled in the following cases:

- [Clear Nightscape]/[Cool Night Sky]/[Warm Glowing Nightscape]/[Handheld Night Shot] (Scene Guide Mode)
- When recording motion pictures

Setting the ISO sensitivity setting increments

Available in the following modes: **P** **A** **S** **M** CM **C1** **C2** **SCN** **COL**

You can determine whether to set the ISO values in 1EV or 1/3EV steps.

MENU → **[Rec]** → **[ISO Increments]**

[1/3 EV]	[L.80]*/[L.100]*/[125]/[160]/[200]/[250]/[320]/[400]/[500]/[640]/[800]/[1000]/[1250]/[1600]/[2000]/[2500]/[3200]/[4000]/[5000]/[6400]/[8000]/[10000]/[12500]/[H.16000]*/[H.20000]*/[H.25000]*
[1 EV]	[L.80]*/[L.100]*/[125]/[200]/[400]/[800]/[1600]/[3200]/[6400]/[12500]/[H.25000]*

* Only available when [Extended ISO] is set.

- When the setting is changed from [1/3 EV] to [1 EV], [Sensitivity] will be set to value closest to the value set with [1/3 EV].

Extending ISO sensitivity

Available in the following modes: **P** **A** **S** **M** CM **C1** **C2** **SCN** **COL**

This mode allows setting the ISO sensitivity up to [25000]

MENU → **[Rec]** → **[Extended ISO]**





Settings: **[ON]/[OFF]**

Selecting the Exposure Metering Mode

Available in the following modes: 

You can select between three different brightness metering methods.

MENU →  [Rec] → [Metering Mode]

 (Multiple)	The brightness is detected in different sections of the frame. The exposure is then based on the probable main subject. Usually, we recommend using this method.
 (Center-weighted)	This method concentrates metering sensitivity on the subject in the center of the screen while also registering the rest of the frame.
 (Spot)	This method concentrates metering sensitivity on the subject in the center of the screen while also registering the rest of the frame  .

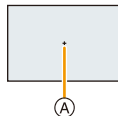

- These menu items are shared by the [Rec] menu and the [Motion Picture] menu. When the setting for either of the two is changed, the setting for the other is also changed.

Setting the Shutter Type

Available in the following modes:          

You can use either of the two shutters to take pictures: the mechanical shutter or the electronic shutter.

	Mechanical shutter	Electronic Shutter
Description	The camera starts an exposure electronically, and ends it with the mechanical shutter.	The camera starts and ends an exposure electronically.
Flash	○	—
Shutter Speed	60 to 1/4000s	1 to 1/16000s
Shutter sound	Mechanical shutter sound*1+ Electronic shutter sound*2	Electronic shutter sound*2

*1 The mechanical shutter sound cannot be muted.

*2 Electronic shutter sound settings can be changed in [Shutter Vol.]. (P48)

Select the menu.

MENU →  **[Rec]** → **[Shutter Type]**

[AUTO]	Depending on the recording condition and the shutter speed, the shutter type is switched automatically. • Priority is given to the mechanical shutter, which places less limitations on functions, including the ones you use when taking pictures with the flash.
[MSHTR]	Takes pictures only with the mechanical shutter.
[ESHTR]	Takes pictures using only the electronic shutter method.



- When [E] is displayed on the screen, pictures will be taken with the electronic shutter.
- When [Burst Rate] is set to [SH], pictures will be taken with the electronic shutter.
- When [Silent Mode] is set to [ON], pictures will be taken with the electronic shutter.
- **When a moving subject is recorded with the electronic shutter, the subject may appear distorted on the picture.**
- **When the electronic shutter is used under fluorescent or LED lighting, etc., horizontal stripes may appear on the picture. In such cases, lowering the shutter speed may reduce the effect of the horizontal stripes. (P87)**
- **Remember not to exploit this function whenever photographing may violate the privacy, the likeness rights, etc. of the targeted subject. Use at your own risk.**





Selecting a Drive Mode

Available in the following modes: **A** **A+** **P** **A** **S** **M** **C1** **C2** **SCN** **COL**

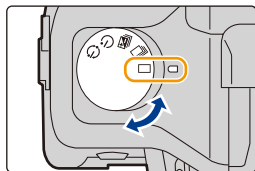
You can change what the camera will do when you press the shutter button.

Rotating the drive mode dial.



 Single	When the shutter button is pressed, only one picture is taken.
 Continuous (P168)	Pictures are taken in succession as long as the shutter button is pressed.
 Auto Bracket (P171)	Each time the shutter button is pressed, a series of pictures is taken with different exposure settings according to the selected interval.
 Self-timer (P173)	When the shutter button is pressed, the picture is taken after the set time has elapsed.
 Time Lapse/Animation (P174, 178)	Pictures are recorded with Time Lapse Shot or Stop Motion Animation.



These settings are not available with [Panorama Shot] in Scene Guide Mode.

Using Continuous Mode

Available in the following modes: **A** **A+** **P** **A** **S** **M** **C1** **C2** **SCN** **COL**

Pictures are taken continuously as long as the shutter button is pressed.

- Pictures taken with the frame rate [SH] will be recorded as a single picture group (P220).

- 1 Set the drive mode dial to [].

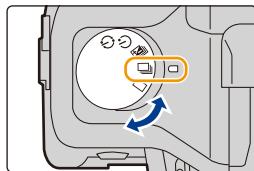

- 2 Focus on the subject and take a picture.

- Keep the shutter button fully pressed to activate Continuous Mode.



■ Changing the frame rate

- 1 Select the menu.

MENU →  [Rec] → [Burst Rate]

- 2 Press **▲/▼** to select the frame rate and then [MENU/SET].



Frame rate		[SH] ^{*2} (Super high speed)	[H] (High speed)	[M] (Medium speed)	[L] (Low speed)
Pictures/ second	AFS	50	12	7	2
	AFF/AFC	—	7	7	2
Live View during Continuous Mode		Not available	Not available	Available	Available
*1	With RAW files	—	10 ^{*3,4}	10 ^{*3,4}	10 ^{*3,4}
	Without RAW files	Max. 60	Depends on the capacity of the card ^{*4}		

*1 Number of recordable pictures

*2 The electronic shutter will operate.

*3 Depending on the recording conditions, the number of frames in a series may be reduced. (For example, when you set [i.Resolution] of the recording menu, the number of frames in a series may be reduced)

*4 Pictures can be taken until the card reaches its capacity limit. However the frame rate will become slower halfway. The exact timing of this depends on the aspect ratio, the resolution, the compression rate setting and the type of card used.

- The frame rate may become slower depending on the following settings.
 - [Picture Size] (P132)/[Quality] (P133)/[Sensitivity] (P161)/Focus Mode (P140)/[Focus/Release Priority] (P150)
- Refer to P133 for information about RAW files.





Focusing in Continuous Mode

The method for achieving focus varies depending on the focus mode (P140) and the [Focus/Release Priority] (P150) setting in the [Custom] menu.

Focus Mode	Focus/Release Priority	Focusing
AFS	[FOCUS]	At the first picture
	[RELEASE]	
AFF/AFC*1	[FOCUS]	Normal focusing*2
	[RELEASE]	Predicted focusing*3
MF	—	Focus set with Manual Focus

*1 When the subject is dark or the frame rate is set to [SH], the focus is fixed on the first picture.

*2 The frame rate may become slower because the camera is continuously focusing on the subject.

*3 The frame rate takes priority, and focus is estimated within possible range.

- When the continuous shooting speed is set to [H], continuous shooting speed may be reduced while shooting a large number of consecutive pictures.
- When the frame rate is set to [SH] or [H] (when the Focus mode is [AFS] or [MF]), the exposure and White Balance settings are fixed at those used for the first picture for the subsequent pictures as well. When the frame rate is set to [H] (when the Focus mode is [AFF] or [AFC]), [M] or [L], they are adjusted each time you take a picture.
- Since the shutter speed becomes slower in dark places, the frame rate may become slower.
- Depending on the operating conditions, it may take time to take the next picture immediately after taking a series.
- **It may take time to save pictures taken in Continuous Mode on the card. If you take pictures continuously while saving, the maximum number of recordable pictures decreases. For continuous shooting, use of a high speed memory card is recommended.**



The Continuous Mode is disabled in the following cases:

- [Glistening Water]/[Glittering Illuminations]/[Handheld Night Shot]/[Soft Image of a Flower]/[Panorama Shot] (Scene Guide Mode)
- [Rough Monochrome]/[Silky Monochrome]/[Miniature Effect]/[Soft Focus]/[Star Filter]/[Sunshine] (Creative Control Mode)
- When White Balance Bracket is set
- When recording motion pictures
- When recording using the flash
- When recording with [iHandheld Night Shot]
- When [HDR] is set to [ON]
- [Multi Exp.]
- In the following cases, [SH] in Continuous Mode cannot be used.
 - When [Quality] is set to [RAW \uparrow], [RAW \downarrow] or [RAW]

Using Auto Bracket

Available in the following modes: [A] [Av] [P] [A] [S] [M] [C1] [C2] [SCN] [COL]

In this mode, up to a maximum of 7 pictures are automatically taken with the selected exposure steps.

With Auto Bracket

[Step]: [3•1/3], [Sequence]: [0/-/+]

1st picture



±0 EV

2nd picture



-1/3 EV

3rd picture



+1/3 EV

- 1 Set the drive mode dial to .

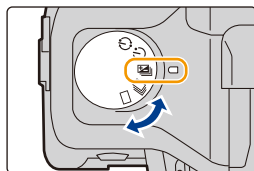

- 2 Focus on the subject and take a picture.

- If you press and hold the shutter button, the number of pictures that you had set is taken.
- The Auto Bracket indication flashes until the number of pictures that you had set is taken.
- The picture count is reset to [0] if you change the Auto Bracket setting or turn the camera off before all the pictures that you had set are taken.



■ Changing the settings for [Single/Burst Settings], [Step] and [Sequence] in Auto Bracket

1 Select the menu.

MENU → [Rec] → [Auto Bracket]

2 Press ▲/▼ to select [Single/Burst Settings], [Step] or [Sequence] and then MENU/SET].

3 Press ▲/▼ to select the setting and then [MENU/SET].

[Single/Burst Settings]	[□] (single)	[Sequence]	[0/-/+]
	[] (continuous)		[-/0/+]
[Step]	[3•1/3] (3 pictures)		
	[3•2/3] (3 pictures)		
	[3•1] (3 pictures)		
	[5•1/3] (5 pictures)		
	[5•2/3] (5 pictures)		
	[5•1] (5 pictures)		
	[7•1/3] (7 pictures)		
	[7•2/3] (7 pictures)		
	[7•1] (7 pictures)		

- You can take one picture at a time when set to [□].
- You can continuously take pictures up to set numbers when set to [].
- Exit the menu after it is set.

- When taking pictures using Auto Bracket after setting an Exposure Compensation value, the pictures taken are based on the selected Exposure Compensation value.



Auto Bracket is disabled in the following cases.

- [Glistening Water]/[Glittering Illuminations]/[Handheld Night Shot]/[Soft Image of a Flower]/[Panorama Shot] (Scene Guide Mode)
- [Rough Monochrome]/[Silky Monochrome]/[Miniature Effect]/[Soft Focus]/[Star Filter]/[Sunshine] (Creative Control Mode)
- When White Balance Bracket is set.
- When recording motion pictures
- When recording using the flash
- When recording with [iHandheld Night Shot]
- When [HDR] is set to [ON]
- [Multi Exp.]

Using the Self-timer

Available in the following modes: **A** **A+** **P** **A** **S** **M** **C1** **C2** **SCN** **COL**

1 Set the drive mode dial to [⌚].

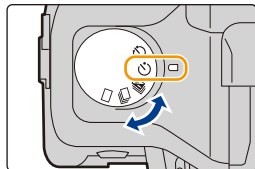

2 Press the shutter button halfway to focus and then press it fully to take the picture.

- Focus and exposure will be set when the shutter button is pressed halfway.
- After the self-timer indicator flashes, recording starts.

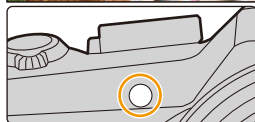

■ Changing the time setting for the self-timer

1 Select the menu.

MENU → **[Rec]** → **[Self Timer]**

2 Press **▲/▼** to select the mode and then press **[MENU/SET]**.

	The picture is taken 10 seconds after shutter is pressed.
	After 10 seconds the camera takes 3 pictures at about 2 seconds intervals.
	The picture is taken 2 seconds after shutter is pressed.
	• When using a tripod, etc., this setting is a convenient way to avoid the camera shake caused by pressing the shutter button.



- We recommend using a tripod when recording with the self-timer.

- The flash output may vary slightly when the [⌚] is selected.



This item cannot be set to [⌚] in the following cases.

- When White Balance Bracket is set
- [Multi Exp.]
- Self-timer is disabled in the following cases.
 - [Panorama Shot] (Scene Guide Mode)
 - When recording motion pictures

Taking Pictures Automatically at Set Intervals

Available in the following modes: **A** **A*** **P** **A** **S** **M** **C1** **C2** **SCN** **COL**

If you set the start time, the time between the shots and the number of pictures, the camera can automatically create a motion picture of subjects such as animals or plants as time elapses.

• **Set the date and time settings in advance. (P34)**

• Pictures taken with Time Lapse Shot are displayed as a set of group pictures. (P220)

1 Set the drive mode dial to [].

- To use the settings you used for the previous picture with the drive mode [], start recording without changing the settings.

2 Press [MENU/SET].

- The screen selected with [Time Lapse/Animation] in the recording menu will be displayed. (The screen will be displayed only when you press [MENU/SET] for the first time after switching the drive mode dial to []. In other cases, the camera operates as usual, displaying the menu screen.)

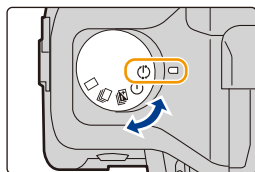

3 Press [MENU/SET].

4 Select [Mode] with , and then press [MENU/SET].

5 Select [Time Lapse Shot] with , and then press [MENU/SET].

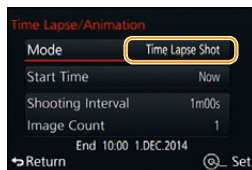

6 Press ▲/▼ to select the item and then [MENU/SET].

[Start Time]	[Now]	Starts the recording when the shutter button is pressed fully.
	[Start Time Set]	You can set the time to start recording. Any time up to 23 hours 59 minutes ahead can be set. Select the item (hour or minute) by pressing ◀/▶, set the start time by pressing ▲/▼, and then press [MENU/SET].
[Shooting Interval]/ [Image Count]	The time between the shots and the number of pictures can be set. ◀/▶: Select the item (minute/second/number of pictures) ▲/▼: Setting [MENU/SET]: Set <ul style="list-style-type: none"> The time between the shots (interval) can be selected within a range of 1 second to 99 minutes and 59 seconds at 1 second increments. The number of pictures ranging from 1 to 9999 can be set. 	

- Set the interval ④ so that it will be longer than the shutter speed ⑤. (The figure below) A shot may be skipped when the interval ④ is shorter than the shutter speed ⑤, for example during night-time recording.

- ①: First
- ②: Second
- ③: Third

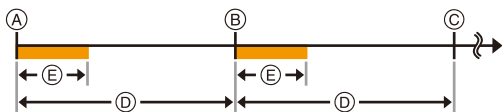

7 Press the shutter button halfway.

- The recording screen will be displayed. You can also perform the same operation by pressing and holding [⏏/⏏] until the recording screen is displayed.



8 Press the shutter button fully.

- The recording starts automatically.
- During recording standby, the power will turn off automatically if no operation is performed for a certain period. The Time Lapse Shot is continued even with the power turned off. When the recording start time arrives, the power turns on automatically. To turn on the power manually, press the shutter button halfway.
- If [FN2] is pressed while the camera is turned on, a selection screen asking you to pause or end will be displayed. Operate in accordance with the screen. Also, if [FN2] is pressed during the pause, a selection screen asking you to resume or end will be displayed. Pressing the shutter button fully will also enable you to resume from the pause.
- A confirmation screen for creating a motion picture is displayed next, so select [Yes].

9 Select the methods for creating a motion picture.

[Rec Quality]	For setting the quality of a motion picture. • With camera models 18 194 / 18 195: [4K/30p]/[FHD/60p]/[FHD/30p]/[HD/30p]/[VGA/30p] • With camera models 18 193 / 18 196: [4K/25p]/[FHD/50p]/[FHD/25p]/[HD/25p]/[VGA/25p]
[Frame Rate]	For setting the number of frames per second. The higher the frame rate is, the smoother the motion picture will be. • With camera models 18 194 / 18 195: [60fps]*/[30fps]/[15fps]/[10fps]/[7.5fps]/[6fps]/[3fps]/[1fps] * Only when set to [FHD/60p] • With camera models 18 193 / 18 196: [50fps]*/[25fps]/[12.5fps]/[8.3fps]/[6.25fps]/[5fps]/[2.5fps]/[1fps] * Only when set to [FHD/50p]
[Sequence]	[NORMAL]: Splices pictures together in recording order. [REVERSE]: Splices pictures together in reverse recording order.

10 Select [OK] with ▲/▼, and then press [MENU/SET].

- A confirmation screen is displayed. It is executed when [Yes] is selected.
- Motion pictures can also be created from [Time Lapse Video] in the [Playback] menu. (P235)

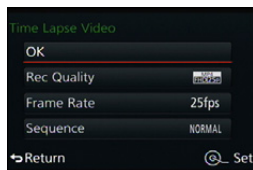

■ Changing the Time Lapse Shot settings

You can change the settings in [Time Lapse/Animation] in the [Rec] menu.

- This function is not for use as a security camera.
- **If you leave the camera somewhere to perform [Time Lapse Shot], make sure to prevent theft.**
- **Recording for long periods in cold places such as ski resorts or places at high altitude, or in warm, wet environments may cause a malfunction, so it is suggested to monitor the operation.**
- Recording may not be consistent with the set interval or the set number of pictures depending on recording conditions.
- We recommend that you use a sufficiently charged battery.
- [Time Lapse Shot] is paused in the following cases.
During [Time Lapse Shot], you can replace the battery and the card, and then restart by turning the camera on again. Turn it off when replacing the battery or the card.
 - When the charge on the battery runs out
 - When the camera is turned off
- Do not connect an AV or an HDMI micro cable, or the USB connection cable (supplied) during Time Lapse Shooting.
- When a picture quality different from the aspect ratio of the original pictures is selected, black strips will be displayed on the top and bottom or the left and right of the motion picture.
- A motion picture that exceeds the recording time of 29 minutes or a size of 4 GB cannot be created.
- Motion pictures less than two seconds long will display "2s" as the motion picture recording time (P70).
- When only one picture is taken, it will not be saved as a group picture.



This function is not available in the following cases:

- [Handheld Night Shot]/[Panorama Shot] (Scene Guide Mode)
- [Multi Exp.]

Creating Stop Motion Pictures

Available in the following modes: **A** **A⁺** **P** **A** **S** **M** **C1** **C2** **SCN** **COL**

A stop motion picture is created by splicing pictures together.

- **Set the date and time settings in advance.** (P34)
- Pictures taken with [Stop Motion Animation] are displayed as a group of pictures. (P220)



Before creating a motion picture with [Stop Motion Animation]

With [Stop Motion Animation], you can make a motion picture in which objects appear to be moving by making a recording each time you move it in small increments, and then splicing the recordings together.



• With camera models 18 194 / 18 195:

The resulting motion pictures can have frame rates 1 to 60fps.

• With camera models 18 193 / 18 196:

The resulting motion pictures can have frame rates 1 to 50fps.

- For smoother motion, record movement in as small increments as possible, and set the frame rate (pictures per second) to a large value.

1 Set the drive mode dial to [].

- To use the settings you used in the previous picture with the drive mode [], start recording without changing the settings.

2 Press [MENU/SET].

- The screen selected with [Time Lapse/Animation] in the recording menu will be displayed. (The screen will be displayed only when you press [MENU/SET] for the first time after switching the drive mode dial to []. In other cases, the camera operates as usual, displaying the menu screen.)

3 Press [MENU/SET].

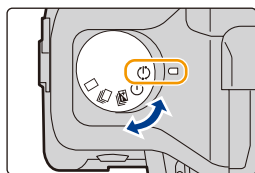

- 4 Select [Mode] with ▲/▼, and then [MENU/SET].
- 5 Select [Stop Motion Animation] with ▲/▼, and then press [MENU/SET].

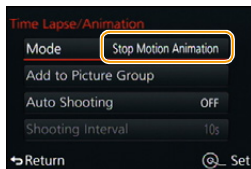

- 6 Press ▲/▼ to select the recording method, and then press [MENU/SET].

[Auto Shooting]	[ON]	Takes pictures automatically at a set interval. When the shutter button is pressed fully, recording starts.
	[OFF]	This is for taking pictures manually, frame by frame.
[Shooting Interval]	<p>(Only when [Auto Shooting] is set to [ON])</p> <p>Sets the interval for automatic recording. A value between 1 and 60 seconds can be set in 1 second increments.</p> <p>Press ◀/▶ to select the recording interval (seconds), then ▲/▼ to set it, and then [MENU/SET].</p>	

- 7 Press the shutter button halfway.
 - The recording screen will be displayed. You can also perform the same operation by pressing and holding [⏏/⏏] until the recording screen is displayed.



- 8 Press the shutter button fully.
 - Up to 9999 frames can be recorded.
- 9 Move the subject according to the intended composition.

- Repeat recording in the same way.
- If the camera is turned off during recording, a message for resuming the recording is displayed when the camera is turned on. Selecting [Yes] allows you to resume the recording from the interruption point.



Checking and editing ongoing recordings

- The recording screen displays up to two pictures taken previously. Use them as reference for the amount of movement.
- Pressing [▶] allows you to check recorded pictures. Unnecessary pictures can be deleted by pressing [⏏/⏏]. Pressing [▶] again will return you to the recording screen.



10 To stop the recording, press [MENU/SET], select [Time Lapse/Animation] in the [Rec] menu, and press [MENU/SET].

- A confirmation screen is displayed. It is ended when [Yes] is selected.
- A confirmation screen for creating a motion picture is displayed next, so select [Yes].

11 Select the methods for creating a motion picture.

[Rec Quality]	For setting the quality of a motion picture. <ul style="list-style-type: none"> • With camera models 18 194 / 18 195: [4K/30p]/[FHD/60p]/[FHD/30p]/[HD/30p]/[VGA/30p] • With camera models 18 193 / 18 196: [4K/25p]/[FHD/50p]/[FHD/25p]/[HD/25p]/[VGA/25p]
[Frame Rate]	For setting the number of frames per second. The higher the frame rate is, the smoother the motion picture will be. <ul style="list-style-type: none"> • With camera models 18 194 / 18 195: [60fps]*/[30fps]/[15fps]/[10fps]/[7.5fps]/[6fps]/[3fps]/[1fps] * Only when set to [FHD/60p] • With camera models 18 193 / 18 196: [50fps]*/[25fps]/[12.5fps]/[8.3fps]/[6.25fps]/[5fps]/[2.5fps]/[1fps] * Only when set to [FHD/50p]
[Sequence]	[NORMAL]: Splices pictures together in recording order. [REVERSE]: Splices pictures together in reverse recording order.

12 Press ▲/▼ to select [OK] and then [MENU/SET].

- A confirmation screen is displayed. The function is executed when [Yes] is selected.
- Motion pictures can also be created from [Stop Motion Video] in the [Playback] menu. (P235)

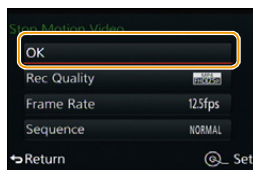

■ Changing the settings of Stop Motion Animation

You can change the settings in [Time Lapse/Animation] in the [Rec] menu.

■ Adding pictures to the Stop Motion Animation group

Selecting [Add to Picture Group] in step 6 will display group pictures recorded with [Stop Motion Animation].

Select a set of group pictures, press [MENU/SET], and then select [Yes] on the confirmation screen.

- Automatic recording may not take place at set intervals because recording takes time under certain recording conditions, such as when the flash is used for recording.
- When a picture quality different from the aspect ratio of the original pictures is selected, black strips will be displayed on the top and bottom or the left and right of the motion picture.
- When a picture quality with a resolution larger than the original pictures is selected, the resolution of the motion picture will deteriorate.
- We recommend that you use a sufficiently charged battery.
- A motion picture that exceeds the recording time of 29 minutes or a size of 4 GB cannot be created.
- Motion pictures less than two seconds long will display "2s" as the motion picture recording time (P70).
- If only one picture was taken, the picture is not saved as a group picture. A picture cannot be selected from [Add to Picture Group] when it is the only one that was taken.



[Stop Motion Animation] is not available in the following cases.

- [Panorama Shot] (Scene Guide Mode)
 - [Multi Exp.]
- [Auto Shooting] is not available in the following cases.
- [Handheld Night Shot] (Scene Guide Mode)

Functions Customized for Various Subjects and Purposes

Making Multiple Exposures on One Picture

Available in the following modes: **A** **P** **A** **S** **M** **C1** **C2** **SCN** **COL**

Gives an effect like multi exposure. (up to 4 times equivalent per a single image)

1 Select the menu.

MENU → **[Rec]** → **[Multi Exp.]**

2 Press ▲/▼ to select [Start] and then press [MENU/SET].

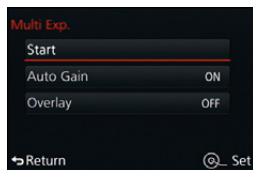

3 Decide on the composition, and take the first picture.

- After taking the picture, press the shutter button halfway to take the next picture.
- Press ▲/▼ to select the item and then [MENU/SET] for one of the following operations.
 - [Next]: Advance to the next picture.
 - [Retake]: Return to the first picture.
 - [Exit]: Record the image of the first picture, and finish the multiple exposure picture-taking session.



4 Shooting the second, third, and fourth exposures.

- If [FN1] is pressed while taking pictures, the photographed images are recorded, and the multiple exposure picture-taking session will be completed.

5 Press ▼ to select [Exit] and then [MENU/SET].

- You can also press the shutter button halfway to finish.

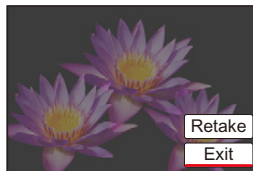

■ About Automatic Gain Control setting

Select [Auto Gain] on the screen shown in step **2** and set it.

- **[ON]:** The brightness level is adjusted according to the number of pictures taken and the pictures are superimposed over each other.
- **[OFF]:** Compensate the exposure to match the subject so that all the superimposed exposure effects will be just right.

■ Combining RAW images on the card

On the screen shown in step **2**, set [Overlay] to [ON].

After [Start], images on the card will be displayed. Select the RAW images, press [MENU/SET], and continue recording.

- [Overlay] is available only for RAW images taken with this camera.

- An image is not recorded until completion.
- The recording information displayed for pictures taken with multiple exposures is that for the last picture taken.
- Items shown in gray on the menu screen cannot be set during multiple exposures.



This function is not available in the following cases:

- When using [Time Lapse Shot]
- When using [Stop Motion Animation]

Disabling Operational Sounds and the Light Sources at once

Available in the following modes: **A** **AF** **P** **A** **S** **M** **MM** **C1** **C2** **SCN** **COL**

This function is useful for recording images in a quiet environment, public facility, etc. or recording images of subjects such as babies or animals.

Select the menu.

MENU → **/c[Custom]** → **[Silent Mode]**

Settings: [ON]/[OFF]

- Operational sounds are muted, and the flash and the AF Assist lamp are switched off.

The following settings are fixed.

- [Shutter Type]: [ESHTR]
- [Flash Mode]: [☺] (flash off)
- [AF Assist Lamp]: [OFF]
- [Beep Volume]: [X] (OFF)
- [Shutter Vol.]: [X] (OFF)

- Even when [ON] is set, the following functions light up/flash.

- Status indicator
- Self-timer indicator
- Wi-Fi connection lamp

- Operational sounds of the camera, such as the sound of the lens aperture being adjusted, are not muted.

- **Remember not to exploit this function whenever photographing may violate the privacy, the likeness rights, etc. of the subject. Use at your own risk.**

Taking Pictures of Registered Faces

Available in the following modes: **A** **A*** **P** **A** **S** **M** **C1** **C2** **SCN** **COL**

Face Recognition is a function which identifies a face as resembling a registered face and prioritizes focus and exposure automatically. Even if the person is located towards the back or on the end of a line in a group photo, the camera will still render the identified face in focus.

Select the menu.

MENU → **[Rec]** → **[Face Recog.]**

Settings: **[ON]/[OFF]/[MEMORY]**

[Face Recog.] is initially set to **[OFF]** on the camera.

[Face Recog.] will turn **[ON]** automatically when the face image is registered.

- The following functions will also work with the Face Recognition function.

In Recording Mode

- The display of corresponding name when the camera detects a registered face* (if a name has been set for the registered face)

* Names of up to 3 people are displayed.

Precedence for the names displayed when taking pictures is determined according to the order of registration.

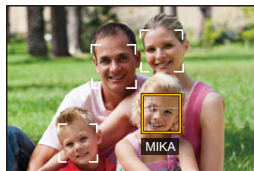

In Playback Mode

- The display of name and age (if information has been registered)
- Selective playback of pictures chosen from pictures registered with Face Recognition ([Category Play] [\(P225\)](#))



- **[Face Recog.] only works when the AF Mode is set to [☺].**
- During the Continuous Mode, [Face Recog.] picture information can only be based on the first picture.
- When group pictures are played back, the name of the first picture of the set is displayed.
- Face Recognition may take more time to select and recognize distinctive facial features than regular Face/Eye Detection.
- Even when face recognition information has been registered, pictures taken with [Name] set to [OFF] will not be categorized by face recognition in [Category Play].
- **Even when Face Recognition information is changed (P189), Face Recognition information for the pictures already taken will not be changed.**
For instance, if the name is changed, pictures recorded before the change will not be categorized by face recognition in [Category Play].
- To change the name information of the pictures taken, perform the [REPLACE] in [Face Rec Edit] (P243).



You cannot use [Face Recog.] in the following cases.

- Recording Modes which do not allow setting to [☺] of the AF Mode (P139)
- [Panorama Shot] (Scene Guide Mode)
- [Miniature Effect] (Creative Control Mode)
- When recording motion pictures
- When using [Time Lapse Shot]

Face Settings

You can register information such as names and birthdays for up to 6 people.

■ Point of recording when registering the face images

- The person should face the camera with eyes open and mouth closed, making sure the outline of the face, the eyes, or the eyebrows are not covered with hair when registering.
- Make sure there is no extreme shading on the face when registering. (Flash will not work during registration.)

(Good example for registering)



■ When a face is not recognized during recording

- Register the face of same person indoors and outdoors, or with different expressions or angles. (P188)
- Additionally register at the location of recording.
- When a person who is registered is not recognized, correct by re-registering.
- Face Recognition may not be possible or may not recognize faces correctly even for registered faces, depending on the facial expression and environment.

1 Press ▲/▼ to select [MEMORY] and then [MENU/SET].

2 Press ▲/▼/◀/▶ to select the Face Recognition frame that is not registered, and then [MENU/SET].

- [New] will not display if there are 6 people already registered. Delete a person already registered to register a new person.

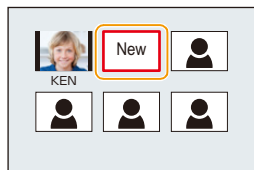

3 Take the picture positioning the face with the guide.

- A confirmation screen is displayed. The function is executed when [Yes] is selected.
- The faces of subjects other than people (animals, etc.) cannot be registered.
- To display the description of the face registration, press ►.

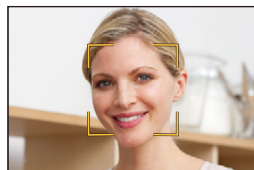

4 Press ▲/▼ to select the item and then [MENU/SET].

- You can register up to 3 face images.

[Name]	<p>For registering names.</p> <ol style="list-style-type: none"> 1 Press ▼ to select [SET] and then [MENU/SET]. 2 Enter the name. <ul style="list-style-type: none"> • For details on how to enter characters, refer to “Entering Text” section on P54.
[Age]	<p>For registering a birthday.</p> <ol style="list-style-type: none"> 1 Press ▼ to select [SET] and then [MENU/SET]. 2 Press ◀/▶ to select the items (Year/Month/Day), press ▲/▼ to set and then [MENU/SET].
[Add Images]	<p>For adding additional face images.</p> <p>(Add Images)</p> <ol style="list-style-type: none"> 1 Select the unregistered face recognition frame, and then press [MENU/SET]. 2 Perform step 3 in “Face Settings”.
	<p>For deleting one of the face images.</p> <p>(Delete)</p> <p>Press ◀/▶ to select the face image to delete, and then [MENU/SET].</p> <ul style="list-style-type: none"> • This feature requires that at least one facial image remains, once registered. • A confirmation screen is displayed. It is executed when [Yes] is selected.

Changing or deleting the information for a registered person

You can modify the pictures or information of an already registered person. You can also delete the information of the registered person.

- 1 Press ▼ to select [MEMORY] and then [MENU/SET].
- 2 Press ▲/▼/◀/▶ to select the face image to edit or delete and then [MENU/SET].
- 3 Press ▲/▼ to select the item and then [MENU/SET].

[Info Edit]	For changing the information of an already registered person. Perform step 4 in “Face Settings”.
[Priority]	The focus and exposure are preferentially adjusted for higher-priority faces. Press ▲/▼/◀/▶ to select the priority and then [MENU/SET].
[Delete]	For deleting information of a registered person. • A confirmation screen is displayed. It is executed when [Yes] is selected.

Recording Profiles of Children and Pets on Images

Available in the following modes:

By setting the name and birthday of your child or pet in advance, you can record their name and age in months and years on images.

You can display them during playback or stamp them on recorded images using [Text Stamp] (P231).

■ Setting [Age] or [Name]

1 Select the menu.

MENU → [Rec] → [Profile Setup]

Settings: [] ([Baby1])/[] ([Baby2])/[] ([Pet])/[OFF]/[SET]

2 Press ▲/▼ to select [SET] and then [MENU/SET].

3 Press ▲/▼ to select [Baby1], [Baby2] or [Pet] and then [MENU/SET].

4 Press ▲/▼ to select [Age] or [Name] and then [MENU/SET].

5 Press ▲/▼ to select [SET] and then [MENU/SET].

Enter [Age] (birthday)

◀/▶: Select the items (year/month/day)

▲/▼: Setting

[MENU/SET]: Set

Enter [Name]

For details on how to enter characters, refer to “Entering Text” on P54.



6 Press ▼ to select [Exit] and then [MENU/SET] to finish.

■ To cancel [Age] and [Name]

Select the [OFF] setting in step 1.



Still pictures recorded during motion picture recording ([] (motion picture priorities)) (P214) will not record age or name.

Using screens and displays suitable for recording

Displaying the center of the screen ([Center Marker])

Available in the following modes: 

The center of the recording screen will be indicated by [+]. This is convenient for changing the focal length/zooming while keeping the subject at the center of the screen.

MENU → \mathcal{L} C [Custom] → [Center Marker]

Settings: [ON]/[OFF]





Checking areas that may be white saturated ([Zebra Pattern])

Available in the following modes: 

You can check areas that may be white saturated by displaying areas above a certain luminance level in a zebra pattern. You can also set the minimum luminance level (brightness) to be processed as a zebra pattern.

MENU → \mathcal{L} C [Custom] → [Zebra Pattern]

[ZEBRA1]	Displays areas above a certain luminance level by a right-leaning zebra pattern.	
[ZEBRA2]	Displays areas above a certain luminance level by a left-leaning zebra pattern.	
[OFF]	—	
[SET]	<p>Sets the minimum brightness level for each zebra pattern. [Zebra 1]/[Zebra 2] Press ▲/▼ to select the brightness, and [MENU/SET]. • You can select a brightness value between [50%] and [105%]. In [Zebra 2], you can select [OFF]. If you select [100%] or [105%], only the areas that are already white saturated are displayed in a zebra pattern. The smaller the value is, the wider the brightness range to be processed as a zebra pattern will be.</p>	



- If there are any white saturated areas, it may be beneficial to compensate the exposure towards negative (P160) referring to the histogram (P65) and then taking the picture. It may result in a better quality picture.
- Displayed zebra patterns will not be recorded.
- If you assign [Zebra Pattern] to [Fn Button Set] (P43) in the [Custom] menu, each time you press the function button to which the setting is assigned, the zebra pattern toggles as follows: [Zebra 1] → [Zebra 2] → [OFF].
When [Zebra 2] is set to [OFF], the setting toggles in the order of [Zebra 1] → [OFF], allowing you to switch the setting quickly.

Displaying the recording screen in black and white ([Monochrome Live View])

Available in the following modes: 

You can display the recording screen in black and white. This function is convenient when a black and white screen will make it easier to set focus with Manual Focus.

MENU →  [Custom] → **[Monochrome Live View]**

Settings: [ON]/[OFF]

- Recorded images will not be affected.

Recording while monitoring camera images

When using the HDMI output, you can take pictures while monitoring the camera image on a TV, etc.

Refer to P275 on how to connect with TV by using an HDMI micro cable.

- The camera image is not output to the TV during motion picture recording.

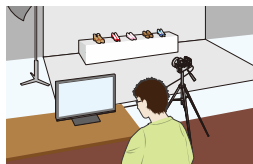

■ Switching the information displayed

You can change the display shown during HDMI output using [HDMI Info Display (Rec)] (P52) in [TV Connection] on the [Setup] menu.

[ON]: The camera display is output as is.

[OFF]: Only images are output.

- When using the Autofocus Mode [- [Aspect Ratio] in the [Rec] menu is fixed to [16:9].
- Electronic sounds and electronic shutter sounds are muted.
- If you set up a Wi-Fi connection while using the HDMI output, no image will be displayed on the camera monitor.
- The scene selection screen in Scene Guide Mode is not output through the HDMI connection.
- Images are not output through the HDMI connection in panorama picture recording.

Optical Image Stabilizer

The camera detects when it is not being held still during recording and automatically compensates the movements, so you can record images with reduced blurring.

Confirm that the O.I.S. switch is set to [ON].

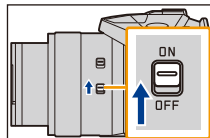

■ Setting the Stabilizer in the [Rec] menu

1 Select the menu.

MENU → **[Rec]** → **[Stabilizer]**

2 Press ▲/▼ to select the item and then [MENU/SET].

 ([Normal])	Vertical and horizontal shake are compensated for.
 ([Panning])	Camera shake is corrected for up/down movements. This mode is ideal for panning (a method of taking pictures which involves turning the camera to track the movements of a subject which continues to move in a fixed direction).



Preventing camera shake

When the camera shake alert appears, use [Stabilizer], a tripod or the self-timer (P173).

- The shutter speed will be slower particularly in the following cases. Keep the camera still from the moment the shutter button is pressed until the picture appears on the screen.

We recommend using a tripod.

- Slow Sync.
- Slow Sync./Red-Eye Reduction
- [Clear Nightscape]/[Cool Night Sky]/[Warm Glowing Nightscape]/[Artistic Nightscape]/[Glittering Illuminations]/[Clear Night Portrait] (Scene Guide Mode)
- When you set to a slow shutter speed



- We recommend setting the O.I.S. switch to [OFF] when using a tripod.
 - We recommend taking pictures with the viewfinder when panning in [ⓘ].
 - The 5-axis Hybrid Image Stabilizer function automatically functions while recording motion pictures. This decreases image blurring when recording motion pictures while zooming or walking, etc.
 - The recorded angle of view may be reduced.
- (With camera models 18 194 / 18 195)**
- If you record a motion picture with [Rec Quality] set to [VGA/4M/30p], the stabilizer function may be less effective compared to other picture quality settings.
- (With camera models 18 193 / 18 196)**
- If you record a motion picture with [Rec Quality] set to [VGA/4M/25p], the stabilizer function may be less effective compared to other picture quality settings.
- The angle of view for the motion picture recording is reduced when you use the O.I.S. switch during the recording.
 - Try to hold the camera still when you press the shutter button.
 - The stabilizer function may not be able to fully compensate camera shake in the following cases:
 - When the camera is moved violently.
 - When the focal length is long.
 - In the digital zoom range.
 - When taking pictures while following a moving subject.
 - When the shutter speed gets slower while taking pictures indoors or in dark places.
 - The panning effect in [ⓘ] is more difficult to achieve in the following cases.
 - In brightly lit places such as in broad daylight on a summer's day.
 - When the shutter speed is faster than 1/100th of a second
 - When you move the camera too slowly because the subject is moving slowly. (The background will not become a blur.)
 - When the camera does not keep up with the subject satisfactorily.



- The [ⓘ]([Normal]) stabilizer is not available for [Panorama Shot] in Scene Guide Mode.
- The stabilizer is not available for [High Speed Video].
- **With camera models 18 194 / 18 195:**
The 5-axis Hybrid Image Stabilizer function is not available when recording a motion picture with [Rec Quality] set to [4K/100M/30p].
- **With camera models 18 193 / 18 196:**
The 5-axis Hybrid Image Stabilizer function is not available when recording a motion picture with [Rec Quality] set to [4K/100M/25p].

Using the Lens' Zoom Function

Available in the following modes: **A** **A*** **P** **A** **S** **M** **MM** **C1** **C2** **SCN** **COL**

You can determine how much of a subject is to be captured/how large a subject is to be rendered by selecting the appropriate focal length, i.e. by zooming.

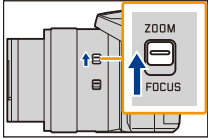
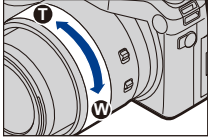
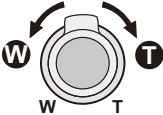
With the Zoom/MF ring	With the zoom lever
<p>1 Set the Zoom/MF ring selector switch to [ZOOM].</p>  <p>2 Rotate the Zoom/MF ring.</p>  <p>• Be careful not to accidentally switch the O.I.S. switch or Zoom/MF ring selector switch when rotating the Zoom/MF ring.</p>	<p>Rotate the zoom lever.</p>  <p>• The smaller the rotation angle is, the slower the zoom speed becomes; the greater the rotation angle is, the faster the zoom speed becomes.</p>
<p>T side: Enlarges subjects</p> <p>W side: Widens the angle of view</p>	

• The lens barrel will extend or retract depending on the focal length. Take care not to obstruct this movement when using the Zoom function.

Optical Zoom

This function allows extending the focal length beyond the lens' zoom limit without deteriorating the image quality.

Maximum magnification: 16×



This function is not available in the following cases:

- [Panorama Shot] (Scene Guide Mode)
- When recording with Zoom Macro

Extended Optical Zoom

This function works when any of the resolutions (P132) indicated with **EX** is selected. You can extend the focal length further than you can with the Optical Zoom without deteriorating the image quality.

Maximum magnification ratio: 32×
(This includes the optical zoom magnification. The magnification level differs depending on [Picture Size] setting.)



This function is not available in the following cases:

- [Toy Effect]/[Toy Pop] (Creative Control Mode)
- [Handheld Night Shot]/[Panorama Shot] (Scene Guide Mode)
- When [Burst Rate] in the [Rec] menu is set to [SH]
- When [HDR] is set to [ON]
- [Multi Exp.]
- When [iHandheld Night Shot] is set to [ON]
- When [iHDR] is set to [ON]
- When [Quality] is set to [RAW₁], [RAW₂] or [RAW]
- When recording with Zoom Macro
- When recording motion pictures

Intelligent Zoom

Available in the following modes: **A** **AF** **P** **A** **S** **M** **MEM** **C1** **C2** **SCN** **COL**

You can extend the focal length up to twice the original magnification ratio while minimizing the deterioration of the image quality.

MENU → **Rec** → [i.Zoom] → [ON]/[OFF]

MENU → **Motion Picture** → [i.Zoom] → [ON]/[OFF]



This function is not available in the following cases:

- [Impressive Art]/[Toy Effect]/[Toy Pop] (Creative Control Mode)
- [Handheld Night Shot]/[Panorama Shot] (Scene Guide Mode)
- When [Burst Rate] in the [Rec] menu is set to [SH]
- When [HDR] is set to [ON]
- [Multi Exp.]
- When [iHandheld Night Shot] is set to [ON]
- When [iHDR] is set to [ON]
- When [Quality] is set to [RAW₁], [RAW₂] or [RAW]

[Digital Zoom]

Available in the following modes: **P** **A** **S** **M** **C1** **C2** **SCN** **COL**

Although the image quality deteriorates when you extend the focal length even further, you can do so to achieve four times the original magnification ratio.

MENU → **[Rec]** → **[Digital Zoom]** → **[ON]/[OFF]**

MENU → **[Motion Picture]** → **[Digital Zoom]** → **[ON]/[OFF]**

- When using the [i.Zoom], the maximum magnification ratio of Digital Zoom is limited to 2×.
- When using Digital Zoom, we recommend using a tripod and the self-timer (P173) for taking pictures.
- In the Digital Zoom range, the AF area is displayed at the center in a larger size.





This function is not available in the following cases:

- [Impressive Art]/[Toy Effect]/[Toy Pop]/[Miniature Effect] (Creative Control Mode)
- [Handheld Night Shot]/[Panorama Shot] (Scene Guide Mode)
- [High Speed Video] (Creative Video Mode)
- When [Burst Rate] in the [Rec] menu is set to [SH]
- When [HDR] is set to [ON]
- [Multi Exp.]
- When [Quality] is set to [RAW], [RAW] or [RAW]

Changing the zoom setting

MENU → $\frac{1}{c}$ [Custom] → [Zoom Lever]

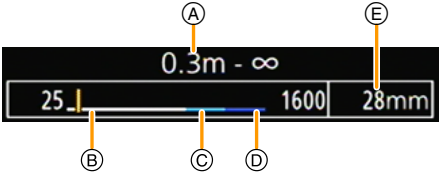
MENU → $\frac{1}{c}$ [Custom] → [Manual ring (Zoom)]

<p>Q (Seamless Zoom)</p>	<p>For normal zooming.</p> <ul style="list-style-type: none"> (A) Available focusing range (B) Optical Zoom range (C) Intelligent Zoom range (D) Digital Zoom range (E) Current focal length setting (35mm film camera equivalent) 
<p>Q (Step Zoom)</p>	<p>For stopping the zoom operation at preset focal lengths. • [Step Zoom] is disabled during motion picture recording.</p> <ul style="list-style-type: none"> (F) Available focusing range (G) Step zoom indication 
<p> (Exposure Compensation)</p>	<p>(This option is displayed only when [Zoom Lever] is selected.) Assigns the exposure compensation function to the zoom lever.</p>

Saving the zoom position when you turn off the camera

MENU → $\frac{1}{c}$ [Custom] → [Zoom Resume] → [ON]/[OFF]

Using the flash

Available in the following modes: **A** **A+** **P** **A** **S** **M** **C1** **C2** **SCN** **COL**

With the built-in flash you can take pictures in dark places or achieve a more even illumination, e.g. in the case of backlit subjects.

■ Opening/Closing the built-in flash unit

A To open the flash unit

Move the flash open slider in the direction indicated by the arrow.

B To close the flash unit

Push the flash down until it clicks into place.

- Forcibly closing the flash can damage the camera.
- Make sure to close the built-in flash when it is not in use.
- The flash setting is fixed to **[☺]** while the flash is closed.

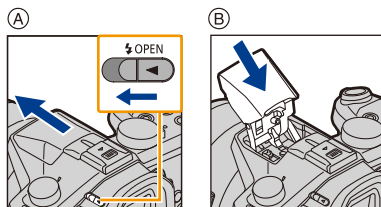

- **Be careful when opening the flash unit as it will pop up.**
- **Be careful not to pinch your fingers when you close the flash unit.**



Switch the flash off (**[☹]**)

When the flash is closed or pictures cannot be taken with the flash due to motion picture recording, etc., **[☹]** (flash off) is displayed on the recording screen and the flash will not fire.

- **Close the flash in places where its use is prohibited so that it will not fire.**

■ The available flash range (approximation)

When taking a close-up picture with flash, the picture's bottom section may be dark due to the light of the flash being partly obstructed by the lens barrel. Always regard the flash range limit.

	Wide	Tele
[AUTO] in [Sensitivity]	30cm (1') to 13.5m (44')	1m (3'3") to 9.5m (31')

- This is the range when [ISO Limit Set] (**P163**) is set to [OFF].





Using the flash skillfully

- When taking flash pictures, white saturation can occur if the subject is too close. If [Highlight] in the [Custom] menu is set to [ON], regions of white saturation will flash black and white when you play back or use Auto Review. In this case, we recommend that you adjust [Flash Adjust.] (P205) in the minus direction and take the pictures again.
 - When taking pictures with flash with the lens hood attached, the picture's bottom section may be dark due to the light of the flash being partly obstructed by the lens hood. This may also lead to faulty flash exposures. We recommend detaching the lens hood.
- Be sure to prevent that dust or sticky substances adhere to the flash unit. When this occurs, it may not pop up smoothly or at all.
 - Do not bring the flash unit too close to objects or close it while it is fired. The objects may be deformed or discolored by its heat or lighting.
 - Do not close the flash unit soon after it is fired prior to taking pictures due to ON/Red-Eye Reduction etc. It causes a malfunction.
 - It may take time to charge the flash if you repeatedly take pictures. You must wait a moment to take the next picture while the flash icon is flashing red indicating the flash is charging.
 - When you attach an external flash unit, it takes priority over the built-in one. Refer to P290 for external flash units.
 - In the following cases, the flash mode is fixed to [☹] (flash off).
 - When recording motion pictures
 - When using the electronic shutter
 - When [HDR] is set to [ON]
 - When [Silent Mode] is set to [ON]

Changing the Flash Modes

Available in the following modes: 





Set the built-in flash's mode to match the situation.

1 Select the menu.

MENU →  [Rec] → [Flash]



2 Press ▲/▼ to select [Flash Mode] and then [MENU/SET].

3 Press ▲/▼ to select the item and then [MENU/SET].

 ([Forced Flash On])	The flash is fired every time regardless of the recording conditions.
 ([Forced On/Red-Eye])*	<ul style="list-style-type: none"> • Use these modes when your subject is back-lit or under fluorescent light.
 ([Slow Sync.])	When taking pictures of dark subjects, this feature will slow the shutter speed when the flash is fired. Dark background landscape will appear brighter.
 ([Slow Sync./Red-Eye])*	
	<ul style="list-style-type: none"> • Use these modes when you take pictures of people in front of a dark background. • Using a slower speed can cause motion blur. Using a tripod can counteract this.

* It can be set only when [Firing Mode] in [Flash] is set to [TTL].

The flash is fired twice.

The interval between the first and second flash is longer when [] or [] is set. The subject should not move until the second flash is fired.

• The effect of Red-Eye Reduction differs between people. Also, if the subject was far away from the camera or was not looking at the first flash, the effect may not be evident.

■ Shutter speeds for each flash mode

Flash mode	Shutter speed
	1/60 ^{*1} to 1/4000s

Flash mode	Shutter speed
	1 to 1/16000s
	60 ^{*2} to 1/16000s

*1 This becomes 60 seconds in Shutter-Priority Mode and B (Bulb) in Manual Exposure Mode.

*2 This becomes B (Bulb) in Manual Exposure Mode.

- In the Snapshot (or) Modes, the shutter speed changes depending on the Scene Mode used.

■ Available flash modes according to the Recording mode

The available flash modes depend on the Recording mode.

(○: Available, —: Not available, ●: Initial setting of Scene Guide Mode)

Recording Mode						
A	Snapshot Mode	—*3	—*3	—*3	—*3	○
A+	Snapshot Plus Mode	—*3	—*3	—*3	—*3	○
P	Program Mode	○	○	○	○	○
A	Aperture-Priority Mode	○	○	○	○	○
S	Shutter-Priority Mode	○	○	—	—	○
M	Manual Exposure Mode	○	○	—	—	○
MV	Creative Video Mode	—	—	—	—	○
COL	Creative Control Mode	—	—	—	—	○

*3 Cannot be set using the [Rec] menu.

[i/A] is set when the flash unit is opened. (P77)



SCN Scene Guide Mode	[Clear Portrait]	○	●	—	—	○
	[Silky Skin]	○	●	—	—	○
	[Backlit Softness]	—	—	—	—	●
	[Clear in Backlight]	●	—	—	—	○
	[Relaxing Tone]	—	—	—	—	●
	[Sweet Child's Face]	○	●	—	—	○
	[Distinct Scenery]	—	—	—	—	●
	[Bright Blue Sky]	—	—	—	—	●
	[Romantic Sunset Glow]	—	—	—	—	●
	[Vivid Sunset Glow]	—	—	—	—	●
	[Glistening Water]	—	—	—	—	●
	[Clear Nightscape]	—	—	—	—	●
	[Cool Night Sky]	—	—	—	—	●
	[Warm Glowing Nightscape]	—	—	—	—	●
	[Artistic Nightscape]	—	—	—	—	●
	[Glittering Illuminations]	—	—	—	—	●
	[Handheld Night Shot]	—	—	—	—	●
	[Clear Night Portrait]	—	—	—	●	○
	[Soft Image of a Flower]	●	—	—	—	○
	[Appetizing Food]	●	—	—	—	○
	[Cute Dessert]	●	—	—	—	○
	[Freeze Animal Motion]	●	—	—	—	○
	[Clear Sports Shot]	●	—	—	—	○
	[Monochrome]	●	○	○	○	○
[Panorama Shot]	—	—	—	—	●	

- The flash mode may change if the Recording mode is changed. Set the flash mode again if necessary.
- When changing the Scene Mode using Scene Guide Mode, the Scene Guide Mode flash mode setting is returned to the default value with each change of scene mode.
- The flash will not be fired when recording a motion picture.

Setting 2nd Curtain Synchro

Available in the following modes: 



2nd curtain synchro fires the flash just before the shutter closes as opposed to the normal firing time (when the shutter opens). This can be utilized to create different effects (see below).



1 Select the menu.

MENU →  **[Rec]** → **[Flash]**

2 Press ▲/▼ to select **[Flash Synchro]** and then **[MENU/SET]**.

3 Press ▲/▼ to select the item and then **[MENU/SET]**.

[1ST]	1st curtain synchro The normal method when taking pictures with the flash.	
[2ND]	2nd curtain synchro The light source appears behind the subject, making the picture appear more logical.	

- Set to [1ST] for normal use.
- [2nd] is displayed in the flash icon on the screen if you set [Flash Synchro] to [2ND].
- The [Flash Synchro] settings also apply to an external flash unit. (P290)
- The faster the shutter speed, the less difference there will be between pictures taken with [1ST] and [2ND].
- You cannot set [] or [] when [Flash Synchro] is set to [2ND].

Flash exposure compensation

Available in the following modes: 

You can adjust the flash exposure to compensate for pictures in which the parts mainly illuminated by the flash would otherwise appear too dark or bright.

1 Select the menu.

MENU →  **[Rec]** → **[Flash]**

2 Press ▲/▼ to select **[Flash Adjust.]** and then **[MENU/SET]**.

3 Press ◀/▶ to set the flash output and then **[MENU/SET]**.

- You can set from [-3 EV] to [+3 EV] in steps of 1/3 EV.
- Select [± 0] to return to the original flash output.

- [+] or [-] is displayed on the flash icon in the screen when the flash level is adjusted.
- The **[Flash Adjust.]** setting also applies to an external flash unit. (P290)

Synchronizing the output of the built-in flash unit to the set Exposure Compensation

Available in the following modes: 

When **[Auto Exposure Comp.]** in **[Flash]** in the **[Rec]** menu is set to **[ON]**, the brightness of the built-in flash will automatically be set to the level appropriate to the selected Exposure Compensation.

- For details on Exposure Compensation, refer to P160.
- The **[Auto Exposure Comp.]** setting also applies to an external flash unit. (P290)

Changing the firing mode (Manual flash)

Available in the following modes: 

You can set a flash control mode at [Firing Mode] in [Flash].

[TTL]	The camera automatically controls the flash output.
[MANUAL]	For setting the flash output manually. In [TTL] you can take the picture you want even when shooting dark scenes that may otherwise be too brightly lit by the flash.



- When [MANUAL] is set, the output rate ([1/1], etc.) is displayed on the flash icon on the screen.

Setting the luminosity ratio (When [MANUAL] is selected)

- 1 Select [Flash] in the [Rec] menu. (P36)
- 2 Press $\blacktriangle/\blacktriangledown$ to select [Manual Flash Adjust.] and then [MENU/SET].
- 3 Press $\blacktriangleleft/\blacktriangleright$ to select an item and then [MENU/SET].
 - You can set from [1/1] (full output) to [1/128] in steps of [1/3].

Correcting red eyes

Available in the following modes: 

When Red-Eye Reduction ([, [) is selected, Red-Eye Removal is performed whenever the flash is used. The camera automatically detects red-eye and corrects the picture.

MENU →  [Rec] → [Red-Eye Removal]

Settings: [ON]/[OFF]

- [] is displayed on the icon when it is set to [ON].



Under certain circumstances, red-eye cannot be corrected.

Recording Motion Pictures

This camera records motion pictures in the MP4 format.
Audio is recorded in stereo.

Setting the resolution and frame rate

Available in the following modes: **[A]** **[A+]** **[P]** **[A]** **[S]** **[M]** **[C1]** **[C2]** **[SCN]** **[COL]**

1 Select the menu.

[MENU] → **[Motion Picture]** → **[Rec Quality]**

2 Press **▲/▼** to select the item and then **[MENU/SET]**.

- Exit the menu after it is set.

Item	Resolution	Frame rate	Bit rate
[4K/100M/30p] *1,2 [4K/100M/25p] *1,3	3840×2160	30p*2 25p*3	100 Mbps
[FHD/28M/60p] *2 [FHD/28M/50p] *3	1920×1080	60p*2 50p*3	28 Mbps
[FHD/20M/30p] *2 [FHD/20M/25p] *3	1920×1080	30p*2 25p*3	20 Mbps
[HD/10M/30p] *2 [HD/10M/25p] *3	1280×720		10 Mbps
[VGA/4M/30p] *2 [VGA/4M/25p] *3	640×480		4 Mbps

*1 These can be set only in Creative Video Mode.

*2 With camera models 18 194 / 18 195

*3 With camera models 18 193 / 18 196

■ **About the compatibility of the recorded motion pictures**

Even when a compatible device is used, recorded motion pictures may be played back with reduced picture and sound quality, or they may not be played back at all.

Also, recording information may not be displayed correctly. Use this camera to playback in such cases.

• **With camera models 18 194 / 18 195:**

For motion pictures recorded with [Rec Quality] set to [4K/100M/30p], refer to "Enjoying Motion Pictures in 4K" on [P274](#).

• **With camera models 18 193 / 18 196:**

For motion pictures recorded with [Rec Quality] set to [4K/100M/25p], refer to "Enjoying Motion Pictures in 4K" on [P274](#).

■ Indication of the icon

- (A) Format
- (B) Resolution
- (C) Frame rate (sensor output)

(With camera models 18 194 / 18 195)



(With camera models 18 193 / 18 196)



• What is bit rate

This is the volume of data for a defined period of time. The quality is higher when the number gets larger. This camera uses the “VBR” recording method. “VBR” is an abbreviation for “Variable Bit Rate”, and the bit rate (volume of data for defined period of time) is changed automatically depending on the subject to record. Therefore, the recording time is shortened when a subject with fast movement is recorded.

How to focus when recording a motion picture ([Continuous AF])

Available in the following modes:

The method for achieving focus varies depending on the focus mode (P140) and the [Continuous AF] setting in the [Motion Picture] menu.

Focus Mode	[Continuous AF]	Description of settings
[AFS]/[AFF]/[AFC]	[ON]	The camera automatically keeps focusing on subjects during recording. (P140)
	[OFF]	The camera maintains the focus position from the start of recording.
[MF]	[ON]/[OFF]	You can focus manually. (P151)

- When the focus mode is set to [AFS], [AFF] or [AFC], if you press the shutter button halfway while recording a motion picture, the camera will re-adjust the focus setting.
- Depending on the recording conditions, an operational sound may be recorded when Auto-focus is operated while recording a motion picture.
It is recommended to record with [Continuous AF] in the [Motion Picture] menu set to [OFF] to avoid recording the lens noise.
- When operating the zoom when recording motion pictures, refocusing may take time.

Recording Motion Pictures

Available in the following modes: **A** **AT** **P** **A** **S** **M** **MM** **C1** **C2** **SCN** **COL**

1 Start recording by pressing the motion picture button.

- (A) Elapsed recording time
- (B) Available recording time

- Recording of motion pictures appropriate for each mode is possible.
- The recording state indicator (red) (C) will flash while recording motion pictures.
- If approximately 1 minute elapses without an operation being performed, part of the display will disappear. Press [DISP] to make the display reappear. This operation is to prevent screen burn-in and is not a malfunction.
- When recording a motion picture, do not cover the microphone with your fingers or other objects.
- Release the motion picture button immediately after you press it.

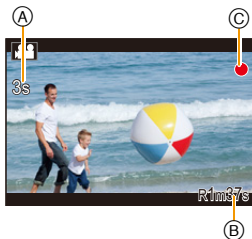
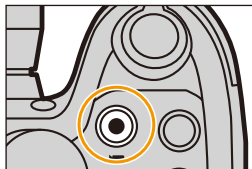

2 Stop the recording by pressing the motion picture button again.

- Still picture recording is also possible during the motion picture recording by fully pressing the shutter button. (P214)



About the operation sound that is produced when you stop recording

Since motion picture recording stops only after you press the motion picture button, the sound of the operation may be noticeable. If the sound bothers you, try the following:

- Cut off the last part of the motion picture using [Video Divide] (P234) in the [Playback] menu.

The motion picture can not be divided near the very end of it. To avoid this, record approximately 3 seconds longer.





Enabling/disabling the motion picture button

MENU → /c[Custom] → [Video Button] → [ON]/[OFF]

- This function is for preventing accidental operation of the button.

Switching between the angle of view for taking pictures and the one for recording motion pictures

MENU → /c[Custom] → [Rec Area] → [] (Picture)/[] (Motion picture)

- When the aspect ratio setting is different in still and motion pictures, the angle of view changes at the start of motion picture recording.
When [Rec Area] is set to [], the angle of view during motion picture recording is displayed.
- The recording area indicated is an approximation.



- When a motion picture is recorded in a high temperature environment or is recorded continuously, the recording may stop after [△] is displayed to protect the camera.
- If Extended Optical Zoom is used before pressing the motion picture button, the setting will be cleared, so the shooting range will change dramatically.
- Confirm the settings for the O.I.S. switch and the Zoom/MF ring selector switch before recording a motion picture. Be careful not to accidentally switch them during recording.
- The operational sound of the zoom or button operation may be recorded when it is operated during the recording of a motion picture.
- The zoom speed decreases during the recording of a motion picture.
- The available recording time displayed on the screen may not decrease regularly.
- Depending on the type of the card, the card access indication may appear for a while after recording motion pictures. This is not a malfunction.
- The [Sensitivity] will be set to [AUTO] (for motion pictures) when recording motion pictures. Also, the [ISO Limit Set] will not operate.
- Even if [Stabilizer] is set to [(●●●)], [(●●●)] will operate in motion picture recording.
- It is recommended to use a fully charged battery when recording motion pictures.
- The motion picture will be recorded in the following categories for certain Recording Modes. A motion picture recording matching each Recording Mode will be performed for the ones not listed below.

Selected Recording Mode	Recording Mode while recording motion picture
<ul style="list-style-type: none"> – Program Mode – Aperture-Priority Mode – Shutter-Priority Mode – Manual Exposure Mode 	Normal motion picture
– [Clear in Backlight] (Scene Guide Mode)	Portrait Mode
– [Clear Nightscape]/[Artistic Nightscape]/[Handheld Night Shot]/[Clear Night Portrait] (Scene Guide Mode)	Low Light Mode



Motion pictures cannot be recorded in the following cases:

- [Glistening Water]/[Glittering Illuminations]/[Soft Image of a Flower]/[Panorama Shot] (Scene Guide Mode)
- [Rough Monochrome]/[Silky Monochrome]/[Soft Focus]/[Star Filter]/[Sunshine] (Creative Control Mode)
- When using [Time Lapse Shot]
- When using [Stop Motion Animation]

Recording motion pictures in 4K

Available in the following modes: 

You can create extremely high-detail motion pictures in 4K by recording with the resolution set to [4K] in [Rec Quality].

- You can record motion pictures in 4K only in Creative Video Mode.
- The angle of view of motion pictures in 4K is narrower than those of motion pictures in other sizes.
- When recording motion pictures in 4K, use a card rated as UHS Speed Class 3. (P29)

To record motion pictures in 4K:

- 1 Set the mode dial to . (P61)
- 2 Set [Rec Quality] in the [Motion Picture] menu to [4K/100M/30p]^{*1}/[4K/100M/25p]^{*2}. (P207)
 - *1 With camera models 18 194 / 18 195
 - *2 With camera models 18 193 / 18 196

Recording still pictures while recording motion pictures

Available in the following modes: **A** **A+** **P** **A** **S** **M** **C1** **C2** **SCN** **COL**

Still pictures can be recorded even while recording a motion picture. (Simultaneous recording)

During motion picture recording, press the shutter button fully to record a still picture.

- The simultaneous recording indicator is displayed while recording still pictures.



■ Setting motion picture and still picture priorities

Available in the following modes: **A** **A+** **P** **A** **S** **M** **C1** **C2** **SCN** **COL**

The recording method for the still pictures taken while recording a motion picture can be set with [Picture Mode] in the [Motion Picture] menu.

<p>[S] (Motion picture priorities)</p>	<ul style="list-style-type: none"> • Pictures will be recorded with a resolution of [S] (2 M). The picture quality may be different to [S] (2 M) of standard pictures. • Only JPEG images are recorded when [Quality] is set to [RAW], [RAW+], or [RAW]. (When set to [RAW], still pictures will be recorded in [Quality] of [S].) • Up to 30 still pictures can be taken during recording of the motion picture. • In [Miniature Effect] of Creative Control Mode, there may be a slight delay between fully pressing the shutter button and recording.
<p>[M] (Still picture priorities)</p>	<ul style="list-style-type: none"> • Pictures will be recorded with the set resolution and quality. • The screen will go dark while recording pictures. A still picture will be recorded in the motion picture during that period, and audio is not recorded. • Up to 4 still pictures can be recorded during recording of the motion picture.



- The aspect ratio will be fixed to [16:9].



This function is not available in the following cases:

– When [Rec Quality] is set to [VGA/4M/30p]^{*1}/[VGA/4M/25p]^{*2}

*1 With camera models 18 194 / 18 195

*2 With camera models 18 193 / 18 196

Using the [Motion Picture] Menu

 For details on [Motion Picture] menu settings, refer to [P36](#).

- [Photo Style], [AFS/AFF], [Metering Mode], [Highlight Shadow], [i.Dynamic], [i.Resolution], [i.Zoom] and [Digital Zoom] are common to both the [Rec] menu and [Motion Picture] menu. Changing these settings in one of these menus is reflected in other menu.
- [Motion Picture] menu is not displayed in the following cases.
 - [Glistening Water]/[Glittering Illuminations]/[Soft Image of a Flower]/[Panorama Shot] (Scene Guide Mode)
 - [Rough Monochrome]/[Silky Monochrome]/[Soft Focus]/[Star Filter]/[Sunshine] (Creative Control Mode)

[Rec Quality]

- Refer to [P207](#) for details.

[Exposure Mode]

- Refer to [P118](#) for details.

[High Speed Video]

- Refer to [P119](#) for details.

[Picture Mode]

- Refer to [P214](#) for details.

[Continuous AF]

- Refer to [P209](#) for details.

[Level Shot]

Available in the following modes:   **P** **A** **S** **M**  **C1** **C2** **SCN** **COL**

The camera automatically detects its tilt and corrects the motion pictures you record to a level position to prevent them from being skewed.

Settings: **[ON]/[OFF]**

- If you record a motion picture while walking or if the tilt is too strong, the motion picture may not be corrected to a level position.
- If you set [Level Shot] to [ON], the angle of view will become smaller when you start recording a motion picture.
- Pictures you take during motion picture recording will not be corrected to a level position.



[Level Shot] does not work in the following cases:

- When recording with [High Speed Video]
- When the O.I.S. switch is set to [OFF]
- When [Rec Quality] is set to [4K/100M/30p]^{*1}/[4K/100M/25p]^{*2} or [VGA/4M/30p]^{*1}/[VGA/4M/25p]^{*2}

*1 With camera models 18 194 / 18 195



*2 With camera models 18 193 / 18 196

[Luminance Level]

Available in the following modes:   **P** **A** **S** **M**  **C1** **C2** **SCN** **COL**

For selecting the luminance range to match the use of video.

Settings:  / ]

- ] is suitable for normal motion picture recording.
- ] is suitable for creating still pictures from recorded motion pictures.

[Flkr Decrease]

Available in the following modes:   **P** **A** **S** **M**  **C1** **C2** **SCN** **COL**

The shutter speed can be fixed to reduce the flicker or striping in the motion picture.

Settings: **[1/50]/[1/60]/[1/100]/[1/120]/[OFF]**

[Mic Level Disp.]

Available in the following modes:           

For setting whether or not the mic levels are displayed on the recording screen.

Settings: [ON]/[OFF]

- When [Mic Level Limiter] is set to [OFF], [Mic Level Disp.] is fixed to [ON].



This function is not available in the following case:

- [Miniature Effect] (Creative Control Mode)
- This function is not available during High Speed Video recording.

[Mic Level Adj.]

Available in the following modes:           

For adjusting the sound input level to 19 different levels (– 12 dB ~ +6 dB).

- Displayed dB values are approximations.



This function is not available in the following case:

- [Miniature Effect] (Creative Control Mode)
- This function is not available during High Speed Video recording.

Adjusting the sound input level automatically ([Mic Level Limiter])

Available in the following modes:           

The camera adjusts the sound input level automatically, minimizing sound distortion (crackling noise) when the volume is too high.

Settings: [ON]/[OFF]



This function is not available in the following case:

- [Miniature Effect] (Creative Control Mode)
- This function is not available during High Speed Video recording.

[Wind Cut]

Available in the following modes: 

You can reduce the wind noise effectively when recording with sound.

Settings: [AUTO]/[HIGH]/[STANDARD]/[LOW]/[OFF]

- Setting [Wind Cut] may alter the usual sound quality.



- This function is not available in the following cases:
 - [Miniature Effect] (Creative Control Mode)
- When [Zoom Mic] is set to [ON].
- This function is not available during High Speed Video recording.

[Zoom Mic]

Available in the following modes: 

Coupled to the zoom operation, this function will clearly record far sounds with tele, and surrounding sounds with wide.

Settings: [ON]/[OFF]

- When set to [ON] and the focal length is changed, the operation sound may be recorded enhanced in accordance with the surrounding sounds. Also, the audio recording level will be lower compared to when [OFF].
- The stereo effect of the audio recording is reduced when the picture is enlarged.
- [Zoom Mic] does not work in the following cases:
 - [Miniature Effect] (Creative Control Mode)
 - [High Speed Video] (Creative Video Mode)

Playing Back Group Pictures

A picture group consists of multiple pictures. You can play back pictures in a group either continuously or one by one.

[▲🖼️]:

A picture group consisting of pictures taken in the Continuous Mode with the frame rate [SH]. (P168)

[▲📷]:

A picture group consisting of pictures taken in a Time Lapse Shot. (P174)

[▲🎞️]:

A picture group consisting of pictures taken in the Stop Motion Animation. (P178)

- You can edit or delete all pictures in a group at once.
(For example, if you delete a picture group, all pictures in the group are deleted.)

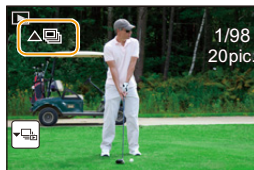

- Pictures will not be grouped if recorded without setting the clock.

Continuously playing back Group Pictures

Select a picture with the group picture icon ([▲🖼️], [▲📷], [▲🎞️]), and then press ▲.

- When playing back group pictures one at a time, the options are displayed.



[From the first picture]: Pictures are played back continuously from the first picture of the group.

[From the current picture]: Pictures are played back continuously from the picture being played back.

Operations during Group Pictures playback

▲	Continuous playback/Pause	▼	Stop
◀	Fast rewind	▶	Fast forward
	Rewind (while pausing)		Forward (while pausing)

Playing back each Group Pictures

1 Select a picture with the group display icon ([, [, []), and then press ▼.

2 Press ◀▶ to flip through images.

- Press ▼ again to return to the normal playback screen.
- Each picture in a group can be treated the same as normal pictures when they are played back. (Such as Multi Playback, Playback Zoom and deleting images)

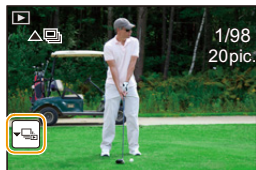

Creating Still Pictures from a Motion Picture

You can create a single still picture from a recorded motion picture.

1 Press **▲** to pause motion picture playback.

2 Press **[MENU/SET]**.

- A confirmation screen is displayed. The function is executed when **[Yes]** is selected.

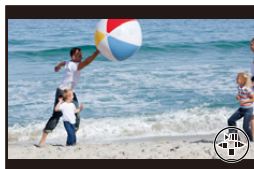

- Still pictures will be saved with **[Aspect Ratio]** set to **[16:9]** and **[Quality]** set to **[.1.1]**. The resolution will differ according to the motion picture you play back.
 - When the motion picture resolution is set to **[4K]** in **[Rec Quality]: [M]** (8 M)
 - When the motion picture resolution is set to **[FHD]**, **[HD]** in **[Rec Quality]: [S]** (2 M)
- Still pictures created from a motion picture may be coarser than with normal picture quality.
- **[.1.1]** is displayed during playback of still pictures created from motion pictures.
- To create still pictures from motion pictures when the camera is connected to a TV with the HDMI micro cable, set **[HDTV Link]** in **[TV Connection]** in the **[Setup]** menu to **[OFF]**.



• With camera models 18 194 / 18 195:

Still pictures cannot be created from motion pictures recorded in **[VGA/4M/30p]**.

• With camera models 18 193 / 18 196:

Still pictures cannot be created from motion pictures recorded in **[VGA/4M/25p]**.

Using the [Playback] Menu

With this menu, you can use various playback functions such as cropping and other editing of recorded images, protect settings, etc.

- With [RAW Processing], [Text Stamp], [Time Lapse Video], [Stop Motion Video], [Resize] or [Cropping], a new, edited picture is created. A new picture cannot be created if there is no free space on the card so we recommend checking that there is free space before editing the picture.
- The camera may not play back images recorded on other devices correctly, and the functions of the camera may not be available for such images.

[Slide Show]

You can play back the pictures you have taken in synchronization with music, and you can do this in sequence by determining a fixed interval between each of the pictures.

You can also put together a slide show composed of only still pictures, only motion pictures etc.

We recommend using this feature when you view your pictures by connecting the camera to a TV.

1 Select the menu.

MENU → **[Playback]** → **[Slide Show]**

2 Select the group to play back by pressing ▲/▼, and then press [MENU/SET].

- During [Category Selection], press ▲/▼/◀/▶ to select a category, and then [MENU/SET].
Refer to [P225](#) for category details.

3 Press ▲ to select [Start] and then [MENU/SET].

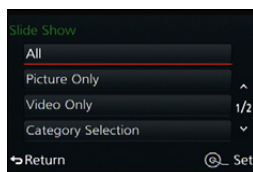

■ Operations during a slide show

▲	Play/Pause	▼	Exit slide show
◀	Back to previous picture	▶	Ahead to next picture
Rear dial (left)	Reduce volume level	Rear dial (right)	Increase volume level

- Normal playback resumes after the slide show finishes.

■ Changing the slide show settings

You can change the settings for slide show playback by selecting [Effect] or [Setup] on the slide show menu screen.

[Effect]

This allows you to select the screen effects when switching from one picture to the next.

[AUTO]/[NATURAL]/[SLOW]/[SWING]/[URBAN]/[OFF]

- When [URBAN] has been selected, the picture may appear in black and white as a screen effect.
- [AUTO] can be used only when [Category Selection] has been selected. The pictures are played back with the recommended effects in each category.
- [Effect] is fixed to [OFF] when in [Video Only] or during the slide show for [📺], [📺], [📺] in [Category Selection].
- Even if [Effect] is set, it does not work during a slide show of Group Pictures.
- When pictures are displayed on a TV connected via HDMI micro cable or when vertically-displayed pictures are played back, some of the [Effect] settings will not work.

[Setup]

[Duration] or [Repeat] can be set.

[Duration]	[5SEC]/[3SEC]/[2SEC]/[1SEC]
[Repeat]	[ON]/[OFF]
[Sound]	[AUTO]: Music is played when the still pictures are played back, and audio is played when the motion pictures are played back.
	[Music]: Music is played back.
	[Audio]: Audio (only for motion pictures) is played back.
	[OFF]: There will be no sound.

- [Duration] can be set only when [OFF] has been selected as the [Effect] setting.
- When playing back the following pictures, the [Duration] setting is disabled.
 - Motion pictures
 - Panorama pictures
 - Group Pictures

[Playback Mode]

Playback in [Normal Play], [Picture Only], [Video Only], [Category Play] or [Favorite Play] can be selected.

1 Select the menu.

MENU → **[Playback]** → **[Playback Mode]**

2 Select the group to play back by pressing ▲/▼, and then [MENU/SET].

When [Category Play] is selected in above step 2

3 Press ▲/▼/◀/▶ to select the category and then press [MENU/SET] to set.

- Pictures are sorted into the categories shown below.

	– [Face Recog.]*
	– [i-Portrait], [i-Night Portrait], [i-Baby] in Scene Detection – [Clear Portrait]/[Silky Skin]/[Backlit Softness]/[Clear in Backlight]/[Relaxing Tone]/[Sweet Child's Face]/[Clear Night Portrait] (Scene Guide Mode)
	– [i-Scenery], [i-Sunset] in Scene Detection – [Distinct Scenery]/[Bright Blue Sky]/[Romantic Sunset Glow]/[Vivid Sunset Glow]/[Glistening Water] (Scene Guide Mode)
	– [i-Night Portrait], [i-Night Scenery], [iHandheld Night Shot] in Scene Detection – [Clear Nightscape]/[Cool Night Sky]/[Warm Glowing Nightscape]/[Artistic Nightscape]/[Glittering Illuminations]/[Handheld Night Shot]/[Clear Night Portrait] (Scene Guide Mode)
	– [Clear Sports Shot] (Scene Guide Mode)
	– [i-Food] in Scene Detection – [Appetizing Food]/[Cute Dessert] (Scene Guide Mode)
	– [Travel Date]
	– Still pictures recorded continuously with continuous shooting speed set to [SH]
	– [Time Lapse Shot]/[Time Lapse Video]
	– [Stop Motion Animation]/[Stop Motion Video]

* Press ▲/▼/◀/▶ to select the person to play back and then [MENU/SET].

As for group pictures, the entire group is treated as a single picture with Face Recognition information.

- Categorization of the motion pictures differ from the still pictures depending on the Recording Mode. Some motion pictures may not be played back.

[Location Logging]

You can write location information sent from a smartphone (latitude and longitude) on images.

You can send location information and write it on images using a smartphone.

(P259)

Preparation:

Sending location information to the camera from the smartphone.

- You need to install "Leica Image Shuttle" on your smartphone. (P250)
- Read the [Help] in the "Image Shuttle" menu for further details on how to operate.

1 Select the menu.

MENU →  **[Playback]** → **[Location Logging]** → **[Add Location Data]**

2 Press ▲/▼ to select the period you intend to record location information on images, and then [MENU/SET].

- A confirmation screen is displayed. the function is executed when [Yes] is selected.
- Images with location information are indicated with [GPS].

■ To pause the recording of location information

Press [MENU/SET] while recording of the location information onto images is taking place.

- During a suspended period, [O] is displayed.
- Select the period with [O] to restart the recording process from the picture you left off.

■ To delete the received location information

1 Select the menu.

MENU →  **[Playback]** → **[Location Logging]** → **[Delete Location Data]**

2 Press ▲/▼ to select the period you want to delete, and then [MENU/SET].

- A confirmation screen is displayed. It is executed when [Yes] is selected.

- Location information can be written only to images taken on this camera.



- Location information will not be written on pictures taken after the location information had been sent (P259).
- When there is insufficient free space on the card, location information might not be able to be written.
- Location information cannot be written on images that were recorded when the clock was not set.

[RAW Processing]

You can process the pictures taken in RAW format. The processed pictures will be saved in JPEG format. You can check how effects are applied to each picture while processing it.

1 Select the menu.

MENU → **[Playback]** → **[RAW Processing]**

2 Select RAW images with ◀/▶, and then press [MENU/SET].

3 Press ▲/▼ to select an item.

- You can set the following items. The settings you used for the recording are selected when you start setting these items.



[White Balance]	Allows you to select a White Balance preset and adjust it. If you select an item with [OK], you can process the image with the setting at the time of recording.
[Exposure Comp.]	Allows you to correct the exposure within a range of -1 EV to +1 EV.
[Photo Style]	Allows you to select a photostyle effect ([Standard]/[Vivid]/[Natural]/[Monochrome]/[Scenery]/[Portrait]).
[i.Dynamic]	Allows you to select an [i.Dynamic] setting ([HIGH]/[STANDARD]/[LOW]/[OFF]).
[Contrast]	Allows you to adjust the contrast.
[Highlight]	Allows you to adjust the brightness of bright sections.
[Shadow]	Allows you to adjust the brightness of dark sections.
[Saturation]/[Color Tone]	Allows you to adjust the saturation. (When [Monochrome] is selected in [Photo Style], you can adjust the color tone.)
[Filter Effect]	Allows you to select a filter effect. (Only when [Monochrome] in [Photo Style] is selected)
[Noise Reduction]	Allows you to adjust the noise reduction setting.
[i.Resolution]	Allows you to select an [i.Resolution] setting ([HIGH]/[STANDARD]/[LOW]/[EXTENDED]/[OFF]).
[Sharpness]	Allows you to adjust the resolution effect.
[Setup]	<p>You can set the following items:</p> <p>[Reinstate Adjustments]: Returns the settings to the ones you used during the recording.</p> <p>[Color Space]: Allows you to select a [Color Space] setting from [sRGB] or [Adobe RGB].</p> <p>[Picture Size]: Allows you to select the size in which the image will be saved in JPEG format ([L]/[M]/[S]).</p>



4 Press [MENU/SET] and set.

- The setting method differs according to the item. For details, refer to “How to set each item” on P228.

5 Press [MENU/SET].

- This operation returns you to the screen in step 3. To set other items, repeat steps 3 through 5.

6 Select [Begin Processing] with ▲/▼, and then press [MENU/SET].

- A confirmation screen will be displayed. Selecting [Yes] will execute the operation. After the operation, exit the menu.

■ How to set each item

When you select an item, the setting screen will be displayed.

Button operation	Description of operation
	Selects a setting.
▲	Displays the screen that lets you set the color temperature. (P128) (only when [White Balance] is set to [K])
▼	Displays the screen that lets you fine-adjust the White Balance. (P129) (only when [White Balance] is set)
[DISP]	Displays the comparison screen.
[MENU/SET]	Sets the adjusted level and returns you to the item selection screen.

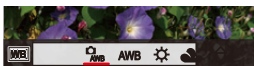

- When [Noise Reduction], [i.Resolution] or [Sharpness] is selected, the comparison screen cannot be displayed.
- You can enlarge the picture with the zoom lever.



On the comparison screen, you can use the following operations to make adjustments:

(A) Current setting

Button operation	Description of operation
	Selects a setting.
[DISP]	Returns you to the setting screen.
[MENU/SET]	Sets the adjusted level and returns you to the item selection screen.

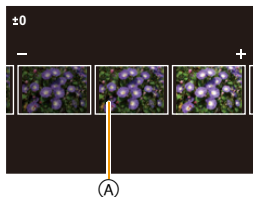

[Setup] setting

When you select an item, the screen that asks you to select [Reinstate Adjustments], [Color Space], or [Picture Size] will be displayed.

- 1 Press ▲/▼ to select an item, and then [MENU/SET].
 - If you select [Reinstate Adjustments], a confirmation screen will be displayed. Selecting [Yes] will execute the operation and return you to the item selection screen.
- 2 Press ▲/▼ to select a setting, and then [MENU/SET].

- The range within which you can correct the exposure differs from the one you can correct during recording.
- The [White Balance] setting of pictures taken with multiple exposures is fixed to the setting at the time of recording.
- If you perform [RAW Processing] in the [Playback] menu on a picture taken with [Red-Eye Removal], the effect will be applied to the processed picture in JPEG format.
- You can process only one RAW image at a time.



- When an AV or an HDMI micro cable is connected, [RAW Processing] is not available.
- You can process only the RAW images you recorded with the camera. [RAW Processing] is not available for images recorded with other models and images that are not stored in RAW format.

[Title Edit]

You can add text (comments) to pictures. After text has been registered, it can be stamped in prints using [Text Stamp] (P231).



1 Select the menu.

MENU →  **[Playback]** → **[Title Edit]** → **[Single]/[Multi]**





2 Select an image to add text.

-  is displayed for pictures with titles already registered.

[Single] setting

- 1 Press /  to select the picture.
- 2 Press [MENU/SET].

**[Multi] setting**

- 1 Press / / /  to select the picture and then [MENU/SET] (repeat).
 - The setting is canceled when [MENU/SET] is pressed again.
- 2 Press  to select [OK], and then [MENU/SET] to execute.

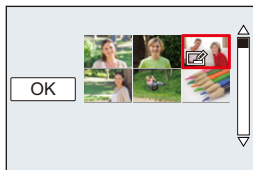
**3 Enter the text. (P54)**

- Exit the menu after it is set.

- To delete the title, erase all the text in the text input screen.
- You can set up to 100 pictures at one time with [Multi].



- You cannot use [Title Edit] for the following pictures.
 - Motion pictures
 - Pictures taken with [RAW_{16:9}], [RAW_{4:3}] or [RAW]

[Text Stamp]

You can stamp the recording date/time, name, location, travel date or title onto the recorded pictures.



1 Select the menu.

[MENU] →  **[Playback]** → **[Text Stamp]** → **[Single]/[Multi]**





2 Select an image you wish to stamp with text.



-  appears on screen if the picture is stamped with text.

[Single] setting

- 1 Press /  to select the picture.
- 2 Press [MENU/SET].

**[Multi] setting**

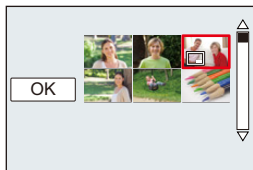
- 1 Press / / /  to select the picture and then [MENU/SET] (repeat).
 - The setting is canceled when [MENU/SET] is pressed again.
- 2 Press  to select [OK], and then [MENU/SET] to execute.

**3 Press /  to select [Set], and then [MENU/SET].**

4 Press ▲/▼ to select text stamp items, and then [MENU/SET].

5 Press ▲/▼ to select the settings, and then [MENU/SET].

[Shooting Date]	[W/O TIME]: [WITH TIME]: [OFF]	Stamps the year, month and date. Stamps the year, month, day, hour and minutes.
[Name]	[👤]: ([Face Recognition]) [👶/🐶]: ([Baby/Pet]) [OFF]	Names registered in [Face Recog.] will be stamped. Names registered in [Profile Setup] will be stamped.
[Location]	[ON]: [OFF]	Stamps the travel destination name set under [Location].
[Travel Date]	[ON]: [OFF]	Stamps the travel date set under [Travel Date].
[Title]	[ON]: [OFF]	Title input in the [Title Edit] will be stamped.

6 Press [↵/⏪].

7 Press ▲ to select [OK], and then [MENU/SET].

- A confirmation screen is displayed. The function is executed when [Yes] is selected. Exit the menu after it is executed.



- When you print pictures stamped with text, the date will be printed over the stamped text if you specify printing of the date at the photo shop or on the printer.
- You can set up to 100 pictures at one time in [Multi].
- The picture quality may deteriorate when text stamping is carried out.
- Depending on the printer being used, some characters may be cut at printing. Check before printing.
- When you stamp pictures in a group, the stamped ones are saved separately from the original ones in the group.



You cannot use [Text Stamp] for the following pictures.

- Motion pictures
- Pictures taken with [Panorama Shot] in Scene Guide Mode
- Pictures recorded without setting the clock and title
- Pictures that were previously stamped with [Text Stamp]
- Pictures taken with [RAW₁], [RAW₂] or [RAW]

[Video Divide]

Recorded motion pictures can be divided in two. This is recommended for when you want to separate a part you need from one you do not need.

Dividing a motion picture is permanent. Decide before you divide!

1 Select the menu.

MENU → **[Playback]** → **[Video Divide]**

2 Press ◀/▶ to select the motion picture to divide, and then [MENU/SET].

3 Press ▲ at the location to divide.

- The motion picture is played back from the same location when ▲ is pressed again.
- You can finely adjust the location for division by pressing ◀/▶ while the motion picture is paused.

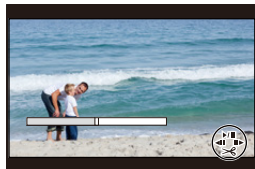

4 Press ▼.

- A confirmation screen is displayed. It is executed when [Yes] is selected. Exit the menu after it is executed.
- A motion picture may be lost if the card or battery is removed while processing the dividing.



- Avoid trying to divide motion picture near the very beginning or end of the motion picture.
- You cannot use [Video Divide] for the following pictures.
 - Motion pictures with a short recording time

[Time Lapse Video]

This function allows you to create a motion picture from a picture group recorded with [Time Lapse Shot].

1 Select the menu.

MENU →  **[Playback]** → **[Time Lapse Video]**

2 Select the [Time Lapse Shot] picture group with , and then press **[MENU/SET]**.

3 Create a motion picture by selecting the methods for creating it.

- The steps are the same as those for creating a motion picture following the recording of [Time Lapse Video].
Refer to step **9** onwards on [P176](#) for details.
Also refer to the notes on [P177](#) for created motion pictures.

[Stop Motion Video]

A motion picture is created from group pictures taken with [Stop Motion Animation].

1 Select the menu.

MENU →  **[Playback]** → **[Stop Motion Video]**

2 Select the Stop Motion Animation group with , and then press **[MENU/SET]**.

3 Create a motion picture by selecting the methods for creating it.

- The steps are the same as those for creating a motion picture following the recording of [Stop Motion Animation].
Refer to step **11** onwards on [P180](#) for details.
Also refer to the notes on [P181](#) for created motion pictures.

[Resize]

To allow easy posting to web pages, attachment to e-mail etc., the resolution (number of pixels) is reduced.

1 Select the menu.

[MENU] → **[Playback]** → **[Resize]** → **[Single]/[Multi]**

2 Select the picture and the resolution.**[Single] setting**

- ❶ Press **◀/▶** to select the picture, and then **[MENU/SET]**.
- ❷ Press **▲/▼** to select the size, and then **[MENU/SET]**.
 - A confirmation screen is displayed. The function is executed when **[Yes]** is selected. Exit the menu after it is executed.

**[Multi] setting**

- ❶ Press **▲/▼** to select the size, and then **[MENU/SET]**.
- ❷ Press **▲/▼/◀/▶** to select the picture, and then **[MENU/SET]** to set (repeat).
 - The setting is canceled when **[MENU/SET]** is pressed again.
- ❸ Press **◀** to select **[OK]**, and then **[MENU/SET]** to execute.
 - A confirmation screen is displayed. The function is executed when **[Yes]** is selected. Exit the menu after it is executed.

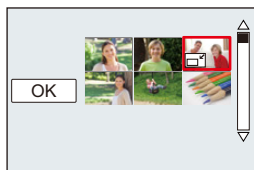

- You can set up to 100 pictures at one time in **[Multi]**.
- The picture quality of the resized picture will deteriorate.



This function is not available in the following cases:

- Motion pictures
- Pictures taken with **[Panorama Shot]** in Scene Guide Mode
- Group Pictures
- Pictures stamped with **[Text Stamp]**
- Pictures taken with **[RAW₁]**, **[RAW₂]** or **[RAW]**

[Cropping]

You can cut out the important part of the recorded picture.

1 Select the menu.

MENU → **[Playback]** → **[Cropping]**

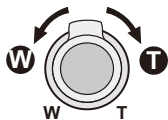
2 Press ◀/▶ to select the picture, and then [MENU/SET].**3 Use the zoom lever and press ▲/▼/◀/▶ to select the parts to be cropped.**

Zoom lever (W): Reduction

Zoom lever (T): Enlargement

▲/▼/◀/▶: Move

4 Press [MENU/SET].

- A confirmation screen is displayed. The function is executed when [Yes] is selected. Exit the menu after it is executed.

- The picture quality of the cropped picture will deteriorate.
- Crop one picture at a time when you want to crop the pictures in a picture group. (You cannot edit all pictures in a group at once.)
- When you crop pictures in a group, the cropped ones are saved separately from the original ones in the group.
- Information regarding the Face Recognition in the original picture will not be copied to images having undergone [Cropping].



This function is not available in the following cases:

- Motion pictures
- Pictures taken with [Panorama Shot] in Scene Guide Mode
- Pictures stamped with [Text Stamp]
- Pictures taken with [RAW_{Hi}], [RAW_{Lo}] or [RAW]

[Rotate]/[Rotate Disp.]

This mode allows you to automatically display pictures vertically if they were recorded holding the camera vertically, or to rotate pictures manually in 90° steps.

[Rotate] (The picture is rotated manually)

- The [Rotate] function is disabled when [Rotate Disp.] is set to [OFF].

1 Select the menu.

MENU →  **[Playback]** → **[Rotate]**

2 Press ◀/▶ to select the picture and then [MENU/SET].

- The [Rotate] function is disabled for Group Pictures.

3 Press ▲/▼ to select the direction to rotate the picture and then [MENU/SET].

The picture rotates clockwise in steps of 90°.



The picture rotates counter-clockwise in steps of 90°.

- Exit the menu after it is set.

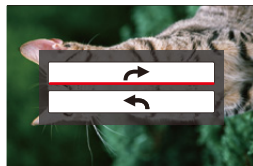
**[Rotate Disp.] (The picture is automatically rotated and displayed)****Select the menu.**

MENU →  **[Playback]** → **[Rotate Disp.]** → **[ON]**

- The pictures are displayed without being rotated when you select [OFF].
- Exit the menu after it is set.



- When you play back pictures on a computer, they cannot be displayed in the rotated direction unless the OS or software is compatible with Exif.
[Exif is a file format for still pictures which allows recording information etc. to be added. It was established by "JEITA (Japan Electronics and Information Technology Industries Association)."]
- [Rotate Disp.] may not work on a screen that plays back multiple pictures, such as the one displayed after [Delete Multi] is selected.

[Favorite]

You can do the following if a mark has been added to pictures and they have been set as favorites.

- Play back only the pictures set as favorites as a slide show.
- Play back only the pictures set as favorites. ([Favorite Play])
- Delete all the pictures not set as favorites. ([All Delete Except Favorite])

1 Select the menu.





MENU →  **[Playback]** → **[Favorite]** → **[Single]/[Multi]**

2 Select the picture.**[Single] setting**

Press / to select the picture, and then [MENU/SET].

- The setting is canceled when [MENU/SET] is pressed again.
- Exit the menu after it is set.

**[Multi] setting**

Press /// to select the picture, and then [MENU/SET] to set (repeat).

- The setting is canceled when [MENU/SET] is pressed again.
- Exit the menu after it is set.

**■ Canceling all the [Favorite] settings**

Select the menu.

MENU →  **[Playback]** → **[Favorite]** → **[Cancel]**

- A confirmation screen is displayed. The function is executed when [Yes] is selected. Exit the menu after it is executed.
- In [Playback Mode], the [Cancel] is disabled.

- You can set up to 999 pictures as favorites.
- When you set pictures in a group as [Favorite], the number of your [Favorite] pictures is displayed on the [Favorite] icon of the group's top picture.



This function is not available in the following case:

- Pictures taken with [RAW]

[Print Set]

DPOF "Digital Print Order Format" is a system that allows the user to select which pictures to print, how many copies of each picture to print and whether or not to print the recording date on the pictures when using a DPOF compatible photo printer or photo printing store. For details, ask at your photo printing store.

When you set [Print Set] for a group pictures, the print setting for the number of prints will be applied to every picture in the group.

1 Select the menu.

MENU → **[Playback]** → **[Print Set]** → **[Single]/[Multi]**

2 Select the picture.**[Single] setting**

Press ◀/▶ to select the picture, and then [MENU/SET].

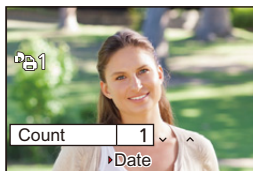
**[Multi] setting**

Press ▲/▼/◀/▶ to select the picture and then [MENU/SET].

**3 Press ▲/▼ to set the number of prints, and then [MENU/SET] to set.**

- When [Multi] has been selected
 - Repeat steps **2** and **3** for each picture.
 - (It is not possible to use the same setting for a multiple number of pictures.)
- [999+] is displayed on the screen, if the total number of prints you set for a group pictures is more than 1000 pictures.
- Exit the menu after it is set.

■ Canceling all the [Print Set] settings

Select the menu.

MENU →  **[Playback]** → **[Print Set]** → **[Cancel]**

- A confirmation screen is displayed. The function is executed when [Yes] is selected. Exit the menu after it is executed.

■ To print the date

After setting the number of prints, set/cancel printing with the recording date by pressing .

- Depending on the photo printing store or the printer, the date may not be printed even if you set to print the date. For further information, ask at your photo printing store or refer to the instructions for the printer.
- The date print feature is disabled for pictures that are stamped with text.

- The number of prints can be set from 0 to 999.
- Depending on the printer, the date print settings of the printer may take precedence so check if this is the case.
- It may not be possible to use the print settings with other equipment. In this case, cancel all the settings, and reset the settings.
- When you set pictures in a group to [Print Set], the number of pictures added to [Print Set] and the total number of pictures to be printed are displayed on the [Print Set] icon of the group's top picture.



This function is not available in the following cases:

- Motion pictures
- Pictures taken with [RAW]
- File that does not comply with the DCF standard

[Protect]

You can set protection for pictures you do not want to delete by mistake.

1 Select the menu.

MENU →  **[Playback]** → **[Protect]** → **[Single]/[Multi]**

2 Select the picture.**[Single] setting**

Press ◀/▶ to select the picture, and then [MENU/SET].

- The setting is canceled when [MENU/SET] is pressed again.
- Exit the menu after it is set.

**[Multi] setting**

Press ▲/▼/◀/▶ to select the pictures and then [MENU/SET] (repeat).

- The setting is canceled when [MENU/SET] is pressed again.
- Exit the menu after it is set.

**■ Canceling all the [Protect] settings**

Select the menu.

MENU →  **[Playback]** → **[Protect]** → **[Cancel]**

- A confirmation screen is displayed. The function is executed when [Yes] is selected. Exit the menu after it is executed.



- Even if you do not protect pictures on a card, they cannot be deleted when the card's Write-Protect slider is set to [LOCK].

- The [Protect] feature is only designed to work with this camera.
- Even if you protect pictures on a card, they will be deleted if the card is formatted.
- When you set pictures in a group to [Protect], the number of pictures with the [Protect] setting is displayed on the [Protect] icon of the group's top picture.

[Face Rec Edit]

You can clear and replace all information relating to face recognition in selected images.

1 Select the menu.

[MENU] → **[Playback]** → **[Face Rec Edit]** → **[REPLACE]/[DELETE]**

2 Press ◀/▶ to select the picture and then [MENU/SET].**3 Press ◀/▶ to select the person and then [MENU/SET].****4 (When [REPLACE] is selected)**

Press ▲/▼/◀/▶ to select the person to replace and then [MENU/SET].

- A confirmation screen is displayed. The function is executed when [Yes] is selected. Exit the menu after it is executed.

- Cleared information regarding the [Face Recog.] cannot be restored.
- When all Face Recognition information in a picture has been canceled, the picture will not be categorized using Face Recognition in [Category Play].
- The Face Recognition information of pictures in a group is edited together. (You cannot edit one picture at a time.)
- Editing of group pictures can be performed only on the first picture of each set.

[Picture Sort]

You can set the order in which the camera displays images during playback.

1 Select the menu.

[MENU] → **[Playback]** → **[Picture Sort]**

2 Press ▲/▼ to select an item and then [MENU/SET].

[FILE NAME]	Displays images by folder name/file name. This display format allows you to locate images in the card easily.
[DATE/TIME]	Displays images by recording date. If the card contains pictures taken with more than one camera, this display format is convenient for looking for images.

- Exit the menu after it is set.

- When you insert another card, images may not be displayed by [DATE/TIME] first. The images will be displayed by [DATE/TIME] if you wait for a while.

[Delete Confirmation]

This sets which option, [Yes] or [No], will be highlighted first when the confirmation screen for deleting a picture is displayed.

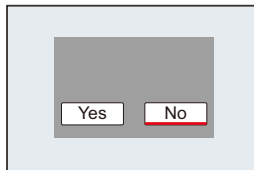
**1 Select the menu.**

[MENU] → **[Playback]** → **[Delete Confirmation]**

2 Press ▲/▼ to select an item and then [MENU/SET].

["Yes" first]	[Yes] is highlighted first, so deletion can be done quickly.
["No" first]	[No] is highlighted first. Accidental deletion of pictures is avoided.

- Exit the menu after it is set.

Wi-Fi[®] function/NFC function

■ Using the camera as a wireless LAN device

When using equipment or computer systems that require more reliable security than wireless LAN devices, ensure that the appropriate measures are taken for safety designs and defects for the systems used. Leica Camera AG will not take any responsibility for any damage that arises when using the camera for any purpose other than as a wireless LAN device.

■ Use of the Wi-Fi function of this camera is presumed to be in countries where this camera is sold

There is the risk that the camera violates the radio transmission regulations if used in countries other than those where this camera is sold, and Leica Camera AG takes no responsibility for any violations.

■ There is the risk that data sent and received via radio transmission may be intercepted

Please note that there is the risk that data sent and received via radio transmission may be intercepted by a third party.

■ Do not use the camera in areas with magnetic fields, static electricity or interference

- Do not use the camera in areas with magnetic fields, static electricity or interference, such as near microwave ovens. These may cause the interruption of the radio transmission.
- Using the camera near devices such as microwave ovens or cordless telephones that use the 2.4 GHz radio wave band may cause a decrease in performance in both devices.

■ Do not connect to wireless networks you are not authorized to use

When the camera utilizes its Wi-Fi function, wireless networks will be searched automatically. When this happens, wireless networks that you are not authorized to use (SSID*) may be displayed, however do not attempt to connect to such networks as it may be considered as unauthorized access.

- * SSID refers to the name that is used to identify a network over a wireless LAN connection. If the SSID matches for both devices, transmission is possible.

■ Before Use

- To use the Wi-Fi function on this camera, a wireless access point or a destination device equipped with the wireless LAN function is required.

■ This camera is compatible with NFC

Using the NFC “Near Field Communication” function, you can easily transfer data necessary for a Wi-Fi connection between this camera and the smartphone.



Compatible models

This function can be used with the NFC compatible device with Android (OS version 2.3.3 or higher). (excluding some models)

- For information on the operation and settings of NFC-compatible smartphones, refer to the operating instructions of your device.

■ About the Wi-Fi connection lamp

Lit blue: The Wi-Fi connection is on standby

Flashing blue: Sending/receiving data through the Wi-Fi connection



■ About the [WIFI] button

[WIFI]/[FN2] button can be used in two ways, as [Wi-Fi] or as [Fn2] (function 2).

At the time of purchase, it is initially set to [Wi-Fi].

- Refer to [P43](#) for details about the function button.

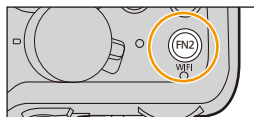

Pressing and holding [WIFI] before connecting to Wi-Fi (When connecting to a smartphone)

- The information required for connecting the smartphone to the camera (QR code, SSID and password) is displayed. ([P251](#))

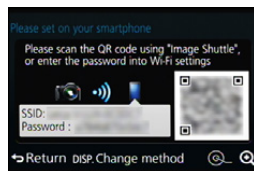

Pressing [WIFI] before connecting to Wi-Fi

- Following items can be selected.

[New Connection]

[Select a destination from History] ([P268](#))

[Select a destination from Favorite] ([P268](#))

- These instructions describe the procedure for [New Connection].



What you can do with the [WIFI] button when connected to Wi-Fi

- Following items can be selected.

[Terminate the Connection]	Terminates the Wi-Fi connection.
[Change the Destination]	Terminates the Wi-Fi connection, and allows you to select a different Wi-Fi connection.
[Change Settings for Sending Images]	Refer to P271 for details.
[Register the Current Destination to Favorite]	Registers the current connection destination or the connection method, so you can easily connect with the same connection method next time.
[Network Address]	Displays the MAC address and IP address of the camera.

■ Describing method

When you see a step that says, “Select [Select a destination from History].” or a similar step, press the cursor buttons to select [Select a destination from History], and press [MENU/SET].

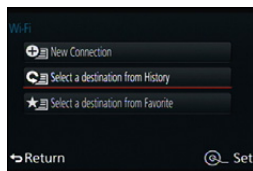

- The camera cannot be used to connect to a public wireless LAN connection.
- Use a IEEE802.11b, IEEE802.11g or IEEE802.11n compatible device when using a wireless access point.
- We strongly recommend that you set an encryption to maintain information security.
- It is recommended to use a fully charged battery when sending images.
- When the battery indicator is flashing red, the connection with other equipment may not start or the connection may be disrupted.
(A message such as [Communication error] is displayed.)
- When sending images on a mobile network, high packet communication fees may be incurred depending on the details of your contract.
- Pictures may not be completely sent depending on radio transmission conditions. If the connection is terminated while sending pictures, pictures with missing sections may be sent.
- **Do not remove the memory card or battery or move to an area without any reception while sending images.**
- The monitor display may become distorted for an instant while connected to the service, however this will not affect the image being sent.

What you can do with the Wi-Fi function

Controlling with a Smartphone/Tablet

Recording with a smartphone.

Playing back images in the camera

Saving images stored in the camera.

Sending images to an SNS.

Writing location information on images stored in the camera



 **Easy connection, easy transfer**

You can use easily by pressing and holding [WIFI] or by using the NFC function.

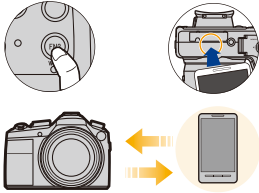

The diagram illustrates two methods for connecting the camera to a smartphone. The top row shows two circular inset images: the left one shows a hand pressing a button on the camera's top panel, and the right one shows a camera with a blue Wi-Fi signal icon above it. The bottom row shows a full view of the camera on the left and a smartphone on the right, connected by two yellow double-headed arrows, indicating bidirectional communication.

P250

These instructions refers to both smartphones and tablets as “smartphones” from this point on unless noted otherwise.

Controlling with a Smartphone/Tablet

You can remotely operate the camera using a smartphone.

You need to install “Leica Image Shuttle” (referred to as “Image Shuttle” from this point on) on your smartphone.



Installing the smartphone/tablet app “Image Shuttle”

The “Image Shuttle” is an application provided by Leica Camera AG.

App for Android™: Android 2.3.3 or higher*

App for iOS: iOS 6.0 or higher
(iPhone 3GS is not supported)

* Connecting to the camera with [Wi-Fi Direct] requires Android OS 4.0 or higher and Wi-Fi Direct™ support.

- 1 Connect the smartphone to a network.**
- 2 (Android) Select “Google Play™ Store”.**
(iOS) Select “App Store™”.
- 3 Enter “Leica Image Shuttle” into the search box.**
- 4 Select “Leica Image Shuttle”  and install it.**

- Use the latest version.
- Statement concerning the supported OS is correct as of September 2014, and is subject to change.
- Read the [Help] in the “Image Shuttle” menu for further details on how to operate.
- The screen differs depending on the OS.
- The screens and procedures described from this point on are those at the time when the camera first became available for purchase. The screens and procedures may change with version updates.
- The service may not be able to be used properly depending on the type of smartphone being used.
- When downloading the app on a mobile network, high packet communication fees may be incurred depending on the details of your contract.

Connecting to a smartphone/tablet

A connection can be easily established by pressing and holding [WIFI] or by using the NFC function.

Preparations:

- Install the “Image Shuttle” in advance. (P250)

1 Press and hold [WIFI].

- The information required for connecting the smartphone to the camera (QR code, SSID and password) is displayed.
- The same screen can be displayed by selecting the following menu items.

Wi-Fi → **[New Connection]** → **[Remote Shooting & View]**

- (A) SSID and password
- (B) QR code

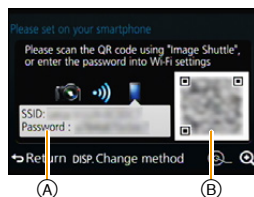
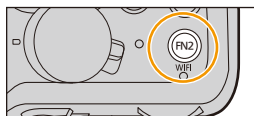

- To change the connection method, press [DISP], and then select the connection method.

2 Operate the smartphone.

- Once the connection is complete, the image from the camera will be displayed on the screen of the smartphone.
(After this operation, it may take a while for the connection to be completed.)
- The connection method differs according to your smartphone.



If you are using an iOS device

When scanning the QR code to set up a connection

(If you are reconnecting the camera, steps ❶ to ❷ are not required)

- ❶ Start "Image Shuttle". (P250)



- ❷ Select [QR code], and then [OK].

- ❸ Using "Image Shuttle", scan the QR code displayed on the screen of the camera.

- If you press [MENU/SET] on the camera, the QR code will be enlarged. When it is difficult to scan the QR code, try enlarging it.

(If the scanning is not successful, move the camera and the smartphone further away from each other and try again or use a connection method other than the QR code method.)



- ❹ Install the profile of "Image Shuttle".

- A message will be displayed on the browser.
- If the smartphone is locked with a passcode, enter the passcode to unlock the smartphone.

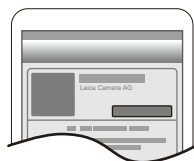

- ❺ Press the home button to close the browser.

- ❻ Turn on the Wi-Fi function in the setting menu of the smartphone.



- ❼ Select the SSID displayed on the screen of the camera.



- ❽ Return to the home screen, and then start "Image Shuttle". (P250)

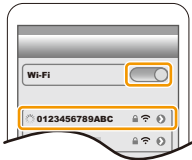

When using an SSID and password to set up a connection

- 1 Turn on the Wi-Fi function in the setting menu of the smartphone.
- 2 Select the SSID displayed on the screen of the camera.

- 3 Enter the password displayed on the screen of the camera.
(Only when connecting for the first time)
- 4 Start "Image Shuttle". (P250)

If you are using an Android device

When scanning the QR code to set up a connection

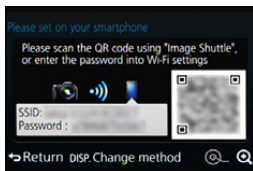
- 1 Start "Image Shuttle". (P250)

- 2 Select [QR code].
- 3 Using "Image Shuttle", scan the QR code displayed on the screen of the camera.
 - If you press [MENU/SET] on the camera, the QR code will be enlarged. When it is difficult to scan the QR code, try enlarging it.
(If the scanning is not successful, move the camera and the smartphone further away from each other and try again or use a connection method other than the QR code method.)

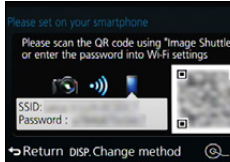

When using an SSID and password to set up a connection

- 1 Start "Image Shuttle". (P250)
- 2 Select [Wi-Fi].
- 3 Select the SSID displayed on the screen of the camera.

- 4 Enter the password displayed on the screen of the camera.
(Only when connecting for the first time)
 - If you mark the box that enables the smartphone to display the password, you can see the password as you enter it.

■ Changing the connection method

To change the connection method, press [DISP], and then select the connection method.



When connecting with [Via Network]:

On the camera

1 Select [Via Network].

- Follow the connection procedure described on [P265](#) to connect the camera to a wireless access point.

On your smartphone/tablet

2 Turn on the Wi-Fi function.

3 Connect the smartphone to the wireless access point to which the camera is connected.

4 Start "Image Shuttle". ([P250](#))

When connecting with [WPS Connection]* in [Direct]:

On the camera

1 Select [Direct].

- Follow the connection procedure described on [P267](#) to connect the camera to the smartphone.

On your smartphone/tablet

2 Start "Image Shuttle". ([P250](#))

- * WPS is a function that allows you to easily set up a connection with a wireless LAN device and make security-related settings. To check whether your smartphone supports the function, refer to the operating instructions of the smartphone.

■ Terminating the connection

After use, terminate the connection to the smartphone.

1 Press [WIFI] on the camera. ([P247](#))

2 On the smartphone, close "Image Shuttle".

(If you are using an iOS device)

On the screen of "Image Shuttle", press the home button to close the app.

(If you are using an Android device)

On the screen of "Image Shuttle", press the return button twice to close the app.

Connecting to a smartphone/tablet by using the NFC function

Using the NFC “Near Field Communication” function, you can easily transfer data necessary for a Wi-Fi connection between this camera and the smartphone.

Compatible models

This function can be used with the NFC compatible device with Android (OS version 2.3.3 or higher). (excluding some models)

Preparation:

(On the camera)

- Set [NFC Operation] to [ON]. (P272)

(On your smartphone)

- Check that your smartphone is a compatible model.
- Turn on the Wi-Fi function.
- Install the “Image Shuttle” in advance. (P250)

1 Launch “Image Shuttle” on the smartphone.

2 While [] is displayed on the screen of the smartphone, touch the smartphone to **(A)** of the camera.

3 When the connection confirmation screen is displayed on the camera, select [Yes].

4 Touch the smartphone to **(A)** of the camera again.

- Steps **3** through **4** are not required from the second time on.
- It may take time to complete the connection.
- When the smartphone has connected, an image of this camera will be displayed on the smartphone.
- The connected smartphone is registered to this camera.
- If a connection attempt by touching fails, restart the “Image Shuttle”, and then display the screen in step **1** again.
- If a connection is established during single picture playback, the picture will be transferred to the smartphone. (P258)

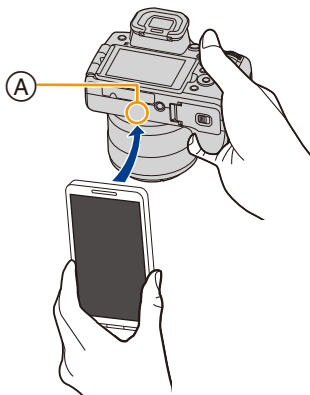

- You can register up to 20 smartphones. When the number exceeds 20, registrations will be deleted, starting from the oldest touched one.
- Performing [Reset Wi-Fi Settings] will delete the smartphone registration.
- If the camera is not recognized even when touching the smartphone, change positions and try again.
- Touch, but do not press the smartphone to this camera strongly.
- For information on the operation and settings of NFC-compatible smartphones, refer to the instructions of your device.
- If there is a metal object between this camera and the smartphone, reading may fail. Also, putting a sticker around the NFC area may deteriorate the communication performance.
- This function is not available in the following cases:
 - When connecting to a computer or a printer
 - When recording motion pictures
 - When using [Time Lapse Shot]
 - [Multi Exp.]

Taking pictures via a smartphone/tablet (remote recording)

1 Connect to a smartphone. (P251)

2 Operate the smartphone.

- 1 Select [].
- 2 Record an image.
 - The recorded images are saved in the camera.
 - Some settings are not available.

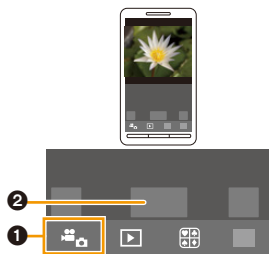

Playing back images in the camera

1 Connect to a smartphone. (P251)

2 Operate the smartphone.

- 1 Select [▶].
 - You can switch the images to be displayed by selecting the icon (A) on the top left of the screen. To display images stored in the camera, select [Leica Image Shuttle].
- 2 Touch the image to enlarge it.

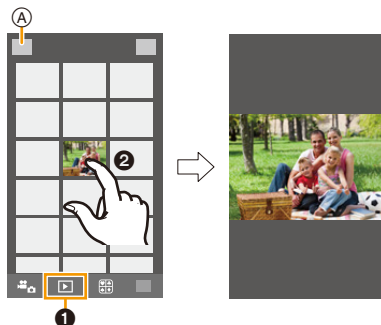

Saving images stored in the camera

1 Connect to a smartphone. (P251)

2 Operate the smartphone.

- 1 Select [▶].
 - You can switch the images to be displayed by selecting the icon (A) on the top left of the screen. To display images stored in the camera, select [Leica Image Shuttle].
- 2 Touch and hold an image, and drag it to save it.

- The function can be assigned to the top, bottom, left or right according to your preference.
- You cannot save pictures taken in RAW format or motion pictures recorded with their picture resolution set to 4K.

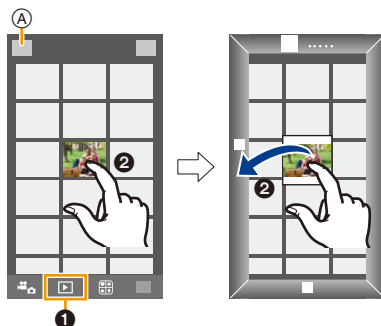

Transferring images stored in the camera easily

A Wi-Fi connection using NFC function is possible by touching the smartphone to the camera, and you can easily transfer images displayed on the screen.

An image can be sent on site immediately after taking it, so you can easily send it to the smartphone* of your family or friend.

* Installing the “Image Shuttle” is required for use.

Preparation:

(On the camera)

- Set [NFC Operation] to [ON]. (P272)
- Set [Touch Sharing] to [ON]. (P272)

(On your smartphone)

- Check that your smartphone is a compatible model.
- Turn on the Wi-Fi function.
- Install the “Image Shuttle” in advance. (P250)

- 1 Play back the picture in the camera.**
- 2 Launch “Image Shuttle” on the smartphone.**
- 3 While [] is displayed on the connection screen of the “Image Shuttle”, touch the smartphone to **A** of the camera.**

- It may take time to complete the connection.
- If a connection attempt by touching fails, restart the “Image Shuttle”, and then display the screen in step **2** again.
- To transfer more than one image, repeat steps **1** and **3**.
(They cannot be transferred as a batch.)

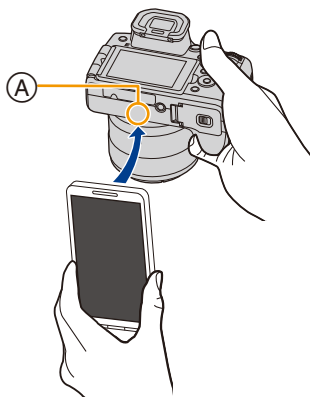

- Depending on the environment you are using, it may take a few minutes to complete the image transfer.
- You do not need to keep the devices in contact with each other while an image is being transferred. Do not put the camera down on top of the lens.

Sending images in the camera to an SNS

1 Connect to a smartphone. (P251)

2 Operate the smartphone.

① Select [▶].

- You can switch the images to be displayed by selecting the icon (A) on the top left of the screen. To display images stored in the camera, select [Leica Image Shuttle].

② Touch and hold an image, and drag it to send it to an SNS, etc.

- The image is sent to a web service such as an SNS.

- The function can be assigned to the top, bottom, left or right according to your preference.

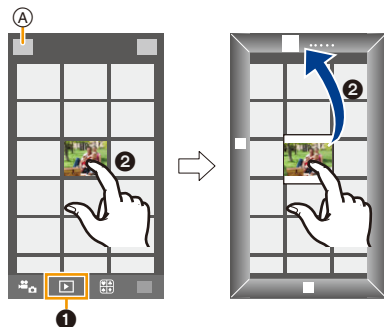

Adding location information to images stored in the camera from a smartphone/tablet

You can send location information acquired with a smartphone to the camera. After sending the information, you can also write it on images stored in the camera.

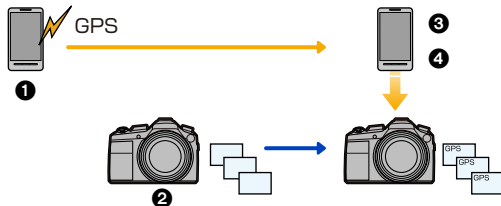

① Start recording location information

② Start recording images

③ Finish recording the location information

④ Sending and writing location information

- Location information different from that at the time of recording may be written. Keep the following points in mind:

- Set the camera's [Home] setting in [World Time] to your region.

- Once you start recording location information with your smartphone, do not change the camera's [Home] setting in [World Time].

- Location information cannot be written on images that were recorded when the clock was not set.

■ Starting recording location information

Operate the smartphone.

- 1 Select [].
- 2 Select [Geotagging].
- 3 Select [].



■ Finishing recording the location information

Operate the smartphone.

- 1 Select [].
- 2 Select [Geotagging].
- 3 Select [].



■ Sending and writing location information

1 Connect to a smartphone. (P251)

2 Operate the smartphone.

- 1 Select [].
- 2 Select [Geotagging].
- 3 Select [].

- Follow the on-screen messages to operate the smartphone.
- When the card in the camera lacks sufficient free space, writing location information may not be possible.
- Once the location information is sent to the camera, you can also write it on images by performing [Location Logging] in the [Playback] menu.



• Cautions for Use:

Remember not to exploit this function whenever it may violate the privacy, the likeness rights, etc. of the targeted subject. Use at your own risk.

- On the smartphone, you can set the acquisition interval of location information and check the transfer status of location information. Refer to [Help] in the “Image Shuttle” menu for details.
- (When using “Image Shuttle” for iOS)
If you press the Home or On/Off button of the smartphone while location information is being recorded, the recording will stop.



Location information is not available in China and the border area in the neighbouring countries of China.

(As of June 2014)

Sending images to a smartphone/tablet by controlling the camera

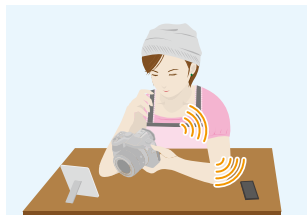

■ Methods for sending and images that can be sent

	JPEG	RAW	MP4
Sending an image each time a recording is made ([Send Images While Recording])	○	—	—
Sending selected images ([Send Images Stored in the Camera])	○	—	○*

* Excluding motion pictures recorded with their size set to [4K] in [Rec Quality]

- Some images may not be played back or sent depending on the device.
- For information on the playback of images, check the instructions of the destination device.
- For details on how to send images, refer to [P270](#).

Preparations:

- Install the "Image Shuttle" in advance. ([P250](#))

Click the followings to jump to the beginning of each menu.

Sending an image each time a recording is made ([Send Images While Recording]) [P262](#)

Sending selected images ([Send Images Stored in the Camera]) [P263](#)

Sending an image each time a recording is made ([Send Images While Recording])

1 Select the menu.

Wi-Fi → **[New Connection]** → **[Send Images While Recording]**

2 Select **[Via Network]** or **[Direct]**, and connect. (P264)

On your smartphone

When connecting with **[Via Network]**:

- 1 Turn on the Wi-Fi function.
- 2 Select the wireless access point you want to connect to, and set.
- 3 Start "Image Shuttle". (P250)

When connecting with **[Wi-Fi Direct]** or **[WPS Connection]** in **[Direct]**:

- 1 Start "Image Shuttle". (P250)

When connecting with **[Manual Connection]** in **[Direct]**:

- 1 Turn on the Wi-Fi function.
- 2 Select the SSID that matches the one displayed on the screen of the camera, and then enter the password.
- 3 Start "Image Shuttle". (P250)

3 Select a device you want to connect.

- When the connection is complete, the screen is displayed. To change the send setting, press **[DISP]**. (P271)

4 Take pictures.

- The pictures are sent automatically after taking them.
- To change the setting or disconnect, press **[WIFI]**. (P247)
You cannot change the settings while sending pictures. Wait until sending is complete.

Sending selected images ([Send Images Stored in the Camera])

1 Select the menu.

Wi-Fi → [New Connection] → [Send Images Stored in the Camera]

2 Select [Via Network] or [Direct], and connect. (P264)

On your smartphone

When connecting with [Via Network]:

- ❶ Turn on the Wi-Fi function.
- ❷ Select the wireless access point you want to connect to, and set.
- ❸ Start "Image Shuttle". (P250)

When connecting with [Wi-Fi Direct] or [WPS Connection] in [Direct]:

- ❶ Start "Image Shuttle". (P250)

When connecting with [Manual Connection] in [Direct]:

- ❶ Turn on the Wi-Fi function.
- ❷ Select the SSID that matches the one displayed on the screen of the camera, and then enter the password.
- ❸ Start "Image Shuttle". (P250)

3 Select a device you want to connect.

- When the connection is complete, the screen is displayed. To change the send setting, press [DISP]. (P271)

4 Select [Single Select] or [Multi Select].

- To change the setting or disconnect, press [WIFI]. (P247)

[Single Select] setting

- ❶ Select the picture.
- ❷ Press [MENU/SET].



[Multi Select] setting

- ❶ Select the picture. (repeat)
 - The setting is canceled when the picture is selected again.
- ❷ Select [OK].
 - The number of pictures that can be sent by [Multi Select] is limited.

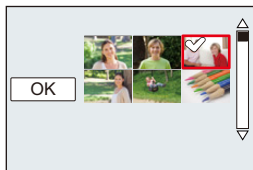

- A confirmation screen is displayed. The function is executed when [Yes] is selected.

About Connections

You can select a connection method after selecting a Wi-Fi function and a destination. Performing a direct connection is convenient for when you are in a place away from home where wireless access points are not available or for when connecting temporarily to a device you do not usually use.

When connecting with the same settings as the previous ones, you can use the Wi-Fi function quickly by connecting via [Select a destination from History] or [Select a destination from Favorite].

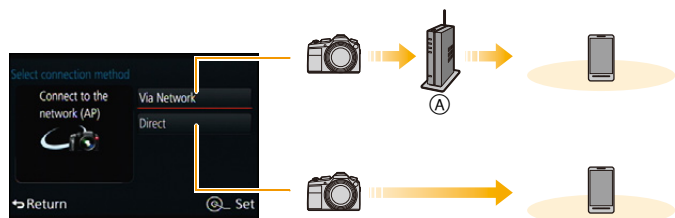

Ⓐ Wireless access point

[Via Network]	Connects via a wireless access point.	P265
[Direct]	Your device connects directly to the camera.	P267

Connecting from your house (via the network)

You can select the method for connecting to a wireless access point.

- * WPS refers to a function that allows you to easily configure the settings related to the connection and security of wireless LAN devices.

To check if the wireless access point you are using is compatible with WPS, refer to the manual of the wireless access point.

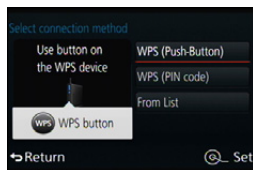

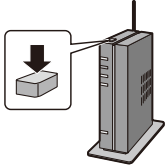
<p>[WPS (Push-Button)]</p>	<p>Saves a push button type wireless access point that is compatible with Wi-Fi Protected Setup™ with a WPS mark.</p> <p>Press the wireless access point WPS button until it switches to WPS mode. e.g.:</p> <ul style="list-style-type: none"> • Refer to the wireless access point instruction manual for details. 
<p>[WPS (PIN code)]</p>	<p>Saves PIN code type wireless access point that is compatible with Wi-Fi Protected Setup with a WPS mark.</p> <ol style="list-style-type: none"> 1 Select the wireless access point you are connecting to. 2 Enter the PIN code displayed on the camera screen into the wireless access point. 3 Press [MENU/SET]. <ul style="list-style-type: none"> • Refer to the wireless access point instruction manual for details.
<p>[From List]</p>	<p>Select this option when you are not sure about the WPS compatibility, or when you want to search for and connect to a wireless access point.</p> <ul style="list-style-type: none"> • Refer to P266 for details.

If you are not sure about the WPS compatibility (connecting by [From List])

Search for available wireless access points.

- Confirm the encryption key of the selected wireless access point if the network authentication is encrypted.
- When connecting by [Manual Input], confirm SSID, encryption type, and encryption key of the wireless access point you are using.

1 Select the wireless access point you are connecting to.

- Pressing [DISP] will search for a wireless access point again.
- If no wireless access point is found, refer to “When connecting with [Manual Input]” on [P266](#).

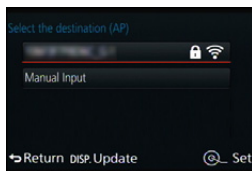
**2 (If network authentication is encrypted)****Enter the encryption key.**

- For details on how to enter characters, refer to “Entering Text” section on [P54](#).

■ When connecting with [Manual Input]**1 On the screen displayed in step 1 of “If you are not sure about the WPS compatibility (connecting by [From List])”, select [Manual Input].****2 Enter the SSID of the wireless access point you are connecting to, then select [Set].**

- For details on how to enter characters, refer to “Entering Text” section on [P54](#).

3 Select the network authentication type.

- For information on network authentication, see the instructions of the wireless access point.

4 Select the encryption type.

- The type of settings that can be changed may vary depending on the details of network authentication settings.

Network authentication type	Encryption types that can be set
[WPA2-PSK]/[WPA-PSK]	[TKIP]/[AES]
[Common Key]	[WEP]
[Open]	[No Encryption]/[WEP]

5 (When an option other than [No Encryption] is selected)**Enter the encryption key.**

- Check the wireless access points instruction manual and settings when saving a wireless access point.
- If no connection can be established, the wireless access point’s radio waves may be too weak. Refer to “Message Displays” ([P298](#)) and “Troubleshooting” ([P311](#)) for details.
- Transmission speed may decrease, or may not be usable depending on the environment it is used in.

Connecting from a location away from your house (direct connection)

You can select the method for connecting to the device you are using.

Select the connection method supported by your device.

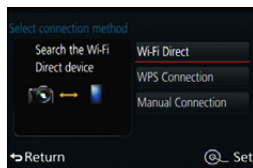

[Wi-Fi Direct]	<ol style="list-style-type: none"> 1 Set the device to Wi-Fi Direct™ mode. 2 Select [Wi-Fi Direct]. 3 Select the device to connect to. <ul style="list-style-type: none"> • Read the instructions of your device for details.
[WPS Connection]	<p>[WPS (Push-Button)]</p> <ol style="list-style-type: none"> 1 Select [WPS (Push-Button)]. 2 Set the device to WPS mode. <ul style="list-style-type: none"> • You may have to wait longer for a connection when pressing the [DISP] button.
	<p>[WPS (PIN code)]</p> <ol style="list-style-type: none"> 1 Select [WPS (PIN code)]. 2 Enter the PIN code of the device into the camera.
[Manual Connection]	<p>Enter the SSID and password into the device. The SSID and password are displayed on the connection waiting screen of the camera.</p> <ul style="list-style-type: none"> • If you press [MENU/SET] on the camera, the QR code will be enlarged. When it is difficult to scan the QR code, try enlarging it. (P252, 253)

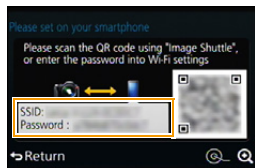

Connecting quickly with the same settings as the previous ones ([Select a destination from History]/[Select a destination from Favorite])

When the Wi-Fi function is used, a record is saved in the history. You can register records as favorites.

Connecting from the history or favorites allows you to easily connect with the same settings as the previous ones.

1 Press [WIFI].

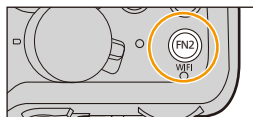

2 Select [Select a destination from History] or [Select a destination from Favorite].

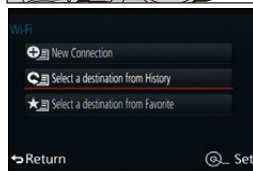

[Select a destination from History]	Connects with the same settings as the previous ones.
[Select a destination from Favorite]	Connects with settings registered as favorites.

3 Select item.

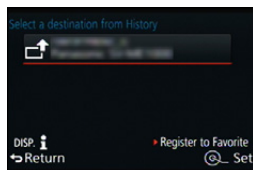

Registering records as favorites

1 Press [WIFI].

2 Select [Select a destination from History].

3 Select the item you want to register to favorites, and then press ►.

4 Enter a registration name.

- For details on how to enter characters, refer to “Entering Text” section on P54.
- A maximum of 30 characters can be entered. A two-byte character is treated as two characters.

Editing the items registered to favorites

- 1 Press [WIFI].
- 2 Select [Select a destination from Favorite].
- 3 Select the favorite item you want to edit, and then press ►.
- 4 Select the item.

[Remove from Favorite]	—
[Change the Order in Favorite]	Select the destination.
[Change the Registered Name]	<ul style="list-style-type: none"> • For details on how to enter characters, refer to “Entering Text” section on P54. • A maximum of 30 characters can be entered. A two-byte character is treated as two characters.



Saving frequently-used Wi-Fi connection settings as favorites

The number that can be saved in the history is limited.
We recommend that you save frequently-used Wi-Fi connection settings by registering them as favorites. (P268)



Checking the connection detail of the history or favorite

If [DISP] is pressed when selecting an item in the history or favorites, the details of the connection can be displayed.

- Performing [Reset Wi-Fi Settings] clears the history and the contents saved in [Select a destination from Favorite].
- When connecting to a network to which many computers are connected by using [Select a destination from History] or [Select a destination from Favorite], a connection attempt may fail because the previously-connected device will be identified from among many devices. If a connection attempt fails, reconnect by using [New Connection].

About settings for sending images

When sending images, select the method for sending them after selecting [New Connection].

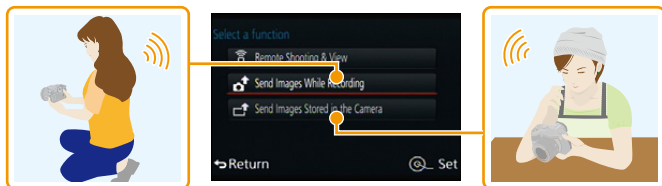

After the connection has been completed, settings for sending, such as the image size for sending, can also be changed.



Sending Images While Recording

A picture can be automatically sent to a specified device every time you take it.

- Since the camera gives priority to recording, sending may take longer during the recording.

- When connected with [Send Images While Recording], [] is displayed on the recording screen, and [] is displayed while sending a file.
- If you turn off the camera or the Wi-Fi connection before sending is complete, unsent pictures will not be resent.
- You may not be able to delete files or use the playback menu while sending.

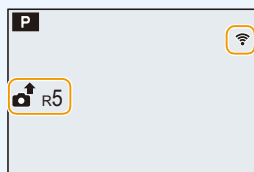

Motion pictures cannot be sent.

Send Images Stored in the Camera

Images can be selected and sent after recording.

- Details of the playback menu [Favorite] or [Print Set] settings will not be sent.



- Some images taken with a different camera may not be able to be sent.
- Images that have been modified or edited with a computer may not be able to be sent.

Changing the settings for sending images

Pressing [DISP] after completing a connection allows you to change the settings for sending such as the image size for sending.

<p>[Size]</p>	<p>Resize the image to send. [Original]/[Change]</p> <ul style="list-style-type: none"> • You can select the resolution for [Change] from [M], [S] or [VGA]. The aspect ratio does not change.
---------------	---

[Wi-Fi Setup] Menu

This menu allows configuring the settings required for the Wi-Fi function. The settings cannot be changed when connected to Wi-Fi.

Select the menu.

MENU → **⌘ [Setup]** → **[Wi-Fi]** → **[Wi-Fi Setup]** → **Desired item to be set**

[Device Name]	<p>You can change the name of the camera.</p> <ol style="list-style-type: none"> 1 Press [DISP]. 2 Enter the desired device name. <ul style="list-style-type: none"> • For details on how to enter characters, refer to “Entering Text” section on P54. • A maximum of 32 characters can be entered.
[NFC Operation]	<p>Configures the settings for the NFC function.</p> <p>[ON]: NFC function is worked.</p> <p>[OFF]</p>
[Touch Sharing]	<p>Sets the camera operation after the connection with the NFC function is complete.</p> <p>[ON]: When a Wi-Fi connection is complete by using the NFC function during single picture playback, the single picture can be transferred.</p> <p>[OFF]</p>

[Wi-Fi Password]	To prevent incorrect operation or use of the Wi-Fi function by a third party and to protect saved personal information, it is recommended that you protect the Wi-Fi function with a password. Setting a password will automatically display the password input screen when the Wi-Fi function is used. [Setup]: Enter any 4-digit numbers as the password. [Delete]
-------------------------	--

• For details on how to enter characters, refer to “Entering Text” section on [P54](#).

• Make a copy of password.

If you forget the password, you can reset it with [Reset Wi-Fi Settings] in the [Setup] menu, however other settings will also be reset.

[Network Address]	Displays the MAC address and IP address of the camera.
--------------------------	--

• A “MAC Address” is a unique address that is used to identify network equipment.

• “IP address” refers to a number that identifies a computer connected to a network such as the Internet. Usually, the addresses for homes are automatically assigned by the DHCP function such as a wireless access point. (Example: 192.168.0.87)

[Approved Regulations]*	The technical compliance standard authentication number is displayed.
--------------------------------	---

* With camera model 18 194.

Enjoying Motion Pictures in 4K

Watching motion pictures in 4K

■ Playing Back on a TV

By connecting the camera to a TV that supports 4K and playing back motion pictures recorded with their resolution set to [4K] in [Rec Quality], you can enjoy extremely high-detail motion pictures in 4K. Even though the output resolution will be lower, you can also play them back by connecting the camera to a TV that does not support motion pictures in 4K.



Preparation: If the resolution is [4K], set [HDMI Mode (Play)] (P51) to [AUTO] or [4K].

Connect the camera and a 4K-compatible TV with an HDMI micro cable, and display the playback screen. (P275)

- When [HDTV Link] is set to [ON] and the camera is connected to a TV supporting HDTV Link, input of the TV will be switched automatically and playback screen will be displayed. Refer to P278 for details.
- When you have motion pictures recorded with their resolution set to [4K] in [Rec Quality], you can also play them back by inserting the card into the SD card slot of a TV that supports 4K.
- Read the instructions for the TV.



■ Watching on a computer

- To play back and edit motion pictures in 4K, you need a high-performance computer environment.



Storing 4K motion pictures

■ Storing on a computer

You can acquire recorded pictures to a computer by connecting the camera and the computer.

Refer to P280 for details.

Playing Back Pictures on a TV

Pictures recorded with this camera can be played back on a TV.

Preparations: Turn the camera and the TV off.

- Make sure to use cables compatible with the TV's terminals.
Image quality varies depending on the type of terminal used.

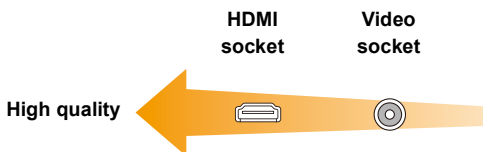

1 Connect the camera and a TV.

- Make sure the plugs are aligned correctly and that they are inserted straight. (Otherwise the connectors may be bent out of shape which may cause trouble.)

Do not connect devices to incorrect terminals. Doing so may cause malfunction.

To connect with an HDMI micro cable

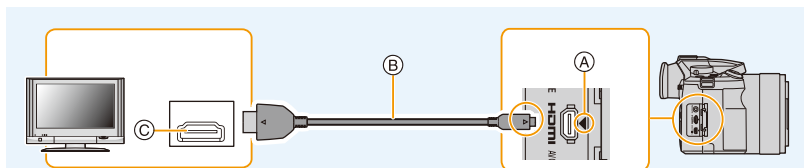

- Use only a "High Speed HDMI micro cable" with the HDMI logo.
Cables that do not comply with the HDMI standards will not work.
"High Speed HDMI micro cable" [Type D–Type A plug, up to 2m (6'7") long]
- Check the [HDMI Mode (Play)]. (P51)
- During 24p motion picture playback, please set [HDMI Mode (Play)] to [AUTO].
For settings other than [AUTO], it cannot output at 24 frames/second.
- Audio will be played back as stereo (2ch).
- No picture is displayed on the screen of the camera.
- When [HDTV Link] is set to [ON], operations using the buttons on the camera are restricted.

(A) Align the marks, and insert.

(C) HDMI socket

(B) HDMI micro cable



To connect with an AV cable

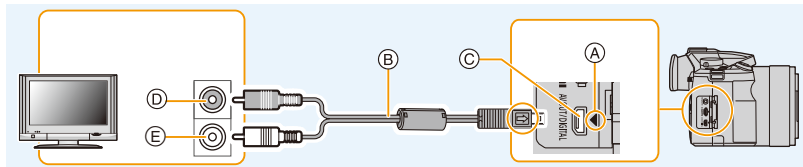

- Use only AV cables that comply with the respective standards.
- Check the [TV Aspect]. (P51)
- Audio will be played back in monaural.
- The viewfinder will not operate when connected with an AV cable.

- (A) Align the marks, and insert.
- (B) AV cable
- (C) [AV OUT/DIGITAL] terminal
 - The color of the terminal is gold.
- (D) Yellow: to the video input socket
- (E) White: to the audio input socket

2 Turn on the TV and select the input to match the connection in use.

3 Turn the camera on and then press [▶].

- The input of the TV will switch automatically and the playback screen is displayed when connected to a HDTV Link compatible TV using an HDMI micro cable with [HDTV Link] (P52) set to [ON]. (P278)

- Depending on the [Aspect Ratio], black bands may be displayed on the top and bottom or the left and right of the pictures.
- Change the screen mode on your TV if the picture is displayed with the top or bottom cut off.
- Output from the HDMI micro cable has priority when both an AV and an HDMI micro cable are connected.
- The connection with the USB connection cable (supplied) will take priority when there is a simultaneous connection with the HDMI micro cable.
- When you play back a picture vertically, it may be blurry.
- Proper playback will be dependent on the TV used for viewing.
- You can view pictures on TVs in other countries (regions) which use the NTSC or PAL system when you set [Video Out] in the [Setup] menu. (With camera models 18 193 / 18 196)
- No sound is output from the camera speakers.
- Read the instructions for the TV.





The recorded pictures can be played back on a TV with an SD Memory Card slot

- Depending on the TV model, pictures may not be displayed on the full screen.
- The file format of the motion pictures that can be played back differs depending on the TV model.
- In some cases, panorama pictures cannot be played back. Also, auto-scroll playback of panorama pictures may not work.
- For cards compatible with playback, refer to the instructions of the TV.

Using HDTV Link (HDMI)

What is the HDTV Link (HDMI) (HDAVI Control™)?

- This function allows you to use the remote control unit of compatible TVs for easy operations when the camera has been connected to a HDTV Link compatible device using an HDMI micro cable for automatic linked operations.
(Not all operations are possible.)
- HDTV Link is a function based on a HDMI control function using the standard HDMI CEC (Consumer Electronics Control) specification.
Linked operations with HDMI CEC compatible devices are not guaranteed for all makes.
When using devices made by other companies that are compatible with HDTV Link, refer to the instructions for the respective devices.

Preparations: Set the [HDTV Link] to [ON]. (P52)

- 1 Connect the camera to a TV compatible with HDTV Link with an HDMI micro cable (P275).**
- 2 Turn the camera on and then press [▶].**
- 3 Operate with the remote control for the TV.**
 - Operate with reference to the operation icons displayed on the screen.

- To play back the sound of a film during a slide show, set [Sound] to [AUTO] or [Audio] on the Slide Show setting screen.
- It is recommended to connect the camera to an HDMI terminal other than the HDMI1 if there are 2 or more HDMI input terminals on the TV.
- Operation using the buttons on the camera will be limited.

■ Other linked operations

Turning the camera off:

If you use the remote control for the TV to turn the TV off, the camera is also turned off.

Automatic input switching:

- If you connect with an HDMI micro cable, then turn the camera on, and then press [▶], the input channel on the TV automatically switches to the camera's screen. If the TV's power is in standby status, it will turn on automatically (if [Set] has been selected for the TV's [Power on link] setting).
- Depending on your TV's HDMI connection, on some TV's it may be necessary to manually select the HDMI connection you are using. In this case, use the remote control for the TV to switch the input channel.
(For details on how to switch input, please read the instructions for the TV.)
- If HDTV Link does not work properly, refer to [P322](#).

- If you are unsure whether or not the TV you are using is compatible with HDTV Link, read the operating instructions for the TV.
- Available linked operations between the camera and a TV is different depending on the types TVs even if they are compatible with HDTV Link. Refer to the instructions of the TV for the operations that support on the TV.
- Be sure to use a cable that is HDMI certified.
- Use only a "High Speed HDMI micro cable" with the HDMI logo.
Cables that do not comply with the HDMI standards will not work.
"High Speed HDMI micro cable" [Type D–Type A plug, up to 2m (6'7") long]
- [HDMI Mode (Play)] for the camera is determined automatically when the HDTV Link is operating.

Copying the recorded image data to a computer

With card readers (built-in / external)

- Some computers can read directly from the card taken from the camera, others require the use of an external card reader. For details, refer to the instructions of the respective devices.
- If the computer being used does not support SDXC Memory Cards, a message prompting you to format may appear.
(Doing so would cause all recorded image data to be erased, so make sure to select [NO].)
- With an external card reader, make sure it supports the type of card being used.

With a computer connected directly to the camera (using the available software)

■ Computers that can be used:

Any model capable of recognizing a mass storage device.

- Windows support: Windows XP/Windows Vista/Windows 7/Windows 8/
Windows 8.1
- Mac support: OS X v10.5 to v10.9

Using the Adobe® Photoshop® Lightroom® software, you can import the image data for still and motion pictures recorded with this camera in all file formats to a computer.

■ Installing the software

To utilize the software, it must be installed first. Three preparatory steps are necessary:

1 Register your camera on the Leica Camera AG homepage.

- a. Open an account at <http://owners.leica-camera.com>. As a result, you will receive access to the "Owners area".
 - b. Register your camera at "My products" by entering its serial number. Do so by following the respective instructions.
 - c. Then select "...software download...". You will be requested to enter the TAN code which you will find on a sticker on the Guarantee Card.
- The key with which you can activate the software will be sent to you by email.

2 Install the software to your computer.

3 Activate the software with the key (numbers) you have received.

- Do so by following the respective instructions appearing after opening the software.
- For details on how to operate the software, refer to the online assistance.

■ Copying the data

1 Connect the computer and camera with the supplied USB connection cable.

- Please turn the camera and your computer on before connecting.
- **Make sure to use the right plugs for the differing sockets, that the plugs are aligned correctly and that they are inserted straight.**
(Otherwise the connectors may be bent out of shape which may cause malfunction.)
- Hold the plugs (not the cable) to insert. Do not use any other USB connection cables except the supplied one or a genuine Leica USB connection cable.

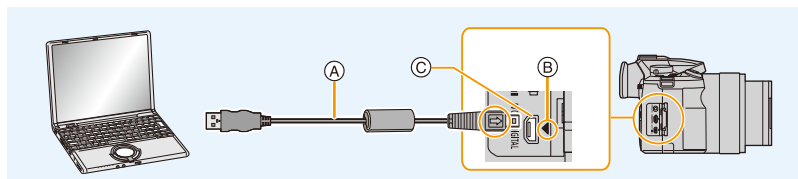

- (A) USB connection cable
- (B) Align the marks, and insert.
- (C) [AV OUT/DIGITAL] terminal
 - The color of the terminal is gold.

2 Press ▲/▼ to select [PC], and then [MENU/SET].

- If [USB Mode] (P50) is set to [PC] in the [Setup] menu in advance, the camera will be automatically connected to the computer without displaying the [USB Mode] selection screen.
- If [USB Mode] is set to [PictBridge(PTP)], a message may appear on the computer screen. In that case, close the message, and remove the USB connection cable safely, and then set the [USB Mode] to [PC].

3 Copy the images to the computer using the installed software.

- Use a battery with sufficient battery power. If the remaining battery power becomes low while the camera and the computer are communicating, the status indicator flashes and the alarm beeps.
Disconnect the USB connection cable safely. Otherwise, data may be destroyed.
- Before inserting or removing a card, turn the camera off and disconnect the USB connection cable. Otherwise, data may be destroyed.

■ Copying to a computer without using the available software

If you are not able to install the available software, you can copy files and folders to your computer by dragging and dropping files from the camera.

- The content (folder structure) on the card of this camera is as follows.

For Windows: A drive ([LEICA]) is displayed in [Computer]

For Mac: A drive ([LEICA]) is displayed on the desktop

• Card

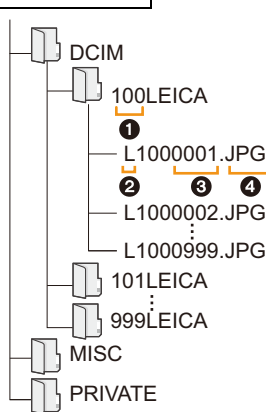

DCIM:	Images
① Folder number	
② Color space	L: sRGB _: AdobeRGB
③ File number	
④ JPG:	Still pictures
MP4:	[MP4] Motion pictures
RWL:	Pictures in RAW files
MISC:	DPOF print Favorite

- A new folder is created when pictures are taken in the following situations.
 - After [No.Reset] (P53) in the [Setup] menu has been executed
 - When a card containing a folder with the same folder number has been inserted (such as when pictures were taken using another camera make)
 - When there is a picture with file number 999 inside the folder

■ Connection in the PTP Mode

Set [USB Mode] to [PictBridge(PTP)].

- The data can now be read only from the card in the PC.
- When there are 1000 or more pictures on a card, the pictures may not be imported in the PTP Mode.
- Motion pictures cannot be played back in PTP Mode.

Saving still pictures and motion pictures on a Recorder

■ Dubbing with non-compatible equipment

You can dub the content played back using this camera to non-compatible equipment such as recorders and video players by connecting the camera to the non-compatible equipment using an AV cable.

Non-compatible equipment will be able to play back the content. This is convenient if you wish to pass around dubbed content. In this case, the content will be played back in standard rather than high-definition picture quality.

- 1 **Connect the camera with the recording equipment with an AV cable.**
- 2 **Start the playback of the camera.**
- 3 **Start the recording on the recording equipment.**

- When ending the recording (copying), stop the playback on the camera after stopping the recording on recording equipment.

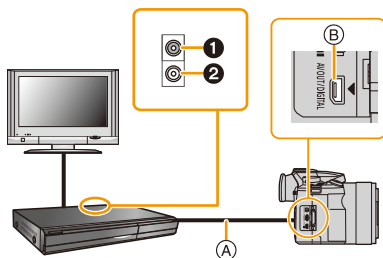

- ① Yellow: to the video input socket
- ② White: to the audio input socket
- Ⓐ AV cable
- Ⓑ [AV OUT/DIGITAL] terminal
 - The color of the terminal is gold.

- When you play back motion pictures on 4:3 aspect ratio TV, you must set [TV Aspect] (P51) on the camera to [4:3] before starting a copy. The image will be vertically long if you play back motion pictures copied with [16:9] setting on a [4:3] aspect TV.
- Use only AV cables that comply with the respective standards.
- See the instructions for the recording equipment for details about copying and playing back.

Printing the Pictures

If you connect the camera to a printer supporting PictBridge, you can select the pictures to be printed out and instruct that printing be started on the camera's monitor.

- Group pictures will not be displayed as group pictures but as single pictures.
- Some printers can print directly from the card removed from the camera. For details, refer to the operating instructions of your printer.

Preparations: Turn on the camera and the printer.

Perform the print quality and other settings at the printer before printing the pictures.

1 Connect the printer and camera with the supplied USB connection cable.

- Check the direction of the terminals and plug in/out straight holding onto the plug.

(It may result in malfunction by the deforming of the terminal if it is plugged in obliquely or in wrong direction.)

Do not connect devices to incorrect terminals. Doing so may cause malfunction.

- Do not use any other USB cables except the supplied one. Use of cables other than the supplied one may cause malfunction.

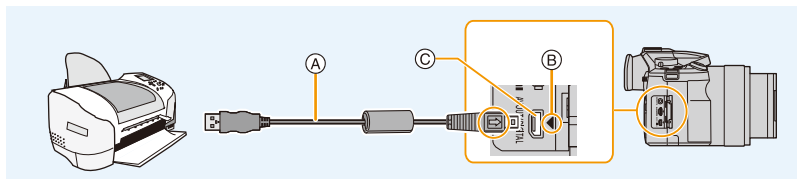

- Ⓐ USB connection cable
- Ⓑ Align the marks, and insert.
- Ⓒ [AV OUT/DIGITAL] terminal
 - The color of the terminal is gold.

2 Press ▲/▼ to select [PictBridge(PTP)], and then [MENU/SET].



- Use a battery with sufficient battery power. If the remaining battery power becomes low while the camera and the printer are connected, the status indicator flashes and the alarm beeps. If this happens during printing, stop printing at once. If not printing, disconnect the USB connection cable.
- Do not disconnect the USB connection cable while  (Cable disconnect prohibit icon) is displayed.
(May not be displayed depending on the type of printer used.)
- Before inserting or removing a card, turn the camera off, and disconnect the USB connection cable.



Motion pictures recorded cannot be printed out.

Selecting a single picture and printing it

- 1 Press **◀/▶** to select the picture and then **[MENU/SET]**.



- 2 Press **▲** to select **[Print start]** and then **[MENU/SET]**.
 - Refer to [P287](#) for the items that can be set before starting to print the pictures.
 - Disconnect the USB connection cable after printing.

Selecting multiple pictures and printing them

- 1 Press **▲**.
- 2 Press **▲/▼** to select an item and then **[MENU/SET]**.

[Multi Select]	<p>Multiple pictures are printed at one time.</p> <ul style="list-style-type: none"> • Press ▲/▼/◀/▶ to select the pictures and then [MENU/SET]. (When [MENU/SET] is pressed again, the setting is canceled.) • After the pictures have been selected, press ◀ to select [OK], and then [MENU/SET].
[Select All]	Prints all the stored pictures.
[Print Set (DPOF)]	Prints the pictures set in [Print Set] only. (P240)
[Favorite]	Prints the pictures set as favorites only. (P239)

- 3 Press **▲** to select **[Print start]** and then **[MENU/SET]**.
 - If the print check screen has appeared, select **[Yes]**, and print the pictures.
 - Refer to [P287](#) for the items which can be set before starting to print the pictures.
 - Disconnect the USB connection cable after printing.

Print Settings

Select and set the items both on the screen in step 2 of the “Selecting a single picture and printing it” and in step 3 of the “Selecting multiple pictures and printing them” procedures.

- When you want to print pictures on a paper size or a layout which is not supported by the camera, set [Paper Size] or [Page Layout] to  and then set the paper size or the layout on the printer.
(For details, refer to the operating instructions of the printer.)
- When [Print Set (DPOF)] has been selected, the [Print with Date] and [Num.of prints] items are not displayed.

■ [Print with Date]

[ON]	Date is printed.
[OFF]	Date is not printed.

- If the printer does not support date printing, the date cannot be printed on the picture.
- Depending on the printer, the date print settings of the printer may take precedence so check if this is the case.
- When printing images with a text stamp, please remember to set print with date to [OFF] or the date will print on top.
- In some printers, the picture date for pictures taken with the aspect ratio set to [1:1] will be printed vertically.

When asking the photo shop to print the pictures

- By stamping the date using [Text Stamp] (P231) or setting date printing at the time of the [Print Set] (P240) setting before going to a photo shop, the dates can be printed on the pictures at the photo shop.

■ [Num.of prints]





You can set the number of prints up to 999.

■ [Paper Size]

	Settings on the printer are prioritized.
[L/3.5"×5"]	89mm×127mm
[2L/5"×7"]	127mm×178mm
[POSTCARD]	100mm×148mm
[16:9]	101.6mm×180.6mm
[A4]	210mm×297mm
[A3]	297mm×420mm
[10×15cm]	100mm×150mm
[4"×6"]	101.6mm×152.4mm
[8"×10"]	203.2mm×254mm
[LETTER]	216mm×279.4mm
[CARD SIZE]	54mm×85.6mm

• Paper sizes not supported by the printer will not be displayed.

■ [Page Layout] (Layouts for printing that can be set with the camera)

	Settings on the printer are prioritized.
	1 picture with no frame on 1 page
	1 picture with a frame on 1 page
	2 pictures on 1 page
	4 pictures on 1 page

• An item cannot be selected if the printer does not support the page layout.

■ Layout printing

When printing a picture several times on 1 sheet of paper.

For example, if you want to print the same picture 4 times on 1 sheet of paper, set [Page Layout] to  and then set [Num.of prints] to 4 for the picture that you want to print.

When printing different pictures on 1 sheet of paper.

For example, if you want to print 4 different pictures on 1 sheet of paper, set [Page Layout] to  and then set [Num.of prints] to 1 for each of the 4 pictures.

- The camera is receiving an error message from the printer when the  indication lights orange during printing. After finishing printing, make sure there are no problems with the printer.
- If the number of prints is high, the pictures may be printed several times. In this case, the remaining number of prints indicated may differ from the number set.
- Only pictures taken in JPEG format can be printed. Those taken in RAW will use the JPEG pictures that were simultaneously created. If an equivalent JPEG picture is not available, no print will take place.

Accessories

External Flash Units

When you use an external flash unit such as the Leica CF22 (available as accessory P13), you will have a longer effective flash range than with the built-in flash.

Preparations:

- Turn off the camera and close the built-in flash.

Removing the Hot Shoe Cover

The camera comes with the hot shoe cover in the hot shoe.

To remove the hot shoe cover

- 1 Press down at the front to unlock
- 2 Pull out in the direction indicated by the arrow

- When the hot shoe is not in use, make sure to use the cover.
- Please be careful not to lose the hot shoe cover.
- Keep the hot shoe cover out of reach of children to prevent swallowing.

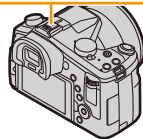
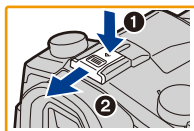

Using the compatible flash units

- 1 Mount the flash unit in the hot shoe and then turn on camera and flash.
- 2 Select the menu item.

MENU → [Rec] → [Flash]

- 3 Press **▲/▼** to select [Flash Mode] and then [MENU/SET].
- 4 Press **▲/▼** to select an item and then [MENU/SET].
 - While the external flash is connected, the following icons are displayed.

: External flash ON

: External flash Slow Sync.

: External flash OFF





When using other commercially available external flash units without communication functions with the camera





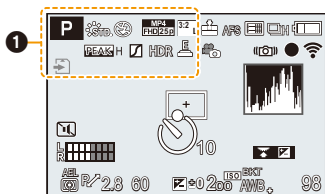

- It is necessary to set the exposure on the external flash unit. If you want to use it in its Auto Mode, use one that allows you to set the aperture value and the ISO sensitivity to match the settings on the camera.
 - Set to Aperture-Priority Mode or Manual Exposure Mode on the camera and then set the same aperture value and ISO sensitivity on the external flash unit. (The exposure cannot be compensated adequately due to the change on the aperture value in Shutter-Priority Mode and the external flash unit cannot control its light output adequately in Program Mode because the aperture value cannot be fixed.)
-
- You can set the aperture value, the shutter speed and the ISO sensitivity on the camera even with an attached external flash unit.
 - Some commercial external flash units have synchro terminals with high-voltage or reversed polarity. Using such devices may cause a malfunction or the camera may not operate normally.
 - Even if the attached external flash unit is turned off, the camera may enter the external flash mode. When you are not using the external flash unit, detach it.
 - Do not open the built-in flash when an external flash unit is attached.
 - The camera may become top-heavy when attaching the larger external flash unit.
 - Detach the external flash unit when carrying the camera.
 - With an attached the flash unit, do not hold the combination only by the flash unit because it may detach from the camera.
 - If you use an external flash unit when the White Balance is set to [], finely adjust the White Balance depending on the picture quality. (P129)
 - If you record at close range with the lens set to a short (Wide) focal length, light from the flash may be blocked by the lens, darkening the lower part of the picture.
 - Read the instructions of the external flash for details.

Monitor/Viewfinder Displays









- The following images are examples of when the display screen is set to  (monitor style) in the monitor.

In recording

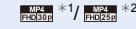

	Automatic viewfinder/ monitor switching (P56)
	Peaking (P153)
	Highlight Shadow (P124)
	HDR (P136)
	Multi exposure (P182)
	Electronic shutter (P165)

1

	Recording Mode (P61)
C 1	Custom settings (P120)
	Photo Style (P122)
	Creative control adjustment display (P108)
	Flash Mode (P201)
	Flash triggering (P204)
	resolution (P207)
	Resolution/Aspect Ratio (P131)
	Card (displayed only during recording) (P29)
8m30s	Elapsed recording time ^{*3} (P210)
	Simultaneous recording indicator (P214)

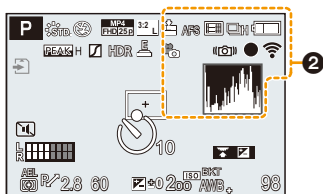

2

RAW	Compression rate (P133)
120fps *1/ 100fps *2	High Speed Video (P119)
AFS AFF AFC MF	Focus Mode (P140)
	AF Metering Mode (P139)
	Face Recognition (P185)
AFL	AF Lock (P158)
	Frame rate (P168)
	Auto Bracket (P171)
	Self-timer (P173)
	Time Lapse Shot (P174)
	Stop Motion Animation (P178)
	Battery indication (P24)
	Picture Mode (Still picture priorities) (P214)
	Luminance Level (P217)
AF	Macro recording (P156)
	Level Shot (P217)

	Optical Image Stabilizer (P193)
	Camera shake alert (P193)
	Recording state (Flashes red.)/Focus (Lights green.) (P58)
	Focus (Under low illumination) (P58)
	Connected to Wi-Fi
	Histogram (P65)

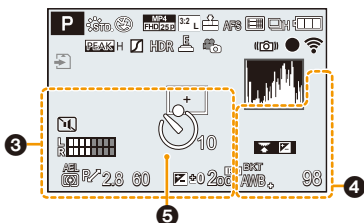

3	Name* ⁴ (P190)
	Number of days that have passed since the departure date* ⁴ (P47)
	Age* ⁴ (P190)
	Location* ⁴ (P47)
	Current date and time/Travel destination setting* ⁴ : (P46)
	AF area (P58, 146)
	Spot metering target (P164)
	Self-timer* ⁵ (P173)
	Silent Mode (P184)
	Zoom Microphone (P219)
	Mic Level display (P218)
	Mic Level Limiter (OFF) (P218)
	AE Lock (P158)
	Exp. metering mode (P164)
	Program Shift (P85)
2.8	Aperture value (P58)
60	Shutter speed (P58)

*1 With camera models 18 194 / 18 195

*2 With camera models 18 193 / 18 196

*3 m: minute, s: second

*4 This is displayed for about 5 seconds when the camera is turned on, after setting the clock and after switching from Playback to Recording Mode.

*5 This is displayed during countdown.

*6 It is possible to switch the display between the number of recordable pictures and available recording time with the [Remaining Disp.] setting in the [Custom] menu.

	Exposure compensation value (P160)
	Brightness (P83)
	Manual Exposure Assistance (P89)
200 ^{ISO}	ISO sensitivity (P161)
4	
	Dial operation guide (P18)
	White Balance Bracketing (P130)
	White Balance Fine Adjustment (P129)
	White Balance (P126)
	Color (P83)
98	Number of recordable pictures* ⁶ (P31)
R8m30s	Available recording time* ^{3,6} (P32)
5	
	Shutter speed/Aperture indication (P84)
	Zoom range (P198)

On-monitor recording information

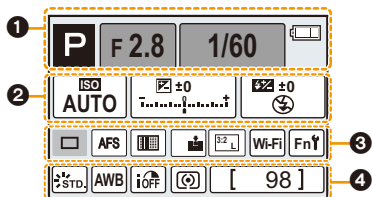

1

	Recording Mode (P61)
F2.8	Aperture value (P58)
1/60	Shutter speed (P58)
	Battery indication (P24)

2

	ISO sensitivity (P161)
	Exposure compensation value (P160)
	Brightness (P83)
	Manual Exposure Assistance (P89)
	Flash Mode (P201)
	Flash Exp. Comp./triggering (P204)

3

	Single (P167)
	Burst (P168)
	Auto Bracket (P171)
	Self-timer (P173)

	Time Lapse Shot (P174)
	Stop Motion Animation (P178)
AFS AFF AFC MF	Focus Mode (P140, 151)
	AF Metering Mode (P139)
	Quality (P133)
	Resolution/Aspect Ratio (P131)
Wi-Fi	Wi-Fi (P246)
	Function button setting (P43)

4

	Photo Style (P122)
	White Balance (P126)
	Intelligent Dynamic Range Control (P135)
	Metering Mode (P164)
98	Number of recordable pictures (P31)
R8m30s	Available recording time (P32)

In playback

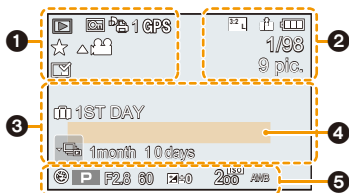

1

	Playback Mode (P225)
	Protected picture (P242)
	Number of prints (P240)
GPS	Location Information display (P226)
	Favorites (P239)
	Cable disconnect prohibit icon (P285)
	Motion picture playback (P70)
	Play panorama (P106)
	Picture Series Group Playback (P220)
	Continuous [Time Lapse Shot] Picture Group Playback (P220)
	Continuous playback of the Stop Motion Animation Group (P220)
	Stamped with text indication (P231)
8m30s	Elapsed playback time*1 (P70)

2

	Resolution/Aspect Ratio (P131)
	Recording quality (P207)
	Compression rate (P133)

120fps ^{*2/} 100fps ^{*3}	High Speed Video (P119)
	Luminance Level (P217)
	Battery indication (P24)
1/98	Picture number/Total pictures
9 pic.	Number of pictures in series
8m30s	Motion picture recording time*1 (P70)

3

	Currently retrieving information icon (P299)
	Number of days that have passed since the departure date (P47)
	Picture Series Group Display (P221)
	[Time Lapse Shot] Picture Group Display (P221)
	Display for the Stop Motion Animation Group (P221)
	Silent Mode (P184)
1 month 10days	Age (P190)

4

Name*4	(P188, 190)
Location*4	(P47)
Title*4	(P230)

5

Recording information

Detailed information display

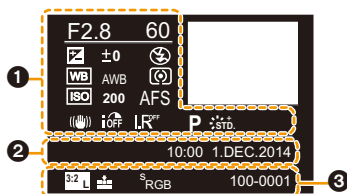

1	Recording information
	Intelligent Dynamic Range Control (P135)
	HDR*5 (P136)
	Intelligent Resolution (P135)
2	Recorded date and time/World Time (P46)

	Resolution/Aspect Ratio (P131)
	Compression rate (P133)
*2/ *3	resolution (P207)
120fps *2/ 100fps *3	High Speed Video (P119)
	Luminance Level (P217)
	Color space*5 (P138)
100-0001	Folder/File number (P282)

Histogram display

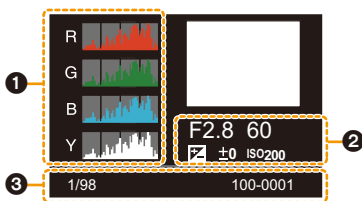

1	Histogram (P71)
2	Recording information

3	1/98	Picture number/Total pictures
	100-0001	Folder/File number (P282)

*1 m: minute, s: second

*2 With camera models 18 194 / 18 195

*3 With camera models 18 193 / 18 196

*4 It is displayed in order of [Title], [Location], [Name] ([Baby1]/[Baby2], [Pet]), [Name] ([Face Recog.]).

*5 This is not displayed for motion pictures.

Message Displays

Confirmation or error messages will be displayed on the screen in some cases. The major messages are described below as examples.

[This picture is protected]

- Delete the picture after canceling the protect setting. (P242)

[Some pictures cannot be deleted]/[This picture cannot be deleted]

- Pictures not based on the DCF standard cannot be deleted.
Perform formatting (P30) on the camera after saving necessary data on a computer, etc.

[Cannot be set on this picture]

- [Title Edit], [Text Stamp] or [Print Set] cannot be set for pictures not based on the DCF standard.

[Memory Card Error Format this card?]

- The card has been formatted in a way that cannot be used with the camera.
 - Insert a different card.
 - Format the card again with the camera after saving necessary data on a computer etc. (P30)
Data will be deleted.

[Please turn camera off and then on again]/[System Error]

- This is displayed when the lens has stopped operating normally due to being obstructed by a hand etc.
Turn the camera off and on. If the message persists, contact your Leica dealer or the nearest Leica Customer Care center.

[Memory Card Error]/[This memory card cannot be used]

- Use a card compatible with this camera. (P29)

[Insert SD card again]/[Try another card]

- An error has occurred accessing the card.
Insert the card again.
- Insert a different card.

[Read Error/Write Error Please check the card]

- The camera has failed to read or write data.
Remove the card after turning the camera off. Insert the card again, the camera unit on, and try to read or write the data again.
- The card may be damaged.
- Insert a different card.

[Cannot record due to incompatible format(NTSC/PAL) data on this card.]

- Perform formatting (P30) on the camera after saving necessary data on a computer, etc.
- Insert a different card.

[Motion recording was cancelled due to the limitation of the writing speed of the card]

- Depending on the [Rec Quality] of a motion picture, the speed class rating required for the card differs. Use a card that meets the rating. For details, refer to “About motion picture recording and speed class” on P29.
- If the recording stops even when you are using a card that meets the speed class rating, the data writing speed is too slow. We recommend making a backup and then to format the card (P30).

Depending on the type of the card, motion picture recording may stop in the middle.



[A folder cannot be created]

- A folder cannot be created because there are no remaining folder numbers that can be used. Format the card on the camera after saving necessary data on a computer etc. (P30)
If you execute [No.Reset] in the [Setup] menu after formatting, the folder number is reset to 100. (P53)

[Picture is displayed for 16:9 TV]/[Picture is displayed for 4:3 TV]

- Select [TV Aspect] in the [Setup] menu if you want to change the TV aspect ratio. (P51)
- This message also appears when the USB connection cable is connected to the camera only. If the other end of the USB connection cable is connected to a computer or printer, the message will disappear. (P281, 284)

[Editing operation cannot proceed as information processing is ongoing.]

When there are too many image files, the currently retrieving information icon () or ) may be displayed on the playback screen for a long period of time. During this time, use of some items in the [Playback] menu is not possible.

- If the camera is turned off while acquiring information, only the pictures that have already acquired the information are saved as a group.

When you turn on again, the information retrieval will restart from the same point.

[This battery cannot be used]

- Use a genuine Leica battery. If this message is displayed even when a genuine Leica battery is used, contact your Leica dealer or the nearest Leica Customer Care center.
- If the battery terminal is dirty, clean it and remove any objects.

[Failed to connect wireless access point]/[Connection failed]/[No destination found]

- Check following regarding the wireless access point.
 - The wireless access point information set on the camera is wrong.
 - Check the authentication type, encryption type, and encryption key. (P266)
 - Power of the wireless access point is not turned on.
 - Setting of the wireless access point is not supported by the camera.
- Check the network setting of the destination.
- Radio transmission from other devices may block the connection to a wireless access point. Check other devices that are connected to the wireless access point and devices that use the 2.4 GHz band.

[No picture to send]

- This is displayed when there is no image to transmit due to the restriction of the destination. Check the file format of the image to send. (P261)

[Connection failed. Please retry in a few minutes.]/[Network disconnected. Transfer stopped.]

- Radio transmission from the wireless access point are getting weak. Perform the connection closer to the wireless access point.
- There is no reply from the server or the communication processing time is exceeded. Try again after a while.
- Depending on the wireless access point, connection may be automatically disconnected after a specific time has passed. Reconnect.

[Connection failed]

- Check following regarding the smartphones you intend to connect.
 - The smartphone does not operate.
 - Change the access point to connect to in the smartphone Wi-Fi settings to this camera.
 - There is no free storage space on the smartphone.

[Some files cannot be sent because of destination limit]/[Transfer completed. Some files are left because of destination limit.]

- Check the file format of the image to send. (P261)
- Sending motion pictures may fail if the file size is too large.
 - Split the motion picture using [Video Divide]. (P234)

[Cannot get IP address. Please set wireless AP's IP address setting to DHCP.]

- Turn on DHCP settings of the IP address of the connected wireless access points.

[Cannot connect to server]

- If a message is displaying asking to update the root certificate, agree to update the root certificate.

Menu list

[Rec]

This menu lets you set the aspect ratio, resolution and other aspects of the pictures you are recording.

- [Photo Style], [AFS/AFF], [Metering Mode], [Highlight Shadow], [i.Dynamic], [i.Resolution], [i.Zoom] and [Digital Zoom] are common to both the [Rec] menu and [Motion Picture] menu. Changing these settings in one of these menus is reflected in other menu.

[Photo Style]	You can select effects to match the type of image you wish to record. You can adjust the color and image quality of the effects.	P122
[Aspect Ratio]	Sets the aspect ratio of the image.	P131
[Picture Size]	Set the resolution.	P132
[Quality]	Set the compression rate at which the pictures are to be stored.	P133
[AFS/AFF]	Assigns [AFS] or [AFF] to [AFS/AFF] of the focus mode lever.	P140
[Metering Mode]	Sets the exposure metering method.	P164
[Burst Rate]	Sets the frame rate for continuous recording.	P168
[Auto Bracket]	Sets single/continuous recording, compensation range and recording sequence for Auto Bracket recording.	P171
[Self Timer]	Sets the manner in which the self-timer works.	P173
[Time Lapse/Animation]	Makes the recording settings for Time Lapse Shot and Stop Motion Animation.	P174, P178
[Highlight Shadow]	You can adjust the brightness of bright and dark sections of an image while checking the results on the screen.	P124
[i.Dynamic] (Intelligent dynamic range control)	Adjusts the contrast and exposure.	P135
[i.Resolution]	Records pictures with more defined outlines and sense of clarity.	P135
[i>Handheld Night Shot]	Pictures of the night scenery will be taken in quick succession and composed into a single picture.	P80
[iHDR]	There is, for example, strong contrast between the background and the main subject, multiple still pictures are recorded with differing exposures and combined to create a single still picture rich in gradation.	P81

[HDR]	You can combine 3 pictures with different levels of exposure into a single picture with rich gradation.	P136
[Multi Exp.]	Gives an effect like multi exposure. (up to 4 times equivalent per a single image)	P182
[Panorama Settings]	Sets the recording direction and image effect for panorama recording.	P104
[Shutter Type]	You can choose between taking pictures with the mechanical or the electronic shutter.	P165
[Flash]	Sets the manner in which the flash works.	P201
[Red-Eye Removal]	Automatically detects red-eye caused by the flash and corrects the image data accordingly.	P206
[ISO Limit Set]	When the ISO sensitivity is set to [AUTO] or [ISO], an optimal ISO sensitivity is set with the selected value as an upper limit.	P163
[ISO Increments]	The ISO sensitivity settings values changes in steps of 1/3EV or 1EV.	P163
[Extended ISO]	You can extend the available ISO sensitivity values.	P163
[Long Shtr NR]	You can eliminate the noise caused by recording with a slower shutter speed.	P137
[i.Zoom]	You can extend the focal length setting/zoom range with minimum image deterioration.	P196
[Digital Zoom]	Increases the focal length/zoom magnification. The higher the level of magnification, the greater the degradation in image quality.	P197
[Color Space]	Set this when you want to correct the color reproduction of the recorded pictures on a computer, printer etc.	P138
[Stabilizer]	When camera shake is sensed during recording, the camera compensates automatically.	P193
[Face Recog.]	Sets focus and exposure automatically prioritizing registered faces.	P185
[Profile Setup]	If you set the name and birthday of a child or pet in advance, you can record their name and age in months and years in the images.	P190

[Motion Picture]

This menu lets you set the [Rec Quality], and other aspects for motion picture recording.

- [Photo Style], [AFS/AFF], [Metering Mode], [Highlight Shadow], [i.Dynamic], [i.Resolution], [i.Zoom] and [Digital Zoom] are common to both the [Rec] menu and [Motion Picture] menu.

Changing these settings in one of these menus is reflected in other menu.

– For details, refer to the explanation for the corresponding setting in the [Rec] menu.

[Rec Quality]	This sets up the picture quality of motion pictures.	P207
[Exposure Mode]	For selecting the method for setting the aperture value and shutter speed in Creative Video Mode.	P118
[High Speed Video]	You can record slow motion pictures by performing ultra-high-speed recording.	P119
[Picture Mode]	Sets the recording method for still pictures during motion picture recording.	P214
[Continuous AF]	Focusing continues whenever the targeted subject changes its distance to the camera.	P209
[Level Shot]	The camera automatically detects its tilt and corrects the motion pictures you record to a level position to prevent them from being skewed.	P217
[Luminance Level]	For selecting the luminance range to match the use of video.	P217
[Flikr Decrease]	The shutter speed can be fixed to reduce the flicker or striping in the motion picture.	P217
[Mic Level Disp.]	For setting whether or not the mic levels are displayed on the recording screen.	P218
[Mic Level Adj.]	Allows adjusting the sound input level to 19 different levels.	P218
[Mic Level Limiter]	Adjusts the sound input level automatically.	P218
[Wind Cut]	You can reduce the wind noise effectively when recording with sound.	P219
[Zoom Mic]	Couples the microphone's recording characteristics to the zoom operation, it will clearly record far sounds with tele, and surrounding sounds with wide.	P219

[Custom]

Operation of the camera, such as displaying of the screen and button operations, can be set up according to your preferences. Also, it is possible to register the modified settings.

[Cust.Set Mem.]	Registers the current camera settings as custom set.	P120
[Silent Mode]	Disables operational sounds and output of light at once.	P184
[AF/AE Lock]	Sets the fixed content for focusing and exposure when the AF/AE lock is on.	P158
[AF/AE Lock Hold]	This will set the operation of [AF/AE LOCK] button when taking a picture with fixed focus or exposure.	P159
[Shutter AF]	Sets whether or not focusing is started automatically when the shutter button is pressed halfway.	P149
[Half Press Release]	The shutter will immediately fire when the shutter button is pressed halfway.	P149
[Quick AF]	Speeds up the focusing that takes place when you press the shutter button.	P149
[Eye Sensor AF]	The camera automatically adjusts the focus setting when the eye sensor is active.	P57
[Pinpoint AF Time]	Sets the time for which the screen is enlarged when the shutter button is pressed halfway with Autofocus Mode set to [+] .	P148
[AF Assist Lamp]	The AF assist lamp will illuminate the subject when the shutter button is pressed half-way, making it easier for the camera to focus in low light conditions.	P150
[Direct Focus Area]	Moves the AF area or MF assist using the cursor buttons.	P148, P154
[Focus/Release Priority]	Pictures can only be taken when focusing is successful.	P150
[AF+MF]	You can adjust the focus manually after the automatic focusing has finished.	P150
[MF Assist]	Sets the display method of MF Assist (enlarged screen).	P152
[MF Guide]	When you focus manually, an MF guide that allows you to check the setting is displayed.	P153
[Peaking]	In-focus sections are highlighted during manual focusing.	P153

[Histogram]	This allows you to set either to display or not display the histogram.	P65
[Guide Line]	This will set the pattern of guide lines displayed when taking a picture.	P65
[Center Marker]	Displays [+], which indicates the center of the recording screen.	P191
[Highlight]	When the Auto Review function is activated or when playing back, white saturated areas appear flashing in black and white.	P72
[Zebra Pattern]	Indicates sections that will be totally overexposed by a zebra pattern.	P191
[Monochrome Live View]	You can display the monitor image in black and white.	P192
[Constant Preview]	You can check the effects of the chosen aperture and shutter speed on the recording screen in Manual Exposure Mode.	P90
[Expo.Meter]	Set whether or not to display the shutter speed/aperture indication.	P84
[Dial Guide]	Set whether or not to display the dial operation guide.	P18
[EVF Disp.Style]	This will set the display style of the viewfinder.	P64
[Monitor Disp. Style]	This will set the display style of the monitor.	P63
[Monitor Info. Disp.]	Displays the recording information screen.	P65
[Rec Area]	This changes the angle of view during motion picture recording and still picture recording.	P211
[Remaining Disp.]	This will switch display between the number of recordable pictures and available recording time.	P33
[Auto Review]	For setting the length of time that the picture is displayed after taking the still picture.	P59
[Fn Button Set]	You can assign frequently-used functions to particular buttons.	P43
[Zoom Lever]	Changes the zoom lever operation.	P198
[Manual ring (Zoom)]	Changes the Zoom/MF ring operation.	P198
[Zoom Resume]	Saves the zoom position when you turn off the camera.	P198

[Q.MENU]	Switches the setting method of Quick Menu.	P40
[Video Button]	Enables/disables the motion picture button.	P211
[Eye Sensor]	For setting the eye sensor sensitivity and the method for switching between the monitor and viewfinder.	P57
[Menu Guide]	Sets the screen that is displayed when the mode dial is set to SCN and COL .	P62

[Setup]

This menu lets you perform the clock settings, select the operating beep tone settings and other settings.

You can also configure the settings of Wi-Fi related functions.

[Clock Set]	For setting Date/Time.	P34
[World Time]	For setting the times for the region where you live and your holiday destination.	P46
[Travel Date]	Departure date and return date of the trip as well as the name of the travel destination can be set.	P47
[Wi-Fi]	For configuring the each setting for Wi-Fi functions.	P272
[Beep]	For setting the volume for electronic noises and the electronic shutter noise.	P48
[Live View Mode]	For setting the frame rate of the recording screen (Live View screen).	P48
[Monitor Display]/ [Viewfinder]	Brightness, color, or red or blue tint of the monitor/viewfinder can be adjusted.	P48
[Monitor Luminance]	For setting the monitor brightness to suit the amount of surrounding light.	P49
[Economy]	For reducing the camera's power consumption to prevent the battery from being run down.	P50
[USB Mode]	For setting the communication method when connecting using the USB connection cable.	P50
[TV Connection]	This sets how the camera connects to a television etc.	P51
[Menu Resume]	Stores the location of the last-used menu item for each menu.	P52
[Menu Information]	Descriptions of menu items or their settings are displayed on the menu screen.	P52

[Language]	For setting the language displayed on the screen.	P52
[Version Disp.]	It is possible to check which version of firmware is on the camera.	P53
[Exposure Comp. Reset]	An exposure value can be reset when the Recording Mode is changed or the camera is turned off.	P53
[No.Reset]	Returns the image file number to 0001.	P53
[Reset]	The recording or setup/custom settings are reset to the default.	P53
[Reset Wi-Fi Settings]	For resetting all settings in the [Wi-Fi] menu to factory default settings.	P53
[Format]	Allows the card to be formatted.	P30

[Playback]

This menu lets you set the Protection, Cropping or Print Settings, etc. of recorded pictures.

[Slide Show]	Selects the type etc. of the images and plays back in order.	P223
[Playback Mode]	Selects the type etc. of the images and plays back only particular images.	P225
[Location Logging]	You can write location information (longitude/latitude) on images sent from the smartphone.	P226
[RAW Processing]	You can convert the pictures taken in the RAW format into the JPEG format on the camera.	P227
[Title Edit]	For entering texts (comments) on the recorded pictures.	P230
[Text Stamp]	Stamps the recorded pictures with recording date and time, names, travel destination, travel date, etc.	P231
[Video Divide]	Splits the recorded motion picture in two.	P234
[Time Lapse Video]	Creates a motion picture from a set of group pictures recorded with the [Time Lapse Shot].	P235
[Stop Motion Video]	Creates a motion picture from the Stop Motion Animation group.	P235
[Resize]	Reduces the resolution (number of pixels).	P236
[Cropping]	Crops the recorded image.	P237
[Rotate]	Rotate pictures manually in 90° steps.	P238
[Rotate Disp.]	This mode allows you to display pictures vertically if they were recorded holding the camera vertically.	P238
[Favorite]	Allows images to be marked as favorites.	P239
[Print Set]	Sets the images for printing and the number of prints.	P240
[Protect]	Protects images to prevent deletion by mistake.	P242
[Face Rec Edit]	Removes or changes information relating to personal identity.	P243
[Picture Sort]	Sets the display order of the images you play back on the camera.	P243
[Delete Confirmation]	This sets which option, [Yes] or [No], will be highlighted first when the confirmation screen for deleting a picture is displayed.	P244

Troubleshooting

First, try out the following procedures (P311–P325).

If the problem is not resolved, it may be improved by selecting [Reset] (P53) in the [Setup] menu.

Battery and power source

**The camera cannot be operated even when it is turned on.
The camera turns off immediately after it is turned on.**

- The battery is exhausted.
→ Charge the battery.
- If you leave the camera on, the battery will be discharged.
→ Turn the camera off frequently by using [Economy] etc. (P50)

The camera is turned off automatically.

- Is the linked operation of HDTV Link enabled?
→ If you are not using HDTV Link, set [HDTV Link] to [OFF]. (P52)

The card/battery door does not close.

- Insert the battery correctly all the way in. (P27)

The battery discharges too quickly.

- Is a Wi-Fi connection being used for a long period of time?
The battery can discharge quickly when connected to Wi-Fi.
→ Turn the camera off frequently by using [Economy] etc. (P50)

Recording

**Taking pictures is not possible.
The shutter will not operate immediately when the shutter button is pressed.**

- Is the subject focused?
→ Is [Focus/Release Priority] in the [Custom] menu set to [FOCUS]? (P150)
You cannot take a picture until the subject is brought into focus.

The recorded picture is whitish.

- Pictures might look whitish when lens front surface is soiled with fingerprints or similar.
→ If the lens is dirty turn the camera off and then gently wipe the lens surface with a soft, dry cloth.

The main subject is too bright or dark.

- Check if an exposure compensation may be necessary. (P160)
- Is the AE Lock (P158) applied incorrectly?

Multiple pictures are taken at one time.

- Cancel the following settings:
 - Continuous/Auto Bracket/[] of the self-timer (P167)
 - White Balance Bracket (P130)

The subject is not focused properly.

- The subject is beyond the focus range of the camera. (P59)
- The camera may not be held still enough or the subject may be moving slightly. (P193)
- Is [Focus/Release Priority] in the [Custom] menu set to [RELEASE]? (P150)
- Is [Shutter AF] in the [Custom] menu set to [OFF]? (P149)
- Is the AF Lock (P158) applied incorrectly?

**The recorded picture is blurred.
The Optical Image Stabilizer is not effective.**

- The shutter speed will be slower and the Optical Image Stabilizer function may not work properly when taking pictures especially in dark places.
 - We recommend holding the camera firmly with both hands when taking pictures. (P55)
 - We recommend using a tripod and the self-timer (P173) when taking pictures with a slow shutter speed.

Taking pictures using White Balance Bracket is not possible.

- Is there any memory remaining on the card?

**The recorded picture looks grainy.
Noise appears on the picture.**

- Try the following:
 - Take pictures in bright places.
 - Decrease the ISO sensitivity. (P161)
 - Increase the setting for [Noise Reduction] in [Photo Style] or lower the setting for each of the items other than [Noise Reduction]. (P123)
 - Set [Long Shtr NR] to [ON]. (P137)
- Is [Picture Size] (P132) or [Quality] (P133) set low?
- Is [Digital Zoom] set? (P197)

Striping or flicker may appear under lighting such as fluorescent lighting and LED lighting fixtures.

- This is characteristic of MOS sensors which serve as the camera's pickup unit.
This is not a malfunction.
- Are you taking pictures with the electronic shutter? (P165)
 - When using the electronic shutter, lowering the shutter speed may reduce the effect of the horizontal stripes.



The brightness or the hue of the recorded picture is different than in reality.

- When recording under fluorescent or LED lighting fixtures, etc., increasing the shutter speed may introduce slight changes to brightness and color. These are a result of the characteristics of the light source and do not indicate a malfunction.
- When recording subjects in extremely bright locations or recording under fluorescent lighting, LED lighting fixtures, mercury lamps, sodium lighting, etc., the colors and screen brightness may change or horizontal striping may appear on the screen.

**The subject cannot be locked.
(AF tracking not possible)**

- Set the AF area to the distinctive color of the subject if there is a part that is different from the surrounding color. (P142)

Playback sound is too quiet.

- Is your finger covering the speaker? (P14)

Motion pictures

Recording motion pictures is not possible.

- You may not be able to record for a short while after turning the camera on when using a large capacity card.

Motion picture recording stops unexpectedly.

- Depending on the [Rec Quality] of a motion picture, the speed class rating required for the card differs. Use a card that meets the rating. For details, refer to "About motion picture recording and speed class" on [P29](#).
- When a card with a slow data writing speed is used, motion picture recording may stop midway.
→ If a card on which recording and deleting have been repeated many times or a card that has been formatted on a computer or other equipment is being used, we recommend that you make a backup of the data and format ([P30](#)) the card on the unit.

When recording a motion picture, the screen may go dark.

- When recording a motion picture, the screen may go dark after a certain period to reduce battery consumption, but this will not affect the recorded motion picture.

The screen may be blacked out momentarily, or the unit may record noise.

- Depending on the environment at the time of motion picture recording, the screen may be blacked out momentarily or the camera may record noise due to static electricity or powerful electromagnetic radiation (radio towers, high voltage power lines, etc.).

Striping or flicker appears under lighting such as a fluorescent or LED lighting fixtures.

The subject appears distorted.

- This is characteristic of MOS sensors like the one in this camera.
This is not a malfunction.
When a subject moves across the frame very fast, the subject may appear slightly distorted.
- When noticeable flicker or striping is seen under lighting such as a fluorescent or LED lighting fixtures, you can reduce the flicker or striping by setting up [Flkr Decrease] ([P217](#)) and fixing the shutter speed. It is possible to select a shutter speed from [1/50], [1/60], [1/100], or [1/120]. You can set the shutter speed manually in Creative Video Mode. ([P118](#))

In motion pictures, unexpected clicking and buzzing sounds are recorded.

The recorded sound is very quiet.

- When recording in a quiet environment, the sound of aperture, focus or zoom operation may be recorded in motion pictures.
Focus operation can be set to [OFF] in [Continuous AF] ([P209](#)).
- While recording motion pictures, obstructing the microphone receiver areas with a finger may reduce the level of audio recording or audio may not record at all. Also be careful because the operation sound of lens movements (zooming/focusing) can easily be recorded.

An operational sound is recorded at the end of a motion picture.

Since motion picture recording stops only after you press the motion picture button, the sound of the operation may be noticeable. If this bothers you, try the following:

→ Cut off the last part of the motion picture using [Video Divide] (P234) in the [Playback] menu.

It may not be possible to cut off the motion picture near its very end. To avoid this, record approximately 3 seconds longer.

Flash

The flash does not fire.

- Is the flash closed?
→ Open the flash. (P199)
- When the electronic shutter is used, the flash is not triggered. (P165)
→ Set [Shutter Type] to [AUTO] or [MSHTR].
- When [Silent Mode] is set to [ON], the flash is not triggered. (P184)
→ Set [Silent Mode] to [OFF].

The flash is fired 2 times.

- (Except for when [Firing Mode] in [Flash] is set to [MANUAL]) The flash is fired 2 times. The interval between the first and second flash is longer when Red-Eye Reduction (P201) is set so the subject should not move until the second flash is activated.

Monitor/Viewfinder

The Monitor/Viewfinder turns off although the camera is turned on.

- If no operations are performed during the set time period, [Auto EVF/Monitor Off] (P50) is activated, and the Monitor/Viewfinder turns off.
- When an object or your hand is positioned near the eye sensor, the Monitor display may switch to the Viewfinder display. (P56)

The Monitor/Viewfinder is too bright or dark.

- Check [Monitor Luminance] setting. (P49)
- Perform [Monitor Display]/[Viewfinder]. (P48)

The monitor image may flicker for an instant or its brightness may change significantly for an instant.

- This occurs due to the aperture of the lens changing when the shutter button is pressed halfway, or when the brightness of the subject changes. This is not a malfunction.

The picture is not displayed on the monitor.

- Does the picture appear on the viewfinder?
→ Press [EVF] to switch to monitor display. (P56)
- Is the monitor switched off?
→ Switch the display by pressing [DISP]. (P63)

Monitor and viewfinder do not switch when [EVF] is pressed.

- The image is displayed on the monitor only when the camera is connected to a computer or printer.

Black, white, red, blue and green dots appear on the Monitor/Viewfinder.

- This is not a malfunction.
These pixels do not affect the recorded pictures.

Noise appears on the monitor.

- In dark places, noise may appear because the image data is amplified to maintain its brightness.

Unevenly bright parts or irregular colors appear on the viewfinder image.

- The viewfinder of the camera uses OLED technology. Therefore, screen burn-in may occur on the screen when a same image is displayed for a long period of time, but it does not affect the recorded images.

Playback

The picture being played back is not rotated, or is rotated in a wrong direction, when displayed.

- You can display the pictures without being rotated when [Rotate Disp.] (P238) is set to [OFF].
- You can rotate pictures with the [Rotate] function. (P238)

**The picture is not played back.
There are no recorded pictures.**

- Is the card inserted?
- Is there a picture on the card?
- Is this a folder or picture which was processed in the computer?
If it is, it cannot be played back by this camera.
- Has [Playback Mode] been set for playback?
→ Change to [Normal Play]. (P225)

The folder number and the file number are displayed as [—] and the screen turns black.

- Is this a non-standard picture, a picture which has been edited using a computer or a picture which was taken by another make of digital camera?
- Did you remove the battery immediately after picture-taking or did you take the picture using a battery with a low remaining charge?
→ To delete such pictures, make a backup of the data and format the card (P30).

Playback sound or operation sound is too low.

- Is something covering up the speaker? (P14)

Images with a different date than the recorded date are played back in Calendar Playback.

- Is the clock in the camera set properly? (P34)
- Images edited on a computer or images recorded on other cameras might display a different date to the recorded date during the Calendar Playback.

White round spots like soap bubbles appear on the recorded picture.



- If you take a picture with flash in a dark place or indoors, white round spots may appear on the picture caused by the reflections of particles of dust in the air. This is not a malfunction.



[Thumbnail is displayed] appears on the screen.

- Is it a picture that has been recorded with other equipment?
In such cases, these pictures may be displayed with a deteriorated picture quality.

Red parts of the recorded image have changed color to black.

- When Red-Eye Removal ([] or []) is performed, red parts may be corrected to black.
→ It is recommended to take a pictures with the flash closed, Flash Mode set to [], or [Red-Eye Removal] set to [OFF]. (P206)

Motion pictures recorded with this camera cannot be played back on other equipment.

- The picture quality or sound quality of recorded motion pictures may be deteriorated even when these are played back with compatible devices. Also, recording information may not be displayed correctly.

Wi-Fi function

**A Wi-Fi connection cannot be established.
Radio transmission gets disconnected.
The wireless access point is not displayed.**

■ General tips for using a Wi-Fi connection

- Try [Reset Wi-Fi Settings] in the [Setup] menu.
- Use within the communication range of the device to be connected.
- Is any device, such as microwave oven, cordless phone, etc., that uses 2.4 GHz frequency operated nearby?
 - Radio waves may get interrupted when used simultaneously. Use the camera sufficiently away from such devices.
- When the battery indicator is flashing red, the connection with other equipment may not start or the connection may be disrupted.
(A message such as [Communication error] is displayed.)
- If you place the camera on a metal table or shelf, the radio transmission may be adversely affected. In such cases, you may not be able to establish a connection. Move the camera away from the metal surface.

■ About a wireless access point

- Check if the wireless access point to connect is in operating state.
- The camera may not display or connect to a wireless access point depending on the radio wave condition.
 - Move the camera closer to the wireless access point.
 - Remove the obstacles between the camera and the wireless access point.
 - Change the direction of the camera.
 - Change the location and orientation of the wireless access point.
 - Perform [Manual Input]. (P266)
- It may not display even if the radio waves exist depending on the setting of the wireless access point.
 - Check the settings of the wireless access point.
 - When the network SSID of the wireless access point is set not to broadcast, the wireless access point may not be detected. Enter the network SSID to start the connection (P266) or enable the SSID broadcast of the wireless access point.
- Connection types and security setting methods are different depending on the wireless access point. (Refer to the instructions of the wireless access point.)
- Is the 5 GHz/2.4 GHz switchable wireless access point connected to other equipment using the 5 GHz band?
 - The use of a wireless access point that can use 5 GHz/2.4 GHz simultaneously is recommended. It cannot be used simultaneously with this camera if it is not compatible.

It takes long time every time to connect to a smartphone.

- It may take longer time to connect depending on the Wi-Fi connection setting of the smartphone, but it is not a malfunction.

The camera is not displayed in the Wi-Fi setting screen of the smartphone.

- From the Wi-Fi setting menu on the smartphone, turn off and then on the Wi-Fi function.

I have forgotten the password for the Wi-Fi.

- Execute the [Reset Wi-Fi Settings] in the [Setup] menu. (P53)
However, all the information you have set on the [Wi-Fi Setup] menu will be reset.

The camera cannot be connected using NFC.

- Is your smartphone compatible with NFC?
→ The camera can be used with NFC-compatible terminals via Android (OS version 2.3.3 or higher).
- Make sure the NFC function of your smartphone is ON.
- Is [NFC Operation] set to [OFF]? (P272)
- Some smartphones cannot be easily checked simply by touching.
→ If the camera is not recognized even after touching, change positions and try again by touching slowly.
- If the duration of touching is short, the smartphone may not be recognized.
→ Touch and hold the smartphone for a while.

TV, computer and printer

The picture does not appear on the television.

- Is the camera connected to the TV correctly?
→ Set the TV input to external input mode.

The picture is not displayed fully on the TV.

The display areas on the TV screen and the camera's monitor are different.

- Check the [TV Aspect] setting. (P51)
- Depending on the TV model, the pictures may be extended horizontally or vertically or they may be displayed with their edges cut off.

The motion pictures cannot be played back on a TV.

- Are you trying to play back the motion pictures by directly inserting the card in the card slot of the TV?
→ Connect the camera to the TV with an AV or an HDMI micro cable, and then play back the motion pictures on the camera. (P275)

Sound is not output from the speaker of the camera.

- When an AV or an HDMI micro cable is connected, sound is not output from the camera.

HDTV Link does not work.

- Is it connected properly with an HDMI micro cable? (P275)
- Is the [HDTV Link] on the camera set to [ON]? (P52)
 - If the input channel does not switch automatically, use the remote control for the TV to switch it.
 - Check the HDTV Link setting on the connected device.
 - Turn the camera off and on.
 - Set [HDAVI Control] to [Off] on the TV and then turn it back to [On].
(Refer to the instructions of the TV for details.)
 - Check [Video Out] setting. (P51)
(With camera models 18 193 / 18 196)

Cannot communicate with the computer.

- Is the camera recognized by the computer correctly?
 - Set to [PC] in [USB Mode]. (P50, 281)
 - Turn the camera off and on.

The card is not recognized by the computer.

- Disconnect the USB connection cable. Connect it again while the card is inserted in the camera.
- If there are two or more USB terminal on a single computer, try connecting the USB connection cable to another USB terminal.

**The card is not recognized by the computer.
(SDXC memory card is used.)**

- Check if your computer is compatible with SDXC memory cards.
- A message prompting to format the card may be displayed when connecting, but do not format.
- If the [Access] displayed on the monitor does not disappear, disconnect the USB connection cable after turning the camera off.

The picture cannot be printed when the camera is connected to a printer.

- Pictures cannot be printed using a printer that does not support PictBridge.
→ Set to [PictBridge(PTP)] in [USB Mode]. ([P50](#), [284](#))

The ends of the pictures are cut at printing.

- When using a printer with a Cropping or borderless printing function, cancel this function before printing.
(For details, refer to the instructions for the printer.)
- When you order photo studios to print pictures, ask them 16:9 pictures can be printed.

Others

There is a sound from the lens unit.

- It is a sound of lens movement or aperture operation when the camera is turned on or off, and it is not a malfunction.
- The sound, which is caused by the automatic adjustment of the aperture, is heard when the brightness has changed due to, for example, zooming or the movement of the camera. This is not a malfunction.

An unreadable language was selected by mistake.

- Press [MENU/SET], select the [Setup] menu icon [X] and then select the [00] icon to set the desired language. (P52)

Part of the picture is flashing in black and white.

- This is a highlight function showing the white saturated area. (P72)

A red lamp sometimes turns on when the shutter button is pressed halfway.

- In dark places, the AF Assist Lamp (P150) lights up in red to make it easier to focus on a subject.

Zooming stops instantaneously.

- When using the Extended Optical Zoom, the zooming action will stop temporarily. This is not a malfunction.

The AF Assist Lamp does not turn on.

- Is [AF Assist Lamp] set to [ON]? (P150)
- The AF Assist Lamp does not turn on in bright places.

The camera becomes warm.

- The surface of the camera and the reverse side of the monitor may become warm during use. This does not affect the performance or quality of the camera.

The clock is reset.

- If you do not use the camera for a long time, the clock may be reset.
→ [Please set the clock] message will be displayed; please reset the clock. (P34)

The file numbers are not recorded consecutively.

- When you perform an operation after taking a certain action, the pictures may be recorded in folders with different numbers from the ones used prior to the operation.

The file numbers are recorded with previously used numbers.

- If you insert or remove the battery before turning off the camera, the folder and file numbers for the pictures taken will not be stored in the memory. When the camera is turned on again and pictures are taken, they may be stored under file numbers which should have been assigned to previous pictures.

Cautions for Use

Optimal use of the camera

Keep the camera as far away as possible from electromagnetic equipment (microwave ovens, TVs, speakers, large motors, etc.).

- If you use the camera on top of or near a TV, the pictures and/or sound on the camera may be disrupted by electromagnetic wave radiation.
- Do not use the camera near cell phones because doing so may result in noise adversely affecting the pictures and/or sound.
- Recorded data may be damaged, or pictures may be distorted, by strong magnetic fields created by speakers or large motors.
- Electromagnetic wave radiation generated by microprocessors may adversely affect the camera, disturbing the pictures and/or sound.
- If the camera is adversely affected by electromagnetic equipment and stops functioning properly, turn the camera off and remove the battery. Then reinsert the battery and turn the camera on.

Do not use the camera near radio transmitters or high-voltage lines.

- If you record near radio transmitters or high-voltage lines, the recorded pictures and/or sound may be adversely affected.

Always use the supplied cords and cables.

If you use optional accessories, use the cords and the cables supplied with them.

Do not extend the cords or the cables.

Do not spray the camera with insecticides or volatile chemicals.

- If the camera is sprayed with such chemicals, the body of the camera may be damaged and the surface finish may peel off.

Do not keep rubber or plastic products in contact with the camera for a long period of time.

Cleaning

Before cleaning the camera, remove the battery, or disconnect the power plug from the outlet. Then wipe the camera with a dry, soft cloth.

- When the camera is soiled badly, it can be cleaned by wiping the dirt off with a wrung wet cloth, and then with a dry cloth.
- To wipe off the dust or dirt on the Zoom/MF ring, use a dry, dust-free cloth.
- Do not use solvents such as benzine, thinner, alcohol, kitchen detergents, etc., to clean the camera, since this may damage the body or cause its coating to peel off.
- When using a chemical cloth, be sure to follow the accompanying instructions.

■ For care of the eyecup on the viewfinder

- As the eyecup cannot be removed, gently wipe it with a dry and soft cloth, and be careful not to remove it.
- If you wipe the eyecup too hard and it is removed, consult your Leica dealer or the nearest Leica Customer Care center.

About the Monitor/Viewfinder

- Do not press the monitor with excessive force. Uneven colors may appear on the monitor and it may malfunction.
- If the camera is cold when you turn it on, the picture on the Monitor/Viewfinder will be slightly darker than usual at first. However, the picture will return to normal brightness when the internal temperature of the camera increases.

Extremely high precision technology is employed to produce the Monitor/Viewfinder screen. However there may be some dark or bright spots (red, blue or green) on the screen. This is not a malfunction. Though the Monitor/Viewfinder screen parts are produced with highly controlled precision technology, some pixels may be inactive or always lit. The spots will not be recorded on pictures on a card.

About the Lens

- Do not exert pressure on the lens.
- Do not leave the camera with the lens facing the sun as sunlight may cause it to malfunction. Also, be careful when placing the camera outside or near a window.
- When the lens' front surface is soiled (water, oil, and fingerprints, etc.), the picture may be affected. Lightly wipe the surface of the lens with a soft, dry cloth before and after taking pictures.
- Retract the lens when carrying the camera.

Battery

The battery is a rechargeable lithium ion battery. Its ability to generate power comes from the chemical reaction that takes place inside it. This reaction is susceptible to the surrounding temperature and humidity. If the temperature is too high or too low, the operating time of the battery will become shorter.

Always remove the battery after use.

- Place the removed battery in a plastic bag, and store or keep away from metallic objects (clips, etc.).

If you drop the battery accidentally, check to see if the body of the battery and the terminals are damaged.

- Inserting a damaged battery in the camera will damage the camera.

Bring charged spare batteries when going out.

- Be aware that the operating time of the battery becomes shorter in low temperature conditions such as at a ski resort.
- When you travel, do not forget to bring along the charger so that you can charge the battery in the country that you are traveling in.

Disposal of an unusable battery.

- The battery has a limited lifespan.
- Do not throw the battery into a fire because this may cause an explosion.

Do not allow battery terminals to come into contact with metal objects (such as necklaces, hairpins, etc.).

- This can cause short-circuiting or heat generation and you may be badly burned if you touch such a battery.

Charger

- The [CHARGE] indicator may flash under the influence of static electricity or electromagnetic radiation. This phenomenon has no effects on charging.
- If you use the charger near a radio, the radio reception may be disturbed.
Keep the charger 1m (3'3") or more away from a radio.
- The charger may generate whirring sounds when it is being used. This is not a malfunction.
- After use, be sure to disconnect the charger from the electrical outlet.
(A very small amount of current is consumed if it is left connected.)
- Keep the terminals of the charger and battery clean.

Card

Do not leave the card where the temperature is high, where electromagnetic radiation or static electricity are easily generated or exposed to direct sunlight.

Do not bend or drop the card.

- The card may be damaged or the recorded content may be damaged or deleted.
- Put the card in the card case or the storage bag after use and when storing or carrying the card.
- Do not allow dirt, dust, or water to get into the terminals on the back of the card and do not touch the terminals with your fingers.

Notice for when transferring to another party, or disposing of the memory card, to “Format” or “delete” using the camera or a computer will only modify the file management information, it will not erase the data in the memory card completely. It is recommended to physically destroy the memory card or use the commercially available computer data deletion software to completely erase the data in the memory card before transferring to another party or disposing.

Management of data in the memory card is the responsibility of the user.

About the personal information

If a name or birthday is set for [Profile Setup]/Face Recognition function, this personal information is kept in the camera and recorded in the image.

Setting a Wi-Fi password is recommended to protect personal information. (P273)

Disclaimer

- Information including personal information may be altered or vanish due to erroneous operation, effect of static electricity, accident, malfunction, repair, or other handlings. Please note in advance that Leica Camera AG is not liable in any way for any direct or indirect damage from the alteration or vanishing of information or personal information.

When requesting a repair, transferring to another party, or disposing.

- After making a copy of personal information, always delete such information as well as information and wireless LAN connection settings that you have saved within the camera with [Reset Wi-Fi Settings] (P53).
- Reset the settings to protect the personal information. (P53)
- Remove the memory card from the camera when requesting a repair.
- Settings may return to factory default when camera is repaired.
- Please contact the dealer where you purchased the camera or the nearest Leica Customer Care center if above operations are not possible due to malfunction.

When transferring to another party, or disposing of the memory card, please refer to “Notice for when transferring to another party, or disposing of the memory card, to”. (P329)

When not using the camera for a long period of time

- Store the battery in a cool and dry place with a relatively consistent temperature:
[Recommended temperature: 15°C to 25°C (59°F to 77°F), Recommended humidity: 40%RH to 60%RH]
- Always remove the battery and the card from the camera.
- If the battery is left inserted in the camera, it will discharge even if the camera is turned off. If the battery continues to be left in the camera, it will discharge excessively and may become unusable even if charged.
- When storing the battery for a long period of time, we recommend charging it once a year. Remove the battery from the camera and store it again after it has completely discharged.
- We recommend storing the camera with a desiccant (silica gel) when you keep it in a closet or a cabinet.
- **Check all the parts before taking pictures when you have not used the camera for a long period of time.**

About the picture data

- Recorded data may be damaged or lost if the camera breaks down due to inappropriate handling. Leica Camera AG will not be liable for any damage suffered due to loss of recorded data.

About tripods or unipods

- When you use a tripod, make sure the tripod is stable when the camera is attached to it.
- You may not be able to remove the card or the battery when using a tripod or unipod.
- You may not be able to touch the NFC antenna with another device when using a tripod or unipod.
- Make sure that the screw on the tripod or unipod is not angled when attaching or detaching the camera. You may damage the thread in the camera if you use excessive force when tightening it. Also, the camera body and the rating label may be damaged or scratched if the camera is attached too loosely to the tripod or unipod.
- Read the instructions for the tripod or unipod carefully.

- The SDXC Logo is a trademark of SD-3C, LLC.
- HDMI, the HDMI Logo, and High-Definition Multimedia Interface are trademarks or registered trademarks of HDMI Licensing LLC in the United States and other countries.
- Manufactured under license from Dolby Laboratories. Dolby and the double-D symbol are trademarks of Dolby Laboratories.
- Leica is a registered trademark of Leica Microsystems IR GmbH.
- Elmarit is a registered trademark of Leica Camera AG.
- Adobe® Photoshop® Lightroom® is a registered trademark of Adobe Systems Incorporated.
- Windows and Windows Vista are either registered trademarks or trademarks of Microsoft Corporation in the United States and/or other countries.
- Mac and Mac OS are trademarks of Apple Inc., registered in the U.S. and other countries.
- App Store is a service mark of Apple Inc.
- Android and Google Play are trademarks or registered trademarks of Google Inc.
- The Wi-Fi CERTIFIED Logo is a certification mark of the Wi-Fi Alliance.
- The Wi-Fi Protected Setup Mark is a mark of the Wi-Fi Alliance.
- “Wi-Fi”, “Wi-Fi Protected Setup”, “Wi-Fi Direct”, “WPA” and “WPA2” are marks or registered marks of the Wi-Fi Alliance.
- This product uses “DynaFont” from DynaComware Corporation. DynaFont is a registered trademark of DynaComware Taiwan Inc.
- QR Code is a registered trademark of DENSO WAVE INCORPORATED.
- Other names of systems and products mentioned in these instructions are usually the registered trademarks or trademarks of the manufacturers who developed the system or product concerned.



This product is licensed under the AVC patent portfolio license for the personal and non-commercial use of a consumer to (i) encode video in compliance with the AVC Standard ("AVC Video") and/or (ii) decode AVC Video that was encoded by a consumer engaged in a personal and non-commercial activity and/or was obtained from a video provider licensed to provide AVC Video. No license is granted or shall be implied for any other use. Additional information may be obtained from MPEG LA, LLC. See <http://www.mpegla.com>.

This product incorporates the following software:

- (1) the software owned by third party and licensed to Leica Camera AG, and/or
- (2) open source software

The software categorized as (2) is distributed in the hope that it will be useful, but WITHOUT ANY WARRANTY, without even the implied warranty of MERCHANTABILITY or FITNESS FOR A PARTICULAR PURPOSE.

Please refer to the detailed terms and conditions thereof displayed by selecting [MENU/SET] → [Setup] → [Version Disp.] → [Software info].

Leica Service Addresses

Leica Product Support

The Product Support department at Leica Camera AG can provide you with answers to any technical questions relating to Leica products, including software supplied, either in writing, on the telephone or by e-mail.

They are also the contact point for purchasing advice and to order instructions.

Alternatively, you can send us your questions using the contact form on the Leica Camera AG homepage.

Leica Camera AG

Product Support / Software Support

Am Leitz-Park 5

D-35578 Wetzlar

Telephone: +49 (0) 6441-2080-111 /-108

Fax: +49 (0) 6441-2080-490

info@leica-camera.com / software-support@leica-camera.com

Leica Customer Care

For servicing your Leica equipment or in the event of damage, Leica Camera AG Customer Care department or the repair service provided by authorized Leica agents in your country are available (see the Warranty Card for a list of addresses).

Leica Camera AG

Customer Care

Am Leitz-Park 5

D-35578 Wetzlar

Telephone: +49 (0) 6441-2080-189

Fax: +49 (0) 6441-2080-339

customer.care@leica-camera.com



my point of view