

# User's Guide

## Copyright

# Copyright

No part of this publication may be reproduced, stored in a retrieval system, or transmitted in any form or by any means, electronic, mechanical, photocopying, recording, or otherwise, without the prior written permission of Seiko Epson Corporation. No patent liability is assumed with respect to the use of the information contained herein. Neither is any liability assumed for damages resulting from the use of the information herein. The information contained herein is designed only for use with this Epson product. Epson is not responsible for any use of this information as applied to other products.

Neither Seiko Epson Corporation nor its affiliates shall be liable to the purchaser of this product or third parties for damages, losses, costs, or expenses incurred by the purchaser or third parties as a result of accident, misuse, or abuse of this product or unauthorized modifications, repairs, or alterations to this product, or (excluding the U.S.) failure to strictly comply with Seiko Epson Corporation's operating and maintenance instructions.

Seiko Epson Corporation and its affiliates shall not be liable for any damages or problems arising from the use of any options or any consumable products other than those designated as Original Epson Products or Epson Approved Products by Seiko Epson Corporation.

Seiko Epson Corporation shall not be held liable for any damage resulting from electromagnetic interference that occurs from the use of any interface cables other than those designated as Epson Approved Products by Seiko Epson Corporation.

© 2015 Seiko Epson Corporation. All rights reserved.

The contents of this manual and the specifications of this product are subject to change without notice.

# Trademarks

- ❑ EPSON® is a registered trademark, and EPSON EXCEED YOUR VISION or EXCEED YOUR VISION is a trademark of Seiko Epson Corporation.
- ❑ PRINT Image Matching™ and the PRINT Image Matching logo are trademarks of Seiko Epson Corporation. Copyright © 2001 Seiko Epson Corporation. All rights reserved.
- ❑ EPSON Scan software is based in part on the work of the Independent JPEG Group.
- ❑ libtiff

Copyright © 1988-1997 Sam Leffler

Copyright © 1991-1997 Silicon Graphics, Inc.

Permission to use, copy, modify, distribute, and sell this software and its documentation for any purpose is hereby granted without fee, provided that (i) the above copyright notices and this permission notice appear in all copies of the software and related documentation, and (ii) the names of Sam Leffler and Silicon Graphics may not be used in any advertising or publicity relating to the software without the specific, prior written permission of Sam Leffler and Silicon Graphics.

THE SOFTWARE IS PROVIDED "AS-IS" AND WITHOUT WARRANTY OF ANY KIND, EXPRESS, IMPLIED OR OTHERWISE, INCLUDING WITHOUT LIMITATION, ANY WARRANTY OF MERCHANTABILITY OR FITNESS FOR A PARTICULAR PURPOSE.

IN NO EVENT SHALL SAM LEFFLER OR SILICON GRAPHICS BE LIABLE FOR ANY SPECIAL, INCIDENTAL, INDIRECT OR CONSEQUENTIAL DAMAGES OF ANY KIND, OR ANY DAMAGES WHATSOEVER RESULTING FROM LOSS OF USE, DATA OR PROFITS, WHETHER OR NOT ADVISED OF THE POSSIBILITY OF DAMAGE, AND ON ANY THEORY OF LIABILITY, ARISING OUT OF OR IN CONNECTION WITH THE USE OR PERFORMANCE OF THIS SOFTWARE.

- ❑ Microsoft®, Windows®, and Windows Vista® are registered trademarks of Microsoft Corporation.
- ❑ Apple, Macintosh, Mac OS, OS X, Bonjour, Safari, iPad, iPhone, iPod touch, and iTunes are trademarks of Apple Inc., registered in the U.S. and other countries. AirPrint and the AirPrint logo are trademarks of Apple Inc.
- ❑ Google Cloud Print™, Chrome™, Chrome OS™, and Android™ are trademarks of Google Inc.
- ❑ Adobe, Adobe Reader, Acrobat, and Photoshop are trademarks of Adobe systems Incorporated, which may be registered in certain jurisdictions.
- ❑ Intel® is a registered trademark of Intel Corporation.
- ❑ General Notice: Other product names used herein are for identification purposes only and may be trademarks of their respective owners. Epson disclaims any and all rights in those marks.

## Contents

### Copyright

### Trademarks

### About This Manual

Introduction to the Manuals. . . . .	7
Marks and Symbols. . . . .	7
Descriptions Used in this Manual. . . . .	8
Operating System References. . . . .	8

### Important Instructions

Safety Instructions. . . . .	9
Printer Advisories and Warnings. . . . .	9
Advisories and Warnings for Setting Up the Printer. . . . .	10
Advisories and Warnings for Using the Printer. . . . .	10
Advisories and Warnings for Transporting or Storing the Printer. . . . .	11
Advisories and Warnings for Using the Printer with a Wireless Connection. . . . .	11
Advisories and Warnings for Using the LCD Screen. . . . .	11
Protecting Your Personal Information. . . . .	11

### Printer Basics

Part Names and Functions. . . . .	12
Control Panel. . . . .	14
Buttons and Lights. . . . .	14
Icons Displayed on the LCD Screen. . . . .	15
Menu Options. . . . .	15
<b>C</b> opy Mode. . . . .	15
<b>S</b> can Mode. . . . .	16
<b>F</b> ax Mode. . . . .	17
<b>S</b> etup Mode. . . . .	18

### Loading Paper

Paper Handling Precautions. . . . .	23
Available Paper and Capacities. . . . .	24
List of Paper Types. . . . .	24
Loading Paper in the Rear Paper Feed. . . . .	25

### Placing Originals

Available Originals for the ADF. . . . .	29
Placing Originals on the ADF. . . . .	29
Placing Originals on the Scanner Glass. . . . .	30

### Printing

Printing from a Computer. . . . .	32
Printing Basics - Windows. . . . .	32
Printing Basics - Mac OS X. . . . .	34
Printing on 2-Sides (for Windows only). . . . .	36
Printing Several Pages on One Sheet. . . . .	37
Printing to Fit the Paper Size. . . . .	38
Printing Multiple Files Together (for Windows Only). . . . .	39
Printing One Image on Multiple Sheets to Create a Poster (for Windows Only). . . . .	40
Printing Using Advanced Features. . . . .	46
Printing Photos Using Epson Easy Photo Print. . . . .	48
Printing from Smart Devices. . . . .	48
Using Epson iPrint. . . . .	48
Using AirPrint. . . . .	50
Canceling Printing. . . . .	51
Canceling Printing - Printer Button. . . . .	51
Canceling Printing - Windows. . . . .	51
Canceling Printing - Mac OS X. . . . .	51

### Copying

### Scanning

Scanning Using the Control Panel. . . . .	53
Scanning to the Cloud. . . . .	53
Scanning to a Computer. . . . .	53
Scanning to a Computer (WSD). . . . .	54
Scanning from a Computer. . . . .	54
Scanning Basics. . . . .	54
Scanning Using Advanced Features. . . . .	56
Scanning from Smart Devices. . . . .	59
Installing Epson iPrint. . . . .	59
Using Epson iPrint. . . . .	59

### Faxing

Setting Up a Fax. . . . .	61
Connecting to a Phone Line. . . . .	61
Making Basic Fax Settings. . . . .	64





# About This Manual

---

## Introduction to the Manuals

The following manuals are supplied with your Epson printer. As well as the manuals, see the help included in the various Epson software applications.

Start Here (paper manual)

Provides you with information on setting up the printer, installing the software, using the printer, solving problems, and so on.

User's Guide (digital manual)

This manual. Provides overall information and instructions on using the printer, and on solving problems.

Network Guide (digital manual)

Provides information on network settings and solving problems when using the printer on a network.

You can obtain the latest versions of the above manuals with the following methods.

Paper manual

Visit the Epson Europe support website at <http://www.epson.eu/Support>, or the Epson worldwide support website at <http://support.epson.net/>.

Digital manual

Start EPSON Software Updater on your computer. EPSON Software Updater checks for available updates of Epson software applications and the digital manuals, and allows you to download the latest ones.

### Related Information

➔ [“EPSON Software Updater” on page 95](#)

---

## Marks and Symbols



**Caution:**

*Instructions that must be followed carefully to avoid bodily injury.*



**Important:**

*Instructions that must be observed to avoid damage to your equipment.*

**Note:**

*Provides complementary and reference information.*

➔ Related Information

Links to related sections.

---

## Descriptions Used in this Manual

- ❑ Screenshots of the printer driver and the EPSON Scan (scanner driver) screens are from Windows 8.1 or Mac OS X v10.10.x. The content displayed on the screens varies depending on the model and situation.
- ❑ Illustrations of the printer used in this manual are examples only. Although there may be slight differences depending on the model, the method of operation is the same.
- ❑ Some of the menu items on the LCD screen vary depending on the model and settings.

---

## Operating System References

### Windows

In this manual, terms such as "Windows 8.1", "Windows 8", "Windows 7", "Windows Vista", "Windows XP", "Windows Server 2012 R2", "Windows Server 2012", "Windows Server 2008 R2", "Windows Server 2008", "Windows Server 2003 R2", and "Windows Server 2003" refer to the following operating systems. Additionally, "Windows" is used to refer to all versions.

- ❑ Microsoft® Windows® 8.1 operating system
- ❑ Microsoft® Windows® 8 operating system
- ❑ Microsoft® Windows® 7 operating system
- ❑ Microsoft® Windows Vista® operating system
- ❑ Microsoft® Windows® XP operating system
- ❑ Microsoft® Windows® XP Professional x64 Edition operating system
- ❑ Microsoft® Windows Server® 2012 R2 operating system
- ❑ Microsoft® Windows Server® 2012 operating system
- ❑ Microsoft® Windows Server® 2008 R2 operating system
- ❑ Microsoft® Windows Server® 2008 operating system
- ❑ Microsoft® Windows Server® 2003 R2 operating system
- ❑ Microsoft® Windows Server® 2003 operating system

### Mac OS X

In this manual, "Mac OS X v10.10.x" refers to OS X Yosemite, "Mac OS X v10.9.x" refers to OS X Mavericks, and "Mac OS X v10.8.x" refers to OS X Mountain Lion. Additionally, "Mac OS X" is used to refer to "Mac OS X v10.10.x", "Mac OS X v10.9.x", "Mac OS X v10.8.x", "Mac OS X v10.7.x", and "Mac OS X v10.6.8".



# Important Instructions

---

## Safety Instructions

Read and follow these instructions to ensure safe use of this printer. Make sure you keep this manual for future reference. Also, be sure to follow all warnings and instructions marked on the printer.

- Use only the power cord supplied with the printer and do not use the cord with any other equipment. Use of other cords with this printer or the use of the supplied power cord with other equipment may result in fire or electric shock.
- Be sure your AC power cord meets the relevant local safety standard.
- Never disassemble, modify, or attempt to repair the power cord, plug, printer unit, scanner unit, or options by yourself, except as specifically explained in the printer's manuals.
- Unplug the printer and refer servicing to qualified service personnel under the following conditions:  
The power cord or plug is damaged; liquid has entered the printer; the printer has been dropped or the casing damaged; the printer does not operate normally or exhibits a distinct change in performance. Do not adjust controls that are not covered by the operating instructions.
- Place the printer near a wall outlet where the plug can be easily unplugged.
- Do not place or store the printer outdoors, near excessive dirt or dust, water, heat sources, or in locations subject to shocks, vibrations, high temperature or humidity.
- Take care not to spill liquid on the printer and not to handle the printer with wet hands.
- Keep the printer at least 22 cm away from cardiac pacemakers. Radio waves from this printer may adversely affect the operation of cardiac pacemakers.
- If the LCD screen is damaged, contact your dealer. If the liquid crystal solution gets on your hands, wash them thoroughly with soap and water. If the liquid crystal solution gets into your eyes, flush them immediately with water. If discomfort or vision problems remain after a thorough flushing, see a doctor immediately.
- Avoid using a telephone during an electrical storm. There may be a remote risk of electric shock from lightning.
- Do not use a telephone to report a gas leak in the vicinity of the leak.
- Be careful not to touch any ink when you handle the ink tanks, ink tank caps, and opened ink bottles or ink bottle caps.
  - If ink gets on your skin, wash the area thoroughly with soap and water.
  - If ink gets into your eyes, flush them immediately with water. If discomfort or vision problems continue after a thorough flushing, see a doctor immediately.
  - If ink gets into your mouth, see a doctor right away.
- Do not tilt or shake an ink bottle after removing its seal; this can cause leakage.
- Keep ink bottles and the ink tank unit out of the reach of children. Do not allow children to drink from or handle the ink bottles and ink bottle cap.

---

## Printer Advisories and Warnings



Read and follow these instructions to avoid damaging the printer or your property. Make sure you keep this manual for future reference.

## Important Instructions

### Advisories and Warnings for Setting Up the Printer

- Do not block or cover the vents and openings in the printer.
- Use only the type of power source indicated on the printer's label.
- Avoid using outlets on the same circuit as photocopiers or air control systems that regularly switch on and off.
- Avoid electrical outlets controlled by wall switches or automatic timers.
- Keep the entire computer system away from potential sources of electromagnetic interference, such as loudspeakers or the base units of cordless telephones.
- The power-supply cords should be placed to avoid abrasions, cuts, fraying, crimping, and kinking. Do not place objects on top of the power-supply cords and do not allow the power-supply cords to be stepped on or run over. Be particularly careful to keep all the power-supply cords straight at the ends and the points where they enter and leave the transformer.
- If you use an extension cord with the printer, make sure that the total ampere rating of the devices plugged into the extension cord does not exceed the cord's ampere rating. Also, make sure that the total ampere rating of all devices plugged into the wall outlet does not exceed the wall outlet's ampere rating.
- If you plan to use the printer in Germany, the building installation must be protected by a 10 or 16 amp circuit breaker to provide adequate short-circuit protection and over-current protection for the printer.
- When connecting the printer to a computer or other device with a cable, ensure the correct orientation of the connectors. Each connector has only one correct orientation. Inserting a connector in the wrong orientation may damage both devices connected by the cable.
- Place the printer on a flat, stable surface that extends beyond the base of the printer in all directions. The printer will not operate properly if it is tilted at an angle.
- Allow space above the printer so that you can fully raise the document cover.
- Leave enough space in front of the printer for the paper to be fully ejected.
- Avoid places subject to rapid changes in temperature and humidity. Also, keep the printer away from direct sunlight, strong light, or heat sources.

### Advisories and Warnings for Using the Printer

- Do not insert objects through the slots in the printer.
- Do not put your hand inside the printer during printing.
- Do not touch the white flat cable and ink tubes inside the printer.
- Do not use aerosol products that contain flammable gases inside or around the printer. Doing so may cause fire.
- Do not move the print head by hand; otherwise, you may damage the printer.
- Be careful not to trap your fingers when closing the scanner unit.
- Do not press too hard on the scanner glass when placing the originals.
- Prolonged use of the printer when the ink level is below the lower line could damage the printer. Epson recommends filling the ink tank to the upper line when the printer is not operating to reset the ink level.
- Always turn the printer off using the  button. Do not unplug the printer or turn off the power at the outlet until the  light stops flashing.
- If you are not going to use the printer for a long period, be sure to unplug the power cord from the electrical outlet.

## Important Instructions

### Advisories and Warnings for Transporting or Storing the Printer

- When storing or transporting the printer, avoid tilting it, placing it vertically, or turning it upside down; otherwise ink may leak.
- Before transporting the printer, make sure that the print head is in the home (far right) position.

### Advisories and Warnings for Using the Printer with a Wireless Connection

- Radio waves from this printer may negatively affect the operation of medical electronic equipment, causing them to malfunction. When using this printer inside medical facilities or near medical equipment, follow directions from the authorized personnel representing the medical facilities, and follow all posted warnings and directions on the medical equipment.
- Radio waves from this printer may negatively affect the operation of automatically controlled devices such as automatic doors or fire alarms, and could lead to accidents due to malfunction. When using this printer near automatically controlled devices, follow all posted warnings and directions on these devices.

### Advisories and Warnings for Using the LCD Screen

- The LCD screen may contain a few small bright or dark spots, and because of its features it may have an uneven brightness. These are normal and do not indicate that it is damaged in any way.
- Only use a dry, soft cloth for cleaning. Do not use liquid or chemical cleaners.
- The exterior cover of the LCD screen could break if it receives a heavy impact. Contact your dealer if the screen's surface chips or cracks, and do not touch or attempt to remove the broken pieces.

---

## Protecting Your Personal Information

When you give the printer to someone else or dispose of it, erase all the personal information stored in the printer's memory by selecting **Setup > Restore Default Settings > Clear All Data and Settings** on the control panel.

# Printer Basics

## Part Names and Functions

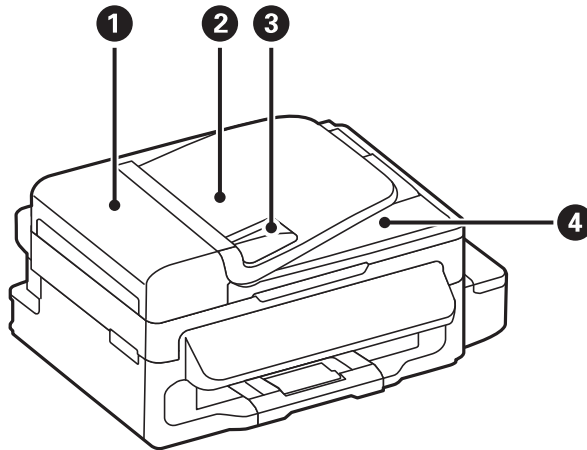

❶	ADF (Automatic Document Feeder) cover	Open when removing jammed originals in the ADF.
❷	ADF input tray	Feeds originals automatically.
❸	ADF edge guide	Feeds originals straight into the printer. Slide to the edges of the originals.
❹	ADF output tray	Holds originals ejected from the ADF.

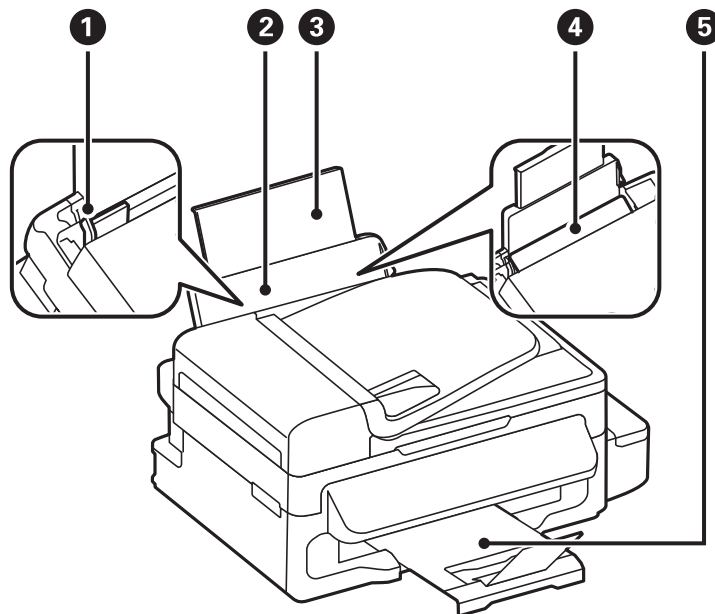

❶	Edge guide	Feeds the paper straight into the printer. Slide to the edges of the paper.
---	------------	---

### Printer Basics

②	Rear paper feed	Loads paper.
③	Paper support	Supports loaded paper.
④	Feeder guard	Prevents foreign substance from entering the printer. Usually keep this guard closed.
⑤	Output tray	Holds the ejected paper.

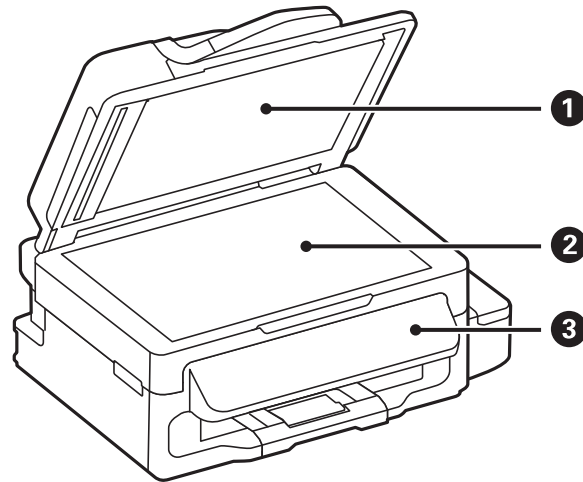

①	Document cover	Blocks external light while scanning.
②	Scanner glass	Place the originals.
③	Control panel	Operates the printer.

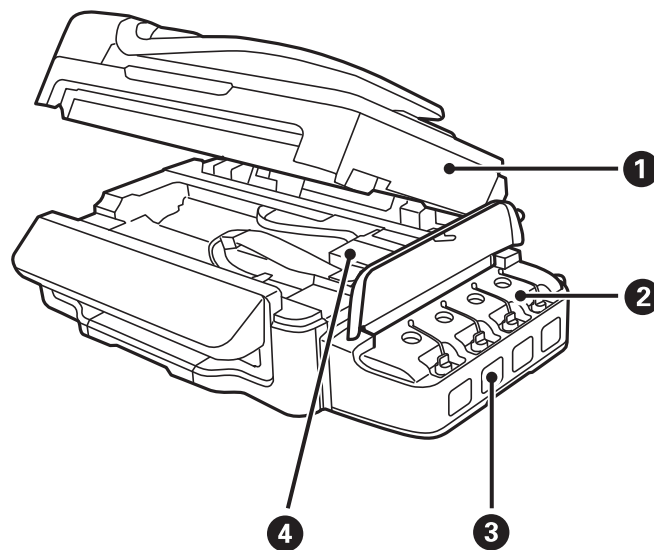

①	Scanner unit	Scans placed originals. Open when removing jammed paper inside the printer.
②	Ink tank unit	Contains the ink tanks.

### Printer Basics

③	Ink reservoir tanks (Ink tanks)	Supplies ink to the print head.
④	Print head (under this section)	Fires ink.

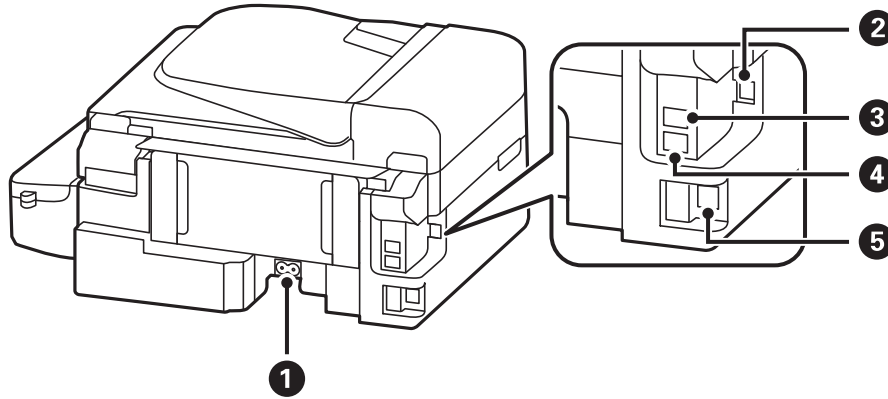

①	AC inlet	Connects the power cord.
②	USB port	Connects a USB cable.
③	LINE port	Connects a phone line.
④	EXT. port	Connects external phone devices.
⑤	LAN port	Connects a LAN cable.



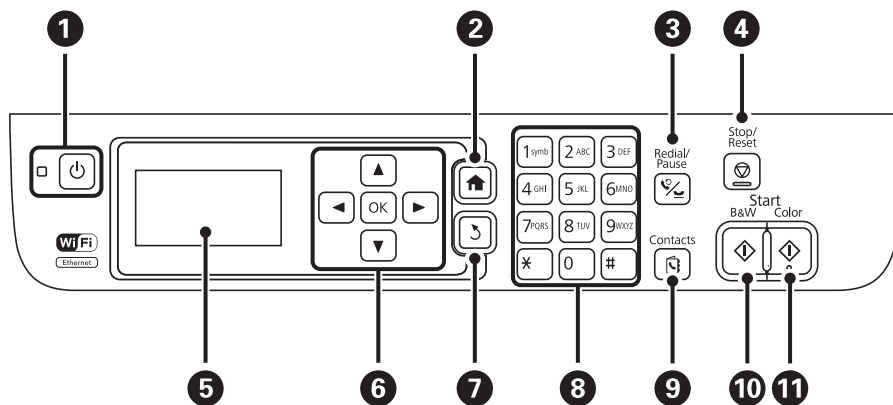

## Control Panel

### Buttons and Lights













①		Turns the printer on or off. Unplug the power cord when the power light is off.
②		Displays the home screen.
③		Enter the last dialed number or enter a pause when entering a fax number.

## Printer Basics

4		Stops the current operation.
5	-	Displays menus and messages.
6	◀, ▶, ▲, ▼, OK	Press ◀, ▶, ▲, and ▼ to select menus. Press OK to confirm your selection or run the selected feature.
7		Returns to the previous screen.
8	0 - 9 *, #	Enters numbers, characters, and symbols.
9		Opens the contacts list.
10		Starts printing, copying, scanning, and faxing in black and white.
11		Starts printing, copying, scanning, and faxing in color.

## Icons Displayed on the LCD Screen

The following icons are displayed on the LCD screen depending on the printer's status.

	Turns on when originals are placed in the ADF.
	Turns on when the wired (Ethernet) network is disabled and an Ethernet cable is not connected.
	Turns on while the printer is connected to a wired (Ethernet) network.
	Turns on while the printer is not connected to a wireless (Wi-Fi) network.
	Turns on while the printer is connected to a wireless (Wi-Fi) network. The number of bars indicates the signal strength of the connection. The more bars there are, the stronger the connection.
	Indicates a problem with the printer's wireless (Wi-Fi) network connection, or that the printer is searching for a wireless (Wi-Fi) network connection.
	Indicates that the printer is connected to a network in Ad Hoc mode.
	Indicates that Simple AP mode and Wi-Fi Direct mode are disabled.
	Indicates that the printer is connected to a network in Wi-Fi Direct mode.
	Indicates that Simple AP mode is enabled.
	Turns on when Eco Mode is enabled.

## Menu Options

### Copy Mode

**Note:**

- ❑ Available menus vary depending on the layout you selected.
- ❑ Press the OK button to display hidden setting menus.

## Printer Basics

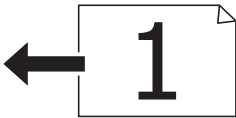
Menu	Settings and Explanations	
Number of copies	Enter the number of copies.	
Layout	With Border	Copies with a border around the edges.
	2-up	<p>Copies multiple page originals onto one sheet.</p> <p>When placing originals in the ADF, insert them into the feeder from the top or left edge.</p> <p>Load vertical originals as shown below, and select <b>Portrait</b> from <b>Document Orientation</b>.</p>  <p>Load horizontal originals as shown below, and select <b>Landscape</b> from <b>Document Orientation</b>.</p> 
	ID Card	Scans both sides of an ID card and copies onto one side of A4 size paper.
Document Size	Select the size of your original.	
Zoom	<p>Enlarges or reduces the original.</p> <p>Select <b>Auto Fit Page</b> to fit to the paper size of the selected paper source.</p>	
Document Orientation	Select the orientation of your original.	
Quality	<p>Select the type of your original.</p> <p>Draft: Provides faster printing, but the printouts may be faint.</p> <p>For users in Belgium, the draft mode is not available.</p> <p>Best: Provides higher quality printing, but the printing speed may be slower.</p>	
Density	Set the density of your copies.	
Layout Order	Select the copy layout for multiple pages when you have selected <b>2-up</b> as the <b>Layout</b> setting.	

## Scan Mode

### Cloud

Menu	Settings and Explanations
Destination	Select a destination that has been registered in the Epson Connect Server.



## Printer Basics

Menu	Settings and Explanations	
Settings	Format	Select the format in which to save the scanned image.
	Scan Area	Select the scan area. Auto Cropping: Crops the white space around the text or image when scanning. Max Area: Scans at the maximum scan area of the scanner glass or the ADF.
	Document Type	Select the type of your original.
	Density	Select the contrast of the scanned image.
	Document Orientation	Select the orientation of your original.

## Computer

Menu	Settings and Explanations	
Select Computer	From the list of computers connected using USB or over the network, select the computer you want to save the scanned image to.	
Settings	Format	Select the format in which to save the scanned image.

## Computer (WSD)

This menu has no setting item.

## Fax Mode

Select **Fax** on the home screen, and then press the OK button.

Menu	Settings and Explanations
Resolution	Select the resolution of the outgoing fax. Select <b>Photo</b> for originals that contain both text and photo images.
Density	Set the density of the outgoing fax.
Direct Send	See the page that describes this feature for more details.
Transmission Report	Prints a transmission report automatically after you send a fax. Select <b>Print on Error</b> to print a report only when an error occurs.
Send Fax Later	See the pages that describes these features for more details.
Polling Receive	
Reprint Faxes	Prints received faxes temporarily stored in the printer's memory from the latest one.

## Printer Basics

Menu	Settings and Explanations	
Fax Report	Fax Settings List	Prints the current fax settings.
	Fax Log	Displays or prints a history of sent and received fax jobs. You can set to print this report automatically using the following menu. <b>Setup &gt; Fax Settings &gt; Output Settings &gt; Fax Log Auto Print</b>
	Last Transmission	Prints a report for the previous fax that was sent or received through polling.
	Protocol Trace	Prints a detailed report for the previous fax that was sent or received.

### Related Information

- ➔ [“Sending Many Pages of a Monochrome Document \(Direct Send\)” on page 70](#)
- ➔ [“Sending Faxes at a Specified Time \(Send Fax Later\)” on page 69](#)
- ➔ [“Receiving Faxes by Polling \(Polling Receive\)” on page 72](#)

## Setup Mode

Menu	Settings and Explanations		
Maintenance	Print Head Nozzle Check	Prints a pattern to check if the print head nozzles are clogged.	
	Print Head Cleaning	Cleans clogged nozzles in the print head.	
	Reset Ink Levels	Select this feature to reset the ink levels before you refill the ink tanks.	
	Print Head Alignment	Adjusts the print head to improve print quality. Perform this feature if your printouts look blurry or text and lines are misaligned.	
	Paper Guide Cleaning	Perform this feature to clean the roller inside the printer when the printout are smeared or scuffed.	
Paper Setup	Select the paper size and paper type you loaded in the paper source.		
Print Status Sheet	Configuration Status Sheet	Prints an information sheet showing the current printer status and settings.	
	Usage History Sheet	Prints an information sheet showing the usage history of the printer.	
Printer Settings	Paper Source Settings	A4/Letter Switching	Enable this feature so that error messages are not displayed even when the paper size setting for the print job and the paper loaded in the paper source do not match. This feature is only available when the paper size is set to A4 or Letter.
		Error Notice	Displays an error message when the paper size or type settings in <b>Paper Setup</b> and the print settings do not match.
	PC Connection via USB	Enables the printer which is connected to the computer over a USB connection. If this feature is disabled, the computer does not recognize printers with a USB connection.	

## Printer Basics

Menu	Settings and Explanations		
Common Settings	Sound	Adjust the volume and select the type of audio.	
	Sleep Timer	Select the time period before the printer enters sleep mode (energy saving mode) when no operations are performed.  The LCD screen turns black when the set time passes.	
	Power Off Timer	You can adjust the time before power management is applied. Any increase will affect the product's energy efficiency. Please consider the environment before making any change.	
	LCD Contrast	Adjust the contrast of the LCD screen.	
	Date/Time Settings	Date/Time	Enter the current date and time.
		Daylight Saving Time	Select the summer time setting that applies to your area.
		Time Difference	Enter the time difference between your local time and UTC (Coordinated Universal Time).
	Country/Region	Select the country or region.	
	Language	Select the display language.	
	Scroll Speed	Select the scroll speed of the LCD screen.	
Network Settings	Network Status	Displays or prints the network settings and connection status.	
	Wi-Fi Setup	Wi-Fi Setup Wizard	See the <i>Network Guide</i> for more details.
		Push Button Setup (WPS)	
		PIN Code Setup (WPS)	
		Wi-Fi Auto Connect	
		Disable Wi-Fi	You may be able to resolve network problems by disabling the Wi-Fi settings or making the Wi-Fi settings again. See the <i>Network Guide</i> for more details.
	Wi-Fi Direct Setup	See the <i>Network Guide</i> for more details.	
Connection Check	Checks the status of the network connection and prints the network connection check report. If there are any problems with the connection, see the check report to solve the problem.		
Advanced Setup	See the <i>Network Guide</i> for more details.		
Epson Connect Services	You can suspend or resume the Epson Connect or Google Cloud Print service, or cancel using the services (restore the default settings).		
Google Cloud Print Services	See the Epson Connect portal website for more details. <a href="https://www.epsonconnect.com/">https://www.epsonconnect.com/</a> <a href="http://www.epsonconnect.eu">http://www.epsonconnect.eu</a> (Europe only)		
Fax Settings	See the list of menus in <b>Fax Settings</b> .		

## Printer Basics

Menu	Settings and Explanations	
Universal Print Settings	These print settings are applied when you print using an external device without using the printer driver.	
	Top Offset	Adjust the top or left margin of the paper.
	Left Offset	
	Skip Blank Page	Skips blank pages in the print data automatically.
Eco Mode	Sleep Timer	<p>Select the time period before the printer enters sleep mode (energy saving mode) when no operations are performed.</p> <p>The LCD screen turns black when the set time passes.</p> <p>When this setting is disabled, the setting made in <b>Common Settings</b> is applied.</p>
Restore Default Settings	Resets the selected settings to their defaults.	

### Related Information

- ➔ [“Copy Mode” on page 15](#)
- ➔ [“Scan Mode” on page 16](#)
- ➔ [“Fax Settings” on page 20](#)

## Fax Settings

Select **Setup** > **Fax Settings** from the home screen.

Menu	Settings and Explanations	
User Default Settings	The settings made in this menu become your default settings for sending faxes. For details on the setting items, see the list of menus in <b>Fax</b> mode.	
Receive Settings	Receive Mode	Select the receive mode.
	DRD	If you have subscribed to a distinctive ring service from your telephone company, select the ring pattern to be used for incoming faxes (or select <b>On</b> ).
	Rings to Answer	Select the number of rings that must occur before the printer automatically receives a fax. Select "0" (zero) if you want to receive faxes with no ringing.
	Remote Receive	When you answer an incoming fax call on a phone connected to the printer, you can start receiving the fax by entering the code using the phone.

## Printer Basics

Menu	Settings and Explanations	
Output Settings	Fax Output	Saves received documents on a computer. You need to make settings on FAX Utility on a computer.
	Auto Reduction	Reduces large received documents to fit on the paper in the paper source. Reducing may not always be possible depending on the received data. If this is turned off, large documents are printed at their original size on multiple sheets, or a blank second page may be ejected.
	Auto Rotation	Rotates automatically to print on A5 size paper when a landscape-oriented A5 size document is received and the paper source setting is set to A5. Prints on A4 size paper when this feature is disabled.
	Collation Stack	Prints received documents from the last page (print in descending order) so that the printed documents are stacked in the correct page order. When the printer is running low on memory, this feature may not be available.
	Print Suspend Time	Stops and restarts printing received documents at the entered time. The received documents are not printed during the specified time period but saved in the memory. When the printer is running low on memory, this feature may not be available. Received documents are printed automatically after the restarting time. This feature can be used for noise prevention at night or to prevent confidential documents from being disclosed while you are away.
	Attach Image to Report	Prints a <b>Transmission Report</b> with an image of the first page of the sent document. On(Large Image): Prints the upper part of the page without reducing. On(Small Image): Prints the entire page reducing it to fit onto the report.
	Fax Log Auto Print	Prints the fax log automatically. On(Every 30): Prints a log every time 30 fax jobs are completed. On(Time): Prints the log at a specified time. However, if the number of fax jobs exceeds 30, the log is printed before the specified time.
	Report Format	Select a format for fax reports other than <b>Protocol Trace</b> . Select <b>Detail</b> to print with error codes.

## Printer Basics

Menu	Settings and Explanations	
Basic Settings	Fax Speed	Select the fax transmission speed.  We recommend selecting <b>Slow(9,600bps)</b> when a communication error occurs frequently, when sending/receiving a fax to/from abroad, or when you are using an IP (VoIP) phone service.
	ECM	Automatically corrects errors in the fax transmission (Error Correction Mode), mostly caused by telephone line noise. If this is disabled, you cannot send or receive documents in color.
	Dial Tone Detection	Detects a dial tone before starting to dial.  If the printer is connected to a PBX (Private Branch Exchange) or digital phone line, the printer may fail to start dialing. In this situation, change the <b>Line Type</b> setting to <b>PBX</b> . If this does not work, disable this feature. However, disabling this feature may drop the first digit of a fax number and send the fax to the wrong number.
	Dial Mode	Select the type of phone system to which you have connected the printer. When set to <b>Pulse</b> , you can temporarily switch the dialing mode from pulse to tone by pressing * ("T" is entered) while entering numbers on the fax top screen. Depending on the region, this setting may not be displayed.
	Line Type	Select the line type to which you have connected the printer. For more details, see the page that describes basic fax settings.
	Header	Enter your sender name and fax number. These appear as a header on outgoing faxes.  You can enter up to 40 characters for your name, and up to 20 digits for your fax number.
Security Settings	Backup Data Auto Clear	Fax documents deleted by using the control panel disappear from the LCD screen, but their backups are temporarily stored in the memory. The following features delete backups.
	Clear Backup Data	Backup Data Auto Clear: Automatically deletes backups each time a sent or received document is deleted.  Clear Backup Data: Deletes all backups. Run this before you give the printer to someone else or dispose of it.
Check Fax Connection	Checks if the printer is connected to the phone line and ready for fax transmission, and prints the check result on A4 size plain paper.	
Fax Setting Wizard	Select to make basic fax settings by following the on-screen instructions.  For more details, see the page that describes basic fax settings.	

### Related Information

- ➔ [“Fax Mode” on page 17](#)
- ➔ [“Saving Received Faxes on a Computer” on page 73](#)
- ➔ [“Making Basic Fax Settings” on page 64](#)

# Loading Paper

## Paper Handling Precautions

- ❑ Read the instruction sheets supplied with the paper.
- ❑ Fan and align the edges of the paper before loading. Do not fan or curl photo paper. Doing so may damage the printable side.

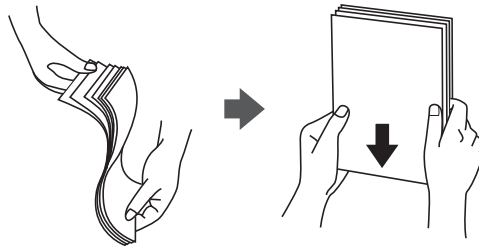

- ❑ If the paper is curled, flatten it or curl it slightly in the opposite direction before loading. Printing on curled paper may cause paper jams and smears on the printout.

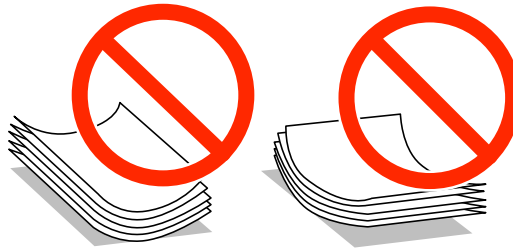

- ❑ Do not use paper that is wavy, torn, cut, folded, damp, too thick, too thin, or paper that has stickers stuck to it. Using these types of paper causes paper jams and smears on the printout.
- ❑ Fan and align the edges of the envelopes before loading. When the stacked envelopes are puffed up with air, press them down to flatten them before loading.

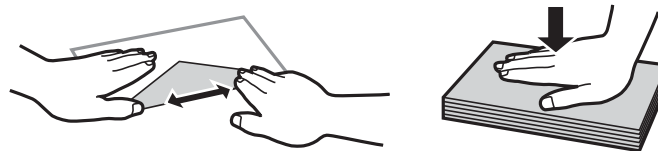

- ❑ Do not use envelopes that are curled or folded. Using these envelopes causes paper jams and smears on the printout.
- ❑ Do not use envelopes with adhesive surfaces on the flaps or window envelopes.
- ❑ Avoid using envelopes that are too thin, as they may curl during printing.

### Related Information

➔ [“Printer Specifications” on page 121](#)

## Available Paper and Capacities

Epson recommends using genuine Epson paper to ensure high-quality printouts.

### Genuine Epson Paper

Media Name	Size	Loading Capacity (Sheets)	Manual 2-Sided Printing
Epson Bright White Ink Jet Paper	A4	80 <sup>*1</sup>	✓
Epson Premium Glossy Photo Paper <sup>*2</sup>	A4, 13 × 18 cm (5 × 7 in.), 16:9 wide size (102 × 181 mm), 10 × 15 cm (4 × 6 in.)	20	-
Epson Matte Paper-Heavyweight <sup>*2</sup>	A4	20	-
Epson Photo Quality Ink Jet Paper <sup>*3</sup>	A4	80	-

\*1 For manual 2-sided printing, you can load up to 30 sheets for paper with one side already printed.

\*2 Only printing from computer or smart device is available.

\*3 Only printing from computer is available.

#### Note:

The availability of paper varies by location. For the latest information on paper available in your area, contact Epson support.

### Commercially Available Paper

Media Name	Size	Loading Capacity (Sheets)	Manual 2-Sided Printing
Plain paper	Letter <sup>*1</sup> , A4, B5 <sup>*1</sup> , A5 <sup>*1</sup> , A6 <sup>*1</sup>	Up to the line indicated by the triangle symbol on the edge guide. <sup>*2</sup>	✓
	Legal <sup>*1</sup> , User Defined <sup>*1</sup>	1	
Envelope <sup>*1</sup>	Envelope #10, Envelope DL, Envelope C6	10	-

\*1 Only printing from computer or smart device is available.

\*2 For manual 2-sided printing, you can load up to 30 sheets for paper with one side already printed.

### Related Information

➔ [“Technical Support Web Site” on page 131](#)

## List of Paper Types

To obtain optimum printing results, select the paper type that suits the paper.



## Loading Paper

Media Name	Media Type	
	Control Panel	Printer Driver, Smart device*
Epson Bright White Ink Jet Paper	plain papers	plain papers
Epson Premium Glossy Photo Paper	Prem. Glossy	Epson Premium Glossy
Epson Matte Paper-Heavyweight	Matte	Epson Matte
Epson Photo Quality Ink Jet Paper	Matte	Epson Matte
Plain paper	plain papers	plain papers
Envelope	Envelope	Envelope

\* For smart devices, these media types can be selected when printing using Epson iPrint.

## Loading Paper in the Rear Paper Feed

1. Open the feeder guard and pull out the paper support.

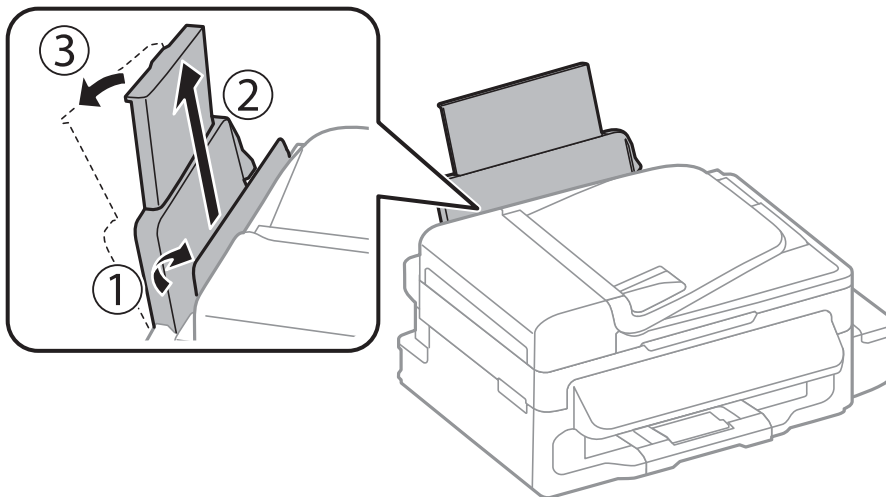

2. Slide the edge guide.

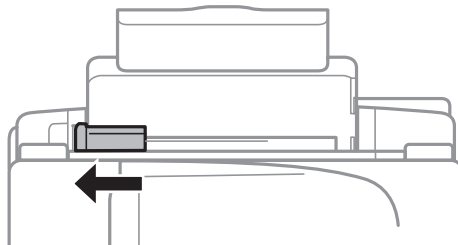

### Loading Paper

3. Load paper vertically along the right side of the rear paper feed with the printable side facing up.

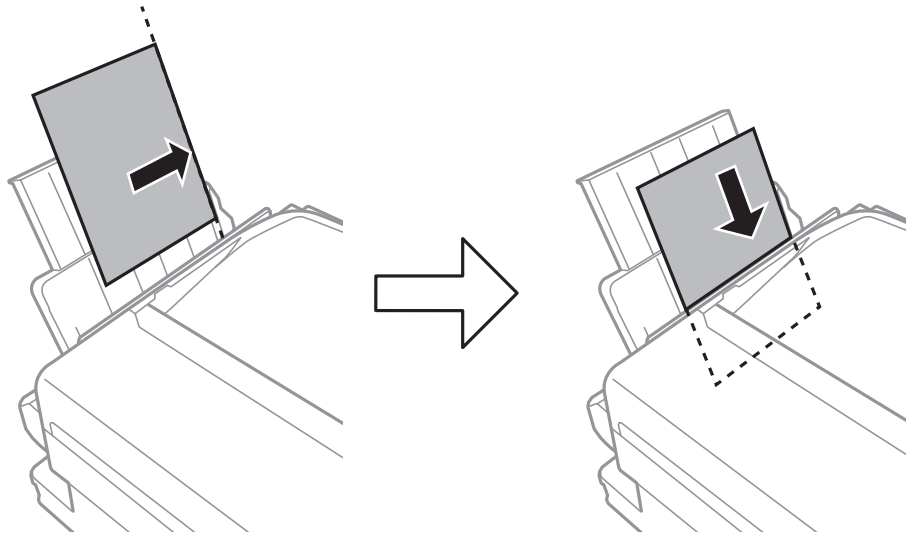

**Important:**

Do not load more than the maximum number of sheets specified for the paper. For plain paper, do not load above the line just under the ▼ symbol inside the edge guide.

- ❑ Envelopes

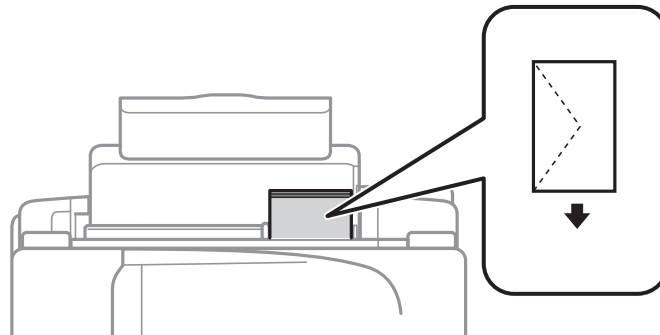

- ❑ Pre-punched paper

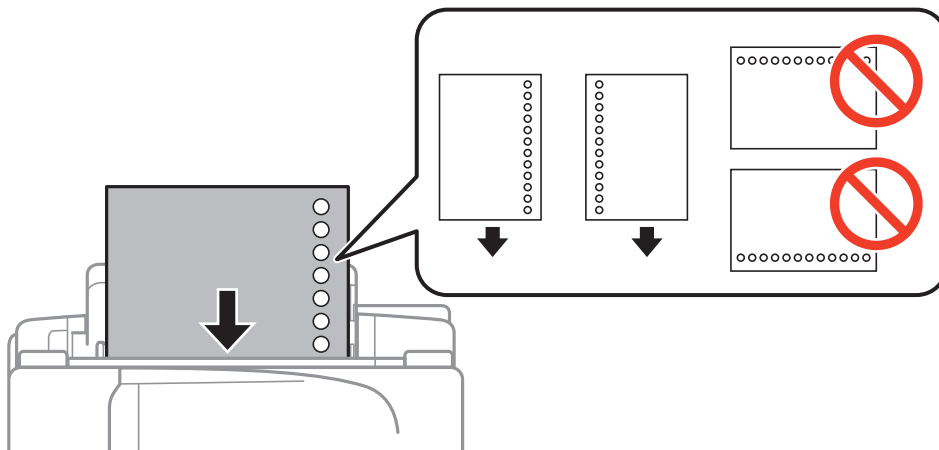

## Loading Paper

**Note:**

You can use pre-punched paper under the following conditions.

- ❑ Loading capacity: One sheet
- ❑ Available size: A4, B5, A5, A6, Letter, Legal
- ❑ Binding holes: Do not load paper with the binding holes at the top or the bottom.  
Adjust the print position of your file to avoid printing over the holes.

4. Slide the edge guide to the edge of the paper, and then close the feeder guard.

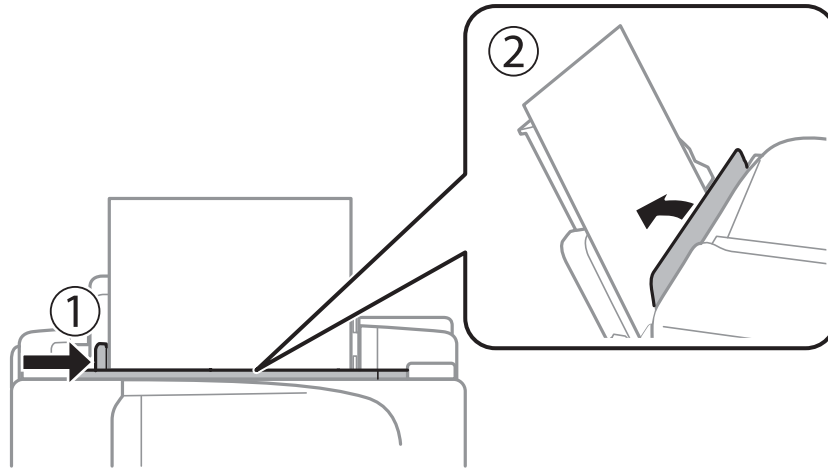

5. On the control panel, set the size and type of the paper you loaded in the rear paper feed.

**Note:**

You can also display the paper size and paper type settings screen by selecting **Setup > Paper Setup**.

6. Slide out the output tray.

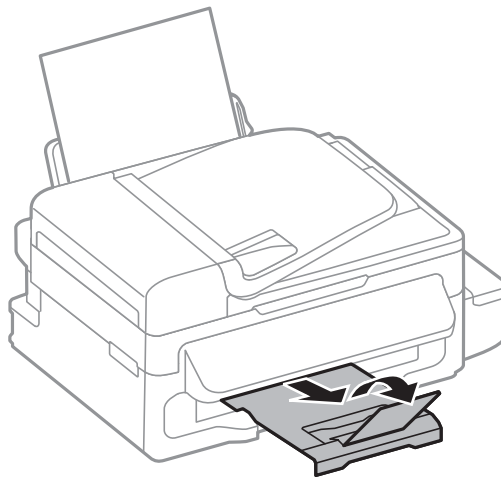

**Note:**

Return the remaining paper to its package. If you leave it in the printer, the paper may curl or the print quality may decline.

### Related Information

- ➔ [“Paper Handling Precautions” on page 23](#)

## Loading Paper

➔ [“Available Paper and Capacities” on page 24](#)

# Placing Originals

Place originals on the scanner glass or the ADF. Use the scanner glass for originals that the ADF does not support. You can scan multiple originals at the same time with the ADF.

---

## Available Originals for the ADF

Available Paper Sizes	A4, Letter, Legal
Paper Type	Plain paper
Paper Thickness (Weight of Paper)	64 to 95 g/m <sup>2</sup>
Loading Capacity	A4, Letter: 30 sheets or 3 mm Legal: 10 sheets

To prevent paper jams, avoid placing the following originals in the ADF. For these types, use the scanner glass.

- Originals that are torn, folded, wrinkled, deteriorated, or curled
- Originals with binder holes
- Originals held together with tape, staples, paper clips etc.
- Originals that have stickers or labels stuck to them
- Originals that are cut irregularly or not right angled
- Originals that are bound
- OHPs, thermal transfer paper, or carbon backs

---

## Placing Originals on the ADF

1. Align the edges of the originals.
2. Slide the ADF edge guide.

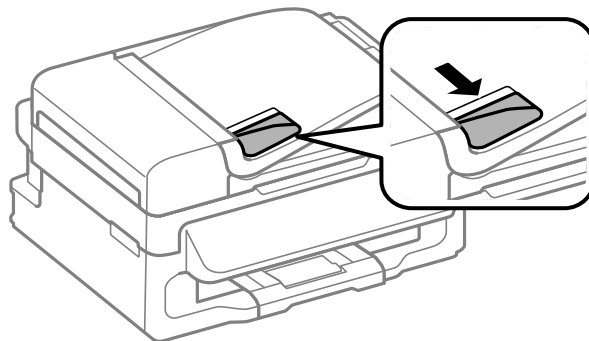

## Placing Originals

3. Place the originals face up in the ADF.

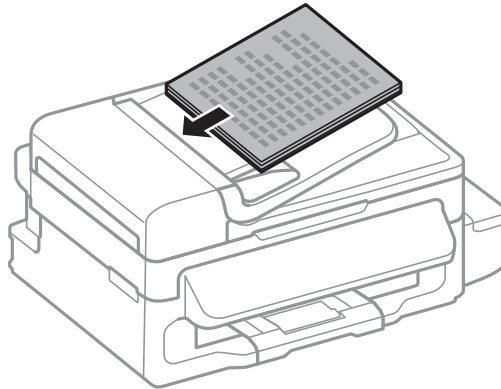

**!** *Important:*

- Do not load originals above the line just under the ▼ symbol inside the ADF edge guide.
- Do not add originals while scanning.

4. Slide the ADF edge guide to the edge of the originals.

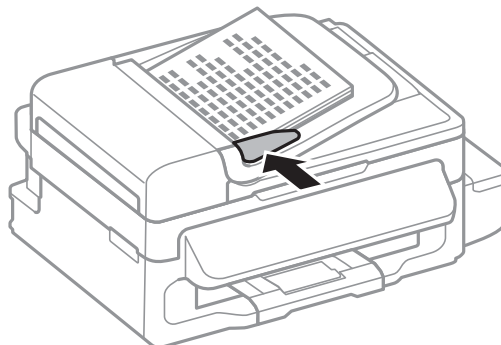

### Related Information

➔ [“Available Originals for the ADF” on page 29](#)

---

## Placing Originals on the Scanner Glass

**!** *Caution:*

*Be careful not to trap your fingers when closing the document cover. Otherwise you may be injured.*

**!** *Important:*

*When placing bulky originals such as books, prevent exterior light from shining directly onto the scanner glass.*

## Placing Originals

1. Open the document cover.

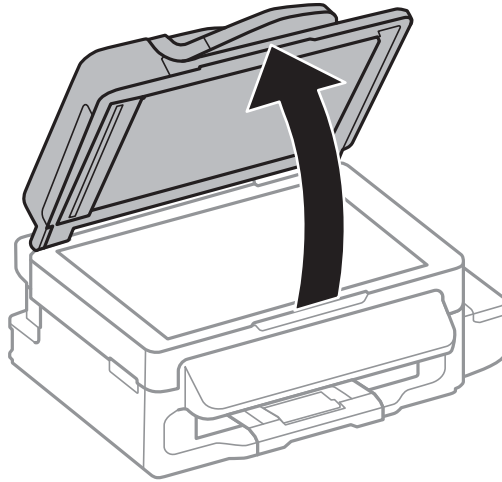

2. Remove any dust or stains on the scanner glass.
3. Place the original face-down and slide it to the corner mark.

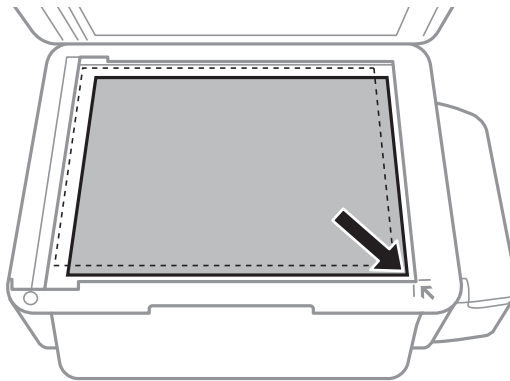

**Note:**

- ❑ A range of 1.5 mm from the edges of the scanner glass is not scanned.
- ❑ When originals are placed in the ADF and on the scanner glass, priority is given to the originals in the ADF.

4. Close the cover gently.

**Note:**

*Remove the originals after scanning or copying. If you leave the originals on the scanner glass for a long time, they may stick to the surface of the glass.*

# Printing

---

## Printing from a Computer

### Printing Basics - Windows

**Note:**

- ❑ See the online help for explanations of the setting items. Right-click an item, and then click **Help**.
- ❑ Operations may differ depending on the application. See the application's help for details.

1. Load paper in the printer.



**Important:**

*Make the paper settings on the control panel.*

2. Open the file you want to print.
3. Select **Print** or **Print Setup** from the **File** menu.
4. Select your printer.



## Printing

5. Select **Preferences** or **Properties** to access the printer driver window.

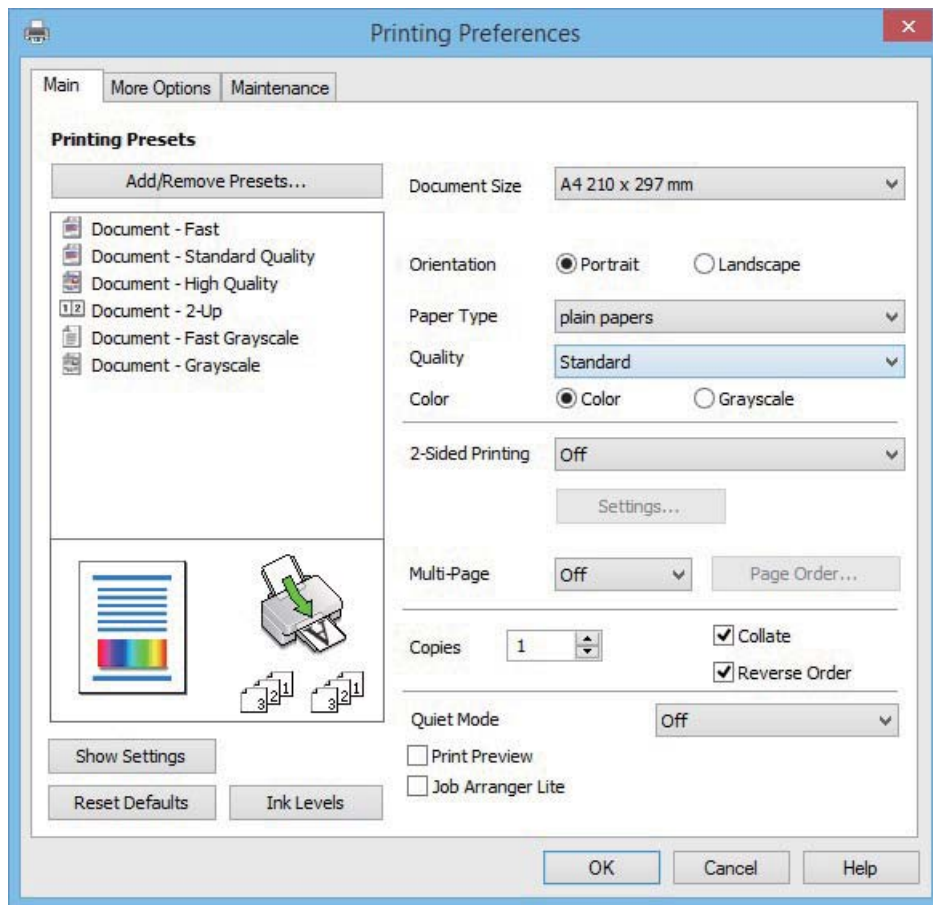

6. Make the following settings.
  - Document Size: Select the paper size you loaded in the printer.
  - Orientation: Select the orientation you set in the application.
  - Paper Type: Select the type of paper you loaded.
  - Color: Select **Grayscale** when you want to print in black or shades of gray.

**Note:**

When printing on envelopes, select *Landscape* as the **Orientation** setting.

7. Click **OK** to close the printer driver window.
8. Click **Print**.

### Related Information

- ➔ [“Available Paper and Capacities” on page 24](#)
- ➔ [“Loading Paper in the Rear Paper Feed” on page 25](#)
- ➔ [“List of Paper Types” on page 24](#)

## Printing

### Printing Basics - Mac OS X

**Note:**

Explanations in the section use *TextEdit* as an example. Operations and screens differ depending on the application. See the application's help for details.

1. Load paper in the printer.



**Important:**

Make the paper settings on the control panel.

2. Open the file you want to print.
3. Select **Print** from the **File** menu or another command to access the print dialog.

If necessary, click **Show Details** or ▼ to expand the print window.

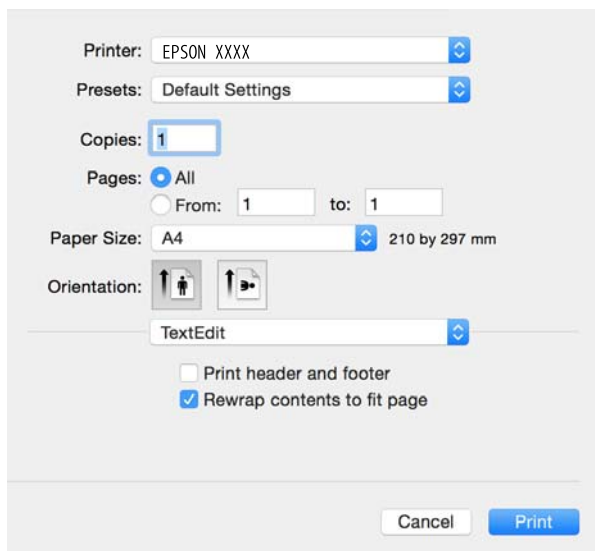

4. Make the following settings.
  - Printer: Select your printer.
  - Presets: Select when you want to use the registered settings.
  - Paper Size: Select the paper size you loaded in the printer.
  - Orientation: Select the orientation you set in the application.

**Note:**

- If the above setting menus are not displayed, close the print window, select **Page Setup** from the **File** menu, and then make settings.
- When printing on envelopes, select landscape orientation.

## Printing

5. Select **Print Settings** from the pop-up menu.

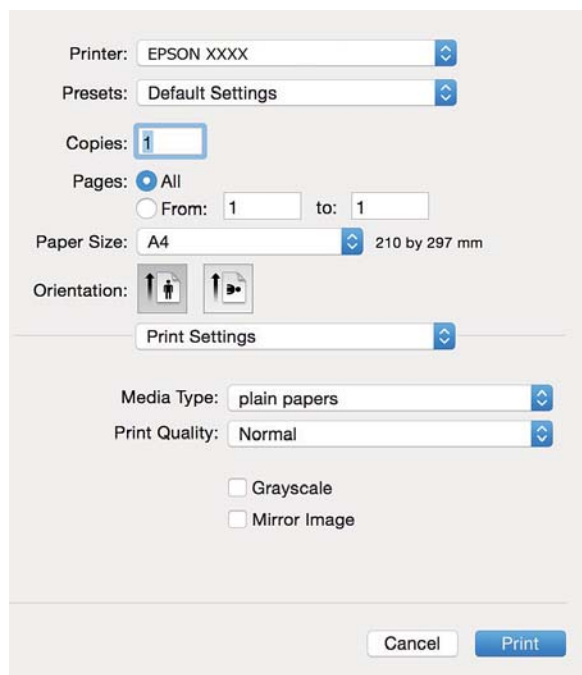

**Note:**

On Mac OS X v10.8.x or later, if the **Print Settings** menu is not displayed, the Epson printer driver has not been installed correctly.

Select **System Preferences** from the  menu > **Printers & Scanners** (or **Print & Scan**, **Print & Fax**), remove the printer, and then add the printer again. See the following to add a printer.

<http://epson.sn>

6. Make the following settings.
  - Media Type: Select the type of paper you loaded.
  - Grayscale: Select to print in black or shades of gray.
7. Click **Print**.

### Related Information

- ➔ “Available Paper and Capacities” on page 24
- ➔ “Loading Paper in the Rear Paper Feed” on page 25
- ➔ “List of Paper Types” on page 24

## Printing

### Printing on 2-Sides (for Windows only)

The printer driver prints automatically separating even pages and odd pages. When the printer has finished printing the odd pages, flip the paper over following the instructions to print the even pages. You can also print a booklet that can be created by folding the printout.



**Note:**

- If you do not use paper that is suitable for 2-sided printing, the print quality may decline and paper jams may occur.
- Depending on the paper and the data, ink may bleed through to the other side of the paper.
- If **EPSON Status Monitor 3** is disabled, access the printer driver, click **Extended Settings** on the **Maintenance** tab, and then select **Enable EPSON Status Monitor 3**.
- 2-sided printing may not be available when the printer is accessed over a network or is used as a shared printer.

1. Load paper in the printer.
2. Open the file you want to print.
3. Access the printer driver window.
4. Select **Manual (Long-edge binding)** or **Manual (Short-edge binding)** from **2-Sided Printing** on the **Main** tab.
5. Click **Settings**, make the appropriate settings, and then click **OK**.

**Note:**

To print as a booklet, select **Booklet**.

6. Set the other items on the **Main** and **More Options** tabs as necessary, and then click **OK**.
7. Click **Print**.

When the first side has finished printing, a pop-up window is displayed on the computer. Follow the on-screen instructions.

#### Related Information

- ➔ [“Available Paper and Capacities” on page 24](#)
- ➔ [“Loading Paper in the Rear Paper Feed” on page 25](#)
- ➔ [“Printing Basics - Windows” on page 32](#)

## Printing

### Printing Several Pages on One Sheet

You can print two or four pages of data on a single sheet of paper.

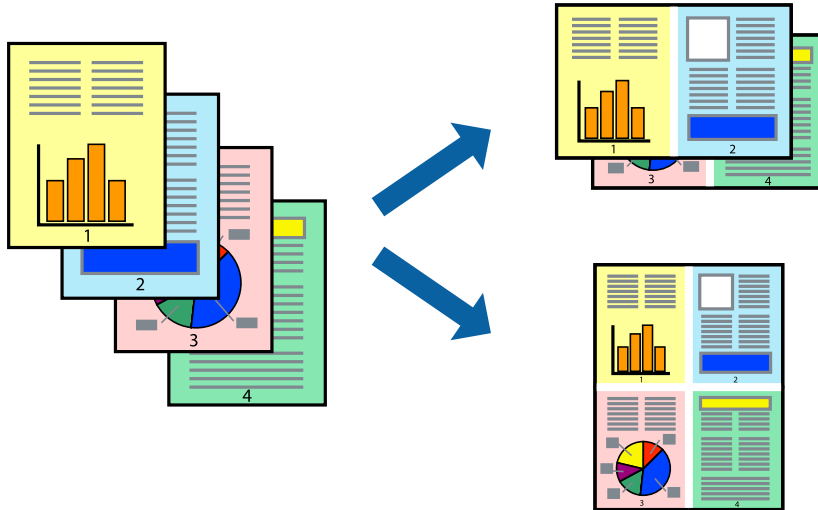

### Printing Several Pages on One Sheet - Windows

1. Load paper in the printer.
2. Open the file you want to print.
3. Access the printer driver window.
4. Select **2-Up** or **4-Up** as the **Multi-Page** setting on the **Main** tab.
5. Click **Page Order**, make the appropriate settings, and then click **OK** to close the window.
6. Set the other items on the **Main** and **More Options** tabs as necessary, and then click **OK**.
7. Click **Print**.

#### Related Information

- ➔ [“Loading Paper in the Rear Paper Feed” on page 25](#)
- ➔ [“Printing Basics - Windows” on page 32](#)

### Printing Several Pages on One Sheet - Mac OS X

1. Load paper in the printer.
2. Open the file you want to print.
3. Access the print dialog.
4. Select **Layout** from the pop-up menu.
5. Set the number of pages in **Pages per Sheet**, the **Layout Direction** (page order), and **Border**.

## Printing

6. Set the other items as necessary.
7. Click **Print**.

### Related Information

- ➔ [“Loading Paper in the Rear Paper Feed” on page 25](#)
- ➔ [“Printing Basics - Mac OS X” on page 34](#)

## Printing to Fit the Paper Size

You can print to fit the paper size you loaded in the printer.



## Printing to Fit the Paper Size - Windows

1. Load paper in the printer.
2. Open the file you want to print.
3. Access the printer driver window.
4. Make the following settings on the **More Options** tab.
  - Document Size: Select the paper size you set in the application.
  - Output Paper: Select the paper size you loaded in the printer.  
**Fit to Page** is selected automatically.

*Note:*  
*If you want to print a reduced image at the center of the page, select **Center**.*
5. Set the other items on the **Main** and **More Options** tabs as necessary, and then click **OK**.
6. Click **Print**.

### Related Information

- ➔ [“Loading Paper in the Rear Paper Feed” on page 25](#)
- ➔ [“Printing Basics - Windows” on page 32](#)

## Printing

### Printing to Fit the Paper Size - Mac OS X

1. Load paper in the printer.
2. Open the file you want to print.
3. Access the print dialog.
4. Select the size of the paper you set in the application as the **Paper Size** setting.
5. Select **Paper Handling** from the pop-up menu.
6. Select **Scale to fit paper size**.
7. Select the paper size you loaded in the printer as the **Destination Paper Size** setting.
8. Set the other items as necessary.
9. Click **Print**.

#### Related Information

- ➔ [“Loading Paper in the Rear Paper Feed” on page 25](#)
- ➔ [“Printing Basics - Mac OS X” on page 34](#)

### Printing Multiple Files Together (for Windows Only)

**Job Arranger Lite** allows you to combine several files created by different applications and print them as a single print job. You can specify the print settings for combined files, such as layout, print order, and orientation.

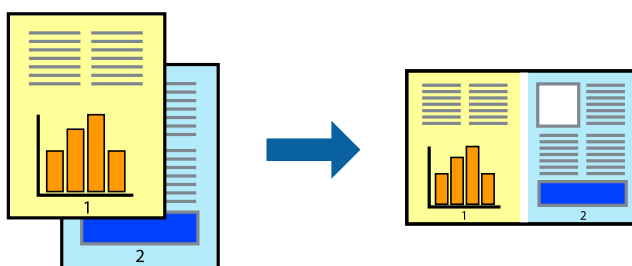

#### Note:

To open a **Print Project** saved in **Job Arranger Lite**, click **Job Arranger Lite** on the printer driver's **Maintenance** tab. Next, select **Open** from the **File** menu to select the file. The extension of the saved files is ".ecl".

1. Load paper in the printer.
2. Open the file you want to print.
3. Access the printer driver window.
4. Select **Job Arranger Lite** on the **Main** tab.
5. Click **OK** to close the printer driver window.

## Printing

- Click **Print**.

The **Job Arranger Lite** window is displayed and the print job is added to the **Print Project**.

- With the **Job Arranger Lite** window opened, open the file that you want to combine with the current file, and then repeat steps 3 to 6.

**Note:**

*If you close the **Job Arranger Lite** window, the unsaved **Print Project** is deleted. To print later, select **Save** from the **File** menu.*

- Select the **Layout** and **Edit** menus in **Job Arranger Lite** to edit the **Print Project** as necessary.
- Select **Print** from the **File** menu.

### Related Information

- ➔ [“Loading Paper in the Rear Paper Feed” on page 25](#)
- ➔ [“Printing Basics - Windows” on page 32](#)

## Printing One Image on Multiple Sheets to Create a Poster (for Windows Only)

This feature allows you to print one image on multiple sheets of paper. You can create a larger poster by taping them together.

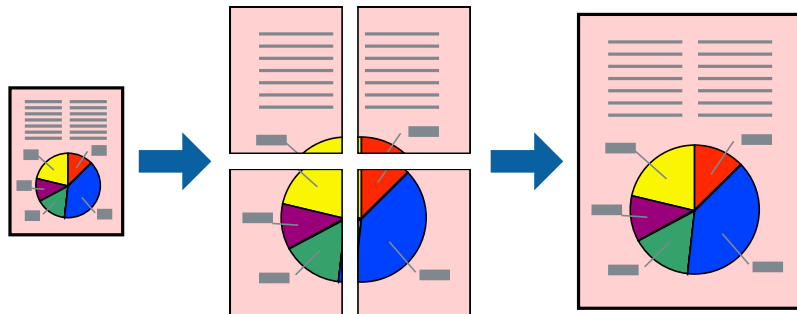

- Load paper in the printer.
- Open the file you want to print.
- Access the printer driver window.
- Select **2x1 Poster**, **2x2 Poster**, **3x3 Poster**, or **4x4 Poster** from **Multi-Page** on the **Main** tab.
- Click **Settings**, make the appropriate settings, and then click **OK**.
- Set the other items on the **Main** and **More Options** tabs as necessary, and then click **OK**.
- Click **Print**.

### Related Information

- ➔ [“Loading Paper in the Rear Paper Feed” on page 25](#)
- ➔ [“Printing Basics - Windows” on page 32](#)



## Printing

### Making Posters Using Overlapping Alignment Marks

Here is an example of how to make a poster when **2x2 Poster** is selected, and **Overlapping Alignment Marks** is selected in **Print Cutting Guides**.

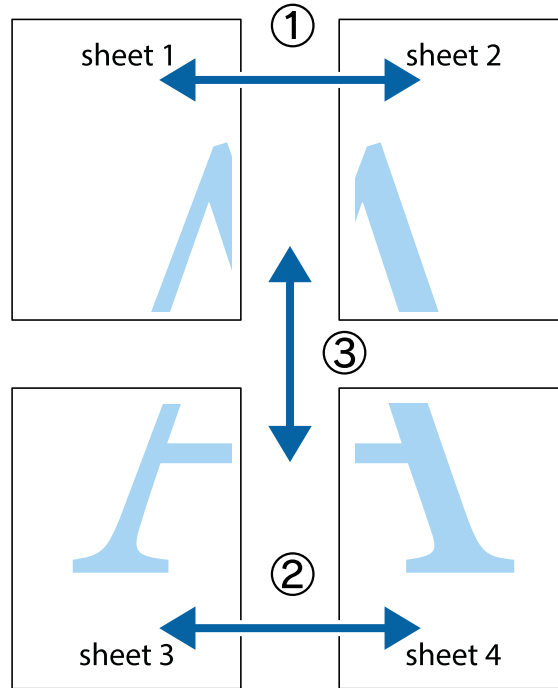

1. Prepare Sheet 1 and Sheet 2. Cut off the margins of Sheet 1 along the vertical blue line through the center of the top and bottom cross marks.

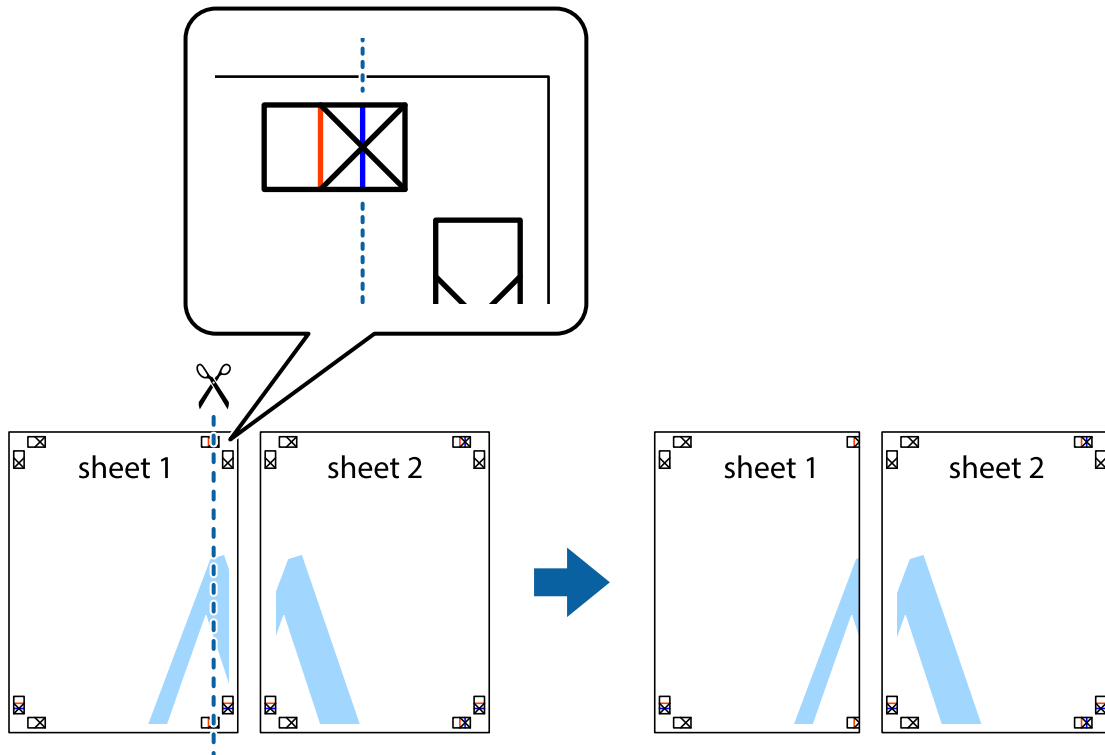

### Printing

2. Place the edge of Sheet 1 on top of Sheet 2 and align the cross marks, then temporarily tape the two sheets together from the back.

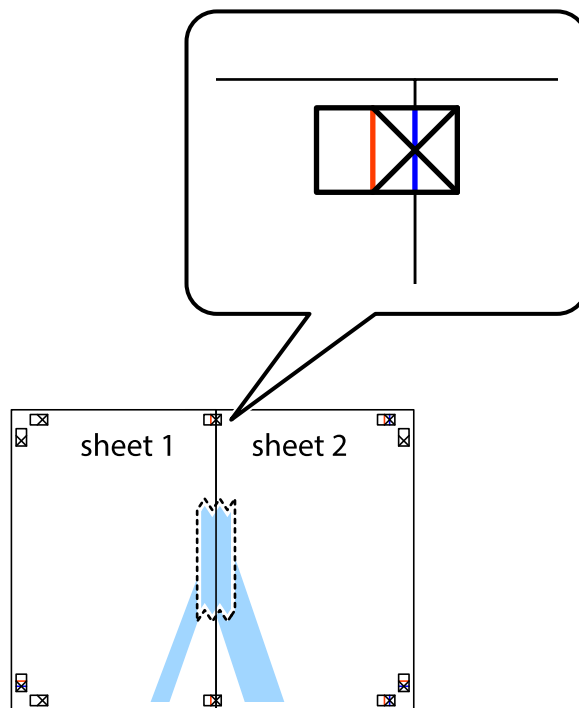

3. Cut the taped sheets in two along the vertical red line through the alignment markers (this time, the line to the left of the cross marks).

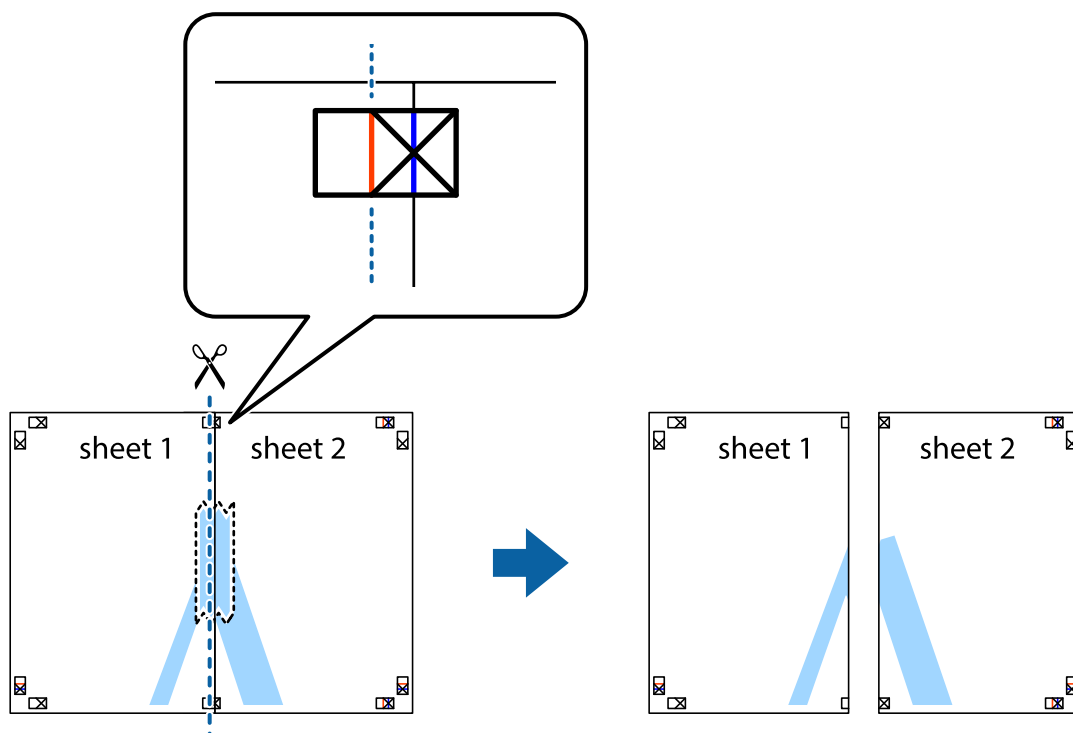

## Printing

4. Tape the sheets together from the back.

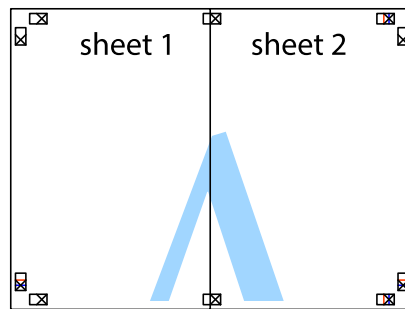

5. Repeat steps 1 to 4 to tape Sheet 3 and Sheet 4 together.
6. Cut off the margins of Sheet 1 and Sheet 2 along the horizontal blue line through the center of the left and right side cross marks.

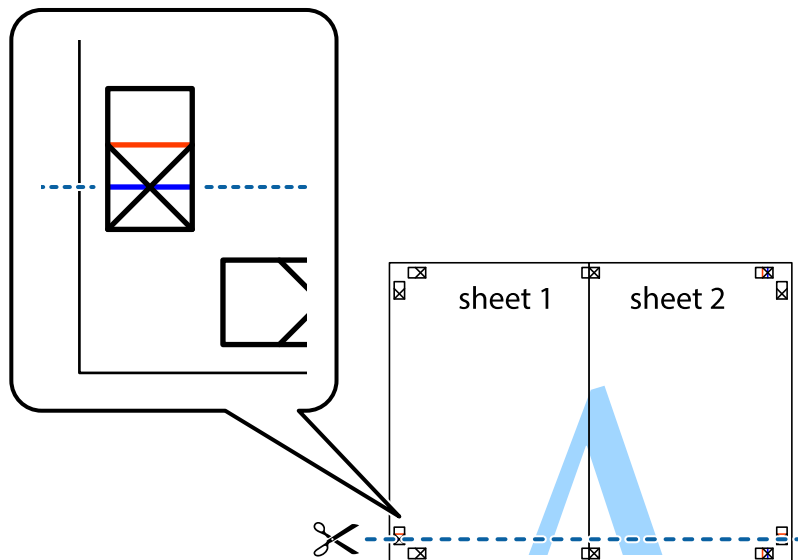

## Printing

7. Place the edge of Sheet 1 and Sheet 2 on top of Sheet 3 and Sheet 4 and align the cross marks, and then temporarily tape them together from the back.

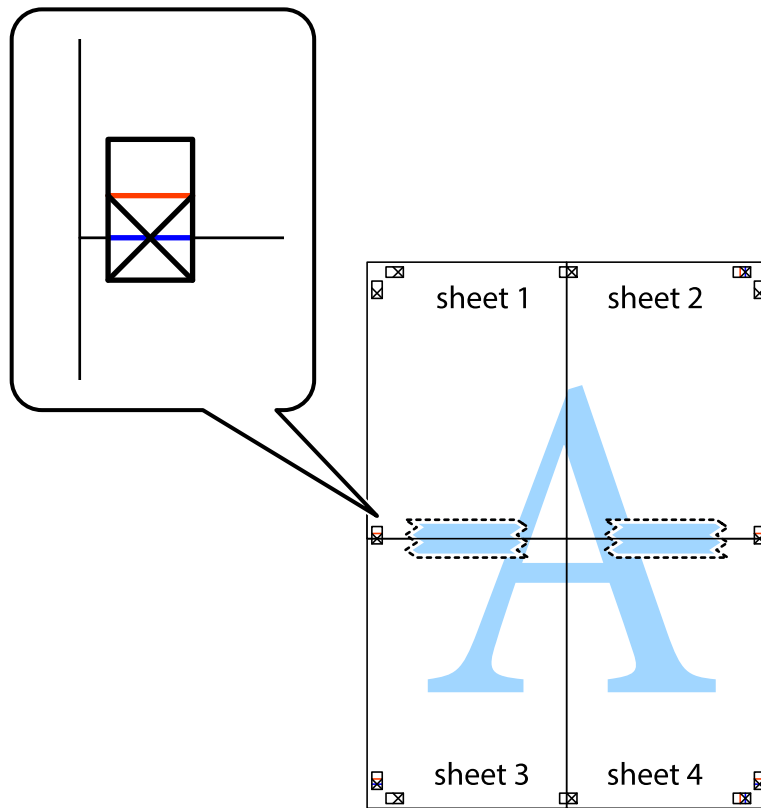

### Printing

- Cut the taped sheets in two along the horizontal red line through the alignment markers (this time, the line above the cross marks).

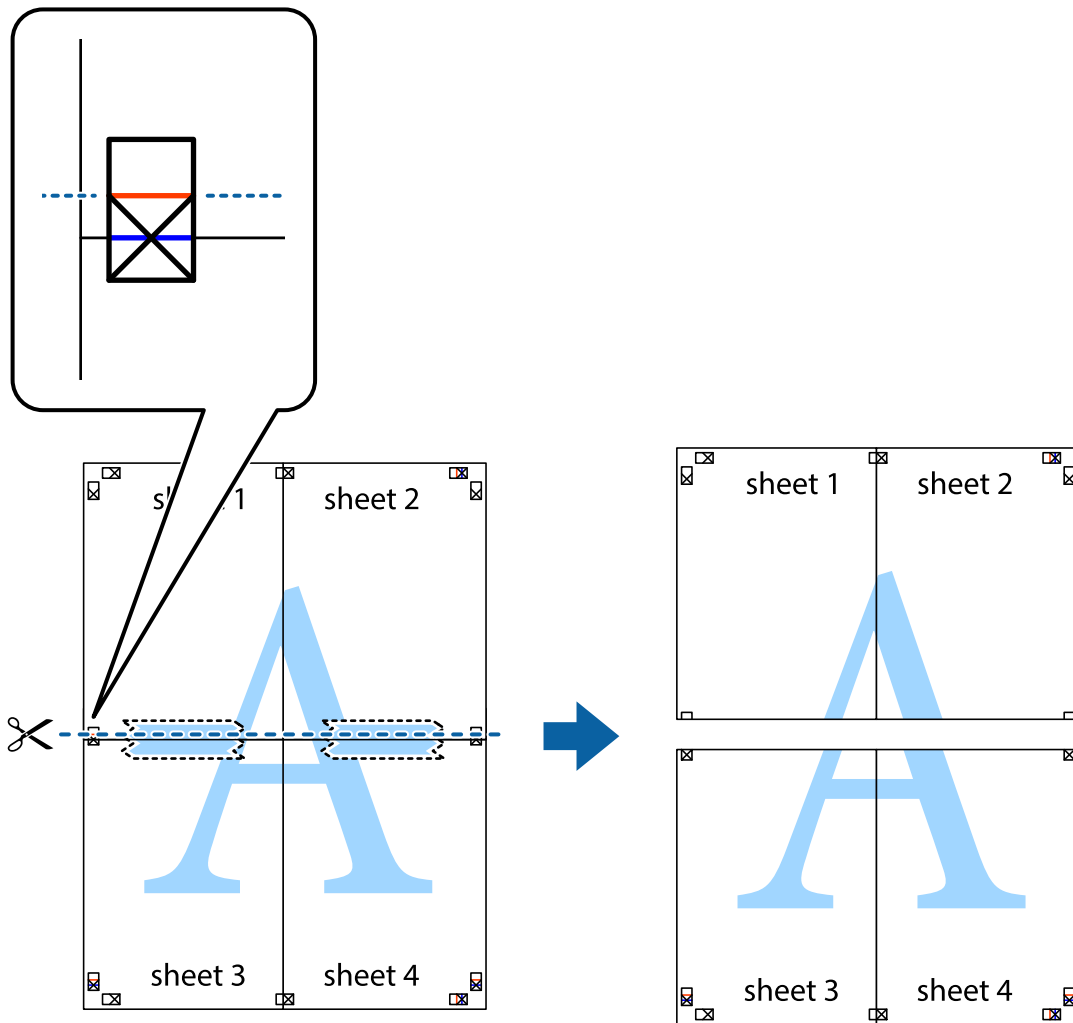

- Tape the sheets together from the back.



## Printing

10. Cut off the remaining margins along the outer guide.

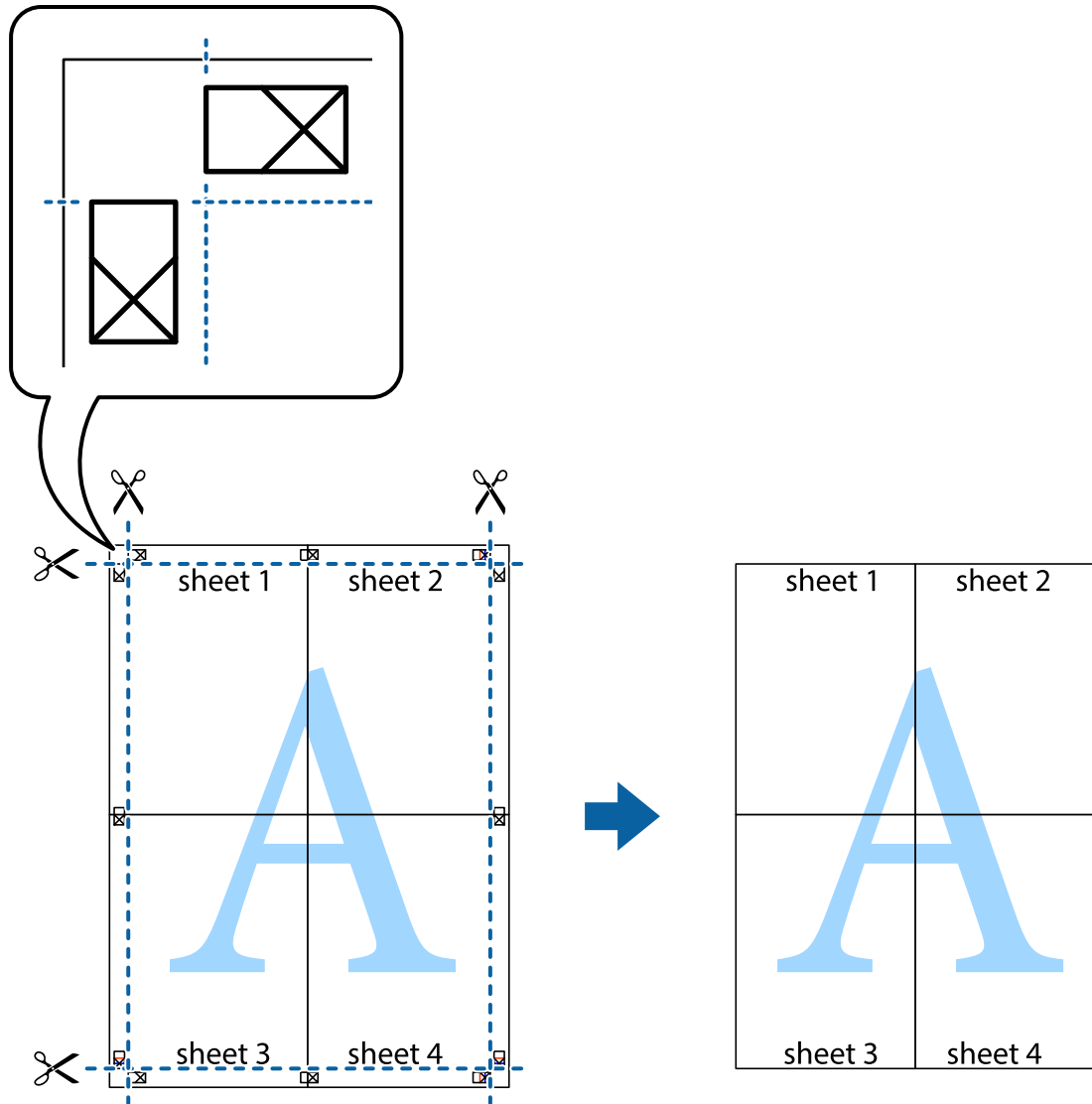

## Printing Using Advanced Features

This section introduces a variety of additional layout and printing features available on the printer driver.

### Related Information

- ➔ [“Windows Printer Driver” on page 91](#)
- ➔ [“Mac OS X Printer Driver” on page 92](#)

## Adding a Printing Preset to Print Easily

If you create your own preset of frequently used print settings on the printer driver, you can print easily by selecting the preset from the list.

## Printing

### Windows

To add your own preset, set items such as the **Document Size** and **Paper Type** on the **Main** or **More Options** tab, and then click **Add/Remove Presets** in **Printing Presets**.

**Note:**

To delete an added preset, click **Add/Remove Presets**, select the preset name you want to delete from the list, and then delete it.

### Mac OS X

Access the print dialog. To add your own preset, set items such as the **Paper Size** and **Media Type**, and then save the current settings as the preset in the **Presets** setting.

**Note:**

To delete an added preset, click **Presets > Show Presets**, select the preset name you want to delete from the list, and then delete it.

## Printing a Reduced or Enlarged Document

You can reduce or enlarge the size of a document by a specific percentage.

### Windows

Set the **Document Size** on the **More Options** tab. Select **Reduce/Enlarge Document**, **Zoom to**, and then enter a percentage.

### Mac OS X

**Note:**

Operations differ depending on the application. See the application's help for details.

Select **Page Setup** (or **Print**) from the **File** menu. Select the printer from **Format For**, select the paper size, and then enter a percentage in **Scale**. Close the window, and then print following the basic printing instructions.

## Adjusting the Print Color

You can adjust the colors used in the print job.

**PhotoEnhance** produces sharper images and more vivid colors by automatically adjusting the contrast, saturation, and brightness of the original image data.

**Note:**

These adjustments are not applied to the original data.

**PhotoEnhance** adjusts the color by analyzing the location of the subject. Therefore, if you have changed the location of the subject by reducing, enlarging, cropping, or rotating the image, the color may change unexpectedly. If the image is out of focus, the tone may be unnatural. If the color is changed or becomes unnatural, print in a mode other than **PhotoEnhance**.

### Windows

Select the method of color correction from **Color Correction** on the **More Options** tab.

If you select **Automatic**, the colors are automatically adjusted to match the paper type and print quality settings. If you select **Custom** and click **Advanced**, you can make your own settings.

## Printing

### Mac OS X

Access the print dialog. Select **Color Matching** from the pop-up menu, and then select **EPSON Color Controls**. Select **Color Options** from the pop-up menu, and then select one of the available options. Click the arrow next to **Advanced Settings** and make the appropriate settings.

### Printing a Watermark (for Windows Only)

You can print a watermark such as "Confidential" on your printouts. You can also add your own watermark.

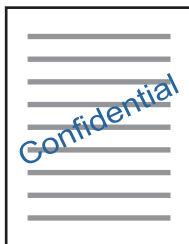

Click **Watermark Features** on the **More Options** tab, and then select a watermark. Click **Settings** to change details such as the density and position of the watermark.

### Printing a Header and Footer (for Windows Only)

You can print information such as a user name and printing date as headers or footers.

Click **Watermark Features** in the **More Options** tab, and then select **Header/Footer**. Click **Settings** and select necessary items from the drop-down list.

## Printing Photos Using Epson Easy Photo Print

Epson Easy Photo Print lets you lay out and print photos easily on various types of paper. See the application's help for details.

**Note:**

*By printing on genuine Epson photo paper, the ink quality is maximized and the printouts are vivid and clear.*

### Related Information

- ➔ [“Available Paper and Capacities” on page 24](#)
- ➔ [“Loading Paper in the Rear Paper Feed” on page 25](#)
- ➔ [“Epson Easy Photo Print” on page 95](#)

---

## Printing from Smart Devices

### Using Epson iPrint

Epson iPrint is an application that allows you to print photos, documents, and web pages from a smart device such as a smartphone or tablet. You can use local print, printing from a smart device that is connected to the same



## Printing

wireless network as your printer, or remote print, printing from a remote location over the Internet. To use remote print, register your printer in the Epson Connect service.



### Related Information

➔ “Epson Connect Service” on page 89

## Installing Epson iPrint

You can install Epson iPrint on your smart device from the following URL or QR code.

<http://ipr.to/c>



## Printing Using Epson iPrint

Start Epson iPrint from your smart device and select the item you want to use from the home screen.

The following screens are subject to change without notice.

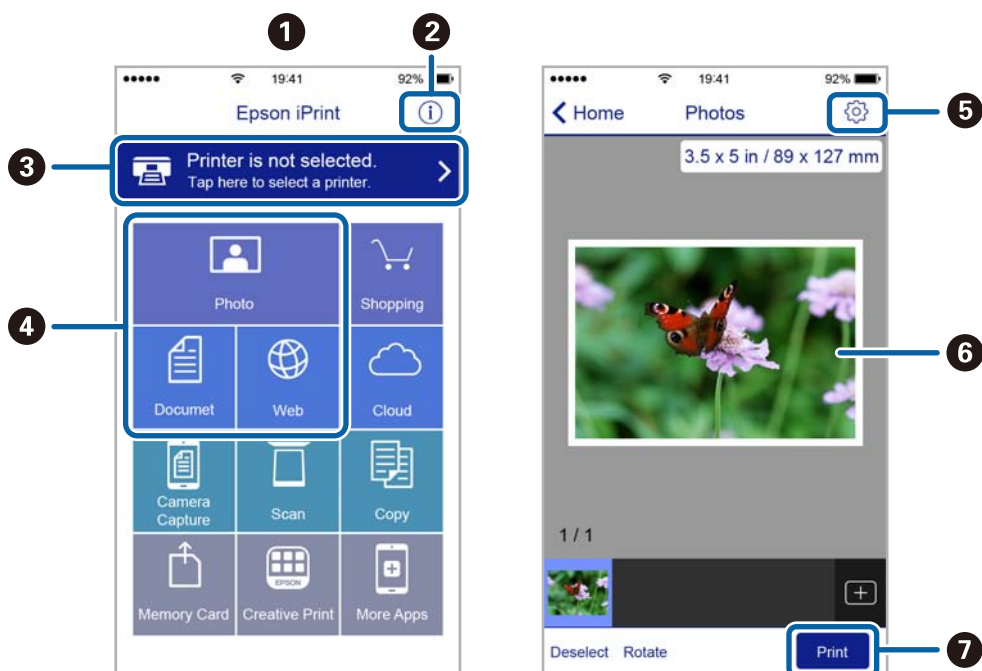

## Printing

①	Home screen displayed when the application is started.
②	Displays information on how to setup the printer and a FAQ.
③	Displays the screen where you can select the printer and make printer settings. Once you have selected the printer, you do not need to select it again from the next time.
④	Select what you want to print such as photos, documents, and web pages.
⑤	Displays the screen to make print settings such as paper size and paper type.
⑥	Displays photos and documents you selected.
⑦	Starts printing.

**Note:**

To print from the document menu using iPhone, iPad, and iPod touch running iOS, start Epson iPrint after transferring the document you want to print using the file sharing function in iTunes.

## Using AirPrint

AirPrint allows you to wirelessly print to your AirPrint-enabled printer from your iOS device using the latest version of iOS and from your Mac OS X v10.7.x or later.



**Note:**

See the AirPrint page of the Apple website for more details.

1. Load paper in the printer.
2. Connect your device to the same wireless network that your printer is using.
3. Print from your device to your printer.

### Related Information

➔ [“Loading Paper in the Rear Paper Feed” on page 25](#)

---

## Canceling Printing

**Note:**

- ❑ *In Windows, you cannot cancel a print job from the computer once it has been completely sent to the printer. In this case, cancel the print job by using the printer's control panel.*
- ❑ *When printing several pages from Mac OS X, you cannot cancel all of the jobs by using the control panel. In this case, cancel the print job from the computer.*
- ❑ *If you have sent a print job from Mac OS X v10.6.8 through the network, you may not be able to cancel printing from the computer. In this case, cancel the print job by using the printer's control panel. You need to change settings in Web Config to cancel printing from the computer. See the Network Guide for more details.*

### Canceling Printing - Printer Button

Press the  button to cancel the print job in progress.

### Canceling Printing - Windows

1. Access the printer driver window.
2. Select the **Maintenance** tab.
3. Click **Print Queue**.
4. Right-click on the job you want to cancel and then select **Cancel**.

**Related Information**

➔ [“Windows Printer Driver” on page 91](#)

### Canceling Printing - Mac OS X

1. Click the printer icon in the **Dock**.
2. Select the job you want to cancel.
3. Cancel the job.
  - ❑ Mac OS X v10.8.x or later  
Click  next to the progress meter.
  - ❑ Mac OS X v10.6.8 to v10.7.x  
Click **Delete**.

# Copying

1. Load paper in the printer.
2. Place the originals.
3. Enter **Copy** from the home screen.
4. Press the ▲ and ▼ buttons to enter the number of copies.
5. Press the OK button.
6. Select **Layout**, and then select the appropriate layout.
7. Press the ▼ button, and then make other settings as necessary.
8. Press the ⬠ button.

## Related Information

- ➔ [“Loading Paper in the Rear Paper Feed” on page 25](#)
- ➔ [“Placing Originals” on page 29](#)
- ➔ [“Copy Mode” on page 15](#)

# Scanning

---

## Scanning Using the Control Panel

### Scanning to the Cloud

You can send scanned images to cloud services using Epson Connect.

See the Epson Connect portal website for details.

<https://www.epsonconnect.com/>

<http://www.epsonconnect.eu> (Europe only)

#### Related Information

➔ [“Scan Mode” on page 16](#)

### Scanning to a Computer

**Important:**

*Make sure you have installed the EPSON Scan and Epson Event Manager on your computer before using this feature.*

1. Place the originals.
2. Enter **Scan** from the home screen.
3. Select **Computer**.
4. Select the computer to which you want to save the scanned images.

**Note:**

- You can change to frequently-used scan settings such as the document type, folder to save, or save format by using Epson Event Manager.
  - When the printer is connected to a network, up to 20 computers can be displayed on the printer's control panel.
  - When the computer to which you want to save the scanned images is detected on the network, the initial 15 characters of the computer's name are displayed on the control panel. If you set a network scan name in Epson Event Manager, it is displayed on the control panel.
5. Press the OK button, and then select the file format.
  6. Press the  button.

#### Related Information

- ➔ [“Placing Originals” on page 29](#)
- ➔ [“Epson Event Manager” on page 93](#)
- ➔ [“Scan Mode” on page 16](#)

## Scanning to a Computer (WSD)

**Note:**

- ❑ *This feature is only available for computers running Windows 8.1/Windows 8/Windows 7/Windows Vista.*
- ❑ *If you are using Windows 7/Windows Vista, you need to setup your computer in advance using this feature. See the Network Guide for more details.*

1. Place the originals.
2. Enter **Scan** from the home screen.
3. Select **Computer (WSD)**.
4. Select a computer.
5. Press the  button.

**Related Information**

- ➔ [“Placing Originals” on page 29](#)
- ➔ [“Scan Mode” on page 16](#)

---

## Scanning from a Computer

Scan using the scanner driver "EPSON Scan". See the EPSON Scan help for an explanation of each setting item.

### Scanning Basics

This section uses EPSON Scan's **Home Mode** to explain the basics of scanning. The operation work flow is the same in other scanning modes.

**Note:**

*You cannot use **Home Mode** when scanning from ADF. Scan from scanner glass or use **Office Mode** or **Professional Mode**.*

1. Place the originals.
2. Start EPSON Scan.

## Scanning

3. Select **Home Mode** from the **Mode** list.

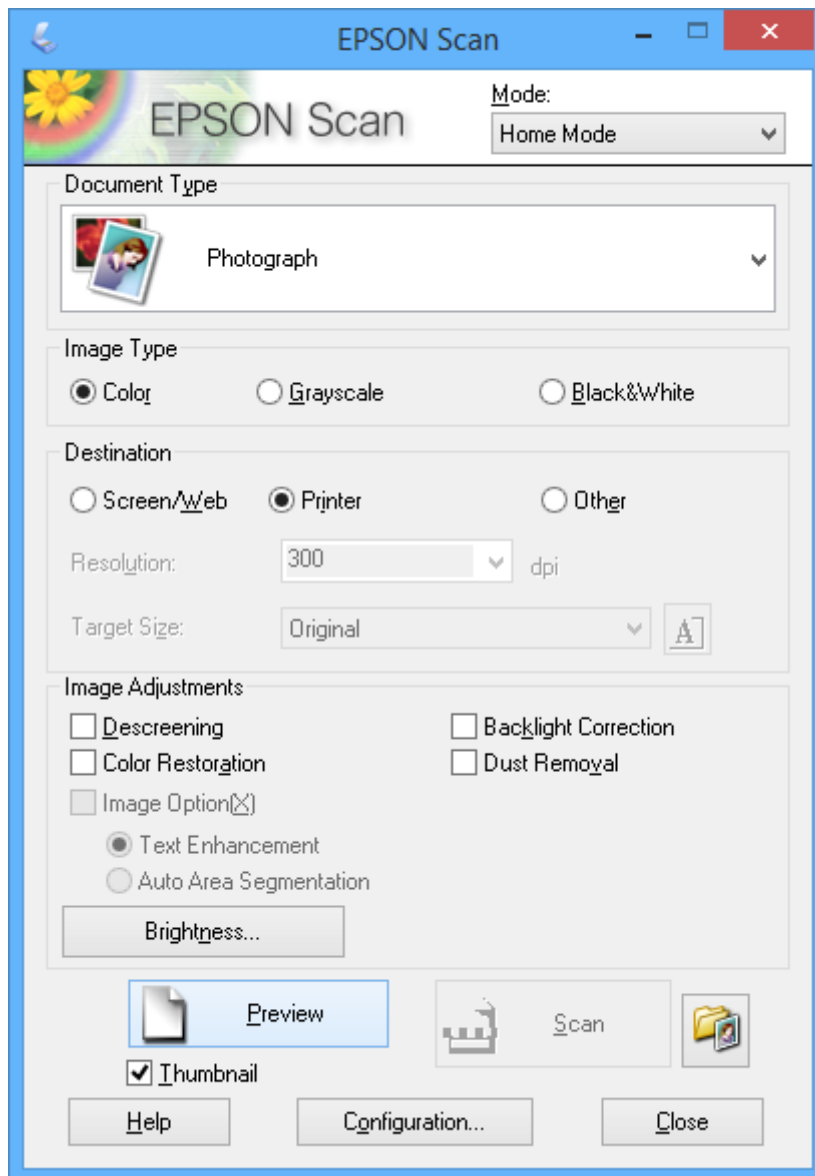

4. Make the following settings.

- Document Type:** Select the type of the original you want to scan.
- Image Type:** Select the color type of the image you want to scan.  
Although this is automatically selected by the **Document Type** setting, you can change the setting.
- Destination:** Select the resolution of the image you want to scan.  
If you select **Other**, you can set **Resolution**.
- Thumbnail:** Only available if you select **Photograph** as the Document Type setting.  
If you select this item and click **Preview**, you can scan by automatically detecting the scan area, direction, or skew of the document, or place multiple photos on the scanner glass.

## Scanning

5. Click **Preview**.

**Note:**

- ❑ Depending on the photos and the scanning conditions, the scan results may not be as intended. Clear **Thumbnail**, and only place one photo.
- ❑ When placing multiple photos, place them at least 20 mm (0.8 inch) apart. Also, the edge area of the scanner glass is not scanned.

6. Adjust the quality or brightness of the image as necessary.

**Note:**

Depending on the originals, the scan results may not be as intended.

7. Click **Scan**.

8. In the **File Save Settings** screen, make appropriate settings such as the file name, location, and image format type, and then click **OK**.

**Note:**

When **Show this dialog box before next scan** is cleared, the **File Save Settings** screen is not displayed and scanning starts immediately. To display the **File Save Settings** screen, click the  (**File Save Settings**) icon to the right of **Scan** before starting to scan.

### Related Information

- ➔ [“Placing Originals” on page 29](#)
- ➔ [“EPSON Scan \(Scanner Driver\)” on page 93](#)

## Scanning Using Advanced Features

### Scanning at Specified Sizes (Office Mode)

You can scan originals at the specified size without previewing the image. By using the ADF, you can scan many documents rapidly. Select **Office Mode** from the **Mode** list in EPSON Scan.



## Scanning

### Note:

- ❑ If you want to scan many documents to one file, save in PDF format.
- ❑ If you are using the ADF and want to click **Preview**, only load the first page of the original you want to preview. After previewing, load the entire original including the first page you have previewed, and then click **Scan**.

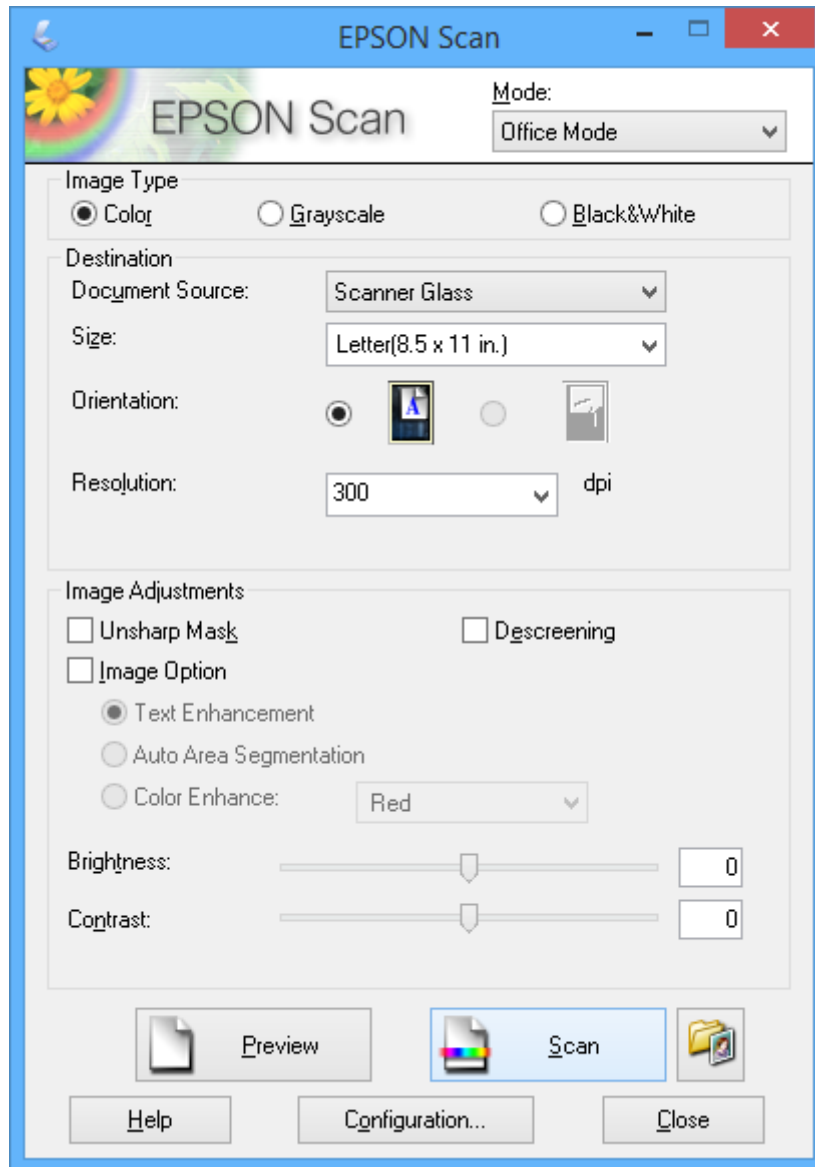

## Scanning by Adjusting the Image Quality (Professional Mode)

You can scan images while adjusting the quality and color. This mode is recommended for advanced users. Select **Professional Mode** from the **Mode** list in EPSON Scan.

## Scanning

### Note:

- If you want to scan using the ADF, select **ADF** as the **Document Source**.
- If you are using the ADF and want to click **Preview**, only load the first page of the original you want to preview. After previewing, load the entire original including the first page you have previewed, and then click **Scan**.

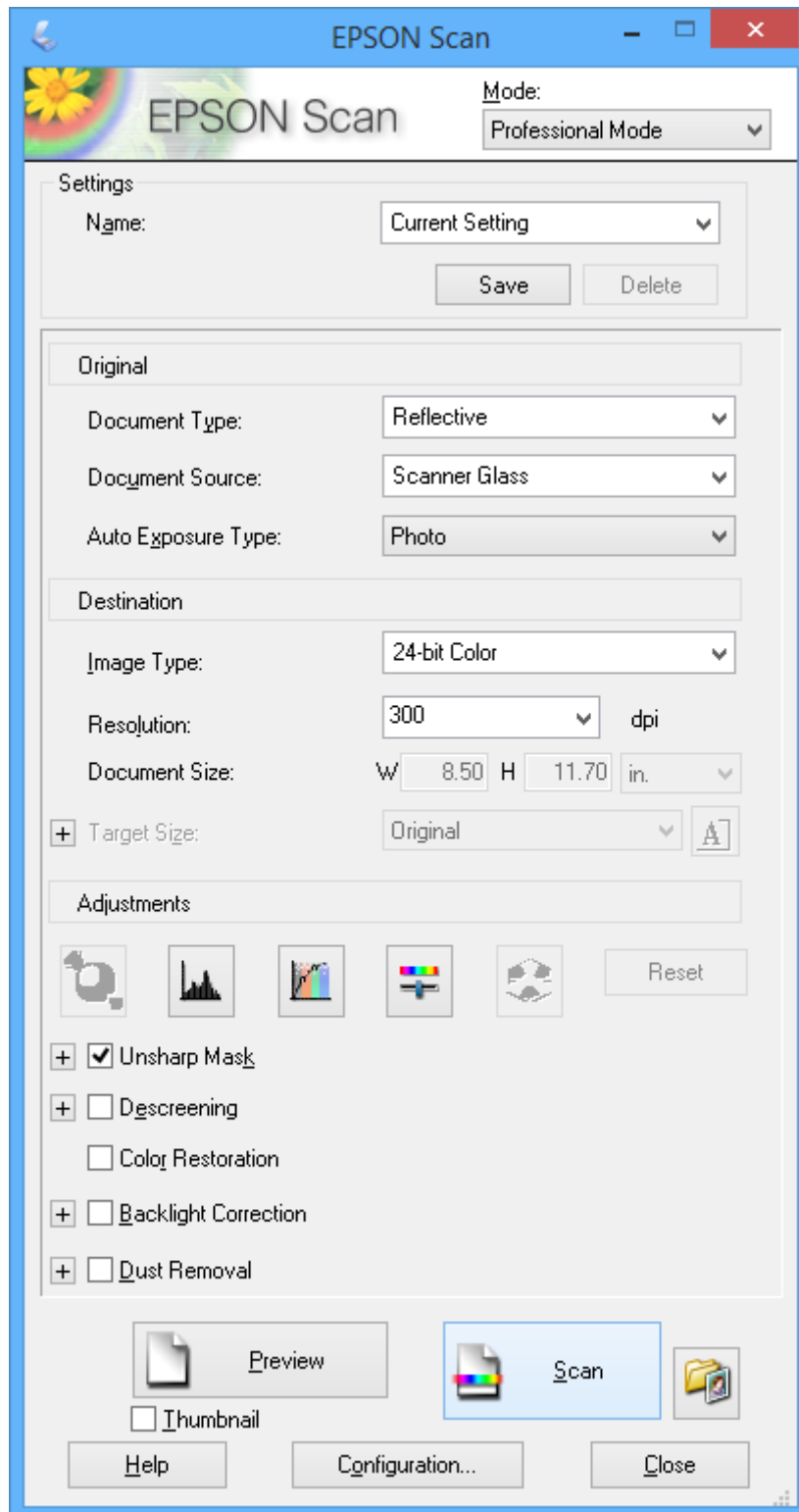

# Scanning from Smart Devices

Epson iPrint is an application that allows you to scan photos and documents from a smart device, such as a smartphone or tablet, that is connected to the same wireless network as your printer. You can save the scanned data on a smart device or to Cloud services, send it by email, or print it.

## Related Information

➔ “Epson Connect Service” on page 89

## Installing Epson iPrint

You can install Epson iPrint on your smart device from the following URL or QR code.

<http://ipr.to/c>



## Using Epson iPrint

Start Epson iPrint from your smart device and select the item you want to use from the home screen.

The following screens are subject to change without notice.

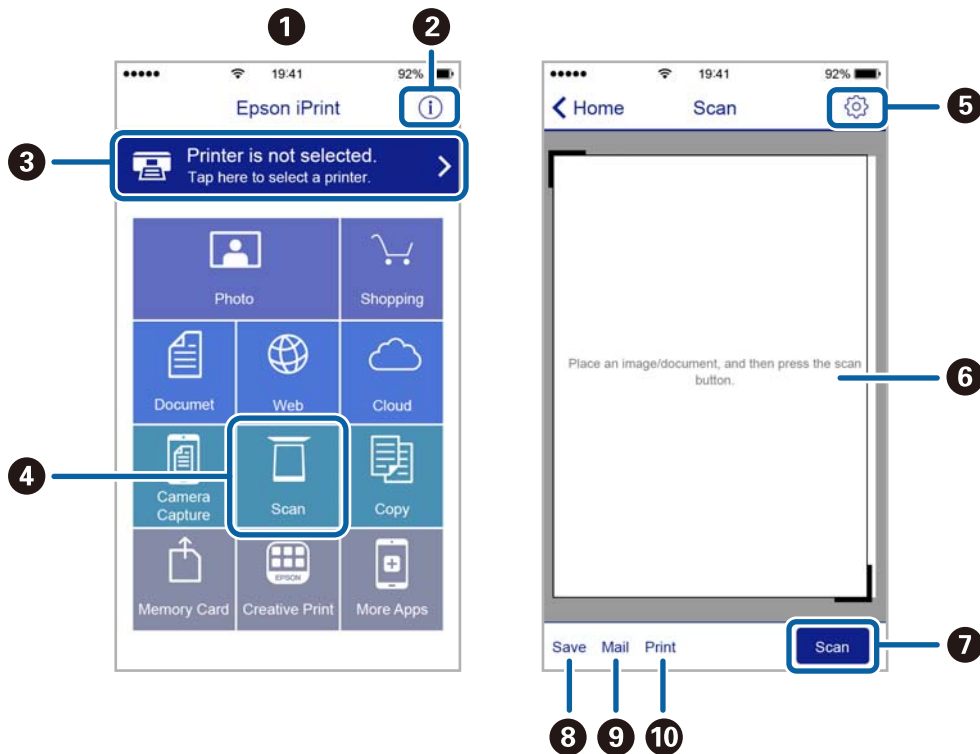

**Scanning**

①	Home screen displayed when the application is started.
②	Displays information on how to setup the printer and a FAQ.
③	Displays the screen where you can select the printer and make printer settings. Once you have selected the printer, you do not need to select it again from the next time.
④	Displays the scanning screen.
⑤	Displays the screen where you can make scan settings such as resolution.
⑥	Displays scanned images.
⑦	Starts scanning.
⑧	Displays the screen where you can save scanned data to a smart device or Cloud services.
⑨	Displays the screen where you can send scanned data by email.
⑩	Displays the screen where you can print scanned data.

# Faxing

---

## Setting Up a Fax

### Connecting to a Phone Line

#### Compatible Telephone Lines

You can use the printer over standard analogue telephone lines (PSTN = Public Switched Telephone Network) and PBX (Private Branch Exchange) telephone systems.

You may not be able to use the printer with the following phone lines or systems.

- VoIP phone line such as DSL or fiber-optic digital service
- Digital phone line (ISDN)
- Some PBX telephone systems
- When adapters such as terminal adapters, VoIP adapters, splitters, or DSL router are connected between the telephone wall jack and the printer

#### Connecting the Printer to a Phone Line

Connect the printer to a telephone wall jack using an RJ-11 (6P2C) phone cable. When connecting a telephone to the printer, use a second RJ-11 (6P2C) phone cable.

Depending on the area, a phone cable may be included with the printer. If it is included, use that cable.

You may need to connect the phone cable to an adapter provided for your country or region.

**Important:**

*Remove the cap from the EXT. port of the printer only when connecting your telephone to the printer. Do not remove the cap if you are not connecting your telephone.*

In areas where lightning strikes occur frequently, we recommend that you use a surge protector.

## Faxing

### Connecting to a Standard Phone Line (PSTN) or PBX

Connect a phone cable from the telephone wall jack or PBX port to the LINE port on the back of the printer.

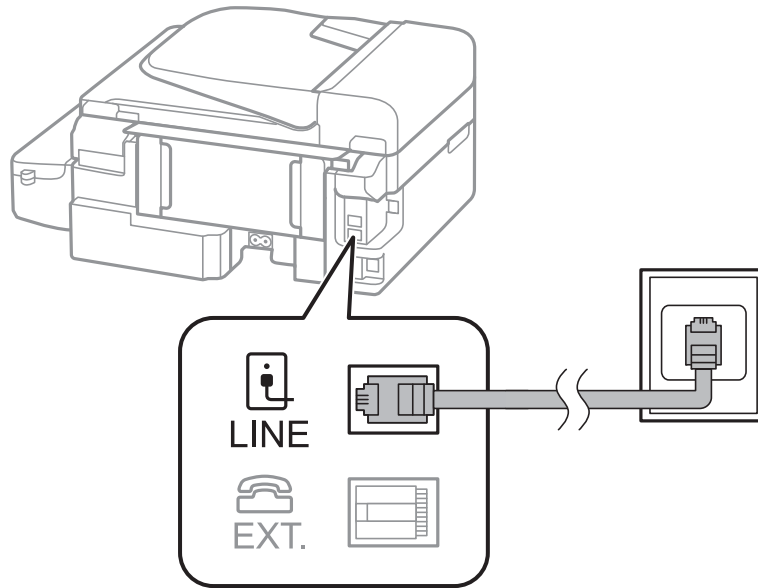

### Related Information

➔ [“Making Settings for a PBX Phone System” on page 66](#)

### Connecting to DSL or ISDN

Connect a phone cable from the DSL modem or the ISDN terminal adapter to the LINE port on the back of the printer. See the documentation provided with the modem or the adapter for more details.

**Note:**

*If your DSL modem is not equipped with a built-in DSL filter, connect a separate DSL filter.*

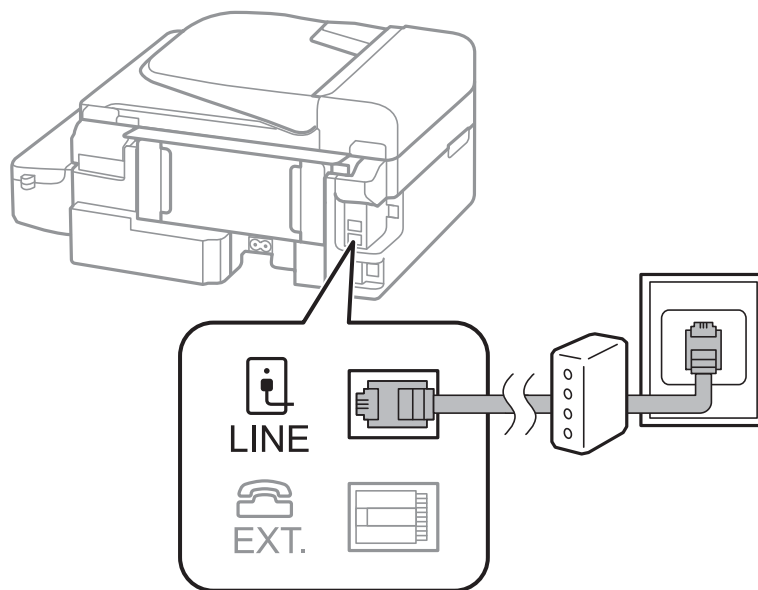

## Faxing

### Connecting Your Phone Device to the Printer

When using the printer and your telephone on a single phone line, connect the telephone to the printer.

**Note:**

- ❑ *If your phone device has a fax function, disable the fax function before connecting. See the documentation provided with the phone device for more details.*
- ❑ *Set the number of **Rings to Answer** before receiving faxes to a larger number than for the answering machine.*

1. Remove the cap from the EXT. port on the back of the printer.

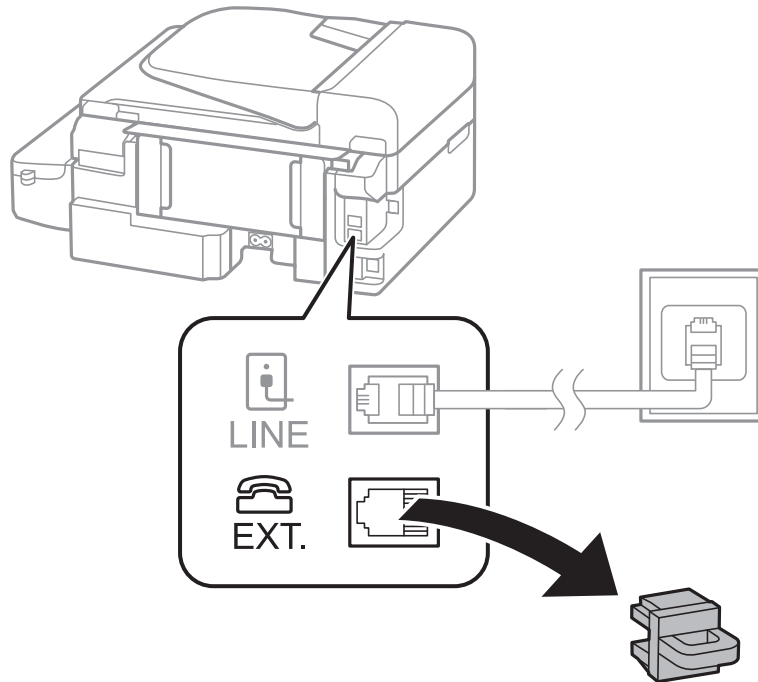

## Faxing

2. Connect the phone device and the EXT. port with a phone cable.

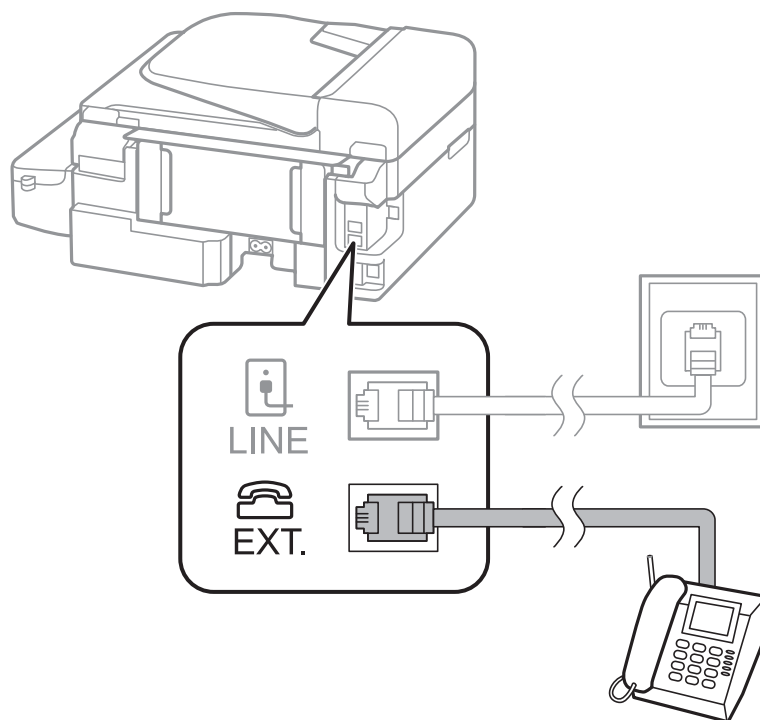

### **!** Important:

*When sharing a single phone line, make sure you connect the phone device to the EXT. port of the printer. If you split the line to connect the phone device and the printer separately, the phone and the printer do not work correctly.*

3. Pick up the handset of the connected phone device and confirm that a message asking you to select whether to send or receive a fax is displayed on the LCD screen.

If the message is not displayed, check that the phone cable is securely connected to the EXT. port.

### Related Information

➔ [“Settings for the Answering Machine” on page 71](#)

## Making Basic Fax Settings

First make basic fax settings such as **Receive Mode** using the **Fax Setting Wizard**, and then configure the other settings as necessary.

The **Fax Setting Wizard** is automatically displayed when the printer is turned on for the first time. Once you have made the settings, you do not need to make them again unless the connection environment is changed.

## Making Basic Fax Settings Using the Fax Setting Wizard

Make basic settings by following the on-screen instructions.



## Faxing

1. Connect the printer to the phone line.



**Important:**

*Because an automatic fax connection check runs at the end of the wizard, make sure you connect the printer to the phone line before starting the wizard.*

2. Enter **Setup** from the home screen.

3. Select **Fax Settings > Fax Setting Wizard**, and then press the ▲ button.

The wizard begins.

4. On the fax header entry screen, enter your sender name such as your company name.

**Note:**

*Your sender name and your fax number appear as the header for outgoing faxes.*

5. On the phone number entry screen, enter your fax number.

6. Select whether you are using a DRD setting.

- If you have subscribed to a distinctive ring service from your telephone company: Press the ▲ button, select the ring pattern to be used for incoming faxes, and then go to step 9. **Receive Mode** is automatically set to **Auto**.

- If you do not need to set this option: Press the ▼ button, and then go to the next step.

**Note:**

- Distinctive ring services, offered by many telephone companies (the service name differs by company), allows you to have several phone numbers on one phone line. Each number is assigned a different ring pattern. You can use one number for voice calls and another for fax calls. Select the ring pattern assigned to fax calls in **DRD**.*

- Depending on the region, **On** and **Off** are displayed as the **DRD** options. Select **On** to use the distinctive ring feature.*

7. Select whether you are using your phone device connected to the printer.

- When connected: Press the ▲ button, and then go to the next step.

- When not connected: Press the ▼ button, and then go to step 9. **Receive Mode** is set to **Auto**.

8. Select whether you want to receive faxes automatically.

- To receive automatically: Press the ▲ button. **Receive Mode** is set to **Auto**.

- To receive manually: Press the ▼ button. **Receive Mode** is set to **Manual**.

9. On the **Confirm Settings** screen, press the OK button. Press the ▲ and ▼ buttons to check the settings you made, and then press the OK button.

To correct or change settings, press the ↻ button.

10. Select **Start**, and when you are prompted to print the check result, press the ◇ button.

A report of the check result that shows the connection status is printed.

## Faxing

**Note:**

- ❑ If there are any errors reported, follow the instructions on the report to solve them.
- ❑ If you are prompted to select the line type, select the line type. When you are connecting the printer to a PBX phone system or terminal adapter, select **PBX**.
- ❑ If the screen indicates that the dial tone is not detected, press the ▲ button to disable the dial tone detection feature. However, disabling the dial tone detection feature may cause the printer to skip the first digit of a fax number when dialing and send the fax to the wrong number.

11. When **Start** is displayed again, press the ▼ button. Select **Done** to quit the wizard.

**Related Information**

- ➔ [“Connecting the Printer to a Phone Line” on page 61](#)
- ➔ [“Setting Receiving Mode” on page 70](#)
- ➔ [“Making Settings for a PBX Phone System” on page 66](#)
- ➔ [“Fax Settings” on page 20](#)

## Making Basic Fax Settings Individually

You can make fax settings without using the fax setting wizard by selecting each setting menu individually. The settings configured using the wizard can also be changed. For more details, see the list of menus in fax settings.

**Related Information**

- ➔ [“Fax Settings” on page 20](#)

### ***Making Settings for a PBX Phone System***

Make the following settings when using the printer in offices that use extensions and require external access codes, such as 0 and 9, to get an outside line.

1. Enter **Setup** from the home screen.
2. Select **Fax Settings > Basic Settings > Line Type**.
3. Select **PBX**.
4. Select **Use** as the access code.
5. On the **Access Code** screen, enter the external access code used for your phone system, and then press the OK button.

The access code is stored in the printer. When sending a fax to an outside fax number, enter # (hash) instead of the actual access code.

**Note:**

When # (hash) is entered at the beginning of the fax number, the printer replaces the # with the stored access code when dialing. Using # helps avoid connection problems when connecting to an outside line.

---

## Registering Contacts for Faxing

Registering frequently used fax numbers to a contact list allows you to easily send faxes. You can group some entries together to send a fax to multiple recipients at a time. Up to 60 entries (a group entry is counted as one) can be registered.

### Registering Contacts

1. Press the  button in **Fax** mode.
2. Press the # button, and then select **Add Entry**.
3. Select the entry number that you want to register.
4. Enter a name and fax number.

**Note:**

When entering a fax number, enter an external access code at the beginning of the fax number if your phone system is PBX and you need the access code to get an outside line. If the access code has been set in the **Line Type** setting, enter a hash (#) instead of the actual access code. To add a pause (pause for three seconds) during dialing, enter a hyphen by pressing the  button.

5. Select the fax speed. Press the  button to change.

**Note:**

The fax speed set in **Setup > Fax Settings > Basic Settings > Fax Speed** is used by default. If frequent communication errors occur for the recipient, or if the recipient is overseas, we recommend changing this to **Slow(9,600bps)** is recommended.

6. Press the OK button to register a contact.

**Note:**

To edit or delete an entry, select the target entry, press the  button, and then select **Edit** or **Delete**.

### Registering Grouped Contacts

Adding contacts to a group allows you to send a fax to multiple destinations at the same time.

1. Press the  button in the **Fax** mode.
2. Press #, and then select **Add Group**.
3. Select the entry number that you want to register.
4. Enter a name, and then press the OK button.
5. Press the \* button to select the contacts that you want to register in the group.

**Note:**

- You can register up to 30 contacts.
- To deselect, press the \* button again.

## Faxing

- Press the OK button to register the contacts as a group.

**Note:**

To edit or delete a grouped contact, select the target grouped contact, press the ► button, and then select **Edit** or **Delete**.

## Registration and Backup of Contacts Using a Computer

Using FAX Utility, you can create a contact list on your computer and import it to the printer. You can also back up the contact data stored in the printer to the computer. See the help of FAX Utility for details.

Contacts data may be lost due to a printer malfunction. We recommend that you make a backup of the data whenever you update the data. Epson shall not be responsible for the loss of any data, for backing up or recovering data and/or settings even during a warranty period.

---

## Sending Faxes

### Basic Fax Sending Operations

Send faxes in color or monochrome (B&W).

**Note:**

If the fax number is busy or a problem occurs, the printer automatically redials twice after one minute.

### Sending Faxes Using the Control Panel

- Place the originals.

**Note:**

You can send up to 100 pages in one transmission; however depending on the remaining amount of memory, you may not be able to send faxes even with less than 100 pages.

- Enter **Fax** from the home screen.

- Specify the recipient.

To enter manually: Enter numbers using the numerical keypad, and then press the OK button.

To select from the contacts list: Press the  button, and then select the recipient.

To select the last dialed number: Press the  button.

**Note:**

You can send the same monochrome fax to up to 30 recipients. A color fax can only be sent to one recipient at a time.

To add a pause (pause for three seconds) during dialing, enter a hyphen by pressing .

If you set an external access code in **Line Type**, enter "#" (hash) instead of the actual external access code at the beginning of the fax number.

If you press the  button and the last fax was sent to a group dial entry, the entry registered last in the group is displayed.

To delete the recipient you selected, press the ► button, and then select **Delete Contacts**.

- Press the OK button, and then make settings such as the resolution and the sending method as necessary.

## Faxing

5. Press the  button.

**Note:**

- To cancel sending, press the  button.
- It takes longer to send a fax in color because the printer performs scanning and sending simultaneously. While the printer is sending a color fax, you cannot use the other features.
- Depending on the contents of the original and the resolution you selected, the time required for sending a fax varies.

### Related Information

- ➔ [“Placing Originals” on page 29](#)
- ➔ [“Fax Mode” on page 17](#)
- ➔ [“Registering Contacts for Faxing” on page 67](#)

## Sending Faxes Dialing from the External Phone Device

You can send a fax by dialing using the connected telephone when you want to talk over the phone before sending a fax, or when the recipient's fax machine does not switch to the fax automatically.

1. Place the originals.

**Note:**

*You can send up to 100 pages in one transmission;*

2. Pick up the handset of the connected telephone.
3. Select **Send** on the printer's control panel, and then dial the recipient's fax number using the phone.
4. Press the OK button, and then make settings such as the resolution and the sending method as necessary.
5. When you hear a fax tone, press the  button, and then hang up the handset.

**Note:**

- When a number is dialed using the connected telephone, it takes longer to send a fax because the printer performs scanning and sending simultaneously. While sending the fax, you cannot use the other features.
- Depending on the contents of the original and the resolution you selected, the time required for sending a fax varies.

### Related Information

- ➔ [“Placing Originals” on page 29](#)
- ➔ [“Fax Mode” on page 17](#)

## Various Ways of Sending Faxes

### Sending Faxes at a Specified Time (Send Fax Later)



You can set to send a fax at a specified time. Only monochrome faxes can be sent when the time to send is specified.

1. Place the originals.

## Faxing

2. Enter **Fax** from the home screen.
3. Specify the recipient.
4. Press the OK button, and then select **Send Fax Later**.
5. Select **On**, and then press the OK button.
6. Enter the time to send the fax, and then press the OK button.
7. Make settings such as the resolution and the density as necessary.
8. Press the  button.

**Note:**

*Until the fax is sent at the specified time, you cannot send other faxes. To cancel the fax, press the  button on the fax mode top screen, and then press the  button.*

### Related Information

- ➔ [“Sending Faxes Using the Control Panel” on page 68](#)
- ➔ [“Placing Originals” on page 29](#)
- ➔ [“Fax Mode” on page 17](#)

## Sending Many Pages of a Monochrome Document (Direct Send)

When sending a fax in monochrome, the scanned document is temporarily stored in the printer's memory. Therefore, sending a lot of pages may cause the printer to run out of memory and stop sending the fax. You can avoid this by enabling the **Direct Send** feature, however, it takes longer to send the fax because the printer performs scanning and sending simultaneously. You can use this feature when there is only one recipient.

From the home screen, select **Fax**, and then press the OK button. Set **Direct Send** to **On**.

## Sending a Fax from a Computer

You can send faxes from the computer by using the FAX Utility and PC-FAX driver. See the help of FAX Utility and PC-FAX driver for the operating instructions.

### Related Information

- ➔ [“PC-FAX Driver \(Fax Driver\)” on page 94](#)
- ➔ [“FAX Utility” on page 94](#)

---

# Receiving Faxes

## Setting Receiving Mode

You can set **Receive Mode** using the **Fax Setting Wizard**. When you set up the fax feature for the first time, we recommend using the **Fax Setting Wizard**. If you want to change the **Receive Mode** settings individually, follow the steps below.

## Faxing

1. Enter **Setup** from the home screen.
2. Select **Fax Settings > Receive Settings > Receive Mode**.
3. Select how to receive.
  - Auto**: Recommended for heavy fax users. The printer automatically receives a fax after the number of rings you specified.

**Important:**

When you do not connect a telephone to the printer, select the **Auto** mode.

- Manual**: Recommended for users who do not fax often, or who want to receive a fax after answering calls with the connected telephone. When receiving a fax, pick up the handset, and then operate the printer.

**Note:**

If you enable the **Remote Receive** feature, you can start receiving a fax just by using the connected telephone.

### Related Information

- ➔ [“Making Basic Fax Settings Using the Fax Setting Wizard” on page 64](#)
- ➔ [“Receiving Faxes Manually” on page 71](#)
- ➔ [“Receiving Faxes Using a Connected Telephone \(Remote Receive\)” on page 72](#)

## Settings for the Answering Machine

You need settings to use an answering machine.

- Set the **Receive Mode** of the printer to **Auto**.
- Set the **Rings to Answer** setting of the printer to a higher number than the number of rings for the answering machine. Otherwise, the answering machine cannot receive voice calls to record voice messages. See the manuals that came with the answering machine for its settings.

The **Rings to Answer** setting may not be displayed depending on the region.

### Related Information

- ➔ [“Fax Settings” on page 20](#)

## Various Ways of Receiving Faxes

### Receiving Faxes Manually

When you connect a telephone and set the **Receive Mode** setting of the printer to **Manual**, follow the steps below to receive faxes.

1. When the telephone rings, pick up the handset.
2. When you hear a fax tone, select **Receive** on the printer's control panel.

**Note:**

If you enable the **Remote Receive** feature, you can start receiving a fax just by using the connected telephone.

## Faxing

3. Press the  button, and then hang up the handset.

### Related Information

- ➔ [“Receiving Faxes Using a Connected Telephone \(Remote Receive\)” on page 72](#)
- ➔ [“Saving Received Faxes on a Computer” on page 73](#)

## Receiving Faxes Using a Connected Telephone (Remote Receive)

To receive a fax manually, you need to operate the printer after you pick up the handset of the telephone. By using the **Remote Receive** feature, you can start receiving a fax just by operating the phone.

The **Remote Receive** feature is available for telephones that support tone dialing.

### Related Information

- ➔ [“Receiving Faxes Manually” on page 71](#)

### Setting Up Remote Receive

1. Enter **Setup** from the home screen.
2. Select **Fax Settings > Receive Settings > Remote Receive**.
3. After enabling **Remote Receive**, enter a two digit code (0 to 9, \*, and # can be entered).
4. Press the OK button.

### Using Remote Receive

1. When the telephone rings, pick up the handset.
2. When you hear a fax tone, enter the start code using the telephone.
3. After confirming that the printer has started receiving the fax, hang up the handset.

## Receiving Faxes by Polling (Polling Receive)

You can receive a fax stored on another fax machine by dialing the fax number. Use this feature to receive a document from a fax information service. However, if the fax information service has an audio guidance feature that you need to follow to receive a document, you cannot use this feature.

### Note:

*To receive a document from a fax information service that uses audio guidance, just dial the fax number using the connected telephone, and operate the phone and the printer following the audio guidance.*

1. Enter **Fax** from the home screen.
2. Press the OK button, and then enable **Polling Receive**.
3. Enter the fax number.
4. Press the  button.



## Faxing

### Related Information

➔ [“Sending Faxes Dialing from the External Phone Device” on page 69](#)

## Saving Received Faxes on a Computer

You can set to convert received documents into PDF format and save them on a computer connected to the printer. You can also set to automatically print the documents while saving them on the computer.

First, you need to use FAX Utility to make the setting. Install FAX Utility on the computer.



#### **Important:**

- Set the printer's receive mode to **Auto**.
- Try not to let your computer enter sleep mode. If the computer is left in sleep mode or if it is turned off, the printer temporarily saves received documents and may result in a memory full error that disables sending and receiving faxes.

1. Start FAX Utility on the computer connected to the printer.
  2. Open the setting screen of FAX Utility.
    - Windows**  
Select **Fax Settings for Printer > Received Fax Output Settings**.
    - Mac OS X**  
Click **Fax Receive Monitor**, select the printer, and then click **Received Fax Output Settings**.
  3. Click **Save faxes on this computer**, and specify the folder to save received documents.
  4. Make the other settings as necessary, and then send the setting to the printer.
- Note:**  
*For details on the setting items and the procedure, see the help of FAX Utility.*
5. On the printer's control panel, enter **Setup**.
  6. Select **Fax Settings > Output Settings > Fax Output**.
  7. The current setting is displayed. Check that the printer is set to save faxes on a computer. If you want to automatically print received documents while saving them on the computer, select **Save then Print**.

#### **Note:**

*To stop saving received document on the computer, set **Fax Output** to **Print** on the printer. You can also use FAX Utility to change the setting, however, changing from FAX Utility is not allowed while there are received faxes that have not been saved on the computer.*

### Related Information

➔ [“FAX Utility” on page 94](#)

➔ [“Setting Receiving Mode” on page 70](#)

---

## Using Other Faxing Features

### Printing Fax Report and List

#### Printing Fax Report Manually

1. Enter **Fax** from the home screen.
2. Press the OK button, and then select **Fax Report**.
3. Select the report to print, and then follow the on-screen instruction.

**Note:**

You can change the report format. From the home screen, select **Setup > Fax Settings > Output Settings**, and then change the **Attach Image to Report** or **Report Format** settings.

#### Related Information

- ➔ [“Fax Mode” on page 17](#)
- ➔ [“Fax Settings” on page 20](#)

### Setting Up to Print Fax Reports Automatically

You can make settings to print the following fax reports automatically.

#### Transmission Report

From the home screen, select **Setup > Fax Settings > User Default Settings > Transmission Report**, and then select **Print** or **Print on Error**.

**Note:**

To change settings when sending a fax, press the OK button on the fax top screen, and then select **Transmission Report**.

#### Fax Log

From the home screen, select **Setup > Fax Settings > Output Settings > Fax Log Auto Print**, and then select **On(Every 30)** or **On(Time)**.

#### Related Information

- ➔ [“Fax Mode” on page 17](#)
- ➔ [“Fax Settings” on page 20](#)

---

## Reprinting Received Faxes

You can reprint received documents that you have already printed. All of the received documents saved in the printer's memory are printed in reverse chronological order. However, if the printer runs out of memory, documents that have already been printed are automatically deleted starting with the oldest document.

1. Enter **Fax** from the home screen.

## Faxing

2. Press the OK button, and then select **Reprint Faxes**.
3. Press the  button.

**Note:**

*After reprinting your documents, press the  button to stop printing.*

# Refilling Ink

## Checking the Ink Levels

To confirm the actual ink remaining, visually check the ink levels in all of the printer's tanks.

**Important:**

*Prolonged use of the printer when the ink level is below the lower line on the ink tank unit could damage the printer. Consider refilling.*

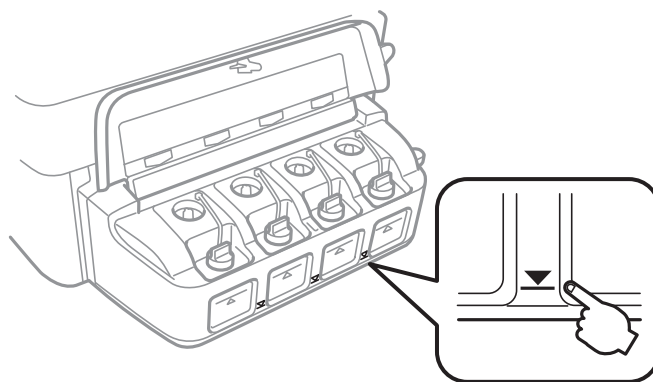

You can check the approximate ink levels from the computer.

## Checking the Ink Levels - Windows

1. Access the printer driver window.
2. Click **Ink Levels** on the **Main** tab.

**Note:**

*If EPSON Status Monitor 3 is disabled, the ink levels are not displayed. Click **Extended Settings** on the **Maintenance** tab, and then select **Enable EPSON Status Monitor 3**.*

### Related Information

➔ [“Windows Printer Driver” on page 91](#)

## Checking the Ink Levels - Mac OS X

1. Select **System Preferences** from the  menu > **Printers & Scanners** (or **Print & Scan**, **Print & Fax**), and then select the printer.
2. Click **Options & Supplies** > **Utility** > **Open Printer Utility**.
3. Click **EPSON Status Monitor**.

## Ink Bottle Codes

Epson recommends the use of genuine Epson ink bottles. Epson warranty does not cover damage caused by inks other than those specified, including any genuine Epson ink not designed for this printer or any third party ink.

Other products not manufactured by Epson may cause damage that is not covered by Epson's warranties, and under certain circumstances, may cause erratic printer behavior.

The following are the codes for genuine Epson ink bottles.

BK (Black)	C (Cyan)	M (Magenta)	Y (Yellow)
664	664	664	664



**Important:**

Use of genuine Epson ink other than the specified ink could cause damage that is not covered by Epson's warranties.

**Note:**

For users in Europe, visit the following website for information on Epson's ink bottle yields.

<http://www.epson.eu/pageyield>

## Ink Bottle Handling Precautions

Read the following instructions before refilling ink.

### Handling precautions

- Use ink bottles with the correct part code for this printer.
- This printer requires careful handling of ink. Ink may splatter when the ink tanks are filled or refilled with ink. If ink gets on your clothes or belongings, it may not come off.
- Store ink bottles at normal room temperature and keep them away from direct sunlight.
- Epson recommends using the ink bottle before the date printed on the package.
- Store the ink bottles in the same environment as the printer.
- When storing or transporting an ink bottle after removing its seal, do not tilt the bottle and do not subject it to impacts or temperature changes. Otherwise, ink may leak even if the cap on the ink bottle is tightened securely. Be sure to keep the ink bottle upright when tightening the cap, and take measures to prevent ink from leaking when you transport the bottle.
- After bringing an ink bottle inside from a cold storage site, allow it to warm up at room temperature for at least three hours before using it.
- Do not open the ink bottle package until you are ready to fill the ink tank. The ink bottle is vacuum packed to maintain its reliability. If you leave an ink bottle unpacked for a long time before using it, normal printing may not be possible.
- Prolonged use of the printer when the ink level is below the lower line could damage the printer. Epson recommends filling the ink tank to the upper line when the printer is not operating to reset the ink level.
- To ensure you receive premium print quality and to help protect your print head, a variable ink safety reserve remains in the ink tank when your printer indicates to refill ink. The yields quoted for you do not include this reserve.

## Refilling Ink

- ❑ Although the ink bottles may contain recycled materials, this does not affect printer function or performance.
- ❑ Specifications and appearance of the ink bottle are subject to change without prior notice for improvement.
- ❑ Quoted yields may vary depending on the images that you are printing, the paper type that you are using, the frequency of your prints and environmental conditions such as temperature.

### Ink consumption

- ❑ To maintain optimum print head performance, some ink is consumed from all ink tanks not only during printing but also during maintenance operation such as print head cleaning.
- ❑ When printing in monochrome or grayscale, color inks instead of black ink may be used depending on the paper type or print quality settings. This is because a mixture of color inks is used to create black.
- ❑ The ink in the ink bottles supplied with your printer is partly used during initial setup. In order to produce high quality printouts, the print head in your printer will be fully charged with ink. This one-off process consumes a quantity of ink and therefore these bottles may print fewer pages compared to subsequent ink bottles.

---

## Refilling the Ink Tanks

1. Enter **Setup** from the home screen.
2. Select **Maintenance > Reset Ink Levels**.
3. Press the **◊** button.
4. Open the ink tank unit cover, and then remove the cap of the ink tank. After removing the cap, place it as shown in the illustration below.

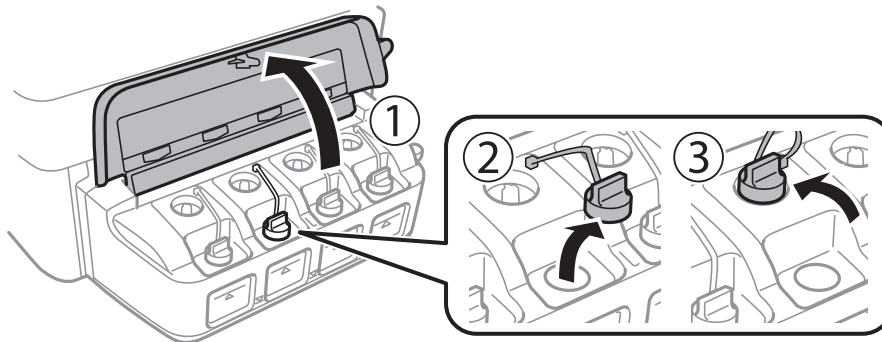

## Refilling Ink

**!** *Important:*

- ❑ *Be careful not to spill any ink.*
- ❑ *Make sure that the color of the ink tank matches the ink color that you want to refill.*

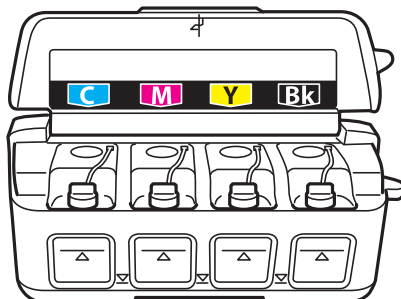

5. Snap off the top of the cap, remove the cap of the ink bottle, remove the seal from the bottle, and then install the cap.

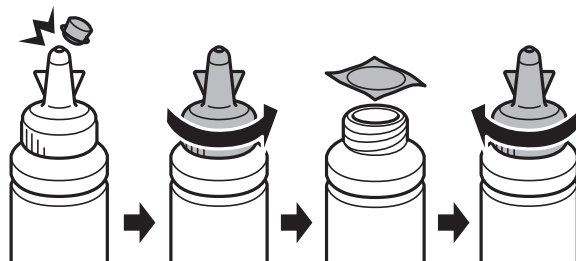

**!** *Important:*

*Close the ink bottle cap tightly; otherwise ink may leak.*

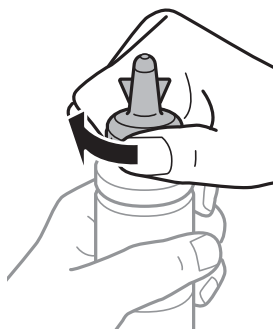

**Note:**

*Do not dispose of the top of the cap. If any ink remains in the ink bottle after refilling the tank, use the top of the cap to seal the ink bottle cap.*

## Refilling Ink

6. Refill the ink tank with the correct colored ink up to the upper line on the ink tank.

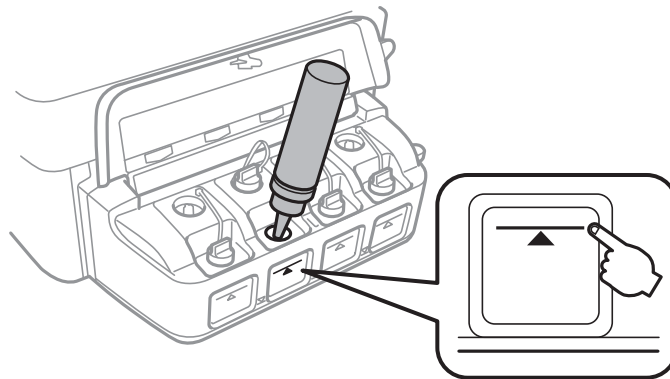

**!** **Important:**

*It may be difficult to see inside the ink tank. Refill the ink tank carefully to prevent ink from spilling out from the ink inlet.*

**Note:**

*If any ink remains in the ink bottle after filling the ink tank up to the upper line, install the cap securely and store the ink bottle upright for later use.*

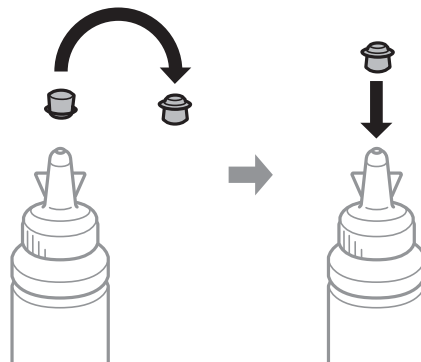

7. Close the cap onto the ink tank securely.

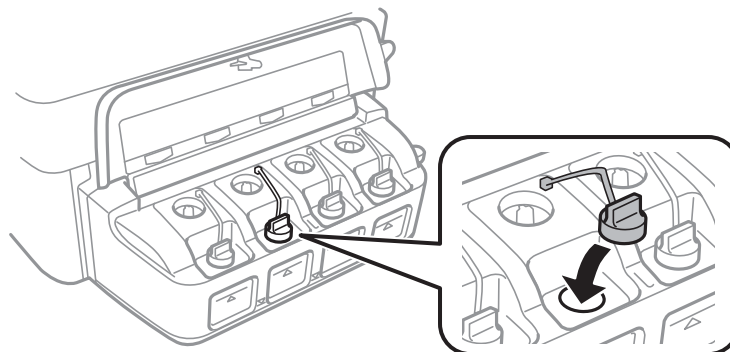



## Refilling Ink

8. Close the ink tank unit cover.

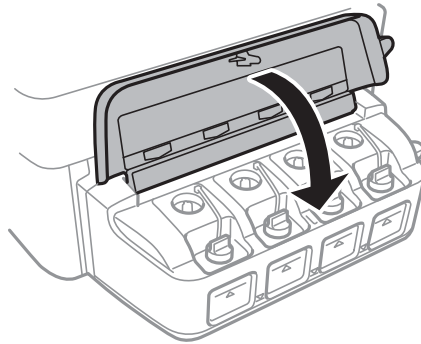

9. Press the OK button.
10. Follow the instructions on the LCD screen to reset the ink levels.

**Note:**

*You can reset the ink levels even if you did not fill the ink to the upper line. However, this printer cannot generate notifications and stop operations before ink levels drop below the lower line.*

### Related Information

- ➔ [“Ink Bottle Codes” on page 77](#)
- ➔ [“Ink Bottle Handling Precautions” on page 77](#)

# Improving Print and Scan Quality

## Checking and Cleaning the Print Head

If the nozzles are clogged, the printouts become faint, there is visible banding, or unexpected colors appear. When print quality has declined, use the nozzle check feature and check if the nozzles are clogged. If the nozzles are clogged, clean the print head.

**!** **Important:**

*Do not open the scanner unit or turn off the printer during head cleaning. If the head cleaning is incomplete, you may not be able to print.*

**Note:**

- Because print head cleaning uses some ink, clean the print head only if quality declines.
- When ink is low, you may not be able to clean the print head. Prepare a new ink bottle.
- If print quality has not improved after repeating nozzle check and head cleaning three times, wait for at least 12 hours without printing, and then run the nozzle check again and repeat the head cleaning if necessary. We recommend to turn off the printer. If print quality has still not improved, contact Epson support.
- To prevent the print head from drying out, do not unplug the printer while the power is on.
- To keep the print head operating at its best, we recommend printing a few pages on a regular basis.

## Checking and Cleaning the Print Head - Control Panel

1. Load A4-size plain paper in the printer.
2. Enter **Setup** from the home screen.
3. Select **Maintenance > Print Head Nozzle Check**.
4. Follow the on-screen instructions to print the nozzle check pattern.

**Note:**

*The test pattern may vary by model.*

5. Compare the printed check pattern with the sample shown below.
  - All lines are printed: The print head nozzles are not clogged. Close the nozzle check feature.

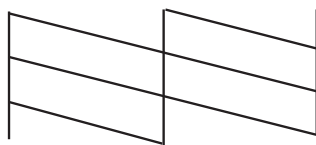

## Improving Print and Scan Quality

- ❑ There are broken lines or missing segments: The print head nozzles may be clogged. Go to the next step.

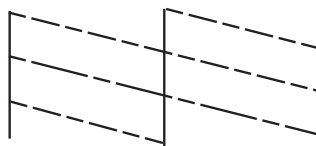

6. Follow the on-screen instructions to clean the print head.
7. When cleaning is finished, print the nozzle check pattern again. Repeat cleaning and printing the pattern until all lines are printed completely.

### Related Information

- ➔ [“Loading Paper in the Rear Paper Feed” on page 25](#)

## Checking and Cleaning the Print Head - Windows

1. Load A4-size plain paper in the printer.
2. Access the printer driver window.
3. Click **Nozzle Check** on the **Maintenance** tab.
4. Follow the on-screen instructions.

### Related Information

- ➔ [“Loading Paper in the Rear Paper Feed” on page 25](#)
- ➔ [“Windows Printer Driver” on page 91](#)

## Checking and Cleaning the Print Head - Mac OS X

1. Load A4-size plain paper in the printer.
2. Select **System Preferences** from the  menu > **Printers & Scanners** (or **Print & Scan, Print & Fax**), and then select the printer.
3. Click **Options & Supplies** > **Utility** > **Open Printer Utility**.
4. Click **Nozzle Check**.
5. Follow the on-screen instructions.

### Related Information

- ➔ [“Loading Paper in the Rear Paper Feed” on page 25](#)

---

## Replacing Ink inside the Ink Tubes

If you have not used the printer for a long time and notice banding or missing colors in the printouts, you may need to replace the ink inside the ink tubes to solve the problem. The **Power Ink Flushing** utility allows you to replace all of the ink inside the ink tubes.

### **Important:**

- ❑ *This feature consumes a lot of ink. Before using this feature, make sure there is enough ink in the printer's ink tanks. If there is not enough ink, refill the ink tanks.*
- ❑ *This feature effects the service life of the ink pad. Ink pad reaches its capacity earlier by running this feature. Contact Epson or an authorised Epson service provider to request replacement before the end of its service life. It is not a user-serviceable part.*
- ❑ *After using the Power Ink Flushing utility, turn the printer off and wait for at least 12 hours. Using this feature improves the print quality after 12 hours, however it cannot be used again within 12 hours of the last use. If you still cannot solve the problem after trying all of the methods above, contact Epson support.*

## Replacing Ink inside the Ink Tubes - Windows

1. Access the printer driver window.
2. Click **Power Ink Flushing** on the **Maintenance** tab.
3. Follow the on-screen instructions.

### Related Information

➔ [“Windows Printer Driver” on page 91](#)

## Replacing Ink inside the Ink Tubes - Mac OS X

1. Select **System Preferences** from the  menu > **Printers & Scanners** (or **Print & Scan**, **Print & Fax**), and then select the printer.
2. Click **Options & Supplies** > **Utility** > **Open Printer Utility**.
3. Click **Power Ink Flushing**.
4. Follow the on-screen instructions.

---

## Aligning the Print Head

If you notice a misalignment of vertical lines or blurred images, align the print head.

## Aligning the Print Head - Control Panel

1. Load A4-size plain paper in the printer.

## Improving Print and Scan Quality

2. Enter **Setup** from the home screen.
3. Select **Maintenance > Print Head Alignment**.
4. Follow the on-screen instructions to print the alignment pattern.
5. Follow the on-screen instructions to align the print head. Find and enter the number for the most solid pattern in each group.

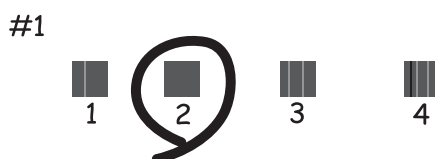

**Note:**

- The test pattern may vary by model.
- If print quality is not improved, align the print head from a computer.

### Related Information

- ➔ [“Loading Paper in the Rear Paper Feed” on page 25](#)

## Aligning the Print Head - Windows

1. Load A4-size plain paper in the printer.
2. Access the printer driver window.
3. Click **Print Head Alignment** on the **Maintenance** tab.
4. Follow the on-screen instructions.

### Related Information

- ➔ [“Loading Paper in the Rear Paper Feed” on page 25](#)
- ➔ [“Windows Printer Driver” on page 91](#)

## Aligning the Print Head - Mac OS X

1. Load A4-size plain paper in the printer.
2. Select **System Preferences** from the  menu > **Printers & Scanners** (or **Print & Scan, Print & Fax**), and then select the printer.
3. Click **Options & Supplies > Utility > Open Printer Utility**.

## Improving Print and Scan Quality

4. Click **Print Head Alignment**.
5. Follow the on-screen instructions.

### Related Information

➔ [“Loading Paper in the Rear Paper Feed” on page 25](#)

---

## Cleaning the Paper Path for Ink Smear

When the printouts are smeared or scuffed, clean the roller inside.



**Important:**

*Do not use tissue paper to clean the inside of the printer. The print head nozzles may be clogged with lint.*

1. Load A4-size plain paper in the printer.
2. Enter **Setup** from the home screen.
3. Select **Maintenance > Paper Guide Cleaning**.
4. Follow the on-screen instructions to clean the paper path.

**Note:**

*Repeat this procedure until the paper is not smeared with ink.*

### Related Information

➔ [“Loading Paper in the Rear Paper Feed” on page 25](#)

---

## Cleaning the ADF

When the copied or scanned images from the ADF are smeared or the originals do not feed in the ADF correctly, clean the ADF.



**Important:**

*Never use alcohol or thinner to clean the printer. These chemicals can damage the printer.*

1. Open the ADF cover.

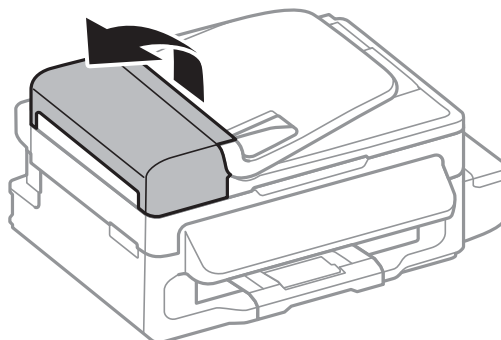

## Improving Print and Scan Quality

2. Use a soft, dry, clean cloth to clean the roller and the interior of the ADF.

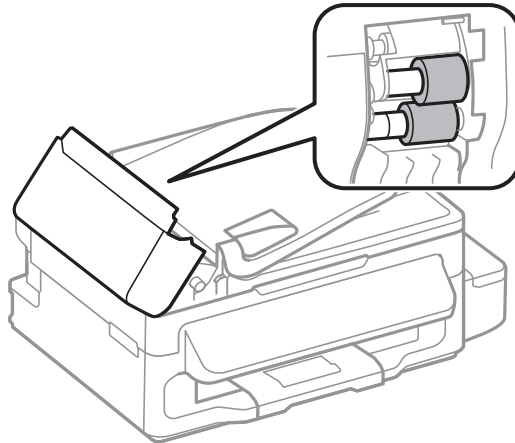

3. Open the document cover.

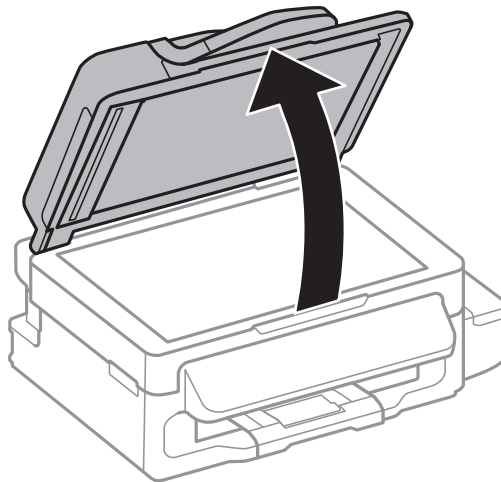

4. Clean the part that is shown in the illustration.



## Improving Print and Scan Quality

**Note:**

- ❑ *If the glass surface is stained with grease or some other hard-to-remove material, use a small amount of glass cleaner and a soft cloth to remove it. Wipe off all remaining liquid.*
- ❑ *Do not press the glass surface too hard.*
- ❑ *Be careful not to scratch or damage the surface of the glass. A damaged glass surface can decrease the scan quality.*

---

## Cleaning the Scanner Glass

When the copies or scanned images are smeared or scuffed, clean the scanner glass.



**Caution:**

*Be careful not to trap your hand or fingers when opening or closing the document cover. Otherwise you may be injured.*



**Important:**

*Never use alcohol or thinner to clean the printer. These chemicals can damage the printer.*

1. Open the document cover.

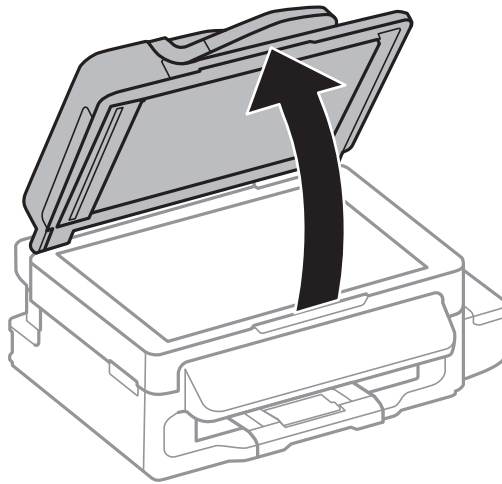

2. Use a soft, dry, clean cloth to clean the surface of the scanner glass.

**Note:**

- ❑ *If the glass surface is stained with grease or some other hard-to-remove material, use a small amount of glass cleaner and a soft cloth to remove it. Wipe off all remaining liquid.*
- ❑ *Do not press the glass surface too hard.*
- ❑ *Be careful not to scratch or damage the surface of the glass. A damaged glass surface can decrease the scan quality.*



# Network Service and Software Information

This section introduces the network services and software products available for your printer from the Epson website or the supplied CD.

---

## Epson Connect Service

By using Epson Connect service available on the Internet, you can print from your smartphone, tablet PC, or laptop, anytime and practically anywhere.

The features available on the Internet are as follows.

Email Print	Epson iPrint remote print	Scan to Cloud	Remote Print Driver
✓	✓	✓	✓

See the Epson Connect portal website for details.

<https://www.epsonconnect.com/>

<http://www.epsonconnect.eu> (Europe only)

---

## Web Config

Web Config is an application that runs in a web browser, such as Internet Explorer and Chrome, on a computer or smart device. You can confirm the printer status or change the network service and printer settings. To use the Web Config, connect the printer and the computer or device to the same network.

**Note:**

*The following browsers are supported.*

OS	Browser
Windows XP or later	Internet Explorer 8 or later, Firefox*, Chrome*
Mac OS X v10.6.8 or later	Safari*, Firefox*, Chrome*
iOS*	Safari*
Android 2.3 or later	Default browser
Chrome OS*	Default browser

\*: Use the latest version.

## Running Web Config on a Web Browser

1. Check the printer's IP address.

Select **Setup** > **Network Settings** > **Network Status** > **Wired LAN/Wi-Fi Status** or **Wi-Fi Status** from the home screen, and then check the printer's IP address.

2. Launch a Web browser from a computer or smart device, and then enter the printer's IP address.

Format:

IPv4: http://the printer's IP address/

IPv6: http://[the printer's IP address]/

Examples:

IPv4: http://192.168.100.201/

IPv6: http://[2001:db8::1000:1]/

**Note:**

Using the smart device, you can also run Web Config from the maintenance screen of Epson iPrint.

### Related Information

➔ [“Using Epson iPrint” on page 48](#)

## Running Web Config on Windows

When connecting a computer to the printer using WSD, follow the steps below to run Web Config.

1. Access the devices and printers screen in Windows.
  - Windows 8.1/Windows 8/Windows Server 2012 R2/Windows Server 2012  
Select **Desktop** > **Settings** > **Control Panel** > **View devices and printers in Hardware and Sound (or Hardware)**.
  - Windows 7/Windows Server 2008 R2  
Click the start button, and select **Control Panel** > **View devices and printers in Hardware and Sound**.
  - Windows Vista/Windows Server 2008  
Click the start button, and select **Control Panel** > **Printers in Hardware and Sound**.
2. Right-click on your printer and select **Properties**.
3. Select the **Web Service** tab and click the URL.

## Running Web Config on Mac OS X

1. Select **System Preferences** from the  menu > **Printers & Scanners** (or **Print & Scan, Print & Fax**), and then select the printer.
2. Click **Options & Supplies** > **Show Printer Webpage**.

---

## Windows Printer Driver

The printer driver controls the printer according to the commands from an application. Making settings on the printer driver provides the best printing results. You can also check the status of the printer or keep it in top operating condition using the printer driver utility.

**Note:**

You can change the language of the printer driver. Select the language you want to use from the **Language** setting on the **Maintenance** tab.

### Accessing the printer driver from applications

To make settings that apply only to the application you are using, access from that application.

Select **Print** or **Print Setup** from the **File** menu. Select your printer, and then click **Preferences** or **Properties**.

**Note:**

Operations differ depending on the application. See the application's help for details.

### Accessing the printer driver from the control panel

To make settings that apply to all of the applications, access from the control panel.

 Windows 8.1/Windows 8/Windows Server 2012 R2/Windows Server 2012

Select **Desktop > Settings > Control Panel > View devices and printers** in **Hardware and Sound**. Right-click on your printer, or press and hold it and then select **Printing preferences**.

 Windows 7/Windows Server 2008 R2

Click the start button, and select **Control Panel > View devices and printers** in **Hardware and Sound**. Right-click on your printer and select **Printing preferences**.

 Windows Vista/Windows Server 2008

Click the start button, and select **Control Panel > Printers** in **Hardware and Sound**. Right-click on your printer and select **Select printing preferences**.

 Windows XP/Windows Server 2003 R2/Windows Server 2003

Click the start button, and select **Control Panel > Printers and Other Hardware > Printers and Faxes**. Right-click on your printer and select **Printing preferences**.

### Starting the utility

Access the printer driver window. Click the **Maintenance** tab.

## Restricting Settings for the Windows Printer Driver

You can lock some settings of the printer driver so that other users cannot change them.

**Note:**

Log on to your computer as an administrator.

1. Open the **Optional Settings** tab in printer properties.

 Windows 8.1/Windows 8/Windows Server 2012

Select **Desktop > Settings > Control Panel > View devices and printers** in **Hardware and Sound**. Right-click on your printer, or press and hold it and then select **Printer properties**. Click the **Optional Settings** tab.

 Windows 7/Windows Server 2008 R2

## Network Service and Software Information

Click the start button, and select **Control Panel > View devices and printers** in **Hardware and Sound**. Right-click on your printer, and then select **Printer properties**. Click the **Optional Settings** tab.

- Windows Vista/Windows Server 2008

Click the start button, and select **Control Panel > Printers** in **Hardware and Sound**. Right-click on your printer, and then select **Properties**. Click the **Optional Settings** tab.

- Windows XP/Windows Server 2003 R2/Windows Server 2003

Click the start button, and select **Control Panel > Printers and Other Hardware > Printers and Faxes**. Right-click on your printer, and then select **Properties**. Click the **Optional Settings** tab.

2. Click **Driver Settings**.
3. Select the feature that you want to restrict.  
See the online help for explanations of the setting items.
4. Click **OK**.

## Making Operation Settings for the Windows Printer Driver

You can make settings such as enabling **EPSON Status Monitor 3**.

1. Access the printer driver window.
2. Click **Extended Settings** on the **Maintenance** tab.
3. Make the appropriate settings, and then click **OK**.  
See the online help for explanations of the setting items.

### Related Information

➔ [“Windows Printer Driver” on page 91](#)

---

## Mac OS X Printer Driver

The printer driver controls the printer according to the commands from an application. Making settings on the printer driver provides the best printing results. You can also check the status of the printer or keep it in top operating condition using the printer driver utility.

### Accessing the printer driver from applications

Click **Page Setup** or **Print** on the **File** menu of your application. If necessary, click **Show Details** (or ▼) to expand the print window.

#### Note:

Depending on the application being used, **Page Setup** may not be displayed in the **File** menu, and the operations for displaying the print screen may differ. See the application's help for details.

### Starting the utility

Select **System Preferences** from the  menu > **Printers & Scanners** (or **Print & Scan**, **Print & Fax**), and then select the printer. Click **Options & Supplies > Utility > Open Printer Utility**.

## Making Operation Settings for the Mac OS X Printer Driver

### Accessing the Operation Settings Window of the Mac OS X Printer Driver

Select **System Preferences** from the  menu > **Printers & Scanners** (or **Print & Scan**, **Print & Fax**), and then select the printer. Click **Options & Supplies** > **Options** (or **Driver**).

### Operation Settings of the Mac OS X Printer Driver

- Skip Blank Page: Avoids printing blank pages.
- Quiet Mode: Prints quietly. However, the print speed may be slower.
- High Speed Printing: Prints when the print head moves in both directions. The print speed is faster, but the quality may decline.
- Warning Notifications: Allows the printer driver to display warning notifications.
- Establish bidirectional communication: Usually, this should be set to **On**. Select **Off** when acquiring the printer information is impossible because the printer is shared with Windows computers on a network or for any other reason.

---

## EPSON Scan (Scanner Driver)

EPSON Scan is an application for controlling scanning. You can adjust the size, resolution, brightness, contrast, and quality of the scanned image.

**Note:**

*You can also start EPSON Scan from a TWAIN-compliant scanning application.*

### Starting on Windows

**Note:**

*For Windows Server operating systems, you need to install the **Desktop Experience** feature.*

- Windows 8.1/Windows 8/Windows Server 2012 R2/Windows Server 2012  
Enter the application name in the search charm, and then select the displayed icon.
- Except for Windows 8.1/Windows 8/Windows Server 2012 R2/Windows Server 2012  
Click the start button, and select **All Programs** or **Programs** > **EPSON** > **EPSON Scan** > **EPSON Scan**.

### Starting on Mac OS X

**Note:**

*EPSON Scan does not support the Mac OS X fast user switching feature. Turn off fast user switching.*

Select **Go** > **Applications** > **Epson Software** > **EPSON Scan**.

---

## Epson Event Manager

Epson Event Manager is an application that allows you to manage scanning from the control panel and save images to a computer. You can add your own settings as presets, such as the document type, the save folder location, and the image format. See the application's help for details.

**Note:**

*Windows Server operating systems are not supported.*

**Starting on Windows**

- Windows 8.1/Windows 8

Enter the application name in the search charm, and then select the displayed icon.

- Windows 7/Windows Vista/Windows XP

Click the start button, and select **All Programs** or **Programs > Epson Software > Event Manager**.

**Starting on Mac OS X**

Select **Go > Applications > Epson Software > Event Manager**.

---

## PC-FAX Driver (Fax Driver)

PC-FAX driver is an application that allows you to send a document created on a separate application as a fax directly from the computer. PC-FAX driver is installed when you install FAX Utility. See the application's help for details.

**Note:**

- Windows Server operating systems are not supported.*

- The operation differs depending on the application you used to create the document. See the application's help for details.*

**Accessing from Windows**

In the application, select **Print** or **Print Setup** from the **File** menu. Select your printer (FAX), and then click **Preferences** or **Properties**.

**Accessing from Mac OS X**

In the application, select **Print** from the **File** menu. Select your printer (FAX) as the **Printer** setting, and then select **Fax Settings** or **Recipient Settings** from the pop-up menu.

---

## FAX Utility

FAX Utility is an application that allows you to configure various settings for sending faxes from a computer. You can create or edit the contacts list to be used when sending a fax, configure to save received faxes in PDF format on the computer, and so on. See the application's help for details.

**Note:**

- Windows Server operating systems are not supported.*

- Make sure you have installed the printer driver before installing FAX Utility.*

**Starting on Windows**

- Windows 8.1/Windows 8

Enter the application name in the search charm, and then select the displayed icon.

- Windows 7/Windows Vista/Windows XP

Click the start button, and select **All Programs** (or **Programs**) > **Epson Software > FAX Utility**.

### Starting on Mac OS X

Select **System Preferences** from the  menu > **Printers & Scanners** (or **Print & Scan, Print & Fax**), and then select the printer (FAX). Click **Options & Supplies** > **Utility** > **Open Printer Utility**.

---

## Epson Easy Photo Print

Epson Easy Photo Print is an application that allows you to easily print photos with various layouts. You can preview the photo image and adjust the images or position. You can also print photos with a frame. See the application's help for details.

**Note:**

- Windows Server operating systems are not supported.*
- To use this application, the printer driver needs to be installed.*

### Starting on Windows

- Windows 8.1/Windows 8  
Enter the application name in the search charm, and then select the displayed icon.
- Windows 7/Windows Vista/Windows XP  
Click the start button, and then select **All Programs** or **Programs** > **Epson Software** > **Epson Easy Photo Print**.

### Starting on Mac OS X

Select **Go** > **Applications** > **Epson Software** > **Epson Easy Photo Print**.

---

## E-Web Print (for Windows Only)

E-Web Print is an application that allows you to easily print web pages with various layouts. See the application's help for details. You can access the help from the **E-Web Print** menu on the **E-Web Print** tool bar.

**Note:**

*Windows Server operating systems are not supported.*

### Starting

When you install E-Web Print, it is displayed in your browser. Click **Print** or **Clip**.

---

## EPSON Software Updater

EPSON Software Updater is an application that checks for new or updated software on the internet and installs it. You can also update the printer's firmware and manual.

**Note:**

*Windows Server operating systems are not supported.*

## Network Service and Software Information

### Starting on Windows

- ❑ Windows 8.1/Windows 8

Enter the application name in the search charm, and then select the displayed icon.

- ❑ Windows 7/Windows Vista/Windows XP

Click the start button, and select **All Programs** (or **Programs**) > **Epson Software** > **EPSON Software Updater**.

### Starting on Mac OS X

Select **Go** > **Applications** > **Epson Software** > **EPSON Software Updater**.

---

## EpsonNet Config

EpsonNet Config is an application that allows you to set the network interface addresses and protocols. See the operations guide for EpsonNet Config or the application's help for more details.

### Starting on Windows

- ❑ Windows 8.1/Windows 8/Windows Server 2012 R2/Windows Server 2012

Enter the application name in the search charm, and then select the displayed icon.

- ❑ Except for Windows 8.1/Windows 8/Windows Server 2012 R2/Windows Server 2012

Click the start button, and select **All Programs** (or **Programs**) > **EpsonNet** > **EpsonNet Config V4** > **EpsonNet Config**.

### Starting on Mac OS X

Select **Go** > **Applications** > **Epson Software** > **EpsonNet** > **EpsonNet Config V4** > **EpsonNet Config**.

---

## Uninstalling Applications

### Note:

Log on to your computer as an administrator. Enter the administrator password if the computer prompts you.

### Uninstalling Applications - Windows

1. Press the  button to turn off the printer.
2. Quit all running applications.
3. Open **Control Panel**:
  - ❑ Windows 8.1/Windows 8/Windows Server 2012 R2/Windows Server 2012  
Select **Desktop** > **Settings** > **Control Panel**.
  - ❑ Except for Windows 8.1/Windows 8/Windows Server 2012 R2/Windows Server 2012  
Click the start button and select **Control Panel**.





## Network Service and Software Information

4. Open **Uninstall a program** (or **Add or Remove Programs**):
  - Windows 8.1/Windows 8/Windows 7/Windows Vista/Windows Server 2012 R2/Windows Server 2012/Windows Server 2008 R2/Windows Server 2008  
Select **Uninstall a program** in **Programs**.
  - Windows XP/Windows Server 2003 R2/Windows Server 2003  
Click **Add or Remove Programs**.
5. Select the application you want to uninstall.
6. Uninstall the applications:
  - Windows 8.1/Windows 8/Windows 7/Windows Vista/Windows Server 2012 R2/Windows Server 2012/Windows Server 2008 R2/Windows Server 2008  
Click **Uninstall/Change** or **Uninstall**.
  - Windows XP/Windows Server 2003 R2/Windows Server 2003  
Click **Change/Remove** or **Remove**.

**Note:**  
If the **User Account Control** window is displayed, click **Continue**.
7. Follow the on-screen instructions.

## Uninstalling Applications - Mac OS X

1. Download the Uninstaller using EPSON Software Updater.  
Once you have downloaded the Uninstaller, you do not need to download it again each time you uninstall the application.
2. Press the  button to turn off the printer.
3. To uninstall the printer driver or PC-FAX driver, select **System Preferences** from the  menu > **Printers & Scanners** (or **Print & Scan, Print & Fax**), and then remove the printer from the enabled printers list.
4. Quit all running applications.
5. Select **Go > Applications > Epson Software > Uninstaller**.
6. Select the application you want to uninstall, and then click **Uninstall**.



**Important:**

*The Uninstaller removes all drivers for Epson inkjet printers on the computer. If you use multiple Epson inkjet printers and you only want to delete some drivers, delete all of them first, and then install the necessary printer driver again.*

**Note:**

*If you cannot find the application you want to uninstall in the application list, you cannot uninstall using the Uninstaller. In this situation, select **Go > Applications > Epson Software**, select the application you want to uninstall, and then drag it to the trash icon.*

**Related Information**

➔ [“EPSON Software Updater” on page 95](#)

---

## Installing Applications

Connect your computer to the network and install the latest version of applications from the website.

**Note:**

- ❑ Log on to your computer as an administrator. Enter the administrator password if the computer prompts you.
- ❑ When reinstalling an application, you need to uninstall it first.

1. Quit all running applications.
2. When installing the printer driver or EPSON Scan, disconnect the printer and the computer temporarily.

**Note:**

*Do not connect the printer and the computer until you are instructed to do so.*

3. Install the applications by following the instructions on the website below.

<http://epson.sn>

**Note:**

*If you are using a Windows computer and you cannot download applications from the website, install them from the software disc that came with the printer.*

**Related Information**

➔ [“Uninstalling Applications” on page 96](#)

---

## Updating Applications and Firmware

You may be able to clear certain problems and improve or add functions by updating the applications and the firmware. Make sure you use the latest version of the applications and firmware.

1. Make sure that the printer and the computer are connected, and the computer is connected to the internet.
2. Start EPSON Software Updater, and update the applications or the firmware.

**Important:**

*Do not turn off the computer or the printer while updating.*

**Note:**

*If you cannot find the application you want to update in the list, you cannot update using the EPSON Software Updater. Check for the latest versions of the applications from your local Epson website.*

<http://www.epson.com>

**Related Information**

➔ [“EPSON Software Updater” on page 95](#)

# Solving Problems

## Checking the Printer Status

### Checking Messages on the LCD Screen

If an error message is displayed on the LCD screen, follow the on-screen instructions or the solutions below to solve the problem.

Error Messages	Solutions
Printer Error 0xXX Turn the power off and on again. For details, see your documentation.	Remove any paper or protective material in the printer. If the error message is still displayed after turning the power off and on again, contact Epson support.
A printer's ink pad is nearing the end of its service life. Please contact Epson Support.	Contact Epson or an authorised Epson service provider to replace the ink pad*. It is not a user-serviceable part. The message will be displayed until the ink pad is replaced.  Press the  button to resume printing.
A printer's ink pad is at the end of its service life. Please contact Epson Support.	Contact Epson or an authorised Epson service provider to replace the ink pad*. It is not a user-serviceable part.
Communication error. Check if the computer is connected.	Connect the computer and the printer correctly. If you are connecting over a network, see the <i>Network Guide</i> . If the error message is still displayed, make sure that EPSON Scan and Epson Event Manager are installed on the computer.
Invalid IP address and subnet mask. Enter them correctly. See your documentation.	See the <i>Network Guide</i> .
No dial tone detected.	This problem might be resolved by selecting <b>Setup &gt; Fax Settings &gt; Basic Settings &gt; Line Type</b> and then selecting <b>PBX</b> . If your phone system requires an external access code to get an outside line, set the access code after selecting <b>PBX</b> . Use # (hash) instead of the actual access code when entering an outside fax number. This makes connection more secure.  If the error message is still displayed, set the <b>Dial Tone Detection</b> settings to disabled. However, disabling this feature may drop the first digit of a fax number and send the fax to the wrong number.
Recovery Mode	The printer has started in recovery mode because the firmware update failed. Follow the steps below to try to update the firmware again.  1. Connect the computer and the printer with a USB cable. (During recovery mode, you cannot update the firmware over a network connection.)  2. Visit your local Epson website for further instructions.

\* In some print cycles a very small amount of surplus ink may be collected in the ink pad. To prevent ink leakage from the pad, the printer is designed to stop printing when the pad has reached its limit. Whether and how often this is required will vary according to the number of pages you print, the type of material that you print and the number of cleaning cycles that the printer performs. The need for replacement of the pad does not mean that your

## Solving Problems

printer has ceased to operate in accordance with its specifications. The printer will advise you when the pad requires replacing and this can only be performed by an authorised Epson Service provider. The Epson warranty does not cover the cost of this replacement.

### Related Information

- ➔ [“Contacting Epson Support” on page 131](#)
- ➔ [“Installing Applications” on page 98](#)
- ➔ [“Updating Applications and Firmware” on page 98](#)

## Checking the Printer Status - Windows

1. Access the printer driver window.
2. Click **EPSON Status Monitor 3** on the **Maintenance** tab.

#### **Note:**

- You can also check the printer status by double-clicking the printer icon on the taskbar. If the printer icon is not added to the taskbar, click **Monitoring Preferences** on the **Maintenance** tab, and then select **Register the shortcut icon to the taskbar**.
- If **EPSON Status Monitor 3** is disabled, click **Extended Settings** on the **Maintenance** tab, and then select **Enable EPSON Status Monitor 3**.

### Related Information

- ➔ [“Windows Printer Driver” on page 91](#)

## Checking Printer Status - Mac OS X

1. Select **System Preferences** from the  menu > **Printers & Scanners** (or **Print & Scan, Print & Fax**), and then select the printer.
2. Click **Options & Supplies** > **Utility** > **Open Printer Utility**.
3. Click **EPSON Status Monitor**.

---

## Removing Jammed Paper

Check the error displayed on the control panel and follow the instructions to remove the jammed paper including any torn pieces. Next, clear the error.



#### **Important:**

*Remove the jammed paper carefully. Removing the paper vigorously may cause damage to the printer.*

## Solving Problems

### Removing Jammed Paper from the Rear Paper Feed

Remove the jammed paper.

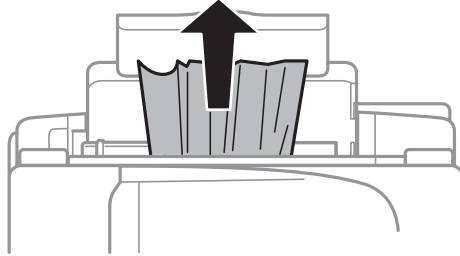

### Removing Jammed Paper from Inside the Printer

 **Caution:**

- Be careful not to trap your hand or fingers when opening or closing the scanner unit. Otherwise you may be injured.
- Never touch the buttons on the control panel while your hand is inside the printer. If the printer starts operating, it could cause an injury. Be careful not to touch the protruding parts to avoid injury.

1. Open the scanner unit with the document cover closed.

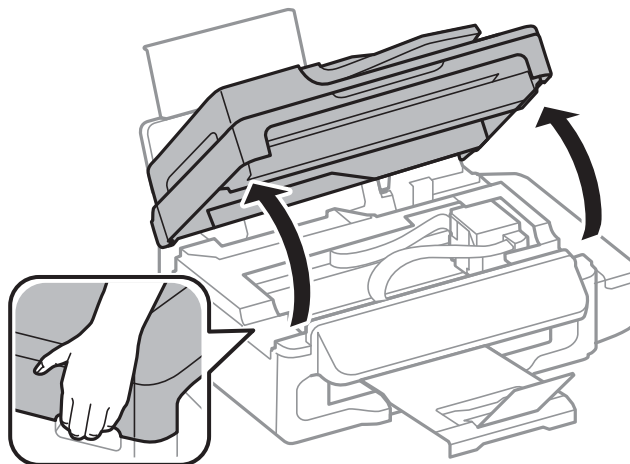

## Solving Problems

2. Remove the jammed paper.

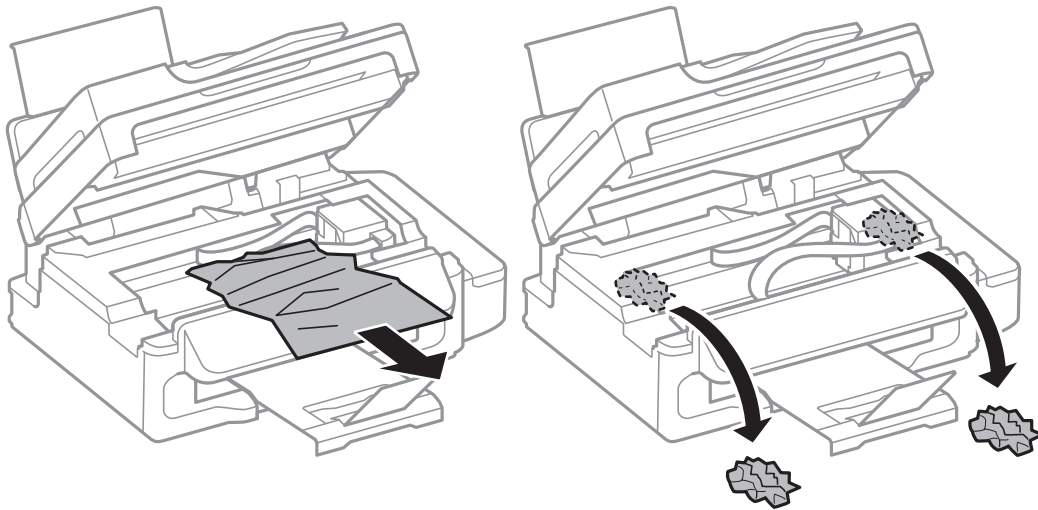

**!** **Important:**

*Do not touch the white flat cable, translucent part, and ink tubes inside the printer. Doing so may cause a malfunction.*

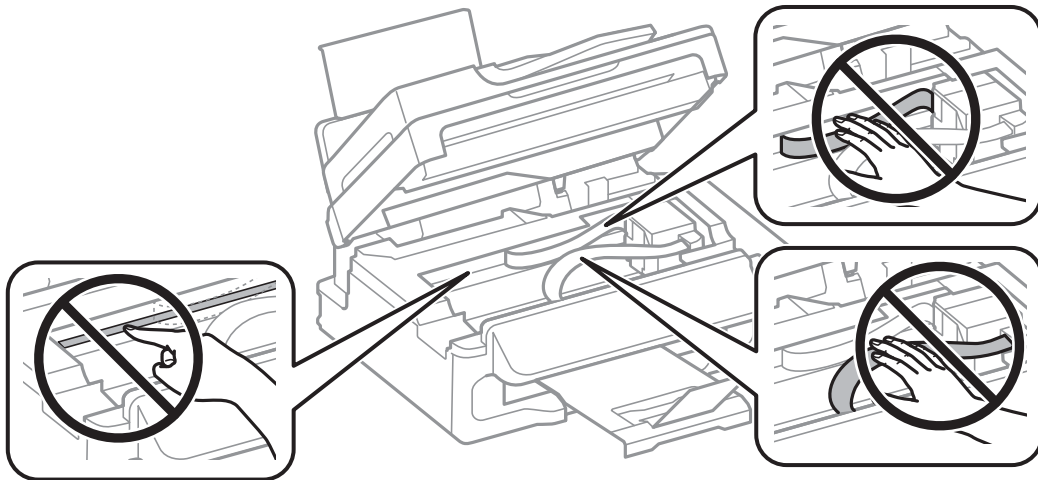

3. Close the scanner unit.

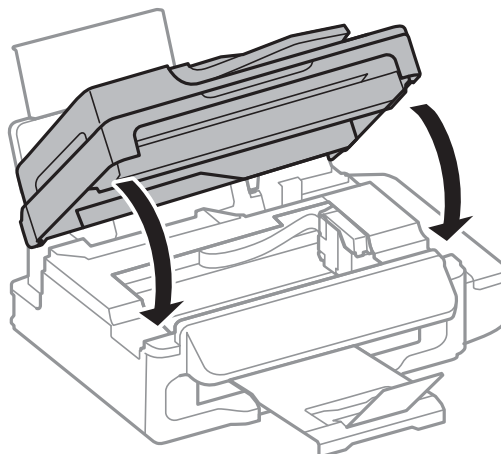

## Removing Jammed Paper from the ADF

1. Open the ADF cover.

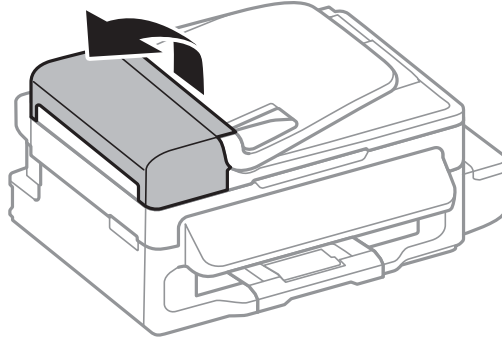

2. Remove the jammed paper

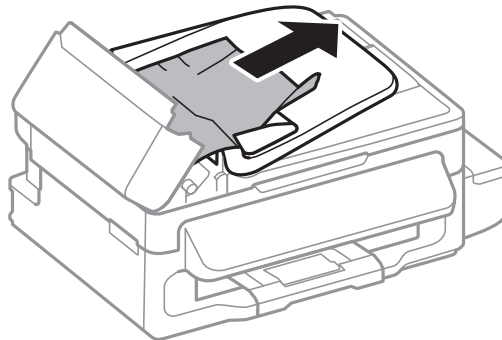

3. Open the ADF.

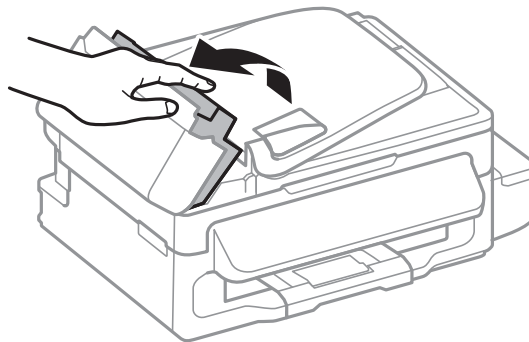

## Solving Problems

4. Remove the jammed paper

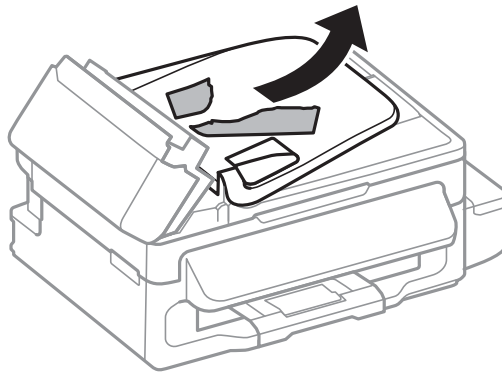

5. Raise the ADF input tray, and then remove the jammed paper.

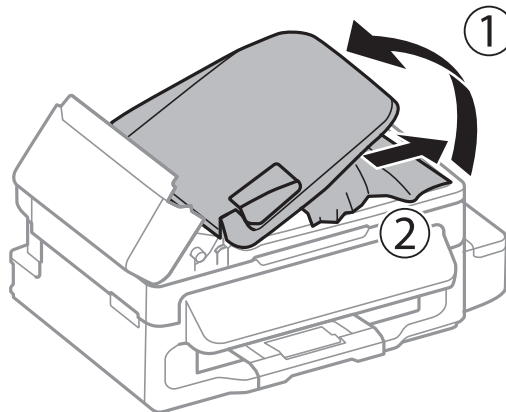

6. Close the ADF cover.

---

## Paper Does Not Feed Correctly

Check the following points, and then take the appropriate actions to solve the problem.

- Place the printer on a flat surface and operate in the recommended environmental conditions.
- Use paper supported by this printer.
- Follow the paper handling precautions.
- Make sure the paper size and paper type settings match the actual paper size and paper type loaded in the printer.

### Related Information

- ➔ [“Environmental Specifications” on page 125](#)
- ➔ [“Available Paper and Capacities” on page 24](#)
- ➔ [“Paper Handling Precautions” on page 23](#)
- ➔ [“List of Paper Types” on page 24](#)



## Solving Problems

### Paper Jams

- Load paper in the correct direction, and slide the edge guides against the edges of the paper.
- Load one sheet of paper at a time if you have loaded several sheets of paper.

#### Related Information

- ➔ [“Removing Jammed Paper” on page 100](#)
- ➔ [“Loading Paper in the Rear Paper Feed” on page 25](#)

### Paper Feeds at a Slant

Load paper in the correct direction, and slide the edge guides against the edges of the paper.

#### Related Information

- ➔ [“Loading Paper in the Rear Paper Feed” on page 25](#)

### Several Sheets of Paper are Fed at a Time

- Load one sheet of paper at a time.
- When several sheets of paper are fed at a time during manual 2-sided printing, remove any paper which is loaded in the printer before you reload the paper.

### No Paper Feeds

Do not load more than the maximum number of sheets specified for the paper. For plain paper, do not load above the line indicated by the triangle symbol on the edge guide.

#### Related Information

- ➔ [“Available Paper and Capacities” on page 24](#)

### Paper Out Error Occurs

When a paper out error occurs although paper is loaded in the rear paper feed, reload paper against the right edge of the rear paper feed.

### Original Does Not Feed in the ADF

- Use originals supported by the ADF.
- Load originals in the correct direction, and slide the ADF edge guides against the edges of the originals.
- Clean the inside of the ADF.
- Do not load originals above the line indicated by the triangle symbol on the edge guide.
- Check that the ADF icon appears on the control panel. If it does not appear, place the originals again.

**Related Information**

- ➔ [“Available Originals for the ADF” on page 29](#)
- ➔ [“Placing Originals on the ADF” on page 29](#)
- ➔ [“Cleaning the ADF” on page 86](#)



---

## Power and Control Panel Problems

### Power Does Not Turn On

- Hold down the  button for a little longer.
- Make sure the power cord is securely plugged in.

### Power Does Not Turn Off

Hold down the  button for a little longer. If you still cannot turn off the printer, unplug the power cord. To prevent the print head from drying out, turn the printer back on and turn it off by pressing the  button.

### LCD Screen Gets Dark

The printer is in sleep mode. Press any button on the control panel to return the LCD screen to its former state.

---

## Printer Does Not Print

Check the following if the printer does not operate or prints nothing.

- Connect the USB cable securely to the printer and the computer.
- If you are using a USB hub, try to connect the printer directly to the computer.
- If you are using the printer over a network, make sure the printer is connected to the network. You can check the status by checking the indicators on the control panel or by printing the network status sheet. If the printer is not connected to the network, see the *Network Guide*.
- If you are printing a large data size image, the computer may run out of memory. Print the image at a lower resolution or a smaller size.
- In Windows, click **Print Queue** on the printer driver's **Maintenance** tab, and then check the following.
  - Check if there are any paused print jobs.  
Cancel printing if necessary.
  - Make sure the printer is not offline or pending.  
If the printer is offline or pending, clear the offline or pending setting from the **Printer** menu.
  - Make sure the printer is selected as the default printer from the **Printer** menu (there should be a check mark on the menu item).  
If the printer is not selected as the default printer, set it as the default printer.

## Solving Problems

- In Mac OS X, make sure the printer status is not **Pause**.

Select **System Preferences** from the  menu > **Printers & Scanners** (or **Print & Scan, Print & Fax**), and then double-click the printer. If the printer is paused, click **Resume** (or **Resume Printer**).

- Perform a nozzle check, and then clean the print head if any of the print head nozzles are clogged.
- If you are using the printer through AirPrint, enable the AirPrint setting on Web Config. If this setting is disabled, you cannot use AirPrint.

### Related Information

- ➔ [“Canceling Printing” on page 51](#)
- ➔ [“Checking and Cleaning the Print Head” on page 82](#)

---

## Printout Problems

### Nothing or a Very Faint Image is Printed

If you have not used the printer for a long time, the print head nozzles may be clogged and ink drops may not be discharged. Perform a nozzle check, and then clean the print head if any of the print head nozzles are clogged.

### Related Information

- ➔ [“Checking and Cleaning the Print Head” on page 82](#)

### Print Quality Is Poor

Check the following if the print quality is poor due to blurry prints, banding, missing colors, faded colors, misalignment, and mosaic-like patterns in the prints.

- Make sure the initial ink charging is complete.
- Check the ink tank. If the tank is empty, refill the ink immediately and clean the print head.
- Run the nozzle check and then clean the print head if any of the print head nozzles are clogged.
- If you have not used the printer for a long time, use the Power Ink Flushing utility of the printer driver.
- Align the print head.
- If misalignment appears at intervals of 2.5 cm, align the print head.
- Use paper supported by this printer.
- Do not print on paper that is damp, damaged, or too old.
- If the paper is curled or the envelope is puffed up, flatten it.
- When printing images or photos, print using high-resolution data. Images on websites are often low resolution although they look good enough on the display, and so print quality may decline.
- Select the appropriate paper type setting on the control panel or in the printer driver for the type of paper loaded in the printer.
- Print using a high quality setting on the control panel or in the printer driver.

## Solving Problems

- When images or photos are printed in unexpected colors, adjust the color and then print again. The automatic color correction feature uses the standard correction mode in **PhotoEnhance**. Try another correction mode in **PhotoEnhance** by selecting an option other than **Auto Correct** as the **Scene Correction** setting. If the problem continues, use any other color correction feature other than **PhotoEnhance**.
- Disable the bidirectional (or high speed) setting. When this setting is enabled, the print head prints while moving in both directions, and vertical lines may be misaligned. If you disable this feature, printing may slow down.
  - Windows  
Clear **High Speed** on the printer driver's **More Options** tab.
  - Mac OS X  
Select **System Preferences** from the  menu > **Printers & Scanners** (or **Print & Scan, Print & Fax**), and then select the printer. Click **Options & Supplies** > **Options** (or **Driver**). Select **Off** as the **High Speed Printing** setting.
- Do not stack the paper immediately after printing.
- Dry the printouts completely before filing or displaying them. When drying the printouts, avoid direct sun light, do not use a dryer, and do not touch the printed side of paper.
- Try to use genuine Epson ink bottles. This product is designed to adjust colors based on the use of genuine Epson ink bottles. The use of non-genuine ink bottles may cause print quality to decline.
- Use ink bottles with the correct part code for this printer.
- Epson recommends using the ink bottle before the date printed on the package.
- When printing images or photos, Epson recommends using genuine Epson paper rather than plain paper. Print on the printable side of the genuine Epson paper.

### Related Information

- ➔ [“Refilling the Ink Tanks” on page 78](#)
- ➔ [“Checking and Cleaning the Print Head” on page 82](#)
- ➔ [“Replacing Ink inside the Ink Tubes” on page 84](#)
- ➔ [“Aligning the Print Head” on page 84](#)
- ➔ [“Paper Handling Precautions” on page 23](#)
- ➔ [“Available Paper and Capacities” on page 24](#)
- ➔ [“List of Paper Types” on page 24](#)
- ➔ [“Adjusting the Print Color” on page 47](#)

## Copy Quality Is Poor

Check the following if uneven colors, smears, dots, or straight lines appear in the copied image.

- Clean the paper path.
- Clean the scanner glass.
- Clean the ADF.
- Do not press too hard on the original or the document cover when you are placing the originals on the scanner glass. Uneven colors, smears, or dots may appear when the original or the document cover is pressed too hard.
- If a moiré (cross-hatch) pattern appears, change the reduce and enlarge setting or place the original at a slightly different angle.

## Solving Problems

- When the paper is smeared, lower the copy density setting.

### Related Information

- ➔ [“Cleaning the Paper Path for Ink Smear” on page 86](#)
- ➔ [“Cleaning the Scanner Glass” on page 88](#)
- ➔ [“Cleaning the ADF” on page 86](#)
- ➔ [“Print Quality Is Poor” on page 107](#)

## An Image of the Reverse Side of the Original Appears in the Copied Image

- For a thin original, place the original on the scanner glass and then place a piece of black paper over it.
- Lower the copy density setting on the control panel.

### Related Information

- ➔ [“Copy Mode” on page 15](#)

## The Position, Size, or Margins of the Printout Are Incorrect

- Load paper in the correct direction, and slide the edge guide against the edges of the paper.
- When placing the originals on the scanner glass, align the corner of the original with the corner indicated by a symbol on the frame of the scanner glass. If the edges of the copy are cropped off, move the original slightly away from the corner.
- Clean the scanner glass and the document cover. If there is dust or stains on the glass, the copy area may extend to include the dust or stains, resulting in the wrong printing position or small images.
- Select the appropriate size setting for the original on the control panel.
- Select the appropriate paper size setting on the control panel or in the printer driver.
- Adjust the margin setting in the application so that it falls within the printable area.

### Related Information

- ➔ [“Loading Paper in the Rear Paper Feed” on page 25](#)
- ➔ [“Placing Originals” on page 29](#)
- ➔ [“Cleaning the Scanner Glass” on page 88](#)
- ➔ [“Printable Area” on page 121](#)

## Paper Is Smeared or Scuffed

Check the following if the paper is smeared or scuffed when printing.

- Clean the paper path.
- Clean the scanner glass and the document cover.
- Load paper in the correct direction.
- When performing manual 2-sided printing, make sure that the ink is completely dry before reloading the paper.

## Solving Problems

- When the paper is smeared during copying, lower the copy density setting on the control panel.

### Related Information

- ➔ [“Cleaning the Paper Path for Ink Smear” on page 86](#)
- ➔ [“Cleaning the Scanner Glass” on page 88](#)
- ➔ [“Loading Paper in the Rear Paper Feed” on page 25](#)
- ➔ [“Print Quality Is Poor” on page 107](#)

## Printed Characters Are Incorrect or Garbled

- Connect the USB cable securely to the printer and the computer.
- Cancel any paused print jobs.
- Do not put the computer manually into the **Hibernate** mode or the **Sleep** mode while printing. Pages of garbled text may be printed next time you start the computer.

### Related Information

- ➔ [“Canceling Printing” on page 51](#)

## The Printed Image Is Inverted

Clear any mirror image settings in the printer driver or the application.

- Windows  
Clear **Mirror Image** on the printer driver's **More Options** tab.
- Mac OS X  
Clear **Mirror Image** from the print dialog's **Print Settings** menu.

## The Printout Problem Could Not be Cleared

If you have tried all of the solutions and have not solved the problem, try uninstalling and then reinstalling the printer driver.

### Related Information

- ➔ [“Uninstalling Applications” on page 96](#)
- ➔ [“Installing Applications” on page 98](#)



---

## Other Printing Problems

### Printing Is Too Slow

- Close any unnecessary applications.
- Lower the quality setting. High quality printing slows down the printing speed.

## Solving Problems

- Enable the bidirectional (or high speed) setting. When this setting is enabled, the print head prints while moving in both directions, and the printing speed increases.
  - Windows  
Select **High Speed** on the printer driver's **More Options** tab.
  - Mac OS X  
Select **System Preferences** from the  menu > **Printers & Scanners** (or **Print & Scan, Print & Fax**), and then select the printer. Click **Options & Supplies > Options** (or **Driver**). Select **On** as the **High Speed Printing** setting.
- Disable **Quiet Mode**.
  - Windows  
Select **Off** as the **Quiet Mode** setting on the printer driver's **Main** tab.
  - Mac OS X  
Select **System Preferences** from the  menu > **Printers & Scanners** (or **Print & Scan, Print & Fax**), and then select the printer. Click **Options & Supplies > Options** (or **Driver**). Select **Off** as the **Quiet Mode** setting.

## Printing Slows Down Dramatically During Continuous Printing

Printing slows down to prevent the printer mechanism from overheating and being damaged. However, you can continue printing. To return to normal printing speed, leave the printer idle for at least 30 minutes. Printing speed does not return to normal if the power is off.

---

## Cannot Start Scanning

- If you are scanning with the ADF, check that the document cover and ADF cover are closed.
- Connect the USB cable securely to the printer and the computer.
- If you are using a USB hub, try to connect the printer directly to the computer.
- If you cannot scan over a network, see the *Network Guide*.
- If you scan at a high resolution over a network, a communication error may occur. Lower the resolution.
- Make sure you select the correct printer (scanner) if a scanner list is displayed when you start EPSON Scan.
- If you are using any TWAIN-compliant applications, select the printer (scanner) you are using.

## Solving Problems

- ❑ In Windows, make sure the printer (scanner) is displayed in **Scanner and Camera**. The printer (scanner) should be displayed as "EPSON XXXXX (printer name)". If the printer (scanner) is not displayed, uninstall and then re-install EPSON Scan. See the following to access **Scanner and Camera**.
  - ❑ Windows 8.1/Windows 8/Windows Server 2012 R2/Windows Server 2012  
Select **Desktop > Settings > Control Panel**, enter "Scanner and Camera" in the search charm, click **Show Scanner and Camera**, and then check if the printer is displayed.
  - ❑ Windows 7/Windows Server 2008 R2  
Click the start button and select **Control Panel**, enter "Scanner and Camera" in the search charm, click **View scanners and cameras**, and then check if the printer is displayed.
  - ❑ Windows Vista/Windows Server 2008  
Click the start button, select **Control Panel > Hardware and Sound > Scanners and Cameras**, and then check if the printer is displayed.
  - ❑ Windows XP/Windows Server 2003 R2/Windows Server 2003  
Click the start button, select **Control Panel > Printers and Other Hardware > Scanner and Cameras**, and then check if the printer is displayed.
- ❑ If you cannot scan using any TWAIN-compliant applications, uninstall and then reinstall the TWAIN-compliant application.
- ❑ For Mac OS X with an Intel processor, if other Epson scanner drivers except for EPSON Scan, such as Rosetta or PPC are installed, uninstall them and EPSON Scan, and then reinstall EPSON Scan.

### Related Information

- ➔ ["Uninstalling Applications" on page 96](#)
- ➔ ["Installing Applications" on page 98](#)

## Cannot Start Scanning when Using the Control Panel

- ❑ Make sure EPSON Scan and Epson Event Manager are installed correctly.
- ❑ Check the scanning setting assigned in Epson Event Manager.

### Related Information

- ➔ ["Epson Event Manager" on page 93](#)

---

## Scanned Image Problems

### Scan Quality Is Poor

- ❑ Clean the scanner glass.
- ❑ Clean the ADF.
- ❑ Do not press too hard on the original or the document cover when you are placing the originals on the scanner glass. Uneven colors, smears, or dots may appear when the original or the document cover is pressed too hard.
- ❑ Remove dust from the original.
- ❑ Make the appropriate document type settings.



## Solving Problems

- Scan at a higher resolution.
- Adjust the image in EPSON Scan, and then scan. See the EPSON Scan help for details.

### Related Information

- ➔ [“Cleaning the Scanner Glass” on page 88](#)
- ➔ [“Cleaning the ADF” on page 86](#)

## Characters Are Blurred

- In **Home Mode** or **Office Mode** in EPSON Scan, select **Image Option** from the **Image Adjustments** setting, and then select **Text Enhancement**.
- In **Professional Mode** in EPSON Scan, select **Document** as the **Auto Exposure Type** in the **Original** settings.
- Adjust the threshold settings in EPSON Scan.
  - Home Mode**  
Select **Black & White** as the **Image Type** setting, click **Brightness**, and then adjust the threshold.
  - Office Mode** or **Professional Mode**  
Select **Black & White** as the **Image Type** setting, and then adjust the threshold.
- Scan at a higher resolution.

## An Image of the Reverse Side of the Original Appears in the Scanned Image

- For a thin original, place the original on the scanner glass and then place a piece of black paper over it.
- Make the appropriate document type settings.
- In **Home Mode** or **Office Mode** in EPSON Scan, select **Image Option** from the **Image Adjustments** setting, and then select **Text Enhancement**.

### Related Information

- ➔ [“Scan Mode” on page 16](#)

## Moiré (Cross-Hatch) Patterns Appear in the Scanned Image

- Place the original at a slightly different angle.
- Select **Descreening** in EPSON Scan.
- Change the resolution setting.

## Scanning Area or Direction Is Not Correct

- When placing the originals on the scanner glass, align the corner of the original with the corner indicated by a symbol on the frame of the scanner glass. If the edges of the scanned image are cropped off, move the original slightly away from the corner.
- Clean the scanner glass and the document cover. If there is dust or stains on the glass, the scanning area may extend to include the dust or stains, resulting in the wrong scanning position or small images.

## Solving Problems

- ❑ When you place multiple originals on the scanner glass to scan them separately, but they are scanned onto a single file, place the originals at least 20 mm (0.8 inch) apart. If the problem continues, place one original at a time.
- ❑ Set the scan area correctly.
- ❑ When scanning using the thumbnail preview in EPSON Scan, move the original 4.5 mm (0.18 inch) away from the edges of the scanner glass.
- ❑ When using the thumbnail preview for a large original in **Home Mode** or **Professional Mode** in EPSON Scan, the scanning area may not be correct. When previewing in EPSON Scan, create marquee of the area you want to scan on the **Preview** tab in the **Preview** window.
- ❑ If **Auto Photo Orientation** in EPSON Scan does not work as intended, see the EPSON Scan help.
- ❑ Clear **Auto Photo Orientation** in EPSON Scan.
- ❑ When scanning with EPSON Scan the available scanning area may be restricted if the resolution setting is too high. Lower the resolution or adjust the scanning area in the **Preview** window.

### Related Information

- ➔ [“Placing Originals” on page 29](#)
- ➔ [“Cleaning the Scanner Glass” on page 88](#)

## The Scanned Image Problem Could Not be Cleared

If you have tried all of the solutions and have not solved the problem, click **Configuration** in the EPSON Scan window, and then click **Reset All** on the **Other** tab to initialize the EPSON Scan settings. If initialization does not solve the problem uninstall and re-install EPSON Scan.

### Related Information

- ➔ [“Uninstalling Applications” on page 96](#)
- ➔ [“Installing Applications” on page 98](#)

---

## Other Scanning Problems

### Thumbnail Preview Does Not Work Properly

See the EPSON Scan help.

### Related Information

- ➔ [“EPSON Scan \(Scanner Driver\)” on page 93](#)

### Scanning Is Too Slow

Lower the resolution.

## Solving Problems

### Scanning Stops when Scanning to PDF/Multi-TIFF

- ❑ When scanning using EPSON Scan, you can scan up to 999 pages in PDF format and up to 200 pages in Multi-TIFF format. When scanning using the control panel, you can scan up to 50 pages in PDF format and in Multi-TIFF format.
- ❑ When scanning large volumes, we recommend scanning in grayscale.
- ❑ Increase the free space on the computer's hard disk. Scanning may stop if there is not enough free space.
- ❑ Try scanning at a lower resolution. Scanning stops if the total data size reaches the limit.

#### Related Information

- ➔ [“Scan Mode” on page 16](#)



---

## Problems when Sending and Receiving Faxes

### Cannot Send or Receive Faxes

- ❑ Use **Check Fax Connection** on the control panel to run the automatic fax connection check. Try the solutions printed on the report.
- ❑ Check the **Line Type** setting. Setting this to **PBX** may solve the problem. If your phone system requires an external access code to get an outside line, register the access code to the printer, and enter # (hash) at the beginning of a fax number when sending.
- ❑ If a communication error occurs, change the **Fax Speed** setting to **Slow(9,600bps)** on the control panel.
- ❑ Check that the telephone wall jack works by connecting a phone to it and testing it. If you cannot make or receive calls, contact your telecommunication company.
- ❑ To connect to a DSL phone line, you need to use a DSL modem equipped with a built-in DSL filter, or install a separate DSL filter to the line. Contact your DSL provider.
- ❑ If you are connecting to a DSL phone line, connect the printer directly to a telephone wall jack to see if the printer can send a fax. If it works, the problem may be caused by the DSL filter. Contact your DSL provider.
- ❑ Enable the **ECM** setting on the control panel. Color faxes cannot be sent or received when ECM is off.
- ❑ To send or receive faxes using the computer, make sure that the printer is connected using a USB cable or to a network, and that the printer driver and the PC-FAX Driver have been installed on the computer. The PC-FAX Driver is installed together with the FAX Utility.

## Solving Problems

- ❑ In Windows, make sure the printer (fax) is displayed in **Devices and Printers**, **Printer**, or **Printers and Other Hardware**. The printer (fax) is displayed as "EPSON XXXXX (FAX)". If the printer (fax) is not displayed, uninstall and then re-install the FAX Utility. See the following to access **Devices and Printers**, **Printer**, or **Printers and Other Hardware**.
  - ❑ Windows 8.1/Windows 8
    - Select **Desktop > Settings > Control Panel > View devices and printers in Hardware and Sound** or **Hardware**.
  - ❑ Windows 7
    - Click the start button, and then select **Control Panel > View devices and printers in Hardware and Sound** or **Hardware**.
  - ❑ Windows Vista
    - Click the start button, and select **Control Panel > Printers in Hardware and Sound**.
  - ❑ Windows XP
    - Click the start button, and select **Control Panel > Printers and Other Hardware > Printers and Faxes**.
- ❑ In Mac OS X, check the following.
  - ❑ Select **System Preferences** from the  menu > **Printers & Scanners** (or **Print & Scan**, **Print & Fax**), and then select the printer (fax) displayed. The printer (fax) is displayed as "FAX XXXX (USB)" or "FAX XXXX (IP)". If the printer (fax) is not displayed, click + and then register the printer (fax).
  - ❑ Select **System Preferences** from the  menu, select **Printers & Scanners** (or **Print & Scan**, **Print & Fax**), and then double-click the printer (fax). If the printer is paused, click **Resume** (or **Resume Printer**).

### Related Information

- ➔ [“Fax Settings” on page 20](#)
- ➔ [“Making Settings for a PBX Phone System” on page 66](#)
- ➔ [“Connecting the Printer to a Phone Line” on page 61](#)
- ➔ [“Uninstalling Applications” on page 96](#)
- ➔ [“Installing Applications” on page 98](#)

## Cannot Send Faxes

- ❑ Set up the header information for outgoing faxes on the control panel. Some fax machines automatically reject incoming faxes that do not include header information.
- ❑ If you have blocked your caller ID, unblock it. Some phones or fax machines automatically reject anonymous calls.
- ❑ Ask the recipient if the fax number is correct and the recipient's fax machine is ready to receive a fax.



### Related Information

- ➔ [“Fax Settings” on page 20](#)
- ➔ [“Cannot Send or Receive Faxes” on page 115](#)

## Cannot Send Faxes to a Specific Recipient

Check the following if you cannot send faxes to a specific recipient due to an error.

## Solving Problems

- ❑ If the recipient machine does not pick up your call within 50 seconds after the printer has finished dialing, the call ends with an error. Dial using a connected telephone to check how long it takes before you hear a fax tone. If it takes more than 50 seconds, add pauses after the fax number to send the fax. Press  to enter the pause. A hyphen is entered as the pause mark. One pause is about three seconds. Add multiple pauses as needed.
- ❑ If you have selected the recipient from the contacts list, verify that the registered information is correct. If the information is correct, select the recipient from the contacts list, press the  button, and then select **Edit**. On the **Add Entry** screen, change **Fax Speed** to **Slow(9,600bps)**.

### Related Information

- ➔ [“Sending Faxes Dialing from the External Phone Device” on page 69](#)
- ➔ [“Registering Contacts for Faxing” on page 67](#)
- ➔ [“Cannot Send or Receive Faxes” on page 115](#)

## Cannot Send Faxes at a Specified Time

Set the date and the time correctly on the control panel.

### Related Information

- ➔ [“Sending Faxes at a Specified Time \(Send Fax Later\)” on page 69](#)
- ➔ [“Setup Mode” on page 18](#)

## Cannot Receive Faxes

- ❑ If you have subscribed to a call forwarding service, the printer may not be able to receive faxes. Contact the service provider.
- ❑ If you have not connected a telephone to the printer, set the **Receive Mode** setting to **Auto** on the control panel.

### Related Information

- ➔ [“Fax Settings” on page 20](#)
- ➔ [“Cannot Send or Receive Faxes” on page 115](#)

## Memory Full Error Occurs

- ❑ If the printer has been set to save received faxes on a computer, turn on the computer that is set to save the faxes. Once the faxes are saved in the computer, they are deleted from the printer's memory.
- ❑ Even though the memory is full, you can send a monochrome fax by using the **Direct Send** feature. Or divide your originals into two or more to send them in several batches.
- ❑ If the printer cannot print a received fax due to a printer error, such as a paper jam, the memory full error may occur. Solve the printer problem, and then contact the sender and ask them to send the fax again.

### Related Information

- ➔ [“Saving Received Faxes on a Computer” on page 73](#)
- ➔ [“Fax Mode” on page 17](#)
- ➔ [“Removing Jammed Paper” on page 100](#)

## Solving Problems

### Sent Fax Quality Is Poor

- Clean the scanner glass and the document cover.
- Clean the roller in the ADF.
- Change the **Resolution** setting on the control panel. If your originals contain both text and photos, select **Photo**.
- Change the **Density** setting on the control panel.
- Enable the **ECM** setting on the control panel.

#### Related Information

- ➔ [“Cleaning the Scanner Glass” on page 88](#)
- ➔ [“Cleaning the ADF” on page 86](#)
- ➔ [“Fax Mode” on page 17](#)
- ➔ [“Fax Settings” on page 20](#)

### Faxes Are Sent at the Wrong Size

- When sending a fax using the scanner glass, place the original correctly aligning its corner with the origin mark.
- Clean the scanner glass and the document cover. If there is dust or stains on the glass, the scanning area may extend to include the dust or stains, resulting in the wrong scanning position or small images.

#### Related Information

- ➔ [“Placing Originals” on page 29](#)
- ➔ [“Cleaning the Scanner Glass” on page 88](#)

### Received Fax Quality Is Poor

- Enable the **ECM** setting on the control panel.
- Contact the sender and ask them to send at a higher quality mode.
- Reprint the received fax.

#### Related Information

- ➔ [“Fax Settings” on page 20](#)
- ➔ [“Reprinting Received Faxes” on page 74](#)

### Received Faxes Are Not Printed

If an error has occurred on the printer, such as a paper jam, the printer cannot print received faxes. Check the printer.

#### Related Information

- ➔ [“Removing Jammed Paper” on page 100](#)

---

## Other Faxing Problems

### Cannot Make Calls on the Connected Telephone

Connect the telephone to the EXT. port on the printer, and pick up the receiver. If you cannot hear a dial tone through the receiver, connect the phone cable correctly.

#### Related Information

➔ [“Connecting Your Phone Device to the Printer” on page 63](#)

### Answering Machine Cannot Answer Voice Calls

On the control panel, set the printer's **Rings to Answer** setting to a number higher than the number of rings for your answering machine.

#### Related Information

➔ [“Fax Settings” on page 20](#)

➔ [“Settings for the Answering Machine” on page 71](#)

### Sender's Fax Number Not Displayed on Received Faxes or the Number Is Wrong

The sender may not have set the fax header information or may have set it incorrectly. Contact the sender.

---

## Other Problems

### Slight Electric Shock when Touching the Printer

If many peripherals are connected to the computer, you may feel a slight electric shock when touching the printer. Install a ground wire to the computer that is connected to the printer.

### Operation Sounds Are Loud

If operations sounds are too loud, enable **Quiet Mode**. Enabling this feature may reduce printing speed.

Windows printer driver

Select **On** as the **Quiet Mode** setting on the **Main** tab.

Mac OS X printer driver

Select **System Preferences** from the  menu > **Printers & Scanners** (or **Print & Scan, Print & Fax**), and then select the printer. Click **Options & Supplies** > **Options** (or **Driver**). Select **On** as the **Quiet Mode** setting.

## Solving Problems

### The ADF Does Not Work

There may be dust in the hole at the front-left of the scanner glass. Clean out any dust.

### The Date and Time Are Incorrect

Set the date and the time correctly on the control panel. After a power failure caused by a lightning strike or if the power is left off for a long time, the clock may show the wrong time.

#### Related Information

➔ [“Setup Mode” on page 18](#)

### Application Is Blocked by a Firewall (for Windows Only)

Add the application to the Windows Firewall allowed program in security settings on the **Control Panel**.

### A Message Prompting You to Reset the Ink Levels is Displayed

Refill all or the specified ink tanks, select the color that you refilled on the LCD screen, and then press the  button to reset the ink levels.

Depending on the usage conditions, the message may be displayed when there is still ink in the tank.

#### Related Information

➔ [“Refilling the Ink Tanks” on page 78](#)



# Appendix

## Technical Specifications

### Printer Specifications

Print Head Nozzle Placement		Black ink nozzles: 180 Color ink nozzles: 59 for each color
Weight of Paper	Plain Paper	64 to 90 g/m <sup>2</sup> (17 to 24lb)
	Envelopes	Envelope #10, DL, C6: 75 to 90 g/m <sup>2</sup> (20 to 24 lb)

### Printable Area

Print quality may decline in the shaded areas due to the printer's mechanism.

#### Single sheets (normal printing)

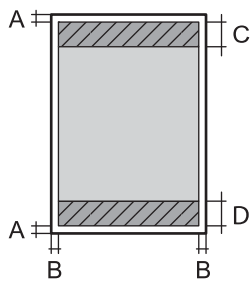
	A	3.0 mm (0.12 in.)
	B	3.0 mm (0.12 in.)
	C	40.0 mm (1.57 in.)
	D	32.0 mm (1.26 in.)

#### Envelopes

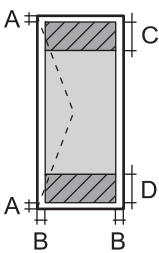
	A	3.0 mm (0.12 in.)
	B	5.0 mm (0.20 in.)
	C	18.0 mm (0.71 in.)
	D	40.0 mm (1.57 in.)

### Scanner Specifications

Scanner Type	Flatbed
Photoelectric Device	CIS
Maximum Document Size	216 × 297 mm (8.5 × 11.7 in.) A4, Letter

## Appendix

Resolution	1200 dpi (main scan) 2400 dpi (sub scan)
Color Depth	Color <input type="checkbox"/> 48 bits per pixel internal (16 bits per pixel per color internal) <input type="checkbox"/> 24 bits per pixel external (8 bits per pixel per color external) Grayscale <input type="checkbox"/> 16 bits per pixel internal <input type="checkbox"/> 8 bits per pixel external Black and white <input type="checkbox"/> 16 bits per pixel internal <input type="checkbox"/> 1 bits per pixel external
Light Source	LED

## Interface Specifications

For Computer	Hi-Speed USB
--------------	--------------

## Fax Specifications

Fax Type	Walk-up black and white and color fax capability (ITU-T Super Group 3)
Supported Lines	Standard analogue telephone lines, PBX (Private Branch Exchange) telephone systems
Speed	Up to 33.6 kbps
Resolution	Monochrome <input type="checkbox"/> Standard: 203 × 98 dpi <input type="checkbox"/> Fine: 203 × 196 dpi <input type="checkbox"/> Photo: 203 × 196 dpi Color <input type="checkbox"/> Fine: 200 × 200 dpi <input type="checkbox"/> Photo: 200 × 200 dpi
Page Memory	Up to 100 pages (when received ITU-T No.1 chart in monochrome draft mode)
Redial*	2 times (with 1 minute intervals)
Interface	RJ-11 Phone Line, RJ-11 Telephone set connection

\* The specifications may differ by country or region.

## Wi-Fi Specifications

Standards	IEEE802.11b/g/n*1
-----------	-------------------

## Appendix

Frequency Range	2.4 GHz
Coordination Modes	Infrastructure, Ad hoc <sup>*2</sup> , Wi-Fi Direct <sup>*3 *4</sup>
Wireless Securities	WEP (64/128bit), WPA2-PSK (AES) <sup>*5</sup>

\*1 Complies with either IEEE 802.11b/g/n or IEEE 802.11b/g depending on location of purchase.

\*2 Not supported for IEEE 802.11n.

\*3 Not supported for IEEE 802.11b.

\*4 Simple AP mode is compatible with a Wi-Fi connection (infrastructure) or an Ethernet connection. See the *Network Guide* for more details.

\*5 Complies with WPA2 standards with support for WPA/WPA2 Personal.

## Ethernet Specifications

Standards	IEEE802.3i (10BASE-T) <sup>*1</sup> IEEE802.3u (100BASE-TX) IEEE802.3az (Energy Efficient Ethernet) <sup>*2</sup>
Communication Mode	Auto, 10Mbps Full duplex, 10Mbps Half duplex, 100Mbps Full duplex, 100Mbps Half duplex
Connector	RJ-45

\*1 Use a category 5e or higher STP (Shielded twisted pair) cable to prevent risk of radio interference.

\*2 The connected device should comply with IEEE802.3az standards.

## Security Protocol

SSL/TLS	HTTPS Server/Client, IPPS
---------	---------------------------

## Supported Third Party Services

AirPrint	Print	iOS 5 or later/Mac OS X v10.7.x or later
	Scan	Mac OS X v10.9.x or later
	Fax	Mac OS X v10.8.x or later
Google Cloud Print		

## Appendix

### Dimensions

Dimensions	<p>Storage</p> <ul style="list-style-type: none"> <li><input type="checkbox"/> Width: 490 mm (19.3x in.)</li> <li><input type="checkbox"/> Depth: 377 mm (14.8 in.)</li> <li><input type="checkbox"/> Height: 229 mm (9.0 in.)</li> </ul> <p>Printing</p> <ul style="list-style-type: none"> <li><input type="checkbox"/> Width: 490 mm (19.3 in.)</li> <li><input type="checkbox"/> Depth: 543 mm (21.4 in.)</li> <li><input type="checkbox"/> Height: 294 mm (11.6 in.)</li> </ul>
Weight*	Approx. 6.3 kg (13.9x lb)

\* Without the ink and the power cord.

### Electrical Specifications

Rated Power Supply Voltage	100 to 240 V
Rated Frequency Range	50 to 60 Hz
Rated Current	0.5 to 0.3 A
Power Consumption (with USB Connection)	<p>Standalone copying: Approx. 11 W (ISO/IEC24712)</p> <p>Ready mode: Approx. 4.0 W</p> <p>Sleep mode: Approx. 1.6 W</p> <p>Power off: Approx. 0.3 W</p>

**Note:**

- Check the label on the printer for its voltage.
- For European users, see the following Website for details on power consumption.  
<http://www.epson.eu/energy-consumption>
- For users in Belgium, power consumption when copying may vary.  
Check <http://www.epson.be> for the latest specifications.

Appendix

### Environmental Specifications

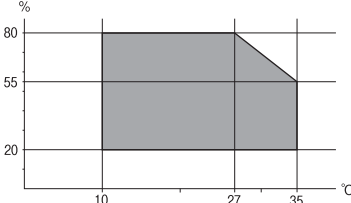
<p>Operation</p>	<p>Use the printer within the range shown in the following graph.</p>  <p>Temperature: 10 to 35°C (50 to 95°F) Humidity: 20 to 80% RH (without condensation)</p>
<p>Storage</p>	<p>Temperature: -20 to 40°C (-4 to 104°F)* Humidity: 5 to 85% RH (without condensation)</p>

\* You can store for one month at 40°C (104°F).

### Environmental Specifications for Ink Bottles

<p>Storage Temperature</p>	<p>-20 to 40 °C (-4 to 104 °F)*</p>
<p>Freezing Temperature</p>	<p>-15 °C (5 °F) Ink thaws and is usable after approximately 2 hours at 25 °C (77 °F).</p>

\* You can store for one month at 40 °C (104 °F).

### System Requirements

- Windows 8.1 (32-bit, 64-bit)/Windows 8 (32-bit, 64-bit)/Windows 7 (32-bit, 64-bit)/Windows Vista (32-bit, 64-bit)/Windows XP Professional x64 Edition/Windows XP (32-bit)/Windows Server 2012 R2/Windows Server 2012/Windows Server 2008 R2/Windows Server 2008 (32-bit, 64-bit)/Windows Server 2003 R2 (32-bit, 64-bit)/Windows Server 2003 (32-bit, 64-bit)
- Mac OS X v10.10.x/Mac OS X v10.9.x/Mac OS X v10.8.x/Mac OS X v10.7.x/Mac OS X v10.6.8

**Note:**

- Mac OS X may not support some applications and features.
- The UNIX File System (UFS) for Mac OS X is not supported.

# Regulatory Information

## Standards and Approvals

### Standards and Approvals for U.S. Model

Safety	UL60950-1 CAN/CSA-C22.2 No.60950-1
EMC	FCC Part 15 Subpart B Class B CAN/CSA-CEI/IEC CISPR 22 Class B

This equipment contains the following wireless module.

Manufacturer: Askey Computer Corporation

Type: WLU6320-D69 (RoHS)

This product conforms to Part 15 of the FCC Rules and RSS-210 of the IC Rules. Epson cannot accept responsibility for any failure to satisfy the protection requirements resulting from a non-recommended modification of the product. Operation is subject to the following two conditions: (1) this device may not cause harmful interference, and (2) this device must accept any interference received, including interference that may cause undesired operation of the device.

To prevent radio interference to the licensed service, this device is intended to be operated indoors and away from windows to provide maximum shielding. Equipment (or its transmit antenna) that is installed outdoors is subject to licensing.

### Standards and Approvals for European Model

Low voltage directive 2006/95/EC	EN60950-1
EMC directive 2004/108/EC	EN55022 Class B EN61000-3-2 EN61000-3-3 EN55024
R&TTE directive 1999/5/EC	EN300 328 EN301 489-1 EN301 489-17 TBR21 EN60950-1

For European users

We, Seiko Epson Corporation, hereby declare that the following equipment Model is in compliance with the essential requirements and other relevant provisions of Directive 1999/5/EC:

C463C

## Appendix

For use only in Ireland, UK, Austria, Germany, Liechtenstein, Switzerland, France, Belgium, Luxemburg, Netherlands, Italy, Portugal, Spain, Denmark, Finland, Norway, Sweden, Iceland, Croatia, Cyprus, Greece, Slovenia, Malta, Bulgaria, Czech, Estonia, Hungary, Latvia, Lithuania, Poland, Romania, and Slovakia.

Epson cannot accept responsibility for any failure to satisfy the protection requirements resulting from a non-recommended modification of the products.



### Standards and Approvals for Australian Model

EMC	AS/NZS CISPR22 Class B
-----	------------------------

Epson hereby declares that the following equipment Models are in compliance with the essential requirements and other relevant provisions of AS/NZS4268:

C463C

Epson cannot accept responsibility for any failure to satisfy the protection requirements resulting from a non-recommended modification of the products.

### Restrictions on Copying

Observe the following restrictions to ensure the responsible and legal use of the printer.

Copying of the following items is prohibited by law:

- Bank bills, coins, government-issued marketable securities, government bond securities, and municipal securities
- Unused postage stamps, pre-stamped postcards, and other official postal items bearing valid postage
- Government-issued revenue stamps, and securities issued according to legal procedure

Exercise caution when copying the following items:

- Private marketable securities (stock certificates, negotiable notes, checks, etc.), monthly passes, concession tickets, etc.
- Passports, driver's licenses, warrants of fitness, road passes, food stamps, tickets, etc.

**Note:**

*Copying these items may also be prohibited by law.*

Responsible use of copyrighted materials:

Printers can be misused by improperly copying copyrighted materials. Unless acting on the advice of a knowledgeable attorney, be responsible and respectful by obtaining the permission of the copyright holder before copying published material.

---

## Checking the Total Number of Pages Fed Through the Printer

You can check the total number of pages fed through the printer.

## Checking the Total Number of Pages Fed Through the Printer - Control Panel

The information is printed together with the nozzle check pattern.

1. Load A4-size plain paper in the printer.
2. Enter **Setup** from the home screen.
3. Select **Maintenance > Print Head Nozzle Check**.
4. Follow the on-screen instructions to print the nozzle check pattern.

## Checking the Total Number of Pages Fed Through the Printer - Windows

1. Access the printer driver window.
2. Click **Printer and Option Information** on the **Maintenance** tab.

### Related Information

➔ [“Windows Printer Driver” on page 91](#)

## Checking the Total Number of Pages Fed Through the Printer - Mac OS X

1. Select **System Preferences** from the  menu > **Printers & Scanners** (or **Print & Scan**, **Print & Fax**), and then select the printer.
2. Click **Options & Supplies > Utility > Open Printer Utility**.
3. Click **Printer and Option Information**.

---

## Saving Power

The printer enters sleep mode or turns off automatically if no operations are performed for a set period. You can adjust the time before power management is applied. Any increase will affect the printer's energy efficiency. Please consider the environment before making any change.

### Saving Power - Control Panel

1. Enter **Setup** from the home screen.
2. Select **Common Settings**.
3. Select **Power Off Timer** or **Sleep Timer**, and then make settings.



## Transporting the Printer

When you need to transport the printer to move or for repairs, follow the steps below to pack the printer.

**Caution:**

*Be careful not to trap your hand or fingers when opening or closing the scanner unit. Otherwise you may be injured.*

**Important:**

- ❑ *When storing or transporting the printer, avoid tilting it, placing it vertically, or turning it upside down; otherwise ink may leak.*

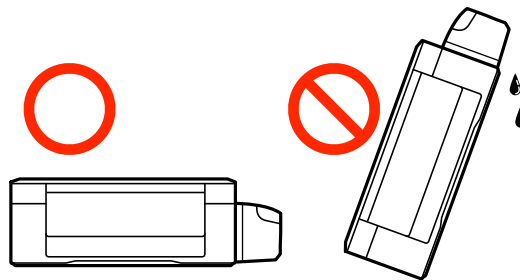

- ❑ *When storing or transporting an ink bottle after removing its seal, do not tilt the bottle and do not subject it to impacts or temperature changes. Otherwise, ink may leak even if the cap on the ink bottle is tightened securely. Be sure to keep the ink bottle upright when tightening the cap, and take measures to prevent ink from leaking when you transport the bottle.*
- ❑ *Do not put opened ink bottles in the box with printer.*

1. Turn off the printer by pressing the  button.
2. Make sure the power light turns off, and then unplug the power cord.

**Important:**

*Unplug the power cord when the power light is off. Otherwise, the print head does not return to the home position causing the ink to dry, and printing may become impossible.*

3. Disconnect all cables such as the power cord and USB cable.
4. Remove all of the paper from the printer.
5. Make sure there are no originals on the printer.

Appendix

6. Open the scanner unit with the document cover closed. Secure the print head to the case with tape.

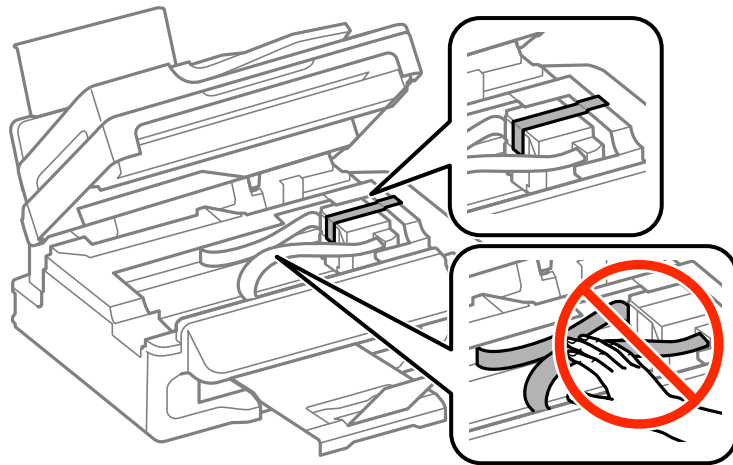

7. Close the scanner unit.

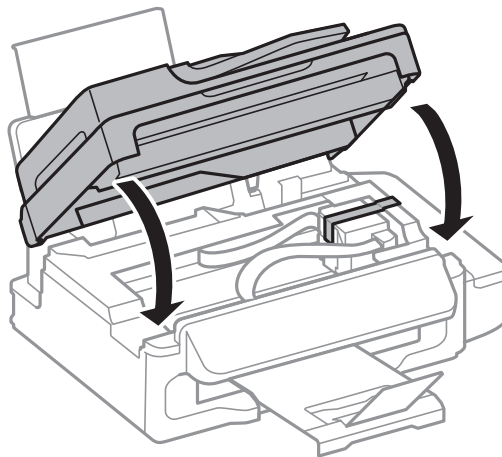

8. Prepare to pack the printer as shown below.

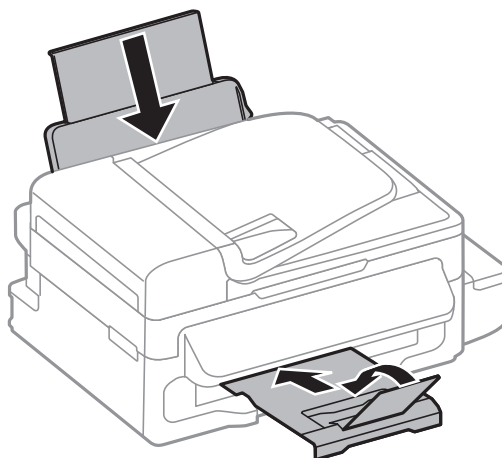

## Appendix

9. Make sure to install the cap onto the ink tank securely.

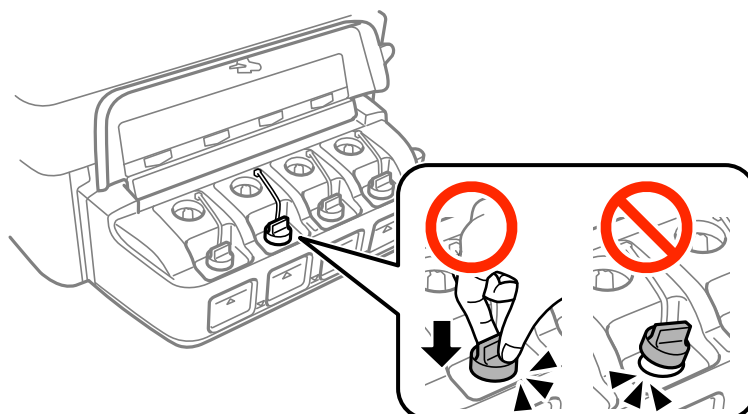

10. Pack the printer in its box using the protective materials.

When you use the printer again, make sure you remove the tape securing the print head. If print quality has declined the next time you print, clean and align the print head.

### Related Information

- ➔ “Part Names and Functions” on page 12
- ➔ “Checking and Cleaning the Print Head” on page 82
- ➔ “Aligning the Print Head” on page 84

---

## Where to Get Help

### Technical Support Web Site

If you need further help, visit the Epson support website shown below. Select your country or region and go to the support section of your local Epson website. The latest drivers, FAQs, manuals, or other downloadables are also available from the site.

<http://support.epson.net/>

<http://www.epson.eu/Support> (Europe)

If your Epson product is not operating properly and you cannot solve the problem, contact Epson support services for assistance.

### Contacting Epson Support

#### Before Contacting Epson

If your Epson product is not operating properly and you cannot solve the problem using the troubleshooting information in your product manuals, contact Epson support services for assistance. If Epson support for your area is not listed below, contact the dealer where you purchased your product.

Epson support will be able to help you much more quickly if you give them the following information:

## Appendix

- Product serial number

(The serial number label is usually on the back of the product.)

- Product model

- Product software version

(Click **About**, **Version Info**, or a similar button in the product software.)

- Brand and model of your computer

- Your computer operating system name and version

- Names and versions of the software applications you normally use with your product

**Note:**

*Depending on the product, the dial list data for fax and/or network settings may be stored in the product's memory. Due to breakdown or repair of a product, data and/or settings may be lost. Epson shall not be responsible for the loss of any data, for backing up or recovering data and/or settings even during a warranty period. We recommend that you make your own backup data or take notes.*

## Help for Users in Europe

Check your Pan-European Warranty Document for information on how to contact Epson support.

## Help for Users in Australia

Epson Australia wishes to provide you with a high level of customer service. In addition to your product manuals, we provide the following sources for obtaining information:

### Internet URL

<http://www.epson.com.au>

Access the Epson Australia World Wide Web pages. Worth taking your modem here for the occasional surf! The site provides a download area for drivers, Epson contact points, new product information and technical support (e-mail).

### Epson Helpdesk

Epson Helpdesk is provided as a final backup to make sure our clients have access to advice. Operators on the Helpdesk can aid you in installing, configuring and operating your Epson product. Our Pre-sales Helpdesk staff can provide literature on new Epson products and advise where the nearest dealer or service agent is located. Many types of queries are answered here.

The Helpdesk numbers are:

Phone: 1300 361 054

We encourage you to have all the relevant information on hand when you ring. The more information you prepare, the faster we can help solve the problem. This information includes your Epson product manuals, type of computer, operating system, application programs, and any information you feel is required.

## Help for Users in New Zealand

Epson New Zealand wishes to provide you with a high level of customer service. In addition to your product documentation, we provide the following sources for obtaining information:

## Appendix

### Internet URL

<http://www.epson.co.nz>

Access the Epson New Zealand World Wide Web pages. Worth taking your modem here for the occasional surf! The site provides a download area for drivers, Epson contact points, new product information and technical support (e-mail).

### Epson Helpdesk

Epson Helpdesk is provided as a final backup to make sure our clients have access to advice. Operators on the Helpdesk can aid you in installing, configuring and operating your Epson product. Our Pre-sales Helpdesk staff can provide literature on new Epson products and advise where the nearest dealer or service agent is located. Many types of queries are answered here.

The Helpdesk number is:

Phone: 0800 237 766

We encourage you to have all the relevant information on hand when you ring. The more information you prepare, the faster we can help solve the problem. This information includes your Epson product documentation, type of computer, operating system, application programs, and any information you feel is required.