

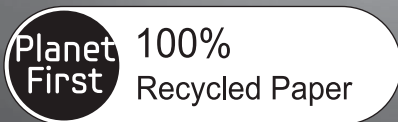

DV9 Series  
DV8 Series  
DV7 Series

# Heat Pump Dryer user manual



This manual is made with 100% recycled paper.

imagine the possibilities

Thank you for purchasing this Samsung product.

To receive more complete service,  
please register your product at

[www.samsung.com/register](http://www.samsung.com/register)



# features

---

## **1. Super capacity**

Now you can dry extra-large loads. Our 9kg, 8kg, and 7kg capacity dryers have large drums, circulating large volumes of air through your clothes, and drying them faster. Reverse tumble and anti-wrinkle features give a better wrinkle-free result and makes ironing easier.

## **2. Visible water tank indicator**

A first for condenser dryer design, you can now see the level of the condensed water inside of the tank through the transparent section of the panel. No more coming home only to find incomplete drying. If the tank is close to needing emptied, you can see it and fix it.

## **3. Sensor drying (fully automatic drying)**

By adopting humidity and temperature sensors, the operating time and energy usage is controlled using digital technology. Consistent levels of drying, much safer care for your fabrics, and more flexibility for easy ironing settings or getting ready for short term or long term cupboard storage.

## **4. Interior lamp (DV9, DV8 Series)**

No more sock hunting in the dark; the interior lamp allows easy viewing of the drum, aiding a lot in making sure you picked up every item every time.

## **5. Rack drying (DV9 Series Only)**

This is a low-temperature drying function developed to allow new flexibility in what you can dry in this appliance. Delicates can be protected better using the platform to avoid tumbling action, great for tights, or vulnerable fabrics not usually suitable for a dryer. Even sport shoes, which are not appropriate for tumbling, can be dried safely in this way.

## **6. Reversible door for easier door opening at any location**

Our dryers will fit into more spaces without a door conflict, because the opening direction of our easy reversible door can be changed with ease. This is great for location options, but also helps in case you stack the dryer over the washing machine. You can change the direction left/right opening to whatever suits your home.

## **7. Diamond drum for fabric care**

The Diamond-shaped drum reduces abrasion and offers excellent protection to your laundry.

## **8. High energy efficiency**

Heat Pump dryers offer a great way to save energy and still receive the services of a high performance drying appliance. This machine has been designed and optimised to make the most efficient use of power we can offer, and this appliance is much more efficient than the original Condenser Dryer technology.

# safety information

Congratulations on your new Samsung Dryer. This manual contains important information on the installation, use, and care of your appliance. Please take the time to read this manual to take full advantage of your dryer's many benefits and features.













	<h2>WARNING - Risk of Fire</h2>
<ul style="list-style-type: none"> <li>• Clothes dryer installation must be performed by a qualified technician.</li> <li>• Install the clothes dryer according to the manufacturer's instructions and local codes.</li> <li>• To reduce the risk of severe injury or death, follow all installation instructions.</li> </ul>	

## WHAT YOU NEED TO KNOW ABOUT SAFETY INSTRUCTIONS

Warnings and Important Safety Instructions in this manual do not cover all possible conditions and situations that may occur. It is your responsibility to use common sense, caution, and care when installing, maintaining, or operating your dryer.

Always contact your manufacturer about problems or conditions you do not understand.

## IMPORTANT SAFETY SYMBOLS AND PRECAUTIONS

 <b>WARNING</b>	Hazards or unsafe practices that may result in <b>severe personal injury or death.</b>
 <b>CAUTION</b>	Hazards or unsafe practices that may result in <b>minor personal injury or property damage.</b>
 <b>CAUTION</b>	To reduce the risk of fire, explosion, electric shock, or personal injury when using your washer, follow these basic safety precautions:
	Do NOT attempt.
	Do NOT disassemble.
	Do NOT touch.
	Follow directions explicitly.
	Unplug the power plug from the wall socket.
	Make sure the machine is grounded to prevent electric shock.
	Call the service center for help.
	Note
	Read operator's manual

**These warning icons are here to prevent injury to you and others.**

**Please follow them explicitly.**

**After reading this section, keep it in a safe place for future reference.**

**Read all instructions before using the appliance.**

# safety information

---



This appliance is not intended for use by persons (including children) with reduced physical, sensory or mental capabilities, or lack of experience and knowledge, unless they have been given supervision or instruction concerning use of the appliance by a person responsible for their safety.

Children should be supervised to ensure that they do not play with the appliance.



Never stop a tumble dryer before the end of the drying cycle unless all items are quickly removed and spread out so that the heat is dissipated.

Do not touch the glass door during drying cycle as it is hot. This may result in burns.

## INSTRUCTION ABOUT THE WEEE MARK

---



### **Correct Disposal of This Product (Waste Electrical & Electronic Equipment)**

**(Applicable in countries with separate collection systems)**

This marking on the product, accessories or literature indicates that the product and its electronic accessories (e.g. charger, headset, USB cable) should not be disposed of with other household waste at the end of their working life. To prevent possible harm to the environment or human health from uncontrolled waste disposal, please separate these items from other types of waste and recycle them responsibly to promote the sustainable reuse of material resources.

Household users should contact either the retailer where they purchased this product, or their local government office, for details of where and how they can take these items for environmentally safe recycling.

Business users should contact their supplier and check the terms and conditions of the purchase contract. This product and its electronic accessories should not be mixed with other commercial wastes for disposal.



## SEVERE WARNING SIGNS FOR INSTALLATION

---



The installation of this appliance must be performed by a qualified technician or service company.

- Failure to do so may result in electric shock, fire, an explosion, problems with the product, or injury.

Plug the power cord into an AC 220~240V/50Hz wall socket or higher and use the socket for this appliance only. In addition, do not use an extension cord.

- Sharing a wall socket with other appliances using a power strip or extending the power cord may result in electric shock or fire.
- Ensure that the power voltage, frequency and current are the same as those of the product specifications. Failure to do so may result in electric shock or fire. Failure Plug the power plug into the wall socket firmly.

Remove all foreign substances such as dust or water from the power plug terminals and contact points using a dry cloth on a regular basis.

- Unplug the power plug and clean it with a dry cloth.
- Failure to do so may result in electric shock or fire.

Keep all packaging materials well out of the reach of children, as packaging materials can be dangerous to children.

- If a child places a bag over its head, it may result in suffocation.
- 



This appliance must be properly grounded.

Do not ground the appliance to a gas pipe, plastic water pipe, or telephone line.

- This may result in electric shock, fire, an explosion, or problems with the product
- Never plug the power cord into a socket that is not grounded correctly and make sure that it is in accordance with local and national codes.

Do not install or keep the product exposed to the outdoor elements.

---



Do not use a damaged power plug, damaged power cord or loose wall socket.

- This may result in electric shock or fire.

If the plug (power supply cord) is damaged, it must be replaced by the manufacturer or its service agent or a similar qualified technician in order to avoid a hazard.

This appliance should be positioned to be accessible to the power plug after installation.

Do not pull or excessively bend the power cord.

Do not twist or tie the power cord.

Do not hook the power cord over a metal object, place a heavy object on the power cord, insert the power cord between objects, or push the power cord into the space behind the appliance.

- This may result in electric shock or fire.

Do not pull the power cord, when unplugging the power plug.

- Unplug the power plug by holding the plug.
- Failure to do so may result in electric shock or fire.

This appliance must be properly grounded. Never plug the power cord into a receptacle that is not grounded adequately and in accordance with local and national codes. See installation instructions for grounding this appliance.

Install this appliance in a location with solid, level floor.

- Failing to do so may result in abnormal vibrations, noise or problems with the product.

Since an ingredient in hair spray may degrade the hydrophile property of the heat exchanger so that dew may appear on the outer surface of the appliance when the cooling operation is running, do not install the appliance in a beauty salon.

# safety information

---



## SEVERE WARNING SIGNS FOR USING

---

-  Do not let children or pets on or into the product. In addition, when disposing of this product, disassemble the door lock (lever).
- This may result in children falling and injuring themselves.
  - If children become locked in the product, there is a danger of suffocation.
- Do not try to access the inside of the product when the drum is rotating.
- Do not sit on the product or lean against the door.
- This may result in the product turning over and resulting in injury.
- Dry the laundry only after it was spun by an appropriate washing machine.
- Do not dry unwashed items in the tumble dryer.
- Do not drink the condensed water.
- Never stop a tumble dryer before the end of the drying cycle unless all items are quickly removed and spread out so that the heat is dissipated.
- Do not dry laundry contaminated by inflammable materials such as gasoline, kerosene, benzene, thinner, alcohol, etc.
- This may result in electric shock, fire or explosion.
- Do not let pets chew or play with the dryer.
- This may result in electric shock or injury.
- When disposing of the product, separate the door and the power cord before disposing of the product.
- Failing to do so may result in damage to the power code or an injury.
- Do not touch the power plug with wet hands.
- This may result in electric shock.
- When gas (city gas, propane gas, LP gas) leaks, do not touch this appliance or the power cord, ventilate immediately.
- At this time, do not use the ventilating fan.
  - A spark may cause an explosion or fire.
- 

-  Do not repair, replace, or attempt to service any part of the appliance unless specifically recommended in the user-repair instructions. You must also have the skills necessary to service this appliance.
- 

-  Do not attempt to repair, disassemble, or modify the appliance yourself.
- Do not use any fuse (such as cooper, steel wire, etc.) other than the standard fuse.
  - When repairing or reinstalling the appliance is required, contact your nearest service center.
  - Failure to do so may result in electric shock, fire, problems with the product, or injury.
- The product you have purchased is designed for domestic use only.
- The use for business purposes qualifies as product misuse. In this case, the product will not be covered by the standard warranty provided by Samsung and no responsibility can be attributed to Samsung for malfunctions or damages resulting from such misuse.
- If the product generates strange noise, smells of something burning, or generates smoke, immediately cut-off the power and contact the service center.
- Otherwise, it may cause an electric shock or fire as a result.



## CAUTION SIGNS FOR USING

---



Do not stand on top of the appliance or place objects (such as laundry, lighted candles, lighted cigarettes, dishes, chemicals, metal objects, etc.) on the appliance.

- This may result in electric shock, fire, problems with the product, or injury.

Do not touch the glass door and inside of the drum during or just after drying as it is hot.

- This may result in burns.

Do not press the buttons using sharp objects such as pins, knives, fingernails, etc.

- This may result in electric shock or injury.

Do not dry laundry containing forming rubber (latex) or similar rubber textures.

- If forming rubber is heated, it may start a fire.

Do not dry laundry contaminated by vegetable oil or cooking oil as a large amount of the oil will not be removed when washing the laundry. In addition, use the Cool Down cycle so that the laundry is not heated.

- The oxidization heat of the oil may start a fire.

Make sure that the pockets of all clothing to be dried are empty.

- Hard, sharp objects, such as coins, safety pins, nails, screws, or stones can cause extensive damage to the appliance.

Do not dry clothing with large buckles, buttons, or other heavy metal (zippers, hooks and eyelets, button-up covers).

If necessary, use the laundry net for small and lightweight laundry such as fabric tie belt, apron strings, and underwire bras which can dissolve or break during a cycle.

Recommend against using drying sheets to reduce static electricity as this could lead to damage to your laundry and also potential damage to the appliance.

- This may result in damage to the laundry.

Do not use the dryer near dangerous powders such as coal dust, wheat flour, etc.

- This may result in electric shock, fire or an explosion.

Do not place inflammable materials near the product.

- This may result in toxic gases from the product, damage to parts, electric shock, fire or an explosion.

- The appliance should not be placed behind lockable doors etc.

Contains fluorinated greenhouse gases covered by the Kyoto Protocol.

Hermetically sealed system.

Do not vent gases into the atmosphere.

Refrigerant type : R-134a

- Quantity : 0.4 kg
- Global Warming Potential(GWP) : 1300



## SEVERE WARNING SIGNS FOR CLEANING

---

Do not clean the appliance by spraying water directly onto it.

Do not use benzene, thinner or alcohol to clean the appliance.

- This may result in discolouration, deformation, damage, electric shock or fire.

Before cleaning or performing maintenance, unplug the appliance from the wall socket.

- Failure to do so may result in electric shock or fire.

Clean the filter case before and after using the dryer.

Clean the inside of the product on a regular basis by asking an authorized service engineer.

Clean the Heat Exchanger with a soft brush or vacuum cleaner once a month, Do not touch the heat exchanger with your hand. Otherwise, it may cause an injury.

The interior of the dryer should be cleaned periodically by qualified service personnel.

# contents

---

## INSTALLING YOUR DRYER

9

- 9 Unpacking your dryer and Installing guide
- 9 See Dryer Exterior
- 10 Check before installing
- 10 Before using the product
- 10 Important to installer
- 10 Location considerations
- 10 Alcove or closet installation
- 11 Electrical requirements
- 11 Grounding
- 12 Installation side by side
- 12 Final installation checklist
- 13 Draining water without using the water tank
- 13 Connecting the drain hose
- 15 Installation stacking
- 16 Door Reversal

## OPERATING INSTRUCTIONS, TIPS

18

- 18 Overview of the control panel
- 21 Child lock
- 21 Delay End
- 22 Smart Check
- 23 Rack Dry (DV9 Series Only)
- 24 Load the dryer properly
- 24 Getting started

## CARE AND CLEANING

25

- 25 Clean the heat exchange
- 25 Control Panel
- 25 Stainless Steel Tumbler
- 25 Dryer Exterior
- 26 Dumping condensed water (☞)
- 26 Cleaning the filter case (☞)
- 27 Cleaning the Heat Exchanger Filter (☞)

## SPECIAL LAUNDRY TIPS

28

- 28 Special laundry tips

## TROUBLESHOOTING

29

- 29 Check these points if your dryer...
- 31 Information codes

## APPENDIX

32

- 32 Fabric care chart
- 33 Protecting the environment
- 33 Declaration of conformity
- 33 Specifications
- 34 Cycle chart
- 35 Sheet of household tumble driers



# installing your dryer

## UNPACKING YOUR DRYER AND INSTALLING GUIDE

Hire a professional to install this dryer properly. If there is a service call performed as a result of poor setup, adjustment, and connection, it is considered the responsibility of the installer. It is recommended that a professional is called to install this appliance, especially for more difficult installations involving draining to the mains water supply or product stacking. If problems of installation result in a service visit to fix a fault, this is typically considered to be the responsibility of the installer.

Make sure you have everything necessary for proper installation (AC 220~240V/50Hz).

A GROUNDED ELECTRICAL OUTLET is required. See Electrical Requirements (See page 11).

## SEE DRYER EXTERIOR

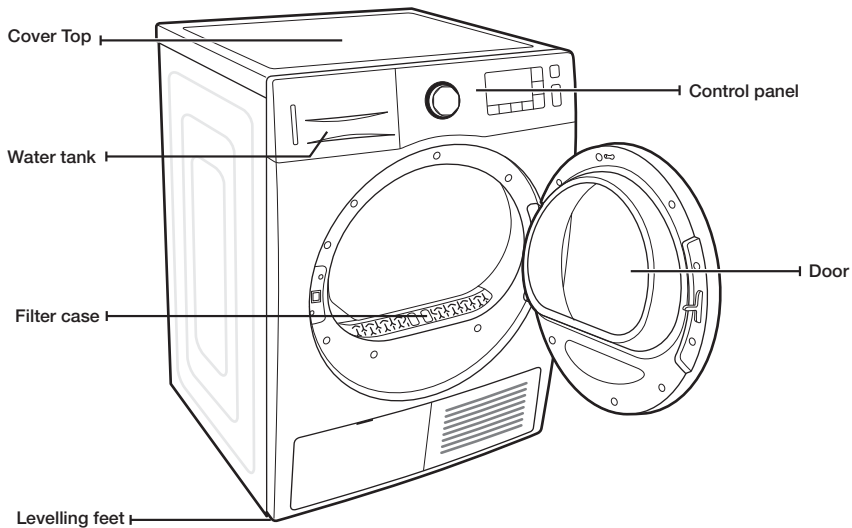

### Parts



Hose guide



Cable tie



Hose connector



Long drain hose (2m)



Manual book



Rack Dry (9 Series)

# installing your dryer

---

## CHECK BEFORE INSTALLING

---

- Do not plug the power cord into the wall outlet before completing the dryer installation.
- Check the appearance of the product for any damaged parts before starting the product installation.
- If there are any parts that appear to be damaged, please contact your nearest Samsung Customer Service Center.
- When moving the product, do not move the product by yourself.
- Take care of the edges of the dryer as they can be sharp.
- Do not install the dryer in a location exposed to frost. Cold water may damage the product.
- Use the product indoors only.
- Do not place the dryer on one side when lifting it, and do not move the dryer in such a way that the internal parts shake. This may result in damage to the internal parts of the product.

## BEFORE USING THE PRODUCT

---

- Check if there are any accessories remaining inside the drum.
- Plug in the power cord just before operating the product.
- Do not block the air inlet hole of the cooling grill at the front of the dryer.
- Do not place inflammable objects near the dryer and keep the surroundings clean.
- Keep the dryer level with the ground.
- Do not remove the adjustable levelling feet of the dryer. They are necessary to keep the product level with the ground.

## IMPORTANT TO INSTALLER

---

Please read the following instructions carefully before installing the dryer. These instructions should be kept for future reference.



REMOVE THE DOOR FROM ALL DISCARDED APPLIANCES TO AVOID THE DANGER OF A CHILD SUFFOCATING.

## LOCATION CONSIDERATIONS

---

Because a condensing type has been adopted, which condenses and processes air inside the dryer, external ventilation is not required.

Therefore, The dryer can be installed and used in any location where the temperature is between 5 and 35 degrees centigrade, unlike a conventional dryer that requires an external exhaust system.

## ALCOVE OR CLOSET INSTALLATION

---

To operate safely and properly, your new Dryer requires minimum clearances of:

Sides – 25 mm

Rear – 51 mm

Top – 25 mm

Front – 470 mm

If both the washing machine and a dryer are installed together, the front of the alcove or closet must have at least 465 mm unobstructed air opening.

## ELECTRICAL REQUIREMENTS

---

 Electrical Requirements is AC 220–240 V / 50 Hz.



- Improper connection of the equipment grounding conductor can result in a risk of electric shock. Check with a qualified electrician or serviceman if you are in doubt as to whether your dryer is properly grounded. Do not modify the plug provided with your dryer – if it doesn't fit the outlet, have a proper outlet installed by a qualified electrician.
- To prevent unnecessary risk of fire, electrical shock, or personal injury, all wiring and grounding must be done in accordance with local codes, or in the absence of local codes, it is your responsibility to provide adequate electrical services for your dryer.

## GROUNDING

---

Your dryer must be grounded. If your dryer malfunctions or breaks down, grounding will reduce the risk of electric shock by providing a path of least resistance for the electric current.

Your dryer comes with a power cord having a three-prong grounding plug for use in a properly installed and grounded outlet.



Never connect the ground wire to plastic plumbing lines, gas lines, or hot water pipes.

Improperly connecting the equipment-grounding conductor can result in electrical shock.

Check with a qualified electrician or serviceman if you are unsure if the dryer is properly grounded. Do not modify the plug provided with the dryer. If it does not fit the outlet, have a proper outlet installed by a qualified electrician.



If the product is not grounded, there is a danger of fire or electric shock.

# installing your dryer

## INSTALLATION SIDE BY SIDE

**For proper installation, we recommend that you hire a professional. To install:**

1. Move your dryer to an appropriate location for installation. Consider installing the dryer and washer side-by-side. Lay two of the carton cushion-tops on the floor. Tip your dryer on its side so it will lay across both cushion-tops.
  2. Set your dryer back in an upright position.
  3. To ensure that the dryer provides optimal drying performance, it must be level. To minimize vibration, noise, and unwanted movement, the floor must be a perfectly level, solid surface.
-  To set the dryer to the same height as the washer, fully retract the levelling feet by turning them counterclockwise, then loosen the legs by turning them clockwise

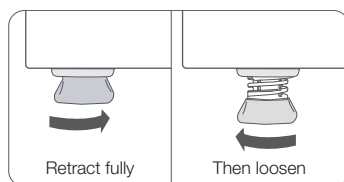

-  Adjust the levelling feet only as much as necessary to level the dryer. Extending the levelling feet more than necessary can cause the dryer to vibrate.
4. Review Electrical Requirements section (See page 11).  
BEFORE OPERATING OR TESTING.
  5. With a level, check your dryer and make necessary adjustments to the levelling legs.
  6. Plug in your dryer, and check operation by using the checklist below.

## FINAL INSTALLATION CHECKLIST

- Dryer is plugged into electrical outlet and is properly grounded.
- Dryer is leveled and is sitting firmly on the floor.
- Start your dryer to confirm that it runs, heats, and shuts off.
- Finally, check if the HE error occurs when after running the Time Dry cycle for 20 minutes.

## DRAINING WATER WITHOUT USING THE WATER TANK

You can use the dryer without using the water tank by following the procedures below.

Install the drain hose so that water can be drained well.

- Otherwise, the water may overflow and it may cause damage to the properties.

## CONNECTING THE DRAIN HOSE

The Dryer can pump the condensed water outside of the DRYER directly with drain hose provide.

The procedures to connect the drain hose are as follows.

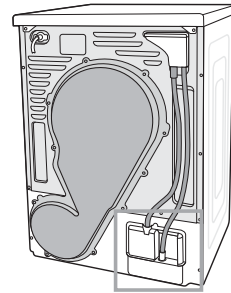

1. Disconnect the drain hose **(A)**.

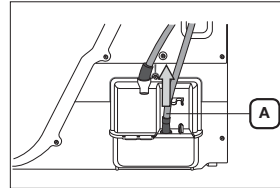

2. Connect the drain hose **(A)** to the other hole.

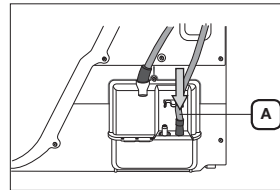

3. Connect accessory hose(long drain hose) **(B)** to the hole next to the hole that is connected to drain hose **(A)**.



- Because the dryer's drain pump can only pump up the drain water to a 90 cm height, when you connect the drain hose **(B)** to the drain point, make sure that the height of drain point does not exceed 90 cm. A drainage error may occur if the drain point exceeds 90 cm. If a drainage error occurs, the control panel displays an error code.
- After connecting the drain hose, you can directly drain the condensed water via the drain-outlet through the connected drain hose or through the washstand or the drain-outlet of the washstand.

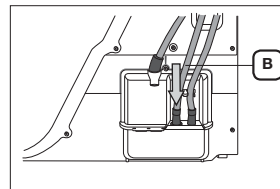

# installing your dryer

## Connecting the drain hose



Do not extend the drain hose.

Since water may leak from the connected part, be sure to use one long drain hose instead of connecting short ones. If you cannot help connecting more than one hose, be sure to seal the connected parts with silicone sealant. (Do not use the electric insulating tape for sealing.)

The end of the drain hose can be positioned in three ways:

1. **Over the edge of a wash basin:** The drain hose must be placed lower than 90cm. If the end of the drain hose needs to be placed above the ground, we recommend a height of 60cm ~ 90cm. To keep the drain hose spout bent, use the supplied plastic hose guide. Secure the guide to the wall with a hook or to the tap with a piece of string to prevent the drain hose from moving.

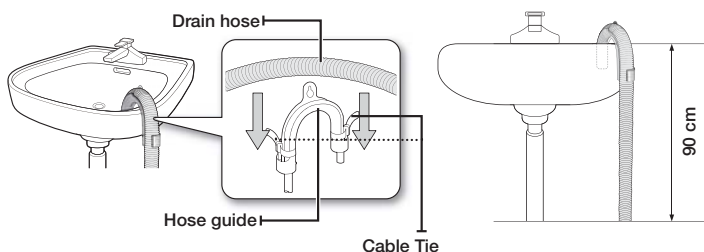

2. Assemble the drain hose and the hose guide and fix them with the cable-tie.
3. You can drain the condensed water by connecting the accessory hose (long drain hose) to the drain-outlet directly.

## Connecting the direct-hose

You can immediately drain the condensed water that comes out while drying, by connecting the drain hose to the tap.

1. Assemble the hose connector and the hose.



Since there is a danger of water leaking from the hose connector and accessory hose, make sure that they are connected firmly.

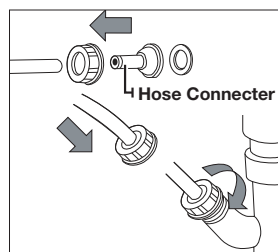

2. Connect the end of the hose to the tap.

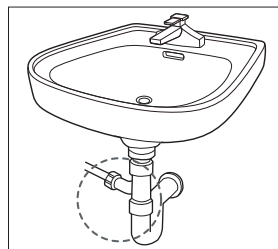

## INSTALLATION STACKING



In case of purchasing the additional stacking kit, contact our Samsung service center or local distributors. [Part no. SK-DH / SK-DA / SKK-DF]

The stacking kit differs depending on the model.

Only use the product in 1 hour after installing the stacking kit by tilting the product so that the product can run after the oil in the compressor becomes stable.

1. Carefully lay the dryer on its side. Use the packing material so you don't scratch the finish on the dryer.

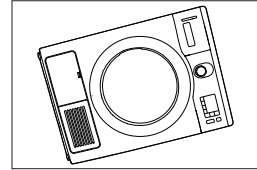

2. Install rubber pads to dryer base.
  - Locate the 4 rubber pads in the parts package. Insert the rubber pads into the holes at the bottom of the levelling legs.
  - Purchase the stacking-kit package additionally.

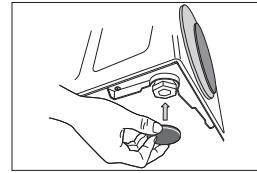

3. Set the dryer upright.



The stacking kit can only be installed for Samsung family products.

4. Install bracket to dryer.
  - Remove washer top cap screw from the rear left. Align left bracket holes with top cap screw hole on rear left of the unit and replace screw.
  - Leave screw loose so dryer hole alignment will be easier.
  - Repeat the above step with the right side.

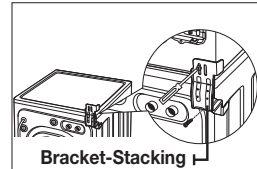

Bracket-Stacking

5. Install dryer and bracket on washer
  - Lift the dryer on top of the washer. Protect the washer control panel with cardboard or other protection. Be sure to lift the dryer high enough to clear the washer control panel. Personal Injury. More than two people are recommended to lift the dryer into position because of its weight and size. Failure to do so could result in injury.
  - Align the holes in the bracket with the holes in the back of the dryer. Using a Phillips screwdriver, attach the M4x12 tapping screws.
  - Tighten the washer bracket screws ; then tighten all stacking kit screws.

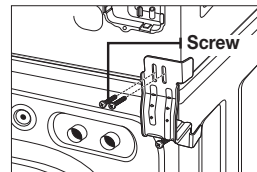

Screw

6. Finalise the installation
  - Refer to the washer Installation Instructions to complete the washer installation.
  - Refer to the dryer Installation Instructions to complete the dryer installation.
  - Carefully slide or walk the stacked washer and dryer into place. Use felt pads or other sliding device to assist moving and to protect flooring.



Do not push on the dryer once installed to top of the washer. Pushing on the dryer may result in pinched fingers.

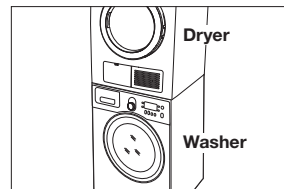

Dryer

Washer

# installing your dryer

## DOOR REVERSAL

Depending on your requirements (installation location, space constraints), you can change the direction the door opens.

**WARNING** This is done according to the customer's needs. The qualified technician or customer can do this themselves directly.

1. Unplug the power cord.
2. Remove the two screws from the door-hinge.
3. Lift the door to separate it.

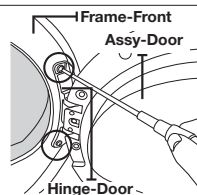

4. Remove the 16 screws.  
Disassemble the air seal and remove the 6 screws (3 flat head screws at the top and 3 round head screws at the bottom).  
(Only for Crystal Gloss door models)

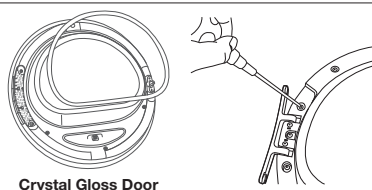

5. After removing the screw, rotate the Assy hinge door, the handle door by 180° as shown in the figure.

**CAUTION** Work carefully so that the door-seal is not removed.

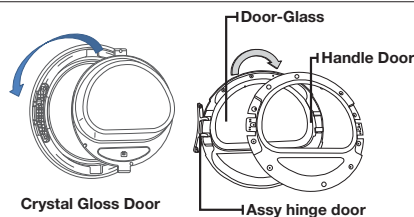

6. Fasten the 16 screws in the correct positions.  
Fasten the 6 screws and replace the air seal.  
(Only for Crystal Gloss door models)
7. Note that two of the screws have a different length from the others.  
(Use the longer screws for the door-lever.)

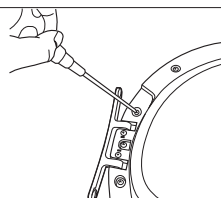

8. Move the position of the screw at the back of the door-hinge.

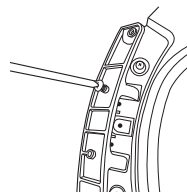



9. Fasten the screw in the bottom hole.

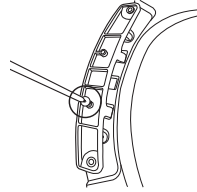

10. Remove the two screws holding the front-frame at the left.  
11. Remove the two screws holding the holder-lever at the left.

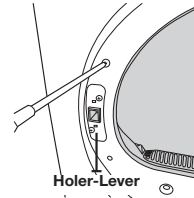

12. Now, move to the right side of the product and fasten the two screws holding the front-frame and the two screws holding the lever-holder.

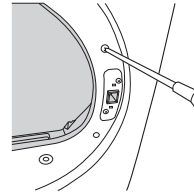

13. Align the door with the fixing holes.  
14. Fasten the two screws holding the door-hinge.

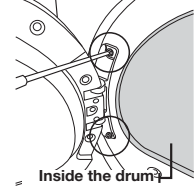

 You can restore the direction the door opens by following the procedures above, if necessary.

# operating Instructions, tips

**⚠ WARNING** To reduce the risk of fire, electric shock, or injury to persons, read the **IMPORTANT SAFETY INSTRUCTIONS** before operating this appliance.

## OVERVIEW OF THE CONTROL PANEL

### [DV9, DV8 Series]

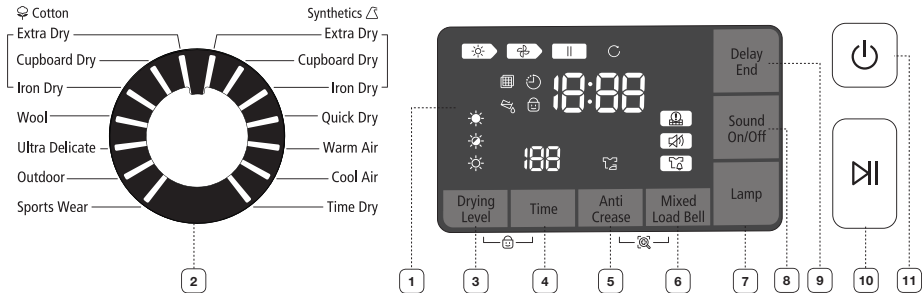

### [DV7 Series]

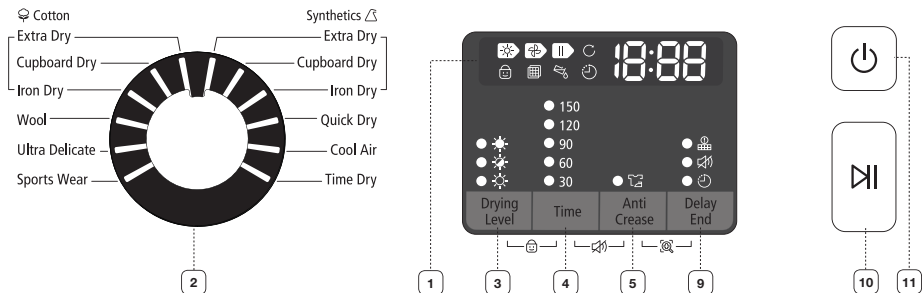

### 1 Digital Graphic Display

Displays the remaining drying cycle time, all cycle information, and error messages.



The display window shows the estimated time remaining in the cycle after you have pressed the **Start/Pause** button. The estimated time remaining may fluctuate as the cycle progresses.

The Drying light will illuminate and remain lit until the cycle is complete.



When your dryer is in the cool-down phase, the Cooling light will illuminate.

When your dryer is in the Anti Crease phase, the "Anti Crease light" will illuminate.

When the cycle is complete, "End" will appear in the display panel until you push the **Start/Pause** button or the **Power** button. If your dryer is paused during a cycle, the indicators will light up until you press the **Start/Pause** button.

















<p><b>2</b> Cycle Selector</p>	<p>When you turn on your dryer, the [Cotton] Cupboard Dry cycle is selected as default.</p> <p>Turn the Cycle Selector to select the cycle you want.</p> <p><b>Cotton</b> - For averagely or lightly soiled cottons, bed linen, table linen, underwear, towels, shirts, etc.</p> <ul style="list-style-type: none"> <li>• Extra Dry - Use for heavy-duty fabrics or items that should be very dry.</li> <li>• Cupboard Dry - Use this cycle to dry loads such as cotton, underwear, and linen (NOT appropriate for jeans).</li> <li>• Iron Dry - Finishes the dry cycle in a moist state appropriate for Ironing.</li> </ul> <p><b>Synthetics</b> - For averagely or lightly soiled blouses, shirts, etc., made of polyester (diolen, trevira), polyamide (perlon, nylon) or other similar blends.</p> <ul style="list-style-type: none"> <li>• Extra Dry - Use for heavy-duty fabrics or items that should be very dry.</li> <li>• Cupboard Dry - Use this cycle to dry loads such as shirts, blouses, bed linen and table linen. (NOT appropriate for jeans).</li> <li>• Iron Dry - Finishes the dry cycle in a moist state appropriate for Ironing.</li> </ul> <p><b>Quick Dry</b> - 60 min is automatically set as the drying time.</p> <p><b>Warm Air</b> - For small items, pre-dried laundry and normal fabrics in 30 minutes. (DV9, DV8 Series)</p> <p><b>Cool Air</b> - For all fabrics to need freshing tumbles without heating.</p> <p><b>Time Dry</b> - Time Dry allows you to select the desired cycle time.</p> <p>Turn the cycle selector dial to Time Dry, then press <b>Time</b> Button to set the drying time. Press the <b>Time</b> button repeatedly to scroll through the time settings. The drying time increase in every 30 minutes up to 150 minutes.</p> <p>After drying the laundry with the normal airy dry cycle, and you feel that the laundry has not dried completely, you can extend the drying time using the Time Dry cycle.</p> <p>After drying the laundry using a drying cycle, and you feel that the laundry has not dried completely, you can extend the drying time using the Time Dry cycle.</p> <p><b>Sports Wear</b> - Use for light sportswear such as sweatsuit.</p> <p><b>Outdoor</b> - For water-proof items such as mountain clothing, skiwear and sports wear. Fabrics include functional technology finishes and fibres such as spandex, stretch, and micro-fibre. We recommend that you use this drying cycle after you wash your laundry using the Outdoor Care cycle with your washing machine. (DV9, DV8 Series)</p> <p><b>Ultra Delicate</b> - The Delicates cycle is designed For lingerie.</p> <p><b>Wool</b> - For machine washable and tumble dryable wool only.</p> <p> For better drying results, turn the laundry inside out before drying it.</p> <p> Overloading the dryer may not yield the same results. For the Max Load of each drying course, refer to the Cycle Chart in the appendix</p>
<p><b>3</b> Drying Level button</p>	<p>To select the dry level in the Cotton, Synthetics cycles, press the <b>Drying Level</b> button. An indicator light will illuminate next to the dryness level you selected.</p> <p>Press the button repeatedly to scroll through the settings. Larger or bulkier loads may require the icon "☀" or "☀☀" Dry setting for complete dryness. the icon "☀☀" is designed to partially dry items. Use for items that lay flat or hang to dry.</p>
<p><b>4</b> Time button</p>	<p>When using Time Dry, Warm Air, Cool Air cycles, time can be adjusted by pressing the <b>Time</b> button.</p> <p>30 min → 60 min → 90 min → 120 min → 150 min (120 min and 150 min time options are not available for Warm Air and Cool Air cycles.)</p> <p>Except the Time Dry, Quick Dry, Warm Air, Cool Air cycle, the time indicator of manual is off because exact drying times are determined by fluctuating humidity levels.</p>

# operating Instructions, tips

<p><b>5 Anti Crease button</b></p>	<p>Anti Crease provides approximately 120 minutes of intermittent tumbling in unheated air at the end of the cycle to reduce wrinkling. Press the <b>Anti Crease</b> button to activate this feature.</p> <p>The indicator light above the pad will illuminate when Anti Crease is selected. Dried laundry is prevented from becoming wrinkled by periodic drum rotations after the completion of the drying course. (Even after "End" is displayed, the drum rotates intermittently.)</p>
<p><b>6 Mixed Load Bell button</b></p>	<p>This is an alarm that notifies the user when the average drying level is damp dry (80 % dried) when the laundry contains various types of materials and fabric.</p> <p>If the corresponding condition is satisfied, the Mixed load bell LED blinks</p>
<p><b>7 Lamp button</b></p>	<p>Lights the dryer drum while the dryer is running. (DV9, DV8 Series)</p> <p> It can be set while your dryer is not only running but also when it is stopped. If you do not turn the Drum Light off within 5 minutes of turning it on, it is automatically turned off.</p>
<p><b>8 Sound On/Off button</b></p>	<p>The Sound On/Off function can be selected during all courses. When this function is selected, sound is turned off for all courses. Even if the power is turned on and off repeatedly, the setting is retained.</p> <p> For DV7 Series model, press the <b>Time</b> and <b>Anti Crease</b> buttons at the same time for 3 seconds.</p>
<p><b>9 Delay End button</b></p>	<p>Press this button repeatedly to cycle through the available Delay End options. (from 3 hours to 19 hours in one hour increments).</p> <p>The hour displayed indicates the time when the dry cycle will be finished. See page 21 for detail.</p>
<p><b>10 Start/Pause button</b></p>	<p>Press to start a dry cycle. If the dryer is running, press it once and it will pause the dryer. Press it again to restart the dry cycle.</p>
<p><b>11 Power button</b></p>	<p>Press once to turn your dryer on, press again to turn it off. If your dryer is left on for more than 10 minutes without any buttons being touched, the power automatically turns off.</p>

 If you insert laundry into your dryer while it is extremely tangled immediately after your washer has finished a wash or spin cycle, it may degrade the drying efficiency or cause the door to open. We recommend that you disentangle your laundry appropriately before inserting it.

 Each indicator on the graphic display means:

	Drying in Progress		Drying Level 3 (Strong)
	Cooling in Progress		Drying Level 2 (Normal)
	Stop		Drying Level 1 (Gentle)
	Anti Crease in Progress		Anti Crease
	Filter Check		Heat Exchanger Filter Clean Alarm
	Delay End		Sound On/Off
	Dumping Condensed Water		Mixed Load Bell
	Child Lock On/Off		Smart Check

## CHILD LOCK

A function to prevent children from playing with your dryer.

### Activating/Deactivating

If you want to activating/deactivating the Child Lock, press both the **Drying Level** and **Time** buttons simultaneously for 3 seconds.

The "Child Lock" (🔒) will be lit when this feature is activated.



- When the power is turned on, the Child Lock function is available.
- Once you set the Child Lock function, no button, except for the **Power** button, will respond until you release the Child Lock function.
- If the dryer is powered on again, the Child Lock function stays on.
- When other buttons, except for the **Power** button, do not respond, check the Child Lock indicator to see if the function is on.

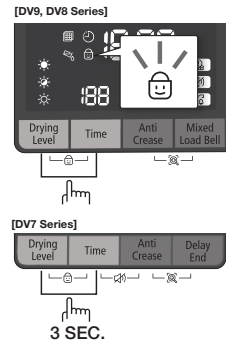

## DELAY END

You can set the dryer to finish your drying cycle automatically at a later time, choosing a delay of between 3 to 19 hours (in 1 hour increments). The hour displayed indicates the time at which the dry will be finished.

1. Manually or automatically set your drying machine according to the type of laundry you are drying.
2. Press the **Delay End** button repeatedly until the required delay time is set. If the delay time is set, the "Delay End" function becomes ON state.
3. Press the **Start/Pause** button. The "Delay End" (🕒) indicator will blink and the clock will begin counting down until it reaches the set time.
4. To cancel a Delay End function, press the **Power** button and then turn the dryer on again.

# operating Instructions, tips

## SMART CHECK

This function enables you to check the status of the dryer using a smartphone.

-  The Smart Check function has been optimized for:  
Galaxy & iPhone series (cannot be supported for some models)



### Downloading the Samsung Smart Washer app

Download the Samsung Smart Washer app to your mobile phone from the Android market or Apple App store and install it. You can easily find it by searching for “**Samsung Smart Washer**”.

### Using the Smart Check function

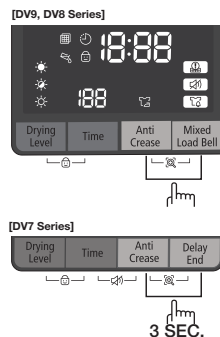
1. Hold down the **Anti Crease** and **Mixed Load Bell** buttons at the same time for 3 seconds when an error occurs to run the Smart Check function. Alternatively, the Smart Check function can be run if no button is pressed after the dryer is turned on.
2. The LED segments on the display panel rotate for 2 or 3 seconds and the Smart Check code is displayed on the dryer’s display panel.



3. Run the **Samsung Smart Washer** app on your smart phone and tap the **Smart Check** button.
-  'Smart Check' may be changed to 'Smart Care' according to the language selection.
4. Focus your smart phone's camera on the Smart Check code displayed on the dryer's display panel.
  -  If light from a light bulb, fluorescent bulb or lamp is reflected on the display panel of the dryer, the smart phone may not be able to easily recognize the Smart Check code.
  - If you hold the smart phone at a too wide angle relative to the front of the display panel, it may not be able to recognize the error code. For best results, hold the smart phone so that the front of the display panel and the smart phone are parallel or nearly parallel.
5. If it focuses correctly, the Smart Check code is automatically recognized, and the detailed information of the status of your dryer, the error and the countermeasures are displayed on your smart phone.
6. If the smart phone fails to recognize the Smart Check code more than twice, please enter the Smart Check code displayed on your dryer's display panel into the Samsung Smart Washer app manually.

## RACK DRY (DV9 SERIES ONLY)

### Installing the drying rack

1. Open the dryer door.
2. Position the drying rack in the tumbler, placing the front lip of the drying rack on the top of the lint filter case.
3. Place the rear legs in the two recessed areas of the dryer's back wall then push down the middle of the drying rack to fix.
4. Place the items to be dried on the rack, leaving space between them so air can circulate.
5. Close the dryer door.
6. Press the **Power** button.
7. Select Time Dry by using the cycle selector dial, set the **Time** button.
  - You can set the drying time up to 150 minutes. Select the time according to the moisture and weight of the items. It may be necessary to reset the timer if a longer drying time is needed. (When you dry laundry using the drying rack, using the Time Dry cycle is recommended.)
8. Press the **Start/Pause** button.

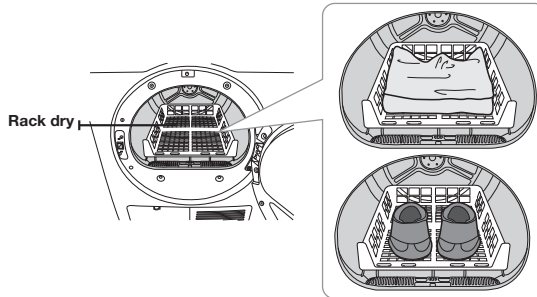

SUGGESTED ITEMS	REMARKS (MAX 1.5kg)
Washable sweaters (block to shape and lay flat on rack)	When drying the laundry using the Rack, fold and place the clothes on the Rack to prevent the clothing from becoming wrinkled.
Stuffed toys (cotton or polyester fiberfilled)	
Stuffed toys (foam or rubber-filled)	
Foam rubber pillows	
Sneakers	To dry sports shoes, place the shoes on the Rack so that the soles of the shoes are facing downwards.

 Drying foam rubber, plastic, or rubber on a heat setting may cause damage to the items and lead to a fire hazard.

 Since damage may result when drying shoes, use the Rack Dry course to dry shoes.

# operating Instructions, tips

---

## LOAD THE DRYER PROPERLY

---

- Place only one wash load in your dryer at a time.
- Mixed loads of heavy and lightweight fabrics will dry differently, which may result in lightweight fabrics being dry while heavy fabrics remain damp at the end of a drying cycle.
- Add one or more similar items to your dryer when only one or two articles of clothing need drying. This improves the tumbling action and drying efficiency.
- Overloading restricts tumbling action, resulting in uneven drying as well as excessive wrinkling of some fabrics.
- Make sure to insert laundry that has been spun by an appropriate washing machine.
- No unwashed textiles should be dried
- Textiles which have been in contact with oil, alcohol, petrol etc. should not be dried.

## GETTING STARTED

---

1. Load your dryer loosely – DO NOT overload.
2. Close the door.
3. Select the appropriate cycle and options for the load.
4. Press the **Start/Pause** button.
5. The dryer indicator light will illuminate.
6. The estimated cycle time will appear in the display.  
The time may fluctuate to better indicate drying time remaining in the cycle.



- When the cycle is complete and “End” will appear in the display.
- Pressing Power cancels the cycle and stops your dryer.
- The Drying, Cooling, and Anti Crease indicator lights will illuminate during those portions of the cycle.



# care and cleaning

---

 **WARNING** Do not clean the dryer by directly spraying water onto the dryer. Do not clean the dryer with benzene, thinner, alcohol, or acetone.

- Otherwise, it may cause discoloration, deformation, damage, electric shock or fire.

 **WARNING** When cleaning the product, be sure to unplug the power cord.

 During the drying cycle, the control panel or the door may accumulate moisture.

## CLEAN THE HEAT EXCHANGE

---

Since the surface of the heat exchanger is sharp, clean it with a soft brush or vacuum cleaner. (It is recommended to clean it at least once every month.)

 **CAUTION** Do not touch the heat exchanger with your hand. Otherwise, it may cause an injury.

## CONTROL PANEL

---

Clean with a soft, damp clothes. Do not use abrasive substances.

Do not spray cleaners directly on the panel.

The control panel finish may be damaged by some laundry pre-treatment soil and stain remover products.

Apply such products away from your dryer and wipe up any spills or overspray immediately.

## STAINLESS STEEL TUMBLER

---

To clean the stainless steel tumbler, use a damp cloth with a mild, non-abrasive cleaner suitable for stainless steel surfaces.

Remove the cleaner residue and dry with a clean cloth.

## DRYER EXTERIOR

---

The entire dryer has a high-gloss finish. Clean with a soft, damp cloth. Do not use abrasive substances.

Protect the surface from sharp objects as they may scratch or damage the finish.

Do not place any heavy or sharp objects or a detergent box on the dryer. Keep them on the purchased pedestal or in a separate storage box.

# care and cleaning

## DUMPING CONDENSED WATER (☞)

1. Pull the water-tank forwards to separate it.



When removing the water tank from the product, hold the water tank using both hands as it is heavy and take care not to spill any water inside the tank. Otherwise, it may cause an injury to your wrist.

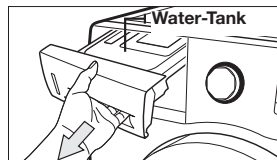

2. Remove the condensed water inside the water-tank.

- Remove the condensed water in the tank after every drying operation.



Since there is a danger of water leaking if you do not drain the water after using the product, make sure to drain the water.

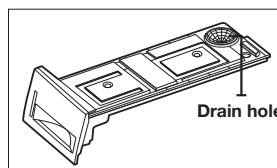

- ☞ If you empty the water tank and press the Start button, the Water Tank Full (☞) in the LED panel is turned off.

## CLEANING THE FILTER CASE (☞)

1. Open the door and remove the filter by pulling it upwards.

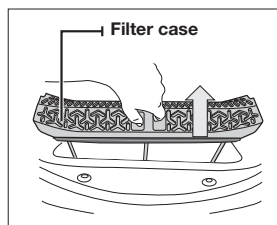

2. Open and clean the filter case.

- Clean the filter case after the drying operation is completed.

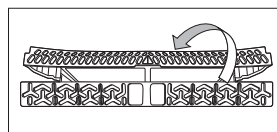

• Since the drying performance may be degraded and there is a danger of fire if you do not clean the filter case after the specified period of use, clean the filter case at the specified cleaning interval.

- Clean the filter case after every drying operation.



- If the surface of the filter is wet, use the filter after drying it completely.

## CLEANING THE HEAT EXCHANGER FILTER ( )

1. Open the condenser compartment cover.

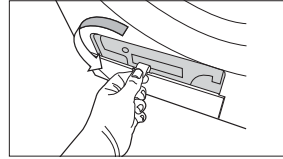

2. Unlock the fixer.

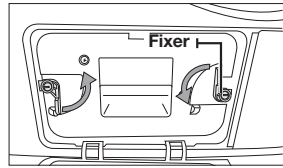

3. Remove the Heat Exchanger Filter.

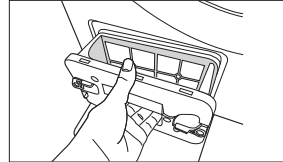

4. Clean the Heat Exchanger Filter with water, or just dust it off. If cleaning the Heat Exchanger Filter with water, dry it thoroughly before reinserting it back.

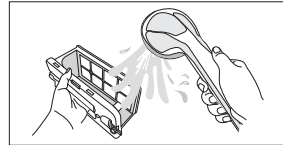

5. Clean it with a soft brush or vacuum cleaner  
(It is recommended to clean it at least once every month.)



Do not touch the heat exchanger with your hand.  
Otherwise, it may cause an injury.

If the heat exchanger filter indicator is turned on or blinks,  
clean the heat exchanger filter.

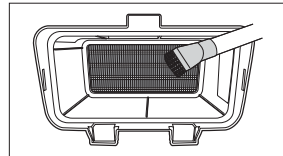

- Since the drying performance may be degraded if you do not clean the Heat Exchanger after a specified period of use, clean the Heat Exchanger at the specified cleaning interval.
- Clean the Heat Exchanger and Filter frequently to maintain the drying performance.
- When assembling the Heat Exchanger Filter after cleaning it, make sure to that the fixer is set to the lock position.

# special laundry tips

## SPECIAL LAUNDRY TIPS

Please follow the care label or manufacturer's instructions for drying special items. If care label instructions are not available, use the following information as a guide.

<b>Bedspreads &amp; Comforters</b>	<ul style="list-style-type: none"><li>• Follow the care label instructions or dry on the <b>Cotton</b> (Cupboard Dry) and High temperature.</li><li>• Make sure the item is thoroughly dry before using or storing.</li><li>• May require repositioning to ensure even drying.</li></ul>
<b>Blankets</b>	<ul style="list-style-type: none"><li>• Use <b>Cotton</b> (Cupboard Dry) and dry only one blanket at a time for best tumbling action.</li><li>• Make sure the item is thoroughly dry before using or storing.</li></ul>
<b>Cloth Nappies</b>	<ul style="list-style-type: none"><li>• Use the <b>Cotton</b> (Cupboard Dry) and the High temperature settings for soft, fluffy diapers.</li></ul>
<b>Down-filled Items (jackets, sleeping bags, comforters, etc.)</b>	<ul style="list-style-type: none"><li>• Use the <b>Cotton</b> (Cupboard Dry) and the Low or Low temperature setting.</li><li>• Adding a couple of dry towels shortens drying time and absorbs moisture.</li></ul>
<b>Foam Rubber (rug backs, stuffed toys, shoulder pads, etc.)</b>	<ul style="list-style-type: none"><li>• DO NOT dry on a heat setting. Use the <b>Cool Air</b> cycle (no heat).</li><li>• WARNING – Drying a rubber item with heat may damage it or be a fire hazard.</li></ul>
<b>Pillows</b>	<ul style="list-style-type: none"><li>• Use the <b>Cotton</b> (Cupboard Dry).</li><li>• Add a couple of dry towels to help the tumbling action and to fluff the item.</li><li>• DO NOT dry kapok or foam pillows in dryer. Use the <b>Cool Air</b> cycle.</li></ul>
<b>Plastics (shower curtains, outdoor furniture covers, etc.)</b>	<ul style="list-style-type: none"><li>• Use the <b>Cool Air</b> cycle or the <b>Time Dry</b> cycle and the Low or Low temperature settings depending on the care label instructions.</li></ul>

### THINGS TO AVOID :

- Fiberglass items (curtains, draperies, etc.).
- Woolens, unless recommended on the label.
- Vegetable or cooking oil-soaked items.

# troubleshooting

## CHECK THESE POINTS IF YOUR DRYER...

PROBLEM	SOLUTION
Doesn't run.	<ul style="list-style-type: none"> <li>• Make sure the door is latched shut.</li> <li>• Be sure the power cord is plugged into a live electrical outlet.</li> <li>• Check the home's circuit breaker and fuses.</li> <li>• Press the <b>Start/Pause</b> button again if the door is opened during the cycle.</li> <li>• Empty the water in the condensed water tank.</li> <li>• Clean the filter case.</li> </ul>
Doesn't heat.	<ul style="list-style-type: none"> <li>• Check the home's circuit breaker and fuses.</li> <li>• Select a heat setting other than <b>Cool Air</b>.</li> <li>• Check the case filter and Heat Exchanger Filter and clean them if necessary.</li> <li>• Dryer may have moved into the cool-down phase of the cycle.</li> </ul>
Doesn't dry.	<ul style="list-style-type: none"> <li>• Check all of the above, plus...</li> <li>• Do not overload. 1 wash load = 1 dryer load.</li> <li>• Sort heavy items from lightweight items.</li> <li>• Large, bulky items like blankets or comforters may require repositioning to ensure even drying.</li> <li>• Check that the dryer is draining properly to extract adequate water from the load.</li> <li>• Load may be too small to tumble properly. Add a few towels.</li> <li>• Clean the filter case.</li> <li>• Clean the Heat Exchanger Filter.</li> </ul>
Is noisy.	<ul style="list-style-type: none"> <li>• Check the load for objects such as coins, loose buttons, nails, etc. Remove promptly.</li> <li>• Be sure the dryer is leveled properly as outlined in the installation instruction.</li> <li>• It is normal for the dryer to hum due to the high velocity of air moving through the dryer drum and fan.</li> </ul>
Dries unevenly.	<ul style="list-style-type: none"> <li>• Seams, pockets, and other similarly heavy areas may not be completely dry when the rest of the load has reached the selected dryness level. This is normal. Select the <b>Extra Dry</b> setting if desired.</li> <li>• If one heavy item is dried with a lightweight load, such as one towel with sheets, it is possible that the heavy item will not be completely dry when the rest of the load has reached the selected dryness level. Sort heavy items from lightweight items for best drying results.</li> </ul>
Has an odour.	<ul style="list-style-type: none"> <li>• Household odors from painting, varnishing, strong cleaners, etc. may enter the dryer with the surrounding room air. This is normal as the dryer draws the air from the room, heats it, pulls it through the tumbler, and exhausts it outside.</li> <li>• When these odors linger in the air, ventilate the room completely before using the dryer.</li> </ul>
Shuts off before load is dry	<ul style="list-style-type: none"> <li>• Dryer load is too small. Add more items or a few towels and restart the cycle.</li> <li>• Dryer load is too large. Remove some items and restart the dryer.</li> </ul>

# troubleshooting

---

<b>PROBLEM</b>	<b>SOLUTION</b>
<b>Lint on clothes</b>	<ul style="list-style-type: none"><li>• Make sure the case filter is cleaned before every load. With some loads that produce high amounts of lint, it may be necessary to clean the filter case during the cycle.</li><li>• Some fabrics are lint producers (for example, a fuzzy white cotton towel) and they should be dried separately from clothes that are lint trappers (for example, a pair of black linen pants)</li><li>• Divide larger loads into smaller loads for drying</li><li>• Check pockets thoroughly before drying and drying clothes.</li></ul>
<b>Garments still wrinkled after Anti Crease</b>	<ul style="list-style-type: none"><li>• Small loads of 1 to 4 items work best.</li><li>• Load fewer garments. Load similar-type garments.</li></ul>
<b>Odours remain in clothing after Cool air.</b>	<ul style="list-style-type: none"><li>• Fabrics containing strong odors should be washed.</li></ul>

## INFORMATION CODES

Information codes may be displayed to help you better understand what is occurring with your Dryer.

ERROR DISPLAY	MEANING	SOLUTION
<b>tE</b>	Air temperature sensor error	Clean the filter case or heat exchanger filter. If the problem continues call for service.
<b>tE5</b>	Compressor temperature sensor error	Turn the power on after 2~3 minutes and start again from the beginning.
<b>dE</b>	Running the dryer with door open	Close the door and then restart. If the problem continues call for service.
<b>HE</b>	Compressor overheat	Call for service
<b>2E</b>	It occurs when low voltage is detected.	Check if the power cord is plugged in. If the problem continues, please contact the service center.
<b>5E</b>	The water tank is full of water. The drain pump is out of order.	Empty the water tank, turn the power on again and start again from the beginning. If the problem continues call for service.



































For any codes not listed above, or if the suggested solution doesn't fix the problem, call your Samsung Service Centre or local Samsung dealer.

Do not let an unauthorized engineer disassemble or repair the product.

# appendix

## FABRIC CARE CHART

The following symbols provide garment care direction. The Clothing care labels include symbols for drying, bleaching, drying and ironing, or dry cleaning when necessary. The use of symbols ensures consistency among garment manufacturers of domestic and imported items. Follow care label directions to maximize garment life and reduce laundering problems.

Wash Cycle		Special Instructions		Warning Symbols for Laundering	
	Normal		Line Dry/ Hang to Dry		Do Not Wash
	Permanent Press / Wrinkle Resistant / Wrinkle Control		Drip Dry		Do Not Wring
	Gentle/Delicates		Dry Flat		Do Not Bleach
	Hand Wash	Heat Setting			Do Not Tumble Dry
Water Temperature**			High		No Steam (added to iron)
	Hot		Medium		Do Not Iron
	Warm		Low	Dryclean	
	Cold		Any Heat		Dry Clean
Bleach			No Heat/Air		Do Not Dry Clean
	Any Bleach (when needed)	Iron-Dry or Steam Temperatures			Line Dry/ Hang to Dry
	Only Non-Chlorine (color-safe) Bleach (when needed)		High		Drip Dry
	Tumble Dry Cycle		Medium		Dry Flat
Normal			Low		
	Permanent Press/ Wrinkle Resistant/ Wrinkle Control				
	Gentle/ Delicates				

\*\* The dot symbols represent appropriate wash water temperatures for various items. The temperature range for Hot is 41 – 52 °C, for Warm 29 – 41 °C and for Cold 16 – 29 °C. (Wash water temperature must be a minimum of 16 °C for detergent activation and effective cleaning.)



## PROTECTING THE ENVIRONMENT

This appliance is manufactured from recyclable materials. If you decide to dispose of this appliance, please observe local waste disposal regulations. Cut off the power cord so that the appliance cannot be connected to a power source. Remove the door so that animals and small children cannot get trapped inside the appliance.

## DECLARATION OF CONFORMITY

This appliance complies with European safety standards, EC directive 93/68 and EN Standard 60335.

## SPECIFICATIONS

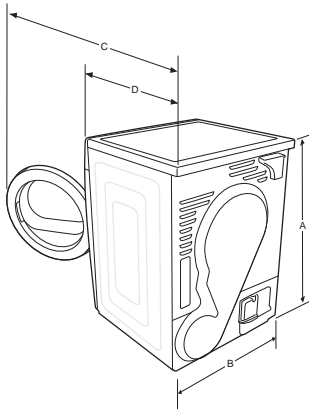

TYPE		FRONT LOADING DRYER	
DIMENSIONS	A. Height	85.0 cm	
	B. Width	59.8 cm	
	C. Depth with door open 90°	110.1 cm	
	D. Depth	63.8 cm	
WEIGHT		50 kg	
ELECTRICAL REQUIREMENTS		220-240 V / 50 Hz	950 - 1100 W
ALLOWABLE TEMPERATURE		5 ~ 35 °C	

# appendix

## CYCLE CHART

(● user option)

Cycle		Max load (kg) (Dry Laundry)			Drying Level	Anti Crease	Mixed Load Bell	Interior Lamp (Only DV9, DV8)	Sound On/Off	Delay End
		DV9	DV8	DV7						
Cotton	Extra Dry	9	8	7	●	●	●	●	●	●
	Cupboard Dry	9	8	7	●	●	●	●	●	●
	Iron Dry	9	8	7	●	●	-	●	●	●
Synthetics	Extra Dry	4.5	4	3.5	●	●	●	●	●	●
	Cupboard Dry	4.5	4	3.5	●	●	●	●	●	●
	Iron Dry	4.5	4	3.5	●	●	-	●	●	●
Wool		2	2	2	-	●	-	●	●	●
Ultra Delicate		1.5	1.5	1.5	-	●	-	●	●	●
Outdoor (Only DV9, DV8 Series)		2	2	-	-	●	-	●	●	●
Sports Wear		2	2	2	-	●	-	●	●	●
Quick Dry		1	1	1	-	●	-	●	●	●
Warm Air (Only DV9, DV8 Series)		-	-	-	-	●	-	●	●	●
Cool Air		-	-	-	-	●	-	●	●	●
Time Dry		-	-	-	-	●	-	●	●	●

\* 9 : DV9 Series (9kg)

\* 8 : DV8 Series (8kg)

\* 7 : DV7 Series (7kg)

# SHEET OF HOUSEHOLD TUMBLE DRIERS

Data sheet for Domestic Tumble Driers

As detailed in EU regulation No. 392/2012

<b>Samsung</b>				
<b>Model Name</b>		<b>DV9 Series</b>	<b>DV8 Series</b>	<b>DV7 Series</b>
Capacity	kg	9	8	7
Type		Condenser	Condenser	Condenser
<b>Energy Efficiency</b>				
A+++ (highest efficiency) to D (least efficient)		A++	A++	A++
<b>Energy Consumption</b>				
Annual Energy Consumption (AE_C) <sup>1)</sup>	kWh/yr	258.0	235.0	211.0
Automatic dryness detector		Yes	Yes	Yes
Energy consumption (E_dry) standard cotton programme at full load	kWh	2.20	1.98	1.75
Energy consumption (E_dry.1/2) standard cotton programme at partial load	kWh	1.12	1.04	0.95
off mode and left-on mode				
The power consumption off-mode (P_o) at full load	W	0.50	0.50	0.50
The power consumption in left-on mode (P_l) at full load	W	5.00	5.00	5.00
Duration of the left-on mode	min	10	10	10
Programme to which the information on the label and the Sheet relate <sup>2)</sup>		Cotton + Cupboard Dry + (Anti Crease off)		
<b>programme duration of the standard program</b>				
Weighted Programme time standard cotton programme at full load and partial load	min	150	136	121
Programme Time (T_dry) standard cotton programme at full load	min	190	170	150
Programme Time (T_dry.1/2) standard cotton programme with partial load	min	120	110	100
condensation efficiency class				
A (most efficient) to G (least efficient)		B	B	B
Average condensation efficiency at full load	%	81	81	81
Average condensation efficiency at partial load	%	81	81	81
Weighted condensation efficiency	%	81	81	81
<b>Airborne noise emissions</b>				
Dry at full load	dB (A) re 1 pW	65	65	65
Built in		No	No	No
<b>Dimensions</b>				
Unit dimensions	Height	mm	850	
	Width	mm	598	
	Depth	mm	638	
Net weight	kg	50		
<b>Electrical connection</b>				
Voltage	V	220-240	220-240	220-240
Power consumption	W	950-1100	950-1100	950-1100
Current	A	5	5	5
Frequency	Hz	50	50	50
<b>Name and address of company</b>		<b>Samsung Electronics Co., Ltd. 129, Samsung-ro, Yeongtong-gu, Suwon-si, Gyeonggi-do, Korea</b>		

- 1) Energy consumption is measured as the annual 9 kg 258 kWh (8 kg 235 kWh, 7 kg 211 kWh) used per year, based on 160 drying cycles of the standard cotton programme at full and partial load, and the consumption of the low-power modes. Actual energy consumption per cycle will depend on how the appliance is used.
- 2) 'standard cotton programme' used at full and partial load is the standard drying programme to which the information in the label and the fiche relates, that this programme is suitable for drying normal wet cotton laundry and that it is the most efficient programme in terms of energy consumption for cotton.  
Consumption data can vary from the nominal values given above depending in the size of the load, types of textiles, residual moisture levels after spinning, fluctuations in the electricity supply and any extra options selected.



QUESTIONS OR COMMENTS?

Country	CALL	OR VISIT US ONLINE AT
U.K	0330 SAMSUNG (7267864)	<a href="http://www.samsung.com">www.samsung.com</a>
EIRE	0818 717100	<a href="http://www.samsung.com">www.samsung.com</a>

Code No. DC68-03297A-02\_EN